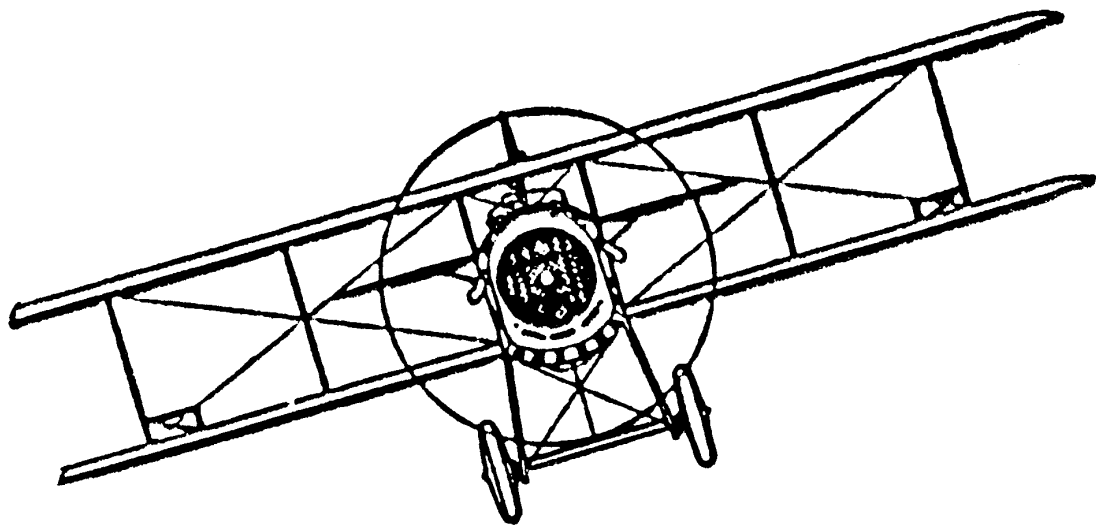

Covering the TI99/4A, the Myarc 9640 and compatibles

MICROpendium

Volume 4 Number 2

March 1987

\$1.50



Spad XIII flight simulator reviewed

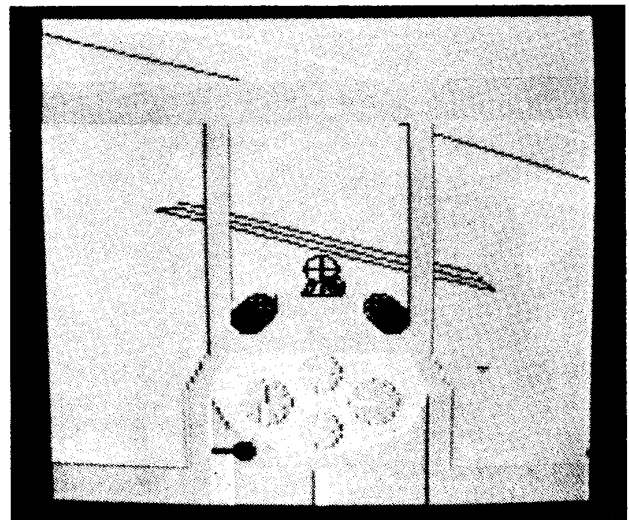

—INSIDE

- Load generator project
- Regena on Central States
- Animation with Logo
- Program to convert assembly code into Extended BASIC

.....Texas Instruments TI-99/4A — COMPUTERS, COMPONENTS AND SOFTWARE.....

TEX+COMP[™]

America's Number One TI computer retailer
TI-99/4 PRODUCTS AT PROFESSIONAL PRICES

The largest selection
of software
for the
TI-99/4A



Tex Comp continues to stock the world's largest selection of TI Software. The TI Software library on module, disk and cassette was developed from 1979-1983 at a cost of millions and is considered the best in the home computer software field. TI utilized the talents of such industry leaders as Scott Forsman, Milton Bradley, Microsoft Corp., Scott Adams, Addison Wesley Publishing, DLM, Milliken Publishing, Scholastic Inc., Imagic, Spinnaker and the list goes on and on.

MANAGEMENT

INFORMATION MANAGEMENT MODULES	
PHM 3006	Home Financial Decisions 4.95
PHM 3007	Household Budget Mgt. 4.95
PHM 3012	Securities Analysis 19.95
PHM 3013	Personal Record Keeping 15.95
PHM 3016	Tax/Inves Rec Keep (Disk Req.) 4.95
PHM 3022	Personal Real Estate 4.95
PHM 3044	Personal Report Generator 10.95
PHM 3035	Terminal Emulator II 9.95
PHM 3111	TI Writer (word processing) 29.95
PHM 3113	Multiplan (spreadsheet) 24.95

DISKETTE PROGRAMS	
PHD 5001	Mailing List (PIO Upgrade) 12.95
PHD 5003	Personal Financial Aids 9.95
PHD 5021	Checkbook Manager 9.95
PHD 5022	Finance Manager 19.95
PHD 5024	Inventory Management 19.95
PHD 5027	Invoice Management 19.95
PHD 5029	Cash Management 19.95
PHD 5038	Lease/Purchase Decisions 9.95
PHD 5075	TI Writer/Multiplan Upgrade 9.95

CASSETTE PROGRAMS	
PHT 6003	Personal Financial Aids 9.95
PHT 6038	Lease/Purchase Decisions 9.95

EDUCATION

MODULES	
PHM 3002	Early Learning Fun 4.95
PHM 3003	Beginning Grammar 4.95
PHM 3004	Number Magic 4.95
PHM 3008	Video Chess 14.95
PHM 3010	Physical Fitness 9.95
PHM 3020	Music Maker 9.95
PHM 3021	Weight Control & Nutrition 10.95
PHM 3064	Touch Typing Tutor 9.95

PHM 3109	TI Logo II (32K req.) 19.95
PHM 3015	Early Reading (Speech) 9.95
PHM 3043	Reading Fun 9.95
PHM 3046	Reading On 9.95
PHM 3047	Reading Roundup 9.95
PHM 3048	Reading Rally 9.95
PHM 3082	Reading Flight 9.95
PHM 3027	Addition & Subtraction I 9.95
PHM 3028	Addition & Subtraction II 9.95
PHM 3029	Multiplication I 9.95
PHM 3049	Division I 9.95
PHM 3050	Numeration I 9.95
PHM 3051	Numeration II 9.95
PHM 3059	Scholastic Spelling 3 9.95
PHM 3060	Scholastic Spelling 4 9.95
PHM 3061	Scholastic Spelling 5 9.95
PHM 3062	Scholastic Spelling 6 9.95
PHM 3088	Computer Math Games VI 9.95
PHM 3090	Milliken Addition 9.95
PHM 3091	Milliken Subtraction 9.95
PHM 3092	Milliken Multiplication 9.95
PHM 3093	Milliken Division 9.95
PHM 3094	Milliken Integers 9.95
PHM 3098	Milliken Number Readiness 4.95
PHM 3099	Milliken Laws of Arithmetic 4.95
PHM 3100	Milliken Equations 4.95
PHM 3101	Milliken Meas of Formulas 4.95
PHM 3114	Alligator Mix 6.95
PHM 3115	Alien Addition 6.95
PHM 3117	Dragon Mix 6.95
PHM 3118	Minus Miasion 6.95
PHM 3119	Meteor Multiplication 6.95
PHM 3177	Face Maker 9.95
PHM 3178	Story Machine 9.95

DISKETTE PROGRAMS	
PHD 5009	Music Skills Trainer 9.95
PHD 5018	Market Simulation 9.95
PHD 5030	Speak & Spell (Speech Ed Req.) 9.95
PHD 5031	Speak & Math (TE II Req.) 9.95
PHD 5042	Spell Writer (TE II Req.) 9.95
PHD 5026	Bridge Bidding I 9.95
PHD 5039	Bridge Bidding II 9.95
PHD 5041	Bridge Bidding III 9.95
PHD 5020	Music Maker Demo (Module Req.) 9.95

CASSETTE PROGRAMS	
See disk versions for requirements i.e. TEII	
PHT 6009	Music Skills Trainer 8.95
PHT 6011	Computer Music Box 8.95
PHT 6018	Market Simulation 8.95
PHT 6031	Speak & Math 9.95
PHT 6042	Spell Writer 9.95
PHT 6026	Bridge Bidding I 9.95
PHT 6039	Bridge Bidding II 9.95
PHT 6041	Bridge Bidding III 9.95

BRIGHT BEGINNINGS SERIES	
PHM 3154	Terry Turtle's Adventure (MBX Expansion System Required) 9.95
PHM 3155	I'm Hiding (MBX Expansion System Required) 9.95

ARCADE PLUS SERIES	
PHM 3149	Space Bandit (MBX Expansion System Recommended) 9.95

PHM 3151	Bigfoot (MBX Expansion System Recommended) 9.95
PHM 3152	Meteor Belt (MBX Expansion System Recommended) 9.95

HOME ENTERTAINMENT

MODULES	
PHM 3023	Hunt the Wumpus 4.95
PHM 3024	Indoor Soccer 8.95
PHM 3025	Mind Challengers 10.95
PHM 3030	Amazing 4.95
PHM 3052	Tombstone City 4.95
PHM 3053	TI Invaders 4.95
PHM 3054	Car Wars 4.95
PHM 3057	Munch Man 4.95

PHM 3056	Alpiner 4.95
PHM 3110	Chisholm Trail 5.95
PHM 3112	Parasc 4.95
PHM 3031	The Attack 4.95
PHM 3032	Blasto 4.95

PHM 3034	Huette 6.95
PHM 3036	Zero Zap 8.95
PHM 3037	Hangman 6.95
PHM 3038	Connect Four 6.95
PHM 3067	Othello 9.95

SPECIAL OFFER

Brand New Original Black & Silver TI-99/4A console only \$79.95. Runs all third party modules and comes with 1 year TI factory warranty.

*Shipping, handling & insurance on this special offer is \$10.00 (Continental U.S.) to any UPS deliverable address. HA, AL, Canada and APO slightly higher.

SPECIALS

Original TI Joysticks
\$7.95 (pair)

Replacement 99/4A
Keyboards
(plug in connection)
\$7.95

Replacement Console
Power Supply
(external transformer)
\$9.95

Texas Instruments TI-99/4A Home Computer

Tex-Comp purchased TI's inventory of these outstanding titles in order to continue its support of the TI-99/4A user, and also continually acquires inventory from leading retailers and distributors who have discontinued home computer sales.

With its five warehouses and financial resources, Tex-Comp has been able to assure you, the TI-99/4A user continued support.



PHM 3041T	Adventure & Pirate Adv. (Cass.)	6.95
PHM 3041D	Adventure & Pirate Adv. (Disk)	6.95
ADVENTURE SERIES ON CASS OR DISK (SPECIFY)		
	Adventureland	9.95
	Mission Impossible	9.95
	Voodoo Castle	9.95
	The Count	9.95
	Strange Odyssey	9.95
	Mystery Fun House	9.95
	Pyramid of Doom	9.95
	Ghost Town	9.95
	Savage Island I & II	9.95
	Golden Voyage	9.95
	Ironheart Adventure (Not Scott Adams)	9.95
	SPECIAL ALL ABOVE ADVENTURES ON DISK OR CASSETTE INCLUDING IRONHEART	29.95
	Buckaroo Bonzai	19.95
	Soccerer of Claymorgue Castle	19.95
	Hulk	19.95
	SPECIAL ALL FOUR + 2 BONUS ADVENTURES & HINT BOOK	29.95
	Specify Disk or Cassette	
DISKETTE PROGRAMS		
PHD 5002	TI-Trek (with new TEII Ver.)	9.95
PHD 5010	Mystery Melody	9.95
PHD 5015	Oldies But Goodies I	9.95
PHD 5017	Oldies But Goodies II	9.95
PHD 5025	Sat. Night Bingo (Speech) Ex-Basic	9.95
PHD 5037	Draw Poker (Ex-Basic Req.)	9.95
CASSETTE PROGRAMS		
PHT 6002	TI-Trek TE-II & Speech	9.95
PHT 6010	Mystery Melody	7.95
PHT 6015	Oldies But Goodies I	7.95
PHT 6017	Oldies But Goodies II	7.95
PHT 6026	Sat. Night Bingo (Speech) Ex-Basic	7.95
PHT 6037	Draw Poker (Ex-Basic Req.)	7.95
TI ARCADE STYLE MODULES AND RECENT RELEASES		
PHM 3149	Space Bandit (MBX Expansion System Recommended)	9.95
PHM 3150	Sewermania (MBX Expansion System Recommended)	9.95
PHM 3151	Bigfoot (MBX Expansion System Recommended)	9.95
PHM 3152	Meteor Belt (MBX Expansion System Recommended)	9.95
PHM 3220	Microsurgeon	9.95
PHM 3219	Super Demon Attack	9.95
PHM 3224	Moonsweeper	9.95
PHM 3145	Snuggly	5.95
PHM 3229	Hopper	4.95
PHM 3233	Burgertime	9.95
PHM 3194	Jawbreaker II	5.95
PHM 3227	Congo Bongo	15.95
PHM 3168	Treasure Island	11.95
PHM 3189	Return to Pirates Island	11.95
PHM 3226	Buck Rodgers	15.95
PHM 3225	Star Trek	15.95
PHM 3222	Fathom	9.95
PHM 3146	Munchmobile	11.95
PHM 3197	Slymolds	15.95

COMPUTER PROGRAMMING AIDS

MODULES		
PHM 3026	Extended Basic & Manual	29.95
PHM 3055	Editor Assembler	19.95
PHM 3058	Mini Memory (With Writer)	38.95
DISKETTE PROGRAMS		
PHD 5007	Teach Yourself 99/4A Basic	9.95
PHD 5019	Teach Yourself Ex-Basic	9.95
PHD 5004	Programming Aids I	9.95
PHD 5005	Programming Aids II	9.95
PHD 5012	Programming Aids III	9.95
PHD 5077	Programming Aids I, II, & III	24.95
PHD 5067	Beginning Basic Tutor	9.95
PHD 5076	Text to Speech (English)	9.95
PHD 5088	TI Forth (Ed Assem Req.)	19.95
PHD 5078	TI Forth Demo Disk (Ed Assem)	9.95
PHD 5079	Forth Source Code (2 Disks)	11.95
CASSETTE PROGRAMS		
PHT 6006	Programming Aids I	6.95
PHT 6007	Teach Yourself 99/4A Basic	6.95
PHT 6019	Teach Yourself Ex-Basic	6.95
PHT 6067	Beginning Basic Tutor	6.95

MATH AND ENGINEERING

DISKETTE PROGRAMS		
PHD 5006	Math Routine Library	9.95
PHD 5008	Electrical Engineering Lib.	9.95
PHD 5013	Graphing Package	9.95
PHD 5016	Structural Engineering Lib.	9.95
PHD 5044	AC Circuit Analysis	9.95
CASSETTE PROGRAMS		
PHT 6006	Math Routine Library	8.95
PHT 6008	Electrical Engineering Lib.	8.95
PHT 6013	Graphing Package	8.95
PHT 6016	Structural Engineering Lib.	8.95
PHT 6044	AC Circuit Analysis	8.95

TI-COUNT SMALL BUSINESS SOFTWARE



General Ledger	89.95
Accounts Receivable	89.95
Accounts Payable	89.95
Inventory	89.95
Payroll	89.95
Mail System	39.95

ALL 6 FOR \$349.95

Send for 1987 Tex-Comp catalog & buyer's guide only \$2.00 (comes with \$5 savings certificate)

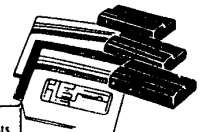
Drastic Reductions



 	VISA and MASTERCARD HOLDERS CALL DIRECT (818) 366-6631	SEND ORDER AND MAKE CHECKS PAYABLE TO TEXCOMP™ P.O. BOX 33064 - GRANADA HILLS, CA 91344 AUTHORIZED DEALER	Texas Instruments 
add 3% for credit card orders			
TERMS: All prices F.O.B. Los Angeles. For fastest service use cashiers check or money order. Add 3% shipping and handling (\$3.00 minimum). East of Mississippi 4 1/2%. (Free shipping on all software orders over \$100.00). Prices and availability subject to change without notice. We reserve the right to limit quantities.			
NOTE: Payment in full must accompany all orders. Credit-Card, Company Check or Money Order for immediate shipment. Personal checks require up to 4 weeks to clear. California orders add 6 1/2% sales tax.			

Contents

MICROpendium

MICROpendium is published 12 times annually in Round Rock, Texas. No material published in the pages of MICROpendium may be used without permission of the publisher. Computer user groups that have signed exchange agreements with MICROpendium may excerpt articles appearing in MICROpendium without prior approval.

While all efforts are directed at providing factual and true information in published articles, the publisher cannot accept responsibility for errors that appear in advertising or text appearing in MICROpendium. The inclusion of brand names in text does not constitute an endorsement of any product by the publisher. Statements published in MICROpendium which reflect erroneously on individuals, products or companies will be corrected upon contacting the publisher.

Unless the author specifies, letters will be treated as unconditionally assigned for publication, copyright purposes and use in any other publication or brochure and are subject to MICROpendium's unrestricted right to edit and comment.

Display advertising deadlines and rates are available upon request.

All correspondence should be mailed to MICROpendium at P.O. Box 1343, Round Rock, TX 78680. We cannot take responsibility for unsolicited manuscripts but will give consideration to anything sent to the above address. Manuscripts will be returned only if a self-enclosed, stamped envelope is included.

All editions of MICROpendium are mailed from the Round Rock (Texas) or Smithville (Texas) Post Office.

Mailing address: P.O. Box 1343, Round Rock, TX 78680

Telephone: (512) 255-1512

Source: TI4596

John Koloen Publisher

Laura Burns Editor

Mack McCormick Technical Editor

Coming next month

- More on the Geneve
- Drawing the Massachusetts flag in BASIC
- How to build a Super Multi-Cart

Table of Contents

Excuse me, may I please LOAD

Mack McCormick provides instruction on how to build a Load Generator.....Page 12

Name those capitals and states

A BASIC program by Regena to sharpen your geographical knowledge of the Central United States.....Page 16

Screen dump utility fills gap

A program for use with Myarc's XBII.....Page 24

Logo tiles and sprites

How to create more sophisticated graphics with more exciting animation.....Page 26

Reviews

Wycove Forth V.3.0.....Page 35

DIJIT Systems RGB Conversion Kit.....Page 36

Spad XIII Flight Simulator.....Page 37

Newsbytes

Fairs around the continent, a new distribution plan for BasicSort and programs from E&M Software.....Page 39

User Notes

Simple titles for videos, deleting columns from TI-Writer and Editor/Assembler and turning assembly into CALL LOADs..Page 42

Classified.....Page 46

Sensational Prices!!! ... On Our Most Popular Hardware and Software!!

TOP QUALITY PERIPHERALS

from
Mechatronic • CorComp • Myarc
MECHATRONIC

TI Intern. This book contains a line by line listing of the TI 99/4A ROM and GROM chips with commentary.

41510 Book \$17.95

Extended BASIC II Plus. This Extended BASIC includes built-in extended statement set and graphics mode. Graphic functions require 32K.

41488 Cartridge..... \$79.95

TI Mouse w/TI-DOS. Requires Extended BASIC, disk system, 32K

41493 Mouse with DOS Disk \$119.95

80-Column Card. Full 80 columns on your TI screen!

41505 \$219.95

CORCOMP

Triple Tech. Board for PE Box includes clock/calendar, printer buffer, and speech synthesizer connection.

34643 \$138.00

34639 Clock/Calendar. Stand-alone. \$79.95

34396 9900 32K Micro Memory. Stand-alone 32K. \$99.95

The Memory Plus series

41070 256K Memory Plus Stand-Alone. \$219.00

41633 512K Memory Plus Stand-Alone. \$279.00

41051 256K Memory Plus Card. \$196.00

41065 512K Memory Plus Card. \$253.00

See "Best Selling Hardware" for more CorComp products.

MYARC

34324 256K Card. \$179.00

42245 512K Card. \$239.00

38179 Extended BASIC Level IV. \$59.95

38395 256K Card with Extended BASIC Level IV. \$249.00

42231 512K Card with Extended BASIC Level IV. \$289.00

38198 512K Upgrade Kit for the 128K Card. \$109.95

See "Best Selling Hardware" for more Myarc products.

THE 49¢ micro DISKETTE!

Are you paying too much for diskettes? Try our first quality, prime, 5 1/4" diskettes (no rejects, no seconds) at these fantastic sale prices and save, save. SAVE! Disks are packaged in boxes of 50; each box contains 5 shrink-wrapped 10-packs that include diskettes in sleeves, labels, and write-protect tabs.

Each diskette is certified to be 100% error free and comes with a lifetime warranty (if you have a problem, we'll replace the diskette). All diskettes include hub reinforcement rings and write-protect notch.

Box of 50

32391 SS, DD Diskettes \$24.50

(49¢ each!)

32403 DS, DD Diskettes \$29.50

(59¢ each!)



FREE!
"EVERYTHING BOOK"
For the
TI Home Computer
Order Item #25982

AVAILABLE FROM
YOUR FRIENDS AT



We gladly accept
mail orders!

P.O. Box 6578
South Bend, IN 46660

Questions? Call
219/259-7051

NEW
LOW
PRICE!



MicroPal® Extended BASIC

MicroPal's Extended BASIC package now includes two free software programs! Bestsellers **Typewriter** and **Name-It** from Extended Software are included in disk and cassette versions with complete manual — absolutely free!! You can immediately begin using the power of Extended BASIC for word processing and data base functions.

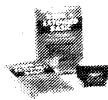

MicroPal Extended BASIC is unconditionally guaranteed to be 100% compatible with all programs written in TI Extended BASIC. With this powerful, high-level language, programmers can have automatic access to the 32K memory expansion, utilize sprite graphics for smooth motion and animation, auto-load disk based programs, and add speech with a 400 word built-in vocabulary! Package includes Extended BASIC on a convenient plug-in cartridge with 240 page manual. Sug. Retail \$89.95

32967 **ONLY \$49.95!!**

LOST HITS "REDISCOVERED"

Some of you may remember that Thorn EMI, the British entertainment giant, developed three super games for the TI. Just before the games were released, TI pulled the plug on the 99/4A and Thorn decided to drop the introductions. At last, TENEX brings you these "lost hits" by special arrangement with a U.K. firm who convinced Thorn to make the program rights available. All three programs are packaged on one convenient disk!

The disk includes:

Computer War
Based on the hit movie "War Games."

Submarine Commander
One of the best submarine simulations ever created for a home computer!

River Rescue
High speed action as you save a group of helpless refugees.

Requires 32K and Extended BASIC.

40856 Disk **ONLY \$29.95**

BEST-SELLING HARDWARE!

STAR MICRONICS NX-10 PRINTER

41366 \$229

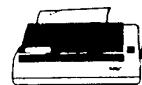

Latest model! Draft quality at 120 cps, near letter quality at 30 cps. 5K print buffer.

42250 PARALLEL PRINTER INTERFACE \$ 44.95

29784 CORCOMP RS-232 INTERFACE \$127.00

29802 CORCOMP 9900

MICRO-EXPANSION SYSTEM \$329.00

MYARC or CORCOMP RS-232 CARD \$ 79.95

32972 MYARC DISK CONTROLLER CARD \$169.95

29770 CORCOMP DISK

CONTROLLER CARD SALE! \$149.95

13315 CORCOMP 32K MEMORY CARD \$119.95

20164 BOX WITH POWER SUPPLY

for external disk drive \$ 59.95

31173 WICO 3-WAY

GATELOCK JOYSTICK \$ 24.95

10285 TI JOYSTICK ADAPTER \$ 4.95

42442 TAC 5™ JOYSTICK. Requires TI Adapter \$ 14.95

42086 SLIK STICK™ JOYSTICK. Requires TI Adapter \$ 6.95

13329 NAVARONE CARTRIDGE EXPANDER \$ 24.95



SHIPPING CHARGES

ORDER AMOUNT	CHARGE
less than \$20.00	\$3.75
\$20.00-\$39.99	4.75
\$40.00-\$74.99	5.75
\$75.00-\$149.99	6.75
\$150.00-\$299.99	7.75
\$300 & up	8.75

Foreign Orders add \$4.00
Heavy items ship at actual cost.

NO EXTRA FEE FOR CHARGES



We verify charge card addresses

ORDER TOLL FREE
1-800-348-2778
INDIANA 1-800-225-6838



Comments

Opening the box on the 9640

The Myarc 9640 computer is finally out. MICROpendium received a 9640 card and keyboard just days before this edition went to press. What follows is a very brief introduction to the system. Because of deadline requirements, it was not possible to examine the product in-depth. Next month's MICROpendium will include a comprehensive review of the computer.

We had just enough time to plug the card into the PEB (after removing the TI system card) and fire it up. We used the 9640 in a system that includes a Myarc disk controller, two floppy disk drives and a TI RS232 card. (Most other peripheral cards have to be removed from the PEB while the 9640 is used.) We tried out three monitors, including two composite monitors (one color and one monochrome) and an RGB analog monitor. This article was partially written using the 9640 with the Myarc 9640 Word Processor, an enhanced, 80-column version of TI-Writer.

The 9640 card is housed in a standard plastic clamshell case. The most noticeable difference between it and other cards are the four ports on its end. These are for the monitor, the keyboard, a mouse and a joystick. The monitor plug is an 8-pin DIN-type that accomodates either a 5-pin DIN connector for a composite monitor or an 8-pin DIN for an analog RGB monitor. The mouse port works only with the yet-to-be-released Myarc mouse and the joystick port works with an Atari-type joystick. However, we did not have time to try out any joysticks.

For programs that use standard 32- or 40-column display,

a color composite monitor should prove to be adequate. It is inappropriate for use with 80-column display. A composite monochrome monitor provides readable 80-column text but is probably inadequate for use with most games that use color. An analog RGB monitor provides the best resolution for 80-column text as well as games. Since the word processor is the only piece of a software I used (and not for long at that), I am necessarily limited in what I can say about the 9640. However, I can report that the 80-column display worked fine and I had no trouble accessing disk drives or a printer. The keyboard is a standard Korean product marketed with many PC clones. It has its function keys located at the top. Cursor control keys are in a separate group to the right of the main key-group. To the right of the cursor keys is a numeric keypad. The keys are responsive to a light touch.

Because of the brief time I've used the 9640 I won't go into any more detail this month. We expect to publish more about the system over the next several months.

Just so you know that we know: we're a little late with this edition. Several things conspired to slow us down, including the installation of new digital typesetting equipment and the learning curve that comes with it, the fact that February was a short month and our hope to get more information about the 9640 in this edition than we managed. (We got the Geneve too late to meet our deadline and then had to fill in two pages designated for the Geneve with other material.) We will do better next month.

—JK

Reviewed in MICROpendium

1984
February: B-1 Nuclear Bomber, Tandon TM-100 Disk Drive, Void, Beanstalk Adventure, Microsurgeon, On Gaming, Database 500
March: Star Trek, Escape From Balthazar, Garkon's Getaway, Sky Diver, Mail-Call, Prowriter 8510 Printer
April: Monthly Budget\$ Master, Budget Master, Home Budget, Thief, Donkey Kong, Khe Sanh
May: Companion Word Processor, Q*Bert, Mad-Dog I & II, Programs for the TI Home Computer
June: Creative Expressions Accounts Receivable/Accounts Payable, CDC 9409 Disk Drive, Starship Concord, Lost Treasure of the Aztec, ASW Tactics II
July: Theon Raiders, Introduction to Assembly Language for the TI Home Computer, Game of Wit, Pole Position
August: TE-1200, Tower, Galactic Battle, Galaxy
September: Wycove Forth, 99/4 Auto Spell-Check, QUICK-COPYer, Wizard's Dominion, Anchor Automation MK XII Modem
October: Killer Caterpillar, ZORK I, Defender
November: 9900 Disk Controller Card/Manager, Super Bugger, Transtar 120S printer, Floppy-Copy, Data Base-X
December: Gravity Master, Data Base Manager System, Learn-

ing 99/4A Assembly Language Programming

1985
January: Super Sketch, Foundation Computing 128K Card, PTERM-99, TI-Runner
February: Super Extended BASIC, Beginning Assembly Language for the TI, ZORK II
March: Morning Star Software CP/M Card, WDS/100 Winchester Disk Drive, Sketch Mate, BMC Color Monitor
April: 9900 Micro Expansion System, Disk + Aid, Gemini 10X-15X
May: Character Sets and Graphics Design, Draw 'N Plot
June: GRAPHX, DATA BASE I
July: Acorn 99, Advanced Diagnostics
August: Model Dow-4 Gazelle, TI-Artist, PC-KEYS, Not-Polyoptics' Bankroll
September: Midnight Mason, Myarc 32K/128K Card, GRAPHX Companion
October: 4A/TALK, Extended BASIC II Plus, XB Detective, Console Writer 2.1
November: Foundation Z80A/80-column cards, 9900BASIC, Adventure Editor
December: Display Enhancement Package, Triple Tech

1986
January: BITMAC, Starcross
February: Night Mission, Peripheral Diagnostic Module, BA-Writer
March: Super Duper, Tunnels of Doom Editor, Business Graphs 99
April: U.S. Open Tennis, PRBASE
May: 4A Flyer, GRAM Kracker, Artist's Companion
June: Myarc Disk Controller Card, Maximem
July: Horizon RAMdisk, Old Dark Caves, Funlwriter, T199/4A Macro Assembler
August: JOYPAINT 99, GPL Assembler, T199/4A INTERN, GPL Linker
September: Mechatronic 128K card
October: TI-Forth Utilities, CorComp Memory Plus
November: Submarine Commander, PEP, MAX-RLE
December: GK Utility I and II and GRAM Packer, X-10 Power-house, RAVE 99/101.
1987
January: MG DISKASSEMBLER, Myarc XBII.
February: TI-Tax, Mechatronic Mouse

Available on your dealer's shelf now!



ANNOUNCING MYARC'S 640K RAM

GENEVE *t.m.*

MODEL 9640 FAMILY COMPUTER

This unit is without a doubt the most sophisticated machine ever offered in the family and small business area to date. With over a year of design and development, including input from more than one hundred users, this machine has surpassed even our own expectations. Take a moment to review some of the many features that place this computer in a class of its own.

*** 99/4(A) COMPATIBLE
RUNS OVER 100 EXISTING
TI CARTRIDGE PROGRAMS**

*** 99/4(A) COMPATIBLE
RUNS OVER 95% OF ALL
ASSEMBLY LANGUAGE
PROGRAMS & UTILITIES**

*** TI-WRITER NOW A FULL
80 COLUMNS**

*** MULTIPLAN ALSO 80 COLUMNS**

LARGER
Standard 640K RAM
2 MEGAGYTES Addressable RAM
MYARC Memory Card Compatible
With MYARC 512K Card,
Supplies 1.1 MEGABYTES RAM
IBM TYPE KEYBOARD Included

FASTER
At Least 2 - 3 Times
PHONE TYPE CABLE
Replaces Old Hex Bus Cable

MOUSE SUPPORT

- Separated Function Keys
- Incredible Graphics Capabilities
- Basic 3.0
- Composite Video Output
- RGB Output
- 128K VDP RAM Memory
- 40 Column Display
- 80 Column Display
- Mouse Output Port
- Joystick Port
- Sound Compatible & Expandable
- Speech Included
- Compatible with Existing Peripheral Cards*
 - Disk Controllers* (MYARC, TI, Corcomp)
 - RS232 Cards* (MYARC, TI, Corcomp)
 - MYARC Memory Expansion Cards Add Directly to RAM (modification required)
- True Hardware Utilities
 - Sprites, Fills, Lines, Data Moves
- TI 9995 Processor Chip - 12 MHz
 - 256 Bytes ULTRA High Speed on Chip RAM
 - Pre-fetch on Instructions
 - Post-store on Instructions
- More RAM Memory than any machine in its price class

For further information, contact your nearest dealer.

If unknown, contact MYARC (201) 766-1700 for dealer information.

Feedback

Multiple colons in Extended BASIC

In Regena's BASIC/XBASIC column (Jan. '87), she implies that BASIC programs which use multiple colons in print statements which are not separated by spaces will not run in Extended BASIC as XB interprets them as statement separators.

In actuality, a line containing multiple colons (no spaces), which is typed in in console BASIC, saved, and then loaded into Extended BASIC will perform just fine. When listed in XBASIC, the colons will be separated by spaces. This is because when the ENTER key is pressed during the initial program entry, the line is "crunched" and each colon is converted to a "token which will tell the computer to move the cursor to the beginning of the next row. XBASIC recognizes that "token" as the same (functionally) but "uncrunches" it for listing purposes as "colon space."

Kenneth M. Woodcock
Norfolk, Virginia

Multiplying lives

In some of the cartridge games for the TI99/4A, you can change the number of lives or the starting level by following this procedure: Insert the cartridge and turn on your computer. When the title screen appears, after selecting the game, quickly type *****.

Brian Doornboos
Tucson, Arizona

Article subject comments

Finally got time to write you on the article you wrote on me last September.

You got it a little backwards, but not too much so.

The list we had on Name-it that consisted of 14 files we had on several disks, as we had only single-density TI controller at the time. We had two lists of 250 each and one of 150 on each disk for the 2,100 total names. We used the instructions in the Navarone DBM manual to translate the files from Int fix 254 to dis fix 127.

To do this, I used the "print" option of Name-it and DskXXX as the device name.

With the CorComp controller, I run our drives as double density so we have 1,438 sectors there to go into. I "printed" each of the files onto the clean disk, one after the other so they were in sequence. I found that I had to use the selective print option where you press function 6 (proceed) to print the record currently on the screen, otherwise it lost a few records by the wayside.

When I had them all on the one disk, then I went in with MG Advance Diagnostics and changed the FDR to indicate the file size as being the whole works and this gave me the one long list that was readable by Navarone.

Discovered a problem with Navarone: for the key field, we were using the phone number, 10 digits (no spaces). But after about 2,500 names, the console memory was full with the key fields, so use a four-digit number for the key field if you are doing a long list.

Another problem with Navarone is loading the REPORT section. For most of the sections, you can press any key to go to the next screen, but for Reports, to load properly, you must press the space bar only to go to the next screen.

With Navarone DBM, we do the mailing labels and the renewal letters for the subscribers. We send these on an 8½x11 sheet that is perfed at 5½ inches and type a dotted line on the perf with a lowercase message "tear here and return lower half with your check." Works very well, renewal response is way up with this form. The forms they send back are penciled in the amount of the payment and the new date of expiration and left in the book till the paper goes to press. Then we do the updating once a month. The DBM makes it almost a joy to do it. You just type in the code number and the record comes right up and you do the update and press proceed and it is filed on the disk.

I discovered double window envelopes at NEBS in Groton, Massachusetts. I use them for the mailings. I do not have to do labels for the letters or return addresses, just format the letter so my address shows in the top window and four lines down the addressee's address.

My wife Carole is the executive direc-

tor of the Statewide Towing Association (of Massachusetts) and a member of the Council of State Towing Associations of the Towing and Recovery Association of America. She does a monthly newsletter for the Statewide Association and keeps the membership (375) updated.

We both use BA-Writer now. It is what TI should have had in the first place. If anyone out there does not have it, get it. We run it out of Extended BASIC instead of the TI-Writer cartridge. We can also run it without the Extended BASIC, by using the Load and Run option on the CorComp controllers.

I now have a CorComp 512K memory card on my machine and I put the BA-Writer on it as Dsk 1. Then I can press "3" for Extended BASIC and it loads in a flash and for going back and forth between Editor and Formatter, no more waiting, it is right there. Coupled with the BA-Writer's memory for file names and ability to stay in Formatter after printing a letter, it is just fantastic!

With the 512K card I can sort the large file I have in Navarone "up there" in the RAMdisk in a much shorter time and no error messages about disk full. I do a sort for zip code right after updating the list with the sorted file in the RAM disk as Dsk1.ZIP, then do a date code form that as the source file and Dsk1.DATES as the sorted file. This second sort takes less than a minute for 600 names.

As for MG's Advanced Diagnostics, if you do not have it, shame on you! Get it! I saved a file that sort of self destructed at 1:30 a.m. today. Disk was kind of full with 75 files on it, but only using 875 sectors out of 1,438. I was able to locate the File Descriptor Record and go in and see the file was there, so I printed it out to the Okidata 82A through the Advanced Diags screen cump facility so we had the data there in print anyway. I saw that it was split in two sections and the File Descriptor Record had no address information whatsoever, just the file name. Using the manual, I set up the "Dis Var 80" and the number of sectors and the beginning addresses and got it to be found. But the BA-Writer still would not load it back into Editor for me. Looked into the sectors again, saw extra stuff on the last line in

See Page 10)

NEW

TEX+COMP proudly presents

Quick & Easy Word Processing with Your TI Computer

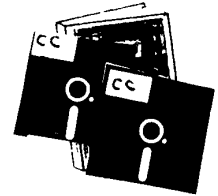
WRITEREASE™From  CarComp**FEATURES:**

- On Screen help menu
- TI formatting commands supported
- FIND String up to 10 times faster than TI Writer
- Word wrap and non-word wrap modes are available
- 30000+ Word Spell Checker

WRITEREASE* IS A BRAND NEW PROFESSIONAL LEVEL WORD PROCESSING SYSTEM FOR OWNERS OF THE TI-99/4A COMPUTER. IT PICKS UP WHERE TI WRITER LEFT OFF... WITH ON SCREEN HELP MENU, DEFAULTS AND SCREEN COLORS ARE USER SELECTABLE ALONG WITH WORD WRAP MODE. THE SYSTEM ALSO SUPPORTS TI FORMATTING COMMANDS. LOADING AND SAVING FILES TO DISK IS TWICE AS FAST AS TI WRITER. THE SYSTEM WITH SPELLING CHECKER WILL WORK WITH ANY TI-99/4A DISK BASED SYSTEM WITH AT LEAST ONE DISK AND 32K OF MEMORY. IT IS THE ONLY WORD PROCESSING SYSTEM DESIGNED TO ACCESS THE CORCOMP 256K AND 512K MEMORY PLUS CARDS OR STAND ALONE UNITS. THE USE OF THESE EXTRA MEMORY UNITS WHILE NOT REQUIRED, WILL PROVIDE LIGHTNING SPEED ACCESS TO THE FILES AND SPELLING CHECKER.

ONLY \$ 49.95 + S&H

COMES COMPLETE WITH WORD PROCESSING PROGRAM & SPELLING CHECKER. LOADS WITH EXBASIC OR ED ASSEMBLER MODULE. COMPATIBLE WITH ALL PARALLEL AND SERIAL PRINTERS. REQUIRES A MINIMUM OF 32K MEMORY EXPANSION, ONE DISK DRIVE AND PRINTER. EASY TO FOLLOW DOCUMENTATION INCLUDED.

SPECIAL OFFER THE WRITEREASE* WORDPROCESSING SYSTEM CAN BE PURCHASED WITH A SPECIAL DISCOUNT OF \$10 WITH THE PURCHASE OF ANY CORCOMP MEMORY PLUS PRODUCT OR PROOF OF PURCHASE OF A PREVIOUS PURCHASE FROM ANY DEALER.

Send order and make checks payable to:

TEX+COMP

P.O. BOX 33064 - GRANADA HILLS, CA 91344



AUTHORIZED DEALER



VISA and MASTERCARD
HOLDERS CALL DIRECT
(818) 366-6631
24 Hour Order Line

TERMS: All prices F.O.B. Los Angeles. For fastest service use cashiers check or money order. Add 3% shipping and handling (\$3.00 Minimum). East of Mississippi 4 1/2%. Add 3% for Credit Card orders. Prices and availability subject to change without notice. We reserve the right to limit quantities.

NOTE: Payment in full must accompany all orders. Credit card, Company check or Money order for immediate shipment. Personal Checks require up to 4 weeks to clear. California orders add 6 1/2% sales tax.

Feedback

Continued from Page 8)

each sector after about 10 sectors, so toggled back into Hex and filled all the last lines with "Fs" then did a Write sector for each sector and it did load into the BA-Writer again for us. This was a tape transcribing which, had it been lost, would have meant three or four hours to do over.

Thank you, MICROpendium, for telling me about Navarone and MG. I also learned about BA-Writer through MICROpendium.

As for the Tow Show, Carole has a program in Navarone where she inputs their requirements for booth space, hotel rooms, ad space and trophy sponsorship and can get out a printout with the total number of rooms with dollar amount and the vendor space with dollar amount and send out confirmation letters for the people.

J. Gibney
Hyde Park, Massachusetts

Help needed with Axiom printer

After a year of dabbling with the TI, I purchased TI-Writer. This required a printer. Not knowing anything about printers and being retired I bought price — an Axiom GP100TI. This was a big mistake for several reasons:

1. The manual which they furnish is almost unintelligible to a novice such as me.

2. Although the machine senses and alerts you to its arriving at the perforation in the paper, it continues to print right on top of the perforation!

3. Complete lack of customer relations. I've written them five times if there is any DIP switch setting which will cause the printer to skip over the perforation and start at the top of the succeeding page.

Thus, this letter to you.

Is there anyone familiar with this printer who could advise me as to how I can get an automatic perforation skip? It would seem to me that, since the machine recognizes that a perforation is imminent that it must have been engineered to skip over it, right?

Another thing it will not do — the Myarc

128K RAM card has a feature called "print spooling." According to the manual, to enable this one opens the printer with "SPPIO." For some reason, it won't work with my Axiom.

From all I've read, this Myarc card is considered to be very good. But, other than using it as a second disk drive (which I do), and being able to print-spool (which I can't) I don't see much else. What the 128K stands for is beyond me; because you certainly don't get any increase in memory. One is still locked in to 48K.

F.M. Seibert
Farmington, Michigan

Unfortunately, we have never used an Axiom printer and get help you with specifics. However, virtually all printers print across page perforations. Generally, one prevents this by adjusting the page formatting commands of the software, in your case TI-Writer. Make sure that your page length doesn't exceed 66 lines and that you start the printing process at the top of a page (TI-Writer will advance several lines before actually printing a line of text but these advanced lines count toward the 66-line total.)

Readers with Axiom printers and Myarc RAMdisks may be able to provide answers regarding your print spooling problems. We assume you are partitioning the spooler/RAMdisk according to the manual.

Keep listings short

I would like to comment on the inclusion of program listings, especially games in the December issue. You should use the limited space available for instruction, news, etc. and leave out the listings, except for the short ones. The early days of the TI computer were well-served by the inexpensive availability of this source of programs. Times have changed with the very good quality software at low prices. Freeware is a good example.

Chester Morrison
Worcester, Massachusetts

TI-Writer won't

When I bought and installed Myarc's 512K card, my TI-Writer module would no longer work. Funlwriter is a good

substitute except that some utilities, such as my spell-checking program, do not work properly with it. Can anyone explain why only the TI-Writer refuses to work, and is there any way to get it to work properly?

Thomas Owens
Ashland, Ohio

We can't explain it. We can't duplicate the problem with our Myarc RAMdisk, which runs TI-Writer, as well as Funlwriter, TK-Writer and BA-Writer. Could it be that your TIW cartridge is defective?

Won't initialize

I have the regular PEB and disk drive setup but have not been able to initialize new disks for the past two weeks. All other functions, such as reading or writing to disks and files work fine, but every time I try to format a new disk, the error message appears indicating no disk in drive. I keep wondering if this is a mechanical problem with the drive or a malfunction in the controller card.

Any suggestions where to start to fix this problem would be very much appreciated.

Helmuth Dann
Lake Worth, Florida

Your problem probably lies in your disk controller card. A problem with a disk drive would probably affect all read/write functions and not just formatting. The quickest and cheapest way to make certain that the controller is defective is to borrow a controller from another TI user in your area and plug it into your PEB. If it initializes a disk then you know your controller is the culprit. Repairs are probably best left to the manufacturer.

The Feedback column is for readers. It is a forum to communicate with other readers. The editor will condense excessively lengthy submissions where necessary. We ask that writers restrict themselves to one subject for the sake of simplicity. Our only requirement is that items be of interest to persons who use the TI99/4A home computer. Mail Feedback items to: MICROpendium, P.O. Box 1343, Round Rock, TX 78680.

TEXCOMP™ Proudly Introduces
 "The Leader of the Pack!"

SUPER JOYSTICK III

for the TI-99/4A

NEW

The World's First High Performance Joystick

- The only joystick actually designed to fit in the palm of your hand.
- Trigger finger firing for faster, more accurate shooting.
- Tactile response switches on top for faster, more precise movements.
- Microswitches guaranteed for ten million uses.

\$24.95 + S&H includes 2-unit adapter (reg. \$10.95)
ONLY \$14.95 IF YOU ALREADY HAVE THE ADAPTER



SUPER JOYSTICK III

IT ISN'T EASY, FOLLOWING IN OUR OWN FOOTSTEPS. IN 1981 WE RECOGNIZED THAT THE ORIGINAL TI JOYSTICKS LEFT SOMETHING TO BE DESIRED ON HIGH SPEED AND MAZE TYPE GAMES SO WE INTRODUCED AN ADAPTER TO USE THE MORE RUGGED ATARI TYPE JOYSTICK WITH THE 99/4A. IN 1982 AT THE TI FEST IN SAN FRANCISCO, WE INTRODUCED OUR SUPER JOYSTICK I WITH IMPROVED CONTACTS AND ACTION. IN 1983 WE INTRODUCED THE SUPER JOYSTICK II WITH A SELECTABLE 4/8 WAY ACTION TO ELIMINATE ERRORS IN HIGH SPEED MAZE TYPE GAMES.

NOW IN 1987 WE ARE PROUD TO INTRODUCE THE FINEST JOYSTICK EVER AVAILABLE FOR THE TI-99/4A. OUR SUPER JOYSTICK III WHICH USES A PRECISION MICROSWITCH MOVMENT SO THAT THE CURSOR (OR GAME FIGURE) GOES EXACTLY WHERE YOU WANT IT TO GO WITH SPEED AND ACCURACY. IN FACT, IT IS SO ACCURATE, THAT THE NEED FOR SWITCHING FROM 4-WAY TO 8-WAY IS ELIMINATED. THIS NEW JOYSTICK IS MADE IN ENGLAND AND IMPORTED BY EPYX WHICH OFFERS A 5 YEAR NO STRINGS (OR CHARGE) WARRANTY ON THIS FANTASTIC UNIT.

WE TURNED LOCAL USER GROUP MEMBERS LOOSE WITH SAMPLES OF THIS NEW JOYSTICK AND THE REVIEWS WERE OUTSTANDING. ONE USER RAISED HIS ALL TIME MUNCHMAN SCORE ON THE FIRST TRY. ANOTHER FOUND THE PRECISION MOVEMENT BETTER FOR CREATING GRAPHICS WITH HER GRAPHX AND TI ARTIST PROGRAMS THAN WHEN USING A TRACBALL.

THE INTRODUCTORY PRICE OF THIS NEW JOYSTICK IS ONLY \$24.95 which includes a special "Y" adapter. If you already have a TI joystick adapter, the price is only \$14.95 each, A SAVINGS OF \$5 OFF THE SUGGESTED RETAIL OF \$19.95 (less adapter)

ORDER NOW AND BE PREPARED TO SET NEW HIGHS IN YOUR GAME SCORES AND GRAPHIC CREATIONS.....

Send order and make checks payable to:

TEXCOMP

P.O. BOX 33064 - GRANADA HILLS, CA 91344



AUTHORIZED DEALER



VISA and MASTERCARD
 HOLDERS CALL DIRECT
(818) 366-6631
 24 Hour Order Line

TERMS: All prices F.O.B. Los Angeles. For fastest service use cashiers check or money order. Add 3% shipping and handling (\$3.00 Minimum). East of Mississippi 4½%. Add 3% for Credit Card orders. Prices and availability subject to change without notice. We reserve the right to limit quantities.

NOTE: Payment in full must accompany all orders. Credit card. Company check or Money order for immediate shipment. Personal Checks require up to 4 weeks to clear. California orders add 6½% sales tax.

Techie Corner

Excuse me, may I please LOAD?

This is the second in a series of articles by Technical Editor Mack McCormick focusing on circuit board projects for the TI99/4A—Ed.

By **MACK MCCORMICK**
Technical Editor

This is another simple, single chip device you may build to improve the efficiency and productivity of your computer. (I promise starting next month the projects will increase in difficulty. As mentioned in the Techie Corner, I have the DSR/Clock circuit finished, GROM emulator, and I am almost finished with an interface for a full-size keyboard.)

As most of you already know, the TMS9900 chip has the facility to use a LOAD interrupt to perform a context switch to another program. A context switch is just like a BLWP instruction in assembly language. The computer takes the first word for the new workspace and the second word for the program entry point. The old WS and PC are stored in the new WS registers R13 and R14, respectively. For future reference, LOAD is called Non-Maskable Interrupt (NMI) on the TMS9995 chip but the address and functions are identical. By using this LOAD vector you can jump into another program from a running program for functions such as screen dumps or debugging. The standard TI DEBUG program has the software included to take advantage of the LOAD vector.

Many of you are probably saying, 'Why should I build this circuit when a push button switch across pins 13 and 21 of the side port will do the same thing?'

You're correct that a simple push button will work but it is not as reliable as this circuit, primarily because it isn't debounced. And, you can get multiple LOAD interrupts in the improper timing sequence which can cause your computer to lock up.

This circuit provides only one LOAD pulse and the pulse is timed to occur when the computer is acquiring an instruction so it always arrives at the proper time. For a mere three parts with a total cost of under \$1 you can have a dependable means of executing the LOAD vector.

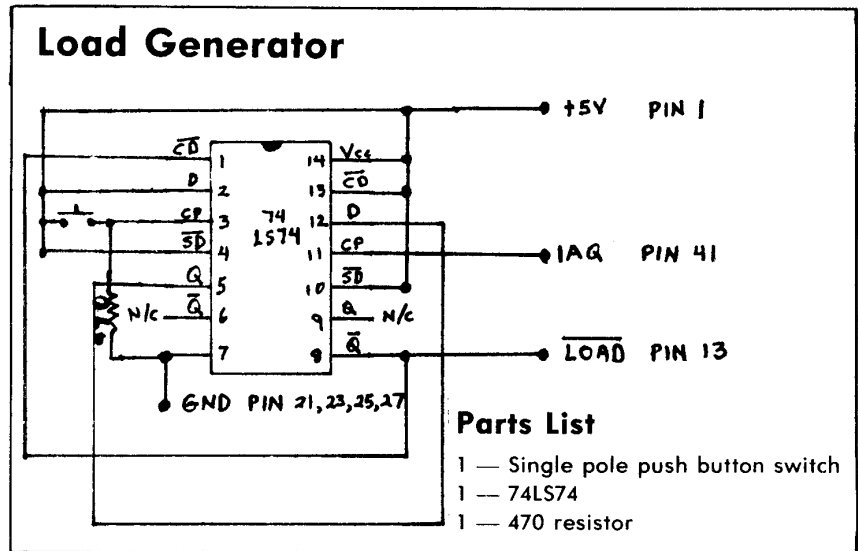

How It Works

Let's first describe how the 74LS74 (Dual D-Type Positive Edge-Triggered Flip Flop) works. It is actually two identical chips in one housing. D is the input, CP is clock pulse, Cd bar is clear, Sd bar is set input, Q is an output with the same value as D and Q bar is the inverted output of D. The bar following the symbol name means active low. Here is an extract of the truth table for the functions we are emulating:

Operating Mode	Inputs		Outputs	
	SD	Cd	Q	Q bar
Set	L	H	X	L
Reset (Clear)	H	L	X	H
Load 1	H	H	H	L
Load 0	H	H	L	H

The one entry not shown here is the CP clock pulse. This is the pulse which causes the chip to operate. It enables the LOAD 1 and LOAD 0 functions as it makes the transition from low to high. When it is low or high the D input has no effect.

In this circuit, chip one (pins 1-6) provides the pulse from the push button switch to the second half of the chip (pins 8-13) which provides the LOAD bar signal to the computer when the instruction acquisition pulse is active high. Half one of the chip has the D and Sd bar inputs tied high to

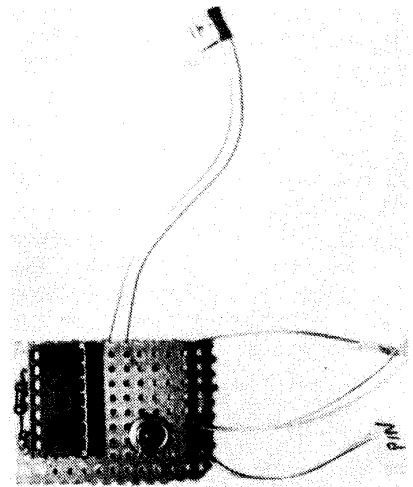

Load Generator circuit

5 volts. The Cd bar input is tied to the Q bar output of the second chip. This is the Load 1 entry in the truth table. When CP goes from low to high when the push button switch is pressed then the H value at D is transferred to the Q output. The 470 ohm resistor is necessary to cause CP to be at a low value so the chip can sense the transition. This value was obtained from Ohms Law using the technical data for the chip.

(See Page 14)

Easily
Do you want to create:

business cards, letterheads, advertisements, announcements, reports,
presentations, forms, flyers, note paper, book reports, greeting cards
newsletters, exams, school projects, term papers, cartoons,
books, transparencies, bookmarks, annual reports,

or anything else that combines words with pictures?

Then you need Font Writer II

Font Writer II

- is written in assembly at crucial points for speed,
- lets you use TI-Writer to create the words you want,
- uses standard TI-Artist fonts and pictures (over 100 fonts available alone and literally thousands of pictures!),
- lets you use CSGD graphics too with simple conversion utilities,
- includes a Font Editor for creating that special font,
- includes a Font Manager for the amateur or professional font designer,
- interfaces with popular graphics programs,
- includes a variety of pictures and fonts so you can begin right away,
- is a complete electronic publishing package that will continue to be updated in the years to come,
- is compatible with the Myarc Geneve 9640 computer,
- and is fully documented with a 40 page typeset manual written by a professional technical writer.

Requires a disk system, 32K, Extended BASIC, and an
Epson compatible/TI/Prowriter printer.

\$24.95 includes shipping and handling

Why settle for less than the best?

**Asgard Software
P.O. Box 10306
Rockville, MD 20850
(301) 345-2492**

TECHIE CORNER—

(Continued from Page 12)

Half two of the chip receives the Q output from half one on it's D input (pin 12) and because Cd bar and Sd bar are high the Load 1 input on pin D is transferred to the Q bar output (pin 8) when the in-

struction acquisition pulse is high (IAQ) from the CPU, indicating the computer is fetching an instruction (logic table Load 1).

As soon as LOAD bar goes low the CPU executes the context switch using the memory words at >FFFC and >FFFE and the chip resets itself because half one Cd bar goes low (logic table reset). What we have done is provide one low pulse to the LOAD bar line of the CPU exactly when required during instruction acquisition.

title screen. You should be able to press your LOAD Generator button and the DEBUG prompt should reappear on your screen indicating you successfully returned to the DEBUG program.

I'd appreciate your feedback on this series to let me know if the articles are understandable from a technical standpoint.

Until next time, have fun.

Kitsap 99ers plan fair

The Kitsap 99ers of Kitsap County, Washington, are holding a Computer Fair at the Kitsap Mall in Silverdale, Washington, April 11-12, with other computer clubs in the area, says Danny J. Stevens, vice president of the group.

Stevens says the Kitsap 99ers sponsor a Forth Interest Group, meeting at 8 a.m. Saturdays at Sinclairs Restaurant in downtown Bremerton, Washington, which would like to hear from other Forth groups or interested parties. Address is Forth Interest Group, c/o Danny Stevens, 1747 Burwell St., Bremerton, WA 98310.

**HARDWARE MANUAL
FOR THE
TI 99/4A**

DESCRIBES:

- Console Design
- Custom Chip Operation
- TMS 9900 H/W Organization
- TMS 9900 Instruction Set
- Interfacing Pitfalls
- Console Schematics
- PEB Card Descriptions
- GROM Simulator Design
- Extended Basic Module description & schematics



Send \$ 19.95 Check or Money Order To:
THE BUNYARD GROUP
PO Box 53171, Lubbock, TX 79453

Construction and Installation

You can build the entire circuit on a piece of perf board in less than 20 minutes. With only four wires to connect, it will fit nicely into your speech synthesizer housing. Pin numbers for connection refer to the side port of the computer. Remember: all the even numbered pins are on top and odd numbered on bottom.

Testing

After all the wires are connected load the TI DEBUG program. After it's loaded enter the program and (Q)uit back to the

TI-TAX TI-TAX TI-TAX

-LADY LIBERTY HAS BEEN RENOVATED
-THE NATION'S TAX PROGRAM WAS RENOVATED
-YOUR TAX PREPARATION CAN BE RENOVATED
-DO YOUR OWN TAXES ON YOUR TI-99/4A

THESE EASY TO USE TEMPLATES:

- Generate and print IRS useable Forms and Schedules
- Get data from related Forms & Schedules
- Can link to your other Multiplan (TM) records
- Do most of your calculations
- Can be used in lieu of IRS preprinted forms
(Except forms requiring signature)

MAKE CHECKS TO:

William G Chavanne
4549 English Avenue
Fort Meade, Md 20755
(301)672-1980

B/ /J	Disk: SHORTFORMS	SHAREFORM	SCHEDULES	OTHERFORMS
	--\$19.95--	>>\$9.95<<	--\$19.95--	--\$19.95--
	Contains: FLOWCHART	FORM1040	SCHEDDP2	FORM1040X
	FORM1040A	FORM1040P2	SCHEDP2	FORM2106
	FORM1040A2	FIGURETAX	SCHEDULEA	FORM2441
	FORM1040EZ	(includes: X,Y,Z,&6)	SCHEDULEB	FORM3903
	FORM4P3	FLOWCHART	SCHEDULED	FORM6251
	PRINT17	PRINT17	SCHEDULEE	FORM4P3
	SCHEDULE1	DOCUMENTATION	SCHEDULEW	
	SCHED1P2		(Docs on SHAREFORMS disk)	
	DOCUMENTATION			

REQUIRES:
32K
17CPI PRINTER
MULTIPLAN

Add \$4.00 shipping and handling

TEX⁺COMP™

America's Number One TI computer retailer

puts the big names in software on line.

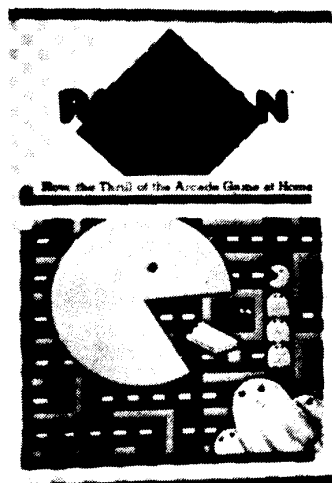

Play the Original Arcade Classics in Your Own Home

PAC-MAN CENTIPEDE DONKEY KONG POLE POSITION



PAC-MAN, POLE POSITION, CENTIPEDE & DONKEY KONG ARE THE ALL TIME FAVORITE COIN OPERATED ARCADE GAMES. ALL OF THESE GREAT TITLES ARE AVAILABLE NOW FROM TEX-COMP FOR YOUR TI-99/4A HOME COMPUTER. THESE ARE THE GREAT ONES AND QUANTITIES ARE LIMITED. AS ALWAYS, TEX-COMP OFFERS THE BEST FOR LESS.

It's the best software at the best prices **\$9⁹⁵** each +s&h
BUY 2—GET 1 FREE! **\$19⁹⁵** any three +s&h
 ALL TITLES MUST BE DIFFERENT—NO DUPLICATES PLEASE!!

EXTRA SPECIAL::ALL FOUR TITLES FOR ONLY \$26.95

Send order and make checks payable to:

TEX⁺COMP

P.O. BOX 33064—GRANADA HILLS, CA 91344



AUTHORIZED DEALER



VISA and MASTERCARD
 HOLDERS CALL DIRECT
(818) 366-6631
 24 Hour Order Line

TERMS: All prices F.O.B. Los Angeles. For fastest service use cashiers check or money order. Add 3% shipping and handling (\$3.00 Minimum). East of Mississippi 4½%. Add 3% for Credit Card orders. Prices and availability subject to change without notice. We reserve the right to limit quantities.

NOTE: Payment in full must accompany all orders. Credit card, Company check or Money order for immediate shipment. Personal Checks require up to 4 weeks to clear. California orders add 6½% sales tax.

BASIC

Name those capitals and states

By REGENA

First of all, thank you for your letters and your warm reception to me as a new columnist for MICROpendium. I welcome your suggestions for topics for this column and have received ideas for several future discussions.

Also—I usually do not have time to announce TI conventions in my columns because I often write my columns three or four months in advance. However, this time I do have a chance to let you know I will be a guest at the Second Annual New England "FAYUH" on April 4, 1987, and am looking forward to meeting the users groups and other friends there at Boston, Massachusetts. I'll be happy to discuss BASIC programming with you in person there during the day.

For those of you who program, there is no "right" way and "wrong" way to program in BASIC. As I have taught programming, I have tried to tell beginning programmers that if the program does what YOU want it to do, then you have a successful program. And yes, if you want to use my program as a beginning point for a program of your own, that's fine. A lot of my programs have been written for you to use, then adapt or customize—or to use some of the techniques to write your own program.

Many of the letters I have received over the years have been requests for programs—the most requested are the rest of the touch typing units, more on algebra and the rest of the states in the United States and capitals programs. The typing units are complete and the ones that have not been published in books or magazines are available on my shareware disk. I probably will write more algebra programs later. Now here is the last set of states, which I have called the Central States.

The previously published programs were Western States, Southern States, New England States and Atlantic States. This Central States program contains all the states not in the other groups except for Alaska and Hawaii. (You may want to add Alaska and Hawaii to the Western States program.) If you have the Western States program or the Southern States program, this program uses the same map and program idea but changes the DATA statements and adjusts the numbers necessary for the 13 states included. To type in the program you could load one of the previous programs, then compare and edit lines.

An outline of the continental United States is shown. One of the states is chosen at random and outlined. The user must then type the name of the state and press ENTER. If the name of the state is correct, the user is then asked for the capital. Type the capital city, then press ENTER. If you need to correct a typing error, press FCTN REDO. The spelling must be correct for the answer to be correct. If the answer is incorrect twice, the correct answer is given, and that state will reappear in the quiz. If the state and capital are correct, that state will not be chosen again.

This program contains a lot of DATA statements, so be careful in typing. Make sure you do not get extra commas. Lines 290-330 contain data for defining graphic characters for the map.

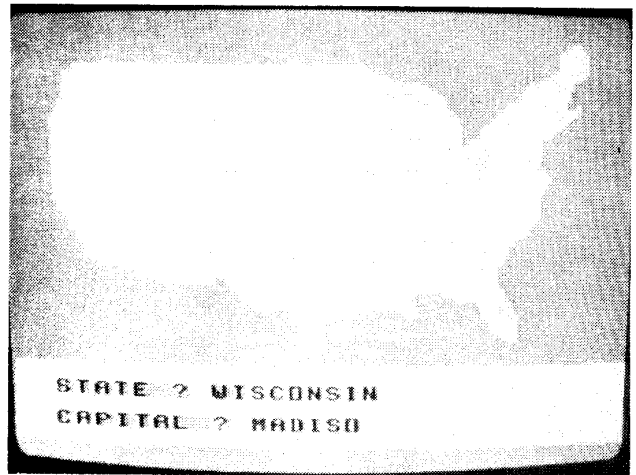

Lines 390-410 contain the state names and corresponding capital cities. Lines 1540 to the end contain the data in subroutines for outlining the states. RESTORE is used to restore the proper data for each state. The first number in the first data statement for the state is how many graphic characters need to be defined, then there are that many graphic character definitions. After the character definitions is a number indicating the number of graphics characters that need to be placed on the screen to outline the state. The DATA statements then have numbers in groups for a row, a column and a character number. The next data element is a number for the number of CALL HCHAR statements necessary to erase the outline of the state. The last sets of numbers are row, column, character number and repetitions for erasing.

Lines 490-530 draw the map on the screen by using PRINT statements with redefined characters. Release the ALPHA LOCK key to type the lowercase characters in the PRINT statements, but push the ALPHA LOCK key back down when you type in the rest of the program and run it.

If you wish to save typing effort, you may have a copy of this program by sending \$3, a blank cassette or diskette and a stamped, self-addressed mailer to REGENA, P.O. Box 1502, Cedar City, UT 84720. Please be sure to specify that you need the TI99/4A version of "Central States."

Extended BASIC notes

I have been having fun with the Extended BASIC II Plus command module from Mechatronic. Although I don't usually do formal reviews of products, I would like to let you know what this product is like. (XB II+ was reviewed in the October 1985 MICROpendium—Ed.) If you are thinking of getting another TI Extended BASIC module or you are just getting started with Extended BASIC, you might be interested in this module.

This module is compatible with the regular TI Extended BASIC but also contained an extended statement set — more words are available with CALL to offer more programming capabilities. The

See Page 18

Sensational Prices!!!

... On Our Most Popular Hardware and Software!!



COMPUTER WAR
from
MicroPal®

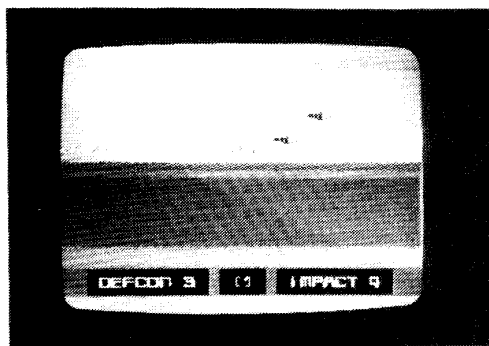

Based on the hit movie "War Games"... this exciting simulation has been a best-seller on diskette — and now it's available from MicroPal™ on cartridge! Even if you own just the TI 99/4A console, you can enjoy this new hit. Be prepared for a challenge — as John Koloen at Micropendium observed, "Computer War makes use of multiple screens and is as fast-moving as I can handle."

COMPUTER WAR. The alarm bells are ringing at NORAD! Can you crack the code and destroy the simulated enemy missiles before the world is engulfed in a thermonuclear holocaust?

42480 Sug. Retail \$29.95 **\$24.95**

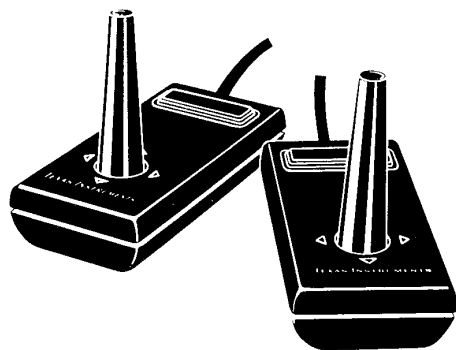

**ORIGINAL TI
DUAL JOYSTICKS**
Only **\$8.95**

At this price you should pick up a spare pair!

15499 **\$8.95**

AVAILABLE FROM
YOUR FRIENDS AT



*We gladly accept
mail orders!*

P.O. Box 6578
South Bend, IN 46660

**Questions? Call
219/259-7051**

ORDER AMOUNT	CHARGE
less than \$20.00	\$3.75
\$20.00-\$39.99	4.75
\$40.00-\$74.99	5.75
\$75.00-\$149.99	6.75
\$150.00-\$299.99	7.75
\$300 & up	8.75

Foreign Orders add \$4.00
Heavy items ship at actual cost

NO EXTRA FEE FOR CHARGES



We verify charge card addresses

**ORDER TOLL FREE
1-800-348-2778**
INDIANA 1-800-225-6838



REGENA —

(Continued from Page 16)

1 module also has a High Resolution graphic section, which is under license from APESOFT (Austria). If you enjoy graphics you'll love the possibility of programming with this module.

I don't have room to go into detail on what all is available, so I'll just give you a brief idea. When I do graphics on other computers, I like the LINE and CIRCLE commands — we have not had them with TI BASIC but have had to redefine characters then place those characters on the screen. With this Extended BASIC no you can use SETTO and MOVETO and specify certain pixels to draw lines on the screen. Here is an example to draw a circle:

```
CALL APESOFT
100 REM CIRCLE
110 CALL LINK("GRAFIC",0)
120 CALL LINK("WINDOW",1,1)
130 CALL LINK("CIRCLE",64,60,30)
140 GOTO 140
```

CALL APESOFT gets into the graphics mode. The "CIRCLE" command lets you specify an x- and y-coordinate for the center of the circle then the radius. There are also commands for "ARCUS" (circular arcs) and "ELLIPS" (ellipses).

Years ago I saw a program to draw a graph of a function on the TI. Although the idea was good the program took *forever* to draw the graph — longer than drawing it yourself on graph paper. This Mechatronic Extended BASIC will allow easy and fast graph drawing. There is even a command called "AXIS" which will draw the axis of a graph on the screen after you specify where you want the x-axis and y-axis to start, how long you want them and what the scale is.

Those who have difficulty in obtaining Extended BASIC II Plus from local dealers or MICROpendium advertisers may write Cynthia Becker, P.O. Box 275, Brighton, MA 02135, for information.

Central States

```
100 REM CENTRAL STATES
110 DIM S$(12),C$(12)
120 CALL CLEAR
130 FOR G=9 TO 12
140 CALL COLOR(G,12,1)
150 NEXT G
160 CALL COLOR(13,1,12)
170 CALL COLOR(14,1,12)
180 CALL COLOR(15,2,11)
190 CALL CHAR(64,"3C4299A1A199423C")
200 PRINT " *****": " *"
;TAB(25); "*"
210 PRINT " * IDENTIFY THE STATES *": " *"
;TAB(25); "*"
220 PRINT " *****"
230 PRINT : : :TAB(7);"CENTRAL STATES"
240 PRINT : : : : "@1987 BY REGENA"
250 FOR G=96 TO 123
260 READ G$
270 CALL CHAR(G,G$)
280 NEXT G
290 DATA FFFFFFFFFFFFFFFF,3F1F0F0707030301,
```

```
7F3F1F0F,FFFF7F7F3F3F3F3F,FFFFFF3C,F0F0F0E0E0
0C0C0B,0F0F0F0F0F0F0F0F
300 DATA 0F0F070703030101,0101030307070F0F,
0F0F0FOFFFFFFFFF,FFFFFFFF7F1F0701,FF3F0F03,
FFFFFFFFF0F0F
310 DATA F8FCFEFE7F3F1F0E,FFFFFFFFFEFC8F8F,
0F8F8FCFCFEFEFF,00B0B0C0C0E0E0F,F0E0C0B,FCF
CF8F8F0F0F0F
320 DATA B0B0C0C0E0E0F0F,0F1F3F7FFFFFFFFF,0
000000030F3FFF,000000000010307,E0E0E0F0F8
FCFEFF,0000000000B0C0E
330 DATA 00E0F0FEFFFFFFFF,0000000000E0F8FE,
E0E0E1E3FFFFFFFFEFC
340 L$="*****"
350 RESTORE 390
360 FOR G=0 TO 12
370 READ S$(G),C$(G)
380 NEXT G
390 DATA NORTH DAKOTA,BISMARCK,SOUTH DAKOTA
,PIERRE,NEBRASKA,LINCOLN,KANSAS,TOPEKA,INDI
ANA,INDIANAPOLIS
400 DATA MINNESOTA,ST. PAUL,IOWA,DES MOINES
,MISSOURI,JEFFERSON CITY,WISCONSIN,MADISON,
ILLINOIS,SPRINGFIELD
410 DATA MICHIGAN,LANSING,OHIO,COLUMBUS,KEN
TUCKY,FRANKFORT
420 CALL CLEAR
430 PRINT "ONE OF THE UNITED STATES": : "WIL
L BE OUTLINED.": : : "TYPE THE NAME OF THE S
TATE"
440 PRINT : "THEN PRESS <ENTER>." : : : "IF TH
E STATE IS CORRECT,"
450 PRINT : "TYPE THE CAPITAL CITY": : "THEN
PRESS <ENTER>."
460 PRINT : : : "NAMES MUST BE SPELLED": : "C
ORRECTLY TO BE ACCEPTED.": : :TAB(15);"PRES
S <ENTER>";
470 CALL KEY(O,K,S)
480 IF K<>13 THEN 470
490 CALL CLEAR
500 PRINT TAB(27);"ts": " i*****yz
u'e": " ";L$;"yx t'r": "h";L$;"w vt"
'z"
510 PRINT "f";L$;"t'nq": "f";L$;"t's"
:"f";L$;"x": "f";L$;"e": "g";L$;"
*****"
520 PRINT " c";L$;"n": " g";L$;"nq": "
j";L$;"e": " k;1*****":TAB
(10);"a*****ndj'p"
530 PRINT TAB(11);"bdc'ndddm co":TAB(13);
"a' a'":TAB(14);"b";TAB(24);"b": : :
: : :
540 FOR C=0 TO 12
550 T=0
560 RANDOMIZE
570 R=INT(13*RND)
580 IF S$(R)="" THEN 570
590 ON R+1 GOSUB 1540,1600,1660,1730,1800,1
860,1930,1990,2060,2130,2210,2280,2340
600 CALL HCHAR(20,1,96,160)
610 READ N
620 FOR A=128 TO 127+N
630 READ G$
640 CALL CHAR(A,G$)
650 NEXT A
660 READ N
670 FOR A=1 TO N
```

(See Page 20)

**9900 + FOR THE TI99/4A
THE ULTIMATE
99/4A EXPANSION SYSTEM
AT A SPECIAL
INTRODUCTORY PRICE
FROM TEX-COMP™**

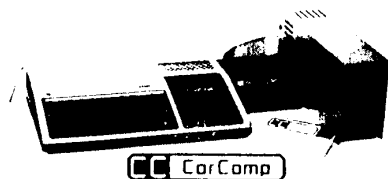

**COMPLETE
EXPANSION SYSTEM
NOTHING ELSE TO BUY!**

TEX-COMP, the undisputed leader in supplying the 99/4A User, has now put together the finest and most complete expansion system ever offered for the TI99/4A.

- **9900 Expansion Box & Regulated Power Supply (UL Approved)**
- **32K Memory Upgrade** Adds 32K bytes of Random Access Memory to your system.
- **Double Sided/Double Density Disk Controller** (operates up to 4 drives)
- **RS232 Interface** Lets you add a wide range of other accessories, such as printers or telephone modems, one parallel and 2 serial outputs.
- **1 SS/SD Disk Drive** Allows you to store and retrieve data on 5 1/4-inch single-or double-sided floppy diskettes.
- **1 Disk Drive Case & Regulated Power Supply**
Handles two 1/2-height drives easily (UL or LAC Approved)
- **New Disk Manager with Improved Disk Utilities**
- **All Cables & Instructions** Including a free TI RS232 Y-Cable.

**ALL FOR
\$379.95**

Plus S&H

For above system with full size DS/DD Disk Drive

\$399.95

For above system with a pair of 1/2-height Drives

539.95

Other leading CorComp Hardware Values:

CorComp RS232 Card (for TI P-Box)	79.95
CorComp 32K Card (for TI P-Box)	99.95
CorComp 256K P-Box Card	169.95
CorComp 512K P-Box Card	229.95
CorComp 256K Stand Alone	249.95
CorComp 512K Stand Alone	269.95
CorComp DS/DD Controller (for TI P-Box)	149.95
CorComp 9900 System with Free RS232 Y-Cable	299.95
CorComp Stand Alone RS232 with Free Y-Cable	109.95
NEW CorComp Stand Alone 32K	89.95
NEW Triple Tech P-Box Card (Clock/Buffer)	109.95
NEW 9900 Clock Stand Alone	69.95
"Grom Buster" (for 1983 Consoles)	24.95
Load Interrupt Switch (with FREE Screen Dump Program)	19.95
NEW PDI Diagnostic Module	24.95

Also available from TEX-COMP

TI-99/4A Console w/1-year warranty (Black & Silver model)	79.95
NEW Star NX-10 (Fully TI Compatible). Replaces SG-10 solid state dipswitch selection—Free Cleaning Kit	New Lower Price 239.95
1/2-Height DS/DD Disk Drive (2 will fit in P-Box)	99.95
Full Size SS/SD Disk Drive (exact replacement for TI 1250)	79.95
Full Size DS/DD Disk Drive	99.95
Drive Enclosure with Regulated Power Supply for 2 1/2-height or 1 full Drive	59.95
Cable Kit for 2 1/2-height Drives (for installation in P-Box)	29.95
Cable Kit for Stand-Alone Drives (specify TI or CorComp system)	29.95
RS2323 Y-Cable	10.95

SEND \$2.00 FOR NEW 1986 CATALOG WHICH INCLUDES A \$5.00 SAVINGS CERTIFICATE.



VISA and MASTERCARD
HOLDERS CALL DIRECT
(818) 366-6631

SEND ORDER AND MAKE CHECKS PAYABLE TO

TEX-COMP™

Texas Instruments



AUTHORIZED DEALER

P O BOX 33084 — GRANADA HILLS CA 91344

add 3% for credit card orders

TERMS: All prices F.O.B. Los Angeles. For fastest service use cashiers check or money order. Add 3% shipping and handling (\$3.00 minimum). East of Mississippi 4 1/2% (Free shipping on all software orders over \$100.00). Prices and availability subject to change without notice. We reserve the right to limit quantities.

NOTE: Payment in full must accompany all orders. Credit Card, Company Check or Money Order for immediate shipment. Personal checks require up to 4 weeks to clear. California orders add 6 1/2% sales tax.
"The Leader of the Pack"

CENTRAL STATES—

(Continued from Page 18)

```

680 READ X,Y,G
690 CALL HCHAR(X,Y,G)
700 NEXT A
710 FOR A=1 TO 7
720 CALL HCHAR(21,2+A,ASC(SEG$("STATE ?",A,
1)))
730 NEXT A
740 CALL HCHAR(21,11,96,15)
750 S1$=""
760 CALL SOUND(150,1397,2)
770 FOR J=1 TO 15
780 CALL KEY(0,K,S)
790 IF S<1 THEN 780
800 IF K=6 THEN 740
810 IF K=13 THEN 850
820 CALL HCHAR(21,10+J,K)
830 S1$=S1$&CHR$(K)
840 NEXT J
850 CALL SOUND(100,880,2)
860 IF S$(R)=S1$ THEN 980
870 CALL SOUND(100,330,2)
880 CALL SOUND(100,262,2)
890 T=T+1
900 IF T<2 THEN 740
910 CALL HCHAR(21,11,96,15)
920 FOR J=1 TO LEN(S$(R))
930 CALL HCHAR(21,10+J,ASC(SEG$(S$(R),J,1)
))
940 NEXT J
    
```

```

950 GOSUB 1420
960 C=C-1
970 GOTO 1290
980 GOSUB 1490
990 FOR A=1 TO 9
1000 CALL HCHAR(23,2+A,ASC(SEG$("CAPITAL ?",
A,1)))
1010 NEXT A
1020 T=0
1030 CALL HCHAR(23,13,96,15)
1040 S1$=""
1050 CALL SOUND(150,1397,2)
1060 FOR J=1 TO 15
1070 CALL KEY(0,K,S)
1080 IF S<1 THEN 1070
1090 IF K=6 THEN 1030
1100 IF K=13 THEN 1140
1110 CALL HCHAR(23,12+J,K)
1120 S1$=S1$&CHR$(K)
1130 NEXT J
1140 CALL SOUND(100,890,2)
1150 IF C$(R)=S1$ THEN 1270
1160 CALL SOUND(100,330,2)
1170 CALL SOUND(100,262,2)
1180 T=T+1
1190 IF T<2 THEN 1030
1200 CALL HCHAR(23,12,96,15)
1210 FOR J=1 TO LEN(C$(R))
1220 CALL HCHAR(23,12+J,ASC(SEG$(C$(R),J,1)
))
    
```

```

1230 NEXT J
1240 GOSUB 1420
1250 C=C-1
1260 GOTO 1290
1270 GOSUB 1490
1280 S$(R)=""
1290 READ N
1300 FOR A=1 TO N
1310 READ X,Y,G,J
1320 CALL HCHAR(X,Y,G,J)
1330 NEXT A
1340 NEXT C
1350 CALL HCHAR(21,1,96,96)
1360 PRINT "TRY AGAIN?(Y/N)";
1370 CALL KEY(0,K,S)
1380 IF K=89 THEN 350
1390 IF K<>78 THEN 1370
1400 CALL CLEAR
1410 STOP
1420 FOR A=1 TO 11
1430 CALL HCHAR(24,20+A,ASC(SEG$("PRESS ENT
ER",A,1)))
1440 NEXT A
1450 CALL KEY(0,K,S)
1460 IF K<>13 THEN 1450
1470 CALL HCHAR(24,21,96,11)
1480 RETURN
1490 CALL SOUND(100,262,2)
1500 CALL SOUND(100,330,2)
1510 CALL SOUND(100,392,2)
1520 CALL SOUND(200,523,2)
1530 RETURN
1540 RESTORE 1560
1550 REM NORTH DAKOTA
1560 DATA 6,1010101010101,101010080804040
4,0202FE,000000FF,0000FF,10101F,9,3,17,12B,
4,17,129
    
```

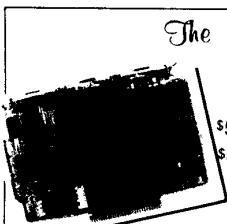

The HORIZON RAMDISK

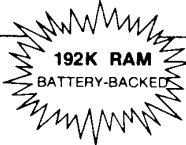

\$53* PC Board, Manuals & Software
 \$45* Five or more boards with one manual and set of disks.

* PARTS AVAILABLE ELSEWHERE FOR ABOUT \$100/720 Sector
 * OHIO RESIDENTS ADD 5% SALES TAX

CONSTRUCTED - 90 DAY WARRANTY

192K - 720 Sector	\$210
104K - 360 Sector	\$165

EASY TO USE...

- > Functions just like a TI floppy drive only FASTER! Load the operating system with a single key press, then access the RAMDISK as you would a floppy disk.
- > Compatible with software using standard DSR/LNK including sector copy, Disk Manager II, MG Explorer, TI Writer, TI Multiplan, and Editor Assembler. Compatible with TI BASIC, TI Extended BASIC, TI and Wycove FORTH, TI LOGO, and Assembly Language.
- > Comes with the DM-1000 Disk Manager. Loads from BASIC of Ext BASIC in 1 second with CALL DM.
- > Compatible with existing hardware including MAXI MEM - GramKracker, and the RAM/GRAM Card.
- > Accepts drive names from DSK1 to DSK6
- > DIP switch sets CRU Base from >1000 to >1700.
- > Adds CALL Subprograms to BASIC to 1) set the drive number, 2) set write protect, 3) set maximum sectors, 4) enable DSR for direct access, 5) execute MRL code from BASIC, DELETE "BCALL" downloads CALLs to low 8K for execution from running Ext BASIC programs.
- > Comes with complete DSR SOURCE CODE. Explains how to write ALL CALL routines to enhance TI BASIC.

HORIZON COMPUTER LIMITED
 P.O. Box 554
 Walbridge, Ohio 43465

NOT JUST ANOTHER RAMDISK...
 THE ONLY BATTERY-BACKED RAMDISK for the TI-99/4A. The on-card batteries recharge when you operate your computer. The batteries will last for years and the entire 192K RAM memory is battery-backed including the DSR RAMDISK Operating System.

THE ONLY FULLY OPEN PE-BOX CARD. The Horizon RAMDISK contains no EPROM or ROM. The DSR Operating System is in RAM and is loaded from a floppy disk. DOCUMENTED SOURCE CODE is provided for those who wish to understand AND MODIFY the Operating System.

THE ONLY PERIPHERAL WITH DSR RAM which allows the assembler language programmer to write Device Service Routines. The Horizon RAMDISK memory is decoded entirely within address space >4000 to >5FFF. A special loader (provided with SOURCE CODE) enables AORG Editor/Assembler object files to be placed in the RAM on the card. You can write all new CALL subprograms for TI BASIC, power-up and interrupt service, and DSR routines making use of the 192K battery-backed RAM. >4000 to >5FFF is always enabled, and the remaining 196K is paged in 2K at a time in >5800 to >5FFF with the LDCR instruction.

THE ONLY RAM CARD YOU CAN BUILD your self at substantial savings over fully constructed models. You can buy the printed circuit board, user's manual, Operating System software, and an ILLUSTRATED step-by-step construction manual with schematic and parts list and get the parts wherever you can find the best deals. Hundreds of TI Enthusiasts have built the Horizon RAMDISK. If you've had any experience building electronic kits you can too - at SIGNIFICANT SAVINGS! (If you want a fully constructed, tested and warranted unit, we sell those too.)

(See Page 22)

TECHNI-GRAPHS Brings Hi-Tech to your TI 99/4A with Programmable Control Keys V2.0.

A WELCOME ADDITION TO YOUR EXISTING EXTENDED BASIC PROGRAMS.

YOUR EXTENDED BA	
DATA FILENAME: DS	-123456789.1
FIRST NAME: JOHN	7 8 9 / C
LAST NAME: DOE	4 5 6 * E
ADDRESS: 1987 ST	1 2 3 - S
CITY, STATE: ANY	0 A Z + N
ITEM PURCHASED: BDAT	
PRICE * 6.337: ■	

CALCULATOR:

11 digit display
add, subtract, multiply
divide, even computes
square roots! Has memory
and recall keys. Uses
WINDOWING feature.

YOUR EXTENDED BASIC PROGRAM			
DATA FILENAME: DSK1. ■			
FIRST NAME:			
LAST NAME:			
YOUR DISK	00714 = RV 0726 = USED		
FILENAME	TYPE	SIZE	Y
PROGRAM	GR	VARR	Y
PRINT	VAR	11	Y
KEYS	PR	2	Y

CATALOG:

Catalog drive to screen
or printer if desired.
Shows filenames, sizes,
file types, write protect
status. Uses WINDOWING
feature.

NOTE PAD		IC PROGRAM	
1. EDIT	2. CHECK	3. KEY	4. XG
5. PRINT	6. SAVE	7. DRY	8. XG
9. ALL	0. END		
GET PAPER		TE ST.	
		DUN.IL	
ITEM PURCHASED: BDAT			
PRICE * 6.337: \$900.99			

NOTEPAD:

Jot down notes, reminders,
etc. Print to printer if
desired. Uses WINDOWING
feature.

PLUS:

- 9 PROGRAMMABLE Control Keys - Save your commonly typed commands to CTRL keys 1-9. Then retrieve the command (up to 2 screen lines) with a single key press. Commands can be saved to disk.
- SINGLE or DOUBLE sized Graphics Screen Dumps
- Ability to change Screen and Text COLORS in the command mode.
- 100% assembly language - Uses no Extended Basic program space. Runs in the background of your Extended Basic program. Remains invisible until the correct key is pressed.

SEND CHECK OR MONEY ORDER FOR \$23.99 + \$1.50 SHIPPING & HANDLING TO:

TECHNI-GRAPHS 1058 PERDA LN. DES PLAINES, IL 60016

REQUIRES: TI 99/4A, TI EXTENDED BASIC, 32K MEMORY EXPANSION, DISK DRIVE, 8 BIT 8 DOT ADDRESSABLE PRINTER

CENTRAL STATES—

(Continued from Page 20)

1570 DATA 5,17,130,5,16,131,5,15,131,5,14,1
32,5,13,133,4,13,128,3,13,128,4,3,17,96,1,3
,13,96,1
1580 DATA 4,13,96,5,5,13,96,5
1590 RETURN
1600 RESTORE 1620
1610 REM SOUTH DAKOTA
1620 DATA 8,00001F101010101,0000FF,000000FF
,0000FC04040404,02020202020202,020204E4
1C,10101F,101010101010101
1630 DATA 12,5,13,128,5,14,129,5,15,130,5,1
6,130,5,17,131,6,17,132,7,17,133,7,16,129,7
,15,129
1640 DATA 7,14,129,7,13,134,6,13,135,3,5,13
,96,5,6,13,96,5,7,13,96,5
1650 RETURN
1660 RESTORE 1680
1670 REM NEBRASKA
1680 DATA 9,00001F101010101,0000FF,000000E0
1C040201,80B040402020201,100B0402FE,0000000
OFF,101010101F
1690 DATA 00000000000000F,101010101010101F,
13,7,13,128,7,14,129,7,15,129,7,16,129,7,17
,130
1700 DATA 8,18,131,9,18,132,9,17,133,9,16,1
33,9,15,133,9,14,134,8,14,135,8,13,136
1710 DATA 3,7,13,96,5,8,13,96,6,9,14,96,5
1720 RETURN
1730 RESTORE 1750
1740 REM KANSAS
1750 DATA 7,0000000007040404,00000000FF,000
0000FE020101,804020202020202,20202020E,040
4040407,0404040404040404
1760 DATA 13,9,14,128,9,15,129,9,16,129,9,1
7,129,9,18,130,10,19,131,11,19,132,11,18,12
9,11,17,129
1770 DATA 11,16,129,11,15,129,11,14,133,10,
14,134
1780 DATA 3,9,14,96,5,10,14,96,6,11,14,96,6
1790 RETURN
1800 RESTORE 1820
1810 REM INDIANA
1820 DATA 5,FF4020202020202,E02020202020202
,202020202020C,427C,2020202020204041
1830 DATA 5,8,22,128,8,23,129,9,23,130,10,2
2,131,9,22,132
1840 DATA 3,8,22,96,2,9,22,96,2,10,22,96,1
1850 RETURN
1860 RESTORE 1880
1870 REM MINNESOTA
1880 DATA 9,80B0B0B0B0B0B0B,80B0B0404020202
,202020202020202,202020201010101F,000000000
00000FF
1890 DATA 10100B0B0B0202FC,80B0B0402020201,
10204040B0B0B0B,FF3F0F0003040B1
1900 DATA 9,3,17,128,4,17,129,5,17,130,6,17
,131,6,18,132,6,19,133,5,19,134,4,19,135,3,
19,136
1910 DATA 5,3,17,96,1,4,17,96,3,5,17,96,3,6
,17,96,3,3,19,121,1
1920 RETURN
1930 RESTORE 1950
1940 REM IOWA
1950 DATA 7,1F1010202020100B,04040202010101
01,00000000000000FF,10102040B0B0B0B,0000B04
02020101

1960 DATA FE01,FF,8,7,17,128,8,17,129,8,18,
130,8,19,130,8,20,131,7,20,132,7,19,133,7,1
8,134
1970 DATA 2,7,17,96,4,8,17,96,4
1980 RETURN
1990 RESTORE 2010
2000 REM MISSOURI
2010 DATA 9,1F0B04020201,FF0000000000B04,40
2020202020202,202020202020203F,000000000000
00FF
2020 DATA 02010101010101F9,09111F,804020100
8040202,FF01020202010101
2030 DATA 9,9,17,128,9,18,129,10,18,130,11,
18,131,11,19,132,11,20,133,12,20,134,10,20,
135
2040 DATA 9,19,136,4,9,17,96,3,10,18,96,3,1
1,18,96,3,12,20,96,1
2050 RETURN
2060 RESTORE 2080
2070 REM WISCONSIN
2080 DATA 7,000000007C83B0B,000000007BBF010
1,F01020202020404,40404040404040C
2090 DATA 00000000000000FF,10100B0B04040201
,80B0B0402020201
2100 DATA 7,4,20,128,4,21,129,5,22,130,6,22
,131,6,21,132,6,20,133,5,20,134
2110 DATA 3,4,20,96,2,5,20,96,3,6,20,96,3
2120 RETURN
2130 RESTORE 2150
2140 REM ILLINOIS
2150 DATA 11,000000003F20101,00000000FF0101
01,804020202020202,202020202020404,40404080
8,0000000000010608
2160 DATA 1060B,020101,804020100B040202,010
1020202010101,10102040B0B0B0B
2170 DATA 11,7,20,128,7,21,129,8,22,130,9,2
2,131,10,22,132,10,21,133,11,21,134,11,20,1
35
2180 DATA 10,20,136,9,19,137,8,20,138
2190 DATA 5,7,20,96,2,8,20,96,3,9,19,96,4,1
0,20,96,3,11,20,96,2
2200 RETURN
2210 RESTORE 2230
2220 REM MICHIGAN
2230 DATA 8,FF3F0F0003040B1,1020407C03,0000
0B7EB1,00000070BF010101,F01010202020404,404
040404040404
2240 DATA 407F,00FF
2250 DATA 8,3,19,128,4,19,129,4,20,130,4,21
,131,5,22,132,6,22,133,7,22,134,7,23,135
2260 DATA 5,3,19,121,1,4,19,96,3,5,22,96,1,
6,22,96,1,7,22,96,2
2270 RETURN
2280 RESTORE 2300
2290 REM OHIO
2300 DATA 6,F0E0EA02020202,202020202020202
,2040B0B,000000000102E418,0B0B0B0B0B0F,0F0B
0B0B0B0B0B0B
2310 DATA 6,6,25,128,7,25,129,8,25,130,8,24
,131,8,23,132,7,23,133
2320 DATA 4,7,23,96,1,8,23,96,3,7,25,96,1,6
,25,116,1
2330 RETURN
2340 RESTORE 2360
2350 REM KENTUCKY
2360 DATA 8,0001020C3040B0B,F30C,0000000304

(See Page 24)

AT LAST—A COMPLETE PRINT SHOP PACKAGE FOR THE TI-99/4A

**THE PRINTSHOPPE 99™ Desktop Publishing System
Now with GRAPHX II - Quick Load + Flip & Rotate**

Now create your own newsletters, advertisements,
signs and greeting cards with this new package.

INCREDIBLE NEW FONTS

TINY LARGE WEIRD *SLANTED*

FOR ALL OCCASIONS

CLIPART AND PICTURES TOO!!

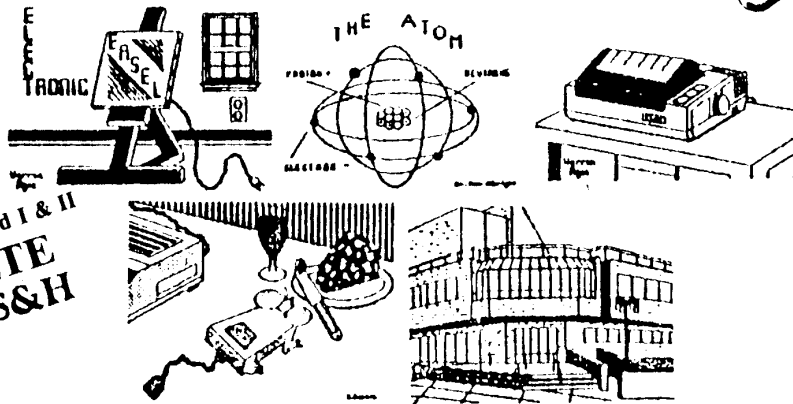

GRAPHX & Asgard I & II
COMPLETE
\$47.95 + S&H

PACKAGE INCLUDES 2 GRAPHX + 2 COMPANION DISKS

Tex-Comp has gone all the way to Australia to directly import the latest extended basic version of GraphX and has combined it in a user-friendly package with 2 outstanding companion disks from Asgard, which are filled with 24 sets of fancy typestyles (fonts) and a huge collection of clip art pictures which can be printed out to make labels, illustrations, letterheads, etc. The companion disks contain a total of 14 clip art files with each file containing an assortment of different pictures.

By using GraphX together with these 2 companion disks, you'll have the ability, not only to create your own graphics, but also an outstanding collection of ready-to-use illustrations & typestyles. Requires 32K, disk drive, joystick and Epson or Star compatible printer.

*ADD \$7.95 for the newly released Companion Disks III by Asgard
MANY MORE TYPE FONTS, CLIP ART AND SPECIAL FEATURES!!!*

Send order and make checks payable to:

TEX+COMP

P.O. BOX 33064—GRANADA HILLS, CA 91344



AUTHORIZED DEALER



VISA and MASTERCARD
HOLDERS CALL DIRECT
(818) 366-6631
24 Hour Order Line

TERMS: All prices F.O.B. Los Angeles. For fastest service use cashiers check or money order. Add 3% shipping and handling (\$3.00 Minimum). East of Mississippi 4 1/2%. Add 3% for Credit Card orders. Prices and availability subject to change without notice. We reserve the right to limit quantities.

NOTE: Payment in full must accompany all orders. Credit card. Company check or Money order for immediate shipment. Personal Checks require up to 4 weeks to clear. California orders add 6 1/2% sales tax.

©1986 TEX-COMP

SEND \$2.00 FOR

CATALOG WHICH INCLUDES A \$5.00 SAVINGS CERTIFICATE

Getting more from XBII

Screen dump utility fills gap

By J. PETER HODDIE

Unlike Mechatronics Extended BASIC II+, Myarc's Extended BASIC II does not include a screen dump routine for printing full screen graphics. The assembly routine in Listing 1 provides a screen dump for use in Myarc's XBII. It will work with Epson and compatible printers. It prints in single density (although it would be fairly easy to make it print in double density), but it is fast. To use the routine, all you have to do is enter CALL LINK("DUMP") when there is a bit map graphics screen present and you're done.

The routine is set up for a PIO printer. If you use an RS232 printer you will have to make a simple change in the source file to the line where it says:

```
TEXT 'PIO.CR.LF'
```

as explained in the source listing. Do not try to make this routine dump the file to disk as the subroutine does not close the printer file, which causes no problems with printers, but would be a mess with a disk drive.

To use these routines, first type in the code given in Listing 1 and save it to disk with the filename DSK1.XDUMP/S. Next enter the Assembler and give a source file name of DSK1.XDUMP/S, object file name of DSK1.XDUMP, hit ENTER for the list file, and enter RC for options. When the Assembler is done you can then start up XBII and do a CALL IN-IT, followed by a CALL LOAD("DSK1.XDUMP") to bring the routines into memory.

Since the discussion of the assembly
(See Page 25)

XBII screen dump

```

DEF DUMP
REF VSBW,VMBR,VMBW
REF DSRLNK
FAC EQU >834A
BSS 2 WE NEED A BYTE HERE FOR PRINTING. . .
BUF1 BSS 256 BUFFER
OUT BSS 8 SMALL BUF FOR CONVERSION
WS BSS 32 MY WORKSPACE
FAB EQU >38B0 PUT FAB IN ONLY FREE SPACE IN VDP
FABBUF EQU FAB+30 AND BUFFER FOR FAB 30 BYTES LATER
PABDAT DATA >0012,PABBUF,>4000,0 THIS IS THE FAB
BYTE 0
TEXT 'PIO.LF.CR' THIS IS THE LENGTH OF YOUR PRINTER NAME
SPACIN BYTE 3,27,'A',8 PUT YOUR PRINTER NAME HERE, UPDATE THE LINE ABOVE.
GRF BYTE 4,27,'K',0,1 THIS SETS THE PRINTER TO 8/72" LINE SPACING
* BYTES OF GRAPHIC DATA
CRLF BYTE 2,13,10 A CARRIAGE RETURN/LINE FEED COMBINATION
H40 BYTE 64 CONSTANT
EVEN
DUMP
LWPI WS LOAD MY WORKSPACE
CLR R13 INITIALIZE CURRENT SCREEN OFFSET
LI R0,PAB ADDRESS FOR PAB
LI R1,PABDAT PAB TEMPLATE
LI R2,32 ABOUT 32 BYTES LONG
BLWP @VMBW COPY PAB TO VDP
LI R14,FAB+9 PREPARE A POINTER TO PAB
MOV R14,@>8356 AND PUT IT IN PLACE FOR DSR
BLWP @DSRLNK OPEN FILE
DATA 8
* R0 IS STILL PAB
LI R1,>0300 SET PAB TO OUTPUT
BLWP @VSBW UPDATE IT.
BL @FRINT INITIALIZE PRINTER FOR CORRECT LINE SPACING
DATA SPACIN
*****
* BEGIN THE MAIN LOOP
LOOP
MOV R13,R0
LI R1,BUF1
LI R2,256
BLWP @VMBR READ THE BYTES
AI R13,8*32 INCREMENT COUNTER
*****
* CONVERT IT TO PRINTER FORMAT
LI R5,BUF1 ADDRESS OF MAIN BUFFER
LI R6,OUT ADDRESS OF CONVERSION BUFFER
DUMP4
MOV R6,R3 COPY OF ADDRESS OF CONVERSION BUFFER
(See Page 25)

```

CENTRAL STATES—

(Continued from Page 22)

```

1860B,000000C03C03,000000000000B06,18040201
020C30C,FF,407F
2370 DATA 10,10,20,128,10,21,129,9,22,130,9
,23,131,9,24,132,10,24,133

```

```

2380 DATA 11,23,134,11,22,134,11,21,134,11,
20,135
2390 DATA 3,9,22,96,3,10,20,96,5,11,20,96,4
2400 RETURN
2410 END

```

DUMP—**Continued from Page 24**

routine this month is so short, I would like to discuss, briefly some of the advantages in writing assembly code for Myarc XBII, instead of TI Extended BASIC. The most obvious feature, from looking at the listing, is that there is no longer a long list of EQUates for common routines such as VSBW, VWTR, STRASG, NUMREF, and XMLLNK. All of these routines are now accessed with a REF, as when programming for Editor/Assembler (although the old EQUates still work).

Furthermore, routines missing from TI's Extended BASIC, such as DSRLNK and GPLLNK, are always present in Myarc's XBII. The CALL LOAD loader is much faster than TI's and can also load compressed object code. With Myarc's XB II, not only do you get more room for your BASIC program but, if you do a CALL LOAD as documented by Myarc, you get over 1K of extra space for assembly code.

Another great feature is that Myarc has documented how the VDP memory is used in each mode, so that finding room for a Peripheral Access Block for your assembly routine, which was at best hazardous in Extended BASIC, is a safe and simple job with XBII.

Next month I will present a series of short assembly routines to allow rapid manipulation of the bit map image and colors.

Readers who do not want to type in the code accompanying this article, or don't have access to an assembler, may obtain the source and object code via modem by calling BCS T199 BBS No. 2 at (617) 335-8475. Or, send \$3 for a diskette with the code to Boston Computer Society, T199 User Group, One Center Plaza, Boston, MA 02108.

24-hour BBS in Miami

The Miami Users Group in North Miami Beach, Florida, now has a BBS up and running 24 hours a day, seven days a week, according to Burt Schreiber, secretary of the group.

The software for the board is Techie. The board has 15 megabytes of hard drive. Phone number is (305) 255-6307.

Continued from Page 24

```

MOV R6,R0          CLEAR IT OUT.
CLR #R0+
CLR #R0+
CLR #R0+
CLR #R0
LI R9,>0080        HIGH BIT OF LOW NYBBLE IS SET

DUMP2 MOV R5,R1     GET ADDRESS OF MAIN BUFFER
LI R8,>8000        BIT FOR OUTPUT.
DUMPO MOVB #R1+,R2  GET A BYTE
SRL R2,8          MAKE IT A WORD
MOV R9,@ANDI     PREPARE FOR TESTING
ANDI R2,0        IS THE BIT SET?
ANDI EQU #-2
JEQ DUMP5        NOPE. SET NO BIT.
AB R8,#R3        PUT IN OUTPUT WORD

DUMP5 SRL R8,1      SHIFT BIT TO DO NEXT COMPARE
CI R8,>0080      ARE WE DONE?
JNE DUMPO        NOPE
INC R3           INCREMENT POSITION IN TEMPORARY BUFFER
SRL R9,1        SHIFT BIT AND ARE WE DONE?
JNE DUMP2        NOPE.

MOV R6,R3        GET ADDRESS OF "OUTPUT BUFFER"
LI R1,8          8 BYTES TO MOVE
DUMP3 MOVB #R3+,#R5+ MOVE A BYTE
DEC R1           DOWN COUNTER
JNE DUMP3        NOT DONE.

CI R5,RUF1+256   DONE WITH WHOLE BUFFER?
JL DUMP4        NOPE.

*****

BL @PRINT        SET PRINTER UP FOR 256 BYTES OF GRAPHIC DATA
DATA GRF

LI R8,RUF1-1     OFFSET INTO BUFFER
LI R9,4          4 PASSES WILL BE NECESSARY

* BEGIN PRINTING LOOP

LOOP1 MOVB @H40,#R8 INDICATE LENGTH OF STRING (64 CHARS)
MOV R8,@DATA    TELL "PRINT" WHERE STRING IS.

DATA BL @PRINT    SEND GRAPHIC DATA TO PRINTER
DATA DATA 0

AI R8,64        INCREMENT TO NEXT POSITION IN BUFFER
DEC R9         DOWN COUNTER
JNE LOOP1      NOT DONE.

BL @PRINT      PRINT A CARRIGE RETURN/LINE FEED
DATA CRLF

CI R13,>1800    DONE WITH WHOLE SCREEN?
JL LOOP        NOPE.

LWPI >83E0     RETURN TO BASIC
B @>006A

*****

PRINT MOV #R11+,R4   GET STRING POINTER
LI R0,PAB+5    ADDRESS OF LENGTH BYTE IN PAB
MOVB #R4+,R1  GET LENGTH BYTE FROM STRING
BLWF @VSBW    TELL PAB HOW LONG THIS STRING IS
SRI R1,8      MAKE LENGTH A WORD
MOV R1,R3     MAKE A COPY OF IT

PRINTO LI R0,PABBUF  ADDRESS OF PAB DATA BUFFER
MOVB #R4+,R1  GET A BYTE FROM OUTPUT STRING
BLWF @VSBW    PUT IN PAB
INC R0        NEXT ADDRESS
DEC R3       DOWN COUNTER.
JNE PRINTO   NOT DONE.

MOV R14,@>8356 TELL DSR WHERE PAB IS
BLWF @DSRLNK WRITE RECORD TO PRINTER
DATA B

RT          RETURN TO CALLING ROUTINE

END

```

—Part II of a series—

Logo tiles and sprites

By SUZANNE L. JOHNSTON

In last month's article we saw how Logo Turtle Graphics is a fun and challenging way to simulate animation, but allows limited detail. With tiles and sprites we can create more sophisticated graphics with more exciting animation.

Tiles are used in Logo graphics to design screen backgrounds. A tile has color and shape which may both be changed, but it cannot move. There are 256 tiles available in TI Logo. The cursor uses tiles 0 and 1 which cannot be changed but the shape of all other tiles can be changed. Tiles 0 through 10 and 32 through 95 are used for standard characters: all other tiles are blank.

To define your own tile shape type MAKECHAR (MC) (number). If you choose one of the blank tiles, such as 200, you will see a blank 8x8 grid on the screen that is tile number 200. The arrow keys move the cursor within the grid. Holding down the FCTN key while pressing (arrow) will leave a black square where the cursor was. When your shape is complete, type FCTN 9 to store the shape in tile 200.

Now that a shape is defined you may want to assign color and position it on the screen. First we have to 'talk' to the tile so Logo knows what we are referring to, so type TELL TILE 200. To set foreground color, or the color of the blacked in portion, type SETCOLOR and some number between 0 and 15 or SETCOLOR :BLUE. Background color is automatically set to color 0 or CLEAR so the screen color shows through. To change both foreground and background type SETCOLOR [4 10] or SETCOLOR SENTENCE :BLUE :YELLOW.

Now we'll position a tile on the screen. Logo uses PUTTILE (PT) followed by tile number, column number and row number (PUTTILE 200 12 10). Columns and rows are shown in Fig. 1. Notice that these coordinates are different from those used to position the Logo Turtle on the screen.

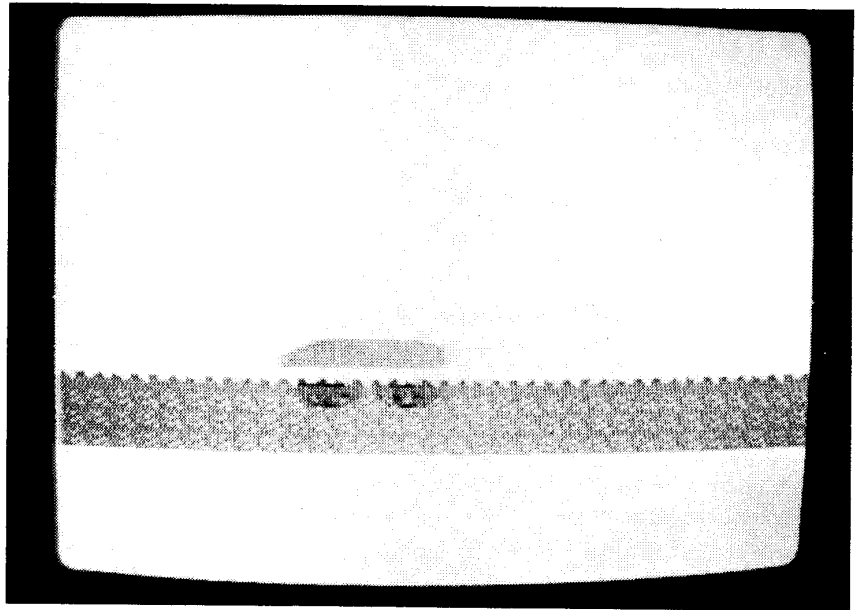

Only 32 columns and 24 rows are available for tiles.

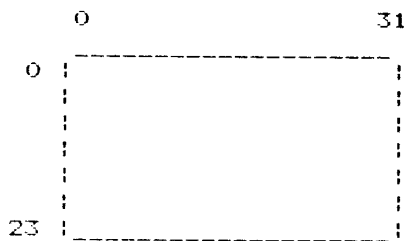

Fig. 1. Row and column coordinates for Logo tiles.

```
A tile may be placed in multiple positions on the screen. Tiles can in fact fill the entire screen without encountering "OUT OF INK" as in Turtle Graphics.
TO FILL
MAKE "COL 0
MAKE "ROW 0
TELL TILE 200
SETCOLOR [4 10]
INCREMENT
END
```

```
TO INCREMENT
PUTTILE 200 :COL :ROW
MAKE "COL :COL + 1
IF :COL = 32 THEN MAKE "ROW
```

```
:ROW + 1
IF :COL = 32 THEN MAKE "COL 0
IF :ROW = 24 THEN STOP
INCREMENT
END
```

This example uses only one tile but illustrates that the entire screen can be filled in with minute detail as long as you do not use more than 192 different tiles. Let's experiment a bit and change tile color by SETCOLOR SENTENCE :PURPLE :GREEN and see that all tiles change color simultaneously. The only other way to change tiles on the screen is to draw over them with the Turtle. Type TELL TURTLE, HIDETURTLE and then draw a bit and notice that all of the tiles change when the Turtle moves over just one tile. Now take a look at tile 200 with MC 200 and see how the shape has been changed. This could be a useful tool to do such things as change an open lake to an ice covered lake with cracks in the surface.

Let's take a look at more sophisticated animation using sprites.
(See Page 27)

LOGO—

(Continued from Page 26)

Sprites are similar to the Turtle in that they have position and heading and respond to directional commands, but they also have various shapes and colors. Color is selected by SETCOLOR just as for tiles, but only a foreground color choice may be made: the background is always clear. TI Logo has 32 sprites and sprite shapes available. Five shapes are predefined: shape 1 is a plane, 2 a truck, 3 a rocket, 4 a ball and 5 a box. Each of the 32 sprites can carry any of the 32 shapes.

To look at sprites, first we must tell Logo we want to address a sprite with TELL SPRITE 1. Each command typed after a TELL statement will address that sprite. A good starting position is the screen center and the command HOME will place it there. Now we can tell Logo what color and shape to give the sprite. SETCOLOR :BLUE and CARRY :TRUCK or CARRY 2 will place a blue truck in the screen center.

Sprites respond to many of the same commands as the Turtle, such as FORWARD or BACK and RIGHT or LEFT for relative positions and SETHEADING for absolute positions. However, unlike the Turtle, sprites do not rotate when direction is changed. Their next movement will be in the new direction but the sprite stays upright at all times.

The exciting characteristic of sprites is that they can have motion. Using SETSPEED (SS) with any number from -127 to 127 they move at different speeds either in the direction of their heading or in the opposite direction with negative numbers. Sprite speed, heading, color, shape and even size (with TI Logo II), can be changed while it is in motion, as in the following example.

```
TELL SPRITE 1
HOME
SETCOLOR :BLUE
CARRY :TRUCK
SETSPEED 20
SC :RED
CARRY :ROCKET
SH 45
```

BIG SMALL

BIG and SMALL commands are only included in TI Logo II and will make all sprites double in size and then shrink. To put additional sprites on the screen type:

```
TELL SPRITE (number)
HOME
CARRY :(PLANE or TRUCK, etc.)
SETCOLOR :(color)
SETHEADING (number)
SETSPEED (number)
```

When you get a number of sprites on the screen it can get confusing. CLEARSCREEN will erase text and tiles but not sprites. To make sprites disappear type SETCOLOR 0. Again, it will affect only the last sprite addressed in TELL. If you want to erase all the sprites or address them as a group with other commands type TELL :ALL. To address a particular group of sprites type TELL [1 2 3 4, etc.]

The coordinate system for sprites, shown in Fig. 2, is similar to that for Turtle Graphics. SXY may be used to position sprites and XCOR and YCOR will output sprite positions.

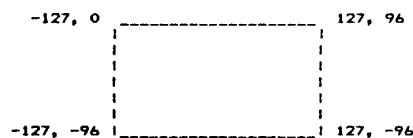

Fig. 2. Logo sprite screen coordinates.

If you would like to make your own shape or modify one of the original five use MAKESHAPE (number). MAKESHAPE 1 will display a 16 by 16 square grid with the shape of a plane. The squares are blackened just as with tiles, using FCTN (arrow) and shapes are stored by FCTN 9. FCTN 4 will clear all the grid squares. Let's assign a name to a sprite number and create a shape.

```
MAKE "PEN 6
TELL SPRITE 6
CARRY :PEN
SXY 50 0
SETCOLOR :BLACK
SETSPEED 0
```

With this set of instructions you can

watch the shape develop in actual size on the screen as you design it with MAKESHAPE. Now type MAKESHAPE 6 and design a pen, then type FCTN 9 and store it in sprite No. 6. The pen I designed is shown in Fig. 3.

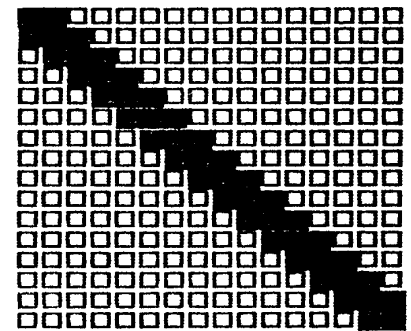

Fig. 3. MAKESHAPE 6

When talking to a group of sprites it is sometimes necessary to give each sprite a separate command. The Logo primitive YOURNUMBER (YN) outputs the sprite number currently ad-

(See Page 28)

Myarc's new

GENEVE

9640

The 640k TI-99/4a compatible!

NOW SHIPPING!

With standard PC-type keyboard	With enhanced PC-type keyboard
\$499.⁰⁰	\$529.⁰⁰

GENEVE is ready to be installed into your P-box and use your existing monitor. Each model comes with a twelve month warranty and hard cover manual. Order from us and receive **50% PAINT OFF** with your purchase! Please add 2% shipping. Michigan residents add 4% sales tax.

Great Lakes Software
804 E. Grand River Ave.
Howell, MI 48843
Order/Info line 517-546-0566

LOGO—

(Continued from Page 27)

dressed in TELL and can be used in conjunction with EACH to address each sprite in a group separately.

```

TO USEEACH
TELL :ALL
SETCOLOR 0
BIG
TELL [0 1 2]
CARRY :BALL
SXY -70 -50
EACH [SETCOLOR YOUR-
NUMBER + 1]
SETSPEED 20
SETHEADING 30
WAIT 80
TURN
END
    
```

```

TO TURN
EACH [RIGHT YOURNUMBER +
4]
WAIT 2
TURN
END
    
```

Each ball is first set to a different color corresponding to its number plus one. Then, in TURN, the path of each ball is given a different radius by adding four to its number.

Now that we have explored tiles and sprites individually let's put them together. Sprites are generally used for games or movies so we will do one example of each. First we will design an interactive game that lays down a random pattern of tiles. Then a sprite is set into motion with its direction controlled from the keyboard. The object of the game is to erase the tiles by directing the sprite over each tile and replacing it with the 'space' tile. The hierarchy of the program is as follows:

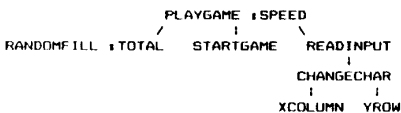

Notice that PLAYGAME has a variable called SPEED. This will control how fast the sprite moves across the screen. We will use sprite 6 that has already been defined as PEN. First in PLAYGAME we make sure the sprite will appear normal size with SMALL. Then set all sprite colors to clear in case

any sprites are already on the screen and clear the screen. Next we call RANDOMFILL to put a tile in the shape of 'X' on the screen 200 times. Tiles are placed in random column and row coordinates by multiplying the Logo primitive RANDOM by itself for each coordinate.

With the screen set up the program moves to STARTGAME. Here we tell sprite zero to carry PEN, place it in the screen center and set its heading to zero. Sprite speed will be determined by what we type when we are ready to play. To control sprite movement we use READINPUT to read input from the keyboard with the Logo primitive READCHAR and make the decisions in Table 1.

INPUT	RESULT
S	Change sprite heading 20 degrees left
D	Change sprite heading 20 degrees right
M	Stop sprite
L	Set sprite into motion
X	Call CHANGECHAR to erase tile

Table 1. Keyboard inputs to procedure READINPUT.

CHANGECHAR uses XCOLUMN and YROW, two procedures given in the Logo manual, to convert sprite X and Y coordinates to tile column and row coordinates. It then places tile 32, the 'space' character, in the appropriate column and row.

Now we are ready to play the game with PLAYGAME (number). I like to use speed 10 so the sprite doesn't get away from me. Once the game starts you can direct the sprite with 'S' and 'D' or pause with 'M' and resume with 'L'. When it is over an X you can fire with 'X' and blank it out.

The other common use for sprites is movies, so let's look at a simple movie that is controlled with procedure TRAVEL. TRAVEL plants grass on the screen and then drives a flashy red convertible across the grass. The procedural hierarchy is as follows:

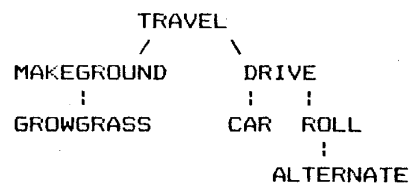

First we need to design the tiles and sprites we'll be using. I made two grass tiles, one for the top row and one to fill in below. I used tiles 97 and 104 so the tiles can be different colors. Tile colors have a restriction. Each group of eight tiles must have the same color. So tiles 0 through 7 are all the same, as are tiles 8 through 15, tiles 16 through 23 and so on. Changing either foreground or background color on a single tile will change the color of all eight tiles in that group. To define the tiles we type MAKE "GRASS1 97 and MAKE "GRASS2 104. The tiles are shown in Fig. 4.

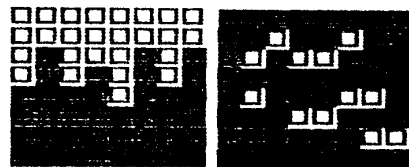

Fig. 4. MAKECHAR 97 and MAKECHAR 104

The car is made of five sprite shapes, three for the convertible body and two for the wheels (Fig. 5).

```

MAKE "WHEEL1 10
MAKE "WHEEL2 11
MAKE "CARBACK 12
MAKE "CARMIDDLE 13
MAKE "CARFRONT 14
    
```

The first things we do in TRAVEL are make the sprites SMALL, color all sprites clear and color the background cyan. MAKEGROUND is then called to clear the screen and color tile GRASS1 green and clear and tile GRASS2 green and lime. It then calls GROWGRASS which starts in column 0 of row 15 and lays tile GRASS1 all the way across. Then GROWGRASS moves to row 16, switches to GRASS2 and fills rows 16, 17 and 18 with GRASS2.

TRAVEL next calls DRIVE to put the car into motion. DRIVE calls CAR (See Page 29)

LOGO—

(Continued from Page 28)

and makes the car body of four sprites, one with CARBACK, two with CARMIDDLE and one with CARFRONT. Heading is set to 90 and the car is positioned just above the grass. Then speed is set to 20 and color to red.

Next DRIVE calls ROLL, which positions two sprites just below the car body, to be the car wheels, sets their heading and speed the same as CAR and makes them black. Then ROLL calls ALTERNATE. I wanted to have rolling wheels but since sprites always remain in the same position regardless of heading, I had to simulate sprite rotation. ALTERNATE addresses the two sprites in ROLL and assigns one WHEEL1 and the other WHEEL2. Then it pauses for 1/60th of a second and assigns the first WHEEL2 and the second WHEEL1. This sequence continues and the wheels seem to roll.

Now we're ready to type TRAVEL and watch the movie. After the first run through, it is interesting to change SMALL to BIG in TRAVEL. The first thing to note is that my flashy red convertible now looks like a tank. Notice also that you can see only half of the wheels and all of the body. This is because when sprites overlap, the sprite

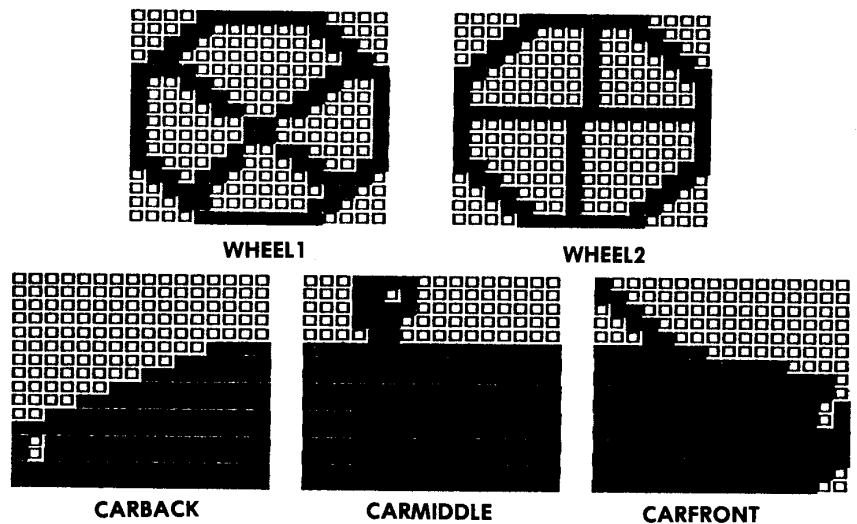

Fig. 5. MAKESHape 10, 11, 12, 13, 14

with the smaller number is on top. The body is made of sprites 0, 1, 2 and 3 and the wheels are sprites 4 and 5. Another idiosyncrasy of sprites in TI Logo is that only four sprites can appear on one line at a time. If there are more than four sprites, the sprites with higher numbers will be partially or fully masked.

This movie uses only two tiles but you could add trees, clouds, moun-

tains, a road or sun and make an elaborate scene if you want. There are also another 26 sprites available if you want to add another car or a bird or blowing leaves.

Tiles and sprites add further dimension to Logo Graphics and may be used either alone, together or in conjunction with the Turtle. Logo Music is another feature that can be added and will be discussed in the next article.

Procedures

```
TO YROW
  OUTPUT ( - YCOR + 96 ) / 8
END
```

```
TO XCOLUMN
  OUTPUT ( XCOR + 128 ) / 8
END
```

```
TO CHANGECHAR
  PUTTILE 32 XCOLUMN YROW
END
```

```
TO READINPUT
  MAKE "CHANGE READCHAR
  IF :CHANGE = "S TELL 0 LT 20
  IF :CHANGE = "D TELL 0 RT 20
  IF :CHANGE = "X CHANGECHAR
  IF :CHANGE = "M SS 0
  IF :CHANGE = "L TELL 0 SS :SPEED
  READINPUT
```

```
END
```

```
TO PLAYGAME :SPEED
  SMALL
  TELL :ALL
  SETCOLOR 0
  CLEARSCREEN
  RANDOMFILL 1
  STARTGAME
  READINPUT
  END
```

```
TO RANDOMFILL :TOTAL
  PUTTILE 88 RANDOM * RANDOM RANDOM * RA
  NDOM
  MAKE "TOTAL :TOTAL + 1
  IF :TOTAL = 200 STOP
  RANDOMFILL :TOTAL + 1
  END
```

(See Page 30)

PROCEDURES—

(Continued from Page 29)

```

TO STARTGAME
TELL SPRITE 0
CARRY :PEN
SETCOLOR :RED
SXY 0 0
SETHEADING 0
SETSPEED :SPEED
END

```

```

TO TURN
EACH [RT YN + 4 ]
WAIT 2
TURN
END

```

```

TO USEEACH
TELL :ALL
SETCOLOR 0
BIG
TELL [0 1 2 ]
CARRY :BALL
SXY -70 -50
EACH [SC YN + 1 ]
SS 20
SH 30
WAIT 80
TURN
END

```

```

TO INCREMENT
PT 200 :COL :ROW
MAKE "COL :COL + 1
IF :COL = 32 THEN MAKE "ROW :ROW + 1
IF :COL = 32 THEN MAKE "COL 0
IF :ROW = 24 THEN STOP
INCREMENT
END

```

```

TO FILL
MAKE "COL 0
MAKE "ROW 0
TELL TILE 200
SETCOLOR [4 10 ]
INCREMENT
END

```

```

TO ALTERNATE
TELL 4
CARRY :WHEEL1
TELL 5
CARRY :WHEEL2
WAIT 1
TELL 4
CARRY :WHEEL2

```

```

TELL 5
CARRY :WHEEL1
WAIT 1
ALTERNATE
END

```

```

TO ROLL
TELL 4
SXY -70 -20
TELL 5
SXY -40 -20
TELL [4 5 ]
SH 90
SETSPEED 20
SETCOLOR :BLACK
ALTERNATE
END

```

```

TO CAR
TELL 0
CARRY :CARBACK
TELL [1 2 ]
CARRY :CARMIDDLE
TELL 3
CARRY :CARFRONT
TELL [0 1 2 3 ]
SETHEADING 90
EACH [SXY -82 + YN * 15 -5 ]
SETSPEED 20
SETCOLOR :RED
END

```

```

TO GROWGRASS :COL :ROW
IF :COL < 32 THEN MAKE "GRASS :GRASS1
IF :COL < 32 THEN MAKE "ROW :ROW ELSE
MAKE "ROW :ROW + 1
IF :COL > 31 THEN MAKE "COL 0
IF :ROW > 15 THEN MAKE "GRASS :GRASS2

```

```

IF :ROW > 18 STOP
PT :GRASS :COL :ROW
GROWGRASS :COL + 1 :ROW
END

```

```

TO DRIVE
CAR
ROLL
END

```

```

TO MAKEGROUND
CLEARSCREEN
TELL TILE 97
SETCOLOR :GREEN

```

(See Page 32)

GENIAL COMPUTERWARE

presents

XB: BUG
by J. Peter Hoddie

OVERALL WINNER OF THE FIRST ANNUAL TI FORUM AND COMPUTER SHOPPER PROGRAMMING CONTEST.

THE POWER OF XB: BUG:

- * GIVES you the ability to look at the internals of your Extended BASIC program.
- * CAN be called from a running program at a key stroke. Does not interfere with the program!
- * PERMITS inspection of ALL Character, Color AND Sprite data.
- * PERMITS inspection of ALL variables.
- * PERMITS modification of numeric variables.
- * ABILITY to list ALL subprograms.
- * ABILITY to trace back ALL GOSUB's and subprogram CALL's.
- * ABILITY to list program.
- * ABILITY to SEARCH all graphics data, variable names, values and program listings.
- * ABILITY to view all open files and their data buffers.
- * ABILITY to view the next data statement.
- * CHECK all system data, current line number, ON ERROR line, ON WARNING, ON BREAK, and more.
- * CAN be used in conjunction with XB programs that use assembly language.

REQUIRES: TI Extended BASIC and 32K memory expansion.

The ULTIMATE tool for the Extended BASIC programmer. Complete documentation and several sample "debugs" included.

\$15.00

TI WRITER TIPS AND TRICKS

By Joyce Corker

This supplement to the TI-Writer Manual will help you find answers to questions like:

- * How did that happen?
- * Is there a way to . . . ?
- * What did I do wrong?
- * How can I do this quickly?

A must have for users of TI-Writer!

\$5.00

HORIZON RAM DISK EPROM
by J. Peter Hoddie

THE RAM DISK EPROM:

- * SUPPORTS single sided, double sided and 256K Horizon RAM disks.
- * FASTER, more reliable than the original Horizon operating system.
- * NEVER lose the operating system, again, because it's locked in ROM.
- * ACCESS RAM disk as DSK1 to DSK6 and as HD.
- * BUILT in CALL HDDIR to catalog RAM disk.
- * CALL DM is available, PLUS, CALL EA5 for UTIL1, CALL MD for modem, CALL BOOT for BOOT program.
- * SPECIAL BOOT program included, modified version of John Johnson's popular MENU program.
- * CALL HDVOL to name RAM Disk.
- * CALL HDDN to set drive number.
- * E/A option 3 loader to load files from ANY device.
- * ABILITY to change drive number at powerup.
- * ABILITY to load BOOT, UTIL1, MD, or MGR at powerup.
- * ALLOWS 14 extra sectors.
- * BASED on the operating system the MYARC RAM Disk.

REQUIRES: Horizon RAM Disk. Included with EPROM are installation and modification instructions, manual, and disk.

\$25.00

GRAM PACKER
By J. Peter Hoddie

THE MULTI-FACETED GRAM PACKER:

- * ALLOWS you to store multiple EAS programs in GRAM space for near instant access from main menu, CALL statements, or RUN command.
- * SPECIAL utilities allow programs to be placed on menu, but to reside on disk, RAM disk, or hard disk.
- * ALLOWS the running of Extended BASIC programs from main menu.
- * ALLOWS for cartridge and even operating system loaders to be installed on menu.

REQUIRES: GRAM Kracker, GRAM Karte or Maximem. Complete documentation and disk included.

\$10.00

"GRAM Packer is for everyone" — MICROpendium, December 1986.

All prices and availability subject to change without notice.

*add \$2.00 shipping

Copyright 1987

Dealer for: Genial Computerware

Disk Only Software
P.O. Box 244
Lorton, Virginia 22079

or call

1-800-446-4462. At the tone, enter 897335 for recorded order message. Touchtone phone is required. Alternate is (301) 369-1339. No Touchtone is required.

Delphi: TELEDATA—CompuServe: 74405,1207—MCI: TDG—TELEX: 6501106897 MCI
Canadian personal checks, at fair exchange rate, welcomed.

SF 99ers to have booth at West Coast Faire

The San Francisco 99ers are getting in to the big time this month as exhibitors at the West Coast Computer Faire. Last year's fair attracted some 750,000 visitors making it one of the largest such events ever.

Neil Wood, who's in charge of the SF 99ers booth at the fair, calls it "the grand daddy of computer fairs. We're looking for membership and getting some exposure to the rest of the world that thinks the TI is dead."

The fair is held over four days, March 26-29, at Moscone Center. This is the first

the 99ers will be participating in the event. Wood says they'll have two full TI systems in operation and will sell software from the user group's software library and other public domain programs.

Denver fair slated

A TI fair is scheduled May 2-3 at the Arapahoe County Fairgrounds in Denver, Colorado.

Mike Miller, vice president of the Rocky Mountain 99ers, says the group is seeking vendors for the fair. Vendor tables start at \$50.

Miller says persons desiring further information can call him at (303) 288-9251 or club president Mark Payne at (303) 288-7667.

Miller says information on the fair will also be posted on the club's bulletin board operating 24 hours at (303) 288-3692.

Payne is sysop and Miller is assistant sysop for the board, which operates at 300 and 1200 baud, no parity and 8 bits.

Miller says the board offers "lots of downloads" and that persons desiring more information can call him or Payne by voice at the numbers listed above.

PROCEDURES—

(Continued from Page 30)

```
TELL TILE 104
SETCOLOR SENTENCE :GREEN :LIME
GROWGRASS 0 15
END
```

```
TO TRAVEL
SMALL
```

```
TELL :ALL
SETCOLOR 0
COLORBACKGROUND :CYAN
MAKEGROUND
DRIVE
END
** DONE **
```

Artist Instances

Now! for users of *TI-Artist* and *Font-Writer*! The most extensive, complete library of instances ever produced, exclusively from **Asgard Software**. Each single disk volume in the **Artist Instances** series is a valuable collection of highly-detailed instance clipart for use in any graphics project. Each individual volume is fully documented with explanatory notes and usage tips for *Font-Writer* and *TI-Artist* users. Each collection contains only the best artwork individually culled from hundreds of files and arranged by subject matter. Finally, each volume is available for an incredible price of only \$9.00 each!

- Volume #1 - *Animals 1*: A complete collection of domestic, wild and fanciful animals.
- Volume #2 - *Animals 2*: More familiar and rare animals to decorate and enhance your creations.
- Volume #3 - *Holidays*: A volume dedicated exclusively to those very special days of the year.
- Volume #4 - *Home*: A vast library of works depicting implements of the home and home repair, and of personal items.
- Volume #5 - *People*: Famous and not-so-famous people individuals for populating your works.
- Volume #6 - *Computer*: Artwork about computers with pieces depicting office implements, transportation, and more.

Order all six volumes for only \$43.20 - a 20% discount! Please add \$.50/volume for shipping and handling. Mail orders to:

Asgard Software, P.O. Box 10306, Rockville, MD 20850
(301) 345-2492 (Office hours 8:00AM-8:00PM EST)

TEX+COMP proudly presents

UNBELIEVABLE PRICES ON 2 IMPORTANT PERIPHERALS



**ADD A 2ND DISK DRIVE TO YOUR
TI/99/4A SYSTEM FOR ONLY**

Comes complete with drive, case, power supply & cable. Ready to connect.

By adding a second drive to your system you can free yourself from swapping program and data disks on many programs. You can also make backups without any disk swapping.

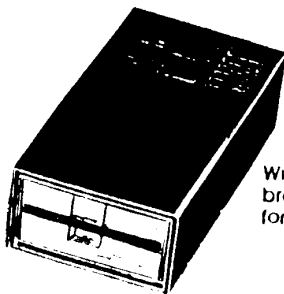

\$129.95
Plus S&H

**ADD \$20.00 for
DS/DD Drive.**

EXTRA VALUE BONUS

With each disk drive ordered we are including a HEAD brand disk drive head cleaning kit which regularly sells for \$15.95.

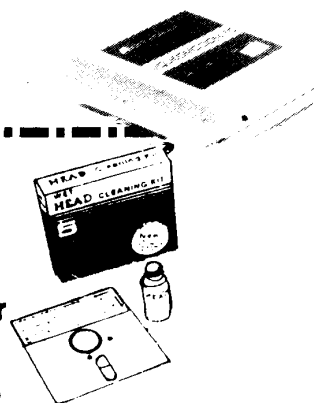

VOLKSMODEM

The Complete Low-Cost Plug-In Modem.

\$39.95

It puts computer-to-computer communications within easy reach of every personal computer owner.

Just plug Volksmodem between any wall phone jack and telephone and put your computer into instant communication with thousands of others. It's that easy. No extra parts or tools are necessary—just one adapter cable and software is all that's needed.

MONEY SAVING SPECIAL. Get the Volksmodem (reg. \$59.95), 99/4A modem cable (reg. \$12.95), and Terminal Emulator II (reg. \$9.95) an \$80+ value for **ONLY \$39.95.**

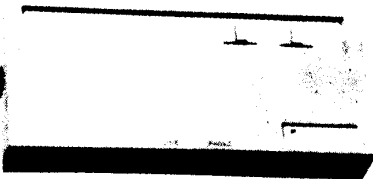

NEW LOW PRICE



VOLKSMODEM 12

300/1200 Intelligent Modem
Hayes Smartmodem Command Structure

- 300/1200 Baud • Bell 103 & 212 A Compatible
- Auto Answer/Auto Dial
- Automatic Speed Mode Selection • Cable Included (18")
- 2-Year Warranty • RS232C Compatible
- Enhanced Noise Immunity

\$139.95

**COMPLETE WITH CABLE,
TEII AND TEIV +**

Send order and make checks payable to

TEX+COMP

PO BOX 33064 - GRANADA HILLS, CA 91344



AUTHORIZED DEALER



VISA and MASTERCARD
HOLDERS CALL DIRECT
(818) 366-6631
24 Hour Order Line

TERMS: All prices FOB Los Angeles. For fastest service use cashiers check or money order. Add 3% shipping and handling (\$3.00 Minimum). East of Mississippi 4 1/2%. Add 3% for Credit Card orders. Prices and availability subject to change without notice. We reserve the right to limit quantities.

NOTE: Payment in full must accompany all orders. Credit Card, Company check or Money order for immediate shipment. Personal Checks require up to 4 weeks to clear. California orders add 6 1/2% sales tax.

DIJIT Systems RGB Kit

Crisp, clear color video

By **MACK MCCORMICK**
Technical Editor

The DIJIT Systems RGB conversion kit is absolutely fantastic! Within 45 minutes of receipt I had the conversion made and was receiving crisp, clear, video with no distortion for the first time on my TI-99/4A. All the interference was gone from the screen and finally it was great to work in the BASIC color scheme (black on cyan) without rainbow color distortion. You can even easily read each character when using FORTH in the 64-column mode. The RGB Conversion Kit performs exactly as advertised. It was very obvious from speaking with Tom Spillane of DIJIT Systems and noticing the packaging and design of the kit that this is a first rate company.

The kit comes with a six-page, illustrated instruction manual.

This project requires soldering on the computer mother board, which should not be a difficult task for those with some experience with a soldering iron. Others may have a friend who would be glad to help out.

The heart of the change is replacing the current TMS9918 composite video chip with the TMS9928 RGB (Color Difference) video chip. The chip is in a socket, so that part is a snap.

You first disassemble the console to get to the mother board. Next you replace the audio/video output jack. There are two jumpers to move and one to install. Add a few resistors and you're in business. One note, I strongly recommend you use a solder sucker such as the type available from Radio Shack when desoldering components and opening holes filled with solder. Reassemble the console and you're ready to align the output to your monitor.

DIJIT Systems also offers an excellent piece of monitor alignment software for \$20 which is not necessary but allows you to appreciate the quality of your RGB conversion. This program displays color bars, cross hatch patterns, red, green, or blue purity rasters, and 128 vertical lines (every other dot turned on), and draws perfect circles and squares to adjust linearity. It

Review

Report Card

Performance.....A
Ease of Use.....B
Documentation.....A
Value.....A
Final Grade.....A

Cost: \$35 for the Console Kit and \$65 for the Decoder Interface.

Manufacturer: DIJIT Systems, 4345 Hortensia St., San Diego, CA 92103 (619) 295-3301

Requirements: console, RGB monitor.

even has a section on adjusting convergence (making all three colors land at exactly the same point on your screen) although I wouldn't recommend you attempt the procedure without the assistance of someone who has considerable experience.

Using this software or your own judgment, you adjust the Decoder Interface for white without the colors "blooming." From that point you never have to make another adjustment.

The Decoder Interface takes the color difference signals from the computer and converts them into separate RGB signals for the monitor, with composite horizon-

tal/vertical sync.

There are two decoders available and you should check with the company if you're not sure which one is correct for your monitor. One is for TTL Digital type RGB monitors (5V p-p @400 ohms) and the other is for analog RGB monitors (1V p-p @75 ohms). Both perform equally well but are required for different monitor types. You should also let DIJIT Systems know your monitor make and model so the company can provide the correct cable.

The only thing I found objectionable was that the company elected to remove the chip numbers from the Decode Interface to prevent pirates from copying the design. I understand their motives, however this prevents the bona fide user from doing his own repair should a chip fail. With a little patience you can figure out what chips they are anyway.

Of course, this system will only be as good as your monitor. I have tested the RGB kit on several monitors and have decided to buy a new monitor as a result. I strongly recommend you do not buy the Sears Total Video System monitor with RGB input. This monitor was designed for TTL Digital RGB input and does not do a good job of color reproduction. If you are buying a new monitor you should select an Analog RGB monitor with a minimum video bandwidth of 10 Mhz. It should use

See Page 36



Wycove Forth Version 3.0

An improvement on the original

By **ROBERT CARMANY**

From time to time, we see the introduction of "Version x.x" of some software program. Usually, the major change in the program is an alteration of the title screen. Sometimes there are a couple of minor "bug fixes" and there is always a price increase! Well, I was prepared to experience much the same when I discovered the most recent version of Wycove Forth. Boy, was I surprised!

First of all, the basic system comes as a two-disk issue. There is one disk with the familiar name "Applications Disk" that contains all of the familiar screens that were in versions 2.0 and 2.1. Of course, there are some additions scattered throughout the system, such as CODE JOYSTICK and PAL and a couple of others. But, all in all, it appears to be just what was issued as version 2.1.

The second disk is the Electives Disk. That is a really "new" experience. It contains all of the electives screens you need to make a working copy of the basic system. There are some other enhancements, but we will wait to discuss them at the appropriate time.

System changes: This is a category beyond the rating factors I considered in trying to construct a Report Card for Wycove Forth Version 3.0. It is necessary, however, to mention some of the more easily identified ones. First of all, the Forth kernel has been moved so that most of it resides in low memory. That frees up some memory in the high block of memory expansion for significantly more program area.

The disk access speed has been greatly improved and we will discuss it more under Performance. The old SAVE-BUFFERS word has been renamed FLUSH to conform to Forth standards (it is much easier to type as well). Cassette access has been removed in this version so it works on disk-only systems. The Forth workspace has been moved so that it doesn't conflict with RS232 interrupt driven input. Some other changes are of passing interest, but these are detailed in the V3 file that comes with the system.

Documentaton: Before we go any fur

Review

Report Card

Performance.....	A+
Ease of Use.....	A
Documentation.....	?
Value.....	A+
Final Grade.....	A

Cost: \$25

Manufacturer: Tim MacEachern, P.O. Box 1105, Dartmouth, Nova Scotia, Canada B2Y 4B8

Requirements: console, monitor or television, memory expansion, disk system and either Extended BASIC, Mini-Memory, Editor/Assembler or TI-Writer (Option 3).

ther. It might be well to mention that this is a limited release. MacEachern feels that there is not a sufficient market left to justify the publication of a new manual for this version. That is why the rating for documentation is a question mark. If you already have the manual for either version 2.0 or 2.1 you are all set. There are some minor differences between the versions that are mentioned in the file V3 that accompanies this release. The original documentation was complete and easy to read so I guess that, if you already have it, the documentation rating should be an "A." For those who have a good working knowledge of the procedures involved in Forth programming, a manual is not necessary. So the rating of the program's documentation remains somewhat an enigma.

Ease of use: The program boots quite smoothly from any of the cartridge environments mentioned in the requirements. The only problem I encountered was the lack of a MENU word or user menu in the system. I was rather disappointed in this regard. However, I soon found it quite easy to transfer the contents of screen 1 to an unused screen and install a MENU word (see Sept. '86 MICROpendium). Everything works quite well.

Performance: This is the area in which

the greatest change has occurred. To begin, the disk access time has been greatly improved. Version 3.0 averages 50 percent faster in screen access from disk than either versions 2.0 or 2.1. It also outstrips TI-Forth in screen loads—about 68 percent faster on the average. The benchmarks that I ran (a minimum of four screens loaded) were right on target—some 50-60 percent faster in this version than in earlier ones.

One of the more interesting changes is in the use of the Electives Disk to generate copies of the Forth system. In addition to copying a new version actually to disk, substantive changes can be made simply by editing a couple of screens. You can change the acceptable word length from 31 characters, increase or decrease the number of screens per disk (from 70 to whatever you wish), change the number of screen buffers (from 5), and many other things. When you are done, you can save the whole customized new system by LOADing screen No. 34 on the Electives Disk. It is all very elegant and easy. Incidentally, the instructions for generating a new system are imbedded in the screens themselves.

All the familiar options are still available. The system still has full sound and speech facility built in as well as a disk directory screen. There are other screens unique to Wycove Forth as well. The biggest advantage is that all these screens are bug free.

One of the biggest advantages inherent in Wycove Forth is the screen title structure. TI-Forth uses a nonstandard method of storing screens. If you have a disk of nothing but screens, it cannot be copied with a disk manager (i.e. DM1000, etc.). It can be copied using a track copier or a Forth copy program. Wycove Forth, on the other hand, uses the standard format for saving screens. They may be copied with any of the standard disk copy utilities. It makes backing up a disk much easier.

Value: If you are an experienced Forth programmer or have a copy of the Wycove Forth manual for either version 2.0 or 2.1, this latest release of Wycove Forth is a real

(See Page 36)

RGB CONVERTER—

(Continued from Page 34)

composite horizontal and vertical sync and be capable of producing 80 columns. For my money I'm going to purchase the Amiga 1080 monitor (not the computer).

In summary I couldn't be more pleased with the results of the DIJIT Systems RGB Conversion Kit. It's difficult to believe how I survived so long with such crummy video as the original TI

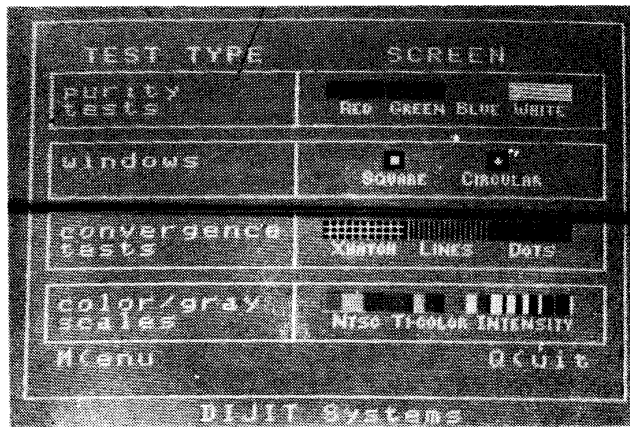

RGB screen test

video chip produces. If you convert, you'll certainly be pleased with the results.

As for the purchase of a new monitor, well, it's certainly one you can use for years to come even if, heaven forbid, you decide to move on to another computer. Contact Tom Spillane at DIJIT Systems for full details. He's very friendly and knowledgeable about video systems.

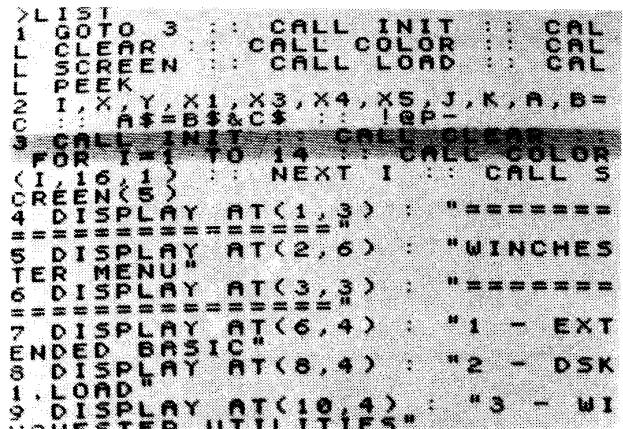

Example of RGB video display



TI ARTIST Ver. 2.01 \$ 19.95
 Companion #5 \$ 9.95
 Char. Sets & Graph. Design 5 \$ 17.95
 User Disk #4 (new!) \$ 10.95
 RAPIDCOPY \$ 14.95
 MG DISKASSEMBLER \$ 19.95
 MG CorComp Controller Eproms \$ 34.95
 MG NIGHT MISSION \$ 19.95
 FONT Writer—By Peter Hoddie \$ 24.95
 Total File—Written in c99 \$ 24.95
 The Printers Apprentice \$ 22.50
 TPA Fonts Disk #1 \$ 11.50
 Business Graphs 99 \$ 15.95

Lots more available!!!—

Used TI Equipment

Qty.	Description	price each
1	99-8 Computer w/ Hexbus DS-DD drive, controller	\$800
6	TI 99-4A Empty Peripheral Boxes—w/ Interface card and AC cord	\$130
15	External Drives w/ power supplies	\$ 75
2	TI 99-4A Pascal P-code systems—w/ docs, software	\$150
6	Full P-Box systems—32k mem. RS232, Disk Controller, Internal Drive, Ext. Drive & p.s.	\$375
15	TI Original Extended BASIC Cartridges w/ manuals	\$ 27

MYARC PRODUCTS—
 Myarc Model 9640 Computer Std. \$445.95
 W/ Enhanced Keyboard \$475.95
(add \$55 for Mouse option per unit)
 Myarc 256K Memory Card \$175.95
 Myarc 512K Memory Card \$239.95
 Myarc DS/DD Controller Card \$145.95
 Myarc RS232 Card \$ 79.95
 Myarc Hard Disk Controller \$259.95

MECHATRONICS PRODUCTS —
 TI Mouse-W/ Software, AC Adpt. \$139.95
 Eprommer W/ Software, Power Sply \$129.95
 128K GramKarte-W/ Software \$199.95
 80 Column Card W/ 80 Col. TIW \$229.95
 2.8" Quickdisk For CC40, TI74 \$220.95
 128K Standalone w/ PIO Port \$129.95

HORIZON RAMDISK —
 Horizon Ramdisk Kit w/ docs, S.W. \$ 48.00
 90K—Built and tested \$185.00
 180K—Built and tested \$225.00

AVATEX MODEMS—
 1200 Baud. Auto Dial. Answer
 AVATEX 1200 \$ 95.00
 AVATEX 1200HC-Hayes Compatible \$130.00

ARMADILLO BYTES—P.O. BOX 900921—DALLAS, TEXAS—75390—(214) 328-9257

Texas Residents add 7 1/4 % State Tax
 —We Accept Cash, Checks or Money Orders—Sorry No Credit Card Orders—
 —FREE PRICE LIST & LATEST SALES FLYER—

WYCOVE FORTH—

(Continued from Page 35)

bargain at \$25. The increase in speed and overall system versatility have always made Forth an outstanding programming language. The continued high quality of Tim MacEachern's latest release make it the most powerful Forth applicaton for the TI99/4A.

Source code for both version 2.0 and 3.0 are available from the same address for \$20 each. The source code for Version 3.0 contains the code for normal disk access as well as the code for direct disk read/write.

Although this is a limited release, MacEachern states in the documentation that some limited support will be offered. From personal experience, I can state that he will reply promptly to your questions and supplies valuable, incisive information. If you need more information about the capabilities of Wycove Forth, consult the September 1984 MICROpendium for a review of Version 2.0. It will give you some insight into the differences between Wycove Forth and TI-Forth and details many of the capabilities of this fine product. Incidentally, in response to that article, MacEachern offered a series of supplementary screens on a variety of topics and you may be able to get your own copy by writing to him at the listed address.

In conclusion, I have been using both TI-Forth and Wycove Forth for a couple of years and had copies of both systems until recently. The introduction of Version 3.0 of Wycove Forth has freed up a couple of disks—I trashed TI-Forth in favor of the much superior Wycove Forth. It is simply THAT good!

Spad XIII Flight Simulator

Watch out Red Baron

By JOHN KOLOEN

Spad XIII by Not-Polyoptics is the latest entry in the growing TI flight simulation field. It is also one of the better ones.

The simulation involves a World War I motif throughout. Taking the controls of a Spad XIII, you have the option of recreational flying or going into battle against the Huns. It's a safe bet that anyone who flies the Spad will spend most of his time in the attack mode.

Performance: Spad XIII can be controlled using a joystick or the keyboard. Keyboard input gives the pilot more control than a joystick. The keyboard became my preferred manner of flying, though it was a little awkward at first. It is often necessary to hold a key down for a second before it registers. Occasionally this delay allowed an enemy plane to pass out of the circle of my gunsight.

The W, E, R, A, S, D, F, Z, X, C and V keys are used to control stick movement, the comma and period keys are used to control the rudder, the Q key fires the machine guns, the B key is used to drop bombs, the throttle is controlled by the 7, 8, 9 and 0 keys, and keys 1-6 are used to select a variety of views (front, left, right, back, up and down). The U key is used to provide a forward view without a cockpit. Normally, a cockpit fills half the screen. The cockpit includes an instrument panel consisting of an altimeter, compass, fuel gauge and air speed indicator. There is also a throttle indicator. The cockpit is framed by the upper wing of the Spad and the tail. The tail rises and falls depending on how level the plane is flying. The position of the tail in relation to the gunsight can be used to insure level flight, though this can be accomplished simply by "eyeballing" the horizon.

Spad XIII operates as you'd expect. Being a rather simple airplane, not a great deal is required to get it airborne. Rev the engine, roll down the runway and pull back on the stick is enough. Keeping it airborne takes a little practice, and it is definitely easier to do with the keyboard than a joystick. Operating in a WWI context, you needn't bother with obtaining clearance

Review

Report Card

Performance.....	A
Ease of Use.....	B
Documentation.....	A
Value.....	A
Final Grade.....	A

Cost: \$29.95

Manufacturer: Not-Polyoptics, P.O. Box 4443, Woodbridge, VA 22191 (703)491-5543.

Requirements: Extended BASIC, memory expansion, disk system, joystick optional

from a tower to land. A light plane such as the Spad can land safely in virtually any clearing. Landing on the runway takes practice, but if you miss and don't want to try again you can just set her down anywhere.

The program uses a stylized 3-D view throughout. (By stylized, I mean that objects are rendered with lines.) The effect is convincing, though not as detailed as a picture created using a good graphics design program.

The most detailed graphics in Spad XIII are the aircraft, French and German airports and hangars, German airplanes, flak and observation balloons. There are also trenches, clouds, sun, the Eiffel Tower, villages, the Seine River, and hills. Predictably, things get bigger as you approach them and smaller as you move away from them. The closer you come the more detailed objects become. You can get close enough to an observation balloon or enemy airplane that they fill the screen.

Color is used in a basic manner: blue represents sky and ground, sun is yellow, clouds are white, black are the enemy planes, red is the machine gun fire coming from your plane.

I find the graphics to be quite satisfactory.

Sound plays a role in Spad XIII, including the droning of the engine and the firing of machine guns. The engine sound changes depending on the amount of throttle. The machine gun sound is right on target. Unfortunately, flak and bombs are not accompanied by sound.

Flying Spad requires a light touch, particularly when climbing. It is easy to angle the nose of the Spad a little too much, causing the plane to roll over. Stalling is a less common problem since it largely has to do

(See Page 39)

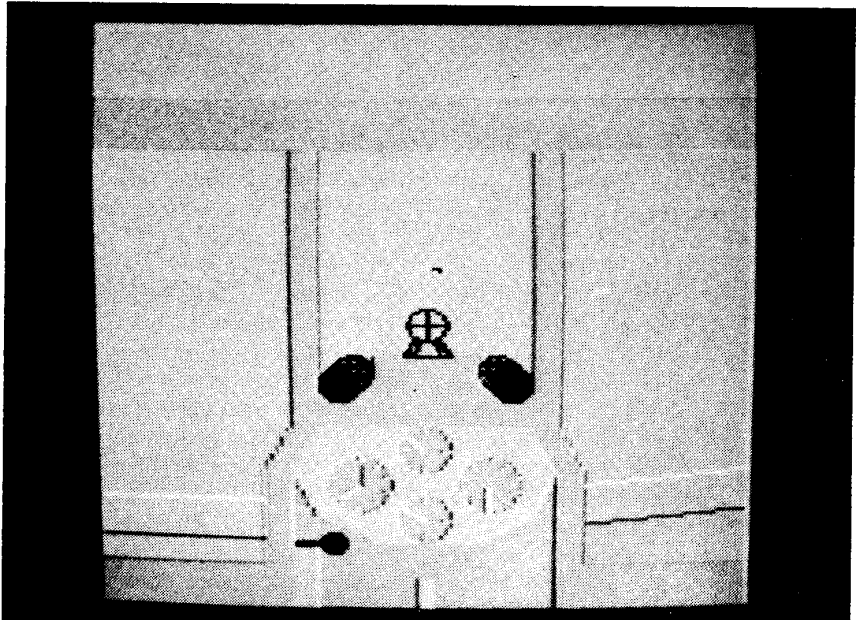

SPAD XIII—

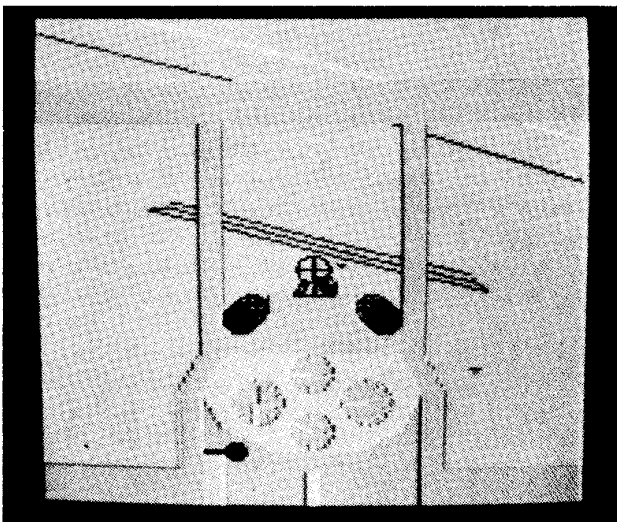

A view of an airfield from the cockpit.

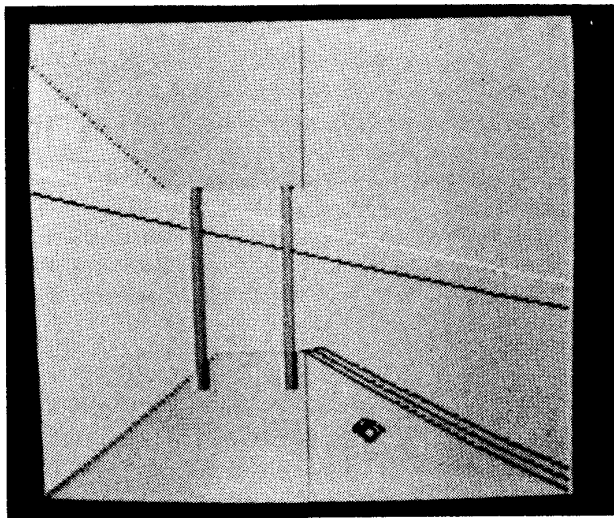

A view of an airfield looking over a wing.

(Continued from Page 39)

with velocity. You expect to stall when you get down to 40 knots or so, but you don't always expect to roll over when your angle of climb gets to be a little too much. But that's a limitation of WWI flying machines and not an arbitrary glitch in the program. I would like to have seen some sort of spirit level to let you know when the plane is angled too much. Sometimes it is difficult to tell just by looking out the cockpit, particularly in view of the fact that primary reference points are the sun, a distant horizon and layer of clouds and widely scattered objects on the ground.

Dogfights are the order of the day for pilots of the Spad XIII, and it doesn't let you down. Whether you are trying to shoot down the ten observation balloons (while avoiding heavy flak), chasing a German two-seater or preparing to bomb a German airfield the challenge of keeping your plane under control while taking aim is engaging. With only 1000 rounds of ammunition in your twin Vickers machine guns marksmanship counts for much. You don't want to shoot when the targets are too far away but if you wait until they're close they may get you first. Tiny bursts of white light represent machine gun fire from the enemy planes. Hitting balloons is easier because they're stationary but what does it matter if the Spad is hit by machine gun fire from a two-seater or flak from the ground? The same goes for bombing the

airfield. It, too, is protected by flak batteries. (Since there's no bomb sight, the only way to score a hit is to drop the bombs from a low altitude. In fact, you can't see them explode from an altitude greater than 1,000 feet.)

The reward for a successful engagement with the enemy is to watch as the shredded balloon or aircraft plummets to the ground. There is a score-keeping feature that tallies the number of hits you've made but I found it to be almost irrelevant.

Although there are definite visual cues confirming hits you make, damage to the Spad shows up as loss of performance of the aircraft. If, all of a sudden, the Spad starts spinning wildly toward the ground and pulling back on the stick doesn't do any good, you can be pretty sure that you took a heavy hit. Smoke erupting in the cockpit would have been a nice touch to confirm that the Spad has been hit. Some visual confirmation of minor hits would at least allow you to head back for the airfield to make repairs. I found that in most cases, by the time I realized the Spad had been hit, the damage was so serious that I couldn't return to the airfield. Those who pay more attention to the performance of the Spad than I have the option of returning to the airfield for repairs and rearming.

Ease of Use: To get the most out of Spad XIII you have to use the keyboard rather than a joystick. Since 25 keys are used to control everything from views to the rud-

der you have to be familiar with their locations before you can gain full control of the aircraft. Fortunately, the documentation is arranged so that a keyboard template occupies the lower half of a page while a diagram of the cockpit instrument panel occupies the top half.

Documentation: The manual is excellent. The 20-page booklet includes plenty of diagrams and historical and performance data on the Spad XIII. It's written in an instructional style that could pass for the real thing.

Value: I think this is the best flight simulation program available for the TI. Bear in mind that it emulates a vintage aircraft and is therefore not directly comparable to the Dow-4 Gazelle or 4A-Flyer. While it is the equal of the Gazelle in terms of its aerodynamic realism, it is superior to it by virtue of its use of graphics. Both the Gazelle and Spad are superior to 4A-Flyer.

The only criticisms I have of it are minor, and mentioned above. It's not the "ultimate" flight simulation program in terms of what is possible on the TI, particularly in terms of the use of graphics. But the fact that it emulates a biplane rather than a modern, high-performance plane was a good decision by Not-Polyoptics. For what it tries to do, it succeeds quite well. And that's a lot more than I said about the last flight simulator I reviewed.

Newsbytes

Programs sought for photography show

A "Computer Corner" is scheduled for the October convention in Milwaukee, Wisconsin, of the Photographic Society of America.

C. Stokesberry of San Lorenzo, California, asks that anyone who has created a TI99/4A program for cataloging slides or for tabulating competition results send him a disk and/or tape of the program, a print-out and documentation along with name and address.

Those who have created commercial programs are asked to send brochures, program description, disk or tape, print-out and program source. Stokesberry notes that copyrights will be observed.

For further information, contact Stokesberry at 630 Via Aires, San Lorenzo, CA 94580.

E & M Software offers utility programs

E & M Software of Napa, California, announces the availability of two utility programs, File Master and Home Banking.

File Master is designed for file management, enabling the user to catalog, run or delete disk files "at the touch of a key," according to Mark Reynolds, president of E & M.

Requirements are Extended BASIC, 32K memory expansion and at least one disk drive. Price is \$7.95, including shipping.

Home Banking is designed to perform many of the routine tasks associated with checkbook management. Reynolds says it will record check number, payee, amount, date and budget code; record all deposits, bank charges and teller machine withdrawals; allow the user to review transactions by entering the desired check number, date of transaction or specific month (with the option of voiding a transaction by a single key press); print a check register in 80-column format which lists the date, check number, payee, amount and balance as of each transaction for all transactions, those starting with a particular transaction, all transactions for a specific month

or a summary of expenditures. It reconciles the Home Banking records with the monthly bank statement, according to the manufacturer.

Requirements are Extended BASIC, a disk drive controller and disk drive and 32K memory expansion. Printer is optional. Price is \$16.95, including shipping.

For further information, or to order, contact E & M Software, 1092 Kansas Ave., Napa, CA 94558.

Kazco International ceases operations

Kazco International of Sylmar, California, which produced products for the TI99/4A, has ceased operations, according to Ray Kazmer, company president.

Kazmer cited declining sales as the reason for discontinuing operations.

BasicSort upgraded, distribution changed

Andreas L. Dessoiff of Fairfield, Connecticut, announces that he is discontinuing fairware distribution of his BasicSort program.

He says he has an improved Version 2.0 available which he will sell outright for \$15 plus \$3 for shipping and handling. The new version eliminates the fairware screens and announcements and key presses required to continue, "which had been the only complaint from users of the program," Dessoiff says.

He says that persons who ordered the program before it became fairware and had subsequently received free copies of the program, most subsequently sent him money after they received the program. "In several cases they also wrote letters marvelling at the speed of the program and expressing their appreciation," Dessoiff says, noting that some paid more than the \$10 he asked for as a fairware price.

"On the other hand the fairware recipients obviously either did not know what they were getting or otherwise did not appreciate it," Dessoiff says. "One demanded a special version that he was not willing to pay for. None of them sent me any money except for the \$3 that I charged for

the cost of postage, a mailer and a disk. Needless to say, I think that distributing the program as fairware was a mistake which I will not repeat."

He says owners of the Fairware Version 1.0 who have paid the Fairware price can upgrade to version 2.0 by sending \$3 for a disk, mailer and postage.

For further information or to order, contact Dessoiff at 1041 Church Hill Rd., Fairfield, CT 06432.

News from Asgard

Asgard Software announces a new series of products for Font Writer and TI-Artist users, the Artist Instances series.

Asgard also announces an update to its High Gravity program and the discontinuance of its Artist Companion product.

Artist Instances, a six-volume set, consists only of files in Instance format. Each volume is differentiated by subject matter, according to the manufacturer, with only works of a particular type included in each. Chris Bobbitt, general manager of Asgard, says works range in size from 8-x-24 pixels up to full-screen size, with larger works predominating in most volumes.

He says complete documentation is provided for both TI-Artist and Font Writer users, and that specific information is provided for each file in each volume as well.

Each volume in the series is available for \$9, or the entire series may be purchased collectively for \$43.20, a 20 percent discount. All volumes require either TI-Artist, Font Writer or any other program that can utilize TI-Artist Instances, and the hardware that each requires.

The upgrade of High Gravity, an educational and entertainment program by Tom Wible, features a game editor for creating new games, is twice as fast and comes with more sample configurations to go with the approximately 20 provided on version 1.0, according to Bobbitt.

Owners of version 1.0 can upgrade to 2.0 by returning their original disk with \$6 for the new documentation, Bobbitt says.

The object of High Gravity is to shoot an unguided projectile through a field of planets of various sizes to a space station trapped inside. The planets exert gravita-

(See Page 40)

Newsbytes

(Continued from Page 39)

tional influence over the path of the projectile (to the point where it can crash).

Bobbitt cites what he called the "unresolved name conflict" with Textaments as one of the primary reasons for withdrawing Artist Companion. Textaments produces a product entitled Artist's Companion.

"Even though our product was released almost concurrently with theirs (Textaments)," Bobbitt says, "ours never seemed to catch on."

He cites the large variety of fonts available in Textaments' companions, largely ported over from the Character Sets and Graphics Design program with the approval and later help of its author, David Rose, as the main reason for the success of Textaments' Artist's Companion.

Bobbitt cites Artist Instances as a new direction for Asgard in support for TI-Artist and Font Writer users.

"We felt the only way to innovate any further in the companion area was to produce specialized, specific products that cater to the individual's specific graphics needs," he says. "The market wasn't sophisticated enough at first for this, but now we feel it is."

He says the firm will continue servicing its Artist Companion product. "We will repair or replace our hundreds of installed copies of the product for as long as we are in business—and maybe longer," he says.

He says a small supply of the two-disk product was in stock at the time of the announcement. "We are liquidating our remaining stock at \$5 a copy," he says. "We'll fill orders on a first-come, first-served basis for as long as they last. We'll then return any checks sent after the inventory is exhausted."

For further information or to order, contact Asgard Software, P.O. Box 10306, Rockville, MD 20850.

MG demonstrations scheduled for group

Craig Miller of MG will demonstrate the Triton Turbo-XT and other MG products at the April 16 meeting of the Front Ranger 99ers in Colorado Springs, Colorado.

The meeting will be at 6:30 p.m. at the

Cheyenne Mountain Inn. Club members will be admitted free and a charge of \$2 will be assessed of nonmembers attending, according to club president Joseph Nuvolini.

Second Ottawa fest scheduled for May

The TI99/4A National Users Association of Canada, in cooperation with the Ottawa TI99/4A Users Group, is sponsoring the second annual TI FEST May 16.

The event will be held from 9:30 a.m. to 5:30 p.m. at Merivale High School, 1755 Merivale Rd., Nepean, Ontario, in the greater Ottawa area.

Bob Boone, TI FEST coordinator, says vendor spaces are available for \$50 apiece and that the fair organizers will provide a vendor with a working TI system in any configuration specified for use during the show.

He says organizers are attempting to assemble an information package on Canadian customs requirements for vendors who will be importing products from the United States.

He notes that a hospitality suite will be arranged at the Talisman Motor Inn for the evening of May 15, and a banquet is scheduled for the night of May 16.

He says that company representatives from Myarc, Horizon, Great Lakes Software, Genie and CompuServe are expected to attend. Barry Traver, Peter Hoddie and Paul Charlton are TI notables expected, he notes.

For further information, contact Boone at 25 Ottawa St., Anrior, Ontario, Canada K7S 1W7 or call (613) 623-7841.

Fest-West '87 slated for May in California

The LA 99ers Computer Group will hold its FEST-WEST '87 May 16-17 at the Shrine Exposition Hall in Los Angeles, California, in conjunction with the Los Angeles Computer Sellathon.

Vendor boots are available for \$100. Tickets are \$6. Publication of a \$1 discount coupon is scheduled for the LA 99ers

(See Page 41)

absolutely!
FREE
 CATALOG
 POLYOPTICS
 13721 LYNN STREET, SUITE 15
 WOODBRIDGE, VA 22191

Newsbytes

(Continued from Page 40)

newsletter and for uploading to networks. The coupon may be freely duplicated, according to organizers, and the ticket is good for both days.

A block of rooms has been reserved at the Vagabond Inn in Los Angeles at \$48 per room, sharing permitted.

A new feature for this year's event may be a consignment table, the LA 99ers' newsletter says.

For further information or room reservations, contact the club's vice president, Terrie Masters, at 148 S. Maple Dr., Beverly Hills, CA 90212 or (219) 271-6930.

New England Faire set for April 4

The Boston Computer Society and 10 other New England users groups are scheduled to present the Second Annual New England TI99 Faire from 10 a.m. to 6 p.m. at Waltham High School in Waltham, Massachusetts.

The Myarc 9640 and the Triton Turbo-XT will be exhibited, according to organizers.

Speakers scheduled include Lou Phillips of Myarc; Jonathan Zittrain, CompuServe sysop; Cheryl Whitelaw (Regena), MICROpendium columnist; Clint Pulley, author of the c99 language; Tom Freeman, software author; Barry Traver of Genial Computerware; and J. Peter Hoddie, software author.

Companies scheduled for sales and exhibits are Myarc, Triton, Access Engineering, Asgard Software, Disk Only Software, Mechatronics, CompuServe, Textaments, Genial Computerware, RAVE Keyboards, RYTE Data and Delphi.

For further information, contact Walt Howe at (617) 692-2707 or the Boston Computer Society office at (617) 367-8080.

Bible Trivia released

Trinity Systems has released a new Bible based home computer game for the TI99/4A called Bible Trivia.

According to the manufacturer, the game harnesses TI99/4A power to give

clues in ways not possible by board games.

The manufacturer says the game can be played by from one to six players or teams, and is designed to aid in learning people, places, numbers and verses of the Bible.

David Butalla of Trinity Systems says the game includes hundreds of clues and the choice of nine skill levels for each player, so that players with different knowledge levels can compete equally.

Bible Trivia runs from TI BASIC and is available on tape for \$14.95. Bible Trivia is also sold with Trinity Systems' Bible Books Game on the same tape for \$19.95 (\$29.90 for the two games purchased separately). Shipping and handling are included and there is a 30-day guarantee.

For further information, or to order, contact Trinity Systems, 1022 Grandview Ave., Pittsburgh, PA 15237 or (412) 366-5811.

New Jersey TICOFF set for second year

TICOFF '87 is set for 9 a.m. to 4 p.m. March 28 at the Roselle Park High School in Roselle Park, New Jersey.

The program is presented by the Roselle Park High School Student Council in cooperation with six New Jersey TI users groups. Proceeds benefit the Student Council's scholarship fund.

For further information, contact Robert Guellnitz, (201) 241-8902 or 241-4550.

New phone number for FLUG TIBBS

Effective March 14, the FLUG TIBBS, run by the Forest Lane TI Users Group of Dallas, Texas has a new phone number, (214)398-7162, for its 24-hour board, available at 300 and 1200 baud.

New sysop will be Rick Morgan, with former sysop Richard Fleetwood serving as co-sysop.

Fleetwood has joined the Delphi system as a member of the Professional Counsel, which also includes Ron Albright, Walt Howe, Paul Charlton, Art Byers and Chris Bobbitt. Jeff Guide of Disk Only Software heads the TI-SIG on Delphi.

Inquiries about the FLUG TIBBS may be sent to the Forest Lane TI Users Group, P.O. Box 743005, Dallas, TX 75390.

Newsbytes is a column of general information for TI99/4A users. It includes product announcements and other items of interest. The publisher does not necessarily endorse products listed in this column.

CSGD AND TI-ARTIST USERS!

EXPAND YOUR GRAPHICS LIBRARY WITH THIS BRAND NEW 2-DISK COLLECTION OF FONTS AND FILES! GET IT IN EITHER CSGD OR TI-ARTIST FORMAT. INCLUDES 11 FONTS.

ROUNDED SOLID PRISMA NEW3D

plus type

PLUS OVER 100 "GRAPHICS" - SMALL, S.M.S. INSTANCES - LIFE.

HAND OVER 30 "PICTURES" - LARGE INSTANCES LIFE.

TI-ARTIST FORMAT REQUIRED
TI-ARTIST V2.0, CSGD FORMAT REQUIRES ANY ONE OF THE CSGD SERIES I - III, PLUS APPROPRIATE HARDWARE. EACH 2-DISK SET IS \$9.95 (UP BLY BOTH FORMATS - 4 DISKS - FOR ONLY \$34.95) PLEASE INCLUDE \$1.50 SHIPPING AND HANDLING. MAIL ORDERS TO:

IMAGELOC SOFTWARE
3674 S.E. LINCOLN
PORTLAND, OR 97214



Reduce eyestrain with text so sharp you can even read the 64 column Forth editor clearly and distinctly.

Get bright sharp graphics in Ti's own palette of 16 computer generated colors.

Banish annoying "rainbow" color bleed distortion and screen interferences from outside sources.

The easy RGB conversion requires

CONSOLE RGB CONVERSION KIT \$35

MODEL 4A DECODER INTERFACE \$75
Including connector for most monitors

Linearization Kit \$15

Required for Sears 4084 and Sanyo DMC 6500/7500

Add to above for S/H \$4

NOTE: An Analog RGB monitor, preferably 80 column rated, is needed to display the full color range. Inquire about our SPECIAL COMBO offer: Super Magnavox monitor plus RGB Conversion Kit.

VIDEO ALIGNMENT SOFTWARE \$20

CACHE CARD \$35

Add to above for S/H \$2

MINI MEMORY LITHIUM CELL Inc S H \$5

CAL Residents include 6% sales tax

TO ORDER: Send check or money order only to:

DIJIT SYSTEMS

4345 Hortensia Street

San Diego, CA 92103

(619) 295-3301

User Notes

Simple titles for videos

The following program, by John Hedstrom, is a simple tool for adding titles to videotapes. The program allows for entry of up to six lines of text. It uses 28-character lines. The user is prompted for foreground and background colors. In operation, the program displays the text on the screen, centered, and draws a border that resembles a filmstrip. To print a quotation mark, enter three of them consecutively. To skip a line, simply press enter.

Here is the program, which first appeared in the newsletter of the Chicago TI User Group:

```

90 ! CHICAGO TIMES
100 ! VCR TITLE SCREEN
110 ! BY JOHN HEDSTROM
120 ! DEC. 3, 1984
130 CALL CLEAR
140 INPUT "SCREEN COLOR?_":
S
150 INPUT "FOREGROUND COLOR?
": F
160 INPUT "LINE #1?_": L1$
170 INPUT "LINE #2?_": L2$
180 INPUT "LINE #3?_": L3$
190 INPUT "LINE #4?_": L4$
200 INPUT "LINE #5?_": L5$
210 INPUT "LINE #6?_": L6$
220 T1=(30-LEN(L1$))/2
230 T2=(30-LEN(L2$))/2
240 T3=(30-LEN(L3$))/2
250 T4=(30-LEN(L4$))/2
260 T5=(30-LEN(L5$))/2
270 T6=(30-LEN(L6$))/2
280 CALL CLEAR
290 CALL SCREEN(S)
300 FOR C=1 TO 12
310 CALL COLOR(C,F,1)
320 NEXT C
330 PRINT TAB (T1);L1$ : : :
      TAB (T2);L2$ : : : TAB (T3)
;L3$ : : : TAB (T4);L4$; : :
: TAB (T5);L5$ : : : TAB (T
6);L6$ : : :
340 CALL HCHAR(1,1,30,32)
350 CALL HCHAR(24,1,30,32)
360 CALL VCHAR(1,1,30,24)
370 GOTO 360

```

Delete columns from TIW, E/A

Bob Stahl of Hummels Wharf, Pennsylvania, provided a program to delete columns from TI-Writer or Editor/Assembler files. Last month we listed a routine that could also be used for this purpose, but Stahl's program goes a step further. Here's what he says:

This program is designed to delete or erase any number of columns between any two rows you specify in a TI-Writer or E/A D/V 80 file. The program will read your file and place it into a D/F 80 file so it can work on individual records. Don't worry about losing your file. It is left in place untouched. If you make a mistake and delete the wrong columns, simply do it again. I would recommend you use a blank disk, with only your program on it when using this program, because the second file will be longer than the original one and both will have to fit on the same disk.

When the program is finished running you can load the file into TI-Writer or E/A. You will notice the file generated is a D/F 80 file. TI-Writer cannot save a F 80 file, but it can read it and save it as a D/V 80 file. So to save space I would recommend you load the file and re-save it using TI-Writer or E/A, whichever fits your application.

When you are deleting columns, the columns will be removed and the columns to the right will be moved left the number of columns you deleted. When you are erasing columns, all columns will be left in place and a space character will be written over the specified columns to be erased.

If you find my explanation a little confusing, just run the program several times and you should get the hang of it. Don't worry, you can't damage your original file. Always remember though; Keep a back-up copy, accidents or equipment failure does happen.

A brief description of the program follows below:

100-210 Prepare the program to turn off the prescan to speed up the program start. Turn off the prescan. This only saves a few seconds in a program this size, but it's good practice to use it in short programs to start with. Learning to use the prescan with longer programs is a threat to any programmers ego.

220-250 Define the border characters and place the border on the screen.

270 You can place a default file name here; only nine characters, and place them where "test" is in quote marks. You may also use a REM here if you don't want a default file name or remove the line entirely.

290-320 Place text on the screen and accept the file name.

330-450 Read your file and put it in a D/F 80 file. Your filename will be used for the new name but an asterisk will be placed as the last character. You will find that after you enter your file name, FCTN 4 or QUIT will not be active. This was done to try and prevent any loss of files. If you wish to leave the program without making any changes to a file, leave 00 in the last entry ENDROW, and the program will jump to the filename input. At this point FCTN 4 and QUIT will work.

460-500 Accept your input; "Y" will delete columns, "N" will erase columns. You specify starting column, length, starting row and ending row. If you want to change any of your input; at ENDROW, leave 00 for the input, and the program will close all files and jump back to the filename input.

510-590 Delete the columns.

600-640 These lines contain the error handling and the end display with your new file name. Also line 640 turns on the prescan before the program starts running.

100 ! Delete or Erase
Columns in TI-WRITER
(See Page 43)

User Notes

(Continued from Page 42)

```

or E/A DIS/VAR 80 files
110 !
120 !
130 DATA By Bob Stahl
140 !       P.O. Box 430
150 !       Hummels Wharf,
160 !       Pa. 17831
170 !
180 GOTO 210
190 CALL CHAR :: CALL CLEAR
:: CALL SCREEN :: CALL COLOR
:: RVCHAR$ :: LVCHAR$ :: BH
CHAR$ :: THCHAR$ :: CALL HCH
AR :: CALL VCHAR :: FNAME$ :
: DISPLAY AT :: DELETE
200 ON ERROR :: OPEN :: LINP
UT :: COUNT :: DELETE$ :: ST
ARTCOL :: LENGTH :: ACCEPT A
T :: STARTROW :: ENDROW :: R
OW :: A$ :: A1$ :: A2$ :: A3
$ :: END
210 !@P-
220 CALL CLEAR :: CALL SCREE
N(5):: FOR COUNT=0 TO 14 ::
CALL COLOR(COUNT,16,5):: NEX
T COUNT :: READ A$
230 RVCHAR$="B0B0B0B0B0B0B0B
0" :: LVCHAR$="0101010101010
101" :: BHCHAR$="FF000000000
0000000" :: THCHAR$="0000000
0000000OFF"
240 CALL CHAR(91,RVCHAR$)::
CALL CHAR(93,LVCHAR$):: CALL
CHAR(123,BHCHAR$):: CALL CH
AR(125,THCHAR$)
250 CALL HCHAR(1,3,125,28)::
CALL HCHAR(7,3,125,28):: CA
LL VCHAR(2,2,93,22):: CALL V
CHAR(2,31,91,22):: CALL HCHA
R(24,3,123,28)
260 !*****
270 FNAME$="TEST" ! PUT WHAT
EVER FILE NAME YOU WANT IN
HERE OR LEAVE IT BLANK BUT R
EMEMBER YOU ONLY CAN USE NIN
E CHARACTERS
280 !*****
290 DISPLAY AT(3,4):"DELETE
COLUMNS UTILITY" :: DISPLAY
AT(6,14):A$ :: DISPLAY AT(10
,5):"FOR DIS/VAR 80 FILES"
300 DISPLAY AT(14,2):"Rows i
n File : " :: DISPLAY AT(12,2
):"File Name :";" ";FNAME$ :

```

```

: DISPLAY AT(16,2):"Delete C
olumns 'YN':";" ";"Y"
310 DISPLAY AT(18,2):"Startc
ol-Length :";" 00";"-";"00"
:: DISPLAY AT(20,2):"Startro
w-Endrow :";" 00";"-";"00" ;
: DISPLAY AT(23,8):""Use Dri
ve 1""
320 ACCEPT AT(12,14)SIZE(-9)
BEEP:FNAME$
330 ON ERROR 630
340 DELETE "DSK1."&FNAME$&"*
" ! DELETE LIKE FILE NAMES S
O NO ERROR WILL OCCUR
350 ON BREAK NEXT
360 COUNT=0
370 OPEN #1:"DSK1."&FNAME$,D
ISPLAY ,VARIABLE 80,INPUT
380 OPEN #2:"DSK1."&FNAME$&"
*",DISPLAY ,FIXED 80,RELATIV
E
390 LINPUT #1:A$
400 IF EOF(1)THEN 440
410 COUNT=COUNT+1
420 PRINT #2:A$
430 GOTO 390
440 DISPLAY AT(14,16):COUNT
450 CLOSE #1
460 ACCEPT AT(16,23)SIZE(-1)
VALIDATE("YN")BEEP:DELETE$
470 ACCEPT AT(18,20)VALIDATE
(DIGIT)SIZE(-2)BEEP:STARTCOL
:: ACCEPT AT(18,23)VALIDATE
(DIGIT)SIZE(-2)BEEP:LENGTH
480 IF STARTCOL>80 OR(STARTC
OL+LENGTH)>81 THEN 470
490 ACCEPT AT(20,20)VALIDATE
(DIGIT)SIZE(-2)BEEP:STARTROW
:: ACCEPT AT(20,23)VALIDATE
(DIGIT)SIZE(-2)BEEP:ENDROW
500 IF STARTROW>COUNT OR EN
DROW>COUNT THEN 490 ELSE IF E
NDROW=0 THEN 620
510 FOR ROW=STARTROW-1 TO EN
DROW-1
520 LINPUT #2,REC ROW:A$
530 IF STARTCOL=1 THEN A1$=""
" :: GOTO 550
540 A1$=SEG$(A$,1,STARTCOL-1
)
550 A2$=SEG$(A$,STARTCOL,LEN
GTH):: A3$=SEG$(A$,STARTCOL+
LENGTH,81-(STARTCOL+LENGTH))
560 IF DELETE$="Y" THEN A2$=""
ELSE A2$=RPT$(" ",LENGTH)

```

```

570 A$=A1$&A2$&A3$
580 PRINT #2,REC ROW:A$
590 NEXT ROW
600 IF DELETE$="Y" THEN A$=""
COLUMNS DELETED" ELSE A$=""CO
LUMNS ERASED"
610 CLOSE #2 :: CALL CLEAR :
: DISPLAY AT(10,7):A$::;TAB
(6);"NEW FILE NAME IS";::;
;TAB(10);"";FNAME$&"*";""
:: FOR COUNT=1 TO 200 :: NEX
T COUNT :: END
620 CLOSE #2 :: DISPLAY AT(1
4,16):" " :: ON BREAK ST
OP :: GOTO 320
630 CALL CLEAR :: DISPLAY AT
(10,9):"FILE ERROR" :: FOR C
OUNT=1 TO 200 :: NEXT COUNT
:: RUN
640 !@P+

```

Turning assembly into CALL LOADs

Last month's User Notes included an assembly program to allow paging of screens from Extended BASIC. Included was an Extended BASIC listing of CALL LOADs. The following program, called "ACE" for Assembly Converter to Extended BASIC, is what we used to convert the assembly object code into CALL LOADs. The program was downloaded from the TexNet database on The Source. Although TexNet has been discontinued, many programs from the TexNet library are now available through TISIG on The Source.

The program requires Extended BASIC, a disk system and memory expansion. The program prompts for all input, including the name of the assembly file to be converted into Extended BASIC and the output file name. Any assembly program to be converted must be suitable for an Extended BASIC environment. Also, the assembly file must not contain any AORGs.

```

100 ! Assembly Object to Ext
ended Basic CALL LOADs Conve
rter
110 GOTO 140 :: DIM STDEF$(1
00):: D$,N$,F$,DEF$,PB$,SC$,
R1$,CT$,L$,HEX$,H$,DSC$,DECC
(See Page 44)

```

User Notes

(Continued from Page 43)

```

$,PROG$
120 CALL LOAD :: CALL INIT :
: CALL LINK :: CALL PEEK ::
CALL CHAR :: CALL HCHAR :: C
ALL KEY
130 AUT,N,A,B,C,D,E,F,G,H,I,
L,M,N,CT,MS,LS,DBM,DBL,FINEL
OC,LOC,INIZLOC,INDEF,NDEF,NL
INK,NL,NLINE,NST,KY,ST,DEC,P
O,Z
140 CALL CLEAR :: CALL SCREE
N(5):: FOR T=0 TO 14 :: CALL
COLOR(T,16,5):: NEXT T :: !
2P-
150 CALL CHAR(128,"00282828"
,131,"000000FF"):: L$=RPT$(C
HR$(131),28):: H$="012345678
9ABCDEF" :: CALL CLEAR
160 PB$=" "
170 DISPLAY AT(4,1):TAB(8);"
Assembly":TAB(8);"Converter
to":TAB(8);"Extended Basic":
L$
180 DISPLAY AT(10,12):"ACE"
190 DISPLAY AT(14,1):L$:"ACE
converts the Object": "of an
Assembly Program into": "an
Extended Basic Program.": "th
e Assembly Program MUST be"
200 DISPLAY AT(19,1):"suitab
le for Extended Basic": "envi
ronment and MUST NOT": "conta
in any AORG.":L$
210 DISPLAY AT(24,6)BEEP:"Pr
ess any key"
220 CALL KEY(0,KY,ST):: IF S
T=0 THEN 220 ELSE CALL CLEAR
230 DISPLAY AT(1,1):L$:TAB(5
);"Are the Assembly": "Object
s already loaded?": : " Ans
wer: (Y/N) N":L$
240 ACCEPT AT(5,17)SIZE(-1)VA
LIDATE("YN")BEEP:RI$ :: IF
RI$="" THEN 150 ELSE IF RI$=
"Y" THEN CALL CLEAR :: GOTO
490 ELSE N$="1" :: CT$="Y" :
: GOSUB 1040
250 DISPLAY AT(6,1):L$:"Inse
rt the diskette with the": "a
ssembly object and enter": "t
he object progr. name": : "Na
me : ";PROG$:L$
260 DISPLAY AT(22,1):L$:"era
se and press ENTER if you":T
AB(9);"are through"
270 ACCEPT AT(11,9)SIZE(-10)
BEEP:PROG$ :: IF PROG$="" TH
EN CALL CLEAR :: GOTO 430
280 DISPLAY AT(13,1):"Disk D
rive ? (1-3) ";N$:L$ :: ACCE
PT AT(13,20)SIZE(-1)VALIDATE
("123")BEEP:N$ :: IF N$="" T
HEN 230
290 ON ERROR 470 :: CALL LOA
D("DSK"&N$&". "&PROG$):: ON E
RROR STOP
300 DISPLAY AT(15,1):"Do you
want to check the": "loaded
program ? (Y/N) ";CT$:L$ ::
ACCEPT AT(16,24)SIZE(-1)VALI
DATE("YN")BEEP:CT$ :: IF CT$
="N" THEN 250
310 DISPLAY AT(18,1):"Does t
he program come back": "to Ex
tended Basic ? (Y/N) Y":L$ :
: ACCEPT AT(19,27)SIZE(-1)VA
LIDATE("YN")BEEP:SC$
320 IF SC$="Y" THEN 340 ELSE
FOR T=1 TO 10 :: DISPLAY AT
(21,1)BEEP:"In this case no
check": "is possible ":L$:L$
330 FOR I=1 TO 100 :: NEXT I
:: CALL HCHAR(21,1,32,96)::
NEXT T :: GOTO 250
340 CALL PEEK(8196,A,B):: NS
T=0 :: INDEF=A*256+B :: FOR
T=16376 TO INDEF STEP -8 ::
NL=T :: GOSUB 1010 :: NST=NS
T+1 :: STDEF$(NST)=DEF$ :: N
EXT T
350 CALL CLEAR :: A=0 :: D$=
"1"
360 DISPLAY AT(1,1):L$:"List
of DEFS to choose from": "fo
r checking purposes":L$
370 FOR T=5 TO 20 STEP 2 ::
FOR Z=1 TO 19 STEP 9 :: A=A+
1 :: DISPLAY AT(T,Z)BEEP:A;S
TDEF$(A):: IF A>NST THEN 38
0 ELSE NEXT Z :: NEXT T
380 DISPLAY AT(T+1,1):L$ ::
DISPLAY AT(20,1):L$:"DEF No.
? (1 -";NST;") ":L$:"Press
ENTER when finished":L$:"Pre
ss ENTER when finished":L$
390 ACCEPT AT(21,21)VALIDATE
(DIGIT)SIZE(-2)BEEP:D$ :: IF
D$(">)" THEN 450
400 CALL CLEAR :: DISPLAY AT
(1,1):L$:"Are the programs l
oaded": : "so far OK. ? (Y/N)
Y":L$ :: ACCEPT AT(4,20)VAL
IDATE("YN")SIZE(-1)BEEP:SC$
:: IF SC$="Y" THEN 430
410 DISPLAY AT(6,1):L$:"Unfo
rtunately in this case": : "i
t's not possible to": : "elim
inate just one program": : "b
ut it's necessary to load"
420 DISPLAY AT(15,1):"all th
e program(s) all ": : "over a
gain.": : "OK? (Y) Y":L$ :: A
CCEPT AT(19,9)VALIDATE("Y")S
IZE(-1)BEEP:SC$ :: CALL INIT
:: CALL CLEAR :: GO TO 250
430 DISPLAY AT(6,1):L$:"Are
all the programs": : "loaded
already ? (Y/N) Y":L$ :: ACC
EPT AT(9,24)VALIDATE("YN")SI
ZE(-1)BEEP:SC$
440 IF SC$="N" OR SC$="" THE
N CALL CLEAR :: GOTO 250 ELS
E 490
450 A=VAL(D$):: IF A>NST THE
N 380 ELSE CALL LINK(STDEF$(
A)):: GOTO 350
460 ! Error handling
470 FOR T=1 TO 8 :: DISPLAY
AT(20,1)BEEP:L$:TAB(6);"Driv
e error or":TAB(6);"Program
name error":L$:L$ :: FOR I=1
TO 100 :: NEXT I
480 CALL HCHAR(20,1,32,128):
: NEXT T :: RETURN 250
490 CALL CLEAR
500 ON ERROR 530 :: CALL PEE
K(8194,A,B,C,D):: FINELOC=A*
256+B :: NL,INDEF=C*256+D ::
GOSUB 1010
510 IF ASC(DEF$)=255 THEN 53
0 ELSE INIZLOC=DBM*256+DBL
520 ON ERROR STOP :: GOTO 56
0
530 CALL CLEAR :: FOR I=1 TO
10 :: DISPLAY AT(10,1)BEEP:
L$:L$:" The Assembly Progra
ms": : " have not been load
ed": :TAB(10);"LOAD THEM!":L
$:L$
540 FOR T=1 TO 100 :: NEXT T
:: CALL HCHAR(12,1,32,160):
: NEXT I :: GOSUB 1040 :: GO
TO 250
550 !Disk-printing routine
560 CALL CLEAR :: GOSUB 930
:: IF F$="" OR N$="" THEN 32
(See Page 45)

```

User Notes

(Continued from Page 44)

```

767 :: ON ERROR 980 :: GOSUB
1060 :: OPEN #2:"DSK"&N$&".
"&F$,VARIABLE 163 :: ON ERRO
R STOP :: N=0
570 !Address of the programm
er
580 PRINT #2:CHR$(0)&CHR$(N)
&CHR$(131)&CHR$(199)&CHR$(LE
N(PB$))&PB$&CHR$(0):: N=1 ::
GOSUB 1090
590 !Insert CALL INIT
600 PRINT #2:CHR$(0)&CHR$(N)
&CHR$(157)&CHR$(200)&CHR$(4)
&"INIT"&CHR$(0):: N=2 :: LOC
=INDEF :: GOSUB 1090
610 ! DEFs name printing
620 FOR NDEF=INDEF TO 16376
STEP 8
630 PRINT #2:CHR$(0)&CHR$(N)
&CHR$(157)&CHR$(200)&CHR$(4)
&"LOAD"&CHR$(183)&CHR$(200)&
CHR$(LEN(STR$(NDEF))&STR$(N
DEF);
640 FOR LOC=NDEF TO NDEF+6 S
TEP 2
650 CALL PEEK(LOC,MS,LS):: P
RINT #2:CHR$(179)&CHR$(200)&
CHR$(LEN(STR$(MS))&STR$(MS)
&CHR$(179)&CHR$(200)&CHR$(LE
N(STR$(LS))&STR$(LS);
660 NEXT LOC
670 PRINT #2:CHR$(182)&CHR$(
0):: GOSUB 1090 :: N=N+1 ::
NEXT NDEF
680 !Print DEF pointer and F
FALM
690 PRINT #2:CHR$(0)&CHR$(N)
&CHR$(157)&CHR$(200)&CHR$(4)
&"LOAD"&CHR$(183)&CHR$(200)&
CHR$(LEN(STR$(8194))&STR$(8
194);
700 FOR LOC=8194 TO 8196 STE
P 2
710 CALL PEEK(LOC,MS,LS):: P
RINT #2:CHR$(179)&CHR$(200)&
CHR$(LEN(STR$(MS))&STR$(MS)
&CHR$(179)&CHR$(200)&CHR$(LE
N(STR$(LS))&STR$(LS);
720 NEXT LOC
730 PRINT #2:CHR$(182)&CHR$(
0):: GOSUB 1090 :: N=N+1 ::
LOC=9460
740 ! Main program printing
750 PRINT #2:CHR$(0)&CHR$(N)
&CHR$(157)&CHR$(200)&CHR$(4)
&"LOAD"&CHR$(183)&CHR$(200)&
CHR$(LEN(STR$(LOC))&STR$(LO
C);
760 FOR LOC=LOC TO LOC+20 ST
EP 2
770 IF LOC>FINELOC THEN 800
:: CALL PEEK(LOC,MS,LS):: PR
INT #2:CHR$(179)&CHR$(200)&C
HR$(LEN(STR$(MS))&STR$(MS)&
CHR$(179)&CHR$(200)&CHR$(LEN
(STR$(LS))&STR$(LS);
780 NEXT LOC
790 PRINT #2:CHR$(182)&CHR$(
0):: GOSUB 1090 :: N=N+1 ::
IF LOC<=FINELOC THEN 750 ELS
E 810
800 PRINT #2:CHR$(182)&CHR$(
0):: GOSUB 1090
810 N=N+1
820 !CALL LINK printing
830 FOR NLINK=INDEF TO 16376
STEP 8 :: NL=NLINK :: GOSUB
1010
840 PRINT #2:CHR$(0)&CHR$(N)
&CHR$(157)&CHR$(200)&CHR$(4)
&"LINK"&CHR$(183)&CHR$(199)&
CHR$(LEN(DEF$))&DEF$&CHR$(18
2)&CHR$(0):: GOSUB 1090
850 N=N+1 :: NEXT NLINK
860 PRINT #2:CHR$(255)&CHR$(
255):: CLOSE #2
870 CALL CLEAR
880 DISPLAY AT(5,1)BEEP:L$:"
The assembly program ";DEF$:
:"has been recorded as a":
:"DIS/VAR 163 file. The name
": "of this file is ";F$:L$
890 DISPLAY AT(14,1):"You ca
n MERGE this file": "and ob
tain an Ext.B.Program":L$:"E
xecute now in command mode:"
: "NEW":)MERGE DSK";N$;".
";F$
900 FOR T=1 TO 70 :: DISPLAY
AT(23,1)BEEP:)"SAVE DSK";N$
;".";SEG$(F$,1,LEN(F$)-3)&"E
XT":L$ :: CALL KEY(0,KY,ST):
: IF ST<>0 THEN STOP
910 NEXT T :: END
920 !Open file: disk drive
& name selection
930 DISPLAY AT(1,1):L$:"Name
of the last DEF": "of the as
sembly programs": "loaded i
n memory ";DEF$:L$
940 F$=DEF$&"MRG" :: DISPLAY
AT(8,1):L$:"proposed name f
or the file": "Max 10 chara
cters ";F$:L$ :: ACCEPT AT
(11,19)SIZE<-10)BEEP:F$
950 IF F$="" THEN RETURN ELS
E IF POS(F$," ",1)>0 OR POS(
F$,".",1)>0 THEN 940
960 DISPLAY AT(14,1):L$:"Dis
k Drive? (1-3) ";N$:L$ :: AC
CEPT AT(15,19)VALIDATE("123"
)SIZE<-1)BEEP:N$ :: RETURN
970 !Sub file error
980 ON ERROR 990 :: CLOSE #2
990 RETURN 560
1000 !call peek DEF names
1010 CALL PEEK(NL,E,F,G,H,I,
L,DBM,DBL):: DEF$=CHR$(E)&CH
R$(F)&CHR$(G)&CHR$(H)&CHR$(I
)&CHR$(L)
1020 PO=POS(DEF$," ",1):: IF
PO>0 THEN DEF$=SEG$(DEF$,1,
PO-1):: RETURN ELSE RETURN
1030 !Sub CALL INIT once onl
y
1040 IF CT=1 THEN RETURN ELS
E CALL INIT :: CT=1 :: RETUR
N
1050 ! Sub # of necessary pr
intings
1060 NLINE=ABS(INT<-((FINELO
C-9460)/22+(16384-INDEF)/4+3
))
1070 DISPLAY AT(17,1)BEEP:"T
he necessary Printing": "oper
ations with Disk Drive": "(
max 172) will be";NLINE:L$
1080 IF NLINE>172 THEN FOR T
=1 TO 10 :: FOR I=1 TO 90 ::
NEXT I :: CALL HCHAR(23,1,3
2,32):: DISPLAY AT(22,1)BEEP
:L$:"OBJECT SIZE IS TOO LARG
E":L$ :: NEXT T :: STOP ELSE
RETURN
1090 NLINE=NLINE-1 :: DISPLA
Y AT(21,1):L$:"# of printing
s yet to be": "executed will
be";NLINE:L$ :: RETURN

```

User Notes is a column of tips and ideas designed to help readers put their home computers to better use. The information provided here comes from many sources, including TI home computer user group newsletters. MICROpendium will pay \$10 for any item sent in by readers that appears in this column. Mail tips to: MICROpendium, P.O. Box 1343, Round Rock, TX 78680.

Classified

Software

DISK ONLY SOFTWARE

- Lotto Mania—Lottery Game—\$19.95
- Shopping List—Grocery List Utility—\$13.95
- Flying Fortress—Flight Simulator—\$19.95
- Karate—Action Game—\$14.95
- Protest—Educational Test Builder—\$17.95
- RLE Pictures—Public Domain, Volumes 1-10—\$6.00 per volume
- Currency Exchange—Monetary Exchange—\$17.95
- Dragon Storm/Piranha—Action Games—\$14.95
- The Orphan Survival Handbook—\$17.95

Disk Only Software

Software

P.O. Box 244

Lorton, Virginia 22079

or call 1-800-445-4462. At the tone, enter 897335 for recorded order message. Touchtone phone is required. Alternate is (301) 369-1339. No Touchtone is required. Delphi: TELE-DATA—CompuServe: 74405,1207—MCI: TDG—TELEX: 6501106897 MCI Canadian personal checks, at fair exchange rate, welcomed. v4,n3

MULTIPLAN TAX TEMPLATES

Sch. 1040, A,B,C,D,E SE W Print on Forms \$10 add \$5 for Ca. Jim Sleeth, P.O.B. 20723 El Cajon, Ca. 92010v4,n3

CHECKBOOK RECONCILE

ROCKETMAN Checkbook Program, \$29.95. Requires 1 disk drive, 32K, Extended BASIC. Write or call California Programs, 4014 San Pablo Dam Rd., El Sobrante, Ca. 94803. 415-222-1626. California residents add 6.5% sales tax. Visa or MasterCard accepted. v4,n6

TUNNELS OF DOOM OWNERS!

Three exciting games for the TOD module packed on one SS/SD disk! New graphics, characters and stories combined with the module's 3D graphics and fantasy action. Requires TOD module, disk. \$7.95 & \$.75 S&H. Asgard Software, Box 10306, Rockville, MD 20850. v3,n3

UNIQUE ACTION GAME

Balloon Wars is an extensive, 30 screen strategy/action game! Pilot your balloon with joystick, skill and luck across the desert—avoiding enemies. Requires XB, Disk. \$9.95 & .75 S&H. Asgard Software, Box 10306, Rockville, MD 20850. v3,n3

MANAGE YOUR BUSY SCHEDULE

Schedule Manager is the only comprehensive schedule program for the 99/4A that features a 3 month schedule per person, notebook for names and addresses, and calendar. Manage any number of schedules! Macintosh-like ease-of-use with help screens. Full 16 page manual. \$14.95 & .75 S&H

Software

(originally \$29.95) Asgard Software, Box 10306, Rockville, MD 20850.v3,n2

TIGERCUB SOFTWARE

Over 130 original entertainment, education and programming utility programs in BASIC and X BASIC on cassette or disk, only \$3 each! 18 different full-disk collections, just \$12 each! Descriptive catalog \$1 refundable. TIPS FROM TIGERCUB full-disk collections of 50+ programs and files from Tigercub Tips newsletters, Vol. I, II, III and IV., \$15 each, any two \$27, any three \$35, all four \$42, postpaid. NUTS & BOLTS (#1) and #2, full disks of 100+ utility subprograms in X BASIC Merge format, ready to merge into your own programs, \$19.95 each, both for \$37, with documentation, postpaid. 156 Collingwood Ave., Whitehall OH 43213.v4,n2

FROM GEMBAR GRAPHICS

The following titles are available for \$13.95 each: GEMINI TICKLER or EPSON RX-80 TICKLER (Menu driven printer set-up programs); DERBY DAY (Sprite-action horse racing program with pari-mutuel betting); BELLS, BARS, AND RATCHETS (set of Assembly Language enhanced 3-reel and 4-reel slot machines); WORLD CAPITALS (multiple choice—musically enhanced). The following are available for \$19.95 each: MATRIX CALCULATOR (operates on matrices up to size 10 by 10); VOCABULARY BUILDING (three-diskette set of 1200 college level words). All programs are on diskette and require XB (except Bells, Bars, and Ratchets which requires E/A) and the expansion system. Please add \$1.50 to each order for Postage and Handling. Florida residents add 5%. GEMBAR GRAPHICS, 455 Amherst Circle East, Satellite Beach, FL 32937. v4,n2

ARTIST-ART #1

Original NEW Graphic Clipart for TI-ARTIST (v2.0 and up). Included are 12 Fonts, and 80 large and small instances. \$11.50 (NO P&H) GENESIS SYSTEMS SOFTWARE, 9589 VIA PEREZA, SAN DIEGO, CA 92129 v4,n2

JOY PAINT

"...over all, the program is fantastic!
...a truly great graphics program..."
-MICROpendium.

"...the slickest, easiest to operate, most
eye-catching graphics program yet..."
-Mid South
99/4a Users Group

JOY PAINT '99	
Comes with clip art disk #1	\$39.95
JOY PAINT'S PAL	\$9.95
CLIP ART DISK #2	\$9.95
CLIP ART CO-OP	Inquire
BANNER '99	\$19.95
EXTENDED BUSINESS GRAPHS II	\$24.95

Great Lakes Software
804 E. Grand River Ave.
Howell, MI 48843
Order /Info line 517-546-0566

Support
Our
Advertisers

Classified

Software

BASICSORT SORT PROGRAM

Version 2 of the super-fast BasicSort utility sort program is now available. Sorts on up to 16 numeric, string, or string segment fields, ascending or descending sequence. Sorts that used to take 30 minutes in Extended BASIC now run in 3-4 seconds! Comes with extensive documentation on disk. Order by sending \$15.00 plus \$3.00 for Shipping/Handling to: Andreas L. Dessoff, 1041 Church Hill Road, Fairfield CT 06432. v4,n2

THE PRINTER'S APPRENTICE

McCann Software offers the most powerful "print program" for the TI-99/4A. Version 2.00 is now available. Registered owners of an earlier version: upgrade is \$3.00 if you send in your original system disk. The upgrade includes new version documents, copying and return mailing. This version is much easier to use and includes the "Jotter" word processor for easy text creation. Our current price list: The Printer's Apprentice (TPA)\$22.50
TPA Fonts Disk One.....\$11.50
And, as reviewed with As in MICROpendium,
Business Graphs 99.....\$15.95
McCann Software also announces the release of its first fairware offering, 99-Animator. 99-Animator is a menu driven animation system which is fast... It can cycle twenty-one frames of animation at blinding speed. A programmable mode lets you auto-animate as many objects as will fit on the animation screen and full editing features allow you to create show stoppers. Send \$10 for disk and mailer to: McCann Software, P.O. Box 34160, Omaha, NE 68134. v4,n2

MOVE OVER MAX!

(1.) YAK-MAN TALKS!—Says anything you type! Many different voices and remarkable "one touch" features. (2.) STATES AND CAPITALS GAME, 1-2 P, Impressive On-Screen Map! (3.) BIBLE BOOKS GAME, 1-2 Players. (4.) BIBLE TRIVIA GAME, 1-6P, ALL NEW! (YAK-MAN Requires Speech Synthesizer and

Policy

The cost of classified advertising is 25 cents per word. Classified display (i.e., special formatting or graphics) is \$9 per column inch. Classified advertisements must be paid in advance. Classified advertisers may request a category under which they would like their advertisement to appear, but the final placement decision is the responsibility of the publisher.

Classified deadlines will be kept open for as long as practical. For the purpose of classified advertising deadlines, any classified ad received later than the first day of any month cannot be assured of placement in the next edition. We will do our best to include every advertisement that is submitted in the earliest possible edition.

The publisher offers no guarantee that any advertisement will be published in any particular issue. Any damages that result either from errors in copy or for failure to be included in any particular edition will be limited to the amount of the cost of the advertisement itself. The publisher reserves the right to reject any advertisement.

The advertiser may elect to publish the advertisement in subsequent editions at the same charge, payable prior to publication. The deadline for carryover classifieds is the same as for new advertising.

In submitting an ad, please indicate whether you would like a refund if it is not published in the requested edition or whether you would like us to hold it for the next edition. Cancellations and refunds cannot be made after the second day of the month.

Send classified advertising to: MICROpendium, P.O. Box 1343, Round Rock, TX 78680.

Software

TE-II. OTHERS NEED NO EXTRAS!) Satisfaction Guaranteed! \$14.95 each, ANY 2 FOR \$19.95, ALL 4 FOR \$29.95! TRINITY SYSTEMS, 1022 Grandview, Pittsburgh, PA 15237. v4,n4

Hardware

YOUR HORIZON RAM DISK KIT ASSEMBLED \$20.00. Other kits comparable. Mack's Techie Boards assembled by hour or job. Gary R. Moore, 1103 South Lafayette, Neosho, Missouri 64850. v4,n2

FOR SALE

RS232+32K Stand Alone \$129.95, RF Modulators \$7.95, Cassette/Joystick Extension Cord, \$4.95, Volksmodem + Cable + TEII, \$59.95. Add \$3.00 Shipping & Handling. MC/VISA Call 216-339-5463. Youngtree, P.O. Box 197, Leavittsburg, OH 44430. Catalog Sent with order or Send \$2.00 (Refunded with 1st Order). v4,n2

Miscellaneous

99/4A HDWE. & SOFTWARE

New P-Code Card V.4 with all books and disks \$150, console with books and cables \$65.
Full PE-Box, all genuine TI cards \$375.
Joystix, modem cables, printer cables, TI and Cat modems, printers, games and more.

Miscellaneous

Call or write to Jim Leshar, 722 Huntley, Dallas, TX. 75214, 214-821-9274. v4,n2

Texas Instruments

TI-99-4a

Hardware & Software

TI-Artist, MG, Myarc, Romox, Moonbeam, Asgard. Monitors, Modems, Cables, Printers, Books.

★ Joysticks by Amiga for the TI. \$12.00

★ Navarone Specials: Data Base MGR \$25

Homework Helper+, DiskFixer, Cartridge

Expander \$20 ea. TrackBall \$20 Speech

Editor \$20, Popeye & Qbert \$10 ea.

Hardware improvements: the 9928 VDP chip

improves monochrome display, and may be

used for RGB, great for monitors \$8.

Yes, we are adding new items every day.

If We Don't Have It, We Can Get It!

L.L. CONNER ENTERPRISE

COMPUTER & ELECTRONICS

1521 Ferry Street

Lafayette, IN 47904

Call 317-742-8146 or BBS 317-423-4879

Visa or M/C Accepted v4,n2

TI 99/4A GENERAL SUPPLIES

Hardware ★ Software ★ Accessories

Retail Store ★ Full Mail Order Service

We carry a full line of TI computer supplies. Call or write us for information

and to join our Mailing List—Free

★ VISA & Master Card Welcome ★

No Extra Charge!

No Handling Fees!

For Mail Order Services

Factory Authorized

Star Printer Service

Pilgrims' Pride Harboro, PA 19040

5 Williams La (215) 441-4262

Knowledgeable Service

Willing Support v4n2

The LEADING monthly devoted to the T199/4A

Subscription Fees

\$17 for 12 issues via domestic third class mail
\$20.50 for 12 issues via domestic first-class mail
\$20.50 (U.S. funds) for 12 issues Canadian or Mexican delivery
\$23.50 (U.S. funds) for 12 issues foreign delivery via surface mail
\$37.00 (U.S. funds) for 12 issues foreign delivery via air mail
(Texas residents add 87 cents sales tax)

Address Changes

Subscribers who move may have the delivery of their most recent issue(s) delayed unless MICROpendium is notified six weeks in advance of address changes. Please include your old address as it appears on your mailing label when making an address change.

Back Issue Policy

Back issues of MICROpendium are available to subscribers only. Those wishing back issues may notify us of the issue(s) desired and include \$1.50 per issue desired in a check or money order. (U.S., Mexico and Canada; Texas residents add 6.25% sales tax.) For foreign airmail delivery, add \$2 per issue, 50 cents per issue surface mail. All prices listed are U.S. funds.

OUT OF STOCK: Vol 1, Nos. 1-2

Send me the next 12 issues of **MICROpendium**. I am enclosing \$ _____ in a check or money order in U.S. funds (Texas residents add \$1.06 cents sales tax.) Mail to: MICROpendium, P.O. Box 1343, Round Rock, TX 78680

Name _____
Address _____
City _____
State _____ ZIP _____

v4,n2

The set of numbers on the right of your mailing label indicates the cover date of your last issue.

P.O. Box 1343, Round Rock, TX 78680

Postmaster: Address Correction Requested

FIRST-CLASS MAIL
U.S. POSTAGE PAID
ROUND ROCK, TX

Permit No. 533