

T7406 Cordless Telephone Installation Guide

Read all documentation before proceeding with installation of this unit.



Warning: First-time battery charge

Follow this procedure for the first-time charge of your handset battery packs and when you first set up your T7406 system. Failure to follow all of these steps can result in operational difficulties.

Ensure that the battery pack is fully charged before you attempt to use your T7406 handset for the first time.

- Charge the battery pack in the rear port of the charger for a minimum of 30 minutes.
- Install the battery pack in the handset.
- Put the handset into the front port of the charger and charge the battery pack in the handset for a minimum of three hours.
- Trickle charge a spare battery pack in the rear battery port of the charger for 12 hours.

Ensure you configure the handsets in an orderly fashion. If you are configuring a number of handsets, ensure the battery packs for all the handsets are charged before you start configuring the handsets to the base station.

Refer to [Handset Configuration](#) on page 27.

© 2002, Nortel Networks, Nashville, TN 37228. ALL RIGHTS RESERVED.

For further information, call your technical support team or a Nortel Networks Sales representative.

Nortel, the Nortel globemark, Norstar, and Business Communications Manager are trademarks of Nortel Networks. All other trademarks are property of their respective owners. All information is subject to change. Nortel Networks reserves the right, without notice, to change its products as progress in engineering or manufacturing methods or any other circumstances may warrant.

Contents

Provisioning the T7406	7
Operational Bandwidths	7
Operational Parameters	7
Installation Site Parameters	8
RF LANs (Radio Frequency Local Area Networks) ..	9
Telephone-to-Base Range	9
Environmental Layout Considerations	10
Environments Unsuitable for the T7406	12
Powering the T7406	13
Battery Charge Controller	13
Specifications	14
Important battery pack information	15
About your T7406 telephone	16
Radio range and coverage considerations	16
Security of Conversation	16
Density and Interference	16
Spare Parts	17
T7406 Parts Lists	17
Handset Overview	18
Handset Signal Detection	19
Handset Features	20
Installing the Base Station	21
Base Station Features	21
Antenna	21
Mounting Bracket	22
T7406 Pre-installation Programming	22
Before you start	23
Mounting and Connecting the Base Station ...	23

Charging the T7406 Battery Pack	24
First-time Charging	25
Handset Power	26
Low battery	26
Recharge	26
Battery levels	27
Handset Configuration	27
Important First-time Installation Information	27
Identifying the Handsets to the System	28
Assigning the Handset to the Base Station ...	29
Using the Handset Display Buttons	30
Configuring the First Handset to a Base Station	30
Configuring the Handset ID Number	30
Changing the Handset ID Password	31
Assigning the Security Code	32
Configure the next handset to the base station	33
Setting Handset Features	33
Ring Type	33
Ringer Volume	34
Lock Handset	34
Language	35
Handset System Feature Notes	35
Button Mapping on the Handset	37
Memory buttons	38
Programming memory buttons	39
Button Inquiry	40
System Feature codes	40
Handset Asleep (Save Battery Mode)	41
Handset Asleep Mode Feature Conditions ..	41
Make and Answer Calls	42
Make a call	42
Answer calls	42

Hold calls	43
Mute microphone	43
Page	43
Customize a handset	44
Backlight On/Off	44
Helpful hints	44
Cleaning battery contacts	45
Installing the T7406 Handset Accessories	46
Optional accessories	48
Leather carrying cases	48
Headset Compatibility	48
Headset installation	49
Regulatory information	50
Canadian Regulations	50
US Regulations	50
Federal Communications Commission (FCC)	
Notice	50
EMI/EMC (FCC Part 15)	51
For Class A Host equipment	51
For Class B Host equipment	52
Safety	52
Important Safety Instructions	52
Installation	53
Use	53

Provisioning the T7406

This chapter provides specification and provisioning information for the T7406 cordless system.

The T7406 is a Frequency Hopping Spread Spectrum (FHSS) cordless telephone. The benefits of this technology are: improved range, robustness and, less susceptibility to interference, fading and multipath. The use of a common wall-mounted base station for multiple handsets allows you to position the base antennas for maximum performance and coverage. The indoor range of the T7406 is 95 meters (300 feet) in a typical office environment. This range may vary with differing environments.

Operational Bandwidths

The T7406 cordless telephone operates in the ISM (Industrial, Scientific, and Medical) 902-928 MHz band. The T7406 divides the ISM band into two sets of operating frequencies to allow the coexistence of other ISM devices. Examples of these products are SKU scanners and remote controls for products such as garage door openers and home theatre systems. Note that, since the T7406 is a frequency hopper, it uses at least half of the available frequencies in the ISM band for operation and can make it difficult for other 900 MHz devices to operate correctly. The following table identifies the frequencies used for the upper and lower bands of operation:

- Lower: 902 - 915 MHz
- Upper: 915.1 - 928 MHz

These bands are selectable for each base station through dip switches located on the back of the T7406 base station. Each base station supports up to three handsets. Selection of the correct band for operation may minimize interference between devices.

Operational Parameters

For example, with a configuration of six handsets, two base stations are required (three handsets per base station). One base station will be set to the upper band, and the other base station will be set to the lower band.

Another example is an environment that already contains another 900 Mhz device (e.g. a scanner with 900 Mhz wireless connection to a LAN). In this environment, only one T7406 base station should be installed. Set the T7406 base station dip switch to the opposite band that the scanner is operating in.

Installation Site Parameters

Physical characteristics of the site where the T7406 is to be installed, or has been installed, must be evaluated to maximize the performance of the T7406 telephone. Outlined below are some of the most common characteristics to be considered:

- wood vs. metal construction
- metal vs. wood studs in wall construction
- thickness of concrete floors and walls (and type of covering, e.g. Metallic wall paper)
- number of floors and walls
- open office (cubicles) vs. closed office (floor to ceiling)
- steel partitions, elevator shafts, electric utility rooms
- RF LANs (Radio Frequency Local Area Networks), extensive machinery, computer equipment, and other cordless phones or wireless devices

Placement of the antenna is crucial for enhancing the performance of the T7406. Pick a central location and mount the antenna with the following guidelines:

- Attach the base station at least eight feet from the floor.
- Minimize the number of walls between the base station and handsets.
- Centralize the location of the base station to make the number of interfering walls equal in all directions.
- Do not mount the base station on an outside wall.
- Do not mount or place the base station outdoors.
- Adjust the antenna for optimal transmission by moving it through 90-degree angle planes (i.e. perpendicular to the wall, parallel to the wall, perpendicular to the floor, parallel to the floor)

RF LANs (Radio Frequency Local Area Networks)

RF LANs are primarily installed in large chain businesses such as retail and grocery where the RF LAN is used for inventory equipment.

With the correct selection of the T7406 operating band, the RF LAN operating at 900 MHz does not pose an operating issue for T7406 nor does the T7406 pose issues for the RF LAN with respect to data transmission capabilities. However, there may be instances where the T7406 user may hear an occasional slight audio click when operating in a RF LAN environment. This should not inhibit the user's ability to hold a normal two-way conversation using the T7406.

Telephone-to-Base Range

The T7406 cordless telephone utilizes an extremely efficient radio design to deliver the maximum possible range while complying with the governing rules of the Federal Communications Commission (FCC) and Industry Canada. The effective operating range within a site will largely depend on the environmental characteristics mentioned previously, such as building construction and internal layout of the site. Typically, the T7406 will provide an effective operating range of 95 meters (300 feet).

If the T7406 is not meeting this operating range, the following are some steps that can be taken to assist with the troubleshooting:

- Check surroundings for any other product that may be causing interference.
- Check environment for obstructions that may be limiting the range.
- Change the orientation of the base station antenna.
- Move the base station to another location.
- Select the alternate operating band of the T7406.

It is important to keep in mind that, based on environmental characteristics, the T7406 may not be the optimum solution for all users. If the desired level of mobility performance is not met, contact your authorized Nortel Networks distributor to discuss alternatives.

Environmental Layout Considerations

The following facility layouts are examples of reference building footprints for which the T7406 is most suited.

1. The Storefront

- under 929 square meters/10,000 square feet
- Open environments with few interior barriers

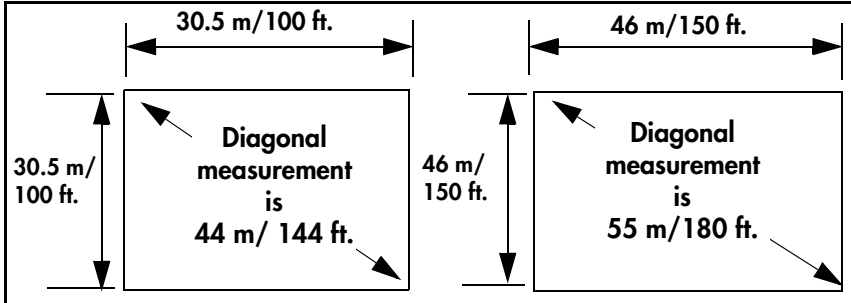

2. Office Facility

The T7406 can also be used in business with larger square footage and including an interior layout that has a higher concentration of physical barriers. Full radio coverage at these facilities takes more planning to work around possible barriers.

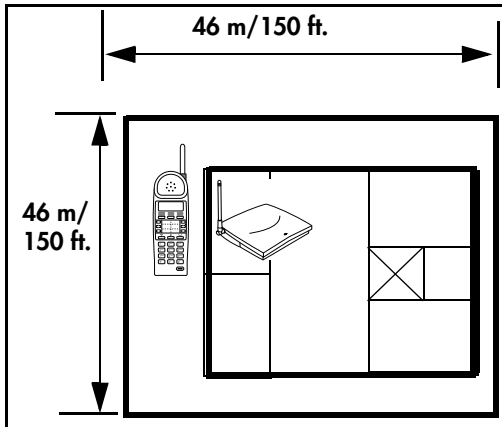

- Professional office
- Typically under 2,323 square meters/25,000 square feet.
- Usually mix of open and closed offices
- Typical office floor with elevator shaft and utility rooms in core of facility.

Some transmission path loss will occur when the base station and the

handset are separated by physical barriers, as represented by this core area.

The amount of path loss is dependent upon the number of walls and type of material and density of barriers utilized in the core area.

3. Combination Office/Warehouse

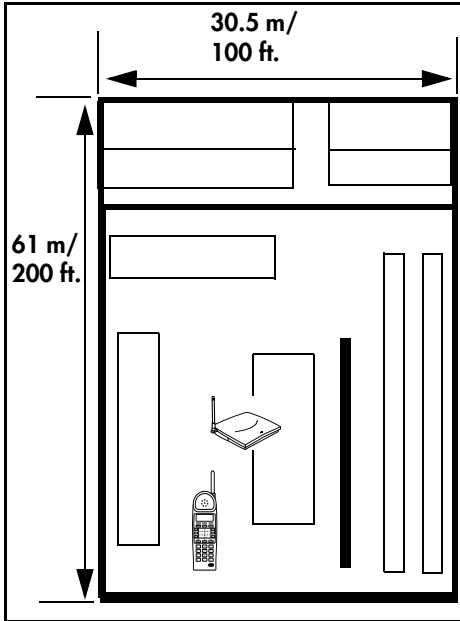

- Various Small Businesses
- Typically under 1,394 square meters/15,000 square feet

- Mixture of closed offices and open spaces

Typical facility with both office and warehousing combined in one operation. Some transmission path loss is expected with the presence of dense firewall and racking/shelves filled with dense materials. Consider placing base station in largest room.

Range will be limited in this situation.

4. Office with adjacent yard area(s)

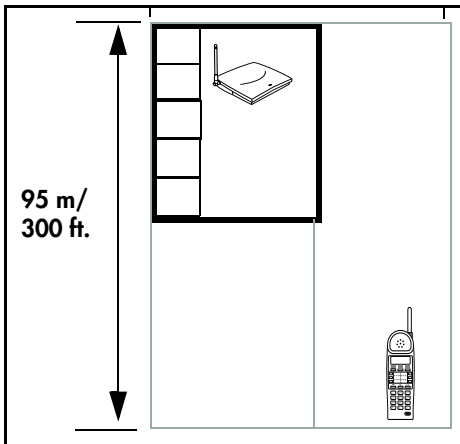

- Various small businesses
- Typical office facility 465 to 929 square meters. (5,000 to 10,000 sq. ft.)
- Adjacent open space or yard next to office
- Radio transmission will be relatively unimpaired in more open environments as path loss due to barriers such as walls and objects are minimized.

This environment may allow for ranges in excess of 95 m (300 ft.).

Environments Unsuitable for the T7406

Campus Environment (multiple buildings on one site)

The campus environment is not a suitable application for the T7406.

For this type of environment, contact your authorized Nortel Networks distributor to discuss alternatives.

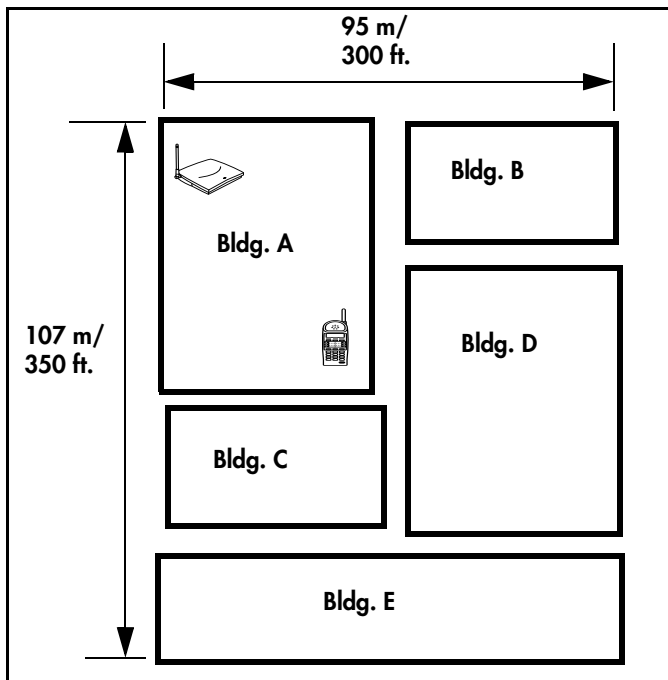

Powering the T7406

The T7406 design has taken into account the need to provide a reliably-powered cordless business telephone. The T7406 utilizes premium 1400 mAh NiMh batteries.

A fully charged 1400 mAh battery should provide four to five hours of talk time in a typical eight-hour day over, approximately, a three-year service life.

The T7406 has been engineered to provide the following talk-time parameters:

- T7406 users should feel comfortable using the handset for an entire workday without the need to put the handset back into the charger cradle for charging or topping up.
- Studies have shown that users have been able to get four to five hours of talk time from a fully charged 1400 mAh battery.
- Traffic studies have shown that typical users do not usually need more than three hours of talk time in an eight-hour day.
- If talk times exceed four hours or the product is to see use through multiple, consecutive shifts, multiple spare batteries are strongly recommended.

Battery Charge Controller

The T7406 incorporates a special handset battery charge controller that employs a four-stage charging program that sequences charging from a soft start to a fast charge, and then to a topping charge, followed by a maintenance charge.

This four-stage charge sequence presents an optimum-charging plan that helps maximize the overall life of the battery by managing two critical elements in the battery charging process, the charge rate and overcharging protection. Note that NiMh batteries do not exhibit memory problems and it is not necessary to drain the batteries prior to recharging.

Low battery status is indicated on the handset by the visual charge status on the display and/or the audible warning tone.

The T7406 handset can be placed back into the charge cradle for charging when it is not in use.

- A fully depleted 1400 mAh battery will be restored to full charge in three hours.
- The handset charge light will turn from red to green to indicate that the handset battery is fully charged and ready for use.
- The T7406 charge stand provides a rear port as a trickle charger that charges a fully depleted 1400 mAh battery in 12 to 14 hours.

Specifications

Frequency band	Half of the 900 MHz ISM band: either 902 to 915 MHz or 915.1 to 928 MHz
Total channel capability	Spread spectrum frequency hopping is available on 27 channels per base
Handset dimensions	Length: 170 mm/6.8 inches (without antenna) Width: 58 mm/2.32 inches Overall Thickness: 40 mm/1.60 inches
Handset range	Typical range of 95 m/300 feet, depending on the physical environment
Handset weight	280 g/9.38 oz. (with battery pack)
Battery Pack	Capacity: 1400 mAh, 3.6 V Talk Mode: up to five hours (with backlight OFF) Standby Mode: up to 72 hours
Base dimensions	Length: 150 mm/6 inches Width: 160 mm/6.4 inches Height (front): 28 mm/1.12 inches Height (rear): 34 mm/1.36 inches
Base power	Input: 110 VAC, 60 Hz Output: 9 VDC, 600 mA

Important battery pack information

Before you use the T7406 cordless handset, read the following information.

This unit contains a rechargeable nickel metal hydride battery:

- Follow the proper installation and charging procedures for the T7406 battery pack. Refer to [Charging the T7406 Battery Pack](#) on page 24.
- The rechargeable battery pack must be fully charged before you use the T7406 handset for the first time.
- It takes approximately three hours to charge a standard 1400 mAh battery pack.
- It takes approximately 12 hours to trickle charge the spare battery in the charging cradle.



Warning:

- The battery will explode if disposed of in a fire.
- Do not use the nickel metal hydride batteries provided with your T7406 cordless telephone with any other product. These batteries were designed specifically for use with the T7406 telephone and the T7406 charger ONLY. Improper use of the T7406 batteries may result in fire hazard.
- Do not do anything that would cause the battery to short circuit.
- Do not charge the battery with any charger other than the one supplied with this equipment.



WARNING

Nickel metal hydride batteries must be disposed of properly.
Do not dispose of the batteries in office or household waste.

Nickel metal hydride batteries are recyclable. You can help preserve the environment by returning your unwanted batteries to your nearest recycling center for recycling or proper disposal.

Phone 1-800-8-BATTERY to locate a Battery Recycling Center near you.

About your T7406 telephone

The T7406 is a multiple-handset, single-base cordless telephone system. The T7406 telephone provides a fully-integrated mobility solution for your business. The T7406 handset allows you to freely move around your work space while on a call, and still maintain access to all your telephone system features.

The T7406 telephone uses advanced digital frequency hopping spread spectrum (FHSS) technology to provide a quality audio path over a 900 MHz radio link. Establishing a call over a radio link is comparable to a wire line communication.

Note: The T7406 cordless telephone is supported on all Norstar systems (DR3 or higher) and on all Business Communications Manager systems.

Radio range and coverage considerations

The effective operating radio range in your facility depends on the building construction and the internal layout of the facility. Typically, a dense office or warehouse environment has an effective operating radio range of 95 meters (300 feet). An open office environment enhances operating radio ranges. Refer to [Provisioning the T7406](#) on page 7.

Security of Conversation

Each base station has a unique Security Code (S.S. Code). All three handsets registered to the base station must share the same Security Code. Each of the three handsets assigned to a base station must also have a unique identification (Set I.D. 1, 2 or 3).

Density and Interference

For this system to be interference-free, install a maximum of two base stations and six handsets per location. Each base station provides three independent time compression multiplexing (TCM) line connections to the telephone system.

Each base station uses half of the Industrial Scientific Medical (ISM) band for its frequency hopping channels. The dip switches on the base station allow you to assign the base station to use either the lower half (**902-915 Mhz**) or the upper half (**915.1-928 Mhz**).

Each base station must use a separate ISM half band. For more information about setting the dip switches, refer to [Installing the Base Station](#) on page 21.

If other devices operating on the ISM band interfere with the T7406 base, the other half of the band may be used to try to minimize interference. In this situation, install only one base station and three handsets per location.

Spare Parts

You can order spare parts for your T7406 telephone. For more information about spare parts, refer to [T7406 Parts Lists](#) on page 17. For more information about accessories, refer to [Optional accessories](#) on page 48. For more information about ordering, contact your system administrator.

T7406 Parts Lists

Along with this guide, the following items are included with the T7406 telephone.

System parts list

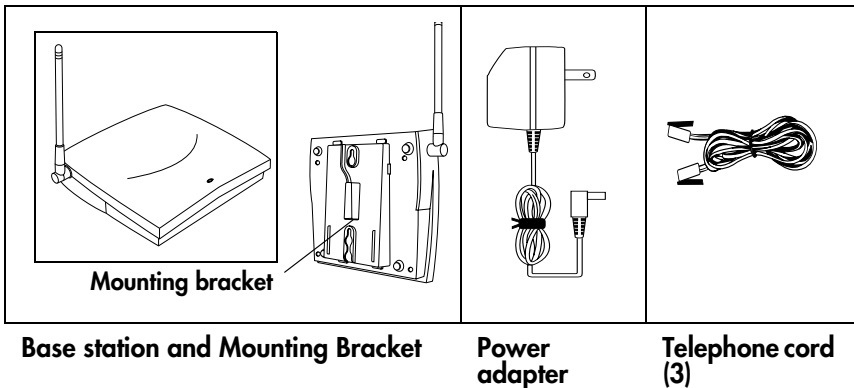

Handset parts list

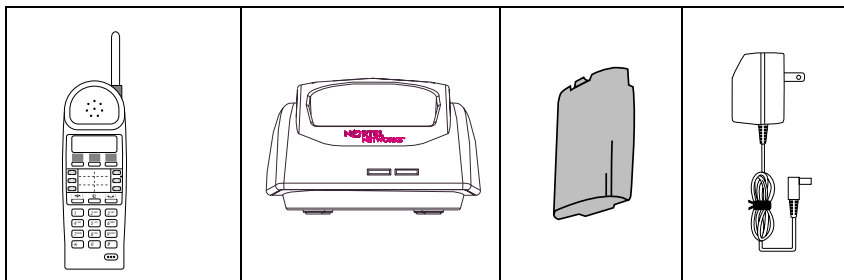
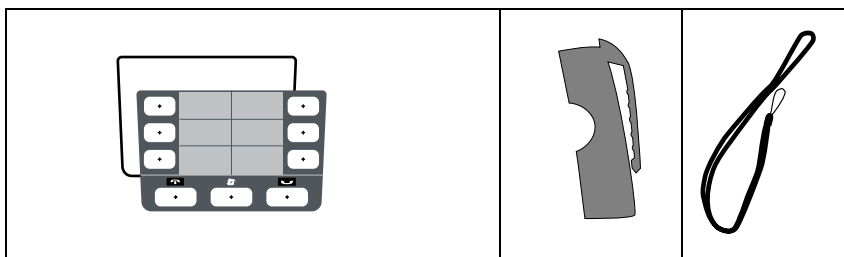
**Handset****Charger****Battery pack
(2)****Power
adapter****Handset card (2) and Plastic lens (1)****Belt clip****Wrist strap**

Handset Overview

The handset automatically links with the base station by searching for the base station signal when the following are completed:

- battery is charged
- base station and handset are powered
- handset identification is configured
- base station Security Code is assigned

Handset Signal Detection

You can monitor the handset signal strength while moving to different locations. The antenna/signal strength and battery icons appear on the handset display.

When you move too far from the base station, the following occurs on the handset:

- the antenna/signal strength icon disappears
- **Out of range...** message appears
- handset produces an intermittent beep
- handset may go into scanning mode

If the signal strength is weak, move back into range to stop the handset display messages and warning tones.

If you go completely out of range during an active call, the call is automatically placed on hold. For more information, refer to [Hold calls](#) on page 43. Retrieve a held call by selecting the flashing red line button when you are back in range.

Note: In cases where the line button does not light when you move back into range of the base station, press the intercom/line button that the call came in on, to take the call off hold.

Handset Features

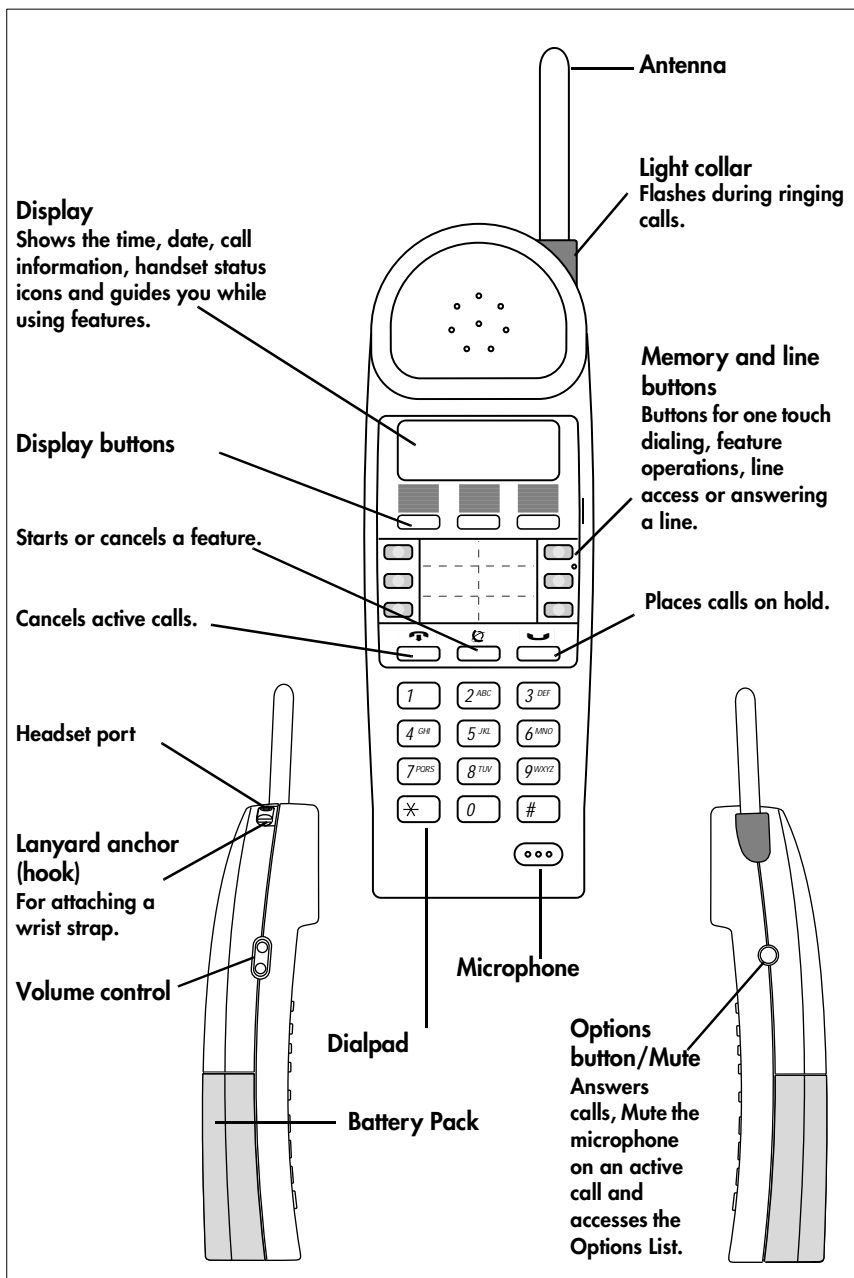

Installing the Base Station

This section describes the base station and:

- how to mount the base station on a wall
- what programming is required before you connect the base station to your system
- how to connect the base station to your system

The T7406 cordless telephone operates on the same principle as a two-way radio. Therefore, the location of the base station affects the range of reception. The base station should not be installed where radio waves are blocked or reflected, such as next to a filing cabinet.

For optimal performance, install the base station at least 2.4 meters (eight feet) above the floor. Always position the antenna at a 90° angle to the base station.

Base Station Features

This section illustrates the base station for the T7406 system.

Antenna

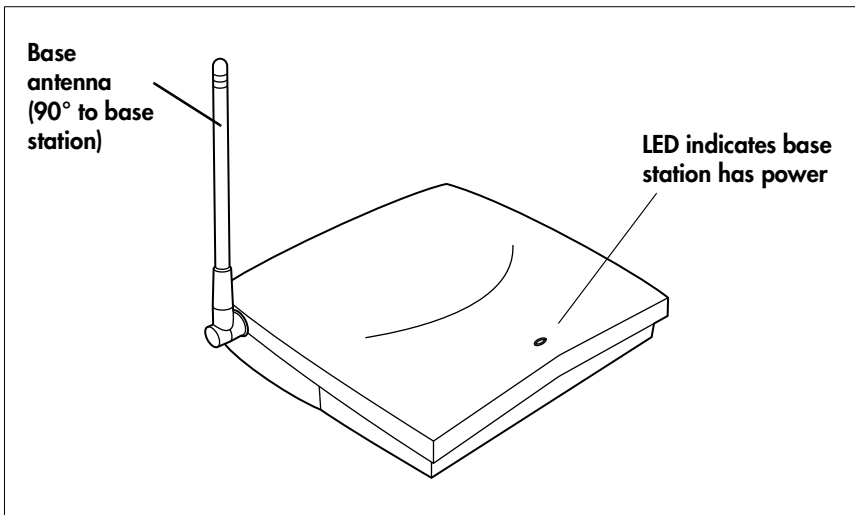

Note: When power is connected to the base station, the LED on the front of the unit starts flashing. During operation the LED flashes every second to indicate that the unit is receiving power.

Mounting Bracket

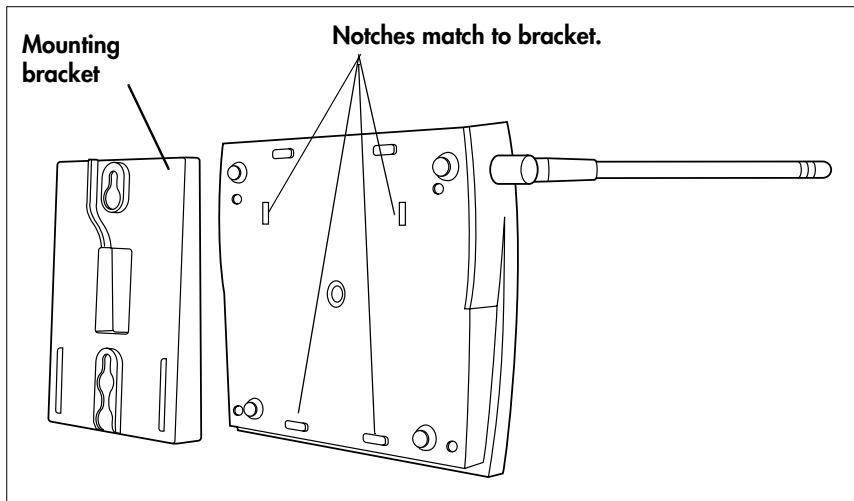

T7406 Pre-installation Programming

Before connecting the T7406 base station to your system, you must set up system programming for the handset lines.

Have the system administrator set up this programming:

1. Program Handsfree to **Auto**.
2. Program a **maximum of three lines** to each handset.
3. Assign **Ring & Appear** on the lines you assign to the handset.
Note: Appear only does not allow the handset to wake from **Handset Asleep** mode.
4. Set the **Page zone** to **None**.
Note: Handsets can send Page announcements, but they cannot receive them.
5. Set **DND on Busy** to **Yes** if you do not want your calls interrupted with a ring tone when a second call comes in. Instead, the button flashes, indicating an incoming call.
6. Other telephone programming is the same as for the M7310 telephone, with the exception of the memory key locations.

Before you start

- Ensure there is an AC power outlet within 1.5 meters (5 feet) of the base station location.
- Ensure that the telephone lines from your system have been installed to the base station location.

Mounting and Connecting the Base Station

Follow these steps to mount and connect each base station.

1. Use the mounting bracket as a template to position the base station and mark the screw positions.
2. Use screws to attach the mounting bracket to a wall or ceiling.
3. Set the base station dip switches, located on the back of the base station, to the required ISM frequency band.

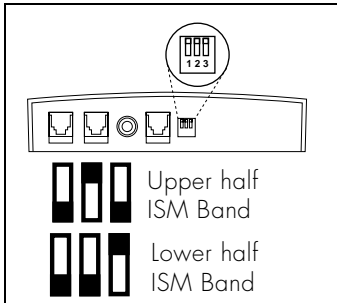

- On the first base station you install, set the dip switches to operate in the upper half of the ISM band. From left to right, set to **Down-Up-Down**.
- On the second base station, set the dip switches to operate in the lower half of the ISM band. From left to right, set to **Down-Down-Up**.

4. Connect the telephone lines to the base station.

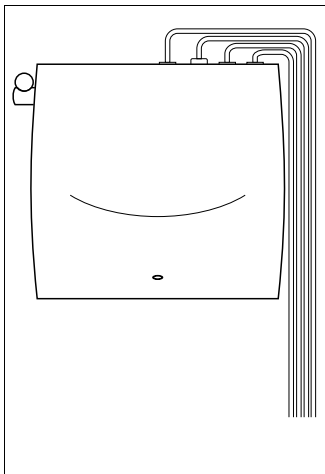

- a. Plug one end of the line cord into a telephone jack on the base station.
- b. Connect the other end into a telephone port on the system equipment.

Note: Connect a maximum of three TCMs per base station to the system.

- c. Plug the small end of the power adapter into the back of the base station.
- d. Plug the other end into an AC outlet.

Note: A red light flashes continuously on the base station when powered.

5. Align the notches on the back of the base station with the mounting bracket on the wall.
6. Push the base station against the brackets until they are securely connected.

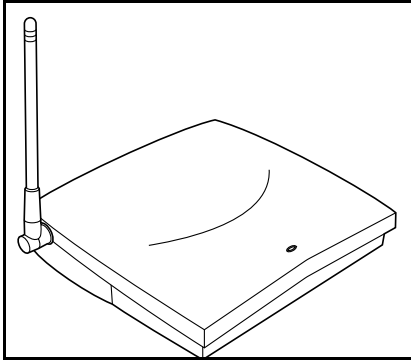

For the best radio reception, make sure the antenna on the base station is always at a 90° angle to the base station.

Charging the T7406 Battery Pack

Warning: It is imperative that you follow the steps in this section when you first initialize a base station and configure the first handset.

Follow these steps to set up the charging unit:

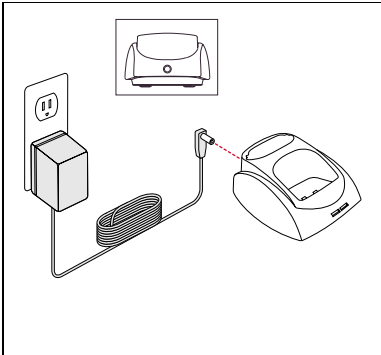

1. Plug the small end of the power adapter into the back of the charger.
2. Plug the power adapter into an AC outlet.

The back port (battery port) on the charger is used to charge the battery pack on its own.

The front port supports the handset with an installed battery pack.

The rechargeable battery pack must be fully charged before you use your T7406 handset for the first time.

Note: Multiple handsets — If you are installing a number of handsets at once, follow these instructions for each handset before you start trying to configure the handsets to the base station.

First-time Charging

When you first setup your new handset, follow these steps to charge the battery and install it into the handset:

1. Charge the battery pack in the back battery port of the charger for a minimum of 30 minutes.
2. Install the battery pack in the handset.
3. Charge the battery pack in the handset for a minimum of three hours.
4. Trickle charge a spare battery pack in the back battery port of the charger for 12 hours.

The following diagrams demonstrate where the battery pack fits onto a handset, and how to trickle charge the spare battery pack.

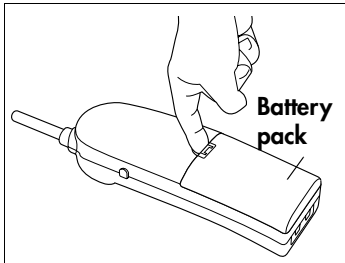

Installing a Battery Pack into the Handset

1. Position the battery pack in the bottom position on the back of the handset.
2. Snap the top of the battery pack into place.

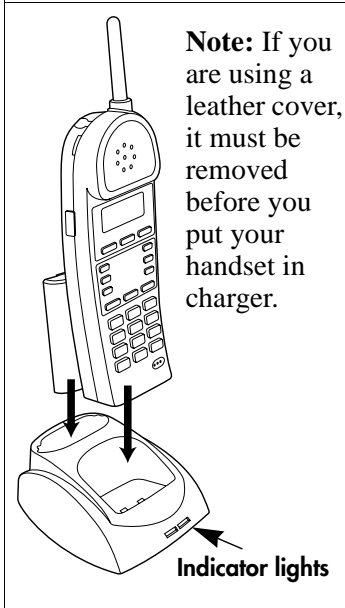

Note: If you are using a leather cover, it must be removed before you put your handset in charger.

Charging the Handset

1. Slide the handset into the charger. Make sure the handset and charger contacts touch.
2. The handset charge indicator light turns on. The battery pack indicator light is red while it is charging. The battery pack fully charges in approximately three hours. When the battery pack is fully charged, the indicator light turns green.

Note: Charging begins as soon as the handset is placed in the base station.

3. Slide the spare battery pack into the back battery port. Make sure the battery pack and charger contacts touch.

Note: Make sure the battery is properly installed in the handset or seated in the charger. If the T7406 battery is not properly installed, or if the battery level is extremely low, the six programmable buttons may light or flash simultaneously. This may also happen when the handset is in the charger.

Exchange the handset battery pack regularly (once a week) if you have a second (spare) battery pack.

The spare battery pack trickle charges in approximately 12 hours. When the spare battery pack is fully charged, the indicator light turns green.

Handset Power

Power to the handset comes from the battery pack installed in the back of the handset. When the battery pack power level is low it must be recharged in the charging unit.

Low battery

When the power is low, a tone sounds every 15 seconds indicating you need to recharge the battery soon. Your call is automatically put on hold 20 seconds after the battery pack runs out.

Recharge

Recharging begins as soon as you put the handset in the charging unit. Refer to [Charging the T7406 Battery Pack](#) on page 24.

- Be sure that the handset and charger contacts touch. A red LED indicates the battery is charging.
- To fully recharge the battery pack, leave the handset in the charger until the indicator light turns green.

Note: If the T7406 battery is not properly installed, or if the battery level is extremely low, the six programmable buttons may light or flash simultaneously. This may also happen when the handset is in the charger.

Battery levels

The following icons appear on the display.

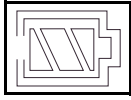

Indicates battery pack is fully charged.

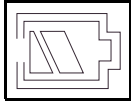

Indicates battery pack is 2/3 charged.

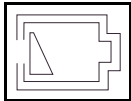

Indicates battery pack is 1/3 charged.

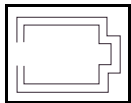

Indicates battery pack is completely discharged.

Note: The battery level icons show approximate charge status values.

You can talk continuously for up to five hours on the handset with a fully charged 1400 mAh battery pack. A fully charged battery pack has a standby time up to 72 hours. Using the backlight shortens talk and standby time.

Handset Configuration

This section describes how to set up handsets on a base station. Note that there is one extra step for setting up the first handset on a new base station.

Important First-time Installation Information

When performing the initial configurations on the handset, ensure that all the handsets you intend to configure have fully-charged battery packs installed.

Since the handsets start scanning as soon as they are powered, you must set the handset ID #s first when you configure the handset to avoid conflicts between handset signals and the possibility of one set mirroring another.

If you install more than one base station on a system, ensure that you assign a unique Security code to each base station. However, all base stations have the same three Handset ID numbers (1, 2, or 3), which identify the handset to the base station.

Identifying the Handsets to the System

Each of the three handsets registered to a base station share an identical Security code, but each handset has a unique handset ID number of 1, 2, or 3.

The handset ID number the handset is assigned to maps back to the TCM/RJ-11 jack on the back of the base station. The diagram below identifies which jack supports which handset ID number.

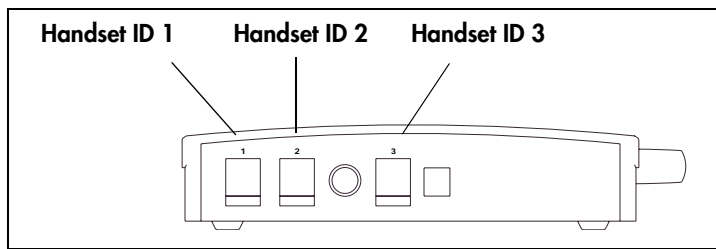

In turn, these numbers correspond to telephone records in the main system. In the system, these records identify each telephone with a local number, referred to as a DN (directory number). Since the records will be set up before you configure your handset, check with your system administrator to determine which local has been assigned to which port. From there, you can identify which Handset ID number should be assigned to each handset.

Note: When a base station is relocated, the Handset ID number follows the set DN (system telephone record), if the Set relocation feature is on.

Assigning the Handset to the Base Station

When you assign the first handset to a base station, you must send the security code to the base station. For subsequent handsets, you only need to identify the security code on the handset itself. This is explained in detail in later sections.

This is the general process for setting up a T7406 handset:

- Identify the handset to a unique Handset ID # (1, 2, or 3)
 - Note:** The handset ID #, which gets assigned to each handset, matches up to TCM/RJ-11 jack on the back of the base station. Ask your system administrator which handset ID maps to which set DN on the system.
- Change the default password for selecting a handset ID (default: 000000)
- Assign a Security code (S.S. code)
- Send the Security code from the handset to the base station
 - Note:** Sending the security code to the base station is only performed for the first handsets. For subsequent handsets, you need only identify the security code on the handset.
- Assign the ring type
- Assign the ringer volume
- Assign the language that appears on the handset display

Using the Handset Display Buttons

The T7406 handset has a three-line display.

The three display buttons located under the display are used to interact with the handset menus and the feature code messages that appear on the display.

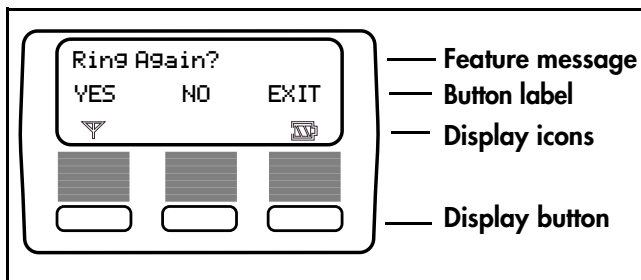

- The first line of the display shows handset messages and menu items.
- The second line displays button labels in capital letters.

- The third line displays the antenna/signal strength icon and the battery charge icon.

Configuring the First Handset to a Base Station

When you configure a handset to a new base station, you must ensure the base station receives the assigned security code. For subsequent handsets, the security code must be identical, but it does not need to be re-assigned to the base station.

Other settings are the same for all handsets.

Configuring the Handset ID Number

Each of the three handsets registered to a base station share an identical Security code, but each handset has a unique Set ID of 1, 2, or 3.

Follow these steps to set the handset ID and new password:

1. Press the Options button.
2. Press SHOW.
3. Press NEXT until the display shows 6. Handset ID.
4. Press SHOW.

The display shows the current Handset ID #.

- If this is the **correct number**, press OKK and continue with the next section.

- If you want to **change the number**, follow these steps:
 - a. Press CHANGE.
The display shows *Enter Password*. (six digits)
 - b. Enter the default password (000000).
 - c. Press OK to accept the code.
The display shows *Press Digit 1 - 3*. The current Handset ID # is displayed on the bottom left of the LCD.
 - d. Press the digit that you want to assign to this handset.
 - e. Press OK.
The display shows *6. Handset ID*.

Changing the Handset ID Password

After you enter the handset ID, if you want to change the password for the ID access, follow these steps:

1. Press NEXT until the display shows *7. Ch9 Password*.
Note: This password is used to access the Handset ID option. If you decide not to change the password, press the **Option** button to exit the menu.
2. Press SHOW.
The display shows *Enter old PWD*.
3. Enter the default six-digit password (000000) or the last password you entered.
4. Press OK.
The display shows *Enter New PWD*.
5. Enter a new six-digit password.
Note: For ease of administration, it is recommended that you use the same password as the one you used for the Security code/S.S. Code.

6. Press OK.
The display shows `Confirm New PWD`.
7. Re-enter the password.
8. Press OK.
The display shows `PWD Changed!`.
9. Press the Options button to exit the Option menu
The display changes to show the date and time.

Password errors

If you enter an incorrect password and the display shows `PWD Error!`, return to the `7. Chg Password` menu item and try again.

Lost password

Make a note of the new password. If you forget your password, you will need to contact your Distributor for help to unlock the set.

Assigning the Security Code

After you assign the handset ID # to a handset, you need to configure the handset to a base station.

Follow these steps to assign a Security code to the handset.

1. Press the Options button.
2. Press SHOW.
3. Press NEXT until the display shows `4. Set S.S. Code :`
4. Press CHANGE to assign a security code to the handset. The display shows `Enter Password`.
5. Enter the six-digit password (default 000000).
6. Press OK. The display shows `Press 6 digits`.
7. Enter the six-digit Security code.
The display changes to show the code as entered.
8. Press OK to accept the code.
The display shows `4. Set S.S. Code :`

If you are assigning a handset to an existing base, your handset is now connected to the system.

If you are assigning the first handset to a **new base station** (which has no security code), continue with the following steps:

9. The display shows **4. Set S.S. Code :**, press **NEXT** to get ready to send the security code to the base station.
The display shows **5. Send S.S. Code.**
10. Unplug the AC power adapter connected to the base station, and plug it back in again.
11. Within 15 seconds, press and hold the **OK** button for five seconds. This sends the Security Code to the base station. The display shows **Send OK!** and you hear a beep when the transfer is successful.
Note: If the Security Code transfer fails, the display shows **Send Error!** To correct this, repeat steps 9 and 10.
12. Press the Options button to exit the Option menu.
The display changes to show the date and time.

Configure the next handset to the base station

Configure the second and third handsets to the base station using these procedures:

1. Follow the steps in [Configuring the Handset ID Number](#) on page 30. Ensure you enter a different handset ID number (1, 2, or 3) for each handset you configure.
2. If you want to change the handset ID password, continue with the steps in [Changing the Handset ID Password](#) on page 31.
3. Once you have assigned a Handset ID #, continue with [Assigning the Security Code](#) on page 32 up to and including step 8.

Setting Handset Features

After you identify the handsets to the base station, you can set up the handset features:

Ring Type

To assign the ring type:

1. Press the Options button.
2. Press SHOW.
The display shows **1. Ring Type**.
3. Press SHOW. The display shows **Ring Type :1**.
Note: There is also a Ringer Off setting.
4. Press CHANGE to listen to the four different rings available on your handset.
5. Press OK to accept the ring type of your choice.
6. Press the Options button to exit the Option menu.
The display changes to show the date and time.

Note: Ring Type can only be set through the Option menu on the handset. This feature cannot be set in system programming.

Ringer Volume

You can assign the ringer volume level for the handset. The ringer volume level assignment also affects the listening volume level.

To assign the ringer volume:

1. Press the Options button.
2. Press SHOW.
3. Press NEXT until the display shows **2. Ringer Volume**.
4. Press SHOW. The display shows **Press Volume Bar**.
5. Press the volume bar on the left side of the handset. There are three ring volumes.
6. Press OK. The display shows **2. Ringer Volume**.
7. Press the Options button to exit the Option menu.
The display changes to show the date and time.



Lock Handset

You can lock the buttons on the handset to prevent unintentional dialpad or button presses.

To assign the Lock Handset feature:

1. Press the Options button.
2. Press SHOW.



3. Press **NEXT** until:
The display shows **3. Lock Handset**.
4. Press **OK** to lock the handset.
The display shows **Handset Locked**.
5. Press the Options button to exit the Option menu.
The display changes to show the date and time.

To release the Handset Locked state, press the  button, then press .



Lock Handset notes:

- An incoming call will automatically release the handset from Handset Lock mode.
- The handset cannot be locked while you are on a call.

Language

  **5** **0** **1**



Select the Primary Language for the display.

  **5** **0** **2**

Select the Alternate Language 1 for the display.

  **5** **0** **3**

Select the Alternate Language 2 for the display.

  **5** **0** **4**

Select the second Alternate Language 3 for the display.

Note: For more information about language choices, talk to your system administrator.

Handset System Feature Notes

The following section provides some notes about system features that the handset has specific applications with.

Ring Notification: If the set is idle and you press a line or intercom button, and then the  button, the set will not get ring notification of an incoming call.

To release the held line, press the line or intercom button, and then press .

Priority call: If a Priority call is made to your T7406 telephone that does not have DND active, and the call is answered but the originating caller then releases the call, you must still press an intercom line and the  button before the line is actually released. If you choose not to do this, the handset stops providing ring notification of incoming calls, refer to **Ring Notification**.

Voice Call Deny (F88): This feature has been purposely set as the default for the handset, since voice calls cannot be made to the T7406 handset. If this setting inadvertently gets turned off by the system administrator or the user, someone attempting to make a voice call to the handset may not receive the No Voice Call display on their telephone. As well, the call will continue as a normal call to the T7406 set.

LCD Contrast Level: This feature is not adjustable, either through the handset or through system programming. Contrast has been automatically set to an optimum level.

T7406 and M7410 interaction: If there are any M7410 telephones installed on the system, you can attach only one base station and three handsets in the same area. In this case, the base station must be set to the upper band. Refer to [Installing the Base Station](#) on page 21 for instructions about setting the base station to the lower band.

Button Mapping on the Handset

When you have completed the steps in [Handset Configuration](#) on page 27, then, you can map the feature buttons on your set.

The handsets have six feature buttons. These buttons can be programmed by your system administrator. You can also program the buttons from your handset. The following section describes the usual mapping of the buttons, based on the M7310 telephone button mapping. The illustration below shows examples of the default button mapping for the handset.

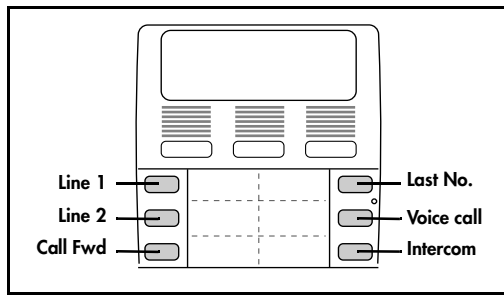

The following two illustrations show the correlation between the T7406 handset buttons and the M7310 and T7316 telephones, which are standard telephones used for Norstar and Business Communications Manager systems.

M7310 to T7406

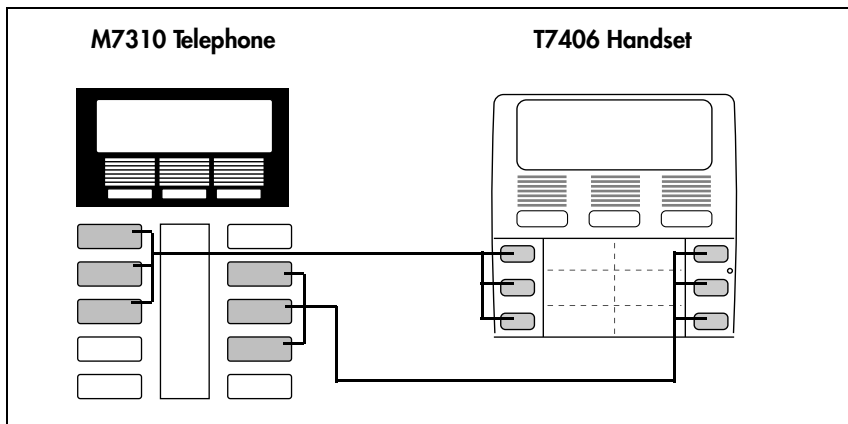

T7316 to T7406

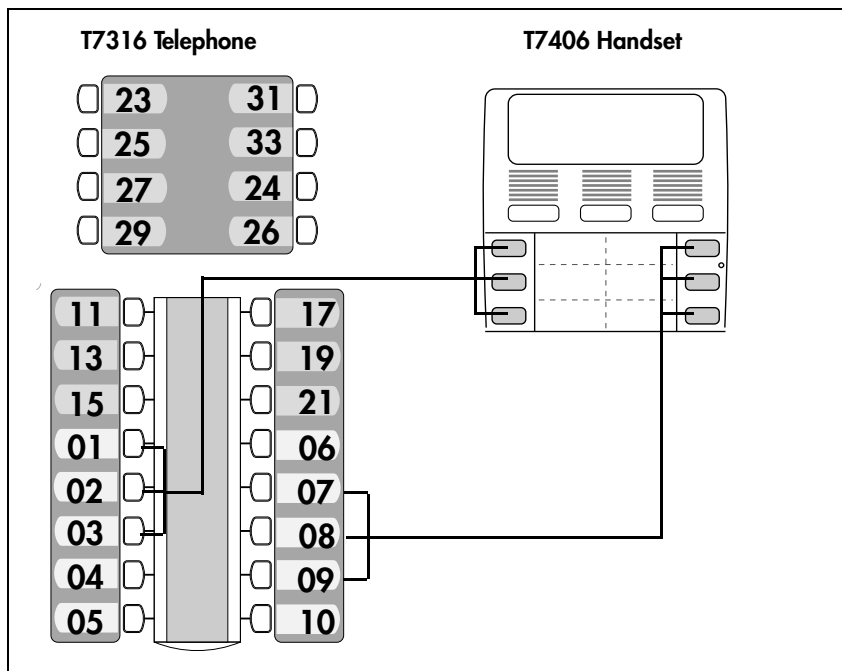

For more information, refer to [Programming memory buttons](#) on page 39.

Memory buttons

Memory buttons are buttons on the handset that are assigned to functions other than Intercom or line buttons. For more information, refer to [Button Mapping on the Handset](#) on page 37.

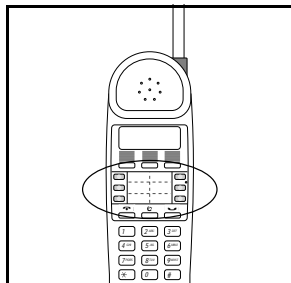

Press * 0 to check a memory or line button.

The display will show you what is programmed onto the button.

Programming memory buttons





You can program memory buttons with:

- external autodial numbers
- internal autodial numbers
- features

After you have programmed the memory buttons, record the names and numbers on the handset card. For more information, refer to [Installing the T7406 Handset Accessories](#) on page 46.





External autodial

To program an external autodial memory button:

1. Press   .
2. Press a memory button.
3. Dial the external number.
4. Press   to store the number.
5. Label the button.







Internal autodial

To program an internal autodial memory button:

1. Press   .
2. Press a memory button.
3. Dial the internal number.
4. Press   to store the number.
5. Label the button.

Features



To program a feature memory button:

1. Press   .
2. Press a memory button.
3. Press  and enter the feature code.
4. Press   to store the feature code.
5. Label the button.

Refer to [System Feature codes](#) on page 40 for a list of the most common features. Your system administrator can also provide a list of all the feature codes that are available.

Erase memory buttons





To erase a memory button:

1. Press   .
2. Press the memory button you want to erase.
3. Press OK to erase the button.

Button Inquiry

Use the Button Inquiry feature to determine what is programmed on the memory buttons on your handset.



























To use the Button Inquiry feature from the handset:



1. Press   .
2. Press the button(s) you want to check, and read the display.
3. Press  or  when you are finished.

System Feature codes

Contact your system administrator for information about all the feature codes that are available on your system and how they operate.

Some of the most common Feature codes are:

Button inquiry	  
Call Forward	 
Conference	 
Do Not Disturb	  
Last Number Redial	 
Messages	 
Page - General	  
Page - Internal	  
Page - External	  
Page - Internal/External	  

Ring Again*	 2
Transfer	 7 0
Voice Call	 6 6
Notes: * In sleep mode, the user receives visual indication only. There is no beep tone indication.	

Memory buttons store telephone numbers or feature codes to give you one-touch dialing or feature activation. For more information about memory buttons, refer to [Memory buttons](#) on page 38.

Handset Asleep (Save Battery Mode)

When the handset is idle for longer than 15 seconds, it automatically goes into Handset Asleep mode to conserve the battery. Incoming calls automatically wake up the handset from the Handset Asleep mode. Pressing any button on the dialpad also wakes up the handset.

Handset Asleep Mode Feature Conditions

If the handset is in Handset Asleep mode, the following features are affected:

- To receive **Message Waiting Indication (MWI)** when the handset is in Handset Asleep mode, press any button on the dialpad to wake up the handset.
- If the **Ring Again** feature is active, and the handset goes into Handset Asleep mode, there is no indication of the Ring Again feature until you press a button on the dialpad to wake up the handset. To use the Ring Again feature, press any button on the dialpad to wake up the handset.

Note: When the handset is awake, the Ring Again feature provides both an audio and a visual indication that the feature is active.

- If the **Do not disturb (DND)** feature is active when the handset is in Handset Asleep mode, there will be no visual notification of incoming calls, including Priority calls.

Priority calls when DND is active: When the handset is in Handset Asleep mode and a Priority call is made to the T7406,

it appears to the caller that the Priority Call was successfully connected, even though you receive no indication on your T7406 handset. As soon as you wake the handset, whenever you have DND set, you must always press the line or intercom button and the  button. This ensures that your handset provides proper audible and visual Ring Notification.

Make and Answer Calls

This section provides a brief overview of how you use the handset to make and answer calls.

Make a call

Use intercom and extension buttons to make internal calls. See your system administrator for a list of numbers.

To make a call:

1. Press an intercom or line button.
2. After the button lights, enter your system external line access code or line pool access code.
3. Dial a number.
4. Press  to end the call.

Answer calls

When your telephone rings while you are on a call, you hear a beep tone through the receiver, unless DND on Busy has been set to Yes in the telephone system programming. In this case, only the indicator light on your handset will indicate that another call is coming in.

To answer a call:



1. Press the flashing red button.
2. Press  to end the call.

Note: When the Options list is active, press the flashing red button to answer an incoming call.

Hold calls

To retrieve a held call, press the button where the call is on hold. Calls are automatically placed on hold when you switch from one line to another.

To hold a call:

1. Press  while on a call. The line button flashes.
2. Press the flashing button to retrieve a held call.
3. Press  to end the call.

Mute microphone

To mute the microphone while you are on a call, press the Options button.

To cancel Mute, press the Options button again.







Note: While Mute is active, if you press any button on the face of the handset, the display will clear, but Mute will remain active. To turn off Mute, press the Options/Mute button on the side of the handset.







Mute only works on the current call. If a second call comes in, and you want to mute that call, answer the call and press the Options/Mute button on the side of the handset.

Page

You can use the T7406 cordless handset to make a page announcement. The handset does not have a loudspeaker so it cannot be paged.

To make a page announcement:

1. Press    and SETS, SPKR or BOTH to make a General page
The announcement is made over telephone and/or external speakers to all telephones in system that can receive Pages.
 - Press    to make an Internal page.
The announcement is made over the telephone speakers of all telephones in the system that can receive pages.

- Press    to make an External page.
The announcement is made through external speakers.
 - Press    to make an Internal/External page.
The announcement is made over both the telephone speakers and the external speakers.
2. Press  to end the page announcement.

Customize a handset

You can customize some of the handset features according your preferences.

To customize your handset, use the **Options** button to access the Options list. Use the display buttons on the handset to navigate through the Options list to find the settings you want. Refer to [Setting Handset Features](#) on page 33.

Backlight On/Off

Your handset display has a backlight that is helpful in low light conditions.

To activate the backlight, press any button on the dialpad.

Note: The battery talk time is reduced with the continuous use of the backlight. The backlight automatically turns off if the handset is idle for more than five seconds.

Helpful hints

If your T7406 telephone is not functioning as you expect, review the following table for possible solutions. If the problem persists, contact your system administrator.

Problem	Possible Cause	Suggestion
You hear warning tones. The handset display shows the discharged battery icon.	Battery pack is not charged sufficiently.	Recharge the battery pack. Ensure the handset is placed properly in the charger. (Charger LCD turns on)

Problem	Possible Cause	Suggestion
You hear warning tones. The handset display shows <code>Out of range...</code> and the antenna/signal strength icon disappears.	Handset is out of range of the base station.	Move within range of the base station. If you are on an active call when you move out of range, the call will automatically be placed on hold until you return into range, or until the other party hangs up.
The handset display shows <code>Scanning...</code> but the antenna/signal strength icon is present.	Handset and base station have different Security codes.	Assign the same Security code to the handset. Assigning the Security Code on page 32.
The six programmable buttons on the handset begin to light/flash simultaneously. light or flash.	This condition can occur when: <ul style="list-style-type: none"> • when the battery power is extremely low • when you have just replaced the battery and it is not seated properly in the handset • when the handset is sitting in the recharger 	To remedy conditions: <ul style="list-style-type: none"> • recharge the battery • Reinstall the battery in the handset • ensure the handset is seated properly in the recharger

Cleaning battery contacts

Clean all charging contacts on the handset and charger with a soft, dry cloth on a regular maintenance cycle to maintain a good charge connection. Do not use water or any other liquids or solvents for this purpose.

Installing the T7406 Handset Accessories

This section describes how to use the utility accessories on your handset.

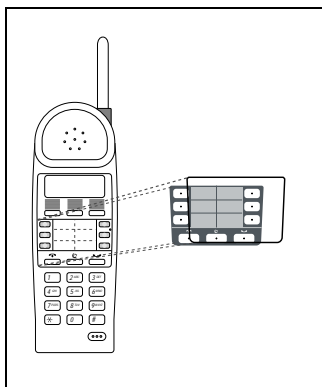

The Handset Card

On the handset card, you can write names or numbers identifying the six memory buttons on the handset. For more information, refer to [Button Mapping on the Handset](#) on page 37.

To install the card:

1. Insert the handset card into place.
2. Cover the handset card with the plastic lens.

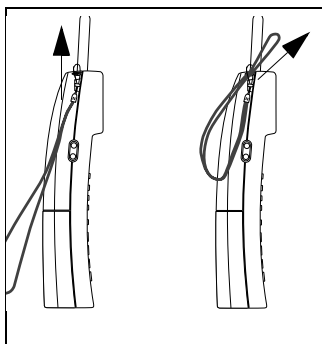

The wrist strap

To free your hands, yet still keep your handset at your fingertips, you can attach a wrist strap to the handset.

To attach the wrist strap to the handset:

1. Put the loop of the wrist strap through the hook on the side of the handset.
2. Put the other end of the strap through the loop.

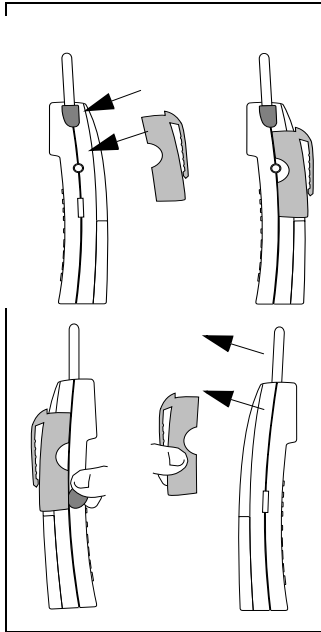

The belt clip

Use the belt clip to clip the handset onto your clothes or carrying case to free your hands for other tasks.

To attach the belt clip to the handset:

1. Line up the side tabs of the belt clip with the notches on the sides of the handset.
2. Snap the belt clip into place.

To remove the belt clip from the handset:

1. Use a small coin to release the side tabs of the belt clip from the notches on each side of the handset.
2. Pull the clip off the handset.

Optional accessories

The following optional accessories are available for your T7406 telephone.

Contact your system administrator for more information about ordering these accessories.

Leather carrying cases

A leather carrying case gives you a convenient way to carry your handset around the office.

When you need to recharge your handset, the leather case must be unbuttoned and removed enough to allow the handset to be properly seated in the charger.

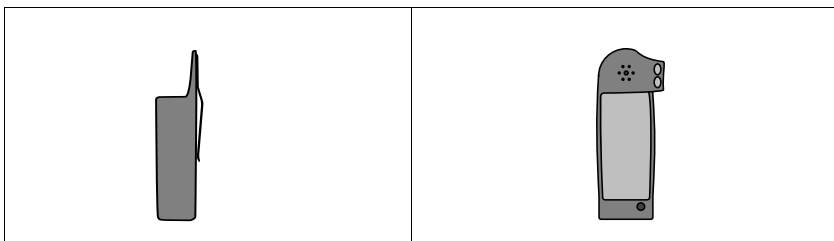

M7015-S: Standard model
(side view)

M7020-C: Custom model
(front view)

Headset Compatibility

A headset offers you handsfree operation of your handset when you use a belt clip or leather case to attach the handset to your belt or carrying case.

Note: To provide headset compatibility, the Handsfree feature must be enabled in system programming. If Handsfree is disabled, certain call handling features may not work as intended.

Note: No audible DTMF tones can be heard through the earpiece when you are wearing a headset with your T7406 handset. Dialpad button pressing is still received normally at the far end.

Headset installation

Follow these steps to attach a headset to the handset port.

1. Lift up and remove the rubber tab to expose the headset port.
2. Insert the headset jack into the headset port.

Note: The headset jack has a 2.5 mm opening. An adapter may be required if your headset has a 3.5 mm pin.

The handset microphone and earphone are disabled when the headset is connected to the headset port. If you use the headset, use the Options button to answer calls and to use the Options List to customize features. When you remove the headset from the headset port, handset operation is enabled automatically.

Regulatory information

Canadian Regulations

Note: This equipment may only be connected to the Host equipment and may not be connected directly to the Public Switched Telephone Network (PSTN).

This device complies with Industry Canada CS03 Issue 8 specifications, and ICES-003 and RSS-210 Canadian EMI requirements.

Operation is subjected to the following two conditions: (1) This device may not cause harmful interference and (2) this device must accept any interference received, including interference that may cause undesired operation.

Note: This device complies with Class A EMI requirements when connected to host equipment that meets Class A and Class B when connected to host equipment that meets Class B.

Privacy of communications may not be assured when using this phone. Do not attempt to repair this equipment. If you experience trouble, call or write for warranty and repair information.

Nortel Networks
30 Norelco Drive,
Weston, Ontario, M9L 2X6
Canada

US Regulations

Federal Communications Commission (FCC) Notice

FCC registration number: This telephone equipment complies with Part 68, Rules and Regulations, of the FCC for connection to Host equipment and may not be connected directly to the Public Switched Telephone Network (PSTN).

(The FCC registration number appears on a sticker affixed to the bottom of the base.)

Do not attempt to repair this equipment. If you experience trouble, call or write for warranty and repair information.

Nortel Networks
640 Massman Drive,
Nashville, TN, 37210
USA

Hearing aids: This telephone is compatible with hearing aids equipped with an appropriate telecoil option.

Programming emergency numbers: When programming emergency numbers and/or making test calls to emergency numbers:

1. Remain on the line and briefly explain to the dispatcher the reason for calling before hanging up.
2. Perform such activities in the off-peak hours, such as early mornings or late evenings.

EMI/EMC (FCC Part 15)

Note: This device complies with Class A EMI requirements when connected to host equipment that meets Class A and Class B when connected to host equipment that meets Class B. Consult the System Installation Guide for the applicable compliance.

Privacy of communications may not be assured when using this phone. Changes or modifications not expressly approved by the party responsible for compliance could void the user's authority to operate the equipment.

For Class A Host equipment

This equipment has been tested and found to comply with the limits for a Class A digital device, pursuant to Part 15 of the FCC Rules. These limits are designed to provide reasonable protection against harmful interference in a commercial environment.

This equipment generates, uses and can radiate radio frequency energy and, if not installed and used in accordance with the instructions, may cause harmful interference to radio communications.

Operation of this equipment in a residential area is likely to cause harmful interference in which case the user will be required to correct the interference at his own expense.

For Class B Host equipment

This equipment has been tested and found to comply with the limits for a Class B digital device, pursuant to Part 15 of the FCC Rules. These limits are designed to provide reasonable protection against harmful interference in a residential installation.

This equipment generates, uses and can radiate radio frequency energy and, if not installed and used in accordance with the instructions, may cause harmful interference to radio communications.

However, there is no guarantee that interference will not occur in a particular installation.

If this equipment does cause harmful interference to radio or television reception, which can be determined by turning the equipment off and on, the user is encouraged to try to correct the interference by one or more of the following measures:

- Reorient or relocate the receiving antenna.
- Increase the separation between the equipment and receiver.
- Connect the equipment into an outlet on a circuit different from that to which the receiver is connected.
- Consult the dealer or an experienced radio/TV technician for help.

Privacy of communications may not be assured when using this telephone.

Changes or modifications not expressly approved by the party responsible for compliance could void the user's authority to operate the equipment.

Safety

This product meets all applicable requirements of both the CSA C22.2 No. 950-95 and UL-1950 Edition 3.

Important Safety Instructions

WARNING: To avoid electrical shock hazard to personnel or equipment damage observe the following precautions when installing telephone equipment.

Installation

1. Never install telephone wiring during a lightning storm.
2. Never install telephone jacks in wet locations unless the jack is specifically designed for wet locations.
3. Never touch uninsulated telephone wires or terminals unless the telephone line has been disconnected at the network interface.
4. Use caution when installing or modifying telephone lines. The exclamation point within an equilateral triangle is intended to alert the user to the presence of important operating and maintenance (servicing) instructions in the literature accompanying the product.



This symbol on the product is used to identify the following important information: Use only with a CSA or UL certified CLASS 2 level C power supply, as specified in the User Card.

Use

When using your telephone equipment, basic safety precautions should always be followed to reduce risk of fire, electric shock and injury to persons, including the following:

1. Read and understand all instructions.
2. Follow the warnings and instructions marked on the product.
3. Unplug this product from the wall outlet before cleaning. Do not use liquid cleaners or aerosol cleaners. Use a damp cloth for cleaning.
4. Do not use this product near water, for example, near a bath tub, wash bowl, kitchen sink, or laundry tub, in a wet basement, or near a swimming pool.
5. Do not place this product on an unstable cart, stand or table. The product may fall, causing serious damage to the product.
6. This product should never be placed near or over a radiator or heat register. This product should not be placed in a built-in installation unless proper ventilation is provided.
7. Do not allow anything to rest on the power cord. Do not locate this product where the cord will be abused by persons walking on it.

8. Do not overload wall outlets and extension cords as this can result in the risk of fire or electric shock.
9. Never spill liquid of any kind on the product.
10. To reduce the risk of electric shock, do not disassemble this product, but have it sent to a qualified service person when some service or repair work is required.
11. Unplug this product from the wall outlet and refer servicing to qualified service personnel under the following conditions:
 - a. When the power supply cord or plug is damaged or frayed.
 - b. If the product has been exposed to rain, water or liquid has been spilled on the product, disconnect and allow the product to dry out to see if it still operates; but do not open up the product.
 - c. If the product housing has been damaged.
 - d. If the product exhibits a distinct change in performance.
12. Avoid using a telephone during an electrical storm. There may be a remote risk of electric shock from lightning.
13. Do not use the telephone to report a gas leak in the vicinity of the leak.
14. **CAUTION:** To eliminate the possibility of accidental damage to cords, plugs, jacks, and the telephone, do not use sharp instruments during the assembly procedures.

WARNING: Do not insert the plug at the free end of the handset cord directly into a wall or baseboard jack. Such misuse can result in unsafe sound levels or possible damage to the handset.

