

# Encore

by Inter-Tel



## **Installation, Programming, and Maintenance Manual**



Part Number  
618.8000

# Encore

*by Inter-Tel*

Version 4.0

## Installation, Programming and Maintenance Manual

Issue 4.0, July 2002



## NOTICE

This *Inter-Tel Encore Installation, Programming and Maintenance Manual* is released by INTER-TEL, INC. as a guide for service personnel. It provides information necessary to properly install, program, operate, and maintain the system.

The contents of this manual, which reflect current INTER-TEL standards and which document Encore software, are subject to revision or change without notice. Software packages released after the publication of this manual will be documented in addenda to the manual or succeeding issues of the manual.

For additional information and/or technical assistance, certified technicians may contact:

Customer Support Department  
INTER-TEL, INC.  
7300 West Boston Street  
Chandler, AZ 85226-3224  
(480) 961-9000  
(888) 777-EASY

**If you have any questions or comments regarding this manual or other technical documentation, contact Inter-Tel's Technical Publications Department at: [Tech\\_Pubs@inter-tel.com](mailto:Tech_Pubs@inter-tel.com)**



# Version 4.0 New Features & Enhancements

If you are familiar with the previous issue of the *Encore Installation Manual*, the following new items are documented in Issue 4.0 of the *Encore Installation, Programming, and Maintenance Manual*. Also, Remote Management Software (RMS) information has been combined into this manual, with existing programming information.

For detailed information on each item, where applicable, refer to the page numbers following the brief explanation below. Throughout this manual, “change bars,” like the one to the left of this paragraph, have been placed in the margins to indicate new or revised information since the last documentation issue.

The new voice-mail module for release 4.0 provides the following features:

- Dynamically accessible ports (all extensions have access to either of the two ports)
- Additional voice prompts
- Mail box full indication
- More storage capacity
- Divert on no answer is automatically set when mail boxes are equipped.
- No support for old voice module in this software. Version 4.0 voice mail software cannot be installed on systems using the v3.0 voice module.
- Courtesy service three-minute ring. If not answered, it will be connected to the system mail box where the caller can leave a message.
- System mail box defaulted OFF for all lines. It can be activated by turning on the desired lines you want as an answering machine (from the Programming Lines option at the keyset or from the Line Programming option in RMS). The answering machine option from the idle menu will need to be selected so the answering machine is activated.
- If the voice module is removed and the power cycled (warm reset), and the voice module is reinserted, it will retain all messages and greetings.
- Maximum number of voice mail messages (per mail box) has increased to 50.
- Voice mail default messages have been increased to 20.





# Table of Contents

| <i>CONTENTS</i>                                          | <i>PAGE</i> |
|----------------------------------------------------------|-------------|
| <b>Version 4.0 New Features &amp; Enhancements</b> ..... | <b>vii</b>  |
| <b>FCC Regulations</b> .....                             | <b>xv</b>   |
| <b>Safety Regulations</b> .....                          | <b>xvii</b> |
| <b>Limited Warranty</b> .....                            | <b>xix</b>  |
| <b>Software License Agreement</b> .....                  | <b>xx</b>   |
| <b>Overview</b>                                          | <b>1-1</b>  |
| <b>1. Introduction</b> .....                             | <b>1-2</b>  |
| <b>2. About This Manual</b> .....                        | <b>1-3</b>  |
| <b>3. System Hardware</b> .....                          | <b>1-4</b>  |
| <b>4. Keysets</b> .....                                  | <b>1-5</b>  |
| <b>5. Feature Summary</b> .....                          | <b>1-6</b>  |
| <b>6. System Capacities</b> .....                        | <b>1-7</b>  |
| <b>Installation</b>                                      | <b>2-1</b>  |
| <b>1. Introduction</b> .....                             | <b>2-2</b>  |
| <b>2. System Installation Checklist</b> .....            | <b>2-3</b>  |
| <b>3. Planning the Installation</b> .....                | <b>2-4</b>  |
| <b>4. Extension and CO Line Cabling</b> .....            | <b>2-7</b>  |
| <b>5. Key Service Unit (KSU)</b> .....                   | <b>2-11</b> |
| <b>6. Keysets</b> .....                                  | <b>2-24</b> |
| <b>7. Single-Line Sets</b> .....                         | <b>2-26</b> |
| <b>8. Long-Line Extension</b> .....                      | <b>2-26</b> |
| <b>9. Optional Equipment</b> .....                       | <b>2-26</b> |
| <b>10. Completing the Installation</b> .....             | <b>2-32</b> |
| <b>11. Upgrading the System Software</b> .....           | <b>2-37</b> |
| <b>12. Customer Training</b> .....                       | <b>2-38</b> |
| <b>Features</b>                                          | <b>3-1</b>  |
| <b>1. Introduction</b> .....                             | <b>3-3</b>  |
| <b>2. Feature Keys and Codes</b> .....                   | <b>3-3</b>  |

| <i>CONTENTS</i>                              | <i>PAGE</i> |
|----------------------------------------------|-------------|
| 3. CO Line Features .....                    | 3-5         |
| 4. Protection Against Power Failure .....    | 3-10        |
| 5. Extensions .....                          | 3-11        |
| 6. Courtesy Service .....                    | 3-18        |
| 7. Voice Messaging Module Features .....     | 3-19        |
| 8. Music-On-Hold .....                       | 3-23        |
| 9. Internal Calls .....                      | 3-23        |
| 10. Outside Calls .....                      | 3-26        |
| 11. Placing Calls On Hold or Park .....      | 3-30        |
| 12. Call Waiting .....                       | 3-31        |
| 13. Call Waiting Tone Protection .....       | 3-32        |
| 14. Call Transfer .....                      | 3-32        |
| 15. Redirecting Ringing Calls .....          | 3-33        |
| 16. Call Forwarding .....                    | 3-33        |
| 17. Conference Calls .....                   | 3-35        |
| 18. Paging .....                             | 3-36        |
| 19. Speed-Dial Numbers .....                 | 3-38        |
| 20. Sending a Hookflash Over a CO Line ..... | 3-39        |
| 21. Display Messages .....                   | 3-39        |
| 22. Do Not Disturb .....                     | 3-40        |
| 23. Reminder Call .....                      | 3-40        |
| 24. Extension Lock .....                     | 3-41        |
| 25. Extension Reset .....                    | 3-42        |
| 26. Manager/Secretary .....                  | 3-43        |
| 27. Room Monitor .....                       | 3-43        |
| 28. Operator Extension .....                 | 3-44        |
| 29. Hunt Groups .....                        | 3-46        |
| 30. Call Logging .....                       | 3-47        |

---

**Keyset Programming** **4-1**

---

|                                                   |     |
|---------------------------------------------------|-----|
| 1. Introduction .....                             | 4-3 |
| 2. The Programming Keyset .....                   | 4-3 |
| 3. Beginning the Keyset Programming Session ..... | 4-4 |
| 4. System-Wide Programming .....                  | 4-5 |

| <i>CONTENTS</i>                             | <i>PAGE</i> |
|---------------------------------------------|-------------|
| 5. Extension Programming .....              | 4-16        |
| 6. Line Programming .....                   | 4-24        |
| 7. System Program Planning Sheets .....     | 4-32        |
| 8. Extensions Program Planning Sheets ..... | 4-36        |
| 9. Line Program Planning Sheets .....       | 4-37        |

---

**RMS Programming** **5-1**

---

|                                                        |      |
|--------------------------------------------------------|------|
| 1. Introduction .....                                  | 5-2  |
| 2. RMS Hardware Requirements .....                     | 5-2  |
| 3. Installing the RMS Software (Initial Install) ..... | 5-3  |
| 4. Upgrading the RMS Software .....                    | 5-4  |
| 5. Starting the RMS Software – Main Screen .....       | 5-4  |
| 6. RMS Deferred Mode .....                             | 5-7  |
| 7. RMS Real Time Mode .....                            | 5-8  |
| 8. RMS Programming Introduction .....                  | 5-14 |
| 9. RMS Extension Programming .....                     | 5-16 |
| 10. RMS Line Programming .....                         | 5-27 |
| 11. RMS System Programming .....                       | 5-36 |
| 12. Extensions Program Planning Sheets .....           | 5-44 |
| 13. Trunk Program Planning Sheets .....                | 5-47 |
| 14. System Program Planning Sheets .....               | 5-50 |

---

**RMS Maintenance** **6-1**

---

|                                 |      |
|---------------------------------|------|
| 1. Introduction .....           | 6-2  |
| 2. Cross Point Images .....     | 6-3  |
| 3. Call Statistics .....        | 6-5  |
| 4. Software States .....        | 6-6  |
| 5. System Phone Monitor .....   | 6-7  |
| 6. Trace .....                  | 6-8  |
| 7. System Reset .....           | 6-9  |
| 8. System Tests .....           | 6-10 |
| 9. Pro-Active Maintenance ..... | 6-11 |
| 10. System Timers .....         | 6-13 |

**Troubleshooting** **7-1**

---

- 1. Introduction ..... 7-2
- 2. Outgoing Calls ..... 7-2
- 3. Incoming Calls ..... 7-3
- 4. Internal Calls ..... 7-3
- 5. Keypad Features..... 7-3
- 6. System Features ..... 7-4
- 7. System, Line, or Extension Failure..... 7-4
- 8. Replacing the CPU ..... 7-5
- 9. Power Supply Replacement..... 7-5
- 10. Customer Support ..... 7-6
- 11. Defective Unit Return Policy..... 7-6

**Replacement Parts** **8-1**

---

- 1. Introduction ..... 8-2
- 2. Ordering Procedure ..... 8-2
- 3. Basic Systems ..... 8-2
- 4. Parts List ..... 8-3

**Index** **I-1**

---

# List of Tables

*NUMBER      TITLE* *PAGE*

## Overview

---

|  |                                        |     |
|--|----------------------------------------|-----|
|  | Table 1-1: System Capacities . . . . . | 1-7 |
|--|----------------------------------------|-----|

## Installation

---

|  |                                                                           |      |
|--|---------------------------------------------------------------------------|------|
|  | Table 2-1: Encore System Environmental Condition Requirements . . . . .   | 2-5  |
|  | Table 2-2: Main CPU Connections - Cable A . . . . .                       | 2-20 |
|  | Table 2-3: Expansion Card Connections - Cable B . . . . .                 | 2-21 |
|  | Table 2-4: V24 Adapter Pinouts . . . . .                                  | 2-31 |
|  | Table 3: Call Handling/Extension Names . . . . .                          | 2-33 |
|  | Table 4: Enabled/Disabled Features . . . . .                              | 2-34 |
|  | TABLE 5. Equipped Lines, Telephone Numbers and Caller ID . . . . .        | 2-34 |
|  | TABLE 6. Answering Machine, Courtesy Service and Auto Attendant . . . . . | 2-35 |
|  | TABLE 7. System-wide Features . . . . .                                   | 2-35 |
|  | TABLE 8. Recorded Greetings . . . . .                                     | 2-36 |

## Features

---

|  |                                                               |      |
|--|---------------------------------------------------------------|------|
|  | Table 3-1: Keypad Feature Codes . . . . .                     | 3-3  |
|  | Table 3-2: Single-Line Only Codes . . . . .                   | 3-4  |
|  | Table 3-3: Operator-Only Codes . . . . .                      | 3-4  |
|  | Table 3-4: Extension Numbers . . . . .                        | 3-4  |
|  | Table 3-5: Outgoing Line Access . . . . .                     | 3-4  |
|  | Table 3-6: Classes of Service and Associated Tables . . . . . | 3-7  |
|  | Table 3-7: Display Message Text . . . . .                     | 3-39 |
|  | Table 3-8: Call Logging Data Output Description . . . . .     | 3-47 |

## Keypad Programming

---

|  |                                                                   |      |
|--|-------------------------------------------------------------------|------|
|  | Table 4-1: Keypad Programming – System-Wide Programming . . . . . | 4-5  |
|  | Table 4-2: Keypad Programming – System Timers . . . . .           | 4-12 |
|  | Table 4-3: Keypad Programming – Extension Programming . . . . .   | 4-16 |
|  | Table 4-4: Keypad Programming – Line Programming . . . . .        | 4-24 |

## RMS Programming

---

|  |                                                               |      |
|--|---------------------------------------------------------------|------|
|  | Table 5-1: RMS Extension Programming Values . . . . .         | 5-16 |
|  | Table 5-2: Classes of Service and Associated Table . . . . .  | 5-19 |
|  | Table 5-3: RMS Line Programming Values . . . . .              | 5-27 |
|  | Table 5-4: RMS System Programming Values and Timers . . . . . | 5-36 |
|  | Table 5-5: RMS Programming User Timers . . . . .              | 5-39 |
|  | Table 5-6: Classes of Service and Associated Tables . . . . . | 5-41 |

*NUMBER*      *TITLE* *PAGE*

**RMS Maintenance**

---

Table 6-1: RMS Maintenance System Timers ..... 6-13

**Replacement Parts**

---

Table 8-1: System Components and Related Part Numbers ..... 8-3

# FCC Regulations

## Important

1. This equipment complies with Part 68 of FCC rules. On the side of the KSU is a label that contains, among other information, the FCC registration number and ringer equivalence number (REN) for this equipment. Customers connecting this equipment to the telephone network shall, before such connection is made, give notice to the telephone company of the particular line(s) to which such connection is to be made, and shall provide the telephone company with the following information:
  - Complies with Part 68 of FCC rules
  - FCC registration number: HAC LKCGTB-36091-CD-E
  - USOC numbers of required interface jacks: RJ21X
  - Facility interface code (FIC): 9.0Y
  - Service Order Code (SOC): 02LS2
  - Ringer equivalence number (REN): 1.25B
  - Port Types (as defined in Standard UL60950)
    - Extension Ports including Central Bell and Doorphone: TNV3
    - PSTN (Central Office) Ports: TNV3
    - RS232, Doorstrike and Music on Hold Ports: SELV

---

**NOTE:** The REN is used to determine the quantity of devices which may be connected to the telephone line. Excessive RENs on the telephone line may result in the devices not ringing in response to an incoming call. To be certain of the number of devices that may be connected to the line, as determined by the total RENs, contact the telephone company to determine the maximum REN for the calling area.

---

The telephone company should also be given notice upon final disconnection of this equipment from the particular line(s).

It is also the responsibility of the customer to provide the telephone company with registration numbers of any other devices which are configured for connection to the telephone network.

2. This equipment cannot be used on public coin service provided by the telephone company. Connection to party line service is subject to state tariffs. (Contact the state public utility commission, public service commission, or corporation commission for information.)
3. If this equipment causes harm to the telephone network, the telephone company will notify the customer in advance that service may be temporarily discontinued. But if advance notice is not practical, the telephone company will notify the customer as soon as possible. Also, the customer will be advised of the right to file a complaint with the FCC, if necessary.
4. The telephone company may make changes in its facilities, equipment, operations, or procedures which may affect the operation of this equipment. If so, the customer shall be given advance notice so that any necessary modifications can be made in order to maintain uninterrupted service.
5. If trouble is experienced with this equipment, contact a local authorized factory service representative for repairs and/or warranty information. The customer, users, and unauthorized technicians should not repair, make adjustments to, or attempt to service this equipment in any way.

6. In the event of trouble with the telephone line(s), this equipment must be disconnected from the telephone line(s). If trouble ceases, the equipment must be repaired by an authorized factory service representative. If the trouble continues to occur with the equipment disconnected, the telephone company should be notified that they have a problem. If this is the case, repairs or adjustments made by the telephone company will be made at their expense.
7. Allowing this equipment to be operated in such a manner as to not provide proper answer supervision signaling is in violation of Part 68 of FCC rules. This equipment returns answer supervision signals to the public telephone network when: answered by the called station, answered by the attendant, routed to a recorded announcement that can be administered by the equipment user, and routed to a dial prompt. This equipment also returns answer supervision on all DID calls forwarded back to the public telephone network. Permissible exceptions are: a call is unanswered, busy tone is received, and reorder tone is received.
8. This equipment is capable of providing users access to interstate providers of operator services through the use of equal access codes. Failure to provide equal access capabilities is a violation of the Telephone Operator Consumer Services Improvement Act of 1990 and Part 68 of the FCC Rules.

#### NOTICE

*THE TELEPHONE INSTRUMENTS SPECIFICALLY DESIGNED FOR THIS SYSTEM HAVE HEARING-AID COMPATIBLE HANDSETS THAT ARE IN COMPLIANCE WITH SECTION 68.316 OF THE FCC RULES.*

#### CAUTION

Radio Frequency Hazard. This equipment generates and uses radio frequency energy and if not installed and used properly, that is, in strict accordance with the manufacturer's instructions, may cause interference to radio and television reception. It has been type tested and found to comply with the limits for a Class A computing device in accordance with the specifications in Subpart J of Part 15 of FCC Rule. Operation of this equipment in a residential area may cause unacceptable interference to radio and TV reception requiring the operator to take whatever steps are necessary to correct the interference. However, there is no guarantee that interference will not occur in a particular installation. If this equipment does cause interference to radio or television reception, which can be determined by turning the equipment off and on, the user is encouraged to try to correct the interference by one or more of the following measures:

- Reorient the receiving antenna
- Relocate the KSU with respect to the receiver
- Check that the KSU and receiver are not on the same circuit; the KSU must be powered from an isolated, dedicated AC outlet

If necessary, the user should consult the dealer or an experienced radio/television technician for additional suggestions. The user may find the following booklet prepared by the FCC helpful: "How to Identify and Resolve Radio-TV Interference Problems."

This booklet is available from the U.S. Government Printing Office, Washington, D.C. 20402, Stock No. 004-000-00398-5.

If RFI problems persist, contact Inter-Tel Customer Support.



# Safety Regulations

## Important Safety Instructions

The following safety information is reprinted from UL 1459. When using your telephone equipment, basic safety precautions should always be followed to reduce the risk of fire, electric shock, and injury to persons, including the following:

1. Read and understand all instructions.
2. Follow all warnings and instructions marked on the product.
3. Unplug this product from the wall outlet before cleaning. Do not use liquid cleaners or aerosol cleaners. Use a damp cloth for cleaning.
4. Do not use this product near water (for example, in a wet basement).
5. Do not place this product on an unstable cart, stand, or table. The product may fall, causing serious damage to the product.
6. Slots and openings in the cabinet and the back or bottom are provided for ventilation, to protect it from overheating; these openings must not be blocked or covered. This product should never be placed near or over a radiator or heat register. This product should not be placed in a built-in installation unless proper ventilation is provided.
7. This product should be operated only from the type of power source indicated in the manual. If you are not sure of the type of power source to your building, consult your dealer or local power company.
8. This product is equipped with a three-wire grounding type plug, a plug having a third (grounding) pin. This plug will only fit into a grounding type power outlet. This is a safety feature. If you are unable to insert the plug into the outlet, contact your electrician to replace your obsolete outlet. Do not defeat the safety purpose of the grounding type plug.
9. Do not allow anything to rest on the power cord. Do not locate this product where the cord will be damaged by persons walking on it.
10. Do not use an extension cord with this product's AC power cord. The AC outlet for this product should not be used for any other electrical equipment.
11. Never push objects of any kind into this product through cabinet slots as they may touch dangerous voltage points or short out parts that could result in a risk of fire or electric shock. Never spill liquid of any kind on the product.
12. To reduce the risk of electric shock, do not disassemble this product, but take it to a qualified service person when service or repair work is required. Opening or removing covers may expose you to dangerous voltages or other risks. Incorrect reassembly can cause electric shock when the product is subsequently used.

13. Unplug this product from the wall outlet and refer servicing to qualified service personnel under the following conditions:
  - a. When the power supply cord or plug is damaged or frayed.
  - b. If liquid has been spilled into the product.
  - c. If the product has been exposed to rain or water.
  - d. If the product does not operate normally by following the operating instructions. Adjust only those controls that are covered by the operating instructions because improper adjustment of other controls may result in damage and will often require extensive work by a qualified technician to restore the product to normal operation.
  - e. If the product has been dropped or the cabinet has been damaged.
  - f. If the product exhibits a distinct change in performance.
14. Avoid using a telephone (other than a cordless type) during an electrical storm. There may be a remote risk of electric shock from lightning.
15. Do not use the telephone to report a gas leak in the vicinity of the leak.

## Save These Instructions

### CAUTION

Possible Fire and Safety Hazard. To reduce the risk of fire, use only no. 26AWG or larger line cord for CO line connections.

For safety reasons you should remove only the knockout panel(s) required for cable access to the KSU MDF area. Removing the other panels exposes the KSU circuitry unnecessarily and could create a safety hazard.

# Limited Warranty

For a period of 18 months from the date of purchase, INTER-TEL warrants the Equipment (except for fuses and lamps) to be free from defects in material, workmanship, or both, and to comply with specifications for the Equipment, as set forth in the *Installation Manual*. Buyer's sole and exclusive remedy for breach of this Limited Warranty shall be to have the defective Equipment (or parts) repaired or replaced at INTER-TEL's option. Shipping costs incurred returning warranty work to INTER-TEL shall be paid for by the Buyer. *This Limited Warranty extends only to the Buyer, not to any customer, user, or third party.* This Limited Warranty does not apply to Equipment (or parts) damaged by improper handling, normal wear and tear, accidents, lightning damage, negligence, or improper use or maintenance, and does not apply to Equipment altered without authorization by INTER-TEL. This Limited Warranty does not extend to any claims, suits, damages, liabilities, costs, and expenses arising from any act, action, or inaction of Buyer. Although the Moss-Magnuson Act should not apply, in the event that it is held to apply by a court of competent jurisdiction, the implied warranty of fitness for a particular purpose shall extend for the 18-month period from the date that the Equipment was purchased.

---

**NOTE:** *THIS WARRANTY IS IN LIEU OF AND EXCLUDES ALL OTHER WARRANTIES, EXPRESS OR IMPLIED, INCLUDING, BUT NOT LIMITED TO, THE IMPLIED WARRANTY OF MERCHANTABILITY OR FITNESS FOR A PARTICULAR PURPOSE. THERE ARE NO WARRANTIES WHICH EXTEND BEYOND THIS LIMITED WARRANTY. IN NO EVENT SHALL INTER-TEL BE LIABLE FOR LOSS OF ANTICIPATED PROFITS, INCIDENTAL OR CONSEQUENTIAL DAMAGES, LOSS OF TIME OR OTHER LOSSES INCURRED BY BUYER IN CONNECTION WITH THE PURPOSE, POSSESSION, OPERATION, OR USE OF THE EQUIPMENT, SUCH CLAIMS BEING EXPRESSLY WAIVED BY THE INSTALLING COMPANY.*

---

## NOTICE

For complete information on returning equipment, refer to the current Inter-Tel Repair and Return Policy (document part no. 835.1065). This document includes specific information on the following subjects: warranty, procedures to follow when returning equipment, equipment damaged in shipment, insurance, repair policy, and advance replacement policy.

# Software License Agreement

THE FOLLOWING IS A SITE LICENSE AGREEMENT RELATING TO THE INTER-TEL SOFTWARE. PLEASE CAREFULLY READ ALL OF THE TERMS AND CONDITIONS BEFORE PROCEEDING. THE SOFTWARE REFERENCED HEREIN IS LICENSED IN ACCORDANCE WITH THE FOLLOWING TERMS AND CONDITIONS. IF YOU DO NOT ACCEPT SUCH TERMS AND CONDITIONS YOU WILL NOT BE PERMITTED TO USE THE SOFTWARE. IF YOU ACCESS OR USE SUCH SOFTWARE IN CONTRAVENTION OF THE TERMS AND PROVISIONS OF THIS AGREEMENT, YOU WILL BE SUBJECT TO PROSECUTION TO THE FULLEST EXTENT PERMITTED BY LAW.

## DEFINITIONS:

“You” means, and “Yours” refers to the original end user purchaser of the Inter-Tel Software Programs. “Computer” means a computer consisting of a single central processing unit, one keyboard and one video display terminal. “Inter-Tel Hardware System” means any proprietary system distributed by Inter-Tel Integrated Systems (hereinafter “Company” or “Inter-Tel”) that operates by means of the Software. “Authorized Dealer” means an individual or entity currently authorized in writing by agreement and in good standing with Inter-Tel entitling the dealer to sell or license the specific Software covered by this license. “Software” means: the computer programs accompanying this License (including, but not limited to, codes, techniques, software tools, formats, designs, methods, processes, know-how and ideas) and any and all copies, modifications, upgrades, enhancements and new releases thereof made or acquired by You and any and all manuals and other printed materials accompanying this License or the Software

## LICENSE:

- (a) Inter-Tel Integrated Systems, Inc. (“Inter-Tel”) grants You a non-exclusive, non-transferable license to install and use the enclosed Inter-Tel Software and accompanying documentation on any one standalone personal computer or Inter-Tel Hardware System (whichever applies). You assume the entire responsibility for the selection and installation of the enclosed Software program(s) in order to achieve desired results. You agree that you are licensing the Program for its end use only and not for resale or redistribution. You must be an Authorized Dealer of the specific Inter-Tel products covered by this license. You will be liable for theft and infringement under applicable patent, copyright and trademark laws of the United States for unauthorized use of the Software covered by this license.

Inter-Tel reserves all rights in and to all patents, copyrights, trademarks, mask works and any other proprietary rights contained or embodied in the Software.

- (b) You may make one (1) copy of the Inter-Tel Software program(s) contained on diskette(s) for back-up purposes only, provided that You reproduce and place the Inter-Tel copyright notice on the backup copy. You may make one (1) copy of the Software program(s) onto one (1) hard drive. You may not copy the Inter-Tel Software program(s) contained on any media other than diskette; i.e., hard disk drive, ROMs, PALs, Software Protection Key, etc.
- (c) You are hereby notified that contained third-party suppliers and vendors are third-party beneficiaries to this Agreement to the extent that the Software contains software, programming and other materials provided by such third-party suppliers and vendors. Such provisions are made expressly for the benefit of and are enforceable by such third-party suppliers and vendors in addition to Inter-Tel.

- (d) You hereby acknowledge and agree that the license granted in this agreement is a site license. I.e., the software may only be installed at the initial end user site licensed for this software and at no other site without the express written consent and relicensing by Inter-Tel Integrated Systems, Inc. You acknowledge and agree that you have the responsibility to sublicense the end user of the software with an agreement in writing containing the statement that “the software licensed hereby may only be installed at the initial end user site licensed for this software and at no other site without the express written consent and relicensing by Inter-Tel Integrated Systems, Inc.” It is the specific intent of this site licensing agreement to (1) prohibit the improper copying and/or the multiple use of this software at other than a designated initial licensed site, and to (2) prohibit the right of resale and/or relicensing of the software without the express written consent of Inter-Tel. You agree that your failure to properly sublicense the software to an end user will subject you to responsibility for the losses occasioned to Inter-Tel.

**NON-PERMITTED USES:**

- You may not use the enclosed program(s) on more than one standalone personal computer or Inter-Tel Hardware System at a time and may not load the Software onto any file server or network.
- You may not sublicense, assign or transfer Your rights under the Agreement without the prior written permission of Inter-Tel.
- You may not use, copy, alter or transfer, electronically or otherwise, the Inter-Tel Software (program(s) or documentation) except as expressly allowed in this Agreement.
- You may not translate, reverse engineer, disassemble or decompile the Inter-Tel Software.
- You agree that you are licensing the Program for its end use only and not for resale or redistribution.

**TERM:**

This Agreement is effective from Your date of purchase and shall remain in force until terminated. You may terminate the Agreement by returning to Inter-Tel the original diskette(s), ROMs, PALs, or other applicable software media and all copies of the Inter-Tel software program(s). The Agreement is also terminated if You fail to comply with any term or condition of this Agreement. You agree to return to Inter-Tel the original diskette(s) and other applicable software media and all copies of the Inter-Tel Software program(s) upon such termination. The Company may immediately terminate this license upon notice to you, whereupon you shall immediately destroy all copies of the Program.

**WARRANTY:**

- (a) Inter-Tel warrants to You that the diskette(s), and/or other applicable software media on which the Inter-Tel Software program(s) are furnished are not defective under normal use for a period of ninety (90) days from the date of purchase, as evidenced by a copy of Your sales receipt.
- (b) Inter-Tel and its third-party suppliers and vendors' liability and Your exclusive remedy shall be the replacement of any diskette(s) and/or other applicable software media that do not meet the warranty and which are returned to Inter-Tel or an authorized dealer together with a copy of Your paid receipt. THE ABOVE IS THE ONLY WARRANTY OF ANY KIND. ALL OTHER WARRANTIES EITHER EXPRESS OR IMPLIED, INCLUDING, BUT NOT LIMITED TO, THE IMPLIED WARRANTIES OF MERCHANTABILITY AND FITNESS FOR A PARTICULAR USE ARE HEREBY DISCLAIMED. This warranty gives You specific legal rights and You may also have other rights which may vary from state to state.

You acknowledge that the Program, including the related documentation and any new releases, modifications and enhancements thereto, belongs to the Company, and that the Company retains all right, title and interest in and to the Program. You further acknowledge that the Program and information relating thereto constitute valuable

trade secrets of the Company. You agree to comply with the terms and conditions of this Agreement and agree to treat the Program as the confidential and proprietary information of the Company.

You shall be solely responsible for the supervision, management and control of your use of the Program and related products and documentation. You hereby indemnify and hold harmless the Company and its affiliates (the Indemnified Parties) against any loss, liability, damages, costs or expenses suffered or incurred by the Indemnified Parties at any time as a result, of any claim, action or proceeding arising out of or relating to your use, operation or implementation of the Program. For purposes of this Agreement, affiliate means any Company division or subsidiary or any other affiliated entity involved in the manufacture or wholesale distribution of Company products.

The Indemnified Parties shall not be responsible, and you shall have no recourse against the Indemnified Parties, for any loss, liability, damages, costs or expenses which may be suffered or incurred at any time by you as a result of your reliance upon or use of the Program, or as a result of any claim, action or proceeding against you arising out of or relating to the use of the Program, or as a result of your defense of any such claim, action or proceeding.

#### **LIMITS OF LIABILITY:**

In no event shall Inter-Tel or its third-party suppliers and vendors be liable for any losses (whether in tort, contract or otherwise) incurred in connection with the purchase, sale, possession, operation, or use of the Software (separately or in combination with other products) including, but not limited to loss of time, loss of anticipated profits, loss of data, loss of information, loss of business, loss of revenue, loss of goodwill or loss of anticipated savings or other business losses, losses relating to routing or programming errors, unauthorized use or access of all intrastate, interstate, and international long distance services, or such access or use by voice mail, DISA, auto attendant, or 800 or 900 services by end-users or unrelated third parties, losses related to the use of copyrighted music with Inter-Tel Software, and to the extent such limitation is permitted by applicable law, losses and damages resulting from physical injury to tangible property or death or injury of any person whether arising from Inter-Tel's negligence, breach of contract or otherwise. IN NO EVENT SHALL INTER-TEL OR ITS THIRD-PARTY SUPPLIERS AND VENDORS BE LIABLE FOR ANY INCIDENTAL OR CONSEQUENTIAL DAMAGES, DIRECTLY OR INDIRECTLY ARISING FROM USE OR INABILITY TO USE THE SOFTWARE, SEPARATELY OR IN COMBINATION WITH OTHER PRODUCTS. IN NO EVENT SHALL THE TOTAL LIABILITY OF INTER-TEL DAMAGES EXCEED THE AMOUNT PAID BY YOU FOR THE SOFTWARE.

#### **ENTIRE AGREEMENT:**

This Agreement constitutes the entire agreement between You and Inter-Tel and supersedes any and all prior agreements between Inter-Tel and You with regard to the Inter-Tel Software. No amendment, modification or waiver of this Agreement will be valid unless set forth in a written instrument signed by the party to be bound thereby. This Agreement shall be governed by the laws of the State of Arizona. No failure or delay on the part of Inter-Tel to enforce its rights hereunder shall operate as a waiver of any right.

This Agreement and any disputes arising hereunder shall be governed by the laws of the State of Arizona, United States of America, without regard to conflicts of laws principles. The parties hereby expressly exclude the application of the U.N. Convention on Contracts for the International Sale of Goods to the Agreement.

#### **GOVERNMENT RESTRICTED RIGHTS:**

The Software is provided with restricted rights. Use, duplication or disclosure by the government is subjected to restrictions set forth in subparagraph c (1) (ii) of the Rights in Technical Data and Computer Software clause at DFARS 252.227-7013 (Oct. 1988) and FAR 52.227-14 and 52.227-19 (June 1987). Contractor is Inter-Tel Integrated Systems, Inc., Chandler, Arizona 85226.

Inter-Tel Integrated Systems, Inc.  
Chandler, AZ 85226  
Revision D

# Overview

| <i>CONTENTS</i>                   | <i>PAGE</i> |
|-----------------------------------|-------------|
| <b>1. Introduction</b> .....      | <b>2-2</b>  |
| <b>2. About This Manual</b> ..... | <b>2-3</b>  |
| <b>3. System Hardware</b> .....   | <b>2-4</b>  |
| <b>4. Keysets</b> .....           | <b>2-5</b>  |
| <b>5. Feature Summary</b> .....   | <b>2-6</b>  |
| A. System Features .....          | 2-6         |
| B. Extension Features .....       | 2-7         |
| <b>6. System Capacities</b> ..... | <b>2-7</b>  |

## 1. INTRODUCTION

**1.1** The Encore System is a versatile and easy-to-use telephone system with the following features:

- Can accommodate up to eight loop-start lines and up to 18 extensions
- Has modular construction that allows it to be upgraded by adding various system expansion cards
- Can operate with system Keysets or standard single-line telephones
- Has remote access and maintenance capability
- Encore Keysets have a simple-to-use, menu-driven interface

**1.2** Your Encore system consists of the wall-mounted Key Service Unit (KSU), to which line and extension connections are made.

**1.3** The Encore System's modular design allows it to grow as your customer's business grows. No matter what size system you start with, you can expand up to the maximum capacity. The base system includes either two or four loop-start line and up to six extension connections. By adding system expansion cards to these base systems you can have up to eight loop-start lines and up to 18 extensions.

**1.4** The system Keypad has a large display area that features an intuitive menu-driven interface. Display Keys activate the features that are shown on the keypad's display. It is not necessary to dial any feature codes when using the Keypad. This makes the system easy to use and saves you time.

**1.5** You can choose to use system Keypads or single-line telephones at each extension, and you can change the combination at any time. A Doorphone is also available that can be programmed to ring at any extension. Optional equipment includes a doorstrike, a long-line extension, a central bell, external music-on-hold, and system Call Logging module and software.

**1.6** The Encore System is extremely flexible. You have the choice of operating the system as either a key system where all users have direct access to all lines for making and receiving calls, or as a PBX with all calls being answered by an operator, or as a combination of both.

**1.7** The Encore is easy to install and maintain. The system can be programmed and maintained remotely using the Remote Management Software. With this software, the system can also be configured to report alarms to service personnel.



## 2. ABOUT THIS MANUAL

**2.1** This *Installation, Programming, and Maintenance Manual* is your guide to installing, programming, and maintaining the Encore phone system.

- The Installation chapter covers the system equipment. (page 2-1)
- The Features chapter includes a description of the system's features and provides instructions for using a Keypad or standard single-line telephone with the system. (page 3-1)
- The Keypad Programming chapter is a system programming reference for using the keypad to perform programming functions. It also includes copies of the System Program Planning Sheets. (page 4-1)
- The RMS Programming chapter is a system programming reference for using the RMS software to perform most programming functions, excluding some specific keypad programming operations. (page 5-1)
- The RMS Maintenance chapter describes the Diagnostics, Pro-Active Maintenance, and System Timers portions of the Remote Management Software. (page 6-1)
- The Troubleshooting chapter details maintenance procedures. (page 7-1)
- The Parts chapter lists all system part numbers. (page 8-1)

### 3. SYSTEM HARDWARE

**3.1** The system Key Service Unit houses a CPU and a power supply unit. The CPU provides six extension interfaces but does not include any line interfaces; at least one Line card is required for line interfaces. The Main Distribution Frame (MDF) area of the CPU contains the connection points for all required extension and line cabling. (See [page 2-7](#) for cabling information.)

**3.2** The CPU also acts as a connection platform for all system expansion cards, as shown below. The system expansion cards are as follows:

- **Extension Card:** Each Extension Card provides interfaces for six extensions and a connector for a Line Card. You can install up to two Extension Cards for a total of 12 extensions, in addition to the six extensions provided by the CPU.
- **Line Card:** This card provides interfaces for two loop start lines. You can install two Line Cards on the CPU and one on each of the Extension Cards for a total of eight lines.
- **Voice Messaging Module:** This card provides up to 80 minutes of voice storage. When installed, a system Answering Machine can be enabled and each extension can be provided with a voice message box. The Voice Messaging Module is also required to provide a personalized greeting in the Courtesy and Auto Attendant services.

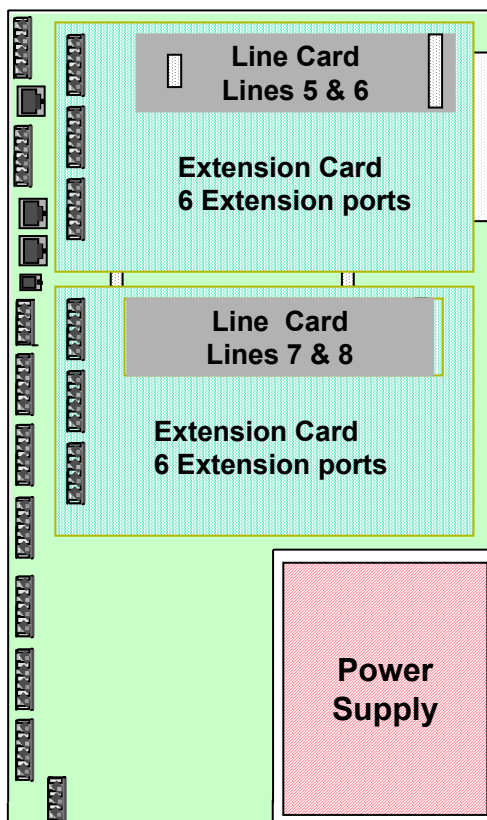

## 4. KEYSETS

**4.1** The system Keypad, shown below, is specially designed for use with the Encore system. It features a four-line display that shows prompts and menus with selectable options. This unique menu-driven interface makes the system simple to use – no codes are needed to program and activate features. System programming can also be performed via a Keypad using the intuitive menu-driven interface.

**4.2** The Keypad features eight Programmable Keys, which are pre-programmed to access lines, and four Function Keys which group frequently used features in a logical manner.

**4.3** The Keypad is fully handsfree, so you can make calls, receive calls, and use its features without lifting the handset.

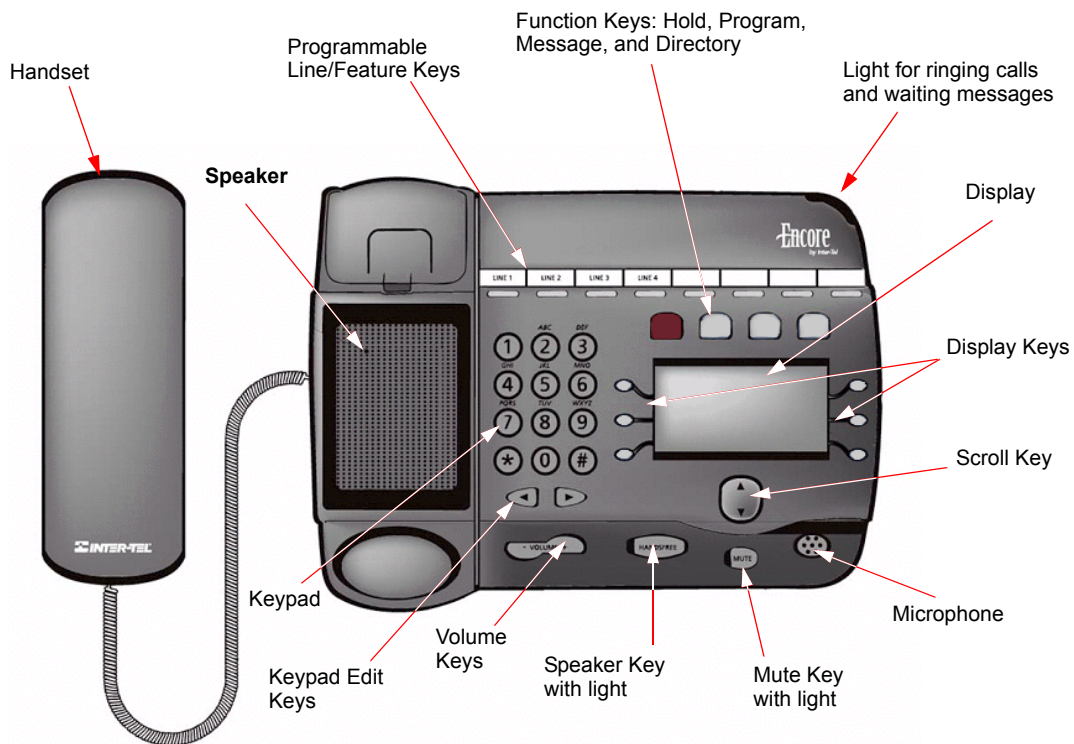

## 5. FEATURE SUMMARY

**5.1** System, keyset, single-line set, and attendant features are listed below. *Those features marked with an asterisk (\*) require additional equipment.* For complete descriptions and operating instructions, refer to the [Installation](#) (page 2-1) and [Features](#) (page 3-1) chapters.

### A. SYSTEM FEATURES

#### General System Features

- Flexible incoming ring assignments (alternate point answering)
- Flexible night ringing arrangement (night ring mode)
- Courtesy Service
- Variable system timers
- Internal paging
- \* Optional Voice Messaging with:
  - Customized Courtesy Service
  - Answering Machine Service
  - Auto-Attendant Service
- \* Optional Doorbox
- \* Optional door strike
- \* Optional external music source for outside call music-on-hold
- \* Optional external paging equipment
- \* Optional system battery back-up
- \* Optional long-line extension
- \* Optional central bell

#### System Maintenance and Record Keeping Features

- System Programming via Keyset (defaults to Extension 20)
- \* Optional Call Logging
- \* Remote Management Software

#### Outside Call Features

- Dual-tone multi-frequency (DTMF) or dial-pulse signaling
- CO line restriction
- Toll restriction
- Day and night modes of operation
- Busy CO line callback

## B. EXTENSION FEATURES

- Hands-free answering of internal calls on Keysets
- On-hook dialing on Keysets
- Direct line key selection on Keysets
- System/station speed dialing
- Last number redial
- System hold
- Conference calls
- Do-not-disturb
- Camp-on and call waiting
- Call transfer
- Call forwarding
- \* Headset compatible

## 6. SYSTEM CAPACITIES

- 6.1 This table details the capacities of various system options available.

**Table 1-1:** *System Capacities*

| Option                                                  | Capacity |
|---------------------------------------------------------|----------|
| Outside Lines                                           | 8        |
| Outgoing Line Groups                                    | 4        |
| Internal Speech Paths                                   | 4        |
| Extensions per System (Keysets and/or single-line sets) | 18       |
| Programming Extension (defaults to Extension 20)        | 1        |
| Operator Extension (Extension 20)                       | 1        |
| Long-Line Extension (Extension 22)                      | 1        |
| Doorphone Extension (Extension 23)                      | 1        |
| Extension Pick-Up Groups                                | 4        |
| Hunt Groups                                             | 4        |
| Voice Message Boxes (if Voice Module installed)         | 18       |
| Speed Dial                                              |          |
| — System Numbers                                        | 200      |
| — Personal Numbers (per extension)                      | 12       |
| Toll Restriction                                        |          |
| — Classes of Service                                    | 6        |
| — Tables                                                | 4        |



# Installation

## CONTENTS

## PAGE

|                                                               |             |
|---------------------------------------------------------------|-------------|
| <b>1. Introduction</b>                                        | <b>2-2</b>  |
| <b>2. System Installation Checklist</b>                       | <b>2-3</b>  |
| <b>3. Planning the Installation</b>                           | <b>2-4</b>  |
| A. Establish Suitable Environmental Conditions for the System | 2-4         |
| B. Assemble the Necessary Tools and Supplies                  | 2-6         |
| <b>4. Extension and CO Line Cabling</b>                       | <b>2-7</b>  |
| A. Running Cable                                              | 2-7         |
| B. Sample System Layout                                       | 2-8         |
| C. Terminating the Cables at Extension Locations              | 2-9         |
| D. Performing Loop Resistance Tests                           | 2-9         |
| E. Wiring for Operation During Power Failure Conditions       | 2-10        |
| F. Signals and Tones                                          | 2-10        |
| <b>5. Key Service Unit (KSU)</b>                              | <b>2-11</b> |
| A. KSU Description                                            | 2-11        |
| B. Unpack and Inspect The KSU                                 | 2-12        |
| C. Install the Expansion Cards in the KSU                     | 2-13        |
| D. Grounding the KSU                                          | 2-16        |
| E. Replace the KSU Cover                                      | 2-17        |
| F. Wall-Mount the KSU                                         | 2-18        |
| G. Connecting Cables to the KSU                               | 2-19        |
| <b>6. Keysets</b>                                             | <b>2-24</b> |
| A. Keyset Design Features                                     | 2-24        |
| B. Connecting the Keyset                                      | 2-24        |
| C. Attaching the Keyset Baseplate                             | 2-25        |
| D. Wall-Mounting a Keyset                                     | 2-25        |
| E. Optional Headsets                                          | 2-25        |
| <b>7. Single-Line Sets</b>                                    | <b>2-26</b> |
| <b>8. Long-Line Extension</b>                                 | <b>2-26</b> |
| <b>9. Optional Equipment</b>                                  | <b>2-26</b> |
| A. Doorphone                                                  | 2-27        |
| B. Doorstrike                                                 | 2-28        |
| C. External Music-On-Hold                                     | 2-29        |
| D. Paging Equipment                                           | 2-30        |
| E. Central Bell                                               | 2-30        |
| F. Call Logging Interface                                     | 2-31        |
| G. Programming Interface                                      | 2-31        |
| <b>10. Completing the Installation</b>                        | <b>2-32</b> |
| <b>11. Upgrading the System Software</b>                      | <b>2-37</b> |
| <b>12. Customer Training</b>                                  | <b>2-38</b> |

## 1. INTRODUCTION

**1.1** This section of the manual describes specifications and installation for the following Encore System hardware:

- Cabling and the Main Distribution Frame (MDF)
- Key Service Unit (KSU)
- Keysets and Single-Line Sets
- Optional Equipment

### NOTICE

This *Inter-Tel Encore Installation, Programming, and Maintenance Manual* instructs certified field technicians on the proper installation practices for the Encore System. This manual does not provide step-by-step instructions for premises wiring practices as dictated by the National Electrical Code, which includes, but is not limited to, cable layouts, cable installation, AC power installation, proper AC grounding, eliminating or preventing external interferences (including, but not limited to, RFI, EMI, lightning, AC power disturbances, static discharge), and other telephony practices standard within the industry. Cable installers, electricians, and field technicians are expected to be properly trained and, if applicable, licensed in their trade practices. ***Official Inter-Tel Encore certification is required for technical assistance.***



## 2. SYSTEM INSTALLATION CHECKLIST

**2.1** System installation is performed in the following order. Detailed instructions and figures for each step are located throughout this chapter.

- Read the safety and precaution information on [page xvii](#).
- Plan the installation, including the Key Service Unit (KSU) location, Keypad and single-line set locations, cable runs, and optional equipment. See [page 2-4](#) for details.
- Run cables to the keypad and single-line set locations. See [page 2-7](#) for details.
  - Run wiring to any optional equipment, such as the external paging equipment, external music source, long-line extension, Doorphone, doorstrike, or central bell.
  - Terminate the cables on modular jack assemblies at the Keypad and single-line set locations.
  - Perform the loop resistance test for each extension's cable.
- Install system expansion cards in the KSU, as necessary, to provide the required functionality. See [page 2-13](#) for details. At minimum, you should install the following:
  - At least one Line Card must be installed to make external calls.
  - A Extension Card must be installed if more than six extensions, or more than four lines are required.
  - A Voice Messaging Module must be installed to provide Voice Messaging or Answering Machine functionality.

### CAUTION

Equipment Damage Hazard. Turn off the system power supply when installing cards. Installing cards with the power on will damage the cards and void the warranty.

- Ground the Extension Cards and KSU. See [page 2-16](#) for details.
- Mount the KSU on the wall. See [page 2-18](#) for details.
- Connect the extension and line cabling to the KSU. See [page 2-19](#) for details.
- Install the telephones and any optional Keypad equipment, such as headsets. See [pages 24 through 26](#) for details.
- Turn on the system and ensure that all equipment is working properly. See [page 2-32](#) for details.
- Refer to the *Getting Started* document to perform initial programming for the system. See “RMS Programming” on [page 5-1](#) and “Keypad Programming” on [page 4-1](#) for information on detailed system programming.
- Provide customer training. See [page 2-38](#) for details.

### 3. PLANNING THE INSTALLATION

3.1 To make installation easier, use the following information when preparing to install the system.

#### A. ESTABLISH SUITABLE ENVIRONMENTAL CONDITIONS FOR THE SYSTEM

##### Location

3.2 The KSU is intended for installation in a residential or office-type environment. It must be mounted on a dry, flat wall.

3.3 Select the KSU location to minimize cable run length. Keysets and single-line sets connected to the system must not exceed a loop limit of 100 ohms (approximately 1500 feet/500 meters) using 24AWG wire. The long-line extension (Extension 22) loop limit is 366 ohms (1.2 miles/2 kilometers). The ohm values are loop measurements; the values in parentheses are the maximum one-way measurements from the KSU.

3.4 Allow sufficient free space all around the KSU for ventilation. Proper placement of the wall-mount bracket, as shown below, will allow sufficient space.

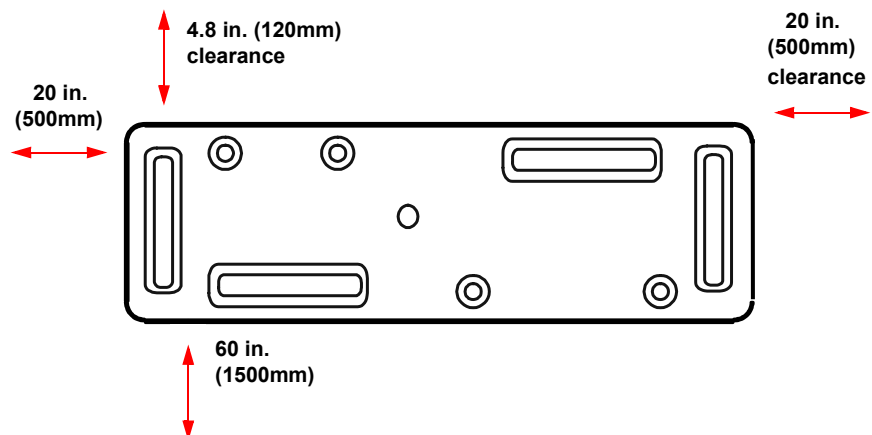

3.5 Allow room near the KSU for the paging amplifier, battery back-up equipment, and the external music source, if used. To avoid interference, the music source should be placed 5 to 10 feet (1.5 to 3 meters) away from the KSU. Make sure there are AC outlets for a music source and a paging amplifier, if they are to be installed. These outlets **MUST NOT** be on the same circuit as the outlet for the KSU.

##### Power Supply

3.6 Locate the KSU within 6 feet (2 meters) of an isolated, dedicated, 105–125VAC, 57–63Hz, 15A, single-phase commercial power source.

---

**NOTE:** This **must** be an isolated, dedicated AC circuit for proper operation. All three wires (power, neutral, and ground) must be run separately from the outlet to the breaker panel without being bonded to any other wire or circuit. **DO NOT** plug any other equipment into this outlet. To maintain the protection provided by the isolated, dedicated circuit, the length of the AC power cord limits the distance between the power supply and the outlet; **DO NOT** use an extension cord.

---

3.7 To reduce the effects of AC voltage surges and spikes that may cause system malfunctions, false logic, and/or damage to the electronic components, a surge/spike protector is recommended.

### Supervised CO Lines

**3.8** *Only supervised CO lines should be used on the Encore System.* While the system has timers that will help to prevent unsupervised trunk use, there is no implied warranty that it is invulnerable to unauthorized intrusions and toll fraud.

**3.9** If the central office does not provide supervision it will not disconnect the call when one party hangs up; it is possible for a caller to remain connected to a CO trunk circuit. If this happens, and the caller begins dialing, the call could be placed through the Encore System and would then be billed to the system's owner. The system cannot check this type of call for toll restriction and may not register the call in the call log. This problem could arise when a call is connected to an extension, when a call is in an unsupervised trunk-to-trunk call, or when a call is forwarded or transferred to the public network.

### Environment

**3.10** The KSU, Keysets, and single-line sets require the following environmental conditions:

**Table 2-1:** *Encore System Environmental Condition Requirements*

| REQUIREMENTS          | IN OPERATION                      | IN STORAGE                          |
|-----------------------|-----------------------------------|-------------------------------------|
| KSU Temperature       | 32° to 104° F<br>(0° C to +40° C) | 40° to 185° F<br>(-40° C to +85° C) |
| Telephone Temperature | 32° to 113° F<br>(0° C to +45° C) | 40° to 185° F<br>(-40° C to +85° C) |
| Relative Humidity     | 5% to 95%                         | 5% to 95%                           |

**NOTE:** It is recommended that the maximum operating temperature (as listed above) *never* be exceeded. Therefore, when installing the KSU and telephones, allow a sufficient margin for error in case of air conditioning failure, routine mechanical maintenance, plant shutdown, etc. As a general guideline, if the conditions are suitable for office personnel, they are also suitable for all equipment operation. A properly controlled environment will help to extend the operating life of the equipment.

**3.11** Do not expose the KSU location to direct sunlight, high humidity, heat, dust, or strong magnetic fields (such as those generated by heavy motors and large copy machines).

**3.12** Ample air space should be provided for the KSU since the power supply is convection cooled. **DO NOT** block the cooling vents located on the top and bottom of the KSU. Never place anything on top of the KSU.

## B. ASSEMBLE THE NECESSARY TOOLS AND SUPPLIES

**3.13** You will need the following supplies and tools:

- Industry-standard, two-pair (four-conductor), twisted-pair cable to run from the KSU to Keysets, single-line sets, and CO lines
- One or two 66M1-50-type block connectors
- Four-conductor modular jack assemblies for Keysets and single-line sets
- A high-impedance digital multimeter to check the correct wiring of the modular jack assemblies. Multimeter accuracy must be  $\pm 0.5\%$  or better.
- A surge/spike protector to protect the system from AC voltage surges.
- 18AWG wire for grounding
- Punch-down tools (provided) for the IDC Krone connectors
- Standard telephone hand tools and the mounting hardware for the KSU, modular jack assemblies, etc.
- Gas discharge tubes with silicon avalanche suppressors for lightning protection on the CO lines
- Assemble the optional equipment:
  - Headsets
  - External music source
  - External paging speakers and amplifier
  - Doorphone/door strike equipment
  - Call Logging Adapter and output device
  - Software, and PCs

## 4. EXTENSION AND CO LINE CABLING

**4.1** Prepare a floor plan for the Keyset and single-line set locations, using a star (home run) configuration. Include each telephone's extension number. Extension number 20 is assigned to the system operator.

### CAUTION

Avoid Fire Hazard. To reduce the risk of fire, use only 26AWG or larger line cord for CO line connections.

### A. RUNNING CABLE

**4.2** A 25-pair cable is run from the CO lines and extensions and terminated on a 66M1-50-type connecting block that is wall-mounted near the KSU. Then connections are made between the block and the MDF section of the KSU using 25-pair cable (see page 2-19). Finally, bridging clips are installed to complete the connections on the block. This installation method provides easy access to test points for troubleshooting and minimizes the need to change punched-down connections when moving equipment.

- CO line cabling runs from the RJ21X block to the 66M1-50-type connecting block.

---

**NOTE:** Gas discharge tubes with silicon avalanche suppressors should be installed on all CO lines for lightning protection. Also, in areas with frequent occurrences of lightning, it is recommended that the cable between the telephone company termination and the gas discharge tubes be at least 75 feet long (the cable may be coiled up if desired).

---

- All extension cables are terminated on the 66M1-50-type connecting block. The other end of each extension cable is terminated on a four-conductor modular jack assembly at the extension location. From the KSU location, run industry standard, two-pair (four-conductor) or 25-pair, twisted-pair cable to keysets and single-lines sets following these guidelines:
  - Install proper type cable for the application according to the National Electrical Code and local building codes. If using multi-pair (e.g., 25-pair) cable runs to multiple extension locations do not include CO lines in a cable being used for extensions. Extension circuits should be included in separate multi-pair cable runs.
  - Avoid cable runs parallel to fluorescent light fixtures or AC lines not in conduit. If these obstacles are unavoidable, run the cables across them at right angles.
  - Do not run extension cables inside electrical conduit already occupied by AC power cable. (To do so is a violation of the National Electrical Code.)
  - Do not run cables near equipment with electric motors or through strong magnetic fields, such as those generated by large copy machines, arc welding equipment, etc.
  - Do not run cables outdoors. The Encore System is designed for indoor wiring only.
  - Do not place extension cables where they can be stepped on or where they can be rolled over by office furniture.
  - Extension cables must not exceed a loop limit of 100 ohms (approximately 1500 feet/500 meters) using 24AWG wire. The long-line extension (Extension 22) loop limit is 366 ohms (1.2 miles/2 kilometers). The ohm values are loop measurements; the values in parentheses are the maximum one-way measurements from the KSU.

---

**NOTE:** It is recommended that four-conductor modular jacks be used for all Keyset and single-line set connections. This allows both types of telephones to be easily interchanged, if necessary. However, if desired, single-line sets can be installed using one-pair cable and four-conductor modular jacks.

---

## B. SAMPLE SYSTEM LAYOUT

**4.3** The diagram below shows a suggested layout for the KSU and block(s). You will need two blocks if Expansion cards are installed.

*Figure 2-1. Sample Layout and Cable Assignments*

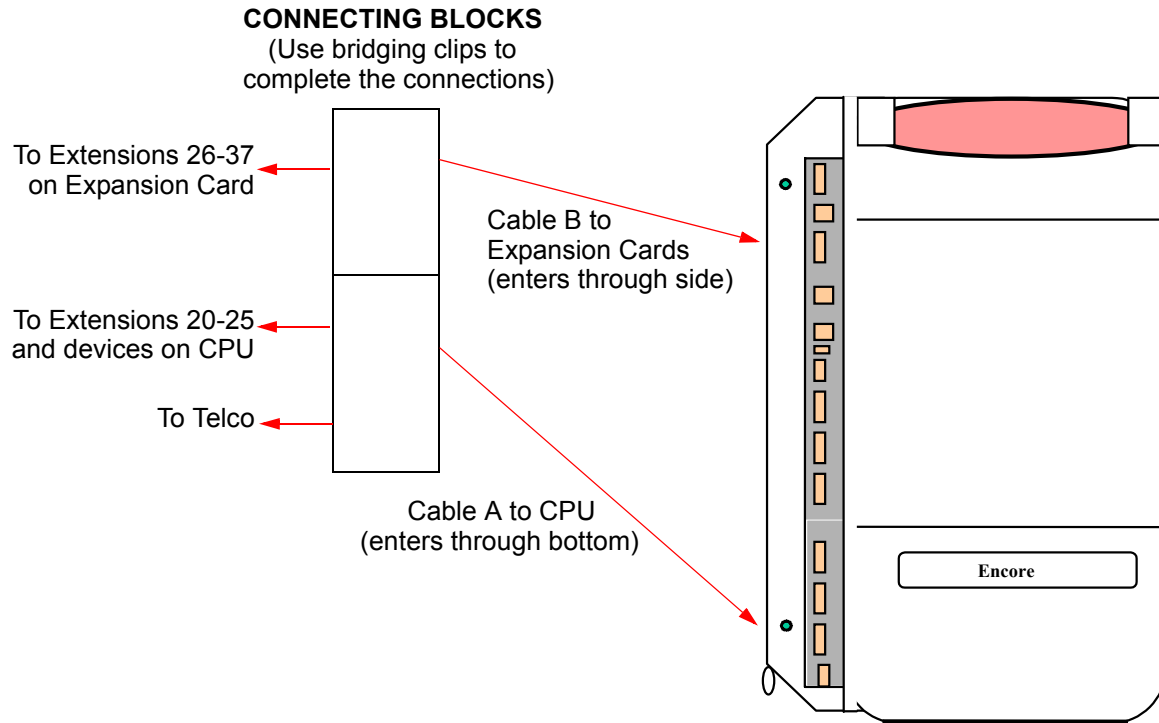

## C. TERMINATING THE CABLES AT EXTENSION LOCATIONS

**4.4** Terminate the keyset and single-line set cables on four-conductor modular jack assemblies at the extension location, as shown in the diagram below. Refer to the figure below for a wiring diagram.

**NOTE:** It is recommended that four-conductor modular jacks be used for all Keyset and single-line set connections. This allows both types of telephones to be easily interchanged, if necessary. However, if desired, single-line sets can be installed using one-pair cable and four-conductor modular jacks.

**Figure 2-2.** *Modular Jack Assembly Wiring*

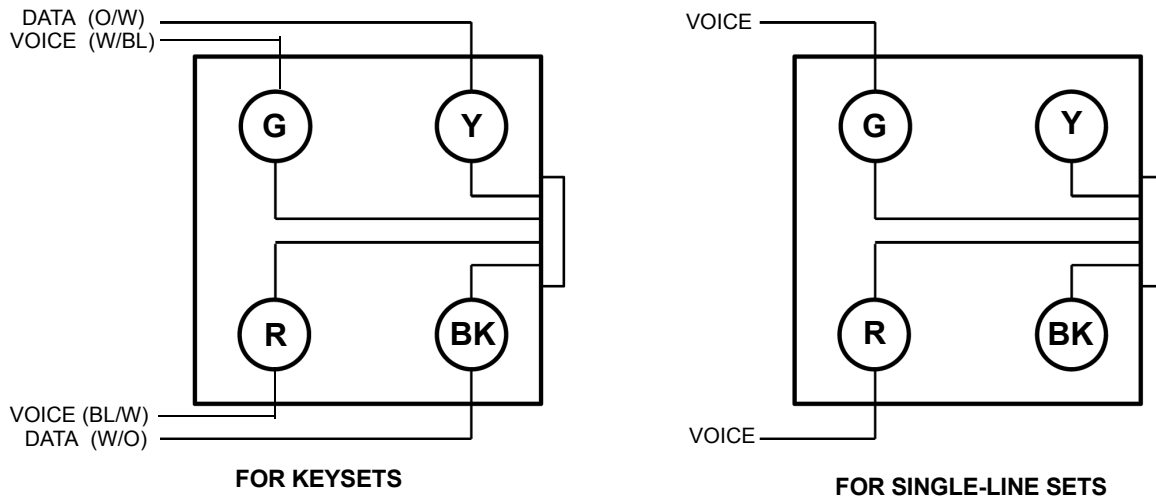

**NOTE:** Single-line sets use only the Voice pair, not the Data pair.

**4.5** Do not mount the assemblies on the wall at this time; they will be wall mounted later when the telephones are installed.

## D. PERFORMING LOOP RESISTANCE TESTS

**NOTE:** If performing the loop resistance test after the system is installed, unplug the keyset from the jack assembly. Then disconnect the bridging clips from the 66M1-50-type connecting block.

**4.6** Perform the following loop resistance test for each individual cable:

1. Ensure that the telephone is not connected to the modular jack assembly.
2. Place a short across the RED and GREEN wires on the modular jack assembly.
3. At the connecting block, measure the resistance across the Voice pair wires. The reading should not exceed 100 ohms (approximately 1500 feet/500 meters) using 24AWG wire. The long-line extension (Extension 22) loop limit is 366 ohms (1.2 miles/2 kilometers). The ohm values are loop measurements; the values in parentheses are the maximum one-way measurements from the KSU.

**NOTE:** Excessive and/or improperly made connections increase the resistance of a cable, which reduces the allowable cable run length.

4. Remove the short after the test is complete.

## E. WIRING FOR OPERATION DURING POWER FAILURE CONDITIONS

**4.7** When planning the extension wiring for the system, consideration should be given to the use of Keysets and single-line telephones in power-fail situations. As Keysets cannot operate without power, Extensions 24, 25, 31 and 37 should either have access to or be equipped with single-line sets if they are to be used in power failure situations.

**4.8** Each board with CO line capability is equipped with a power-failure circuit path. In the event of a total system power failure, at least 50% of the equipped lines are switched to extensions. Lines 1 and 2 are connected to extensions 24 and 25, the last two extensions on the CPU. Line 5 is connected to extension 31, and line 7 to extension 37, the last extensions on each of the Extension Cards. These line positions are summarized in the table below.

| CO LINE | POWER FAILURE EXTENSION |
|---------|-------------------------|
| Line 1  | Extension 24            |
| Line 2  | Extension 25            |
| Line 5  | Extension 31            |
| Line 7  | Extension 37            |

**NOTE:** If lines are connected to extension positions equipped with Keysets, the user must replace the Keyset with a single-line telephone to answer or make calls during a power failure. Keysets cannot be used during a power failure situation.

## F. SIGNALS AND TONES

### Ring Signals

**4.9** The system ringing signals are as follows:

| TYPE OF CALL   | RING SIGNAL                                                            |
|----------------|------------------------------------------------------------------------|
| Outside Call   | 2s on, 4s off                                                          |
| Internal Call  | 800 ms on, 400 ms off, 800 ms on, 4.0 seconds off                      |
| Doorphone Call | 800 ms on, 5200 ms off                                                 |
| Recalling Call | 800 ms on, 400 ms off, 800 ms on, 1000 ms off, 2000 ms on, 1000 ms off |

### Call Processing Signals

**4.10** The following signals and tones are heard through the handset or keyset speaker.

| TYPE OF CALL                                 | RING SIGNAL                                                 |
|----------------------------------------------|-------------------------------------------------------------|
| Dial Tone                                    | Continuous dual tone of 425 Hz $\pm$ 5% and 350 Hz $\pm$ 5% |
| Special Dial Tone<br>(Single-Line Sets only) | 900 ms on, 100 ms off of dial tone                          |
| Ringback                                     | 800 ms on, 400 ms off, 800 ms on, 4s off                    |
| Busy                                         | 500 ms on, 500 ms off                                       |
| Congestion                                   | 200 ms on, 200 ms off                                       |
| Hold                                         | 200 ms on, 200 ms off, 200 ms on, 3.4s off                  |
| Conference                                   | One burst of 200 ms                                         |
| Number Invalid                               | 100 ms on, 100 ms off                                       |
| Call Waiting                                 | 100 ms on, 4.9s off                                         |



## 5. KEY SERVICE UNIT (KSU)

### A. KSU DESCRIPTION

**5.1** The KSU is a compact, wall-mounted unit that houses the system power supply, the CPU, and the expansion cards. The KSU performs all control and switching activities for the system, including: detecting incoming CO calls, storing speed-dial numbers, processing data-controlled features, and controlling the interaction between keysets, single-line sets, CO lines, and voice channels.

**5.2** The KSU dimensions and weight are:

|        |                   |
|--------|-------------------|
| Height | 18 in. (450 mm)   |
| Width  | 12 in. (304.5 mm) |
| Depth  | 3 in. (71.6 mm)   |
| Weight | 5.5 lb. (2.5 kg)  |

**5.3** The CPU has 2MB of random-access memory (RAM) and 4MB of read-only memory (ROM). The software code for the system is stored in the non-volatile ROM memory, and the programmed database and speed-dial numbers are stored in the RAM memory.

**5.4** The RAM memory is protected by a capacitor. The capacitor will protect the programmed database until the accumulated system downtime exceeds 2-3 months (depending on the size of the database).

**5.5** The connectors on the CPU are shown below. Components that are not labeled are not currently used.

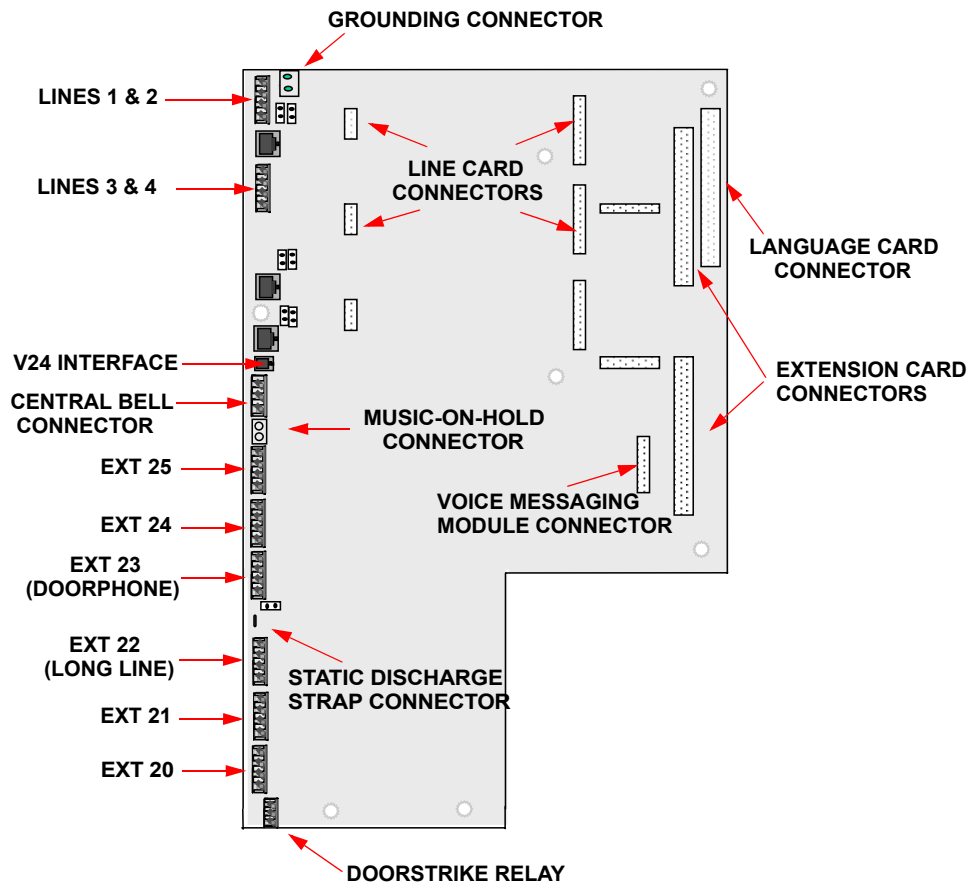

## B. UNPACK AND INSPECT THE KSU

### 5.6 Before beginning the installation:

1. Unpack the KSU and lay it on a flat surface with the cover facing up.
2. Remove the MDF cover by removing the retaining screw at the bottom and sliding the MDF cover upward. Open the KSU by loosening the two retaining screws on the left side of the cover and lifting the cover off the hooks located on the right side. (The screws on the KSU will not come completely out of the plastic.)

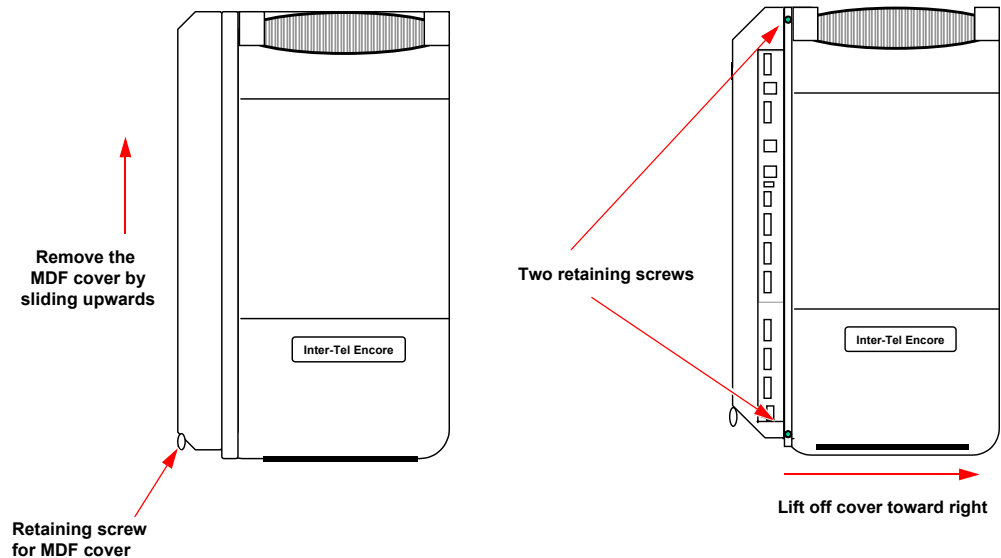

3. Inspect the KSU. If the KSU or any of its internal components are damaged, contact your supplier immediately.
4. Ensure that the correct Language Card is installed in the KSU. This card determines the language that will be used by the Courtesy Service prompts (it does not affect Voice Messaging). There are separate cards for English, Spanish, and French. See the Parts chapter for part numbers. If the wrong Language Card is installed, replace it with the correct card.

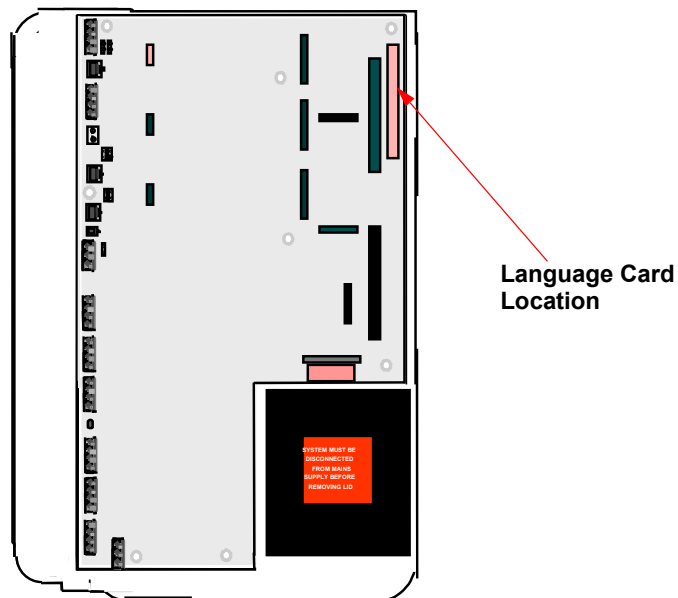

5. If you are installing one or more Expansion cards, proceed to the next section. Otherwise, replace the KSU cover; then proceed to [page 2-18](#).

## C. INSTALL THE EXPANSION CARDS IN THE KSU

### CAUTION

Electrostatic Discharge Hazard. The cards contain static-sensitive components. Lift them only by the edges and carefully handle the components. Always use electrostatic protection when inserting and removing circuit boards. Never insert or remove circuit boards when power is applied to the system.

**5.7** The KSU has circuitry for six extensions. Expansion cards add circuitry for additional extensions and CO lines. Up to two Extension Cards and four Line Cards can be installed as shown below.

**5.8** An optional Voice Messaging Module can also be installed. This card provides up to 80 minutes of voice storage for extension voice message boxes and the Answering Machine feature. It is also used for the Automated Attendant and Custom Courtesy Service features.

### Voice Messaging Module

**5.9** When the Voice Messaging Module is installed, a system Answering Machine can be enabled and each extension can be provided with a voice box. A minimum of two minutes storage is allocated automatically to each programmed extension. The remaining capacity is dynamically allocated.

**5.10** The Voice Messaging Module is also required to provide a personalized greeting in either the Courtesy or Auto Attendant services.

**5.11** The Voice Messaging Module is located on the CPU as shown below. To install, insert the module into the connector on the CPU.

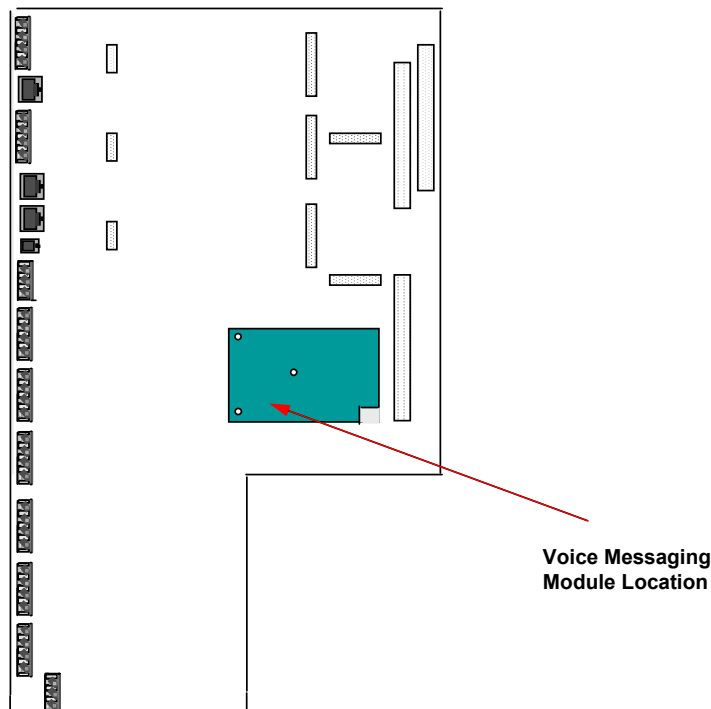

### Line Card

**5.12** The Line card adds two CO lines to the system. Because the CPU does not have CO line connectors, at least one Line Card must be installed for CO line access. Line Cards can be installed on the CPU or on Extension Cards, as shown below.

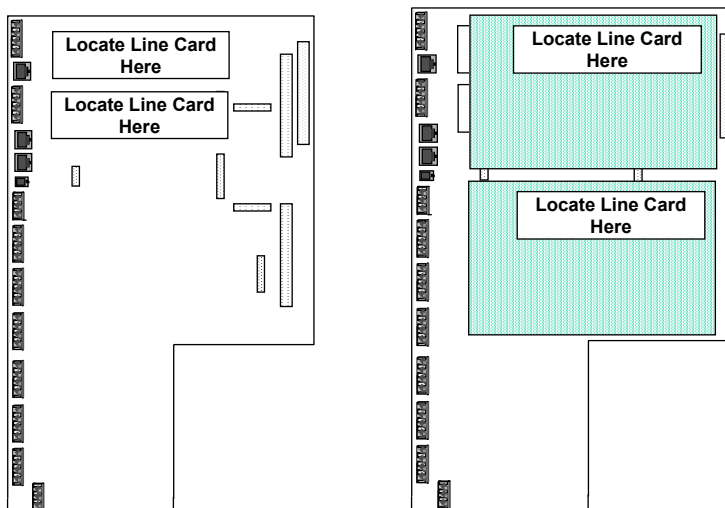

---

**NOTE:** If only one line on a two-port Line Card will be used, the second line must be disabled using system programming.

---

**5.13** To install, insert the Line Card into one of the connectors on the CPU or a connector on a Extension Card.

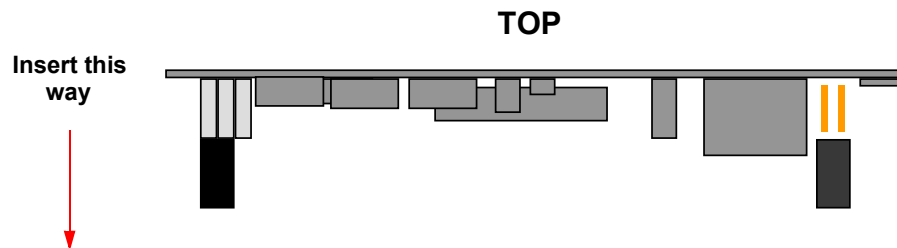

### Extension Card

**5.14** Each Extension Card has circuitry for an additional six extensions. Up to two Extension Cards can be installed.

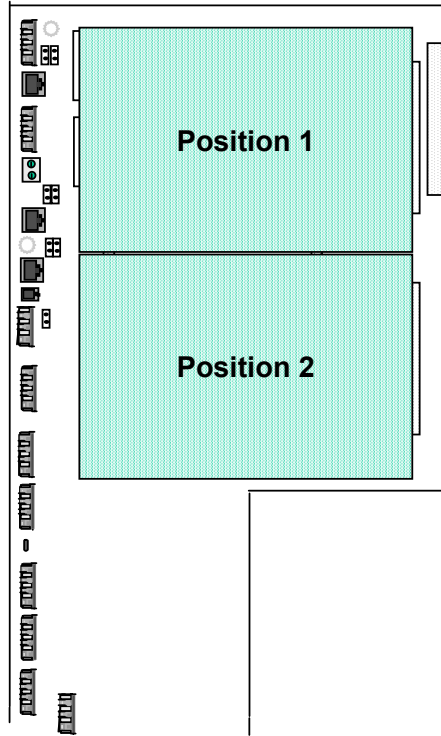

**5.15** The Extension Card has a grounding connector, Line Card and line connectors, and six extension connectors. The figure below shows the Extension Card connectors. The six extensions are numbered 26 through 31 for the card in the lower connector on the CPU and 32 through 37 for the card in the upper connector.

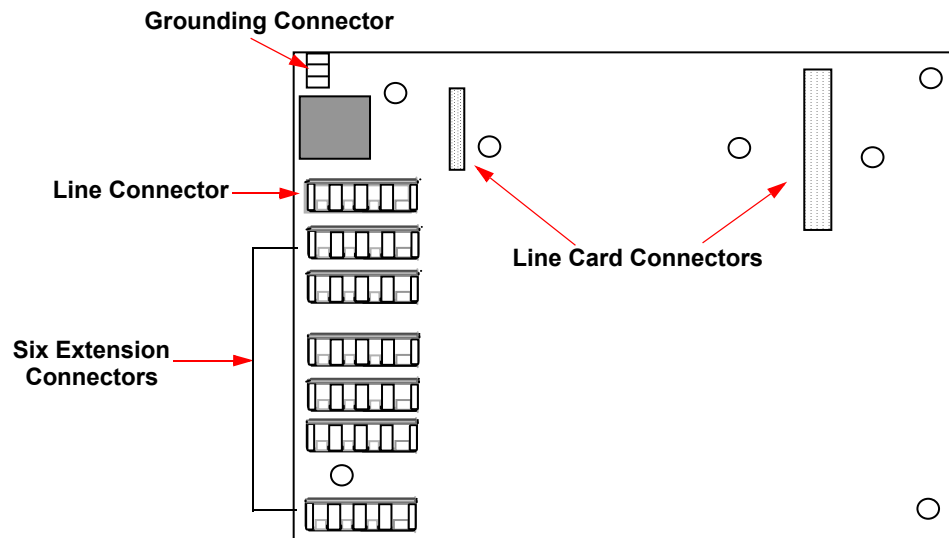

**5.16** To install, insert the Extension Card into the connectors on the CPU. The card must be inserted with the column support located under the line termination points as shown below.

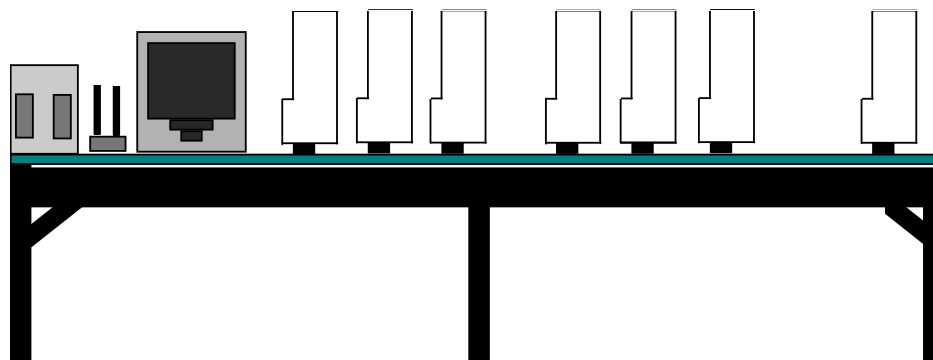

---

**NOTE:** To protect the system against high voltage surges on incoming CO lines (for example, caused by lightning), the ground connector on the Extension Cards must be connected to the grounding point on the CPU. Then the CPU must be attached to earth ground. It should also be equipped with a surge/spike protector (see next page).

---

#### D. GROUNDING THE KSU

**5.17** To protect the system against high voltage surges on incoming CO lines (for example, caused by lightning), the ground connector on the Extension Cards must be connected to the grounding point on the CPU. Then the CPU must be attached to earth ground. It should also be equipped with a surge/spike protector.

**5.18** To ground the cards and CPU, run wire to the grounding terminals as shown below. Then connect the grounding terminal on the CPU to an earth ground.

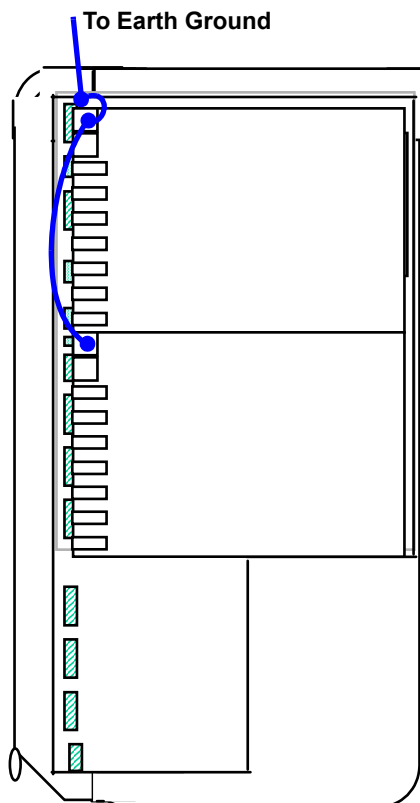

## E. REPLACE THE KSU COVER

**5.19** If expansion cards have been installed in the KSU, you must remove the break-off panels from the side of the KSU cover to allow access to the connectors.

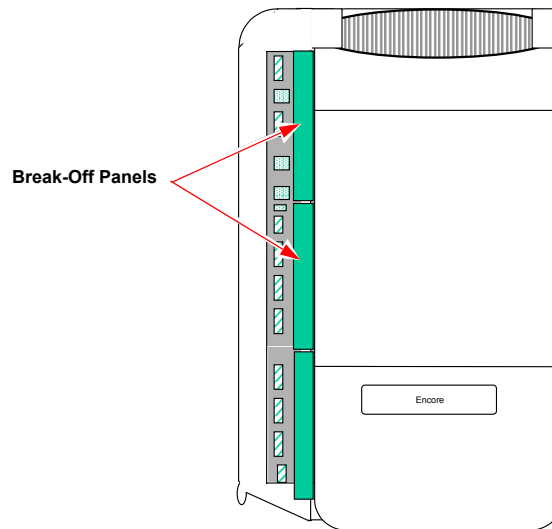

**5.20** Position the cover over the hooks on the right edge of the KSU and then lower the cover onto the KSU. Tighten the retaining screws on the cover.

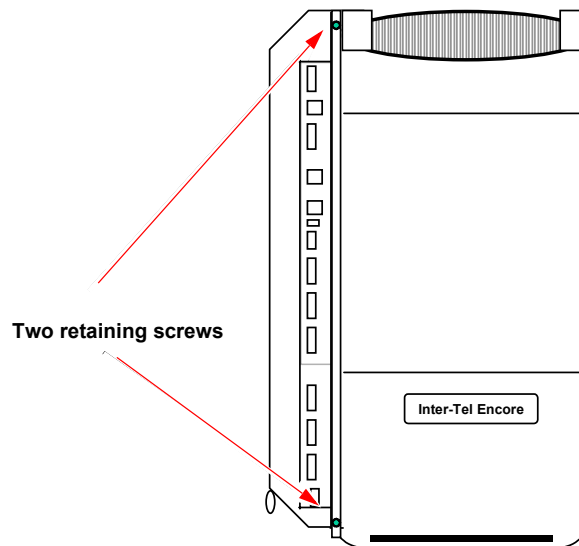

## F. WALL-MOUNT THE KSU

**5.21** When a suitable location has been found, mark the screw locations on the mounting surface, using the mounting bracket provided. Position the bracket on the wall and ensure that it is level. Mark the screw holes, then drill four holes in the wall at the marked locations. If the KSU is being mounted on masonry or plasterboard, use suitable fasteners.

**5.22** The figure below shows the mounting bracket and the necessary top and side clearances.

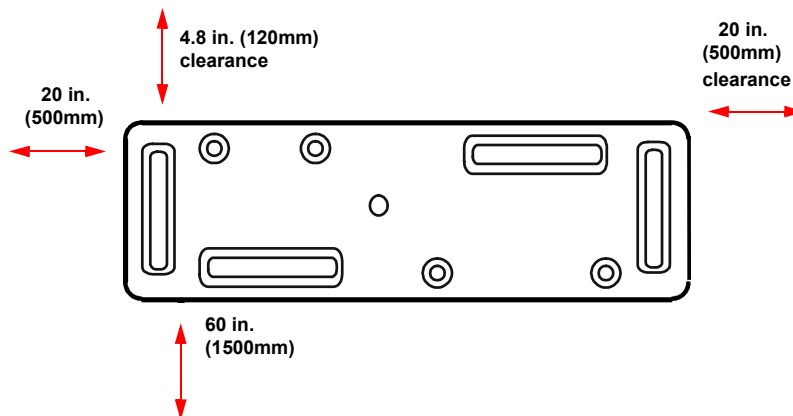

**5.23** Hang the KSU on the bracket, as shown in the figure below.

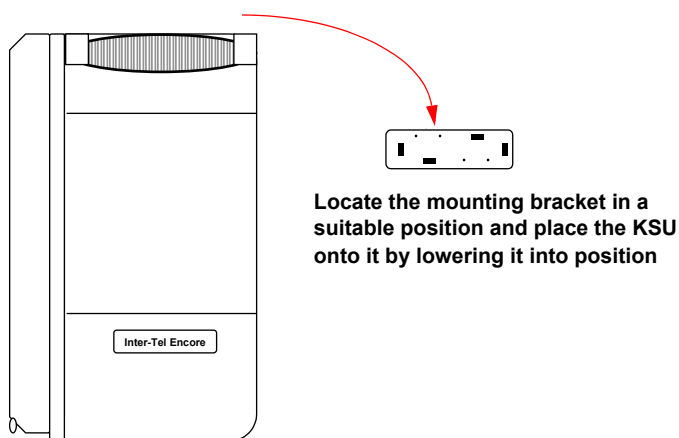



## G. CONNECTING CABLES TO THE KSU

### Wiring Technique

**5.24** The extension and line cables connected to the CPU enter the KSU at the bottom of the KSU, as shown below. Remove the break-out panel at the bottom of the KSU and pass the cables that will be connected to the CPU through the cable entry hole.

#### CAUTION

Safety Hazard. Remove only the knock-out panel(s) required for cable access to the KSU MDF area. Removing the other panels exposes the KSU circuitry unnecessarily and could create a safety hazard.

**5.25** Cables that will be attached to the Extension Cards are routed from the left side of the KSU, directly to the cards. (The breakout panels on the side are removed to allow access to the Extension Cards.)

**5.26** Pass cable-retaining straps through the hooks provided and pass the cables through the cable-retaining straps until they are adjacent to the appropriate connectors. The cables should be neatly guided into the channel space between the connectors and the KSU case side, ensuring that there is sufficient clearance between the cables and the KSU case lid. The cables should remain sheathed inside the KSU housing to within reach of the appropriate connector.

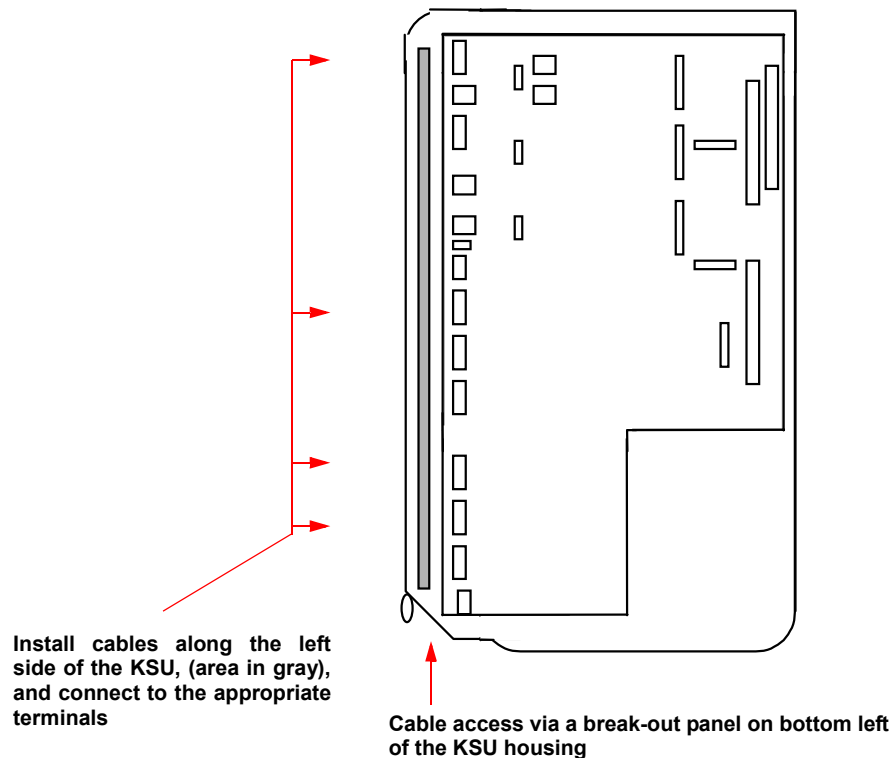

**5.27** The tables on the following pages show the connection points between the CPU connectors in the KSU and the 66M1-50-type connecting block, using the standard 25 pair cable color code.

### Connectors

**5.28** The KSU and Extension Cards are equipped with 4-wire IDC Krone connectors. The same connector type is used to terminate the CO lines as is used to terminate the extensions. To punch down the extension and line cables on the IDC Krone connectors, use the special punch-down tool, provided with the KSU.

**FIGURE 3.** *Main CPU Connections — Cable A*

**Table 2-2:** *Main CPU Connections - Cable A*

| CABLE PAIR | CONNECTION   | DEVICE       |
|------------|--------------|--------------|
| W-BL       | VOICE-A      | Ext 20       |
| BL-W       | VOICE-B      |              |
| W-O        | DATA-C       |              |
| O-W        | DATA-D       |              |
| W-G        | VOICE-A      | Ext 21       |
| G-W        | VOICE-B      |              |
| W-BR       | DATA-C       |              |
| BR-W       | DATA-D       |              |
| W-S        | VOICE-A      | Ext 22       |
| S-W        | VOICE-B      |              |
| R-BL       | DATA-C       |              |
| BL-R       | DATA-D       |              |
| R-O        | VOICE-A      | Ext 23       |
| O-R        | VOICE-B      |              |
| R-G        | DATA-C       |              |
| G-R        | DATA-D       |              |
| R-BR       | VOICE-A      | Ext 24       |
| BR-R       | VOICE-B      |              |
| R-S        | DATA-C       |              |
| S-R        | DATA-D       |              |
| BK-BL      | VOICE-A      | Ext 25       |
| BL-BK      | VOICE-B      |              |
| BL-O       | DATA-C       |              |
| O-BK       | DATA-D       |              |
| BK-G       | MOH          | Music Source |
| G-BK       |              |              |
| BK-BR      | CENTRAL BELL | Central Bell |
| BR-BK      |              |              |
| BK-S       | DOOR STRIKE  | Door Strike  |
| S-BK       |              |              |
| Y-BL       | Not Used     | None         |
| BL-Y       |              |              |
| Y-O        |              |              |
| O-Y        |              |              |
| Y-G        | TIP          | Line #1      |
| G-Y        | RING         |              |
| Y-BR       | TIP          | Line #2      |
| BR-Y       | RING         |              |
| Y-S        | TIP          | Line #3      |
| S-Y        | RING         |              |
| V-BL       | TIP          | Line #4      |
| BL - V     | RING         |              |
| V-O        | TIP          | Line #5      |
| O - V      | RING         |              |
| V-G        | TIP          | Line #6      |
| G - V      | RING         |              |
| V-BR       | TIP          | Line #7      |
| BR - V     | RING         |              |
| V-S        | TIP          | Line #8      |
| S - V      | RING         |              |

**FIGURE 4.** *Expansion Card Connections — Cable B*

**Table 2-3:** *Expansion Card Connections - Cable B*

| CABLE PAIR | CONNECTION | DEVICE |
|------------|------------|--------|
| W-BL       | VOICE-A    | Ext 26 |
| BL-W       | VOICE-B    |        |
| W-O        | DATA-C     |        |
| O-W        | DATA-D     |        |
| W-G        | VOICE-A    | Ext 27 |
| G-W        | VOICE-B    |        |
| W-BR       | DATA-C     |        |
| BR-W       | DATA-D     |        |
| W-S        | VOICE-A    | Ext 28 |
| S-W        | VOICE-B    |        |
| R-BL       | DATA-C     |        |
| BL-R       | DATA-D     |        |
| R-O        | VOICE-A    | Ext 29 |
| O-R        | VOICE-B    |        |
| R-G        | DATA-C     |        |
| G-R        | DATA-D     |        |
| R-BR       | VOICE-A    | Ext 30 |
| BR-R       | VOICE-B    |        |
| R-S        | DATA-C     |        |
| S-R        | DATA-D     |        |
| BK-BL      | VOICE-A    | Ext 31 |
| BL-BK      | VOICE-B    |        |
| BL-O       | DATA-C     |        |
| O-BK       | DATA-D     |        |
| BK-G       | VOICE-A    | Ext 32 |
| G-BK       | VOICE-B    |        |
| BK-BR      | DATA-C     |        |
| BR-BK      | DATA-D     |        |
| BK-S       | VOICE-A    | Ext 33 |
| S-BK       | VOICE-B    |        |
| Y-BL       | DATA-C     |        |
| BL-Y       | DATA-D     |        |
| Y-O        | VOICE-A    | Ext 34 |
| O-Y        | VOICE-B    |        |
| Y-G        | DATA-C     |        |
| G-Y        | DATA-D     |        |
| Y-BR       | VOICE-A    | Ext 35 |
| BR-Y       | VOICE-B    |        |
| Y-S        | DATA-C     |        |
| S-Y        | DATA-D     |        |
| V-BL       | VOICE-A    | Ext 36 |
| BL - V     | VOICE-B    |        |
| V-O        | DATA-C     |        |
| O - V      | DATA-D     |        |
| V-G        | VOICE-A    | Ext 37 |
| G - V      | VOICE-B    |        |
| V-BR       | DATA-C     |        |
| BR - V     | DATA - D   |        |
| V-S        | Not Used   | None   |
| S - V      |            |        |

### CO Line Connections

**5.29** The first A and B pair on each Line Card is used to terminate one line and the second C and D pair is used to terminate a second line. Refer to the chart on [page 2-20](#) for wiring connections.

**5.30** CO lines 1 to 4 are terminated in the CPU connectors, as shown below. The cables for these connections are routed into the KSU through the breakout panel at the bottom.

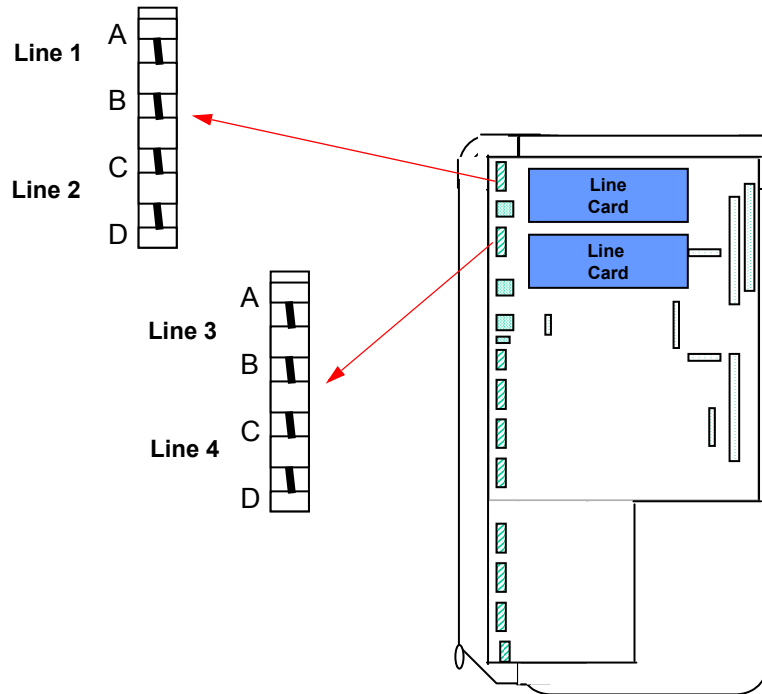

**5.31** CO lines 5 to 8 are terminated on the two Extension Cards, as shown below. The first Extension Card provides a connector for lines 5 and 6 and the second Extension Card provides a connector for lines 7 and 8. The cables for these connections are routed into the KSU from the left, through the breakout panels on the KSU cover.

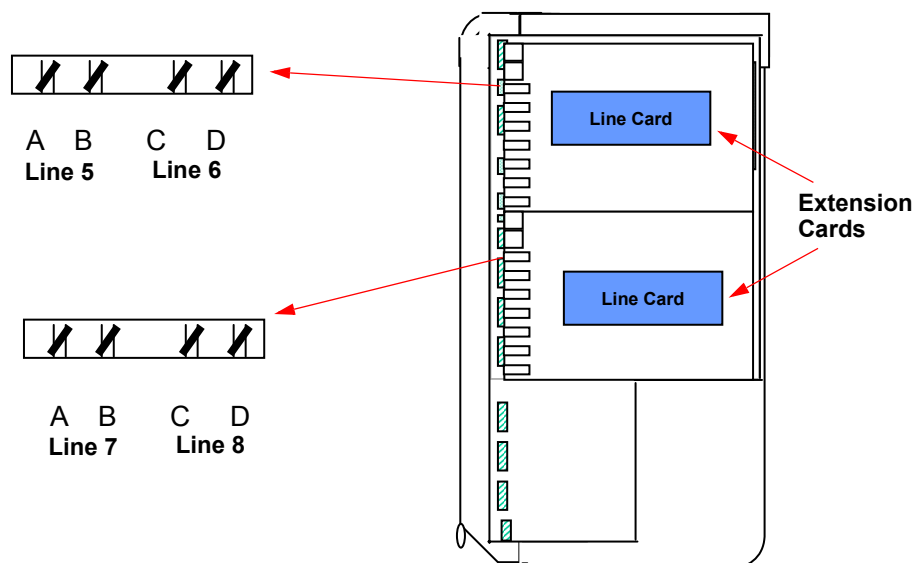

**Extension Connections**

**5.32** Extensions 20 to 25 are terminated on the CPU, as shown below. Note that extensions are numbered from the bottom up. Refer to the charts on pages 20 and 21 for wiring connections. The cables for these connections are routed into the KSU through the breakout panel at the bottom.

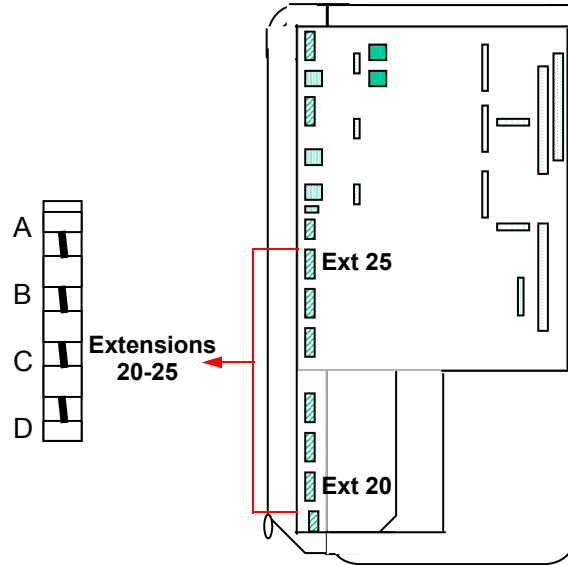

**5.33** Extensions 26 to 37 are terminated on the Extension Cards, as shown below. The cables for these connections are routed into the KSU from the left, through the breakout panels on the KSU cover.

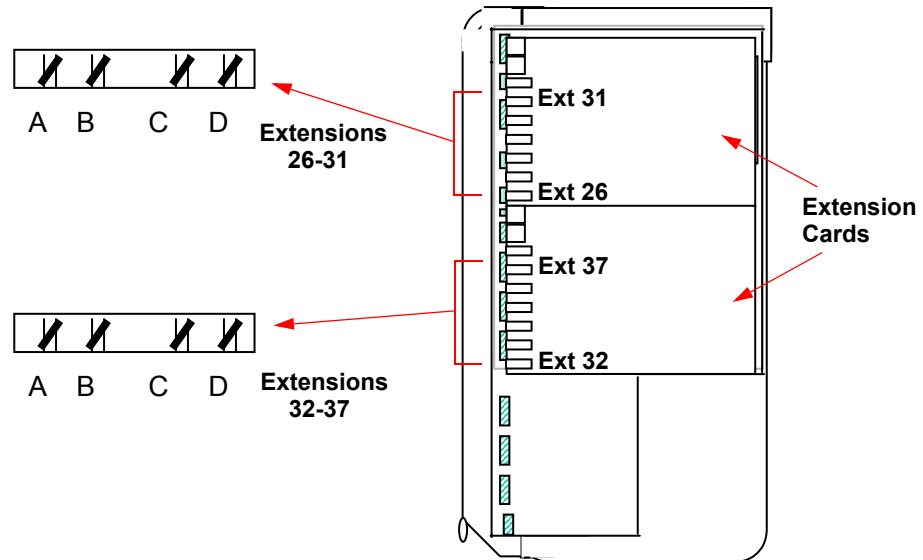

**5.34** The A&B and C&D connections are used for Keysets. Single-line sets require only the A&B connections.

## 6. KEYSETS

**6.1** The system has capacity for up to 18 extensions. Extensions can be equipped with Encore Keysets or industry-standard single-line sets.

### A. KEYSSET DESIGN FEATURES

#### Integrated Speakerphone

**6.2** A built-in, integrated speakerphone is standard in the Keysets. It allows users to place and receive internal calls without lifting the handset. Once a call is connected, the Keyset user may speak handsfree over the speakerphone or lift the handset to speak privately.

**6.3** When using the handset, the user may switch to the speakerphone by pressing the Speaker key and replacing the handset. If enabled, pages may be broadcast over the speaker when the phone is not being used.

#### Liquid Crystal Display (LCD)

**6.4** Each Keyset has a liquid crystal display (LCD). The display helps the user to process calls more efficiently. There are display messages for date and time, numbers dialed, incoming calls, extension and system status, features, and programming. These displays are indicated throughout the [Features](#) section of the manual.

### B. CONNECTING THE KEYSSET

**6.5** Ensure that the extension loop resistance test has been performed before installing the keysets. (See [page 2-9](#).)

**6.6** Install all keysets as follows:

1. Mount the modular jack assembly on the wall.
2. Plug one end of the coiled handset cord into the handset jack on the left side of the keyset. Plug the other end into the handset. Place the handset on hook.
3. Plug one end of the keyset line cord into the modular jack. Plug the other end into the line cord jack.
4. After all keysets are installed, turn on the KSU AC power switch.

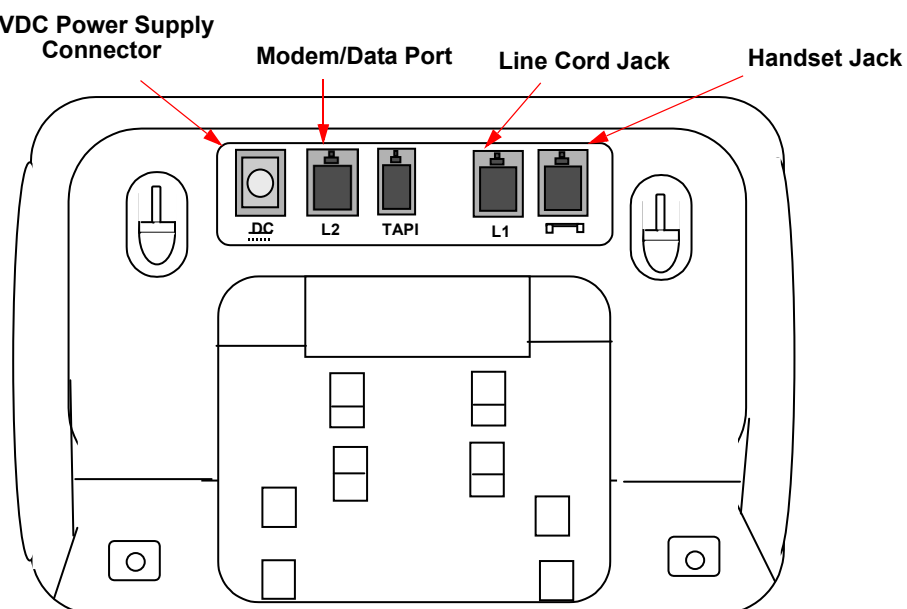

### C. ATTACHING THE KEYSSET BASEPLATE

**6.7** There are retaining clips on the baseplate that allow it to be attached to the keyset at two different angles. When the correct viewing angle has been selected, clip the baseplate onto either the lower or upper slot on the underside of the Keyset.

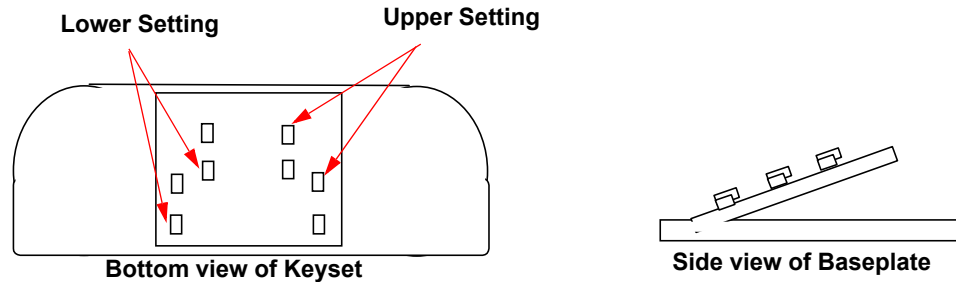

### D. WALL-MOUNTING A KEYSSET

**6.8** Locate, drill and plug the two screw locations as shown below. The holes should be deep enough to accept a 1-inch (25 mm) screw. Install the two screws, leaving .25 to .75 inches (3 or 4 mm) protruding. Remove the baseplate from the base of the phone and position the two keyhole slots on the base of the Keyset over the two screws. (The baseplate is not used.) Then slide the keyset into place.

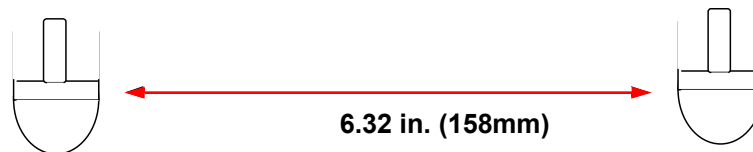

**6.9** The handset retaining clip, located directly below the hookswitch, must be reversed so that the handset is secure when the phone is wall-mounted.

**6.10** When the Keyset is wall mounted, you can hang the handset on the top edge of the Keyset housing if you need to set the handset down during a call.

### E. OPTIONAL HEADSETS

**6.11** The Keysets are compatible with industry-standard, four-conductor, modular headsets that have electret microphones.

**6.12 To attach a headset to a keyset:**

1. Remove the coiled handset cord from the handset jack on the base of the keyset. Leave the handset in the cradle.
2. Insert the headset modular plug into the handset jack. Plug in the headset power source, if used.
3. If the headset has an on/off switch, turn on the headset.

## **7. SINGLE-LINE SETS**

**7.1** Industry-standard, AC-ringing, single-line DTMF sets may be installed on an Encore System.

**7.2** Single-line set users access features simply by lifting the handset and entering a feature code or by using a combination of a hookflash and a feature code. Refer to the Features section of this manual (page 3-1) for details.

**7.3 To install a single-line set:**

1. Mount the modular jack assembly on the wall.
2. Plug one end of the line cord into the modular jack assembly and plug the other end into the jack on the single-line set.

## **8. LONG-LINE EXTENSION**

**8.1** Extension 22 is designed to work with a single-line telephone at a distance of up to 1.2 miles (2 km) away from the KSU.

- If Extension 22 is used as a long-line extension, a single-line telephone extension must be used.
- The maximum cabling distance is 1.2 miles (2 km), 330 ohms, or 3 dB at 1600 Hz. Distance assumes 24 AWG (0.5 mm) diameter copper cabling.
- The cabling must be internal.

## **9. OPTIONAL EQUIPMENT**

**9.1** The following optional system equipment can be installed:

- Doorphone
- Doorstrike
- External Music Source
- External Paging Equipment
- Central Bell
- Call Logging Output Device



## A. DOORPHONE

**9.2** An external Doorphone is available that can be installed on the Encore System. (See PARTS for part numbers.) When a person presses a button on the Doorphone, the unit generates ringing on the extensions programmed to receive Doorphone calls. After answering the ringing call, a system user can talk with the person at the door.

**9.3** In database programming, make sure that the desired keysets have access to the Doorphone. Refer to [page 4-13](#) for details. The Doorphone can be mounted using the supplied bracket.

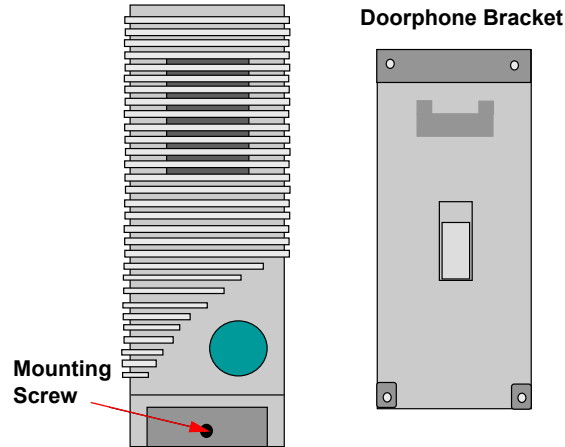

**9.4** To install the Doorphone, connect the single pair from the Doorphone to the A and B connections of Extension 23 on the CPU.

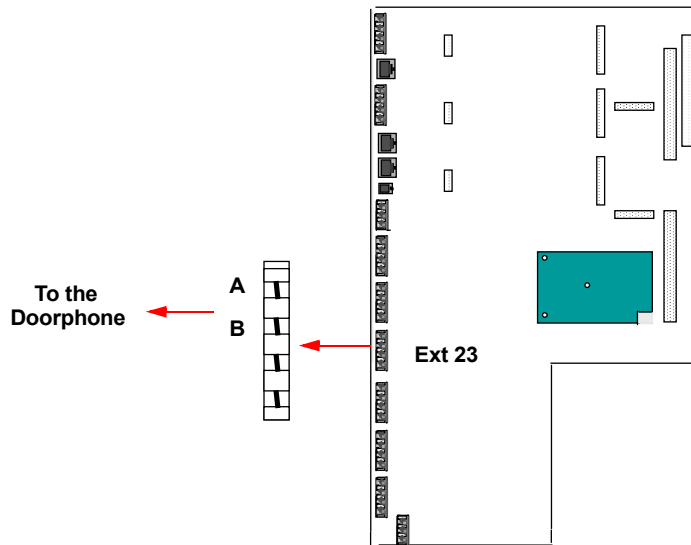

## B. DOORSTRIKE

**9.5** The doorstrike two-way connector provides a closed relay contact when in the operated condition. The relay contact is suited only for use with low voltage DC equipment. (Rating: 24VDC, 2 Amps).

**9.6** If the door is equipped with an electric strike plate, a system user may open the door by dialing a code or pressing a feature button.

---

**NOTE:** You must purchase the doorstrike mechanism and arrange for a qualified electrician to install it. Also, for security reasons, be careful not to place an extension, that can open the doorstrike, too close to a window or other point of access.

---

**9.7** The leads from the CPU A and B connector are connected to the doorstrike, as shown below. This is the connector used for the optional doorstrike mechanism.

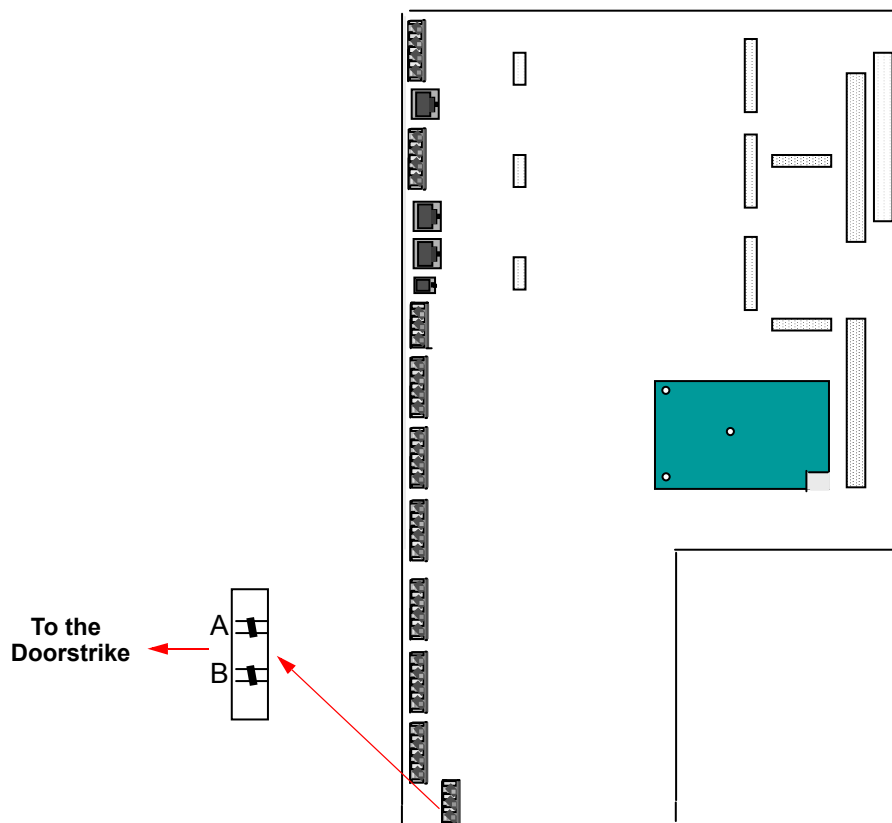

## C. EXTERNAL MUSIC-ON-HOLD

**9.8** If a customer-provided music source is not installed, the internal music-on-hold circuitry provides music for CO lines on hold. However, an external source (such as a radio, tape player, etc.) can be installed and programmed to provide music-on-hold.

**9.9** The music source is connected to the CPU using a fixed-screw terminal.

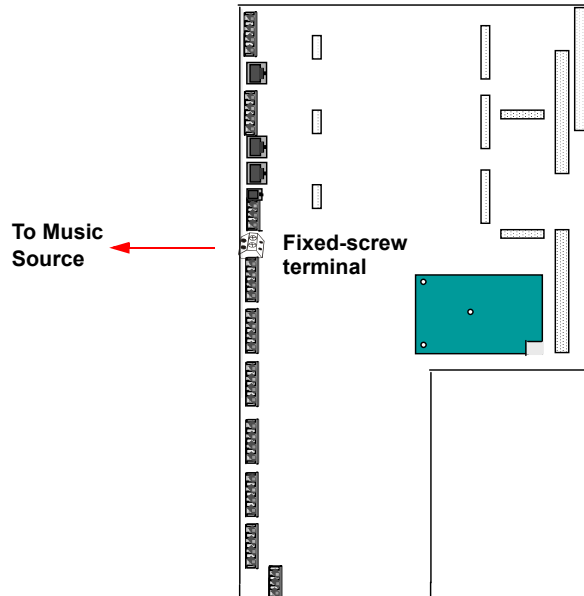

**9.10** The music-on-hold circuitry automatically holds the volume to a predetermined level that is slightly lower than normal voice volume, as required by FCC regulations.

**NOTE:** In some circumstances, there may be broadcast restrictions associated with the music. Check with the music's original distributor and/or the radio station for copyright and broadcast restrictions concerning music-on-hold.

**9.11** If using a radio as a music source, place it five to 10 feet away from the KSU to avoid RFI generated by the KSU. If the radio is placed more than 10 feet away from the KSU, use twisted-pair cable. For better reception, a radio with an external antenna is recommended.

**9.12 To install the music source:**

1. Using a 5- to 10-foot (1.5- to 3.0-meter) length of coaxial cable, connect one end of the cable to the speaker output terminals of the music source.

**NOTE:** If the music source has an earphone jack, you can attach an 1/8-inch mini phone plug or other specified connector and plug it into the earphone jack on the music source. However, if the earphone jack is "padded" so that the optimal volume level cannot be reached, the procedure above may be most effective.

2. Attach the other end of the coaxial cable to the two-pin screw terminal on the CPU.
3. Plug in the AC power cord for the music source. **DO NOT** use the outlet for the KSU.
4. Turn on the AC power to the music source.
5. Enable music-on-hold at the Programming Keyset (see [page 4-10](#) for procedures).
6. From a keyset, select a CO line and dial the telephone number of one of the other lines to call back into the system. Put the call on hold to hear the music. Adjust the volume on the music source to the desired level. The optimum input level is 1.0VRMS (0dB).

## D. PAGING EQUIPMENT

**9.13** The Encore can be configured to operate with external paging equipment (speaker and amplifier). The paging equipment can be connected to any extension position.

**9.14 To install the external paging equipment:**

1. Cut a length of shielded speaker cable (or coaxial cable) to run from the paging amplifier to the KSU.
2. Connect one end of the cable to the amplifier high-impedance input according to the manufacturer's instructions.
3. Connect the other end of the cable to an extension connector on the CPU or Extension Card.
4. Connect the speaker(s) to the amplifier, using speaker cable.
5. Plug in the amplifier's AC power cord. **DO NOT** use the outlet for the KSU.
6. Set the amplifier volume control to the lowest setting and turn on the amplifier.
7. Enable the Paging equipment in system programming (see [page 4-13](#) for details).
8. From a keyset, make a page. Adjust the amplifier to the desired level while placing the page.

## E. CENTRAL BELL

**9.15** The CPU has a connector that supplies a ringing signal when the Central Bell is programmed to ring for an incoming call on a line or line group (refer to [page 4-25](#) for details). The Central Bell is connected to the KSU, as shown below.

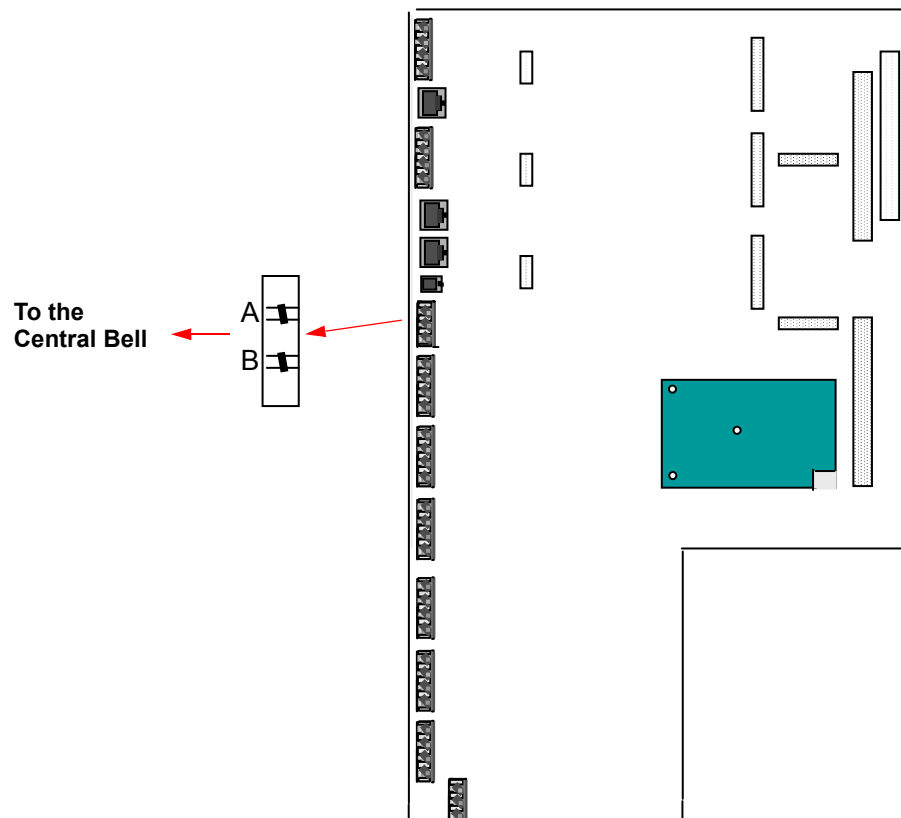

## F. CALL LOGGING INTERFACE

**9.16** If desired, an optional Call Logging Adapter and a output device (printer, terminal, etc.) can be connected to the Encore System to provide call records. The device allows the programmer to print useful call information. See [page 3-47](#) for more details.

**9.17** The Call Logging connection is programmable to use 4800, 9600, or 19200 (default) bps. Other communications settings are: 8 bits, no parity, and 1 stop bit.

**9.18** The Call Logging Interface is attached to the CPU using a V24 Adapter and a 3-foot (1-meter) RJ22-to-RJ22 cable, as shown below.

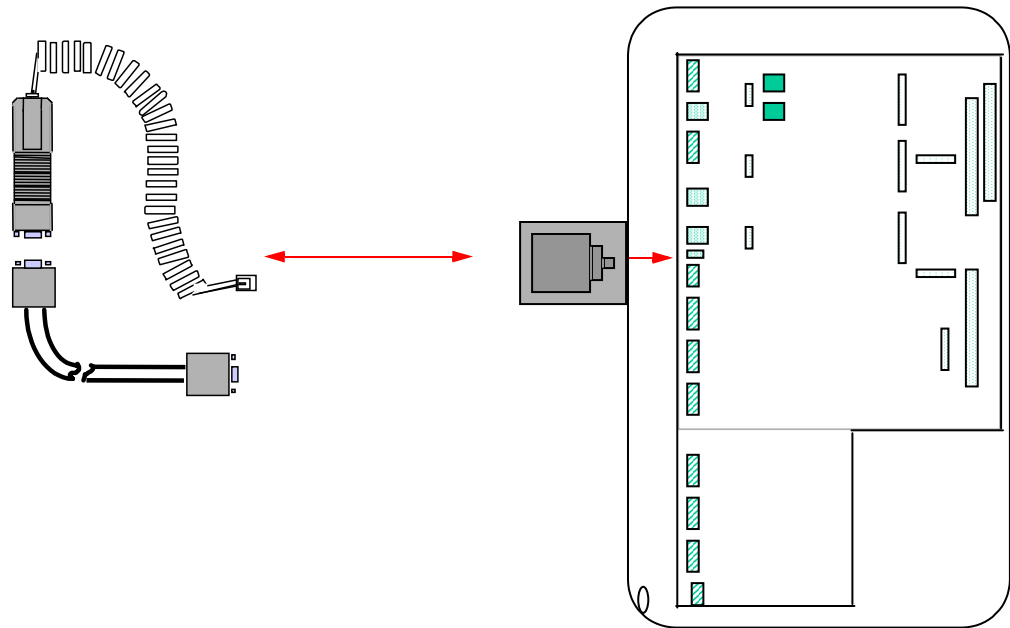

**NOTE:** A standard DB-9 to DB-25 converter connector can be used to connect the external serial port to output device that is not equipped with a DB-9 connector.

**9.19** The V24 Adapter has the following pinout:

**Table 2-4:** V24 Adapter Pinouts

| V24 CONNECTOR | PIN DESCRIPTION         | 25-PIN CONNECTOR |
|---------------|-------------------------|------------------|
| Pin 1         | DCD Data Carrier Detect | Pin 8            |
| Pin 2         | Receive Data            | Pin 3            |
| Pin 3         | Transmit Data           | Pin 2            |
| Pin 4         | DTR Data Terminal Ready | Pin 20           |
| Pin 5         | Signal Ground           | Pin 7            |
| Pin 6         | DSR Data Set Ready      | Pin 6            |
| Pin 7         | RTS Request To Send     | Pin 4            |
| Pin 8         | CTS Clear To Send       | Pin 5            |
| Pin 9         | RI Ring Indicate        | Pin 22           |

## G. PROGRAMMING INTERFACE

**9.20** If desired, the V24 Adapter (shown above) and a PC with Remote Management Software can be connected to an Encore Keyset to provide remote programming and maintenance. For details, refer to “RMS Programming” on [page 5-1](#).

## 10. COMPLETING THE INSTALLATION

### 10.1 To complete the system installation:

1. Using suitable precautions against electrostatic discharge, ensure that all system expansion cards are secured correctly and that all column supports are installed to their relevant positions.
2. Verify all extension and line terminations on the connecting block and the KSU.
3. Ensure there are no screws or metal objects loose within the KSU housing because these may cause damage on power up.
4. Power up and test the system:
  - a. Plug in the KSU power supply.
  - b. Wait 8-10 seconds for the system power up routine to complete. During this period, you will hear several clicks as relays are energized.
  - c. Check that the Vital Activity LED on the CPU is flashing (see below).
  - d. The system Keyset displays will show the product name and software revision for about 1.5 seconds.

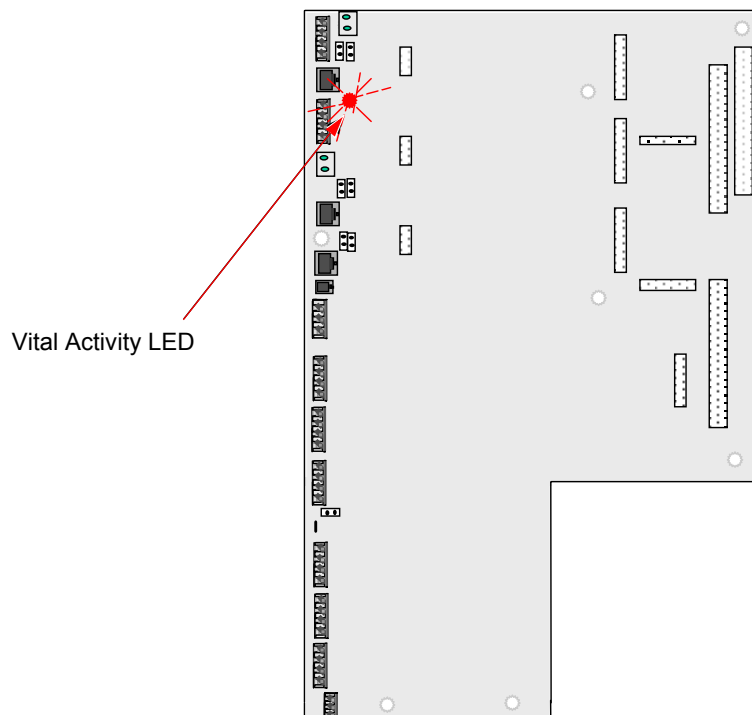

5. Remove any anti-scratch protective film from all Keyset displays.
6. Label all Keysets.
7. Reset the system. (See [page 4-14](#) for details).
8. Ensure that all Keysets provide dial tone, ringing, and handsfree operation. Check that the display is not showing corrupt information.
9. Check that all single-line telephones are providing dial tone and ringing.

10. Perform basic programming. Planning sheets are provided so you can record the settings. Refer to the Programming chapters (“Keyset Programming” on [page 4-1](#) and “RMS Programming” on [page 5-1](#)) to perform additional programming changes from the default, as required.
  - a. Disconnect line interfaces that have no CO lines connected. (See [page 5-31](#).) The system assumes that all Line Cards have CO lines connected to them.
  - b. Program extensions and call routing.  
 Program extensions using RMS. Refer to [page 5-17](#) for information. Use the planning sheet below to record your settings.

**Table 3:** *Call Handling/Extension Names*

| EXTENSION | NAME | FORWARD BUSY | FORWARD BUSY/NO ANSWER | MANAGER (IF SECTY) |
|-----------|------|--------------|------------------------|--------------------|
| 20        |      |              |                        |                    |
| 21        |      |              |                        |                    |
| 22        |      |              |                        |                    |
| 23*       |      |              |                        |                    |
| 24        |      |              |                        |                    |
| 25        |      |              |                        |                    |
| 26        |      |              |                        |                    |
| 27        |      |              |                        |                    |
| 28        |      |              |                        |                    |
| 29        |      |              |                        |                    |
| 30        |      |              |                        |                    |
| 31        |      |              |                        |                    |
| 32        |      |              |                        |                    |
| 33        |      |              |                        |                    |
| 34        |      |              |                        |                    |
| 35        |      |              |                        |                    |
| 36        |      |              |                        |                    |
| 37        |      |              |                        |                    |

\* Extension 23 is the Doorphone.

c. Enable and/or disable features.

Enable or disable desired features using RMS. Refer to [page 5-19](#) for information. Use the planning sheet below to record your settings.

Place a check mark in the box to indicate which extensions will have each of the features *enabled*.

**Table 4:** *Enabled/Disabled Features*

| PROGRAMMING OPTION         | 20 | 21 | 22 | 23* | 24 | 25 | 26 | 27 | 28 | 29 | 30 | 31 | 32 | 33 | 34 | 35 | 36 | 37 |
|----------------------------|----|----|----|-----|----|----|----|----|----|----|----|----|----|----|----|----|----|----|
| Tone Protect               |    |    |    |     |    |    |    |    |    |    |    |    |    |    |    |    |    |    |
| Page Protection            |    |    |    |     |    |    |    |    |    |    |    |    |    |    |    |    |    |    |
| General Call Protection    |    |    |    |     |    |    |    |    |    |    |    |    |    |    |    |    |    |    |
| Extension Disconnect       |    |    |    |     |    |    |    |    |    |    |    |    |    |    |    |    |    |    |
| No Call Logging            |    |    |    |     |    |    |    |    |    |    |    |    |    |    |    |    |    |    |
| No Trunk-to-Trunk Calls    |    |    |    |     |    |    |    |    |    |    |    |    |    |    |    |    |    |    |
| Personal Caller ID List    |    |    |    |     |    |    |    |    |    |    |    |    |    |    |    |    |    |    |
| Voice Messaging            |    |    |    |     |    |    |    |    |    |    |    |    |    |    |    |    |    |    |
| System Speed Dial Override |    |    |    |     |    |    |    |    |    |    |    |    |    |    |    |    |    |    |
| Restrict Use Of PA         |    |    |    |     |    |    |    |    |    |    |    |    |    |    |    |    |    |    |
| Door Restrict              |    |    |    |     |    |    |    |    |    |    |    |    |    |    |    |    |    |    |
| Voice Mail Password        |    |    |    |     |    |    |    |    |    |    |    |    |    |    |    |    |    |    |
| Reminder Call              |    |    |    |     |    |    |    |    |    |    |    |    |    |    |    |    |    |    |
| Extension Lock Code        |    |    |    |     |    |    |    |    |    |    |    |    |    |    |    |    |    |    |
| Voice Message Ports        |    |    |    |     |    |    |    |    |    |    |    |    |    |    |    |    |    |    |

\* Extension 23 is the Doorphone.

d. Equip lines and telephone numbers.

Equip lines and telephone numbers using RMS. Refer to [page 5-31](#) for information on equipping lines. Refer to [page 5-37](#) for information on setting caller ID detection. Use the planning sheet below to record your settings.

**TABLE 5.** *Equipped Lines, Telephone Numbers and Caller ID*

|        | EQUIPPED? | TELEPHONE NUMBER | CALLER ID DETECTION |
|--------|-----------|------------------|---------------------|
| Line 1 |           |                  |                     |
| Line 2 |           |                  |                     |
| Line 3 |           |                  |                     |
| Line 4 |           |                  |                     |
| Line 5 |           |                  |                     |
| Line 6 |           |                  |                     |
| Line 7 |           |                  |                     |
| Line 8 |           |                  |                     |



- e. Program answering machine and courtesy service.

Refer to [page 5-31](#) for information on programming the answering machine and courtesy service features. Use the planning sheet below to record your settings.

*TABLE 6. Answering Machine, Courtesy Service and Auto Attendant*

| LINE   | ANSWERING MACHINE |          | COURTESY SERVICE (DAY/ NIGHT) |                 | AUTO ATTENDANT |          |         |          |
|--------|-------------------|----------|-------------------------------|-----------------|----------------|----------|---------|----------|
|        | Enabled           | Disabled | Voice Module Source           | Internal Source | Day            |          | Night   |          |
|        |                   |          |                               |                 | Enabled        | Disabled | Enabled | Disabled |
| Line 1 |                   |          |                               |                 |                |          |         |          |
| Line 2 |                   |          |                               |                 |                |          |         |          |
| Line 3 |                   |          |                               |                 |                |          |         |          |
| Line 4 |                   |          |                               |                 |                |          |         |          |
| Line 5 |                   |          |                               |                 |                |          |         |          |
| Line 6 |                   |          |                               |                 |                |          |         |          |
| Line 7 |                   |          |                               |                 |                |          |         |          |
| Line 8 |                   |          |                               |                 |                |          |         |          |

- f. Program system-wide features.

Refer to [page 5-37](#) for information on programming system-wide features. Use the planning sheet below to record your settings.

*TABLE 7. System-wide Features*

| PROGRAMMING OPTION                     | ALLOWED VALUES                                             | PROGRAMMED VALUE |
|----------------------------------------|------------------------------------------------------------|------------------|
| Weekend Service                        | On or Off                                                  |                  |
| Flashing Hold LED                      |                                                            |                  |
| Call Logging                           |                                                            |                  |
| Store All Calls (Caller ID)            |                                                            |                  |
| Doorphone                              |                                                            |                  |
| System Voicebox On (Answering Machine) |                                                            |                  |
| 911 & Extension Sending                |                                                            |                  |
| Night Service                          |                                                            |                  |
| Night Service On and Off Times         | HH:MM (24-Hour format)                                     |                  |
| Music On Hold                          | Internal source, External source, Tone on hold, or Silence |                  |
| Programming Position                   | Any equipped extension                                     |                  |
| Paging Amplifier Position              | Any extension                                              |                  |
| System Programming Password            | Four digits                                                |                  |
| Set V24 Baud Rate                      | 4800, 9600, 19200                                          |                  |
| Courtesy Service Source                | Voice Module or Internal                                   |                  |
| Sales Telephone Number                 |                                                            |                  |
| Service Telephone Number               |                                                            |                  |
| Message Capacity                       | 10 – 50                                                    |                  |
| Group Divert to System Box             | On or Off                                                  |                  |

- g. Record greetings.

Refer to [page 4-11](#) for information on programming system-wide features. Use the planning sheet below to record your settings.

*TABLE 8. Recorded Greetings*

| GREETING                    | MESSAGE |
|-----------------------------|---------|
| Auto Attendant Day Greeting |         |
| Auto Attendant Night        |         |
| Courtesy Service Day        |         |
| Courtesy Service Night      |         |
| Directory Message           |         |

## 11. UPGRADING THE SYSTEM SOFTWARE

---

**NOTE:** Check that RMS is installed before performing this procedure.

---

### 11.1 To upgrade the system software:

1. Ensure your phone system PC meets the following requirements for the upgrade version of the Remote Management Software.
  - PC with Remote Management Software for Service Centers (RMS v2.0.8x).
  - V24 adapter and cables
  - Software version 4.0 files (4.0x\_1.fdl and 4.0x\_2.fdl)
  - Flat screw driver
  - Electrostatic Discharge (ESD) wrist strap
2. Record and/or save the customer database and programming details. System speed dials can be saved and restored using RMS.
3. Download Flash files. Disable Power Management features if you are using a laptop.
  - Copy the files **4.0x\_1.fdl** and **4.0x\_2.fdl** to the Remote Maintenance Software directory or a directory on the PC hard disk (the files *must* be located in the same directory).
  - Connect to the KSU using RMS and the V24 connection.
  - From the RMS main menu, select Options – **Download Flash**.
  - Browse to the flash files (.fdl files).
  - Select **4.0x\_1.fdl**.
  - Select the download flash option. The files 4.0x\_1.fdl and 4.0x\_2.fdl are automatically downloaded to the KSU.

The flash download takes approximately 25 minutes. The system alerts you when the flash is finished.
  - Click **OK**.

---

**NOTE:** The download drops the connection between the PC and the KSU.

---

4. Connect to the KSU. From the RMS main menu, select Diagnostic Menu – **Cold Reset**.

---

**NOTE:** The reset drops the connection between the PC and the KSU.

---

5. Restore system speed dials using RMS (page 5-42). When finished, exit RMS.
6. Proceed to “Upgrading the RMS Software” on page 5-4.

## 12. CUSTOMER TRAINING

**12.1** After you complete the installation, make sure the customer is trained to use the system. At minimum, this should cover the following:

- Use of the Keypad menus and associated keys
- Receiving, making, and transferring calls
- Accessing system programming
- Use of Voice Messaging features

**12.2** Explain the features using the *Encore Installation, Programming, and Maintenance Manual* and the *Encore User Guide*. All manuals are provided on the Encore CD-ROM. You will need a free [Adobe Acrobat Reader](#) to access the files.

# Features

## CONTENTS

## PAGE

|            |                                                                   |             |
|------------|-------------------------------------------------------------------|-------------|
| <b>1.</b>  | <b>Introduction</b> .....                                         | <b>2-3</b>  |
| <b>2.</b>  | <b>Feature Keys and Codes</b> .....                               | <b>2-3</b>  |
|            | A. Feature Codes .....                                            | 2-3         |
|            | B. Single-Line Only Codes .....                                   | 2-4         |
|            | C. Operator-Only Codes .....                                      | 2-4         |
|            | D. Extension Numbers .....                                        | 2-4         |
|            | E. Outgoing Line Access .....                                     | 2-4         |
| <b>3.</b>  | <b>CO Line Features</b> .....                                     | <b>2-5</b>  |
|            | A. Dual-Tone Multi-Frequency (DTMF) or Dial-Pulse Signaling ..... | 2-5         |
|            | B. Flexible Incoming Ring Assignment .....                        | 2-5         |
|            | C. Outgoing Line Groups .....                                     | 2-5         |
|            | D. Day and Night Modes and Weekend Service .....                  | 2-5         |
|            | E. Outgoing Line Access/Restriction .....                         | 2-6         |
|            | F. Toll Restriction Classes Of Service .....                      | 2-6         |
|            | G. Caller ID .....                                                | 2-7         |
|            | H. Alternative Call Routing .....                                 | 2-9         |
|            | I. Operation with a Parent PBX .....                              | 2-9         |
| <b>4.</b>  | <b>Protection Against Power Failure</b> .....                     | <b>2-10</b> |
|            | A. Database Protection .....                                      | 2-10        |
|            | B. Power Failure Telephones .....                                 | 2-10        |
| <b>5.</b>  | <b>Extensions</b> .....                                           | <b>2-11</b> |
|            | A. Keysets .....                                                  | 2-11        |
|            | B. Single-Line Sets .....                                         | 2-16        |
|            | C. Doorphone Units .....                                          | 2-17        |
|            | D. Hot Line Extensions .....                                      | 2-17        |
| <b>6.</b>  | <b>Courtesy Service</b> .....                                     | <b>2-18</b> |
| <b>7.</b>  | <b>Voice Messaging Module Features</b> .....                      | <b>2-19</b> |
|            | A. Automated Attendant .....                                      | 2-19        |
|            | B. Answering Machine .....                                        | 2-20        |
|            | C. Voice Messaging .....                                          | 2-20        |
| <b>8.</b>  | <b>Music-On-Hold</b> .....                                        | <b>2-23</b> |
| <b>9.</b>  | <b>Internal Calls</b> .....                                       | <b>2-23</b> |
|            | A. Keypad Handsfree Enable/Disable .....                          | 2-23        |
|            | B. Extension-To-Extension Calling .....                           | 2-24        |
|            | C. Camp On .....                                                  | 2-24        |
|            | D. Extension Ring Back .....                                      | 2-25        |
|            | E. General Call .....                                             | 2-25        |
| <b>10.</b> | <b>Outside Calls</b> .....                                        | <b>2-26</b> |
|            | A. Receiving Outside Calls .....                                  | 2-26        |
|            | B. Placing Outside Calls .....                                    | 2-26        |
|            | C. Line Ring Back .....                                           | 2-29        |
|            | D. Call Pick-Up .....                                             | 2-29        |

| <i>CONTENTS</i>                                       | <i>PAGE</i> |
|-------------------------------------------------------|-------------|
| <b>11. Placing Calls On Hold or Park</b> .....        | <b>2-30</b> |
| A. Hold .....                                         | 2-30        |
| B. Call Park .....                                    | 2-30        |
| C. Consultation Hold .....                            | 2-31        |
| <b>12. Call Waiting</b> .....                         | <b>2-31</b> |
| <b>13. Call Waiting Tone Protection</b> .....         | <b>2-32</b> |
| <b>14. Call Transfer</b> .....                        | <b>2-32</b> |
| <b>15. Redirecting Ringing Calls</b> .....            | <b>2-33</b> |
| <b>16. Call Forwarding</b> .....                      | <b>2-33</b> |
| A. Forwarding Calls .....                             | 2-34        |
| B. Canceling Call Forward .....                       | 2-34        |
| C. Follow Me Forwarding .....                         | 2-35        |
| <b>17. Conference Calls</b> .....                     | <b>2-35</b> |
| <b>18. Paging</b> .....                               | <b>2-36</b> |
| A. Paging Over External speakers .....                | 2-36        |
| B. Responding to a Page .....                         | 2-36        |
| C. Paging Over Keypad Speakers .....                  | 2-37        |
| D. Intercom Calls .....                               | 2-37        |
| <b>19. Speed-Dial Numbers</b> .....                   | <b>2-38</b> |
| <b>20. Sending a Hookflash Over a CO Line</b> .....   | <b>2-39</b> |
| <b>21. Display Messages</b> .....                     | <b>2-39</b> |
| <b>22. Do Not Disturb</b> .....                       | <b>2-40</b> |
| <b>23. Reminder Call</b> .....                        | <b>2-40</b> |
| <b>24. Extension Lock</b> .....                       | <b>2-41</b> |
| A. Locking and Unlocking Your Keypad .....            | 2-41        |
| B. Placing Calls While Your Extension is Locked ..... | 2-41        |
| C. Changing Your Password .....                       | 2-42        |
| <b>25. Extension Reset</b> .....                      | <b>2-42</b> |
| <b>26. Manager/Secretary</b> .....                    | <b>2-43</b> |
| <b>27. Room Monitor</b> .....                         | <b>2-43</b> |
| <b>28. Operator Extension</b> .....                   | <b>2-44</b> |
| A. Day Service/Night Service .....                    | 2-44        |
| B. Intrude .....                                      | 2-44        |
| C. Using the Answering Machine .....                  | 2-45        |
| D. Hunt Group Forwarding .....                        | 2-46        |
| <b>29. Hunt Groups</b> .....                          | <b>2-46</b> |
| <b>30. Call Logging</b> .....                         | <b>2-47</b> |

## 1. INTRODUCTION

**1.1** The Inter-Tel Encore System provides many user-friendly features. This section describes the features and provides detailed instructions on their use. Refer to the *Encore User Guide* for simplified instructions on using extension features.

## 2. FEATURE KEYS AND CODES

**2.1** This section describes the feature codes, single-line only and operator-only codes in addition to extension numbers and outgoing access codes.

### A. FEATURE CODES

**2.2** At Keypad extensions, most of the features are selected using the display keys or user-programmable feature keys. At single-line extensions, the user must enter a feature code. The feature codes that can be used at Keypad or single-line extensions include the following:

**Table 3-1:** *Keypad Feature Codes*

| FEATURE                               | CODE      |
|---------------------------------------|-----------|
| Call Pick-Up (Incoming Calls Only)    | 67        |
| Call Pick-Up Group (All Calls)        | 68        |
| Call Waiting Tone Protection          | 66        |
| Display Messages (Keypads only)       | 39        |
| Extension Lock Change Code            | 42        |
| Extension Lock/Unlock                 | 41        |
| Forward When Busy                     | 152       |
| Forward On No Answer                  | 153       |
| Forward All Calls                     | 151       |
| Do Not Disturb On/Off                 | 150       |
| Door Open                             | 86        |
| Follow Me                             | 154       |
| General Call                          | 65        |
| Page An Individual Keypad             | 43        |
| Page All Keypads                      | 44        |
| Page Answer                           | 45        |
| Page External PA                      | 47        |
| Park                                  | 40        |
| Redial                                | 60        |
| Reminder Call/Reminder Cancel         | 46        |
| Reset Telephone                       | 157       |
| Room Monitor                          | 48        |
| Speed Dial - Dial Personal Numbers    | 61        |
| Speed Dial - Program Personal Numbers | 62        |
| Speed Dial - Dial System Numbers      | 7001-7200 |
| Voice Message Pickup                  | 88        |

## B. SINGLE-LINE ONLY CODES

2.3 These codes are used only at single-line extensions.

**Table 3-2: Single-Line Only Codes**

| FEATURE                                 | CODE         |
|-----------------------------------------|--------------|
| Conference                              | Hookflash 3  |
| External Call Hold                      | Hookflash    |
| Forced Call Waiting                     | Hookflash 8  |
| Hookflash (over a CO line)              | Hookflash 87 |
| Park/Pick Up Parked Call                | Hookflash 40 |
| Release Second Call (when on two calls) | Hookflash 1  |
| Release First Call (when on two calls)  | Hookflash 2  |
| Return and Release (when on conference) | Hookflash 1  |
| Return and Hold (when on conference)    | Hookflash 2  |
| Ring Back                               | Hookflash 5  |
| Transfer                                | Hookflash 88 |

## C. OPERATOR-ONLY CODES

2.4 These codes can be used only at Extension 20.

**Table 3-3: Operator-Only Codes**

| FEATURE                  | CODE |
|--------------------------|------|
| Answering Machine on/off | 158  |
| Night Service on/off     | 156  |

## D. EXTENSION NUMBERS

2.5 These are the numbers used for placing internal calls.

**Table 3-4: Extension Numbers**

| DEVICE                       | EXTENSION |
|------------------------------|-----------|
| Keysets and Single-Line Sets | 20-37     |
| Operator (Extension 20)      | 0         |
| Voice Messaging              | 38        |

## E. OUTGOING LINE ACCESS

2.6 These codes are used for access to outgoing lines for placing calls.

**Table 3-5: Outgoing Line Access**

| OUTGOING LINE            | CODE  |
|--------------------------|-------|
| Line Access - Lines 1-8  | 51-58 |
| Line Access - Group 1    | 9     |
| Line Access - Groups 2-4 | 81-83 |



### 3. CO LINE FEATURES

**3.1** This section explains the CO line functions and programmable features.

#### NOTICE

***Only supervised CO lines should be used on the Encore System.*** While the system has timers that will help to prevent unsupervised trunk use, there is no implied warranty that it is invulnerable to unauthorized intrusions and toll fraud.

If the central office does not provide supervision it will not disconnect the call when one party hangs up; it is possible for a caller to remain connected to a CO trunk circuit. If this happens, and the caller begins dialing, the call could be placed through the Encore System and would then be billed to the system's owner. The system cannot check this type of call for toll restriction and may not register the call in the call log. This problem could arise when a call is connected to an extension, when a call is in an unsupervised trunk-to-trunk call, or when a call is forwarded or transferred to the public network.

#### A. DUAL-TONE MULTI-FREQUENCY (DTMF) OR DIAL-PULSE SIGNALING

**3.2** The system can be installed with either DTMF or dial-pulse lines. Dial-pulse lines must be specially designated in database programming, because all lines are designated as DTMF when the system is initialized. See [page 4-31](#) for programming information.

#### B. FLEXIBLE INCOMING RING ASSIGNMENT

**3.3** The Encore System is extremely flexible. You have the choice of operating it as either a key system where all users have direct access to all lines for making and receiving calls, or you can operate it as a PBX with all calls being answered by an operator console. You can also operate it as a combination of both. See [page 4-25](#) for programming information.

**3.4** Any or all extensions can be programmed to receive ringing for incoming calls. By default, all CO lines will ring at extensions 20 to 25. Each line can be programmed to ring up to 18 extensions and a Central Bell. Each line may also be programmed to ring different extensions for Day and Night Modes (see below). Lines can also be designated as “incoming-only” lines. See [page 4-26](#) for programming information.

**3.5** In addition, lines can be programmed for loop calling, if necessary. All lines are programmed by default to use standard Loop Start signaling. When a line is seized, the telephone system expects to hear dial tone and if it does not the line is disconnected. You can program CO lines to use Loop Calling if required. See [page 4-31](#) for programming information.

#### C. OUTGOING LINE GROUPS

**3.6** CO lines can be grouped together into up to four Outgoing Groups. Each Outgoing Group is associated with a code. These codes are 9, 81, 82, and 83, with Group 1 being associated with 9, etc. Dialing a code selects a line from the associated Outgoing Group. See [page 4-26](#) for programming information.

#### D. DAY AND NIGHT MODES AND WEEKEND SERVICE

**3.7** Day and Night Mode operation allows you to program two sets of call restrictions and ringing settings. You can set the time at which the Night Mode changes will come into effect and the time at which Day Mode will resume (see [page 4-9](#)). The operator also has the ability to manually turn on or off Night Mode.

**3.8** The Encore System can be programmed to provide Weekend Service. If Weekend Service is enabled and Night Mode is invoked on a Friday evening, the system remains in Night Mode until Monday morning.

## E. OUTGOING LINE ACCESS/RESTRICTION

**3.9** When programming the system, you can decide which lines each extension can use for outgoing calls. By default, all extensions have access to all lines.

**3.10** As a means of restricting outgoing calls, extensions can be prevented from having access to one or more CO lines for placing calls. This is performed during line programming. Users attempting to place a call using a restricted CO line hear a busy signal. See [page 4-25](#) for programming information.

## F. TOLL RESTRICTION CLASSES OF SERVICE

**3.11** As a means of controlling costs, each extension can be programmed for a toll restriction Class of Service. This determines the type of call the extension is allowed to dial. See [page 4-18](#) for programming information.

---

**NOTE:** System speed-dial numbers can be programmed to override Class of Service. This feature allows an extension to access all system speed-dial numbers, even though the extension may be restricted from directly dialing a number because of their Class of Service.

---

**3.12** Encore uses a combination of six Classes of Service and four Tables of numbers to set up toll restrictions.

**3.13** The six Classes of Service are defined as follows:

- By default, all extensions are in Class 1. They have no restriction placed on them.
- An extension placed in Class 2 is restricted from dialing the numbers programmed in Table 2. (Table 2 would typically be programmed with international and operator-assisted toll digits, such as 011 and 01).
- An extension placed in Class 3 is restricted from dialing the numbers programmed in Tables 2 and 3. (Table 3 would typically be programmed with toll digits, such as 1).
- An extension placed in Class 4 is restricted to internal and emergency (911) calls only.
- An extension placed in Class 5 is allowed to dial the codes programmed in Table 5. (However, the extension can also be assigned Class 2 or 3 to limit some calls. Table 5 can include allowed area codes, office codes, and/or complete telephone numbers.)
- An extension placed in Class 6 is restricted from dialing codes in Table 6. (This table would typically be programmed with local long-distance area codes. This Class can be combined with Classes 2 and/or 3.)

**3.14** The four Tables are numbered 2, 3, 5, and 6 to correspond with the associated Classes of Service. They can be programmed with up to 50 numbers each. Tables 2, 3, and 6 contain restricted numbers; Table 5 contains allowed numbers. A number can contain up to 13 digits. You can use the “Any” key in the number to indicate that any number of digits will follow (for example, 1X restricts all toll calls that begin with “1,” and 1800X restricts all calls beginning with “1-800”). See [page 4-13](#) for programming information.

**3.15** The following chart summarizes the Classes of Service and the Tables they use.

**Table 3-6:** *Classes of Service and Associated Tables*

| CLASS | TYPE OF RESTRICTION                                                       | TABLE                              |
|-------|---------------------------------------------------------------------------|------------------------------------|
| 1     | No restriction                                                            | N/A                                |
| 2     | Restrict codes in Table 2 (can be combined with Classes 5 and/or 6)       | Table 2 - Restricted Numbers       |
| 3     | Restrict codes in Table 2 and 3 (can be combined with Classes 5 and/or 6) | Tables 2 and 3 -Restricted Numbers |
| 4     | Internal and Emergency calls only                                         | N/A                                |
| 5     | Allow codes (can be combined with Classes 2, 3, and/or 6)                 | Table 5 - Allowed Numbers          |
| 6     | Restrict codes (can be combined Class 2, 3, and/or 5)                     | Table 6 - Restricted Numbers       |

## G. CALLER ID

### Caller ID Displays

**3.16** Caller ID service is available from your telephone company. If you subscribe to this service, your network sends the telephone number of outside callers (providing the caller has not blocked the number). You have the choice of displaying, or not displaying, this information on Keypad displays. See [page 4-31](#) for programming information.

**3.17** As well as displaying the caller's number, the Encore System allows you to associate your own names with caller numbers, and display these names in place of the Caller ID. See [page 4-29](#) for programming information.

**3.18** Here is how a caller number is displayed at a Keypad:

- The caller's number will appear on the display of all Keypads programmed to ring for incoming calls.
- A caller may have chosen to withhold their identity. In this case, the display will show "Blocked Call" instead of the caller's number or name.
- If the number information is not available, the display will show "Number Unavailable" instead of the caller's number.
- If more than one call is ringing at any one time, the number displayed will be that of the first call in the queue. When this call is answered by one of the extensions, the number of the next call in the queue will be displayed.
- If your Keypad is not ringing for the call, you may examine the incoming Caller ID by selecting **Examine I/C Call**. The same information shown on the ringing Keypads is then displayed.

**NOTE:** The system will display the Caller ID in a number-only format even if:

- The system receives the names or names and numbers sent by the network.
- The system will display the name if:
- The system has names associated to the Caller ID programming.
  - The system has names associated to the speed dial programming.

### Routing Calls Based on Caller ID

**3.19** An extension number may be associated with a Caller ID telephone number. In this case an incoming call from that number will ring at only that extension. If the extension is busy and has Call Waiting Tones turned off, the call rings the incoming ringing group programmed for that line.

### Caller ID Number Storage

**3.20** The Caller ID Storage automatically stores information about the last 65 unanswered calls to the system (unless you change the programming to store both answered and unanswered calls). The information stored is the caller's telephone number and the date and time of the call. Information is not stored for calls with withheld or unavailable numbers. When the memory is full, the oldest record is discarded from memory when a new record is received.

**3.21** The system Caller ID Storage can capture either all calls or unanswered calls only. See [page 4-13](#) for programming information.

**3.22** The Caller ID Storage can be allocated to one central storage location, which stores the data on up to 65 calls. Or you can program up to 12 extensions to store up to five numbers each and the remaining numbers are allocated to the central storage. See [page 4-20](#) for information programming individual Caller ID Storage.

- The central storage alerts Extension 20, (regardless of whether it is the Programming Extension), by means of a display prompt, that new calls have been stored. The central storage records all calls that ring into the system. These numbers can be viewed or dialed from any extension.
- Any extensions that have Caller ID Storage will receive a separate record of calls. Individual extension records will contain only calls on the lines programmed to ring directly to that extension.

#### **3.23 To view and/or redial stored caller numbers:**

1. Select **Missed Calls - Individual** to view the numbers in the personal storage of your Keypad or select **Missed Calls - System** to examine the central storage. You will see the following information:
  - The number and time of the last three calls received are displayed.
  - If the call was answered, the display will show an **A** on the right side of the record. If the call was not answered, the "A" will not be displayed.
2. If you press the right Keypad Edit key ( **▶** ), the date information for that call is shown for a few seconds, instead of the time.
3. You may scroll through the stored numbers and names, using the Scroll Up ( **▲** ) and Scroll Down ( **▼** ) keys situated below the display.
4. If you press the Display key beside a particular record, the system automatically seizes a free line and dials the displayed number. If the extension is restricted from dialing, or if there is no line available, you will hear a busy tone.
5. If an **R** is displayed on the right side of a record, this indicates that the number has been redialed.

## H. ALTERNATIVE CALL ROUTING

**3.24** You may use this feature to have calls routed over specific lines (such as specialized common carriers or equal access lines), using special digits, if necessary. You can create up to 50 special Alternative Call Routing numbers. See [page 4-29](#) for programming information.

**3.25** To set up the feature you must enable “Alternate Call Routing” and then associate the required digits with input codes in database programming. For example:

- If you want a particular equal access carrier used for long-distance calls, you can program an input code of “1” and output digits of “10XXX.” Then, you can choose whether the call will go over any line or if it is restricted to a specific line. Once the feature is set up, whenever a user dials a number that begins with 1, the system will automatically replace the 1 with 10XXX and select the line you designated.
- If you want calls to a certain area code to go over a specific line, you can program the area code as the input code, leave the output code blank, and select the line you want used. Then, when an extension user dials that area code, the system will select the designated line, but it will not substitute any digits.

## I. OPERATION WITH A PARENT PBX

**3.26** You can connect the Encore System to a parent PBX via its line interfaces.

**3.27** You can program any of the four Line Groups to work with a parent PBX. When programming the Line Groups as PBX groups, you must tell the system what digits are required to select a line in the parent PBX. The system will then “absorb” those digits when a call is placed and will not consider them part of the number when applying toll restrictions. (You can have a maximum of two PBX access digits.) You must also tell the system how many digits are in the extension numbers on the PBX. See [page 4-27](#) for programming information.

**3.28** To place an outgoing call through the PBX, users must dial the access digit(s) before the external number. To call a parent PBX extension, users must seize a line connected to the PBX and dial the extension number without any access digit(s).

**3.29** Both external numbers and PBX extension numbers may be entered into Personal and System Speed-Dial lists. When a speed-dial number is selected for dialing, the system checks whether the number is a PBX extension by checking the number of digits against the programmed extension number length.

- If it is a PBX extension the system selects a PBX Line Group and, if a line is free, dials the digits.
- If the selected number is an external number, the system attempts to seize a line. If one is available, it dials the number without inserting the access digits. If a line is not available a free PBX line is seized and the access digits are automatically inserted.

**3.30** If Redial is used, the number is redialed on the same group on which the original call was made. If no lines are available, you will hear busy tone.

## 4. PROTECTION AGAINST POWER FAILURE

**4.1** For protection against power failure, database protection and power failure telephones are required.

### A. DATABASE PROTECTION

**4.2** The CPU contains a capacitor that protects the programmed database in the event of a power failure. The capacitor will protect the programmed database until the accumulated system downtime exceeds 2-3 months (depending on the size of the database).

### B. POWER FAILURE TELEPHONES

**4.3** Each board with CO line capability is equipped with a power-failure circuit path. In the event of a power failure (without battery back-up power), lines are switched automatically to the designated extensions and calls can be made and received on these lines until the power is restored. The Keyset will not work when power has failed, so these extensions must be connected to single-line telephones for calls to be made.

**4.4** Lines 1 and 2 are connected to extensions 24 and 25, the last two extensions on the CPU. Line 5 is connected to extension 31, and line 7 to extension 37, the last extensions on each of the Extension Cards. These line positions are summarized in the table below.

| CO LINE | POWER FAILURE EXTENSION |
|---------|-------------------------|
| Line 1  | Extension 24            |
| Line 2  | Extension 25            |
| Line 5  | Extension 31            |
| Line 7  | Extension 37            |

---

**NOTE:** Because Keysets cannot operate without power, Extensions 24, 25, 31 and 37 should either have access to or be equipped with single-line sets if they are to be used in power failure situations. If lines are connected to extension positions equipped with Keysets, the user must replace the Keyset with a single-line telephone to answer or make calls during a power failure. Keysets cannot be used during a power failure situation.

---

## 5. EXTENSIONS

**5.1** The system has capacity for up to 18 extensions. Extensions can be equipped with Encore Keysets or industry-standard single-line sets. Extension 23 can be connected to a Door-phone, if desired. Extension 20 is the operator's extension and, at default, is the Programming Extension.

**5.2** You may assign names to extensions. When an extension receives an internal call, its display will show the calling extension name in the place of the extension number.

### A. KEYSETS

**5.3** The Encore Keyset is specially designed for use with the Encore system. In the drawing below, the keyset features are pointed out. Each is described in more detail later.

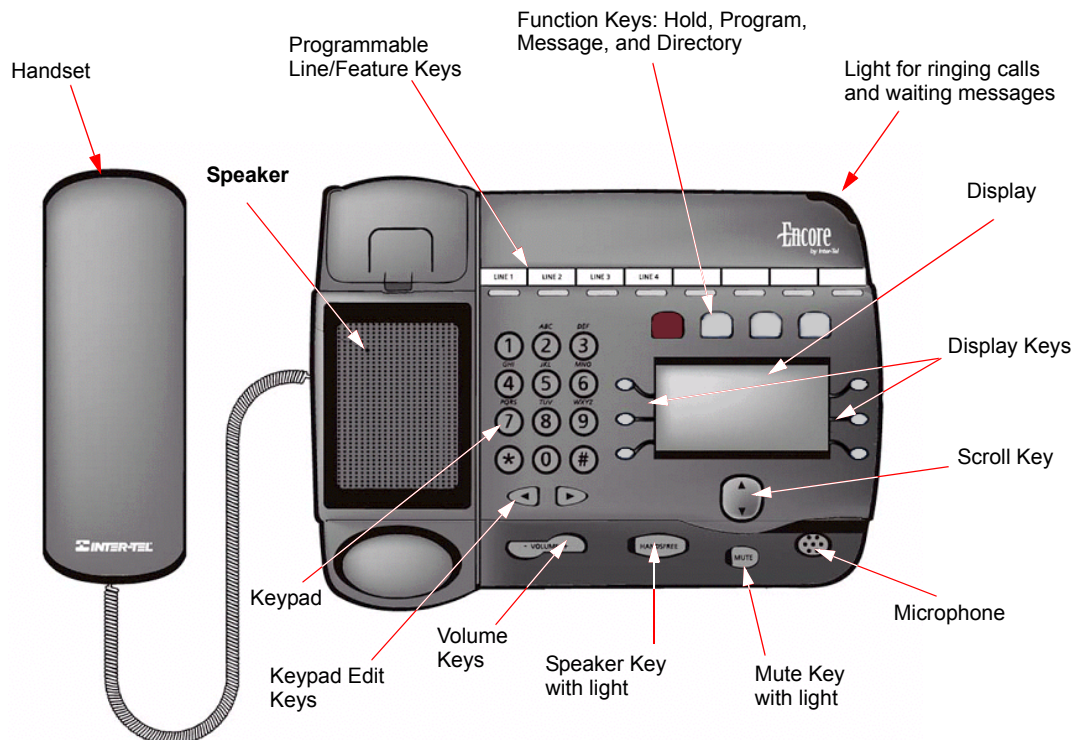

#### Four-Line Liquid Crystal Display (LCD)

**5.4** Each Keyset has a liquid crystal display (LCD). The display helps the user to process calls more efficiently. (These displays are indicated throughout this section of the manual.) The prompts and information shown on the display help you use your Keyset:

- Prompts appear that tell you what action to take or warn of an incorrect action. For example, an attempt to access the system programming menus from the wrong extension will result in the prompt "Programming Refused" being displayed.
- When your Keyset is not in use, its display shows the time and date on the top line.
- When you dial an external number, the display shows the digits as they are dialed.
- When you make an internal call the extension number you dialed is displayed. If the extension has been programmed with a name, the name is displayed.
- You can leave a message on your Keyset display which will be also seen by other Keyset users who call your extension (see [page 3-39](#)).
- You can display Caller ID numbers or names, if programmed, on your Keyset display (see [page 3-7](#)).



**5.5** When the Keypad is idle, the Idle Menu is shown on the display. It contains a large number of options displayed in groups of three. (A menu with the first three options is shown below.) You use the Scroll keys below the display to scroll up and down through the options.

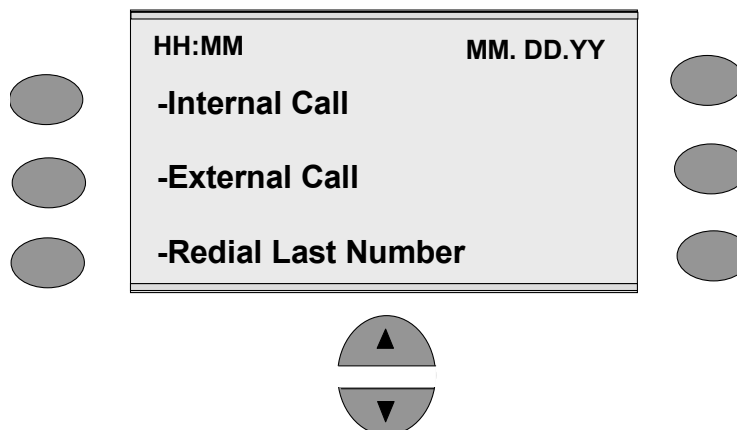

**5.6** If you are on a call or using a feature, the menu changes to offer only those options relevant to what you are doing. Also, when features such as Extension Lock are set, the first prompt on the display becomes the option to cancel the activated feature.

**5.7** When activating certain features, it is necessary to select the extensions or lines on which you wish to activate the feature. In this case the Extension Menu is shown, listing all the extensions connected to the system. Or, a Line Menu is shown, listing all the lines connected to the system when you are activating line features.

---

**NOTE:** Most menus will display the option "Cancel." This allows you to exit without activating the feature. You may also press the Scroll Up (▲) key for two seconds to return to the previous menu. Finally, pressing the Speaker key exits all menus and returns the display to the Idle Menu.

---

### Using the Scroll Keys

**5.8** The Scroll keys are located under the display and are used to scroll up and down through the display options. When the Scroll Down (▼) key is pressed, the next three available options are displayed. Conversely, pressing the Scroll Up (▲) key will take you back up the display to the previous options.

---

**NOTE:** Pressing the Scroll Up (▲) key for two seconds will exit to the previous menu.

---

### Using the Display Keys to Select Menu Options

**5.9** The six Display keys, located on each side of the display, are pressed to select the menu option shown on the display. This will either activate a feature, cause another menu to be displayed, or select an item from a list.

**5.10** When selecting from a displayed list (for example selecting extensions from the extension Menu), selected items will be denoted by a ◆ next to the object. Unselected items will be denoted by a ◇ next to the item. Selecting an item with a ◇ causes the item to be selected and the symbol to change to ◆, and vice versa.

---

**NOTE:** Do not press the Display keys quickly in succession to scroll through menus. You must wait for the display to change before making your next selection.

---



## Function Keys

**5.11** There are four Function keys located directly above the Keypad's display. Particular features are grouped under these keys, as follows:

- **HOLD H:** This key allows you to put outside calls on hold. When calls are placed on hold they can be retrieved from any Keypad (see page 3-30 for details).
- **PROGRAM P:** This key accesses the options available to customize your Keypad settings and enter your personal speed-dial list. It also accesses system programming from the Programming Extension.
- **MESSAGE** ☒ : This key accesses Voice Messaging features (see page 3-20) and Display Messaging features (see page 3-39).
- **DIRECTORY** 📖 : This key allows you to dial system and personal speed-dial numbers. It also allows convenient dialing of the Service and Sales telephone numbers, if programmed.

## Keypad and the Keypad Edit Keys

**5.12** The keypad can be used to enter digits when dialing, or text when programming names or messages. There are two Keypad Edit keys below the keypad. You can use these keys to move left and right when entering names or messages, and to correct digits while dialing.

### 5.13 To enter text when programming names or messages:

Press the keypad keys to enter the desired characters. The number of times a key is pressed determines which character is entered. The letters you enter correspond to the letters printed on keypad keys. A maximum of ten characters per name, including spaces, may be entered.

- For upper and lower case letters and numbers, press the corresponding key. For example, press **2** once for A, twice for B, and so on. Pressing **2** continuously loops through ABCabc2. For Q use **7** and for Z use **9**. Pressing **1** enters only the digit "1" or a space and pressing **0** enters only the digit "0" or a space.
- Wait for two seconds for the cursor to move on or press the right Keypad Edit key (▶) to move to the next location.
- When programming a Speed-dial number, you may insert a pause of 1.5 seconds between digits by selecting **Pause** on the display. (However, you cannot use a pause as the first digit of the speed-dial number.)

## Ringing Call/Message Waiting Light

**5.14** There is a red light on the top right corner of the Keypad. This light flashes when there is an incoming call. It also lights up when a voice message has been left in your voice message box.

## Changing the Display Contrast

**5.15** The Keypad display has four contrast settings. The default setting is Level 3.

### 5.16 to adjust the display contrast:

1. Press the **PROGRAM** key.
2. Scroll to and select **Contrast Options**.
3. Select the desired **Level** to set a contrast option. The prompt **Contrast Set** appears on the display.
4. Press the **Speaker** key to finish programming.

### Changing the Display Language

**5.17** The Keypad displays can be shown in English, Spanish, or French. The default language is English.

**5.18 To change the language on the keypad display:**

1. Press the **PROGRAM** key.
2. Select **Language**. The choice of English, Spanish, or French is displayed
3. Select the desired language. The display changes automatically.

### Programmable Keys/Line Keys

**5.19** There are eight Programmable keys across the top of your Keypad. These keys are pre-programmed as Line keys.

**5.20** Each Line key is associated with a line, the first Line key with line 1 and so on, (as many as the system has lines equipped). Pressing Line key 1 seizes line 1, returning a dial tone and allowing you to dial an external telephone number.

**5.21** The Line keys have a red light, which is lit on all Keypads when the associated line is seized. When a call on a line is put on hold the associated Line key light flashes on all Keypads (unless the system programming is changed from the default, see [page 4-10](#)).

**5.22** If you have fewer than eight lines, some Programmable keys will not be pre-programmed as Line keys. You can program these (and any existing Line keys, if desired) to activate other system features.

**5.23** You can program the keys to use any feature code or extension number. If you assign an extension number to a Programmable key, the light in the key will indicate the status of the extension. When the extension is in use, the light will be lit.

---

**NOTE:** If you assign Open Door to a Programmable key, you will have to disconnect from a Doorphone call before pressing the Open Door key.

---

**5.24 To program the keys:**

1. Press the **PROGRAM** key.
2. Scroll to and select **Key Programming**.
3. Press the Programmable key to be programmed. A list of options appears on the display.
4. Select the feature to be programmed onto the key. If necessary, use the Scroll Down (▼) key to view the list of available features. For example, to program the key with an extension number, select the **Individual Digits** option.
5. Press the **Speaker** key to finish programming.

## Hands-free Answering and the Speaker Key

**5.25** You can use the Speaker key to have a conversation without having to lift the handset. Press the Speaker key to go off-hook, as if the handset were lifted, and use the Keypad speaker and microphone in place of the handset. Pressing the key again goes back on-hook, as if the handset were replaced.

**5.26** When you have the handset off-hook, pressing the Speaker key turns the speaker on and allows other people in the room to hear the caller.

**5.27** The Speaker key has a red light, which is lit whenever the Speaker key has been pressed to go off-hook or to turn on the speaker.

**5.28** You may program your Keypad to work in Handsfree Answer mode. In this mode, when you receive an internal call the Speaker key light flashes red, you hear a burst of tone, and the call is connected automatically. You can speak to the caller without touching the Keypad.

### **5.29 To enable or disable hands-free answering:**

1. Press the **PROGRAM** key.
2. Select **Handsfree Answering**.
3. Select the required option, **Set H/free Answering** or **Cancel H/F Answering**, to set and cancel the Handsfree Answer mode respectively. On the display **Handsfree Answering On (or Off)** will appear and then the display will revert to the Idle Menu.

## Volume Key

**5.30** You can adjust the speaker, handset, and ringing volumes separately.

1. To adjust the speaker volume, press the **Volume** key when in handsfree mode.
2. To adjust the handset receiver volume, press the **Volume** key when in handset mode.
3. To adjust the ringing volume, press the **Volume** key when the Keypad is ringing.

---

**NOTE:** Volume will increase/decrease by one level for every press of the **Volume** key.

---

## Mute Key

**5.31** The Mute key can be pressed when you are using the handset or in handsfree mode. When pressed, the other person on the call cannot hear you. The Mute key has a red light, which is lit when mute is active.

## Setting Ring Tones

**5.32** The Keypad can be programmed to use one of three ring signals to create distinctive ringing. If extensions are placed close together, changing the pitch makes each extension's ring easier to recognize.

### **5.33 To set the ring tone on your keypad:**

1. Press the **PROGRAM** key.
2. Scroll to and select **Ringing Options**.
3. Select the desired **Tone**, which will cause the selected tone to sound.
4. Select **Confirm** to use the chosen tone. On the display **Ring Type Set** will appear and then the display will revert to the Idle Menu.

### Using a Headset in Place of the Handset

**5.34** To use the Keypad with a headset you must first set the Keypad in Headset Mode. In Headset Mode you use the Speaker key instead of lifting or replacing the handset.

**5.35 To enable or disable headset mode:**

1. Press the **PROGRAM** key.
2. Scroll to and select **Headset Mode**.
3. Select the required option, **Headset On** or **Headset Off**. Once selected, the display will show the current mode and then revert to the Idle Menu.

---

**NOTE:** The handset does not operate when the Keypad is in Headset Mode.

---

### Adjusting the Keypad

**5.36** The Keypad baseplate allows you to adjust the Keypad at two angles, and at two heights, as shown below.

**5.37** There are retaining clips on the baseplate that allow it to be attached to the keypad at two different angles. When the correct viewing angle has been selected, clip the baseplate onto either the lower or upper slot on the underside of the Keypad.

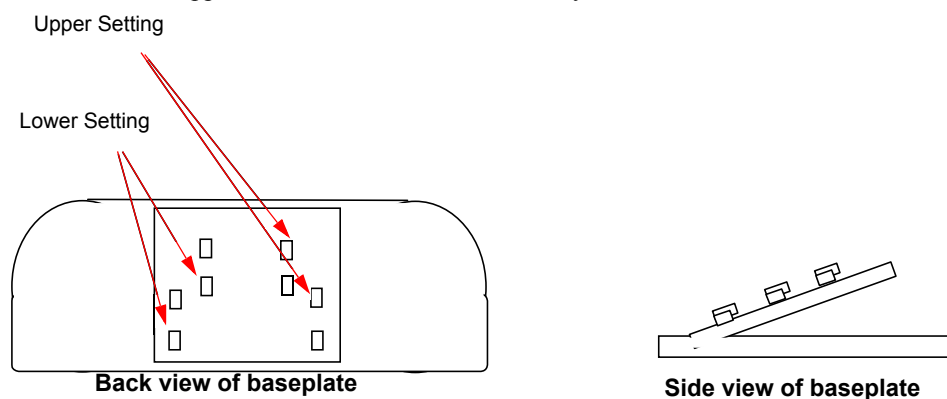

## B. SINGLE-LINE SETS

**5.38** Industry-standard, AC-ringing, single-line DTMF sets may be installed on an Encore System. Single-line sets can be used at any extension. Extension 22 can be used for a long-line extension (see [page 2-26](#)).

**5.39** Single-line set users access features simply by lifting the handset and entering a feature code or by using a combination of a hookflash and a feature code. Detailed instructions are given through this chapter.

## C. DOORPHONE UNITS

**5.40** You can equip your Encore System with a Doorphone. The Doorphone has a button which, when pressed, rings at programmed extensions, and has a microphone/speaker for communication. With a Doorphone installed at the entrance or in your reception area, anyone visiting your premises can call when they arrive and you can speak to them before you let them in. See [page 4-13](#) for programming information.

### Doorphone Calls

**5.41** When a person presses a button on the Doorphone, a call is placed to the extensions programmed to receive Doorphone calls. By answering the call, the extension user can talk with the person at the door.

**5.42** The Doorphone Ring Duration timer controls the amount of time a Doorphone call will continue to ring at the extensions. By default, it is set to 30 seconds. See [page 4-12](#) for timer programming.

### 5.43 To answer a doorphone call:

Lift the handset and speak. There is no code to dial.

---

**NOTE:** An extension cannot make a call to a Doorphone

---

### Optional Doorstrike

**5.44** The Encore System also has a doorstrike relay output, which can be used to operate a strikeplate mechanism that allows users open the door from their extensions. See [page 4-19](#) for information on programming the extensions that can open the door.

**5.45** The doorstrike will remain open until the Open the Door timer expires (defaults to 5 seconds). See [page 4-12](#) for timer programming.

---

**NOTE:** You must purchase the doorstrike mechanism yourself and arrange for a qualified electrician to install it. Also, for security reasons, be careful not to place an extension that can open the doorstrike too close to a window or other point of access.

---

### 5.46 To open a door using the doorstrike:

- **Keyset:** When your extension is ringing with a Doorphone call, and you have a doorstrike mechanism installed, the **Open Door** option will be displayed. If you select the option, the doorstrike relay will operate and the call to the Doorphone will be disconnected.
- **Single-line:** If you are on a call, perform a hookflash and dial **8 6**. If you are not on a call, just dial **8 6**.

## D. HOT LINE EXTENSIONS

**5.47** Extensions can be programmed to automatically dial a number when they go off-hook. The number dialed can be an extension or an external number. No other features can be used at a Hot Line extension. A common application for the Hot Line feature is for a fax or modem. External paging equipment (a paging amplifier and speaker) can be connected to any extension connection in the system. Users can then make announcements over the external paging equipment. See [page 4-23](#) for programming information.

**5.48** A common application for the Hot Line feature is for a fax or modem. The extension can be set to automatically seize a line so the fax or modem does not have to dial 9.

## 6. COURTESY SERVICE

**6.1** The Courtesy Service is used in systems where there may be delays in answering calls, and the customer wants to ensure that callers do not hang up before someone answers their call.

**6.2** If a call rings on a line programmed for Courtesy Service, and it is not answered by an extension within a programmed time (30 seconds by default), the call is automatically answered and a greeting is played. See [page 4-12](#) for timer programming ([page 5-40](#) if using RMS).

**6.3** This service is available, with a standard greeting, on all systems. If the standard greeting is used, the caller hears one of the following:

- During Day Mode the caller will hear, *“Thank you for calling. Your call will be answered shortly. Please hold.”*
- During Night Mode the caller will hear, *“Thank you. There is no one available to take your call at the moment. Please call back during office hours.”*

---

**NOTE:** If a caller hangs up the call will be held by the system until it is either picked up internally or the system times out after one minute.

---

**6.4** If the system is equipped with a Voice Module (as described on the next page), you can customize the greeting. When the Courtesy Service is programmed, you can select the system-provided standard greetings, shown above, or the custom Voice Messaging Module greeting (if you have one). See [page 4-28](#) for programming information and [page 4-11](#) for information on recording the greetings.

---

**NOTE:** If Courtesy Service is active on one port, then the next call (answered by Courtesy Service) will also be presented to the same port. Courtesy Service will never occupy both ports. In the previous operation of Auto Attendant, (where, if it was not available to answer) the call would be answered by internal courtesy source, as a back-up, it no longer applicable. This allows you to enable External Music on Hold when Auto Attendant is enabled on the system.

**ALSO:** If the Voice Messaging options are enabled in Extension Programming, the Forward on No Answer timer will effect how the Courtesy Service message plays before the call is forwarded to voice messaging.

---

**6.5** While the message is playing, the call continues to ring as an incoming call until an extension answers it or the call is automatically disconnected by the system.

**6.6** While the system is in Day Mode, if both Music-On-Hold and Courtesy Service are programmed, the Courtesy Service message and music will be played in rotation to callers on hold. In Night Mode, the Courtesy Service message and hold tones will be played in rotation.

**6.7** If the call is not answered within three minutes, it is connected to the system message box. This allows a caller to leave a voice message (if the Voice Module is installed).

## 7. VOICE MESSAGING MODULE FEATURES

**7.1** A Voice Messaging Module can be installed in the Encore KSU to provide Automated Attendant service, Answering Machine service, and customized Courtesy Service greetings, in addition to Voice Messaging. Each extension can be assigned a voice message box. See [page 4-21](#) for programming information

**7.2** There are two ports on the Voice Messaging Module. Both ports are assigned dynamically on a “first come, first serve” basis, as needed. Extensions may be forwarded to Voice Messaging and extension users can transfer calls to their voice message box.

---

**NOTE:** Messages are saved on the Voice Messaging Module, but the amount of messages is kept on the KSU. If the Voice Messaging Module is removed from a system and then re-connected to the same system, the messages and greetings are retained. If a Voice Messaging Module with messages and greetings is installed in a different system, it responds erratically (e.g the KSU has a record of 10 message and the VM card has a record of 8 messages, the system will try to play messages that do not exist, and users will hear “end of message.”) It is recommended that when a Voice Messaging Module is removed or replaced, a cold reset should be performed so that old messages are not retained.

---

### A. AUTOMATED ATTENDANT

**7.3** The Automated Attendant feature allows calls to ring directly through to an extension, provided that the caller knows the extension number of the person they wish to contact. A Voice Messaging Module must be installed for this feature to operate. See [page 4-30](#) for programming information.

**7.4** When a call arrives on a line programmed for Auto Attendant, the call is answered for the programmed time period (unless the timer is set to one or less than five seconds), then the Automated Attendant answers the call immediately. Because there is full access to both ports, the Auto Attendant restriction on port one is removed. If both ports are not available, the call rings the incoming ring group for the line until answered or a port becomes available. The caller will hear a pre-recorded greeting or a customized greeting. See [page 4-11](#) for information on recording the greetings. The pre-recorded greetings are as follows:

- When the system is in Day Mode, the caller will hear, *“Thank you for calling. If you know the extension you wish to contact, please dial the number. If you require assistance please wait or dial 0.”* (If the caller presses 0, all stations programmed to ring for that line will ring.)
- When the system is in Night Service, the caller will hear, *“Thank you for calling. There is no one available to handle your call at the moment. If you wish to contact a particular extension, please dial the number.”*

---

**NOTE:** If Courtesy Service is active on one port, then the next call (answered by Courtesy Service) will also be presented to the same port. Courtesy Service will never occupy both ports. In the previous operation of Auto Attendant, (where, if it was not available to answer) the call would be answered by internal courtesy source, as a back-up, it no longer applicable. This allows you to enable External Music on Hold when Auto Attendant is enabled on the system.

---

**7.5** The caller then dials the extension number from their DTMF telephone. The system will wait ten seconds for the caller to dial the first digit and a further four seconds for the second digit. If the digits are not received within that time, or an incorrect extension number is dialed, the call will ring in as a normal incoming call.

**7.6** When the caller enters the extension number correctly, the extension will ring. If it is not answered within 30 seconds, or if the extension is busy, the call will ring as a normal incoming call. To set the auto-attendant timer, refer to [page 5-40](#) (using RMS), or refer to [page 4-12](#) (using keyset programming).

## B. ANSWERING MACHINE

**7.7** This service acts as an answering machine. It can be used for answering incoming calls and record messages for selected lines. You can also select how long a call rings before the Answering Machine answers. See [page 4-28](#) for programming information and [page 4-12](#) for timer information.

**7.8** All messages received by the Answering Machine are stored in a system voice message box, which is controlled by Extension 20. The user at Extension 20 can do the following:

- Customize the greeting for the message box. The greeting may ask callers to dial an extension number, in which case the call will be transferred through to that extension.
- Turn the Answering Machine service on and off at any time. (Its operation is independent of Day/Night Mode operation.) If desired, this feature can be turned on permanently, so that unanswered calls are sent to the Answering Machine. (See [page 4-12](#) for timer programming.)

---

**NOTE:** If a call is received when the Voice Module storage is full, it will not be possible to store any further messages. In this case the caller will hear, *“Thank you for calling. There is no one available to handle your call at the moment. If you wish to contact a particular extension, please dial the number.”*

---

## C. VOICE MESSAGING

**7.9** Extensions can be provided with voice message boxes. When an extension user forwards calls to his or her message box, the voice message box answers all internal and outside calls that are placed directly to the extension. (Examples of external calls placed directly to the extension are Automated Attendant calls and calls directed to the extension based on Caller ID.) Messages can be up to 180 seconds long, and the system can store up to 50 messages per mail box.

**7.10** An extension must be allocated a voice message box before it can use Voice Messaging. When the system is first installed, extensions are not allocated a voice message box.

---

**NOTE:** All messages, which have been retrieved or played, are permanently deleted after eight days. Messages that are not retrieved are deleted after 15 days.

**ALSO:** If the mail box is full and messages are not deleted, internal callers trying to leave a message will get busy tone (voice mail busy). External callers trying to leave a message will get ring-back tone and will not be able to leave a message. The Programming Line key LED will be lit, indicating that there is an incoming call in progress.

---

### Forwarding Calls to Your Voice Message Box

**7.11** You turn on voice messaging by forwarding calls to the Voice Message extension (Extension 38).

- If “Forward All Calls” is activated, all calls will be answered by the voice message box.
- If “Forward On No Answer” is activated, calls unanswered after four rings will be answered by the voice message box.
- If “Forward When Busy” is activated, calls received when your extension is busy will be answered by the voice message box.

**7.12** For information on how to forward calls, see [page 3-33](#).



## Accessing Your Message Box

**7.13** If new voice messages have been left in your voice message box, the Message Waiting Light, located on the top right corner of your Keypad, will be on. In addition, the top line on your Keypad display will show “New Voice Messages.” (When messages are left for a single-line telephone, there is no indication given to the telephone. You should regularly access the voice message box to check for messages.)

### 7.14 To access your voice message box from a keypad:

1. EITHER, Select **New Voice Messages** from the display.  
OR, Press the **MESSAGE** ☒ key and select **Voice Messaging** from the display.
2. Enter your voice message box number (which is usually your extension number).
3. Enter your voice messaging password (1111 by default), followed by **#**.
4. You have the following options:
  - **Play:** Plays any messages waiting in your message box. Each message is preceded by a time stamp telling you when the message was received. You may skip the time stamp by dialing **8**, which jumps forward ten seconds. While replaying your messages the following options are available:
    - **Forward Message:** Enter the extension number to send the message to another extension’s message box.
    - **Next Message:** Skip to the next message.
    - **Return Call:** Automatically place a call to the extension that left the message. If the Caller ID for an external caller was received you can return a call to an external number.
  - **Delete All Messages:** Erases all messages in your voice message box.
  - **Greeting:** Listen to or record your personal greeting, as follows:
    - **Record Greeting:** Speak when prompted to record a personalized greeting. When finished, press **Confirm** and then the **Speaker** key.
    - **Replay Greeting:** Replays your greeting automatically for you.
  - **Change Password:** Enter your own password, which can be up to eight digits long. Enter your new voice messaging password. Then press **Confirm** and the **Speaker** key to finish programming.

---

**NOTE:** If you forget your password, it can be viewed using the Programming Extension (see [page 4-22](#)).

---

- **Monitor:** Operate your message box in Monitor Mode. In this mode, when a call is sent to your voice message box while your extension is idle, the call is relayed over the speaker of your Keypad. If you lift your handset, you can intercept the call and speak to the caller, in which case no message is left in the voice message box. To enable or disable Monitor Mode, press the Scroll Down (▼) key and select **Monitor** when it is displayed. Then select **Monitor On** or **Monitor Off**. Press the **Speaker** key to finish programming.
- **Cancel:** Exit from your voice message box.

### 7.15 To access your voice message box from a single-line set:

1. Access your voice message box by dialing **8 8**, followed by your extension number, voice messaging password, and **#**.
2. When you hear your voice message box greeting, do one of the following:
  - To program your greeting or password:
    - Dial **9 1** to change the outgoing greeting. (Speak to record a personalized greeting when prompted, then perform a hookflash or hang up.).
    - Dial **9 2** to hear the current outgoing greeting.
    - Dial **9 3** to delete the outgoing greeting.
    - Dial **0** and enter a new password, up to eight digits, to change your voice messaging password.
  - To play your messages, dial **1**. Playback begins at the first message. Each message is preceded by a time stamp telling you when the message was received. You may skip the time stamp by dialing **8**, which jumps forward ten seconds. While replaying your messages the following options are available:
    - Dial **#** to pause playback
    - Dial **2** to save this message and move to the next message. You can store up to 50 voice messages.
    - Dial **3** to delete this message and move to the next message
    - Dial **4** to go back to the start of the message
    - Dial **5** to go back to the previous message
    - Dial **6** to delete all messages
    - Dial **7** to go back ten seconds
    - Dial **8** to go forward ten seconds/Skip the time stamp
    - Dial **9 + extension number** to forward the message to another extension
    - Dial **0** to return the call (This automatically places a call to the sender.)

### Remote Access

**7.16** In order to access your voice message box remotely, you must have your calls forwarded to your voice message box. You must also have a line that rings at your extension either directly or through the Automated Attendant service.

### 7.17 To access your voice message box from a remote location:

1. *If a line is programmed to ring directly at your extension, dial the line number.*  
*If you do not have a line ringing directly to your extension, dial in on the Automated Attendant line. When you receive the Automated attendant message, dial your extension number and voice messaging password.*
2. When you hear your voice message box greeting, dial **8 8**. Use your voice message box as described above for single-line sets. All options are available when calling from a remote location, except “Return the Call.”

## 8. MUSIC-ON-HOLD

**8.1** There are four music-on-hold options for outside calls on hold: silence, tones, the built-in music-on-hold (that plays the Brandenburg Concerto), or an external music source. The external music source is a radio, CD player, or other device that is connected directly to the KSU. The music-on-hold feature not only makes the wait as pleasant as possible, but it assures the waiting party that the call is still connected.

---

**NOTE:** If Courtesy Service is active on one port, then the next call (answered by Courtesy Service) will also be presented to the same port. Courtesy Service will never occupy both ports. In the previous operation of Auto Attendant, (where, if it was not available to answer) the call would be answered by internal courtesy source, as a back-up; this is no longer applicable. This allows you to enable External Music on Hold when Auto Attendant is enabled on the system.

---

**8.2** While the system is in Day Mode, if both music-on-hold and Courtesy Service are programmed, the Courtesy Service message and music will be played in rotation to callers on hold. In Night Service, the Courtesy Service message and hold tones will be played in rotation.

**8.3** Internal callers will always hear tones when on hold.

---

**NOTE:** In some circumstances, there may be broadcast restrictions associated with the music heard by callers on hold. Check with the music's original distributor and/or the radio extension for copyright and broadcast restrictions concerning music-on-hold.

---

## 9. INTERNAL CALLS

**9.1** Internal calls can be used to place extension-to-extension calls that can be answered handsfree at Keypad extensions. A user who reaches a busy extension can camp on and wait for the extension to become available. Other features, that apply to both outside and intercom calls, are described later in this section of the manual. They include placing calls on hold, call waiting, conferencing, do-not-disturb, and call forwarding.

**9.2** Internal calls can be placed by dialing a two-digit intercom number (20-37), pressing a feature key programmed with an extension number on an Encore Keypad, or dialing 0 to call the operator (Extension 20 by default). Intercom numbers are assigned to stations in the order that the extension cables are connected to the KSU (refer to [page 2-7](#)).

### A. KEYPAD HANDSFREE ENABLE/DISABLE

**9.3** A keypad user can turn off the keypad Handsfree Answering feature by entering a feature code (see [page 3-15](#)). If Handsfree Mode is disabled, the keypad user hears ring tones when receiving an intercom call and must lift the handset (or press the Speaker key) to answer while this feature is enabled.

## B. EXTENSION-TO-EXTENSION CALLING

**9.4** Extension-to-extension calling allows you to receive and place intercom calls.

### Receiving Intercom Calls

**9.5 To receive an internal call on a keyset:**

When the Keyset rings, you can do one of the following:

- Select **Answer The Call** on the display to speak handsfree.
- Press the **Speaker** key to speak handsfree.
- Lift the handset.

**9.6 To receive an intercom call on a single-line set:**

When you hear internal ringing tones, lift the handset.

### Placing Intercom Calls

**9.7** A keyset user can place intercom calls without lifting the handset, using the speakerphone. This method allows the user to speak handsfree once the call is connected.

**9.8 To place an intercom call from a keyset:**

1. You can place an internal call in one of the following ways:
  - Select the **Internal Call** option on the display and select the desired extension from the list.
  - Dial the extension number (20 - 37) and select **Send Digits** on the display.
  - Lift the handset and dial the extension number.

The display will show the extension number, or, if programmed, the extension name.

2. To disconnect the call, hang up. Or press the **Speaker** key, if using the speakerphone.

**9.9 To place an intercom call from a single-line set:**

Lift the handset and dial the extension number.

## C. CAMP ON

**9.10** The Camp On feature allows you to wait on the line for a busy extension to become available.

**9.11 To camp on to an extension:**

When you hear a busy tone when calling an extension, stay off-hook. When the called extension becomes free, your call will ring at their telephone.

## D. EXTENSION RING BACK

**9.12** If the extension you call is busy, use the Ring Back feature to have the extension call you when it becomes free.

**9.13** The Ringback Time Duration timer limits the amount of time a Ring Back call will continue to ring at your extension. At default, the timer is set to 30 seconds. See [page 4-12](#) for timer programming.

**9.14 To request a ring back at a keyset:**

1. When you have called a busy extension, select **Ring Back** on the display.
2. When the extension becomes free, your extension will ring. The displays show **Ring Back From Extension**. Select **Answer The Call** or pick up the handset to call the extension.

**9.15 To request a ring back at a single-line set:**

1. When you have called a busy extension, perform a hookflash and dial **5**.
2. When the extension becomes free, your extension will ring. Pick up the handset to call the extension.

## E. GENERAL CALL

**9.16** The General Call feature allows you to ring all extensions connected to the Encore System. The first extension to answer is connected and the call continues as a normal call.

**9.17** You can program extensions so that they are not rung when a General Call is placed. See [page 4-19](#) for programming information.

**9.18 To ring all extensions:**

- *Keyset:* Select **General Call** on the display.
- *Single-Line:* Dial **6 5**.

## 10. OUTSIDE CALLS

**10.1** When a CO line is selected for receiving or placing an outside call, the voice channel is seized and cannot be used by any other extension. If the desired CO line is busy, the extension user can request a callback. Other features that apply to both outside and intercom calls are discussed later in this section of the manual. They include placing calls on hold, call waiting, call transfer, conferencing, and call forwarding.

### A. RECEIVING OUTSIDE CALLS

**10.2** There is a red light on the top right corner of the Keypad. This light flashes when there is an incoming call.

**10.3 To answer an outside call at a keypad:**

When the Keypad rings, you can do one of the following:

- Select **Answer The Call** on the display and speak handsfree.
- Press the **Speaker** key and speak handsfree.
- Lift the handset.

**10.4 To answer an outside call at a single-line set:**

When you hear ring signals, lift the handset; you are connected to the caller.

### B. PLACING OUTSIDE CALLS

**10.5 To place an outside call from a keypad:**

1. Lift the handset and select an available line in one of the following ways:
  - Select **External Call** on the display. Then select an available line. (Busy lines are indicated by a ♦ beside the line on the display).
  - Press a **Line** key (Line key 1 for line 1, Line key 2 for line 2, and so on). A lit Line key indicates a busy line.

---

**NOTE:** This is applicable only if the Programmable keys are programmed as Line key, which is the default programming.

---

- Dial **9** to select a line from Outgoing Group 1.
- Dial **81, 82, or 83** to select a line from Outgoing Groups 2, 3, or 4 respectively.
- Dial **51, 52, 53, 54, 55, 56, 57, or 58** to seize line 1, 2, 3, 4, 5, 6, 7, or 8 respectively.

2. Dial the telephone number you require. Digits are sent as they are dialed.

**10.6 To place an outside call from a single-line set:**

1. Lift the handset and select an available line in one of the following ways:
  - Dial **9** to select a line from Outgoing Group 1.
  - Dial **81, 82, or 83** to select a line from Outgoing Groups 2, 3, or 4 respectively.
  - Dial **51, 52, 53, 54, 55, 56, 57, or 58** to seize line 1, 2, 3, 4, 5, 6, 7, or 8 respectively.
2. Dial the telephone number you require. Digits are sent as they are dialed.

## Using Keypad Pre-Dial Mode



**10.7** This method can be used only at Keypad extensions. If you do not lift the handset in step 1 on the previous page, you may enter digits in “Pre-Dial Mode.” Digits will not be sent until you lift the handset, press the Speaker key, or select Send Digits from the display.

- You can edit the number you have entered prior to sending the digits by using the left Keypad Edit key, located below the keypad.
- If you are entering an external number in Pre-Dial Mode, enter 9, 81-83, or 51-58 first, to have a line seized when you send the digits for processing.

## Using Speed Dialing

**10.8** You have access to a personal speed-dial list (12 numbers at a Keypad, 10 at a single-line set), and a system speed-dial list of up to 200 numbers. You can program your personal list, using the procedures shown on [page 3-38](#). The system speed-dial list is programmed by the installer or system administrator.

### 10.9 To dial a personal speed-dial number at a keypad:

1. Press the **DIRECTORY**  key.
2. Select **Personal Speed Dial** from the display to access your personal speed-dial list.
3. Select the number you wish to dial. Use the Scroll Down () key to move down the list, if necessary. A line will automatically be seized and the number dialed.

### 10.10 To dial a system speed-dial number at a single-line set:

1. Press the **DIRECTORY**  key.
2. Select **System Speed-Dial**.
3. Press one of these Display keys:
  - If the list has names programmed, you can choose **Select By Name**. Entries are sorted in alphabetical order. Enter the first letter of the name you want. The first three entries starting with that letter are displayed. Use the Scroll keys to locate the name you want and select it.
  - If names are not programmed on all of the entries, you can choose **Select By Location**. All entries, with or without names, are displayed in the location order. Locations with no numbers entered, will not be displayed. Use the Scroll keys to locate the name you want and select it.
4. When you have selected the number or name you want, a free line is automatically selected and the number dialed.

### 10.11 To dial a system speed-dial number at a single-line set:

1. Lift the handset.
2. Do one of the following:
  - Dial **6 1** and then enter the desired speed-dial number (0-9). The number is automatically dialed.
  - Dial the System Speed-Dial location code (7001 – 7200) of the number you wish to access. The number is automatically dialed.

### Calling the Sales or Service Number

**10.12** If your system is programmed with the telephone numbers for your Sales and/or Service personnel, you can easily call them using this procedure. See [page 4-15](#) for number programming information.

#### **10.13 To dial the sales or service number at a keyset:**

1. Press the **DIRECTORY**  key.
2. Select **System Speed-Dial**.
  - Select **System Service** to dial the Service number.
  - Select **System Sales** to dial the Sales number.
3. When you have selected the number or name you want, a free line is automatically selected and the number dialed.

### Redialing

**10.14** The redial feature stores the last telephone number dialed at the extension (manually or speed-dialed). If you reach a busy number, are disconnected, or if there is no answer, the number can be redialed easily. Only one telephone number can be stored for the extension at one time.

**10.15** When the Redial feature is used, a line is seized automatically.

#### **10.16 To redial the last external number dialed:**

- *Keyset:* Select **Redial Last Number** from the display.
- *Single-Line:* Lift the handset and dial **6 0**.



## C. LINE RING BACK

**10.17** If you enter a feature code to select a line and no lines are free, use the Ring Back feature to receive a line as soon as one is available.

**10.18 To have a busy line call you back when it becomes free at a keyset:**

1. Select **Ring Back** on the display.
2. When the line becomes free, your extension will ring. The displays show **Ring Back From Extension**. Select **Answer The Call** or pick up the handset to access the line.

**10.19 To have a busy line call you back when it becomes free at a single-line set:**

1. Perform a hookflash and dial **5**.
2. When the line becomes free, your extension will ring. Pick up the handset to access the line.

## D. CALL PICK-UP

**10.20** Extensions can be programmed to be in Pick-Up Groups. Group members can pick up any call (internal or external), that is ringing at another extension in the same group. See [page 4-20](#) for programming information.

**10.21** For extensions not in your Pick-Up Group, you can pick up external, but not internal, calls. You can also pick up an external call that is ringing on a Central Bell.

**10.22 To pick up at a keyset:**

- *If the call is in your Pick-Up Group:* Select **Call Pick Up** on the display.
- *If the call is outside your Pick-Up Group:* Select **External Call Pick Up** on the display.

**10.23 To pick up at a single-line set:**

- *If the call is in your Pick-Up Group:* Dial **6 8**.
- *If the call is outside your Pick-Up Group:* Dial **6 7**.

## 11. PLACING CALLS ON HOLD OR PARK

### A. HOLD

**11.1** The Hold feature is available on outside calls only. When a user puts a call on hold, all Keysets will have a flashing or lit Line key for that call, depending on system programming. Any keyset user can pick up a call that was placed on hold by pressing the Line key.

**11.2** System programming determines what other Keyset users will see when a call is placed on hold. The associated Line key can be programmed to flash or remain steady on all other Keysets. The default setting is that the light flashes. (See [page 4-10](#) for programming information.)

**11.3** System timers ensure that calls placed on hold are not forgotten. If an outside call remains on hold until the timer expires, it recalls the extension. See [page 4-12](#) for timer programming.

**11.4 To place a call on hold at a keyset:**

1. While on the call, do one of the following:
  - Press the **Hold** key.
  - Select **System Hold** on the display.
2. To retrieve the call, select **Return To Line** on the display, or press the flashing **Line** key.

---

**NOTE:** If an extension has two calls on hold, selecting Return To Line will return to the first call that was put on hold.

---

**11.5 To place a call on hold at a single-line set:**

1. While on the call, perform a hookflash then hang up.
2. You can leave the handset on hook or use your telephone.
  - The held call will call back after thirty seconds if your telephone is idle.
  - If your phone is busy after the thirty seconds, the call will ring as soon as you hang up.

### B. CALL PARK

**11.6** The Call Park feature allows you to put an external call on special hold by “parking” it in the system. Any extension may then pick up the call.

**11.7** Only one call may be parked in the system at a time. A parked call will recall the extension that parked it when the Call Park timer expires (defaults to three minutes). See [page 4-12](#) for timer programming.

**11.8 To park and retrieve a call on a keyset:**

1. While on a call, select **Call Park** on the display.
2. **Pick Up Park** is then displayed on the top line on the display on all Keysets. Select this option to retrieve the parked call.

**11.9 To park and retrieve a call on a single-line set:**

1. While on a call, perform a hookflash and dial **4 0**.
2. Dial **4 0** again to retrieve the parked call.

## C. CONSULTATION HOLD

**11.10** Consultation hold allows a user to pause during an outside call, call another outside number or extension, and then switch between the two calls. (Intercom calls cannot be placed on consultation hold.)

**11.11 To place a call on consultation hold at a keyset:**

1. Scroll to and select **External Consultation**.
2. Select an available line and dial the number.
3. When the call is answered, you can go back and forth between both calls. Select the **Return and Hold** option on the display each time you want to switch to the other call.

**11.12 To place a call on consultation hold at a single-line set:**

1. While on an external call, perform a hookflash and dial the extension number or select a line and dial an outside number.
2. You have the following options:
  - *To return to the previous call and place the current call on hold:* Perform a hookflash and dial **2**.
  - *To return to the previous call and release the current call:* Perform a hookflash and wait. Or perform a hookflash and dial **1**.
  - *To transfer the first call to the extension or outside number:* Hang up while the first call is on hold.

## 12. CALL WAITING

**12.1** If you get a busy tone when you call an extension, you can send a call waiting tone to the extension, provided it is not protected against receiving call waiting tones. An audible tone will sound on the called extension, and the option “Call Wait – Ext xx” will appear on its display. If the called extension is protected against call waiting tones, it will not signal your call to the user.

**12.2 To send a call waiting tone:**

*Keyset:* Select **Waiting Tone** on the display when you hear busy tone.

*Single-Line:* Perform a hookflash and dial **8** when you hear busy tone.

**12.3** If another extension sends call waiting signal to you, it will be indicated on your display and you will hear the call waiting tone (provided your extension is not protected against call waiting tones). If you ignore the call waiting tone for a short period, the calling telephone will be presented with the message “Call Waiting Rejected.”

**12.4 To answer a waiting call:**

*Keyset:* Either hold or release the current call and then select **Answer Call** from the display to answer the waiting call.

*Single-Line:* Hang up to end your current call or place it on hold. The waiting call will ring.

## 13. CALL WAITING TONE PROTECTION

**13.1** As described above, an extension user may send a busy extension a call waiting tone, provided it is not protected against receiving call waiting tones. Any user may program his or her extension to block call waiting tones during a call (or it can be programmed at the Programming Extension, as shown on page 4-18).

### **13.2 To protect an individual call from call waiting tones:**

*Keyset:* When you are on a call, select **Tone Protect** on the display.

*Single-Line:* While on a call, perform a hookflash and dial **6 6**.

## 14. CALL TRANSFER

**14.1** Extension users can transfer outside calls to other extensions or to outside numbers.

- You can transfer a call to an extension after the extension user has answered, while the extension is ringing, or while busy tone is being received from the extension.
- Transferring an external call to an external number ties up two lines. Such calls are called trunk-to-trunk calls. When a trunk to trunk call is set up it is automatically disconnected after a pre-programmed time (five minutes in default). Calls will be disconnected before the timeout period if either of the parties involved in the call hangs up.

---

**NOTE:** You may prevent individual extensions from setting up trunk-to-trunk calls using External Forward, External Transfer and External Conference. See page 4-22 for details.

---

**14.2** If the transferred call remains unanswered at the receiving extension, it recalls the extension that transferred it. See page 4-12 for timer programming.

### **14.3 To transfer to an extension call using a keyset:**

1. While on the call, select **Internal Transfer** on the display.
2. Select the desired extension from the extension list shown on the display, or dial the extension number.
3. Select **Transfer** or hang up, to transfer the call.

### **14.4 To transfer to an external number using a keyset:**

1. Scroll to and select **External Transfer**.
2. Select a free line and dial the number.
3. When the call is answered, press **Transfer**.

### **14.5 To transfer a call using a single-line set:**

1. Perform a hookflash on your telephone.
2. Dial the extension number or select a line and dial an outside number and hang up.

## 15. REDIRECTING RINGING CALLS

**15.1** This feature allows you to forward a call while it is ringing at your Keypad.

**15.2 To forward a call ringing at your keypad:**

1. Select **Forward The Call** on the display.
2. Do one of the following:
  - Select a free extension from the extension list shown on the display. The call is sent to the selected extension and stops ringing at your Keypad. (If you attempt to forward a call to an unavailable extension, it will continue to ring at your Keypad.)
  - Send the call to your voice message box by selecting **VM** on the display. (The “Forward To Voice Messaging” prompt is not displayed if your extension is not equipped with a voice box.) For information on setting up and using a voice message box, refer to [page 3-20](#).

## 16. CALL FORWARDING

**16.1** With call forwarding, an extension user can route incoming intercom and direct ring-in outside calls to another extension, to their voice message box, or to an outside telephone number. The three forwarding options are:

- **Call Forward All Calls.** All incoming calls are forwarded automatically.
- **Call Forward On No Answer.** The Forward If No Answer feature allows you to forward all your calls if there is no answer at your extension before the Forward On No Answer timer expires. (See [page 4-12](#) for timer programming.) If your extension is forwarded to an outside number, internal calls will not be forwarded (the caller will hear busy tone).
- **Call Forward When Busy.** The Forward If Busy feature allows you to forward all your calls whenever your extension is busy. If your extension is forwarded to an outside number, internal calls will not be forwarded (the caller will hear busy tone).

**16.2** You cannot forward calls to an extension that has the “Do Not Disturb” feature set. If the extension that is programmed to receive your forwarded calls is later placed in do-not-disturb, intercom callers will hear do-not-disturb signal when the call is forwarded.

**16.3** Make sure the forwarding destination is not forwarded to another destination. If a forwarding chain has been set up (for example, Extension 20 forwards to Extension 21 which is forwarded to Extension 22, etc.) the forward only goes to first forwarding destination (Extension 21 in the example), but does not go to the other extensions because chained forwards are not recognized.

**16.4** The only calls that will forward to external numbers are those that ring in *only* to your extension. If they ring at any other extension, they will not be forwarded.

**16.5** Forwarding an external call to an external number ties up two CO lines. Such calls are called trunk-to-trunk calls and are limited by a five minute timer. When that timer expires, the call is automatically disconnected.

---

**NOTE:** You may prevent individual extensions from setting up trunk-to-trunk calls using External Forward, External Transfer and External Conference. See [page 4-22](#) for details.

---

## A. FORWARDING CALLS

### 16.6 To forward all calls from your keyset:

1. Scroll to and select **Forward**.
2. Select one of the following:
  - **Forward All Calls**
  - **Forward When Busy**
  - **Forward On No Answer**
3. Enter an extension number to forward all your calls to another extension.  
OR Enter **9** followed by a telephone number to forward calls to an outside number.  
OR Enter **3 8** to forward calls to your voice message box.
4. Select **Confirm**.

### 16.7 To forward all calls from your single-line set:

1. Lift the handset and enter one of the following:
  - Dial **151** for Forward All Calls
  - Dial **152** for Forward When Busy
  - Dial **153** for Forward On No Answer
2. Enter an extension number to forward all your calls to another extension.  
OR Enter **9** followed by a telephone number to forward calls to an outside number.  
OR Enter **3 8** to forward calls to your voice message box.

## B. CANCELING CALL FORWARD

### 16.8 To cancel forward when busy:

---

**NOTE:** You will hear interrupted dial tone until All Call forwarding is canceled.

---

*Keyset:* Select **Cancel Forwarding**.

*Single-Line:* Lift the handset, dial **151**, and hang up.

### 16.9 To cancel forward when busy:

*Keyset:* Select **Forward** and then **Forward When Busy**. The display returns to the Idle Menu.

*Single-Line:* Lift the handset, dial **152**, and hang up.

### 16.10 To cancel a forward on no answer:

*Keyset:* Select **Forward** and then **Forward On No Answer**. The display returns to the Idle Menu.

*Single-Line:* Lift the handset, dial **153**, and hang up.

## C. FOLLOW ME FORWARDING

**16.11** The Follow Me feature allows you to set a call forward to another extension after you have left your extension. You set the forward from the extension that will receive your forwarded calls.

**16.12 To forward your calls to you while you are at a keyset:**

1. From the extension that is to answer the calls, scroll to and select **Forward**.
2. Scroll to and select **Follow Me**.
3. Enter your extension number and your Extension Lock password. (The default Extension Lock password is 123). When these are entered, the forward is activated.

**16.13 To forward your calls to you while you are at a single-line set:**

1. From the extension that is to answer the calls, dial **154**.
2. Enter your extension number and your Extension Lock password. (The default Extension Lock password is 123). When these are entered, the forward is activated.

**16.14 To cancel follow me forwarding:**

Return to your extension and do the following:

- *Keyset*: Select **Cancel Forwarding**.
- *Single-Line*: Lift the handset, dial **154**, and hang up.

## 17. CONFERENCE CALLS

**17.1** This feature allows you to hold a three-way conversation between your extension and two other parties (extensions and/or outside lines).

**17.2 To set up a conference using a keyset:**

1. When on a call, press the Scroll Down (▼) key until the conference options are displayed.
  - **To add an extension to the conference:** Select **Internal Conference** and then select the extension.
  - **To add an outside call to the conference:** Select **External Conference** and then select a free line and dial the external number.
2. When the party answers, select **Conference** on the display.
3. Repeat the steps above to add the third party. All parties will hear a single tone to indicate that the call is a conference call.

**17.3 To set up a conference using a single-line set:**

1. Place the first call and then perform a hookflash.
2. Place the second call, perform a hookflash and dial **3**. All parties will hear a single tone to indicate that the call is a conference call.

---

**NOTE:** If you hang up while on a conference call with two outside parties, both parties will be disconnected.

---

## 18. PAGING

**18.1** The Encore System provide several Paging options:

- The system allows users to make announcements over the speakers of all Keysets.
- Users can make an Intercom Call via the speaker of a Keyset.
- External paging equipment (a paging amplifier and speaker) can be connected to any extension connection in the system. Users can then make announcements over the external paging equipment. See [page 4-13](#) for programming information. Also, certain extensions can be blocked from using the external paging equipment (see [page 4-22](#)).
- The Paging Answer feature allows a user respond directly to the paging extension, without having to know the extension number.
- Keyset extensions can be programmed to block both Paging announcements and Intercom Calls. See [page 4-19](#) for programming information.

### A. PAGING OVER EXTERNAL SPEAKERS

**18.2** To make an announcement over a external paging equipment from a keyset:

1. Lift the handset.
2. Scroll to and select **Paging**.
3. Select **Public Address** and make your announcement (up to 15 seconds).

---

**NOTE:** Do not hang up if you want the paged party to be able to respond directly to your page, as described below.

---

**18.3** To make an announcement over a external paging equipment from a single-line set:

1. Lift the handset and dial **4 7**.
2. Make your announcement (up to 15 seconds).

---

**NOTE:** Do not hang up if you want the paged party to be able to respond directly to your page, as described below.

---

### B. RESPONDING TO A PAGE

**18.4** If you have been paged over the public address paging equipment, the Paging Answer feature puts you in direct contact with the paging extension, provided that the person who paged you has not hung up.

**18.5** To respond to a page:

When you are paged, go to the nearest station and do the following:

- *Keyset:* Select **Answer Page**.
- *Single-Line:* Dial **4 5**.



## C. PAGING OVER KEYSSET SPEAKERS

**18.6** The Internal Paging feature allows any extension to make an announcement over the speakers of all Keysets. Only Keysets that are page-protected will not be paged (see page 4-19).

---

**NOTE:** While receiving a page, a Keyset cannot be used to make or receive calls or use any system features.

---

### **18.7 To make an all-keyset page from a keyset:**

1. Lift the handset.
2. Scroll to and select **Paging**.
3. Select **Page All Keysets**.
4. Make your announcement.

### **18.8 To make an all-keyset page from a single-line set:**

1. Lift the handset and dial **4 4**.
2. Make your announcement.

## D. INTERCOM CALLS

**18.9** The Intercom Call feature allows you to make a call over the speaker of an individual Keyset. If the Keyset is page-protected the Intercom Call will fail.

### **18.10 To make an intercom call using a keyset:**

1. Lift the handset.
2. Scroll to and select **Intercom Call**.
3. Select the extension you wish to page.
4. Make your announcement. (The microphone on the receiving Keyset is muted.)

### **18.11 To make an intercom call using a single-line set:**

1. Lift the handset and dial **4 3**.
2. Dial the extension you wish to page.
3. Make your announcement. (The microphone on the receiving Keyset is muted.)

### **18.12 To answer an intercom call at your keyset:**

Press the **Mute** key and speak in Handsfree Mode, or pick up the handset.

## 19. SPEED-DIAL NUMBERS

**19.1** Two Encore features provide speed dialing:

- **Personal Speed Dialing.** Personal speed-dial numbers can be stored for personal use. Keypad extensions can store up to 12 numbers and single-line extensions can store up to ten, as described below.
- **System Speed Dialing.** Up to 200 system speed-dial numbers can be stored from the programmer's keypad, for use by any extension.

**19.2** Both personal and system speed-dial numbers can be associated with names, if programmed from a keypad.

**19.3** See [page 3-27](#) for speed-dialing instructions.

---

**NOTE:** System speed-dial numbers can be programmed to override Class of Service. This feature allows an extension to access all system speed-dial numbers, even though the extension may be restricted from directly dialing a number because of their Class of Service.

---

### **19.4 To program speed-dial numbers at a keypad:**

1. Press the **PROGRAM** key.
2. Select **Personal Speed-Dial**. The first three locations will be displayed.
3. Select the location you want to program. Use the Scroll Down (▼) key to scroll to the locations as required.
4. Select **New Entry**.
5. Enter the number. If necessary, you may insert a pause of one second between digits by selecting **Pause** on the display. A maximum of ten digits, including pauses, may be entered. (However, you cannot use a pause as the first digit of the speed-dial number.)
6. When the number is entered, select **Confirm**.
7. You are then prompted to enter a name. If you want to do so, follow the instructions on [page 3-13](#). A maximum of ten characters per name, including spaces, may be entered. If you want the number only, press **Cancel**.
8. Press the **Speaker** key to finish programming.

### **19.5 To program speed-dial numbers at a single-line set:**

1. Lift the handset.
2. Dial **6 2**.
3. Enter the location (0 - 9) where you want to store the number.
4. Dial the number you want to store, up to ten digits.
5. Hang up.

### **19.6 To erase speed-dial numbers:**

Repeat the steps shown above for programming a number, but skip the step where you enter the digits.

## 20. SENDING A HOOKFLASH OVER A CO LINE

**20.1** A hookflash may be required when you are using certain telephone company services on your lines, or if your Encore System is connected to another telephone system (PBX) via one of the line interfaces.

**20.2** The Hookflash feature allows you to send a timed hookflash over the outside line. To send a hookflash, you must be on a call or have dialed at least one digit of the number you are calling. (See [page 4-31](#) for information on programming the hookflash method).

**20.3** To send a hookflash over a line:

*Keypad:* Select **Hookflash** on the display.

*Single-Line:* Perform a hookflash and dial **8 7**.

## 21. DISPLAY MESSAGES

**21.1** This feature enables you to set a Display Message that will be seen by any Keypad calling your extension. You can set a Display Message using a single-line set, but you cannot check the content.

**21.2** When setting up a Display Message, the message menu offers a choice of eight pre-programmed messages. The messages are numbered 1-9 so that they can be selected at single-line extensions. (Message 9 is blank so you can enter your own message.) Messages 1-8 are:

**Table 3-7:** *Display Message Text*

| MESSAGE # | MESSAGE TEXT |
|-----------|--------------|
| 1         | Return At    |
| 2         | Call Back At |
| 3         | Call Me At   |
| 4         | In A Meeting |
| 5         | At Lunch     |
| 6         | Gone Home    |
| 7         | On Vacation  |
| 8         | Call         |

**21.3 To set a display message from a keypad:**

1. Press the **MESSAGE** ☒ key.
2. Select **Display Messaging**.
3. Select the message to be displayed from the message menu. (Scroll down, if necessary.)
4. You can add extra text to the message by selecting the **Enter Data** option. See [page 3-13](#) for instructions entering text using the keypad. Also, if you wish to enter a time or a date, press \* for a colon (:), or press # for a dash (-).
5. Press the **Speaker** key to finish programming.

**21.4 To set a display message from a single-line set:**

1. Lift the handset and dial **3 9**.
2. Enter the number of the desired pre-programmed message (1-8).
3. Hang up.

**21.5 To cancel a Display Message:**

*Keypad:* Select **Cancel The Message**.

*Single-Line:* Lift the handset, dial **3 9**, and hang up.

## 22. DO NOT DISTURB

**22.1** If your extension is set to Do Not Disturb, anyone trying to call you will receive a busy signal. If the person trying to contact you has a Keypad, “Do Not Disturb Enabled” will appear on the display. Ring Back and Reminder calls are the only incoming calls that will be accepted when this feature is set.

**22.2** Whenever Do Not Disturb is set, you will hear an interrupted dial tone when you lift the handset.

**22.3 To set do not disturb:**

*Keypad:* Scroll to and select **Do Not Disturb**.

*Single-Line:* Lift the handset, dial **1 5 0**, then hang up.

**22.4 To cancel do not disturb:**

*Keypad:* Select **Cancel Do Not Disturb**.

*Single-Line:* Lift the handset, dial **1 5 0**, then hang up.

## 23. REMINDER CALL

**23.1** This feature enables you to set your extension to ring at a given time. At the programmed time, the extension will ring ten times. If not answered, it will ring twice more at two-minute intervals.

**23.2** Reminder calls must be set daily and therefore cannot be set more than 24 hours ahead.

**23.3 To set a reminder call at a keypad:**

1. Scroll to and select **Reminder Call**.
2. Enter the time in the 24-hour clock format, for example, 0930 for 9:30 AM.

**23.4 To set a reminder call at a single-line set:**

1. Lift the handset, dial **4 6**.
2. Enter the time in the 24-hour clock format, for example, 0930 for 9:30 AM.
3. Hang up.

**23.5 To view and/or cancel a reminder call at a keypad:**

Select **Reminder Call** and the set time will be displayed. You can then do any of the following:

- To retain the programmed time, select **Confirm**.
- To change the time, select **Change** and enter a new time.
- To cancel the reminder call, select **Change** followed by **Confirm**.

**23.6 To cancel a reminder call at a single-line set:**

Lift the handset, dial **4 6 \*** and hang up.

## 24. EXTENSION LOCK

**24.1** This feature allows you to lock your extension to prevent unauthorized users from making external calls.

**24.2** You use an Extension Lock password to lock, unlock, or to make calls from a locked extension. The default Extension Lock password for all extensions is 123, but each extension user may change his or her password. Extension Lock passwords can be viewed from the Programming Extension (see [page 4-22](#)).

### CAUTION

Emergency Access Hazard. Locked extensions cannot be used to dial emergency (911) calls. Make sure another phone is easily accessible in an emergency before you lock your phone.

### A. LOCKING AND UNLOCKING YOUR KEYSSET

#### **24.3 To lock your keyset:**

1. Scroll to and select **Lock The Extension**.
2. Dial your three-digit Extension Lock password. (The default password is 123).
3. Press the **Speaker** key to finish programming.

#### **24.4 To unlock your keyset:**

1. Select **Unlock The Extension**.
2. Dial your three-digit Extension Lock password.
3. Press the **Speaker** key to finish programming.

#### **24.5 To lock or unlock your single-line set:**

1. Lift the handset and dial **4 1**.
2. Dial your three-digit Extension Lock password. (The default password is 123).
3. Hang up to finish programming.

### B. PLACING CALLS WHILE YOUR EXTENSION IS LOCKED

#### **24.6 To make a call from a locked keyset:**

1. Dial **9**, or press a **Line** key, or dial the code for a line (51 - 58), as if to select a line.
2. Dial your three-digit Extension Lock password.
3. Lift the handset, press **Send Digits**, or press the **Speaker** key.
4. When the line is seized, dial the desired number.

#### **24.7 To make a call from a locked single-line set:**

1. Lift the handset and dial your three-digit Extension Lock password.
2. Place your call as usual.

## C. CHANGING YOUR PASSWORD

---

**NOTE:** If you forget your password, it can be viewed using the Programming Extension (see page 4-22).

---

### **24.8 To change your extension lock password at a keyset:**

1. Scroll to and select **Extension Lock**.
2. Select **Change The Lock Code**.
3. Dial your three-digit Extension Lock password.
4. Press the **Speaker** key to finish programming.

### **24.9 To change your extension lock password at a single-line set:**

1. Lift the handset and dial **4 2**.
2. Dial your three-digit Extension Lock password. (The default password is 123).
3. Hang up to finish programming.

## 25. EXTENSION RESET

**25.1** You can reset your extension to cancel all the following features if they have been set:

- Do Not Disturb
- Call Forward
- Ring Back
- Display Messaging
- Reminder Call

### **25.2 To reset your extension:**

*Keyset:* Scroll to and select **Reset The Telephone**. The display shows **Extension Reset** momentarily before returning to the Idle Menu.

*Single-Line:* Lift the handset and dial **1 5 7**. Wait for dial tone to return, then hang up.

## 26. MANAGER/SECRETARY

**26.1** The Manager/Secretary feature is a set of programming options used to maximize the efficiency with which two people work together. It is typically used for a manager/secretary partnership.

**26.2** To activate the Manager/Secretary feature, it is necessary to first combine the Manager and Secretary Extensions. When the Manager/Secretary combinations are programmed, the Secretary may answer calls ringing on the Manager's Extension by pressing a key that is programmed with the manager's number. See [page 4-23](#) for programming information.

**26.3** The Secretary can call the Manager, while the Manager's Extension is idle, by pressing the key. Also, the Secretary can see the status of the Manager's Extension from the key light (lit if the extension is busy, and flashing if ringing).

**26.4** Other system features that may be used in the Manager/Secretary partnership include:

- Programming a dedicated line for the Manager (so that no other extension may make or receive calls on that line)
- Programming the Manager's Extension with a key for paging or calling the Secretary's Extension
- Programming the Manager's Extension to forward all calls to the Secretary

**26.5 To program a key to answer the Manager's calls:**

1. At the extension programmed as the Secretary, press the **PROGRAM** key.
2. Scroll to and select **Key Programming**.
3. Select the Programmable key you want to program.
4. Select **Extensions**.
5. Enter the Manger's extension number
6. Select **Confirm**.
7. Press the **Speaker** key to finish programming.

## 27. ROOM MONITOR

**27.1** Extensions 20 and 21 can call an extension with Room Monitor activated and listen to the room through the handset receiver.

**27.2 To monitor a room using a keyset:**

1. *At the Keyset in the room you wish to monitor*, scroll to and select **Room Monitor**. Lift the handset and leave it off-hook.
2. *At the extension from where you want to listen*, dial the number of the extension where you set up Room Monitor.

**27.3 To monitor a room using a single-line set:**

1. *At the single-line set in the room you wish to monitor*, lift the handset and dial **4 8**. Leave the handset off-hook.
2. *At the extension from where you want to listen*, dial the number of the extension where you set up Room Monitor.

**27.4 To cancel room monitoring:**

Hang up the handset at both extensions.

## 28. OPERATOR EXTENSION

**28.1** The system has one operator (Extension 20). The operator extension provides the following services:

- Can be called by dialing “0”
- Places the system in night mode or day mode
- Can intrude on a trunk-to-trunk call in progress
- Controls the Answering Machine message box
- Forwards Hunt Group calls

### A. DAY SERVICE/NIGHT SERVICE

**28.2** The Day Service/Night Service feature allows you to change the extensions which ring on incoming calls, change the Class of Service at each extension, and change the voice greeting heard by callers, (if you have Voice Messaging installed). These changes can take place each day automatically at pre-programmed times, or can be invoked manually, as described below.

**28.3 To manually turn night service on or off:**

At Extension 20, select **Night Service**.

### B. INTRUDE

**28.4** The Intrude feature is only available from Extension 20, and is used to monitor a call involving two lines (trunk-to-trunk call). This occurs when an outside call is transferred or forwarded to an outside line.

**28.5 To intrude on a trunk-to-trunk call:**

1. Select one of the lines by pressing its **Line** key
2. Select **Intrude** on the display. You are connected to the parties in a three-way conversation.



## C. USING THE ANSWERING MACHINE

**28.6** This service acts as an answering machine. It can be used for answering incoming calls and record messages for selected lines. All messages received are stored in a system voice message box, which is controlled by Extension 20. The user at Extension 20 can do the following:

- Customize the greeting for the message box. The greeting may ask callers to dial an extension number, in which case the call will be transferred through to that extension.
- Turn the Answering Machine service on and off at any time. (Its operation is independent of Day/Night Mode operation.) If desired, this feature can be turned on permanently, so that calls that are not answered for a programmable period (see [page 4-12](#) for timer programming), are answered by the Answering Machine. To change the answering machine timer, refer to [page 4-12](#).

---

**NOTE:** Extension 20 can have its own voice message box, accessed by using extension number 20. The Answering Machine has its own voice message box, accessed by using extension number 0. Both can have their own Voice Messaging passwords.

---

### **28.7 To turn the answering machine on and off:**

Scroll to and select/deselect **Answering Machine** to turn the Answering Machine on or off.

### **28.8 To change the greeting on the answering machine:**

1. Press the **MESSAGE**  key.
2. Select **Voice Messages**.
3. Enter **0** as the voice message box number.
4. Enter your Voice Messaging password, (1111 by default), followed by **#**.
5. Select **Greeting**.
6. Select **Record Greeting**.
7. Speak to record a personalized greeting when prompted.
8. Press **Confirm**.
9. Press the **Speaker** key to finish programming.

**28.9** Messages stored on the Answering Machine can be retrieved from Extension 20 only. When messages have been left, the Message Waiting Light on Extension 20 will be lit and “Voice Messages” will appear on the top line of the display.

### **28.10 To retrieve messages left on the answering machine:**

1. Select **Voice Messages**.
2. Enter **0** as the extension number.
3. Enter the Voice Messaging password and select the option you require. (See [page 3-20](#) for details instructions on retrieving voice messages.)

## D. HUNT GROUP FORWARDING

**28.11** The Hunt Group feature allows you to have groups of extensions answering different lines (as described on the next page).

**28.12** Hunt Group calls can be forwarded to an extension or outside number at Extension 20, as described below. Normally, you would use either the Forward No Answer or Forward When Busy option. This allows you to set up an “overflow” destination for call when the hunt group members do not answer or all members are busy.

**28.13 To set up hunt group forward:**

1. Scroll to and select **Hunt Group Forward**.
2. Select the desired Hunt Group. (If selecting Group 4, you must press the Scroll down key (▼) to see it.)
3. To select the type of Forward you want to use, select one of the following:
  - **Forward All Calls**
  - **Forward When Busy**
  - **Forward On No Answer**
4. Enter the extension or outside number to which the calls are to be forwarded. If you are forwarding to an external number first dial a line access code, (9, 51, 81, etc.), and then the number.
5. Press the **Speaker** key to finish programming.

---

**NOTE:** Individual extensions in a Hunt Group cannot forward calls that ring in to the Hunt Group. Also, when “Hunt Group Forward” is enabled, there is no indication given on Keypad displays.

---

## 29. HUNT GROUPS

**29.1** The Hunt Group feature allows you to have groups of extensions answering different lines.

**29.2** The calls to the Hunt Group are presented in cyclical order to the extensions in the group. That is, the first call is presented to the first extension on the list, the next to the second extension, and so on. If a hunt group member is busy or does not answer, the call will move down the list to the next extension.

**29.3** Hunt Groups are programmed during database programming. See [page 4-27](#) for programming information.

**29.4** Hunt Group calls can be forwarded to an extension or outside number at Extension 20, as described on the previous page. Normally, you would use either the Forward No Answer or Forward When Busy option. This allows you to set up an “overflow” destination for call when the hunt group members do not answer or all members are busy.

---

**NOTE:** The lines and extensions programmed in a Hunt Group are exclusive to that Hunt Group and cannot be placed in another Hunt Group. Calls can be transferred to an individual extension in a Hunt Group from an extension outside the Hunt Group, but not to the Hunt Group as a whole.

---

## 30. CALL LOGGING

**30.1** If the system is equipped with a Call Logging Module, a printer or PC may be connected, which will maintain a record of incoming and outgoing calls made on the system. Details are printed as the calls are completed. See [page 4-11](#) for programming information.

**30.2** Call Logging can be programmed to ignore calls from certain extensions. To prevent call from being logged, see [page 4-11](#).

**30.3** Call Logging uses the V24 module.

**30.4** Calls are printed out in the following format as they are completed:

| 1   | 2        | 3        | 4        | 5   | 6   | 7   | 8       | 9       |
|-----|----------|----------|----------|-----|-----|-----|---------|---------|
| O/G | 01/10/01 | 12.00:01 | 00:00:30 | L01 | S21 | S21 | :000.00 | 1234567 |
| O/G | 01/10/01 | 12.00:10 | 00:01:56 | L02 | S25 | S25 | :000.00 | 567890  |
| I/C | 01/10/01 | 12.01:13 | 00:06:32 | L03 | S22 | S24 | :000.00 |         |

**30.5** The explanation of the data output is as follows:

**Table 3-8:** *Call Logging Data Output Description*

| COLUMN # | DATA OUTPUT EXPLANATION               |
|----------|---------------------------------------|
| 1        | Incoming (I/C) or Outgoing (O/G) Call |
| 2        | Date (day/month/year)                 |
| 3        | Start Time                            |
| 4        | Duration of the Call                  |
| 5        | Line Used                             |
| 6        | Initiating Extension                  |
| 7        | Terminating Extension                 |
| 8        | Not Used (Reserved for future use)    |
| 9        | Digits Dialed                         |



# Keyset Programming

| CONTENTS                                                     | PAGE        |
|--------------------------------------------------------------|-------------|
| <b>1. Introduction</b> .....                                 | <b>4-3</b>  |
| <b>2. The Programming Keyset</b> .....                       | <b>4-3</b>  |
| <b>3. Beginning the Keyset Programming Session</b> .....     | <b>4-4</b>  |
| <b>4. System-Wide Programming</b> .....                      | <b>4-5</b>  |
| A. System Time and Date .....                                | 4-7         |
| B. Language Setting for Keyset Displays .....                | 4-7         |
| C. System Programming Password .....                         | 4-7         |
| D. Programming Position .....                                | 4-8         |
| E. System Speed-Dial Numbers .....                           | 4-8         |
| F. Night Service .....                                       | 4-9         |
| G. Set the Music-On-Hold Option .....                        | 4-10        |
| H. Line Key Lights .....                                     | 4-10        |
| I. System Greetings .....                                    | 4-11        |
| J. Call Logging Enable/Disable .....                         | 4-11        |
| K. System Timers .....                                       | 4-12        |
| L. Doorphone Equipped/Unequipped .....                       | 4-13        |
| M. External Paging .....                                     | 4-13        |
| N. Caller ID Storage .....                                   | 4-13        |
| O. Class of Service Access Tables .....                      | 4-13        |
| P. Local Area Codes .....                                    | 4-14        |
| Q. System Reset .....                                        | 4-14        |
| R. V24 Baud Rate .....                                       | 4-14        |
| S. Sales and Service Numbers .....                           | 4-15        |
| T. Voice Mail (VM) Capacity .....                            | 4-15        |
| U. Group Divert to VM .....                                  | 4-15        |
| V. 911 & Extension Sending .....                             | 4-15        |
| <b>5. Extension Programming</b> .....                        | <b>4-16</b> |
| A. Extension User Names .....                                | 4-18        |
| B. Classes of Service .....                                  | 4-18        |
| C. Call Waiting Tones .....                                  | 4-18        |
| D. Paging and Intercom Calls .....                           | 4-19        |
| E. General Calls .....                                       | 4-19        |
| F. Doorstrike .....                                          | 4-19        |
| G. Pick-Up Groups .....                                      | 4-20        |
| H. Caller ID Storage Allocations .....                       | 4-20        |
| I. System Speed-dial Numbers Override Toll Restriction ..... | 4-20        |
| J. Voice Message Box Assignments .....                       | 4-21        |
| K. Disconnected Extensions .....                             | 4-21        |
| L. No Call Logging .....                                     | 4-21        |
| M. No Trunk-To-Trunk Calls .....                             | 4-22        |
| N. Extension and System Passwords .....                      | 4-22        |
| O. Restrict Use of Paging Equipment .....                    | 4-22        |
| P. Port Swapping .....                                       | 4-22        |

| <i>CONTENTS</i>                                    | <i>PAGE</i> |
|----------------------------------------------------|-------------|
| Q. Hot Line Extension .....                        | 4-23        |
| R. Manager/Secretary Combinations .....            | 4-23        |
| S. Keypad Feedback .....                           | 4-23        |
| <b>6. Line Programming .....</b>                   | <b>4-24</b> |
| A. Day/Night Ringing for Incoming Calls .....      | 4-25        |
| B. Day/Night Central Bell Ringing .....            | 4-25        |
| C. Outgoing Line Restriction .....                 | 4-25        |
| D. Equipped/Unequipped Lines .....                 | 4-26        |
| E. Incoming-Only Lines .....                       | 4-26        |
| F. Outgoing Line Groups .....                      | 4-26        |
| G. PBX Access .....                                | 4-27        |
| H. Hunt Groups .....                               | 4-27        |
| I. Answering Machine Lines .....                   | 4-28        |
| J. Courtesy Greeting Source and Lines .....        | 4-28        |
| K. Caller ID Names and Routing .....               | 4-29        |
| L. Alternate Routing .....                         | 4-29        |
| M. Automated Attendant .....                       | 4-30        |
| N. CO Line Configuration .....                     | 4-31        |
| <b>7. System Program Planning Sheets .....</b>     | <b>4-32</b> |
| <b>8. Extensions Program Planning Sheets .....</b> | <b>4-36</b> |
| <b>9. Line Program Planning Sheets .....</b>       | <b>4-37</b> |

## 1. INTRODUCTION

**1.1** This section of the manual explains how to program the system. The default values of the Encore System reflect a typical installation, therefore the system only requires minimal programming before startup. Some installations will require additional programming to enable special features and make changes to meet the customer's special needs.

**1.2** Programming that *must* be completed after initial installation include:

- Disconnect line interfaces that have no CO lines connected.
- Program incoming ringing and line access.
- Set up Voice Messaging and/or Answering Machine, if used.
- Program the Doorphone, if installed.
- Program the paging equipment position, if installed.

---

**NOTE:** Programmers or technicians must be certified on the Encore System to receive technical support.

---

**1.3** If you prefer to program using a PC, you can use the Encore Remote Management Software (RMS). RMS provides most of the programming options in addition to remote maintenance and diagnostics features.

**1.4** Refer to “RMS Programming” on [page 5-1](#) for information on using RMS for programming system features. Where appropriate in this chapter, page numbers are provided for corresponding RMS programming options.

## 2. THE PROGRAMMING KEYSSET

**2.1** At default, Extension 20 is the Programming Extension, and it has access to all of the system programming options. If programming is attempted from any other extension, the display will show Programming Refused. Because Extension 20 also serves as the system operator, you may wish to change the Programming Extension to a different Keyset (see [page 4-8](#)).

### 3. BEGINNING THE KEYPAD PROGRAMMING SESSION

**3.1** You can gain access to all system programming options by pressing the **PROGRAM** key on the Keypad connected to Programming Extension. While programming, the Scroll Up (▲) and Scroll Down (▼) keys may be used to scroll between the various screens.

**3.2 To begin programming:**

1. From the Programming Extension, press the **PROGRAM** key.
2. Press the Scroll Down Key (▼) until **System Programming** is displayed.
3. Select **System Programming**.
4. When prompted, enter the System Programming password, which is 1111 by default.

---

**NOTE:** You can also enter system programming by dialing **# # 1111** at the Programming Extension and selecting **Send Digits**.

**ALSO:** Where appropriate, page numbers for corresponding options in RMS Programming are shown.

---

5. A screen appears offering options to configure the overall system, the extensions, or the lines. Select the desired option.
  - **System.** Provides programming options that affect the system operation. Instructions for these programming options begin on [page 4-5](#).
  - **Extensions.** Provides programming options that affect extensions. Instructions for these programming options begin on [page 4-16](#).
  - **Lines.** Provides programming options that affect incoming CO lines. Instructions for these programming options begin on [page 4-24](#).



## 4. SYSTEM-WIDE PROGRAMMING

**4.1** When you select **System**, the system-wide programming options appear on the display. The following table lists the available options with their allowed values and defaults, if applicable. Instructions for programming each option are given in the following pages. To program these options and others using RMS, refer to “RMS System Programming” on page 5-36. Also, the following table lists the RMS location and equivalent option and page number.

**Table 4-1:** *Keyset Programming – System-Wide Programming*

| PROGRAMMING OPTION              | ALLOWED VALUES                                                                                                               | DEFAULT VALUE             | RMS LOCATION                                 | RMS EQUIVALENT                      | PAGE      |
|---------------------------------|------------------------------------------------------------------------------------------------------------------------------|---------------------------|----------------------------------------------|-------------------------------------|-----------|
| Language (page 4-7)             | English, Spanish, or French                                                                                                  | English                   | Extension/<br>Phone<br>Programming           | Extension<br>Settings;<br>Language  | page 5-19 |
| Time And Date (page 4-7)        | HH:MM MM-DD-YY                                                                                                               | 12:00<br>01.01.01         | System<br>Programming                        | System Date<br>and Time             | page 5-43 |
| Change Password (page 4-7)      | Four-digit password                                                                                                          | 1111                      | System<br>Programming;<br>System<br>Settings | System<br>Programming<br>Password   | page 5-37 |
| Programming Position (page 4-8) | Any Extension                                                                                                                | Extension 20              |                                              | Programming<br>Position             |           |
| System Speed Dial (page 4-8)    | Up to 200 numbers                                                                                                            | None<br>programmed        | System<br>Programming                        | System Speed<br>Dial List           | page 5-42 |
| Night Service (page 4-9)        | Automatic Service<br>and/or<br>Weekend Service                                                                               |                           | System<br>Programming;<br>System<br>Settings | Night Service                       | page 5-37 |
| Music On Hold (page 4-10)       | Internal source,<br>External source,<br>Tone on hold, or<br>Silence                                                          |                           | Internal<br>source                           | Music On<br>Hold                    |           |
| Line Key Light (page 4-10)      | Light flashing on hold<br>or<br>Light steady on hold                                                                         | Light flashing<br>on hold |                                              | Flashing Hold<br>LED                |           |
| Change Greetings (page 4-11)    | Auto Attendant Day,<br>Auto Attendant Night,<br>Courtesy Service<br>Day, Courtesy<br>Service Night, and<br>Directory Message | Default<br>messages       | n/a                                          | n/a                                 | n/a       |
| Call Logging (page 4-11)        | Call Logging Off or<br>On For All Phones                                                                                     | Call Logging<br>Off       | System<br>Programming                        | System<br>Settings; Call<br>Logging | page 5-37 |

**Table 4-1: Keyset Programming – System-Wide Programming (Continued)**

| PROGRAMMING OPTION                                                                                                                                                                                                                                                     | ALLOWED VALUES                                                                                                                                                                                                             | DEFAULT VALUE                                                                                                                                             | RMS LOCATION                           | RMS EQUIVALENT                        | PAGE                                                                                    |
|------------------------------------------------------------------------------------------------------------------------------------------------------------------------------------------------------------------------------------------------------------------------|----------------------------------------------------------------------------------------------------------------------------------------------------------------------------------------------------------------------------|-----------------------------------------------------------------------------------------------------------------------------------------------------------|----------------------------------------|---------------------------------------|-----------------------------------------------------------------------------------------|
| Timers: (page 4-12)<br>Recall On Hold<br>Recall On Transfer<br>Forward On No Answer<br>Courtesy Delay<br>Open The Door<br>Doorphone Ring<br>Duration<br>Call Park<br>Ringback Time Duration<br>Auto Attendant Delay<br>Answering Machine<br>Delay<br>VM Message Length | 0001 – 1800 seconds<br>001 – 180 seconds<br>001 – 180 seconds<br>01 – 30 seconds<br>01 – 30 seconds<br>01 – 30 seconds<br>001 – 250 seconds<br>01 – 30 seconds<br>01 – 30 seconds<br>001 – 180 seconds<br>30 – 180 seconds | 90 seconds<br>90 seconds<br>15 seconds<br>30 seconds<br>005 seconds<br>30 seconds<br>180 seconds<br>30 seconds<br>001 second<br>30 seconds<br>120 seconds | System Programming;<br>System Settings | User Timers                           | page 5-39<br><br>(System timers associated with RMS maintenance are shown on page 6-13) |
| Doorphone (page 4-13)                                                                                                                                                                                                                                                  | Doorphone equipped or unequipped                                                                                                                                                                                           | Doorphone unequipped                                                                                                                                      |                                        | Doorphone fitted                      | page 5-37                                                                               |
| PA (Paging) Amplifier (page 4-13)                                                                                                                                                                                                                                      | PA equipped or unequipped                                                                                                                                                                                                  | PA not equipped                                                                                                                                           |                                        | PA Position                           |                                                                                         |
| Caller ID List (page 4-13)                                                                                                                                                                                                                                             | Store all calls or Unanswered calls                                                                                                                                                                                        | Stores unanswered calls                                                                                                                                   |                                        | Store all calls (Caller ID Detection) |                                                                                         |
| Class Codes: (page 4-13)<br>Table 2<br>Table 3<br>Table 5<br>Table 6                                                                                                                                                                                                   |                                                                                                                                                                                                                            | Not programmed                                                                                                                                            | System Programming                     | COS Exceptions & Restrictions         | page 5-40                                                                               |
| Local Codes (page 4-14)                                                                                                                                                                                                                                                | Up to 40 codes                                                                                                                                                                                                             |                                                                                                                                                           | Line Programming                       | Line Settings; Local Codes tab        | page 5-32                                                                               |
| Reset Options (page 4-14)                                                                                                                                                                                                                                              | Reset or Reset to Default                                                                                                                                                                                                  | n/a                                                                                                                                                       | Diagnostics                            | System Reset                          | page 6-9                                                                                |
| Set V24 Baud Rate (page 4-14)                                                                                                                                                                                                                                          | 4800, 9600, 19200                                                                                                                                                                                                          | 19200 baud                                                                                                                                                | System Programming;<br>System Settings | V24 Baud Rate                         | page 5-37                                                                               |
| Sales - Service Numbers (page 4-15)                                                                                                                                                                                                                                    | Any outside telephone number                                                                                                                                                                                               | None programmed                                                                                                                                           |                                        | Sales Telephone Number                |                                                                                         |
| VM Capacity (page 4-15)                                                                                                                                                                                                                                                | 10 – 50                                                                                                                                                                                                                    | 20                                                                                                                                                        |                                        | Message Capacity                      |                                                                                         |
| Group Divert to VM (page 4-15)                                                                                                                                                                                                                                         | Individual or System                                                                                                                                                                                                       | Individual                                                                                                                                                |                                        | Group Divert to System box            |                                                                                         |
| 911 & Extension Sending (page 4-15)                                                                                                                                                                                                                                    | Send or not send extension digits to network                                                                                                                                                                               | System does not send extension digits to the network                                                                                                      |                                        | 911 & Extension Sending               |                                                                                         |

## A. SYSTEM TIME AND DATE

### 4.2 To adjust the system time settings, when necessary:

1. Begin the programming session as described on [page 4-4](#). Then select **System**.
2. Select **Time And Date**.
3. Enter the correct time in 24-hour format, (e.g., 2:00 PM as 1400). The display will prompt for a date.
  - If you only wish to set the time select **Confirm** and the display will revert to the Idle Menu.
  - Enter the date in MMDDYY format, (e.g., December 10, 2001 as 121001). When the date has been entered the display will revert to the Idle Menu.
4. Press the **Speaker** key to finish programming.

---

**NOTE:** Following a system reset, the time shown will be 12:00 and the date shown will be 01-01-99. Also, in the event of a power failure, you will need to reset the time and date.

---

## B. LANGUAGE SETTING FOR KEYSSET DISPLAYS

**4.3** The Keyset displays can be shown in English, Spanish, or French. The default language is English. This procedure sets the system-wide language. However, keyset users can change their keyset displays (see [page 3-14](#) for details).

### 4.4 To change the language setting for keyset displays:

1. Begin the programming session as described on [page 4-4](#). Then select **System**.
2. Select **Language**.
3. Select the language that is to be used on a system-wide basis: **English**, **French** or **Spanish**. The selected option is denoted by a **◆**.
4. Press the **Speaker** key to finish programming. Select Cancel to return to the idle menu.

## C. SYSTEM PROGRAMMING PASSWORD

### 4.5 To change the default System Programming Password (1111) to any four-digit number:

1. Begin the programming session as described on [page 4-4](#). Then select **System**.
2. Select **Change Password**.
3. Select **Change** and enter the new four-digit password.
4. Select **Confirm**.
5. Press the **Speaker** key to finish programming.

## D. PROGRAMMING POSITION

**4.6** System programming can only be carried out at one Keyset (the Programming Extension). By default, Extension 20 is the Programming Extension. The Programming Extension can be changed to any other extension, if required.

### **4.7 To change the programming extension:**

1. Begin the programming session as described on [page 4-4](#). Then select **System**.
2. Select **Programming Position**.
3. Select the extension you wish to have as the Programming Extension. The selected Programming Extension is denoted by a **◆**.
4. Press the **Speaker** key to finish programming.

## E. SYSTEM SPEED-DIAL NUMBERS

**4.8** You can program 200 system speed-dial numbers and names. Users of the system may then access these numbers, provided they are not restricted from dialing the number because of their Class of Service (see [page 3-38](#) for details).

**4.9** Up to 24 digits may be stored in any location. A name of up to ten characters, including spaces, can be used for each entry.

**4.10** For a description of the Class of Service Override facility, see the Call Restrictions section on [page 3-6](#). This feature allows an extension to access all system Speed-Dial numbers, even though the extension may be restricted from directly dialing a number because of their Class of Service.

### **4.11 To program system speed-dial numbers:**

1. Begin the programming session as described on [page 4-4](#). Then select **System**.
2. Scroll down to and select **System Speed Dial**.
3. Select **New Entry**.
4. Enter the index number 001-200 and then enter the telephone number.
5. Select **Confirm**.
6. You are then prompted to enter a name. Do one of the following:
  - Press **Cancel** if you do not wish to enter a name.
  - Enter a name as described on [page 3-13](#).
7. Press the **Speaker** key to finish programming.

## F. NIGHT SERVICE

**4.12** The Automatic Night Service feature allows you to set the times at which the system automatically enters Night Mode and when it reverts to Day Mode. (The operator also has the ability to manually turn on or off Night Mode.)

### Set the On and Off Times

#### 4.13 To set night service on/off times:

1. Begin the programming session as described on [page 4-4](#). Then select **System**.
2. Scroll down to and select **Night Service**.
3. Select **Automatic Service**.
4. Enter the automatic on and off times in 24-hour clock format (e.g. 2:00 PM is entered as 1400).
5. Press the **Speaker** key to finish programming.

### Cancel the Automatic Start and End Times

#### 4.14 To cancel the night service automatic start/end times:

1. Begin the programming session as described on [page 4-4](#). Then select **System**.
2. Scroll down to and select **Night Service**.
3. Select **Automatic Service**.
4. Select **Automatic On Time** to cancel the start time, and **Automatic Off Time** to cancel the end time.

---

**NOTE:** When ♦ is displayed next to Automatic On Time and/or Automatic Off Time, the times have been set.

---

5. Select **Change**.
6. Select **Confirm**.

### Set Weekend Service

**4.15** The Weekend Service feature ensures that if Night Service is invoked on a Friday evening, the system remains in Night Mode until Monday morning.

#### 4.16 To set night service weekend service:

1. Begin the programming session as described on [page 4-4](#). Then select **System**.
2. Scroll down to and select **Night Service**.
3. Select **Weekend Service**.
4. Select **Weekend Service On** or **Weekend Service Off**.

---

**NOTE:** A ♦ is displayed next to Weekend Service On or Weekend Service Off to tell you whether the feature is enabled or disabled.

---

5. Press the **Speaker** key to finish programming.

## G. SET THE MUSIC-ON-HOLD OPTION

**4.17** When an external call is placed on hold, you can choose between supplying music, a tone, or silence to the caller. The music source can be internal (using the music chip that is integrated in the system that cannot be changed) or external (using a radio, CD player, or other device connected to your system). Internal callers will always hear tones when on hold.

---

**NOTE:** In the previous operation of Auto Attendant, (where, if it was not available to answer) the call would be answered by internal courtesy source, as a back-up; this is no longer applicable. If the Courtesy Service is programmed to use the internal source, the music-on-hold option is automatically set to the internal source and cannot be changed to an external source (see [page 4-10](#)). However, if the Courtesy Service is programmed to use the Voice Module, music-on-hold can use the external source.

---

**4.18** While the system is in Day Mode, if both Music-On-Hold and Courtesy Service are programmed, the Courtesy Service message and music will be played in rotation to callers on hold. In Night Mode, the Courtesy Service message and hold tones will be played in rotation.

**4.19 To set the music on hold option:**

1. Begin the programming session as described on [page 4-4](#). Then select **System**.
2. Scroll down to and select **Music On Hold**.
3. Select the option (**Internal Source, External Source, Tone On Hold, or Silence**) that you want. A **◆** indicates the current setting.
4. Press the **Speaker** key to finish programming.

## H. LINE KEY LIGHTS

**4.20** You can decide if the associated Line key light is to flash or remain steady on all other Keypads when a call is placed on hold. The default setting is that the light flashes.

**4.21 To set line key light settings:**

1. Begin the programming session as described on [page 4-4](#). Then select **System**.
2. Scroll down to and select **Line Key Light**.
3. Choose either **Light Flashing On Hold** or **Light Steady On Hold**.
4. Press the **Speaker** key to finish programming.

## I. SYSTEM GREETINGS

**4.22** The system greetings are used in the Courtesy Service and Automated Attendant services as follows:

- If a call rings on a line programmed for Courtesy Service, and it is not answered by an extension within a programmed time (30 seconds by default), the call is automatically answered and a greeting is played. See [page 3-18](#) for more information.
- When the call comes in on a line programmed for Automated Attendant, the call will be answered for the programmed time period (unless the timer is set to one or less than five seconds), then the Automated Attendant answers the call immediately. The caller will hear a pre-recorded greeting or a customized greeting. See [page 3-18](#) for more information.

**NOTE:** In the previous operation of Auto Attendant, (where, if it was not available to answer) the call would be answered by internal courtesy source, as a back-up; this is no longer applicable. If the Courtesy Service is programmed to use the internal source, the music-on-hold option is automatically set to the internal source and cannot be changed to an external source (see [page 4-10](#)). However, if the Courtesy Service is programmed to use the Voice Module, music-on-hold can use the external source.

**4.23** You can also record a Directory Message, that tells callers what to dial when they reach the system directory.

### **4.24 To set system greetings:**

1. Begin the programming session as described on [page 4-4](#). Then select **System**.
2. Select **Change Greetings**.
3. *For Automated Attendant greetings:* Select **Auto Attendant Day** or **Auto Attendant Night**.  
*For Courtesy Service greetings:* Select **Courtesy Service Day** or **Courtesy Service Night**.  
*For the Directory greeting:* Select **Directory Message**.
4. Select **Record Greeting**.
5. When prompted, speak to record the new greeting.
6. Press the **Speaker** key to finish programming.

## J. CALL LOGGING ENABLE/DISABLE

**4.25** If the system is equipped with a Call Logging Interface Module, a printer or PC may be connected to maintain a record of incoming and outgoing calls made on the system. Details are printed as the calls are completed. See [page 3-47](#) for more information.

**4.26** Call Logging can be programmed to ignore calls from certain extensions. To prevent call from being logged, see [page 4-21](#).

**4.27** Call Logging is disabled by default on power up. If a Call Logging Interface Module is installed, you must enable Call Logging.

### **4.28 To enable call logging:**

1. Begin the programming session as described on [page 4-4](#). Then select **System**.
  2. Scroll down to and select **Call Logging**.
  3. Select either **On For All Phones** or **Call Logging Off**.
  4. Press the **Speaker** key to finish programming.
- 4.29** To set the interface speed for call logging, see [page 4-14](#). To prevent call from being logged, see [page 4-21](#).

## K. SYSTEM TIMERS

**4.30** You can set various timers from the Programming Extension to suit your requirements. The following table shows each timer with its purpose, range, and default value.

**4.31** To program these timers using RMS, refer to “User Timers” on page 5-39. (System timers associated with RMS maintenance are shown on page 6-13).

**4.32 To set system timers:**

1. Begin the programming session as described on page 4-4. Then select **System**.
2. Scroll down to and select **Timers**.
3. Select the required timer to be changed and enter the duration. (See table below).
4. Select **Confirm** to accept the new time. The confirm option will not be displayed until valid digits are entered.
5. Press the **Speaker** key to finish programming.

**Table 4-2: Keyset Programming – System Timers**

| TIMER                     | PURPOSE                                                                                                                                                                                                                                                                                                                       | RANGE       | DEFAULT     |
|---------------------------|-------------------------------------------------------------------------------------------------------------------------------------------------------------------------------------------------------------------------------------------------------------------------------------------------------------------------------|-------------|-------------|
| Recall On Hold            | The time that elapses before a call, which has been placed on hold, rings back to the extension that put the call on hold.                                                                                                                                                                                                    | 0001 – 1800 | 90 seconds  |
| Recall On Transfer        | The time that elapses before a call, which has been transferred and not answered, rings back to the extension that attempted the transfer.                                                                                                                                                                                    | 001 – 180   |             |
| Forward On No Answer      | The time that elapses before a call ringing at an extension, with Forward on No Answer set, is forwarded.                                                                                                                                                                                                                     | 001 – 180   | 15 seconds  |
| Courtesy Delay            | The time that elapses before an unanswered incoming call is sent to the Courtesy Service.                                                                                                                                                                                                                                     | 01 – 30     | 30 seconds  |
| Open The Door             | The amount of time that the doorstrike relay will remain open following activation.                                                                                                                                                                                                                                           |             | 005 seconds |
| Doorphone Ring Duration   | The amount of time that extensions will ring when the Doorphone is pressed.                                                                                                                                                                                                                                                   |             | 30 seconds  |
| Call Park                 | The time that elapses before a call, which has been placed on Park, rings back to the extension that parked the call.                                                                                                                                                                                                         | 001 – 250   | 180 seconds |
| Ringback Time Duration    | The amount of time an extension will ring when Ringback has been invoked.                                                                                                                                                                                                                                                     | 01 – 30     | 30 seconds  |
| Auto Attendant Delay      | The time that elapses before Auto-Attendant answers a ringing call.                                                                                                                                                                                                                                                           |             | 001 second  |
| Answer Machine Delay      | The time that elapses before an unanswered incoming call is sent to the Answering Machine.<br><br><b>NOTE:</b> If the Answering Machine timer is less than 5 seconds (0 is not allowed), the group of extensions is rung for 5 seconds, and then the Answering Machine starts (the timer is handled as if it were 5 seconds). | 001 – 180   | 30 seconds  |
| Voice Mail Message Length | The time allowed for voice message and voice greetings. The confirm option only appears after you have entered a valid value.                                                                                                                                                                                                 | 30 – 180    | 120         |



## L. DOORPHONE EQUIPPED/UNEQUIPPED

**4.33** You can equip your Encore System with a Doorphone. The Doorphone has a button which, when pressed, rings at programmed extensions, and has a microphone/speaker for communication. With a Doorphone installed at the door or in your reception area, anyone visiting your premises can call when they arrive and you can speak to them before you let them in. See [page 3-17](#) for more information.

**4.34 To set doorphone equip/unequip:**

1. Begin the programming session as described on [page 4-4](#). Then select **System**.
2. Select **Doorphone**.
3. Select **Doorphone Equipped**.
4. Press the **Speaker** key to finish programming.

## M. EXTERNAL PAGING

**4.35** A extension with a paging equipment amplifier connected to it must be programmed as a page port before it can be used for paging. See [page 3-36](#) for more information.

**4.36 To set external paging:**

1. Begin the programming session as described on [page 4-4](#). Then select **System**.
2. Scroll down to and select **PA amplifier**.
3. Select **PA Equipped**.
4. Select the extension to which paging equipment is connected.
5. Press the **Speaker** key to finish programming.

## N. CALLER ID STORAGE

**4.37** The system Caller ID Storage can capture either all calls or unanswered calls only. See [page 4-20](#) for information programming individual Caller ID Storage. See [page 3-7](#) for more information about Caller ID.

**4.38 To set caller ID storage:**

1. Begin the programming session as described on [page 4-4](#). Then select **System**.
2. Scroll down to and select **Caller ID List**.
3. Select **Store All Calls** or **Store Unanswered Calls**.
4. Press the **Speaker** key to finish programming.

## O. CLASS OF SERVICE ACCESS TABLES

**4.39** As a means of controlling costs, each extension can be programmed for a toll restriction Class of Service. This determines the type of call the extension is allowed to dial. See [page 3-6](#) for more information about the Tables.

**4.40 To set class of service:**

1. Begin the programming session as described on [page 4-4](#). Then select **System**.
2. Scroll down to and select **Class Codes**.
3. Select the **Table** to which you want to assign codes. (Table 2, 3, 5, or 6).
4. Select an **Index Number** and enter the code.
5. Select **Confirm** when the code is entered.
6. Repeat steps as necessary until all tables are programmed.
7. Press the **Speaker** key to finish programming.

## P. LOCAL AREA CODES

**4.41** It is necessary to program the local area codes into the system so that the system can recognize the numbers which must have the digit 1 added when they are redialed. The local area codes do not need to have the 1 added.

### 4.42 So program local area codes:

1. Begin the programming session as described on [page 4-4](#). Then select **System**.
2. Scroll down to and select **Local Codes**.
3. Enter the index number 01-40.
4. Enter the three-digit area code, then select **Confirm**.
5. Select the next index and continue until all local codes are programmed.
6. Press the **Speaker** key to finish programming.

## Q. SYSTEM RESET

### CAUTION

Possible Loss of Data Hazard. There are two system reset options available – **Reset!** resets the system and cuts off all established calls and **Reset To Default!** resets the system, cuts off all established calls *and removes all programming from the system*. These are complete system resets, not individual extension resets. They should be used with extreme care, preferably only as directed by your service consultant.

### 4.43 To reset the system:

1. Begin the programming session as described on [page 4-4](#). Then select **System**.
2. Scroll down to and select **Reset Options**.
3. Select **Reset!** to reset the system and cut off all established calls or **Reset To Default!** to reset the system, cut off all established calls *and remove all programming from the system*.

---

**NOTE:** After resetting the system to default, please wait about 10 seconds before entering System Programming to configure Extension Voice Boxes.

---

## R. V24 BAUD RATE

**4.44** The interface to the printer or PC should be serial V24/RS232-C and should meet the following specifications: 4800, 9600 or 19200 bps speed, 8 data bits, no parity.

### 4.45 To set V24 baud rate:

1. Begin the programming session as described on [page 4-4](#). Then select **System**.
2. Scroll down to and select **Set V24 Baud Rate**.
3. Select which speed you require: **4800**, **9600**, or **19200**.
4. Press the **Speaker** key to finish programming.

## S. SALES AND SERVICE NUMBERS

**4.46** If desired, you can program the telephone numbers for your Sales and/or Service personnel so that customers can easily call them.

**4.47 To program sales and service numbers:**

1. Begin the programming session as described on [page 4-4](#). Then select **System**.
2. Scroll down to and select **Sales - Service Numbers**.
3. Select **System Sales** or **System Service**.
4. Enter the telephone number, then press **Confirm**.

## T. VOICE MAIL (VM) CAPACITY

**4.48** This feature allows you to change the voice mail capacity, from the default of 20 messages, to a higher or lower amount, depending on demand.

**4.49 To program the VM capacity limit:**

1. Begin the programming session as described on [page 4-4](#). Then select **System**.
2. Scroll down and select **VM Capacity**.
3. Enter a value between 10 and 50. The default is 20.

## U. GROUP DIVERT TO VM

**4.50** This feature allows you to enable a divert incoming voice mail to the system mail box. This feature is available for incoming calls to groups with more than one extension (when a forward on no answer to the voice module is enabled on any of the phones in the group). The call is diverted to the system mail box instead of the individual's mail box. This is a system-wide flag.

**4.51 To program the group divert to VM:**

1. Begin the programming session as described on [page 4-4](#). Then select **System**.
2. Near the end of the list, select **Group Divert to VM**.
3. Select one of the following options:
  - Send to System VM
  - Send to Individual VM (default)

## V. 911 & EXTENSION SENDING

**4.52** This feature sends the extension number (that dialled 911) to the network.

**4.53 To program 911 sending:**

1. Begin the programming session as described on [page 4-4](#). Then select **System**.
2. Near the end of the list, select **911 & Extension Number**.
3. Select the 911 and Extension sending option. For example, when this symbol ◆ is displayed, the System sends the extension digits to the network. If the symbol ◇ is displayed, the System *will not* send the digits to the network (default setting).

## 5. EXTENSION PROGRAMMING

5.1 If **Extensions** is selected, the extension programming options appear. The following table lists the available Extensions options, with their allowed values and defaults, if applicable.

**Table 4-3:** *Keyset Programming – Extension Programming*

| PROGRAMMING OPTION                  | ALLOWED VALUES                | DEFAULT VALUE                   | RMS LOCATION                                    | RMS EQUIVALENT                      | PAGE      |
|-------------------------------------|-------------------------------|---------------------------------|-------------------------------------------------|-------------------------------------|-----------|
| Name Programming (page 4-18)        | Up To 10 Characters           | None programmed                 | Extension/Phone Programming                     | Call Handling/ Extension Names      | page 5-17 |
| Restriction Classes (page 4-18)     | Day/Night Class Of Service    | All extensions in Class 1       |                                                 | Classes of Service/Pickup Groups    | page 5-18 |
| Tone Protect (page 4-18)            | On or Off                     | Extensions do not accept tone   | Extension/Phone Programming; Extension Settings | Protected from Tones                | page 5-19 |
| Page Protection (page 4-19)         |                               | Extensions accept paging        |                                                 | Protected from Paging               |           |
| General Call Protection (page 4-19) |                               | Extensions accept General calls |                                                 | Protected from general calls        |           |
| Open Door Restriction (page 4-19)   |                               | All extensions enabled          |                                                 | Door Restrict                       |           |
| Pickup Groups (page 4-20)           | Pickup Group 1, 2, 3, or 4    | All extensions in group 1       | Extension/Phone Programming                     | Classes of Service/Pickup Groups    | page 5-18 |
| Personal Caller ID List (page 4-20) | Up to 12 extensions           | No lists programmed             | Extension/Phone Programming; Extension Settings | Personal Caller ID List             | page 5-19 |
| Sys. Spd. Dial Override (page 4-20) | On or Off                     | No override programmed          |                                                 | COS overridden by System Speed Dial |           |
| Voice Boxes (page 4-21)             | One message box per extension | None programmed                 |                                                 | Voice Messaging                     |           |
| Extension Disconnect (page 4-21)    | Connected or Disconnected     | All extensions connected        |                                                 | Extension Disconnected              |           |
| No Call Logging (page 4-21)         | On or Off                     | Not programmed                  |                                                 | No Call Logging                     |           |
| No Trunk-to-Trunk Calls (page 4-22) |                               |                                 |                                                 | No Trunk to Trunk                   |           |
| Examine Passwords (page 4-22)       | Voice Messaging               | Default 123                     |                                                 | Voice Mail Password                 |           |
|                                     | Answering Machine             | Default 1111                    |                                                 | n/a                                 |           |
|                                     | Extension Lock                | Default 1111                    | Extension Lock Code                             |                                     |           |
| Restrict Use of PA (page 4-22)      | On or Off                     | All extensions On               | Restrict use of PA                              |                                     |           |

**Table 4-3:** *Keyset Programming – Extension Programming (Continued)*

| PROGRAMMING OPTION               | ALLOWED VALUES                                            | DEFAULT VALUE  | RMS LOCATION                                                      | RMS EQUIVALENT                      | PAGE      |
|----------------------------------|-----------------------------------------------------------|----------------|-------------------------------------------------------------------|-------------------------------------|-----------|
| Port Swapping<br>(page 4-22)     | Move any extension to an available extension interface    | Not programmed | Extension/Phone Programming                                       | Extension Port Swapping             | page 5-22 |
| Hot Line (page 4-23)             | On or Off                                                 |                | Extension/Phone Programming;<br>Call Handling/<br>Extension Names | Hot Line                            | page 5-17 |
| Manager/Secretary<br>(page 4-23) | Create Secretary extensions and assign Manager extensions |                |                                                                   | Secretary                           |           |
| Keypad Feedback<br>(page 4-23)   | Provides a feedback keypad that is ON by default.         | ON             | Extension/Phone Programming                                       | Extension Settings; Keypad Feedback | page 5-19 |

## A. EXTENSION USER NAMES

**5.2** The system has capacity for up to 18 extensions. Extensions can be equipped with Encore Keysets or industry-standard single-line sets. Extension 23 can be connected to a Doorphone, if desired. Extension 20 is the Operator's extension and, at default, is the Programming Extension.

**5.3** You may assign names to extensions. When an extension receives an internal call, its display will show the calling extension name in the place of the extension number.

1. Begin the programming session as described on [page 4-4](#). Then select **Extensions**.
2. Select **Name Programming**.
3. From the Extension Menu, select the extension you want to name.
4. Enter the name. Up to ten characters (including spaces) can be entered for each name.
5. Select **Confirm**.
6. You will see the Extension Menu again and can continue programming other names.
7. Press the **Speaker** key to finish programming.

## B. CLASSES OF SERVICE

**5.4** With this feature, you can assign the extensions to a Class of Service that will be in effect when the system is in Day and/or Night Mode. By default, all extensions are in Class 1 for both day and night. See [page 3-6](#) for more information about Classes of Service.

1. Begin the programming session as described on [page 4-4](#). Then select **Extensions**.
2. Select **Restriction Classes**.
3. Select **Day Class of Service** or **Night Class of Service**.
4. Select the **Class** you want to assign to the extensions, (Class 1 – Class 6).
5. Select the extensions to be entered in this Class.
6. Press the **Speaker** key to finish programming.

## C. CALL WAITING TONES

**5.5** Extensions may send busy extension a call waiting tone, provided the busy extension is not protected against receiving call waiting tones. Any user may program his or her extension to block call waiting tones during a call. See [page 3-31](#) for more information about Call Waiting.

1. Begin the programming session as described on [page 4-4](#). Then select **Extensions**.
2. Scroll down to and select **Tone Protect**.
3. Select the extensions you wish to allow to receive Call Waiting tones. A  $\diamond$  is displayed beside those extensions allowed to receive Call Waiting tones, and a  $\blacklozenge$  is displayed beside those extensions protected against receiving Call Waiting tones. (By default, all extensions will have a  $\blacklozenge$  displayed.)
4. Press the **Speaker** key to finish programming.

## D. PAGING AND INTERCOM CALLS

**5.6** By default, all Keysets may be paged and they can receive paging intercom calls. You can protect each Keyset to prevent it from receiving pages or intercom calls. For more information, see [page 3-36](#).

1. Begin the programming session as described on [page 4-4](#). Then select **Extensions**.
2. Select **Page Protection**.
3. Select the extensions you wish to protect. A ◆ will be displayed beside protected extensions.
4. Press the **Speaker** key to finish programming.

## E. GENERAL CALLS

**5.7** The General Call feature allows you ring all extensions connected to the Encore System. The first extension to answer is connected, and the call continues as a normal call. By default, all extensions can receive General Calls. You can protect each extension to prevent it from receiving General Calls.

1. Begin the programming session as described on [page 4-4](#). Then select **Extensions**.
2. Scroll down to and select **General Call Protection**.
3. Select those extensions that are to be protected from a General Call. The extensions that are protected will have a ◆ displayed beside them.
4. Press the **Speaker** key to finish programming.

## F. DOORSTRIKE

**5.8** The Encore System has a doorstrike relay output that can be used to operate a strike-plate mechanism to allow users open the door from their extensions. See [page 3-17](#) for the procedure to open the door.

**5.9** The doorstrike will remain open until the Open the Door timer expires (defaults to 5 seconds). See [page 4-12](#) for timer programming.

**5.10** Use the following procedure to determine which extensions will be restricted from opening the Doorstrike. By default, all extensions can open the door.

1. Begin the programming session as described on [page 4-4](#). Then select **Extensions**.
2. Scroll down to and select **Open Door Restriction**.
3. Select which extensions are restricted from opening the door. The extensions restricted from operating the Doorstrike will be indicated with a ◆.
4. Press the **Speaker** key to finish programming.

## G. PICK-UP GROUPS

**5.11** Extensions can be programmed to be in Pick-Up Groups. Group members can pick up any call (internal or external), that is ringing at another extension in the same group. For extensions not in your Pick-Up Group, you can pick up external, but not internal, calls. You can also pick up an external call that is ringing on a Central Bell.

**5.12** You can program up to four Pick-Up Groups. A extension can be placed into only one Pick-Up Group at a time.

1. Begin the programming session as described on [page 4-4](#). Then select **Extensions**.
2. Scroll down to and select **Pick-Up Groups**.
3. Select the Pick-Up Group you wish to program.
4. Select the extensions you want to place in the group. The extensions assigned to the group will have a **◆** displayed beside them.
5. Press the **Speaker** key to finish programming.

## H. CALLER ID STORAGE ALLOCATIONS

**5.13** You can allow up to 12 extensions to store five Caller ID numbers each. Each of these extensions will have a separate record of calls that ring on any CO lines that are programmed to ring at their extensions only. All leftover Caller ID storage locations will be allocated to the system-wide Central Storage. See [page 3-8](#) for more information on Caller ID Storage.

1. Begin the programming session as described on [page 4-4](#). Then select **Extensions**.
2. Scroll down to and select **Personal Caller ID List**.
3. Select the extensions that you wish to have individual lists of missed calls. The extensions that will have a Personal Caller ID List will have a **◆** displayed beside them.
4. Press the **Speaker** key to finish programming.

## I. SYSTEM SPEED-DIAL NUMBERS OVERRIDE TOLL RESTRICTION

**5.14** You may wish to allow extensions to override their toll restriction Class of Service when they dial system speed-dial numbers. By default, this feature is not activated on any extension.

1. Begin the programming session as described on [page 4-4](#). Then select **Extensions**.
2. Scroll down to and select **Sys. Speed No. Override**.
3. Select the extensions on which you wish to activate the feature. Those extensions allowed to override their Class of Service are indicated by a **◆**.
4. Press the **Speaker** key to finish programming.

---

**NOTE:** Numbers on an extension's personal speed-dial list cannot override the Class of Service restriction of the extension.

---



## J. VOICE MESSAGE BOX ASSIGNMENTS

**5.15** A Voice Messaging Module can be installed in the Encore KSU to provide Automated Attendant service, Answering Machine service, and customized Courtesy Service greetings, in addition to Voice Messaging. Each extension can be assigned a voice message box. Each voice message box can store up to 50 messages (20 is the default). See [page 3-19](#) for more information.

1. Begin the programming session as described on [page 4-4](#). Then select **Extensions**.
2. Scroll down to and select **Voice Boxes**.
3. Enter the extensions to be allocated a voice message box. Those extensions allocated a box will be indicated by a **◆**.
4. Press the **Speaker** key to finish programming.

## K. DISCONNECTED EXTENSIONS

**5.16** The system assumes that all available extension interfaces have devices connected to them. If an extension interface does not have a device connected, ensure correct system operation by disconnecting the extension interface in system programming, as follows.

1. Begin the programming session as described on [page 4-4](#). Then select **Extensions**.
2. Scroll down to and select **Extension Disconnect**.
3. Select the extensions you wish to connect or disconnect. Disconnected extensions are denoted by a **◆**.
4. Press the **Speaker** key to finish programming.

---

**NOTE:** When a Keyset is connected to an extension interface that is programmed as disconnected, the Keyset's display may appear as if the Keyset is connected. However, when the handset is lifted a busy tone is heard and no options will be displayed.

---

## L. NO CALL LOGGING

**5.17** If the system is equipped with a Call Logging Module, a printer or PC may be connected, which will maintain a record of incoming and outgoing calls made on the system. Details are printed as the calls are completed. See [page 3-47](#) for more information.

**5.18** If Call Logging is enabled (see [page 4-11](#)), by default all calls from all extensions will be logged. However individual extensions can be programmed to prevent their calls being logged.

1. Begin the programming session as described on [page 4-4](#). Then select **Extensions**.
2. Scroll down to and select **No Call Logging**.
3. Select the extensions whose calls are not to be logged. The selected extensions will be indicated with a **◆**.
4. Press the **Speaker** key to finish programming.

## M. NO TRUNK-TO-TRUNK CALLS

**5.19** You may prevent individual extensions from setting up calls using External Forward, External Transfer, and External Conference.

1. Begin the programming session as described on [page 4-4](#). Then select **Extensions**.
2. Scroll down to and select **No Trunk-To-Trunk Calls**.
3. Select the extensions to be denied this feature. Those extensions denied the feature are indicated by a **◆**.
4. Press the **Speaker** key to finish programming.

## N. EXTENSION AND SYSTEM PASSWORDS

**5.20** You can view an extension's Extension Lock or Voice Messaging password, or the system Answering Machine password.

1. Begin the programming session as described on [page 4-4](#). Then select **Extensions**.
2. Scroll down to and select **Examine Passwords**.
3. Select **Extension Lock Password**, **Voice Messaging Password**, or **Answering Machine**.
  - If you selected **Extension Lock Password**, the Extension Menu appears. Select an extension and its Extension Lock password will appear on the display.
  - If you selected **Voice Messaging Password**, the Extension Menu appears. Select an extension and its Voice Messaging password will appear on the display.
  - If you selected **Answering Machine**, the Answering Machine Password appears on the display.
4. Press the **Speaker** key to finish programming.

## O. RESTRICT USE OF PAGING EQUIPMENT

**5.21** External paging equipment (a paging amplifier and speaker) can be connected to any extension connection in the system. Users can then make announcements over the external paging equipment. See [page 2-30](#) for information on enabling the paging equipment.

1. Begin the programming session as described on [page 4-4](#). Then select **Extensions**.
2. Scroll down to and select **Restrict Use Of PA**.
3. Select the extensions you wish to prevent from using the PA system. A **◆** is displayed beside the extensions that are restricted.
4. Press the **Speaker** key to finish programming.

## P. PORT SWAPPING

**5.22** If an extension interface becomes faulty, you can swap its extension programming to a vacant extension. Calls for the faulty extension will be routed to the new extension.

1. Begin the programming session as described on [page 4-4](#). Then select **Extensions**.
2. Scroll down to and select **Port Swapping**.
3. Select the faulty extension from the extension list.
4. Select the new extension from the extension list.
5. Press the **Speaker** key to finish programming.

## Q. HOT LINE EXTENSION

**5.23** When an extension is programmed as a Hot Line, as soon as you go off-hook the pre-set number is dialed. No other features can be used at a Hot Line extension. A common application for the Hot Line feature is for a fax or modem. The extension can be set to automatically seize a line so the fax or modem does not have to dial 9.

1. Begin the programming session as described on [page 4-4](#). Then select **Extensions**.
2. Scroll down to and select **Hot Line**.
3. Select the extension from the Extension Menu.
4. Enter the number to be dialed. If you wish to dial an external number, enter 9, or another line access code, before the external telephone number.
5. Press the **Speaker** key to finish programming.

## R. MANAGER/SECRETARY COMBINATIONS

**5.24** The Manager/Secretary feature is a set of programming options used to maximize the efficiency with which two people work together. It is typically used for a manager/secretary partnership. See [page 3-43](#) for more information.

**5.25** To activate the Manager/Secretary feature, it is necessary to first combine the Manager and Secretary Extensions. When the Manager/Secretary combinations are programmed, the Secretary may then answer calls ringing on the Manager's Extension by pressing a key that is programmed with the manager's number.

1. Begin the programming session as described on [page 4-4](#). Then select **Extensions**.
2. Scroll down to and select **Manager/Secretary**.
3. Select the **Secretary Extension**. When selected, the menu changes to allow you to select the Manager Extension(s).
4. Select the **Manager Extension(s)**. Manager Extensions will be indicated by a **◆**. (If the extension has been combined previously with the Secretary, it will be indicated with a **◆**. Selecting an extension with a **◆** will remove that extension as a Manager of that Secretary.)
5. Press the **Speaker** key to finish programming.

## S. KEYPAD FEEDBACK

**5.26** Keypad Feedback provides a feedback keypad that is ON by default. Follow the procedure below to turn OFF this feature.

1. Begin the programming session as described on [page 4-4](#). Then select **Extensions**.
2. Scroll down to the bottom of the list and select **Key Confirmation**.

Key Confirmation is ON by default, indicated by a filled diamond **◆** next to each extension.

3. To turn OFF the feedback keypad, select the desired extension. An empty diamond symbol **◇** appears.
4. Press the **Speaker** key to finish programming.

---

**NOTE:** Once the DTMF tones are established (either by connection or inter-digit time out), the Key Confirmation tone should be turned OFF automatically.

---

## 6. LINE PROGRAMMING

**6.1** If **Lines** is selected, the CO line programming options appear. The following table lists the available Lines options, with their allowed values and defaults, if applicable.

**Table 4-4:** *Keyset Programming – Line Programming*

| FEATURE              |             | ALLOWED VALUES                                                                                  | DEFAULT VALUE                | RMS LOCATION                    | RMS EQUIVALENT                     | PAGE      |             |           |
|----------------------|-------------|-------------------------------------------------------------------------------------------------|------------------------------|---------------------------------|------------------------------------|-----------|-------------|-----------|
| Day Ringing Phones   | (page 4-25) | 20-37                                                                                           | 20-25 Programmed             | Line Programming                | Incoming Ringing Groups            | page 5-28 |             |           |
| Night Ringing Phones |             |                                                                                                 |                              |                                 |                                    |           |             |           |
| Day Central Bell     | (page 4-25) | On or Off                                                                                       | Not Programmed               |                                 |                                    |           |             |           |
| Night Central Bell   |             |                                                                                                 |                              |                                 |                                    |           |             |           |
| Outgoing Restriction | (page 4-25) | Restrict extensions from outgoing calls                                                         | No Restrictions              |                                 | Line Settings; Global tab          | page 5-31 |             |           |
| Equipped Lines       | (page 4-26) | 1-8                                                                                             | All Lines Equipped           |                                 |                                    |           |             |           |
| Incoming Calls Only  | (page 4-26) | On or Off                                                                                       | No Restrictions              |                                 |                                    |           |             |           |
| Outgoing Groups      | (page 4-26) | Outgoing Group 1 (9)<br>Outgoing Group 2 (81)<br>Outgoing Group 3 (82)<br>Outgoing Group 4 (83) | All Lines In Group 1         |                                 |                                    |           |             |           |
| PBX Lines            | (page 4-27) | PBX Status<br>Access Digits<br>Extension Number Length                                          | Not Programmed               |                                 |                                    |           | PBX Access  | page 5-30 |
| Hunt Groups          | (page 4-27) | Assign extensions and lines to up to four hunt groups                                           | No Hunt Groups               |                                 |                                    |           | Hunt Groups | page 5-33 |
| Answering Machine    | (page 4-28) | Enabled or Disabled                                                                             | Not Programmed               | Line Programming; Line Settings | Link to Answering Machine          | page 5-31 |             |           |
| Courtesy Service     | (page 4-28) | Voice Module or Internal Source                                                                 |                              |                                 | Courtesy Service Day/Night         |           |             |           |
| Program Caller ID No | (page 4-29) | Associate numbers with names and/or assign ring-in                                              |                              | System Programming              | Program Caller ID Detection Number | page 5-41 |             |           |
| Alternative Routing  | (page 4-29) | On or Off                                                                                       | Alternative Routing Off      | Line Programming                | Alternative Routing                | page 5-34 |             |           |
| Automated Attendant  | (page 4-30) | Day or Night Enabled/Disabled                                                                   | Not Enabled                  | Line Programming; Line Settings | Auto Attendant Day/Night           | page 5-31 |             |           |
| PSTN Programming     | (page 4-31) | Loop Calling<br>Caller ID Detection<br>Tone Dialing                                             | None<br>None<br>Tone Dialing |                                 | Optional tab                       |           |             |           |

## A. DAY/NIGHT RINGING FOR INCOMING CALLS

**6.2** Any or all extensions can be programmed to receive ringing for incoming calls. By default, all CO lines will ring at extensions 20 to 25. Each line can be programmed to ring up to 18 extensions and a Central Bell. Each line may also be programmed to ring different extensions for Day and Night Modes.

1. Begin the programming session as described on [page 4-4](#). Then select **Lines**.
2. Select **Day Ringing Phones** or **Night Ringing Phones** to configure the system for day and night operation respectively.
3. Select the first line you want to program.
4. Select the extensions that are to ring for calls on that line. Extensions that will ring are indicated with a **◆**. When you have selected the extensions, scroll to the end of the extension list and press **Cancel** or press the Scroll Up Key (**▲**) for two seconds.
  - If the system is equipped with a Doorphone, you may select **Doorphone** and then select the extensions that the Doorphone will ring.
  - If the system is equipped with a fax machine, select the extension with the fax machine. Ensure that the extension with the fax machine is the only extension with a **◆** displayed.
5. Select the next line and repeat the programming until all the lines are programmed.
6. Press the **Speaker** key to finish programming.

## B. DAY/NIGHT CENTRAL BELL RINGING

**6.3** Any or all lines can be programmed to ring at the Central Bell in Day and/or Night Modes.

1. Begin the programming session as described on [page 4-4](#). Then select **Lines**.
2. Select **Day Central Bell** or **Night Central Bell** to configure the Central Bell for day and night operation respectively.
3. Select the lines you wish to ring the Central Bell. The lines that will ring the Central Bell are indicated with a **◆**. If the system is equipped with a Doorphone, you may also select **Doorphone** from this menu. The Doorphone will then ring the Central Bell.
4. Press the **Speaker** key to finish programming.

## C. OUTGOING LINE RESTRICTION

**6.4** When programming the system, you can decide which lines each extension can use for outgoing calls. By default, all extensions have access to all lines. As a means of restricting outgoing calls, extensions can be prevented from having access to one or more CO lines for placing calls. Users attempting to place a call using a restricted CO line hear a busy signal.

1. Begin the programming session as described on [page 4-4](#). Then select **Lines**.
2. Scroll down to and select **Outgoing Restriction**.
3. Select the line you wish to restrict.
4. Select the extensions to be prevented from accessing that line. A **◆** is displayed next to those extensions that are restricted from accessing the line.
5. Press the **Speaker** key to finish programming.

## D. EQUIPPED/UNEQUIPPED LINES

**6.5** The system assumes that all available line interfaces have CO lines connected to them. If a line interface does not have a line connected, ensure correct system operation by unequipping the line interface in system programming, as follows:

1. Begin the programming session as described on [page 4-4](#). Then select **Lines**.
2. Scroll down to and select **Equipped Lines**.
3. Select the lines you wish to equip or unequip. Equipped lines are denoted by a **◆**. Unequipped lines are denoted by a **◇**.
4. Press the **Speaker** key to finish programming.

## E. INCOMING-ONLY LINES

**6.6** Lines can also be designated as “incoming-only” lines to prevent them from being used for outgoing calls.

1. Begin the programming session as described on [page 4-4](#). Then select **Lines**.
2. Scroll down to and select **Incoming Calls Only**.
3. Select the lines that are to be used for incoming calls only. Lines programmed for incoming calls only will be indicated by a **◆**.
4. Press the **Speaker** key to finish programming.

## F. OUTGOING LINE GROUPS

**6.7** CO lines can be grouped together into up to four Outgoing Line Groups. Each Group is associated with a code. These codes are 9, 81, 82, and 83, with Group 1 being associated with 9, etc. Dialing a code seizes a line from the associated Group.

1. Begin the programming session as described on [page 4-4](#). Then select **Lines**.
2. Scroll down to and select **Outgoing Groups**.
3. Select the Group you wish to set up.
4. Select the lines to be in the Group. The lines in the Group are indicated by a **◆**.
5. Press the **Speaker** key to finish programming.

**6.8** Lines can be in one Outgoing Line Group only. Selecting a line to be a member of a Group automatically removes it from all other Groups.

---

**NOTE:** When a user dials a speed-dial number, the system checks the Outgoing Line Groups for an available line. It begins checking with Group 1 and, if no lines are available, checks the rest of the groups in numerical order. To avoid having a speed-dial number dialed on a special-purpose line (FX, PBX, etc.), make sure those lines are in the highest numbered group.

---

## G. PBX ACCESS

**6.9** You can connect the Encore System to a parent PBX via its line interfaces. You can then program any of the four Line Groups to work with a parent PBX. When programming the Line Groups as PBX groups, you must tell the system what digits are required to select a line in the parent PBX. The system will then “absorb” those digits when a call is placed and will not consider them part of the number when applying toll restrictions. (You can have a maximum of two PBX access digits). You must also tell the system how many digits are in the extension numbers on the PBX. See [page 3-9](#) for more information about PBX operation.

1. Begin the programming session as described on [page 4-4](#). Then select **Lines**.
2. Scroll down to and select **PBX Group**.
3. Select which **Outgoing Group** you wish to use.
4. You are presented with another menu to program the parent PBX Access digits.
  - Select **Set/Clear PBX Status** to set or clear the selected Outgoing Group as a PBX Group. A confirmation prompt appear momentarily on the top line of the display.
  - Select **Access Digits**. Enter the Access Digits for an external line on the parent PBX and select **Confirm**.
  - Select **Ext. Num. Length**. Enter the number of digits in the extension numbers on the parent PBX.
5. Press the **Speaker** key to finish programming.

---

**NOTE:** When a user dials a speed-dial number, the system checks the Outgoing Line Groups for an available line. It begins checking with Group 1 and, if no lines are available, checks the rest of the groups in numerical order. To avoid having a speed-dial number dialed on a special-purpose line (FX, PBX, etc.), make sure those lines are in the highest numbered group.

---

## H. HUNT GROUPS

**6.10** The Hunt Group feature allows you to have groups of extensions answering different lines. The calls to the Hunt Group are presented in cyclical order to the extensions in the group. That is, the first call starts the first extension in the Hunt Group, the next call goes to the second extension, and so on. See [page 3-46](#) for more information about Hunt Groups.

1. Begin the programming session as described on [page 4-4](#). Then select **Lines**.
2. Scroll down to and select **Hunt Groups**.
3. Select the **Hunt Group** you wish to set up. (Up to four Hunt Groups can be set up. To select Hunt Group 4, scroll down to display it.)
4. Select the extensions to be in the group. When completed, scroll down to and select **Cancel** to quit the Extension Menu.
5. Select the lines that are to be used with the Hunt Group.
6. Press the **Speaker** key to finish programming.

---

**NOTE:** The lines and extensions programmed in a Hunt Group are exclusive to that Hunt Group and cannot be placed in another Group. Calls can be transferred to an individual extension in a Hunt Group from an extension outside the Hunt Group, but not to the Hunt Group as a whole.

---

## I. ANSWERING MACHINE LINES

**6.11** This service acts as an answering machine. It can be used for answering incoming calls and record messages for selected lines. You can also select how long a call rings before the Answering Machine answers. See [page 3-20](#) for more information.

1. Begin the programming session as described on [page 4-4](#). Then select **Lines**.
2. Scroll down to and select **Answering Machine**.
3. Select the lines to be answered by the Answering Machine. The lines that will be answered are indicated by a **◆**.
4. Press the **Speaker** key to finish programming.

## J. COURTESY GREETING SOURCE AND LINES

**6.12** The Courtesy Service is used in systems where there may be delays in answering calls, and the customer wants to ensure that callers do not hang up before someone answers their call. If the call is not answered within three minutes, it is connected to the system message box. This allows a caller to leave a voice message (if the Voice Module is installed).

**6.13** If the system is equipped with a Voice Module, you can customize the greeting. When the Courtesy Service is programmed, you can select the system-provided standard greetings or the custom Voice Messaging Module greeting (if you have one). See [page 3-18](#) for more information.

1. Begin the programming session as described on [page 4-4](#). Then select **Lines**.
2. Scroll down to and select **Courtesy Service**.
3. Select the source for the message:
  - **Internal Source:** This is the default setting.
  - **Voice Module Source:** This option is only available when a Voice Messaging Module is installed. Customized Courtesy Service may only be set up if the Auto-attendant feature has not already been invoked.
4. Select **Courtesy Service Day** or **Courtesy Service Night**.
5. Select the lines that are to be answered by the Courtesy Service. The lines that are programmed to be answered are indicated by a **◆**.
6. Press the **Speaker** key to finish programming.

---

**NOTE:** In the previous operation of Auto Attendant, (where, if it was not available to answer) the call would be answered by internal courtesy source, as a back-up; this is no longer applicable. If the Courtesy Service is programmed to use the internal source, the music-on-hold option is automatically set to the internal source and cannot be changed to an external source (see [page 4-10](#)). However, if the Courtesy Service is programmed to use the Voice Module, music-on-hold can use the external source.

---



## K. CALLER ID NAMES AND ROUTING

**6.14** Up to thirty names, each with a maximum of ten characters (including spaces), may be associated with telephone numbers. When a number with an associated name is received, the name rather than the number is displayed. See [page 3-7](#) for more information about Caller ID.

**6.15** In addition, an extension number may also be associated with a telephone number. In this case an incoming call from that number will ring at only that extension. If the extension is busy and has Call Waiting Tones turned off, the call rings the incoming ringing group programmed for that line.

---

**NOTE:** The system will display the Caller ID in a number-only format even if:

- The system receives the names or names and numbers sent by the network.

The system will display the name if:

- The system has names associated to the Caller ID programming.
- The system has names associated to the speed dial programming.

- 
1. Begin the programming session as described on [page 4-4](#). Then select **Lines**.
  2. Scroll down to and select **Program CID No.**
  3. Select an index number (01 - 30).
  4. Enter the telephone number.
  5. Press **Confirm**.
  6. If you wish to route calls from that number to an extension, select **Program CID Ext.** and select an extension.
  7. Select **Program CID Name** and enter the name to be associated with the number. Refer to [page 3-13](#) for help on how to enter names.
  8. Press the **Speaker** key to finish programming.

## L. ALTERNATE ROUTING

**6.16** You may use this feature to have calls routed over specific lines (such as specialized common carriers or equal access lines), using special digits, if necessary. You can create up to 50 special Alternative Call Routing numbers. See [page 3-9](#) for more information.

1. Begin the programming session as described on [page 4-4](#). Then select **Lines**.
2. Scroll down to and select **Alternative Routing On**.
3. Enter in a code index (01-50).
4. Enter an input code. (This is the digit string dialed by the user that triggers Alternative Routing.)
5. Select **Confirm**.
6. Enter in an output code, if required. (This is the code that will be inserted before the telephone number that the user dials. This code can be used to select a specific Network Provider.)
7. Select **Confirm**.
8. Select the desired option:
  - **Exclusive:** Calls can only be sent on the lines selected below.
  - **Preferred:** Calls will be routed on any available line, if none of the selected lines are available. In this case the output code is not dialed.
9. Select the lines over which calls will be routed.
10. Press the **Speaker** key to finish programming.

## M. AUTOMATED ATTENDANT

**6.17** The Automated Attendant feature allows calls to ring directly through to an extension provided that they know the extension number of the person they wish to contact. A Voice Messaging Module must be installed for this feature to operate.

**6.18** You can program individual lines to be answered with the Automated Attendant. You can also program different lines for the feature for Day and Night Service. Automated Attendant may only be set up if Customized Courtesy Service has not already been enabled.

**6.19** To change the auto-attendant timer, refer to [page 4-12](#) (using a keypad), or refer to [page 5-40](#) (using RMS).

---

**NOTE:** In the previous operation of Auto Attendant, (where, if it was not available to answer) the call would be answered by internal courtesy source, as a back-up; this is no longer applicable. If the Courtesy Service is programmed to use the internal source, the music-on-hold option is automatically set to the internal source and cannot be changed to an external source (see [page 4-10](#)). However, if the Courtesy Service is programmed to use the Voice Module, music-on-hold can use the external source.

---

1. Begin the programming session as described on [page 4-4](#). Then select **Lines**.
2. Scroll down to and select **Auto Attendant**.
3. Select **Confirm** when prompted.
4. Select **Auto-Attendant Day** or **Auto-Attendant Night**.
5. Select the lines that are to have the Auto Attendant service. The lines programmed for this service will be indicated with a **◆**.
6. Press the **Speaker** key to finish programming.

## N. CO LINE CONFIGURATION

**6.20** There are various options to configure the CO line interfaces on your system. It is recommended that these settings should only be altered from the original settings if there has been a change in the CO line connection.

### Loop Calling

**6.21** All lines are programmed by default to use standard Loop Start signaling. When a line is seized the telephone system expects to hear dial tone and if it does not the line is disconnected. You can program CO lines to use Loop Calling if required.

### Caller ID Detection

**6.22** Caller ID service is available from your telephone company. If you subscribe to this service, your network sends the telephone number, or telephone number and name, of outside callers (providing the caller has not blocked the number). You have the choice of displaying, or not displaying, this information on Keyset displays. (See [page 3-7](#) for more information Caller ID.) At default, the system is not programmed to receive Caller ID information.

### DTMF Tone Dialing

**6.23** The system can be installed with either DTMF or dial-pulse lines. Dial-pulse lines must be designated as such in database programming, because all lines are designated as DTMF Tone Dialing lines when the system is initialized.

### Configuring the Lines

1. Begin the programming session as described on [page 4-4](#). Then select **Lines**.
2. Scroll down to and select **PSTN Programming**.
3. Select the desired option:
  - Select **Loop Calling**: A menu showing the CO lines appears. The lines using Loop Calling are indicated by a **◆**. Those using the standard signaling are indicated by a **◇**. Select the lines as required.
  - Select **Caller ID Detection**: Select the lines that have the Caller ID service enabled. The lines you select will have a **◆** displayed beside them.
  - Select **Tone Dialing**: A menu showing the CO lines appears. The lines using Tone Dialing signal are indicated by a **◆**. Those using Pulse dialing are indicated by a **◇**. Select the lines to use Tone or Pulse dialing as required.
4. Press the **Speaker** key to finish programming.

## 7. SYSTEM PROGRAM PLANNING SHEETS

**7.1** Planning sheets are also provided at the end of the RMS Programming chapter, beginning on page 5-44.

### System-Wide Features

| PROGRAMMING OPTION                     | ALLOWED VALUES                                             | PROGRAMMED VALUE |
|----------------------------------------|------------------------------------------------------------|------------------|
| Weekend Service                        | On or Off                                                  |                  |
| Flashing Hold LED                      |                                                            |                  |
| Call Logging                           | On or Off for all phones                                   |                  |
| Store All Calls (Caller ID)            | On or Off (store all calls or unanswered calls)            |                  |
| Doorphone                              | On or Off (equipped or unequipped)                         |                  |
| System Voicebox (Answering Machine) On | On or Off                                                  |                  |
| 911 & Extension Sending                |                                                            |                  |
| Night Service                          | Automatic Service<br>Weekend Service                       |                  |
| Night Service On and Off Times         | HH:MM (24-Hour format)                                     |                  |
| Music On Hold                          | Internal source, External source, Tone on hold, or Silence |                  |
| Programming Position                   | Any equipped extension                                     |                  |
| Paging Amplifier Position              | Any extension (equipped or unequipped)                     |                  |
| System Programming Password            | Four digits                                                |                  |
| Set V24 Baud Rate                      | 4800, 9600, 19200                                          |                  |
| Courtesy Service Source                | Voice Module or Internal                                   |                  |
| Sales Telephone Number                 |                                                            |                  |
| Service Telephone Number               |                                                            |                  |
| Message Capacity                       | 10 – 50                                                    |                  |
| Group Divert to System Box             | On or Off                                                  |                  |

### Timers

| TIMER                    | RANGE       | DEFAULT     | NEW VALUE |
|--------------------------|-------------|-------------|-----------|
| Recall On Hold           | 0010 – 1800 | 90 seconds  |           |
| Recall On Transfer       | 001 – 180   | 90 seconds  |           |
| Forward On No Answer     | 01 – 180    | 15 seconds  |           |
| Courtesy Delay           | 01 – 30     | 30 seconds  |           |
| Open The Door            | 01 – 30     | 5 seconds   |           |
| Door Phone Ring Duration | 01 – 30     | 30 seconds  |           |
| Call Park                | 001 – 250   | 180 seconds |           |
| Ringback Time Duration   | 01 – 30     | 30 seconds  |           |
| Auto Attendant Delay     | 01 – 30     | 01 second   |           |
| Answer Machine Delay     | 01 – 180    | 30 seconds  |           |
| VM Message Length        | 30 – 180    | 120         |           |

**System Speed-Dial Numbers**

| DIAL | NUMBER | DIAL | NUMBER | DIAL | NUMBER | DIAL | NUMBER | DIAL | NUMBER |
|------|--------|------|--------|------|--------|------|--------|------|--------|
| 7001 |        | 7041 |        | 7081 |        | 7121 |        | 7161 |        |
| 7002 |        | 7042 |        | 7082 |        | 7122 |        | 7162 |        |
| 7003 |        | 7043 |        | 7083 |        | 7123 |        | 7163 |        |
| 7004 |        | 7044 |        | 7084 |        | 7124 |        | 7164 |        |
| 7005 |        | 7045 |        | 7085 |        | 7125 |        | 7165 |        |
| 7006 |        | 7046 |        | 7086 |        | 7126 |        | 7166 |        |
| 7007 |        | 7047 |        | 7087 |        | 7127 |        | 7167 |        |
| 7008 |        | 7048 |        | 7088 |        | 7128 |        | 7168 |        |
| 7009 |        | 7049 |        | 7089 |        | 7129 |        | 7169 |        |
| 7010 |        | 7050 |        | 7090 |        | 7130 |        | 7170 |        |
| 7011 |        | 7051 |        | 7091 |        | 7131 |        | 7171 |        |
| 7012 |        | 7052 |        | 7092 |        | 7132 |        | 7172 |        |
| 7013 |        | 7053 |        | 7093 |        | 7133 |        | 7173 |        |
| 7014 |        | 7054 |        | 7094 |        | 7134 |        | 7174 |        |
| 7015 |        | 7055 |        | 7095 |        | 7135 |        | 7175 |        |
| 7016 |        | 7056 |        | 7096 |        | 7136 |        | 7176 |        |
| 7017 |        | 7057 |        | 7097 |        | 7137 |        | 7177 |        |
| 7018 |        | 7058 |        | 7098 |        | 7138 |        | 7178 |        |
| 7019 |        | 7059 |        | 7099 |        | 7139 |        | 7179 |        |
| 7020 |        | 7060 |        | 7100 |        | 7140 |        | 7180 |        |
| 7021 |        | 7061 |        | 7101 |        | 7141 |        | 7181 |        |
| 7022 |        | 7062 |        | 7102 |        | 7142 |        | 7182 |        |
| 7023 |        | 7063 |        | 7103 |        | 7143 |        | 7183 |        |
| 7024 |        | 7064 |        | 7104 |        | 7144 |        | 7184 |        |
| 7025 |        | 7065 |        | 7105 |        | 7145 |        | 7185 |        |
| 7026 |        | 7066 |        | 7106 |        | 7146 |        | 7186 |        |
| 7027 |        | 7067 |        | 7107 |        | 7147 |        | 7187 |        |
| 7028 |        | 7068 |        | 7108 |        | 7148 |        | 7188 |        |
| 7029 |        | 7069 |        | 7109 |        | 7149 |        | 7189 |        |
| 7030 |        | 7070 |        | 7110 |        | 7150 |        | 7190 |        |
| 7031 |        | 7071 |        | 7111 |        | 7151 |        | 7191 |        |
| 7032 |        | 7072 |        | 7112 |        | 7152 |        | 7192 |        |
| 7033 |        | 7073 |        | 7113 |        | 7153 |        | 7193 |        |
| 7034 |        | 7074 |        | 7114 |        | 7154 |        | 7194 |        |
| 7035 |        | 7075 |        | 7115 |        | 7155 |        | 7195 |        |
| 7036 |        | 7076 |        | 7116 |        | 7156 |        | 7196 |        |
| 7037 |        | 7077 |        | 7117 |        | 7157 |        | 7197 |        |
| 7038 |        | 7078 |        | 7118 |        | 7158 |        | 7198 |        |
| 7039 |        | 7079 |        | 7119 |        | 7159 |        | 7199 |        |
| 7040 |        | 7080 |        | 7120 |        | 7160 |        | 7200 |        |

**Class of Service Tables**

**Table 2 - Restricted Numbers for Class of Service 2**

Enter up to 50 numbers.

|  |  |  |  |  |
|--|--|--|--|--|
|  |  |  |  |  |
|  |  |  |  |  |
|  |  |  |  |  |
|  |  |  |  |  |
|  |  |  |  |  |
|  |  |  |  |  |
|  |  |  |  |  |
|  |  |  |  |  |
|  |  |  |  |  |
|  |  |  |  |  |

**Table 3 - Restricted Numbers for Class of Service 3**

Enter up to 50 numbers.

|  |  |  |  |  |
|--|--|--|--|--|
|  |  |  |  |  |
|  |  |  |  |  |
|  |  |  |  |  |
|  |  |  |  |  |
|  |  |  |  |  |
|  |  |  |  |  |
|  |  |  |  |  |
|  |  |  |  |  |
|  |  |  |  |  |
|  |  |  |  |  |

**Table 5 - Restricted Numbers for Class of Service 5**

Enter up to 50 numbers.

|  |  |  |  |  |
|--|--|--|--|--|
|  |  |  |  |  |
|  |  |  |  |  |
|  |  |  |  |  |
|  |  |  |  |  |
|  |  |  |  |  |
|  |  |  |  |  |
|  |  |  |  |  |
|  |  |  |  |  |
|  |  |  |  |  |
|  |  |  |  |  |



**Sales and Service Numbers**

|                |  |
|----------------|--|
| Sales Number   |  |
| Service Number |  |

**8. EXTENSIONS PROGRAM PLANNING SHEETS**

**Name and Class of Service**

| EXTENSION | NAME | CLASS(ES) OF SERVICE | PICKUP GROUP | MANAGER<br>(IF SECRETARY) |
|-----------|------|----------------------|--------------|---------------------------|
| 20        |      |                      |              |                           |
| 21        |      |                      |              |                           |
| 22        |      |                      |              |                           |
| 23        |      |                      |              |                           |
| 24        |      |                      |              |                           |
| 25        |      |                      |              |                           |
| 26        |      |                      |              |                           |
| 27        |      |                      |              |                           |
| 28        |      |                      |              |                           |
| 29        |      |                      |              |                           |
| 30        |      |                      |              |                           |
| 31        |      |                      |              |                           |
| 32        |      |                      |              |                           |
| 33        |      |                      |              |                           |
| 34        |      |                      |              |                           |
| 35        |      |                      |              |                           |
| 36        |      |                      |              |                           |
| 37        |      |                      |              |                           |

\* Extension 24 is the Doorphone.



### Enabled/Disabled Features

Indicate which extensions will have each of the features *enabled* by placing a check mark in the box.

| PROGRAMMING OPTION       | 20 | 21 | 22 | 23 | 24* | 25 | 26 | 27 | 28 | 29 | 30 | 31 | 32 | 33 | 34 | 35 | 36 | 37 |
|--------------------------|----|----|----|----|-----|----|----|----|----|----|----|----|----|----|----|----|----|----|
| Tone Protect             |    |    |    |    |     |    |    |    |    |    |    |    |    |    |    |    |    |    |
| Page Protection          |    |    |    |    |     |    |    |    |    |    |    |    |    |    |    |    |    |    |
| General Call Protection  |    |    |    |    |     |    |    |    |    |    |    |    |    |    |    |    |    |    |
| Open Door Restriction    |    |    |    |    |     |    |    |    |    |    |    |    |    |    |    |    |    |    |
| Personal Caller ID Lists |    |    |    |    |     |    |    |    |    |    |    |    |    |    |    |    |    |    |
| Sys. Speed No. Override  |    |    |    |    |     |    |    |    |    |    |    |    |    |    |    |    |    |    |
| Voice Message Box        |    |    |    |    |     |    |    |    |    |    |    |    |    |    |    |    |    |    |
| Extension Disconnect     |    |    |    |    |     |    |    |    |    |    |    |    |    |    |    |    |    |    |
| No Call Logging          |    |    |    |    |     |    |    |    |    |    |    |    |    |    |    |    |    |    |
| No Trunk-to-Trunk Calls  |    |    |    |    |     |    |    |    |    |    |    |    |    |    |    |    |    |    |
| Restrict Use Of PA       |    |    |    |    |     |    |    |    |    |    |    |    |    |    |    |    |    |    |
| Hot Line                 |    |    |    |    |     |    |    |    |    |    |    |    |    |    |    |    |    |    |
| Manager/Secretary        |    |    |    |    |     |    |    |    |    |    |    |    |    |    |    |    |    |    |

\* Extension 24 is the Doorphone.

## 9. LINE PROGRAM PLANNING SHEETS

### Extensions with Incoming Ringing

#### Day Mode

|        | 20 | 21 | 22 | 23 | 25 | 26 | 27 | 28 | 29 | 30 | 31 | 32 | 33 | 34 | 35 | 36 | 37 | Central Bell |
|--------|----|----|----|----|----|----|----|----|----|----|----|----|----|----|----|----|----|--------------|
| Line 1 |    |    |    |    |    |    |    |    |    |    |    |    |    |    |    |    |    |              |
| Line 2 |    |    |    |    |    |    |    |    |    |    |    |    |    |    |    |    |    |              |
| Line 3 |    |    |    |    |    |    |    |    |    |    |    |    |    |    |    |    |    |              |
| Line 4 |    |    |    |    |    |    |    |    |    |    |    |    |    |    |    |    |    |              |
| Line 5 |    |    |    |    |    |    |    |    |    |    |    |    |    |    |    |    |    |              |
| Line 6 |    |    |    |    |    |    |    |    |    |    |    |    |    |    |    |    |    |              |
| Line 7 |    |    |    |    |    |    |    |    |    |    |    |    |    |    |    |    |    |              |
| Line 8 |    |    |    |    |    |    |    |    |    |    |    |    |    |    |    |    |    |              |

#### Night Mode

| LINE   | 20 | 21 | 22 | 23 | 25 | 26 | 27 | 28 | 29 | 30 | 31 | 32 | 33 | 34 | 35 | 36 | 37 | Central Bell |
|--------|----|----|----|----|----|----|----|----|----|----|----|----|----|----|----|----|----|--------------|
| Line 1 |    |    |    |    |    |    |    |    |    |    |    |    |    |    |    |    |    |              |
| Line 2 |    |    |    |    |    |    |    |    |    |    |    |    |    |    |    |    |    |              |
| Line 3 |    |    |    |    |    |    |    |    |    |    |    |    |    |    |    |    |    |              |
| Line 4 |    |    |    |    |    |    |    |    |    |    |    |    |    |    |    |    |    |              |
| Line 5 |    |    |    |    |    |    |    |    |    |    |    |    |    |    |    |    |    |              |
| Line 6 |    |    |    |    |    |    |    |    |    |    |    |    |    |    |    |    |    |              |
| Line 7 |    |    |    |    |    |    |    |    |    |    |    |    |    |    |    |    |    |              |
| Line 8 |    |    |    |    |    |    |    |    |    |    |    |    |    |    |    |    |    |              |

**Extensions with Outgoing Line Restriction**

| LINE   | 20 | 21 | 22 | 23 | 25 | 26 | 27 | 28 | 29 | 30 | 31 | 32 | 33 | 34 | 35 | 36 | 37 |
|--------|----|----|----|----|----|----|----|----|----|----|----|----|----|----|----|----|----|
| Line 1 |    |    |    |    |    |    |    |    |    |    |    |    |    |    |    |    |    |
| Line 2 |    |    |    |    |    |    |    |    |    |    |    |    |    |    |    |    |    |
| Line 3 |    |    |    |    |    |    |    |    |    |    |    |    |    |    |    |    |    |
| Line 4 |    |    |    |    |    |    |    |    |    |    |    |    |    |    |    |    |    |
| Line 5 |    |    |    |    |    |    |    |    |    |    |    |    |    |    |    |    |    |
| Line 6 |    |    |    |    |    |    |    |    |    |    |    |    |    |    |    |    |    |
| Line 7 |    |    |    |    |    |    |    |    |    |    |    |    |    |    |    |    |    |
| Line 8 |    |    |    |    |    |    |    |    |    |    |    |    |    |    |    |    |    |

---

**NOTE:** Extension 24 is not in these charts because it is assigned to the Doorphone.

---

**Equipped Lines and Telephone Numbers**

| LINE   | EQUIPPED? | TELEPHONE NUMBER |
|--------|-----------|------------------|
| Line 1 |           |                  |
| Line 2 |           |                  |
| Line 3 |           |                  |
| Line 4 |           |                  |
| Line 5 |           |                  |
| Line 6 |           |                  |
| Line 7 |           |                  |
| Line 8 |           |                  |

**Incoming Only Lines**

| LINE   | INCOMING ONLY? |
|--------|----------------|
| Line 1 |                |
| Line 2 |                |
| Line 3 |                |
| Line 4 |                |
| Line 5 |                |
| Line 6 |                |
| Line 7 |                |
| Line 8 |                |

### Line Groups

|        | GROUP 1 (9) | GROUP 2 (81) | GROUP 3 (82) | GROUP 4 (83) |
|--------|-------------|--------------|--------------|--------------|
| Line 1 |             |              |              |              |
| Line 2 |             |              |              |              |
| Line 3 |             |              |              |              |
| Line 4 |             |              |              |              |
| Line 5 |             |              |              |              |
| Line 6 |             |              |              |              |
| Line 7 |             |              |              |              |
| Line 8 |             |              |              |              |

### PBX Lines

|                     | PBX (Y/N) | ACCESS DIGIT(S) | EXTENSION LENGTH |
|---------------------|-----------|-----------------|------------------|
| Access Group 1 (9)  |           |                 |                  |
| Access Group 2 (81) |           |                 |                  |
| Access Group 3 (82) |           |                 |                  |
| Access Group 4 (83) |           |                 |                  |

### Hunt Groups

| LINES        | 1 | 2 | 3 | 4 |
|--------------|---|---|---|---|
| Hunt Group 1 |   |   |   |   |
| Hunt Group 2 |   |   |   |   |
| Hunt Group 3 |   |   |   |   |
| Hunt Group 4 |   |   |   |   |

| EXTENSIONS   | 20 | 21 | 22 | 23 | 25 | 26 | 27 | 28 | 29 | 30 | 31 | 32 | 33 | 34 | 35 | 36 | 37 |
|--------------|----|----|----|----|----|----|----|----|----|----|----|----|----|----|----|----|----|
| Hunt Group 1 |    |    |    |    |    |    |    |    |    |    |    |    |    |    |    |    |    |
| Hunt Group 2 |    |    |    |    |    |    |    |    |    |    |    |    |    |    |    |    |    |
| Hunt Group 3 |    |    |    |    |    |    |    |    |    |    |    |    |    |    |    |    |    |
| Hunt Group 4 |    |    |    |    |    |    |    |    |    |    |    |    |    |    |    |    |    |

**NOTE:** Extension 24 is not in this chart because it is assigned to the Doorphone.

### Answering Machine and Courtesy Service

| FEATURE           | SETTING (Circle One)                   | LINES |
|-------------------|----------------------------------------|-------|
| Answering Machine | Enabled or Disabled                    |       |
| Courtesy Service  | Voice Module Source or Internal Source |       |

### Alternative Routing and Automated Attendant

| FEATURE             | SETTING (Circle One)                                                 | LINES |
|---------------------|----------------------------------------------------------------------|-------|
| Alternative Routing | On or Off                                                            |       |
| Automated Attendant | <b>Day:</b> Enabled or Disabled<br><b>Night:</b> Enabled or Disabled |       |



# RMS Programming

| CONTENTS                                                      | PAGE        |
|---------------------------------------------------------------|-------------|
| <b>1. Introduction</b> .....                                  | <b>5-2</b>  |
| <b>2. RMS Hardware Requirements</b> .....                     | <b>5-2</b>  |
| <b>3. Installing the RMS Software (Initial Install)</b> ..... | <b>5-3</b>  |
| <b>4. Upgrading the RMS Software</b> .....                    | <b>5-4</b>  |
| <b>5. Starting the RMS Software – Main Screen</b> .....       | <b>5-4</b>  |
| <b>6. RMS Deferred Mode</b> .....                             | <b>5-7</b>  |
| <b>7. RMS Real Time Mode</b> .....                            | <b>5-8</b>  |
| A. Setting Up the Connection .....                            | 5-8         |
| B. Connecting to the KSU .....                                | 5-9         |
| C. Real Time Programming Screen .....                         | 5-10        |
| <b>8. RMS Programming Introduction</b> .....                  | <b>5-14</b> |
| <b>9. RMS Extension Programming</b> .....                     | <b>5-16</b> |
| A. Call Handling/Extension Name .....                         | 5-17        |
| B. Classes of Service/Pickup Groups .....                     | 5-18        |
| C. Extension Features .....                                   | 5-19        |
| D. Port Swapping .....                                        | 5-22        |
| E. Personal Speed Dial .....                                  | 5-23        |
| F. Program Keys/Reset Keys to Default Settings .....          | 5-24        |
| G. Phone Status .....                                         | 5-26        |
| <b>10. RMS Line Programming</b> .....                         | <b>5-27</b> |
| A. Incoming Ringing .....                                     | 5-28        |
| B. Line Access .....                                          | 5-29        |
| C. PABX Access .....                                          | 5-30        |
| D. Line Settings .....                                        | 5-31        |
| E. Hunt Groups .....                                          | 5-33        |
| F. Alternative Routing .....                                  | 5-34        |
| <b>11. RMS System Programming</b> .....                       | <b>5-36</b> |
| A. System Settings .....                                      | 5-37        |
| B. User Timers .....                                          | 5-39        |
| C. Exception and Restriction Tables .....                     | 5-40        |
| D. Program Caller ID Detection Number .....                   | 5-41        |
| E. System Speed Dial List .....                               | 5-42        |
| F. System Date and Time .....                                 | 5-43        |
| <b>12. Extensions Program Planning Sheets</b> .....           | <b>5-44</b> |
| <b>13. Trunk Program Planning Sheets</b> .....                | <b>5-47</b> |
| <b>14. System Program Planning Sheets</b> .....               | <b>5-50</b> |

## 1. INTRODUCTION

**1.1** The Remote Management Software is a PC-based software application which allows the Encore system to be programmed, on site or from a remote location, through a graphical user interface (GUI).

**1.2** When accessed, the Remote Management Software offers you the option of configuring live systems either locally or remotely and also allows you to build system databases off line. These databases can be stored and downloaded to systems at a later time.

**1.3** The system configuration files created with Remote Management Software are stored as management database files. These files contain the specific system settings for customer sites. If a customer has multiple sites, they may request similar programming to be downloaded to all of their systems. In this case the same configuration files can be downloaded to multiple sites to save programming time.

**1.4** This chapter is your guide to installing and using the Encore Remote Management Software. It is divided into the following sections:

- RMS Installation (page 5-3). The installation section covers the specifications and installation of the remote maintenance equipment.
- RMS Programming (page 5-14). The programming section is a system programming reference. It also includes copies of the Program Planning Sheets.

**1.5** The RMS Remote Maintenance chapter (page 6-1) describes all of the special remote maintenance features of the software.

## 2. RMS HARDWARE REQUIREMENTS

**2.1** Hardware requirements consist of a PC and associated software and a V24 adapter.

### A. PC REQUIREMENTS

**2.2** The Remote Management Software runs under Microsoft Windows. The PC running Remote Management Software must meet the following minimum requirements:

- Windows 95/98 or higher; Windows NT 4.0; Windows 2000
- 16 Megabytes of RAM
- 20 Megabytes of hard disk space to install the application (4 Megabytes to run the application)
- Available serial COM port (You may require a DB9-to-DB25 connector adapter if your PC is equipped with DB25 COM port sockets or you do not have an available DB9 connector.)

## B. V24 ADAPTER

**2.3** For on-site and remote connections, you will need a V24 Adapter and cables. The Remote Management Software PC is attached to the KSU's RJ11 connector using a V24 Adapter and a 3-foot (1-meter) RJ11-to-RJ11 cable, as shown below.

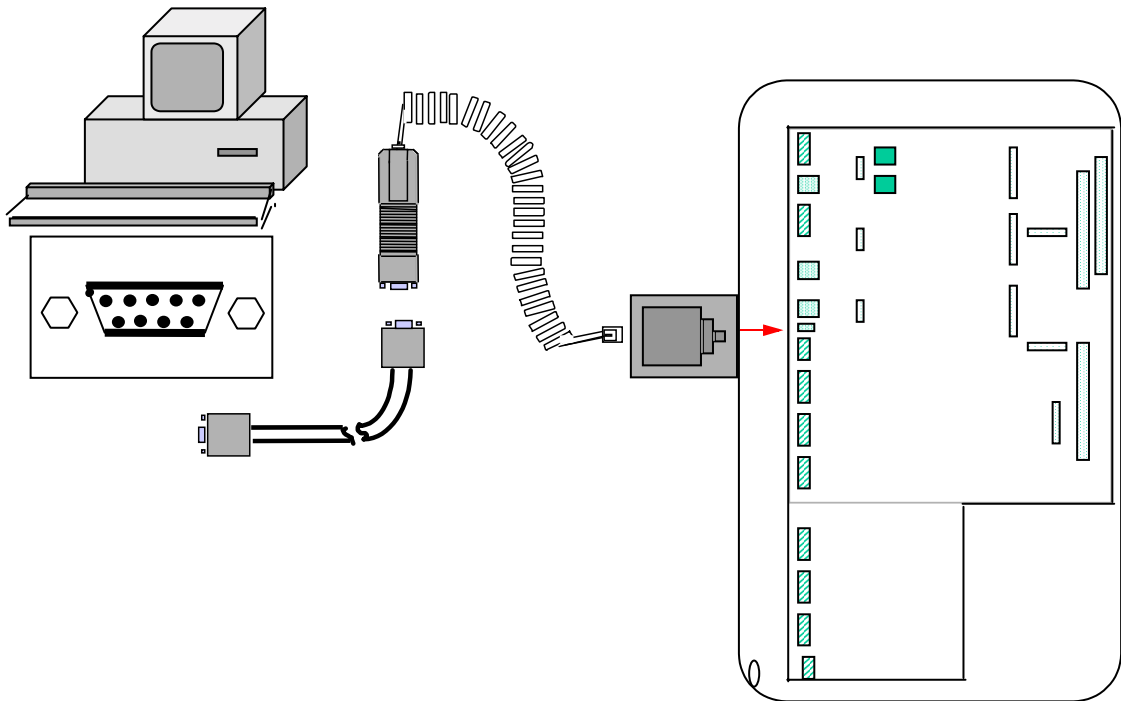

**2.4** For on-site programming, the V24 will be the connection to the on-site KSU. For remote access, it will be connected to your local KSU. You use the CO lines of your local Encore System to call the remote system for uploading and downloading information via the systems' built-in modems.

## 3. INSTALLING THE RMS SOFTWARE (INITIAL INSTALL)

- 3.1** If upgrading system software, refer to "Upgrading the System Software" on page 2-37.
- 3.2** If upgrading RMS software, refer to "Upgrading the RMS Software" on page 5-4.
- 3.3 To install the Remote Management software:**
  1. Insert the Remote Management Software CD into the CD-ROM drive.
  2. Run `setup.exe` from the CD.
  3. When prompted, select the directory where you want to install Remote Management Software.
  4. Follow the instructions on the screen to complete the installation.
  5. At the end of the installation, you are prompted to restart the computer. If you do not choose to restart at that time, you must do it before you can begin using the Remote Management Software.

## 4. UPGRADING THE RMS SOFTWARE

### 4.1 To upgrade the Remote Management software:

1. Insert the Remote Management Software CD into the CD-ROM drive.
2. Run **setup.exe** from the CD.

**NOTE:** During the installation, a dialog box displays with three option choices: repair, modify, and remove. The first two options are used to repair/modify a previously run installation. For example, if there was a problem opening a recently installed RMS version, repair/modify cannot be used to install a new installation over a previous installation. First, remove the old installation, then install the new RMS.

3. From the Welcome screen, select the **Repair** option, then click **Next**.
4. At the end of the upgrade, you are prompted to restart the computer. If you do not choose to restart at that time, you must do it before you can begin using the Remote Management Software.

## 5. STARTING THE RMS SOFTWARE – MAIN SCREEN

5.1 When you open the Remote Management Software, the following screen appears.

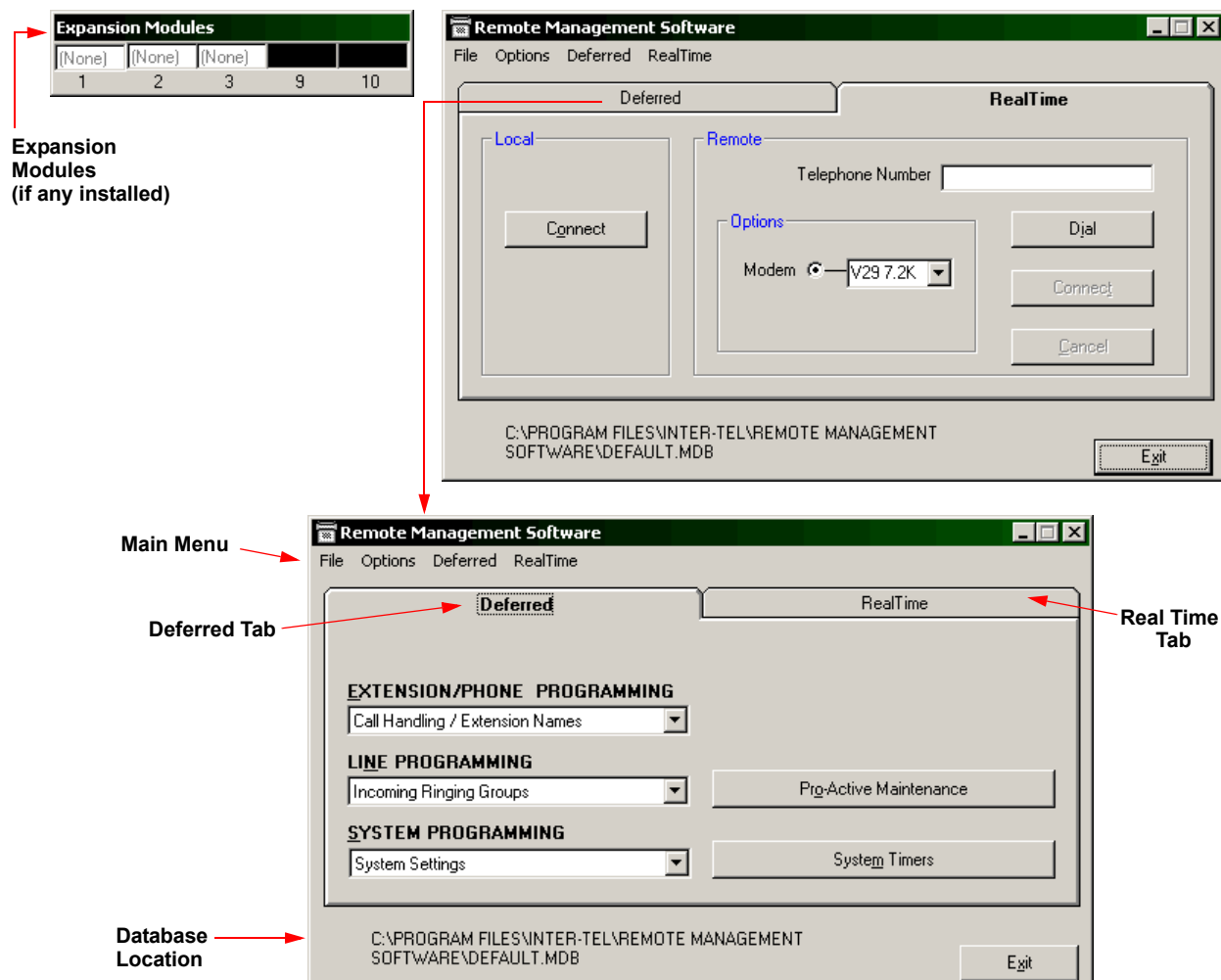



## A. DROP-DOWN MENUS

**5.2** The drop-down menus include the File, Options, Deferred, and Real Time options, as described below.

### File Menu

**5.3** This menu contains only the **Exit** option, which allows you to close the RMS application.

### Options Menu

**5.4** The Options menu contains four options: COM port Setup, Database, System Configuration, and Product Information. Each is described in detail below and on the following pages.

- **COM Port Setup.** This option opens the following dialog box. Select the COM port (on your PC) that is connected to the V24 Module. This is usually COM1.

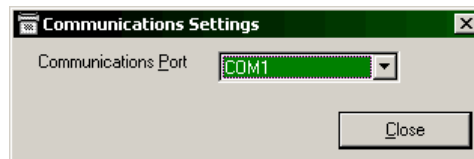

- **Database.** This option opens the Active Database dialog box shown below. The file name shown at the top of the dialog is the path and file name of the default system configuration file.

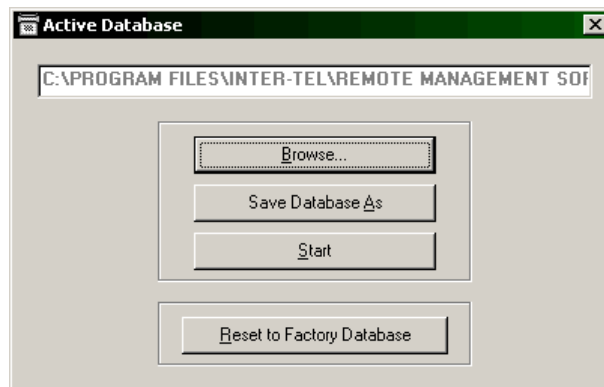

You have the following options:

- **Browse.** Browse for other system configuration files. When selected, they are displayed in the filename display window.
- **Save Database As.** Saves the active database under another file name.
- **Start.** Starts using the database file shown in the File Name field.
- **Reset to Factory Database.** Returns the database to default (factory) values.

- **System Configuration.** This opens the System Configuration dialog box shown below. The screen shown here is used for Deferred programming. The screen used for Real Time connections has different options, as described on [page 5-10](#). The file name for the database being programmed is shown at the top of the screen. The current system configuration programmed in that database is reflected in the other sections of the window.

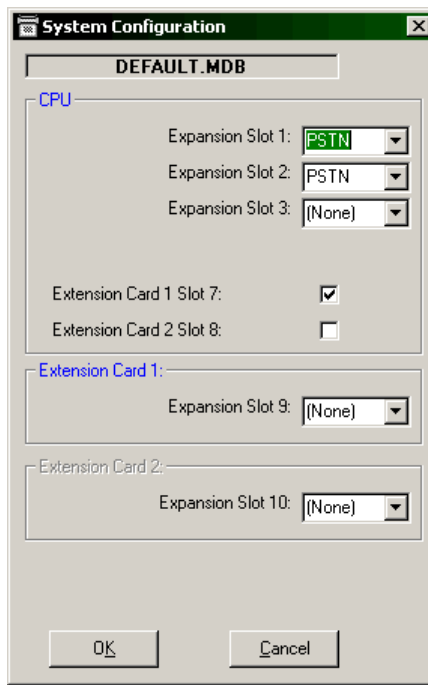

You can change the configuration using this screen, if necessary.

- **Expansion Slot 1-3.** For each Expansion Slot you have the ability to select either PSTN (Line Card) or None, depending upon whether or not a Line Card is installed.
  - **Extension Cards 1 and 2.** If there is a check mark in the box next to an Extension Card, that slot is equipped. In addition, the associated Expansion Slot (9 or 10) will also be activated.
  - **Expansion Slots 9 and 10.** If the associated Extension card is checked, you can select PSTN or None for the Expansion Slot, just as you did for Expansions Slots 1-3 above.
  - **OK and Cancel.** Select OK to save your changes and exit. Select Cancel to exit without saving any changes.
- **Product information.** This displays the screen shown below. It shows the version of Remote Management Software currently being used.

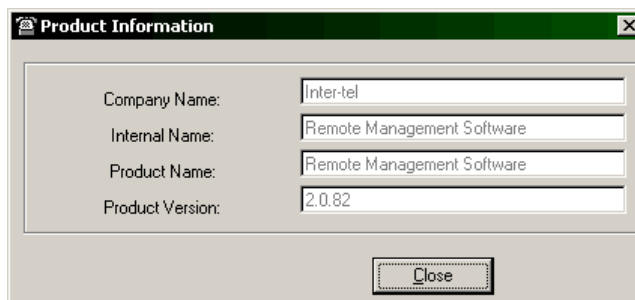

## B. DEFERRED MODE AND REAL TIME MODES

**5.5** The Remote Management Software offers different options when connected to a live system than when operating off-line. Off-line connections are defined as “deferred mode” because the changes you make are deferred until you upload the new database. On-line programming is done in “real time mode.”

**5.6** You have three ways to select the mode:

- *Tabs.* Select the **Deferred** or **Real Time** tab.
- *Menu options.* Select the **Deferred** or **Real Time** drop-down menu option.
- *Function keys.* Press **F1** for Deferred or **F2** for Real Time.

**5.7** The two modes are explained on the following pages.

**NOTE:** Before doing any programming in Deferred mode, after previously being in RealTime mode, do one of the following:

- Exit and restart RMS.
- Reset to the factory defaults.

## 6. RMS DEFERRED MODE

**6.1** The deferred screen is the first screen shown when the Remote Management Software is started.

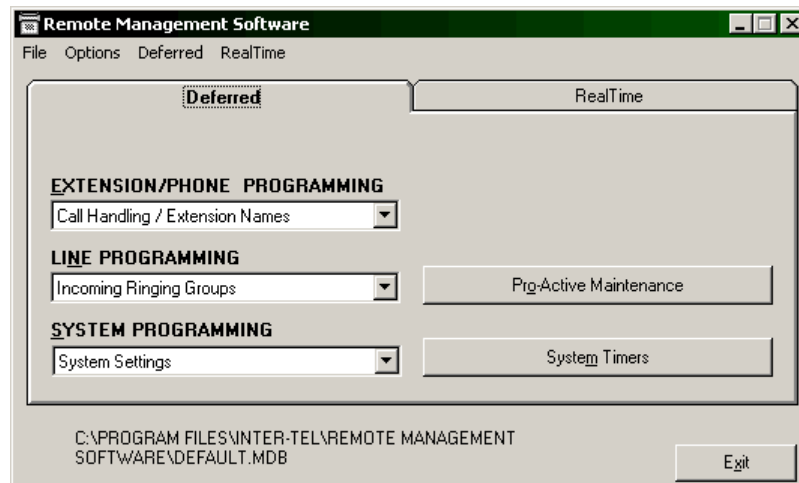

**6.2** The following options are available:

- **Extension/Phone Programming** (see page 5-16 for programming procedures)
- **Line Programming** (see page 5-27 for programming procedures)
- **System Programming** (see page 5-36 for programming procedures)
- **Pro-Active Maintenance** (see page 6-11 for programming procedures)
- **System Timers** (see page 6-13 for programming procedures)
- **Exit.** Closes the application. When selected, you are given the option of saving the database to a file.

**6.3** The Deferred screen allows you to generate off-line system configurations. These completed configurations may be stored as a file and downloaded to a live system, either locally or remotely, at a later time.

## 7. RMS REAL TIME MODE

7.1 In Real Time mode, you must first set up a connection with the system you want to program (before beginning the programming session).

**NOTE:** If you later decide to program in Deferred mode, after previously being in RealTime mode, do one of the following:

- Exit and restart RMS.
- Reset to the factory defaults.

### A. SETTING UP THE CONNECTION

7.2 The Real-time screen window contains the following options.

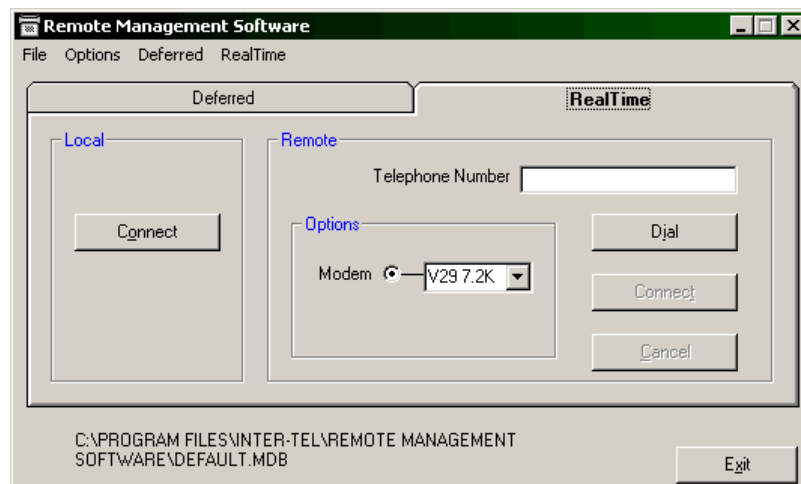

- **Local - Connect.** When selected this allows the Remote Management Software to communicate directly with a system via the V24 connection.
- **Remote.** The Remote connection settings are as follows:
  - **Telephone Number.** Allows you to enter the telephone number of the remote system.
  - **Options - Modem.** Use this drop-down list box to select the modem speed before calling the remote site. You have the choice of the following three speeds: 7.2k, 9.6k, or 300 baud. (The default speed is 7.2k.)
  - **Dial.** Dials the number displayed in the telephone number field.
  - **Connect.** Used when the call to the remote site has been answered and the remote modem answer tone is heard. The remote tone is returned to the local system when the remote user transfers the incoming call rings in directly or is transferred to the internal system modem, as described on the next page.
  - **Cancel.** Allows you to disconnect the call when the number you are dialing is unavailable and you wish to redial without exiting the application.
- **Exit.** Closes the application. You will be given the option of saving the database to a file.

**NOTE:** If you select EXIT while connected to a system, you are offered the option of saving the configuration file of the system to a file. If you have made no changes, select NO. Saving a file without naming it will overwrite the default configuration file.

## B. CONNECTING TO THE KSU

**7.3** To make a direct connection to an on-site KSU, simply select the **Connect** button in the Local area of the Real Time tab. To make a remote connection, follow the steps shown below.

**7.4 To connect to a remote KSU:**

1. Enter the remote system number in the **Telephone Number** field.
2. Select **Dial**. One of the following will occur:
  - If a user at the remote site answers the call, ask the user to transfer the call to **491** for V29 7.2 speed (default), **490** for V29 9.6 speed, or **492** for V21 speed.
  - If your Maintenance Center telephone number has been programmed into the remote system, and the number is matched from the incoming Caller ID information, the modem will return the 7.2k modem tone automatically if you are using V29 7.2 speed.
3. When you hear remote modem answer tone, select **Connect** from Remote area of the Real Time tab to complete the connection. A status bar, like the one shown below, is displayed above the main screen window. This indicates the status of the connect sequence in Local and Remote modes of operation. The background color for the status bar should always be GREEN when connecting. In the event of a communications error the bar will be RED. The status bar also shows the time and date of the last access to the system by Remote Management Software or by a station using Call Manger. The screen below shows that a station user was the last to access the system.



4. When the programming screen appears, as described on the next page, you can begin programming the remote system.

**7.5** When connected to the local or remote system, the application retrieves the system's configuration parameters and displays them at the top of your PC's screen using the following chart. The type of card installed in each location is indicated in the chart. Locations 1 and 2 are the PSTN (Line Card) slots on the connected system's CPU. Location 3 is unused. Locations 9 and 10 are the Line Card connections on the Extension Cards.

| Expansion Modules |      |        |      |      |
|-------------------|------|--------|------|------|
| PSTN              | PSTN | (None) | PSTN | PSTN |
| 1                 | 2    | 3      | 9    | 10   |

## C. REAL TIME PROGRAMMING SCREEN

**7.6** The Local or Remote Connection programming screen appears as soon as the connection is complete.

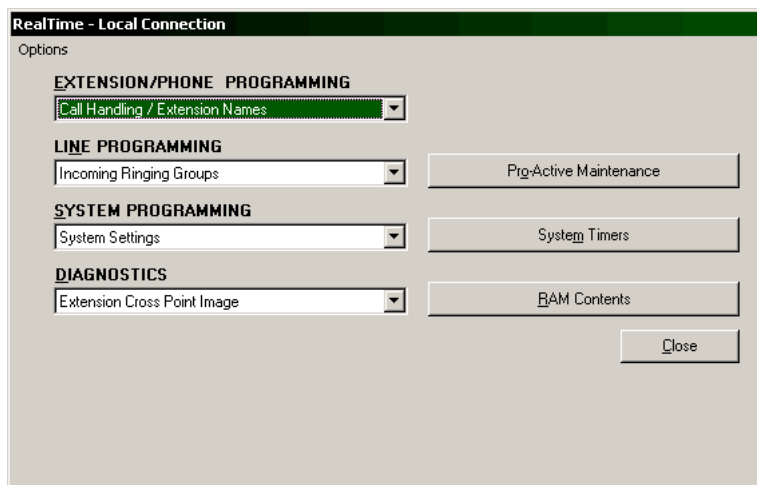

**7.7** The screen has the following programming options:

- **Extension/Phone Programming** (see [page 5-16](#) for programming procedures)
- **Line Programming** (see [page 5-27](#) for programming procedures)
- **System Programming** (see [page 5-36](#) for programming procedures)
- **Diagnostics** (see [page 6-2](#) for programming procedures)

---

**NOTE:** The Ram Contents button is provided for certified service technicians working in conjunction with Inter-Tel technicians.

---

- **Pro-Active Maintenance** (see [page 6-11](#) for programming procedures)
- **System Timers** (see [page 6-13](#) for programming procedures)
- **Close.** Closes the application. You will be given the option of saving the database to a file.

**7.8** It also has an Options drop-down menu with the following five options:

- **Database.** This option opens the Active Database dialog shown on [page 5-5](#). The file name shown at the top of the dialog is the path and file name of the default system configuration file. You have the following options:
  - **Browse.** Browse for other system configuration files. When selected, the files are displayed in the filename display window.
  - **Save Database As.** Saves the active database under another file name.
  - **Start.** Start using the database file shown in the File Name field (after changing it).
  - **Reset to Factory Database.** Return the database to default (factory) values.

- **System Configuration.** Opens the System Configuration dialog box, as shown below. It is similar to the screen shown on page 5-6, except that it shows the current configuration of the system as well as the database being used. The file name, for the database being programmed, is shown at the top left of the screen. The connected KSU software version is shown on the top right of the screen. The current configuration of the *system* being programmed is reflected in the right side of the screen. You can change the configuration, if necessary. The left side shows the configuration of the *database* being programmed.

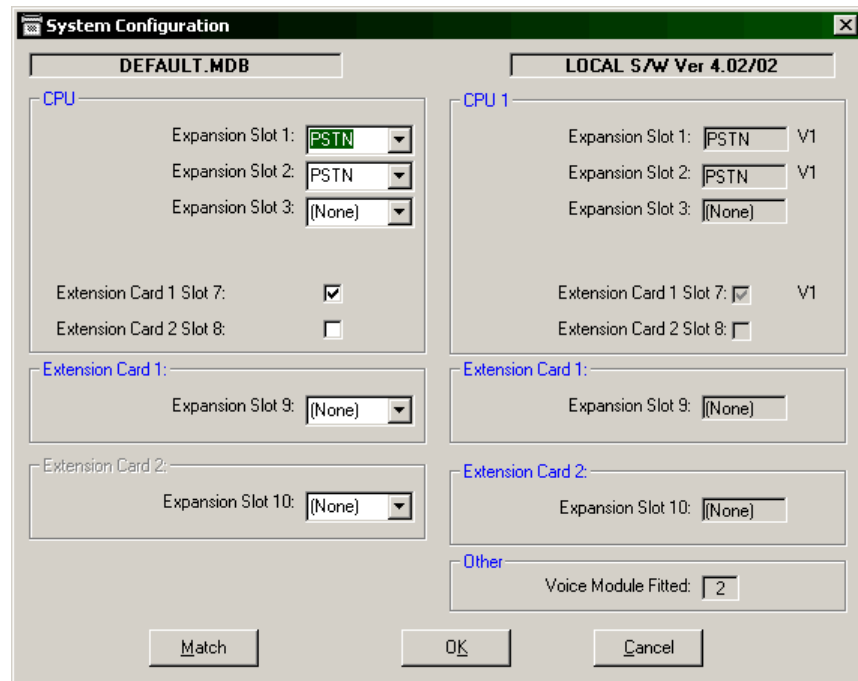

You have the following System configuration options:

- **Expansion Slot 1-3.** For each Expansion Slot you have the ability to select either PSTN (Line Card) or None, depending upon whether or not a Line Card is installed.
- **Extension Cards 1 and 2.** If there is a check mark in the box next to an Extension Card, that slot is equipped. If equipped, the associated Expansion Slot (9 or 10) will also be activated.
- **Expansion slots 9 and 10.** If the associated Extension card is checked, you can select PSTN or None for the Expansion Slot, just as you did for Expansions Slots 1-3 above.
- **Other - Voice Module Fitted.** Shows whether the Voice Messaging Module has been installed.
- **Match.** If the database values do not match the system, you can select the Match button to update the database file to the system configuration.
- **OK and Cancel.** Select OK to save your changes and exit. Or select Cancel to exit without saving any changes.

- **Download Flash.** Opens a dialog box that allows you to send system software to the local system's flash memory. The system software is identified by the numbers 1 and 2. The system has two flash EPROMS on board, the flash download file ending in the number 1 is destined for EPROM 1 and the flash download file ending in number 2 is destined for EPROM 2. Full download files are identified as **FDL** files and patch download files are identified as **PDL** files. For example if the version of the software being downloaded is version 1.70, the files associated with a full download would be 170\_xxx1.FDL and 170\_xxx2.FDL, where xxx is the revision level for that particular release. Where patch download is concerned, it is possible to send file changes to one or both of the EPROM's.

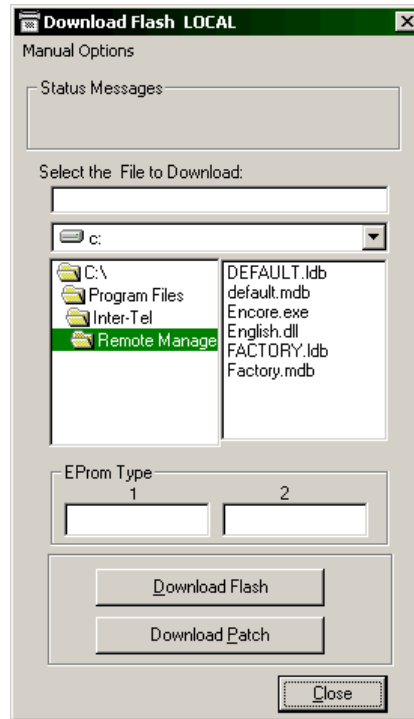

Download options are:

- **Select the File to Download.** Locate and highlight the file you wish to download, using the field below the file name.
- **Download Flash (Direct connections only).** Downloads the system software from your PC. When you select **Download Flash** to initiate the download sequence, the files from your PC are automatically downloaded.
- **Download Patch.** Used for partial downloads. The files being downloaded are not the complete system files, but sections relating to changes required for specific functions and fault resolutions. When you select **Download Patch** to initiate the download sequence, the files from your PC are automatically downloaded.

---

**NOTE:** The download causes the connection between the PC and the KSU to drop.

---

Approximate throughput times for data rates are:

- Flash download of full system software duration should take about 25 minutes.
- Patch download depends upon the size of the patch file.



- **Send Database.** Opens a dialog box that allows you to send a database to the system. You can choose to send the entire database to the system being configured or you can send sections of the active database.

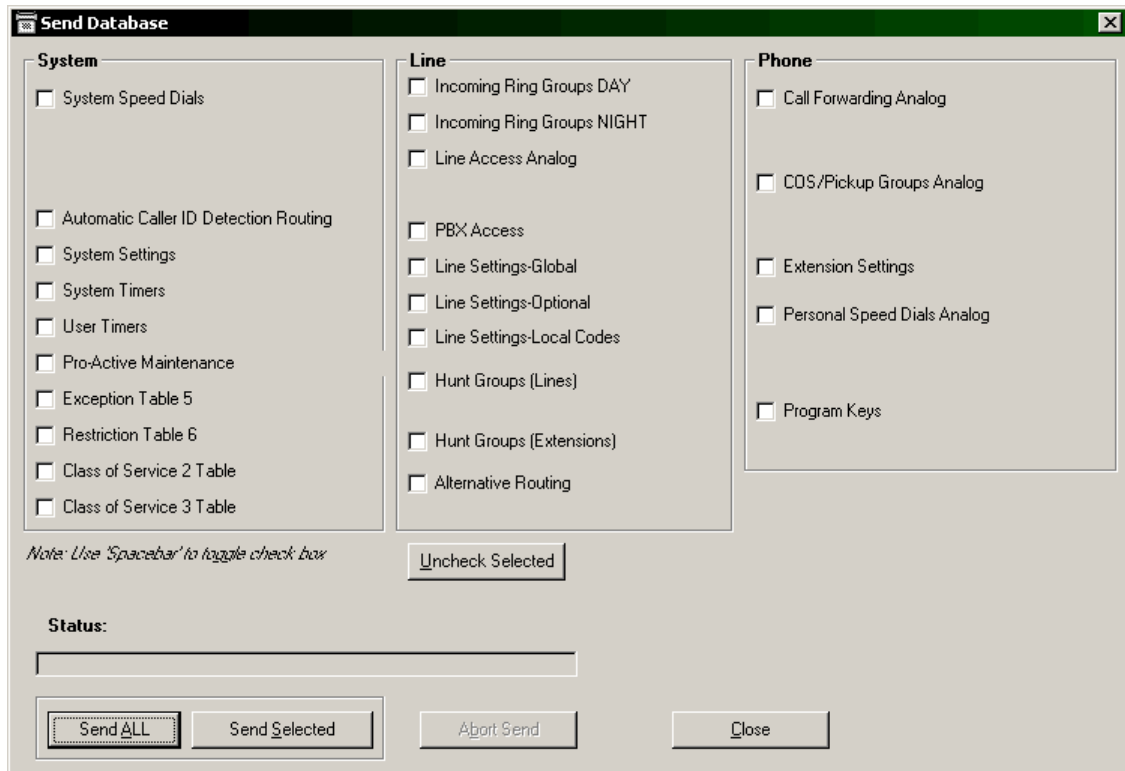

You can use the following options:

- **System, Line, Phone, and Send Selected.** Select the System, Line, and Phone information you want to have downloaded by placing check marks in the appropriate boxes. (If necessary, you can select **Uncheck Selected** to remove all check marks and start over.) Then select **Send Selected**. The Status field will show you what is being sent. When completed, a message will pop up to tell you the Send is complete.
- **Send All.** To send the complete database, select **Send All**. The Status field will show you what is being sent. When completed, a message will pop up to tell you the Send is complete.
- **Abort Send.** If necessary, you can stop sending the database. The Status field will show you what is being sent. When you select **Abort Send**, the current database section will complete sending and then the Send operation will stop. When the Send is stopped, a message will pop up to tell you the Send was aborted.
- **Close.** Select this to exit from the Send Database window.

- **Receive All.** Used to receive the full database from the connected system. You have the following options:
  - **Receive All.** Begin uploading information to your PC. A status message, like the one shown below, displays what is being received.

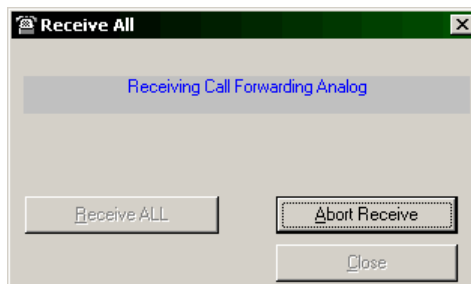

- **Abort Receive.** Stops receiving the database. The Status field displays what was being sent. When you select **Abort Receive**, the current database section completes sending, then the Receive operation stops. When the Receive stops, a message appears informing you the operation was aborted.
- **Close.** Exit from the Receive All window.

## 8. RMS PROGRAMMING INTRODUCTION

**8.1** This section explains how to program the system using the RMS software. The default values of the Encore System reflect a typical installation. Therefore, the system only requires minimal programming before startup. Some installations will require additional programming to enable special features and make changes to meet the customer's needs.

**8.2 To perform programming that *must* be completed after initial installation:**

Complete step 10 on [page 33](#).

---

**NOTE:** Programmers must be certified on the Encore System to receive technical support.

---

**8.3** An example programming screen is shown below.

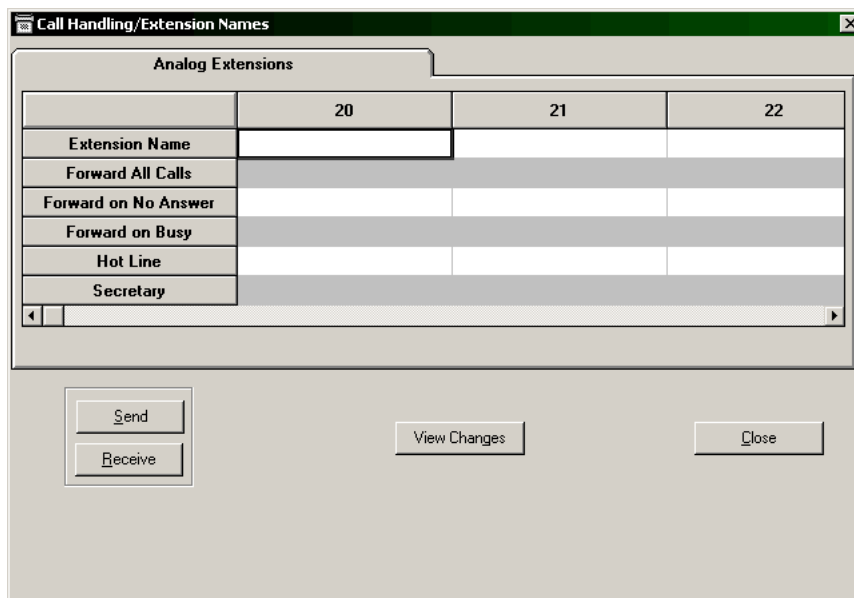

**8.4** The programming screens have the following buttons:

- **Send.** Sends selected the programmed information to the system during a Real Time connection.
- **Receive.** Retrieves selected information from the system during a Real Time connection.
- **View Changes.** Allows you to see the changes that have taken place on the screen before you send them.
- **Close.** Allows you to exit from the programming screen.

---

**NOTE:** You can Send or Receive a single field, a row, a column or a page of data. The data that is highlighted is the data that will be sent or received.

---

**8.5** In both Deferred and Real Time programming, you have the following options:

- **Extension/Phone Programming** (see [page 5-16](#) for programming procedures)
- **Line Programming** (see [page 5-27](#) for programming procedures)
- **System Programming** (see [page 5-36](#) for programming procedures)
- **Pro-Active Maintenance** (see [page 6-11](#) for programming procedures)
- **System Timers** (see [page 6-13](#) for programming procedures)

**8.6** In Real Time programming, the **Diagnostics** option is available (see [page 6-2](#) for programming procedures).

**8.7** In many screens you can program a range of extensions or lines. To do so, highlight the bar on the left. This highlights the entire line. To set all extensions or line for the option, select **Set Range ON**. This enables the option on all the extensions. Conversely, to set the range off, select the option and select **Set Range OFF**.

## 9. RMS EXTENSION PROGRAMMING

**9.1** The **Extension/Phone Programming** drop-down list includes all of the extension programming options. The following table lists the available Extensions options, with their allowed values and defaults, if applicable. In each of the following screens, you can scroll to the extension you want to program and fill in the fields.

**Table 5-1:** *RMS Extension Programming Values*

| SECTION                                                | PROGRAMMING OPTION                                     | ALLOWED VALUES                                               | DEFAULT VALUE                         |
|--------------------------------------------------------|--------------------------------------------------------|--------------------------------------------------------------|---------------------------------------|
| <b>Call Handling / Extension Name</b><br>(page 17)     | Extension Name                                         | Up To 10 Characters                                          | None programmed                       |
|                                                        | Call Forwarding                                        | Forward All Calls<br>Forward On No Answer<br>Forward On Busy |                                       |
|                                                        | Hot Line                                               | On or Off                                                    | Not programmed                        |
|                                                        | Manager/Secretary                                      | Create Secretary extensions and assign Manager extensions    |                                       |
| <b>Classes of Service / Pickup Groups</b><br>(page 18) | Restriction Classes                                    | Day/Night Class Of Service                                   | All extensions in Class 1             |
|                                                        | Pickup Groups                                          | Pickup Group 1, 2, 3, or 4                                   | All extensions in group 1             |
| <b>Extension Settings</b><br>(page 19)                 | Protected From Tones                                   | On or Off                                                    | Extensions do not accept tone         |
|                                                        | Protected From Paging                                  |                                                              | Extensions accept paging              |
|                                                        | Protected from general calls                           |                                                              | Extensions accept General calls       |
|                                                        | Extension Disconnected                                 | Connected or Disconnected                                    | All extensions connected              |
|                                                        | No Call Logging                                        | On or Off                                                    | Not programmed                        |
|                                                        | No Trunk to Trunk                                      |                                                              |                                       |
|                                                        | Personal Caller ID List                                | Up to 12 extensions can be enabled                           | No stores programmed                  |
|                                                        | Voice Messaging                                        | One message box per extension                                | Not programmed                        |
|                                                        | COS overridden by System Speed Dial                    | On or Off                                                    | No override programmed                |
|                                                        | Restricted use of PA                                   |                                                              | All extensions On                     |
|                                                        | Door Restrict                                          |                                                              | All extensions disabled               |
|                                                        | Voice Mail Password                                    | Eight digits                                                 | Default 1111                          |
|                                                        | Reminder Call                                          | HH:MM                                                        | No reminders set                      |
|                                                        | Extension Lock Code                                    | Four digits                                                  | Default 123                           |
|                                                        | Language                                               | English, French, or Spanish                                  | English                               |
|                                                        | Default to mid volume                                  | Off                                                          | ON (extension defaults to mid volume) |
| Keypad Feedback                                        | On or Off                                              | ON (keypad has feedback)                                     |                                       |
| <b>Port Swapping</b><br>(page 22)                      | Move any extension to an available extension interface |                                                              | Not programmed                        |
| <b>Personal Speed Dial</b><br>(page 23)                | Up to 12 numbers with names                            |                                                              |                                       |

**Table 5-1:** RMS Extension Programming Values (Continued)

| SECTION                          | PROGRAMMING OPTION                                                                              | ALLOWED VALUES | DEFAULT VALUE                           |
|----------------------------------|-------------------------------------------------------------------------------------------------|----------------|-----------------------------------------|
| <b>Program Keys</b><br>(page 24) | Line, extension, digit, or feature keys (DND, forward all calls)<br>Reset keys to default       |                | All programmable keys are Line keys 1-8 |
| <b>Phone Status</b><br>(page 26) | Names, do-not-disturb mode, call forwarding, ringbacks, reminders, passwords, and text messages | N/A            | N/A                                     |

## A. CALL HANDLING/EXTENSION NAME

**9.2** Selecting the Call Handling/Extension Names programming option provides the following programming options, shown below.

|                      | 20   | 21     | 22       |
|----------------------|------|--------|----------|
| Extension Name       | OPER | BROGAN | MARTELLI |
| Forward All Calls    |      |        |          |
| Forward on No Answer |      | 22     |          |
| Forward on Busy      |      | 20     |          |
| Hot Line             |      |        |          |
| Secretary            |      |        |          |

- **Extension Name.** Assign names to extensions. When a Keyset extension receives an internal call, its display shows the calling extension name in the place of the extension number.
- **Forwarding Options.** Allows you to enable or disable call forwarding or check which number to which calls are being forwarded.
- **Hot Line.** When an extension is programmed as a Hot Line, as soon as you go off-hook on the Keyset, the preset number is dialed. No other features can be used at a Hot Line extension. A common application for the Hot Line feature is for a fax or modem. The extension can be set to automatically seize a line so the fax or modem does not have to dial 9. In this screen, you can set the number that the Hot Line extension will dial.
- **Secretary.** The Manager/Secretary feature is a set of programming options used to maximize the efficiency with which two people work together. It is typically used for a manager/secretary partnership. This option allows you to indicate which extension will serve as the Secretary for the extension being programmed. In this screen, you can set the Secretary extension.

## B. CLASSES OF SERVICE/PICKUP GROUPS

9.3 The following screen allows you to assign the toll restriction Class of Service options and Pickup Groups for all extensions on the system.

9.4 The options are:

- **Class of Service Day/Night.** Using these fields, you can assign the extensions to a Class of Service that will operate when the system is in Day and/or Night Mode. At default, all extensions are in Class 1 for both day and night. The six Classes of Service are defined as follows. (See the table on the next page for a summary.)
  - Extensions in Class 1 have no restrictions placed on them.
  - A extension placed in Class 2 is restricted from dialing the numbers programmed in Table 2. (Table 2 would typically be programmed with international and operator-assisted toll digits, such as 011+ and 01+).
  - A extension placed in Class 3 is restricted from dialing the numbers programmed in Tables 2 and 3. (Table 3 would typically be programmed with toll digits, such as 1+).
  - A extension placed in Class 4 is restricted to internal and emergency (911) calls only.
  - A extension placed in Class 5 is allowed to dial the codes programmed in Table 5. (However, the extension can also be assigned Class 2 or 3 to limit some calls. This table can include allowed area codes, office codes, and/or complete telephone numbers.)
  - A extension placed in Class 6 is restricted from dialing codes in Table 6. (This table would typically be programmed with local long-distance area codes. This Class can be combined with Classes 2 and/or 3.)

- **Exceptions and Restrictions.** View the Exceptions and Restrictions screen (shown on page 5-40).
- **Tables.** Place a check mark in the appropriate boxes to designate which Tables will be used by each extension for toll restriction.
- **Pickup Groups.** Program extensions to be in one of the four Pick-Up Groups. Group members can pick up any call (internal or external) that is ringing at another extension in the same group. (For extensions not in your Pick-Up Group, you can pick up external, but not internal, calls. You can also pick up an external call that is ringing on a Central Bell.)

**9.5** The following chart summarizes the Classes of Service and the Tables they use:

**Table 5-2:** *Classes of Service and Associated Table*

| CLASS | TYPE OF RESTRICTION                                                       | TABLE                              |
|-------|---------------------------------------------------------------------------|------------------------------------|
| 1     | No restriction                                                            | N/A                                |
| 2     | Restrict codes in Table 2 (can be combined with Classes 5 and/or 6)       | Table 2 - Restricted Numbers       |
| 3     | Restrict codes in Table 2 and 3 (can be combined with Classes 5 and/or 6) | Tables 2 and 3 -Restricted Numbers |
| 4     | Internal and Emergency calls only                                         | N/A                                |
| 5     | Allow codes (can be combined with Classes 2, 3, and/or 6)                 | Table 5 - Allowed Numbers          |
| 6     | Restrict codes (can be combined Class 2, 3, and/or 5)                     | Table 6 - Restricted Numbers       |

### C. EXTENSION FEATURES

**9.6** The following screen allows you to define the features available on an extension basis. To enable a feature, place a check mark in the appropriate box for each extension. The password fields allow you to view and/or change the extension’s Voice mail or Extension Lock password. The Reminder Call and Language features require you to enter or select information to set the feature.

|                                                                   | 20                       | 21                                  | 22                                  | 23                                  | 24                                  |
|-------------------------------------------------------------------|--------------------------|-------------------------------------|-------------------------------------|-------------------------------------|-------------------------------------|
| Protected from Tones                                              | <input type="checkbox"/> | <input checked="" type="checkbox"/> | <input checked="" type="checkbox"/> | <input checked="" type="checkbox"/> | <input checked="" type="checkbox"/> |
| Protected from Paging                                             | <input type="checkbox"/> | <input type="checkbox"/>            | <input type="checkbox"/>            | <input type="checkbox"/>            | <input type="checkbox"/>            |
| Protected from general calls(the complete group is sent/received) | <input type="checkbox"/> | <input type="checkbox"/>            | <input type="checkbox"/>            | <input type="checkbox"/>            | <input type="checkbox"/>            |
| Extension Disconnected                                            | <input type="checkbox"/> | <input type="checkbox"/>            | <input type="checkbox"/>            | <input type="checkbox"/>            | <input type="checkbox"/>            |
| No Call Logging                                                   | <input type="checkbox"/> | <input type="checkbox"/>            | <input type="checkbox"/>            | <input type="checkbox"/>            | <input type="checkbox"/>            |
| No Trunk to Trunk                                                 | <input type="checkbox"/> | <input type="checkbox"/>            | <input type="checkbox"/>            | <input type="checkbox"/>            | <input type="checkbox"/>            |
| Personal Caller ID List                                           | <input type="checkbox"/> | <input type="checkbox"/>            | <input type="checkbox"/>            | <input type="checkbox"/>            | <input type="checkbox"/>            |
| Voice Messaging                                                   | <input type="checkbox"/> | <input type="checkbox"/>            | <input type="checkbox"/>            | <input type="checkbox"/>            | <input type="checkbox"/>            |
| COS overridden by System Speed Dial                               | <input type="checkbox"/> | <input type="checkbox"/>            | <input type="checkbox"/>            | <input type="checkbox"/>            | <input type="checkbox"/>            |
| Restricted use of PA                                              | <input type="checkbox"/> | <input type="checkbox"/>            | <input type="checkbox"/>            | <input type="checkbox"/>            | <input type="checkbox"/>            |
| Door Restrict                                                     | <input type="checkbox"/> | <input type="checkbox"/>            | <input type="checkbox"/>            | <input type="checkbox"/>            | <input type="checkbox"/>            |
| Voice Mail Password                                               | 1111                     | 1111                                | 1111                                | 1111                                | 1111                                |
| Reminder Call (hhmm)                                              |                          |                                     |                                     |                                     |                                     |
| Extension Lock Code                                               | 123                      | 123                                 | 123                                 | 123                                 | 123                                 |
| Voice Messaging Port 1                                            | <input type="checkbox"/> | <input type="checkbox"/>            | <input type="checkbox"/>            | <input type="checkbox"/>            | <input type="checkbox"/>            |
| Voice Messaging Port 2                                            | <input type="checkbox"/> | <input type="checkbox"/>            | <input type="checkbox"/>            | <input type="checkbox"/>            | <input type="checkbox"/>            |
| Language                                                          | English                  | English                             | English                             | English                             | English                             |

Warning: Changing voice messaging settings may delete all greetings and messages in all voiceboxes View Changes

**9.7** A feature can be set for a range of extensions. For example to protect all extensions from call waiting tones, highlight the Protect From Tones bar on the left. This causes the entire line to be highlighted. To set all extensions for the option select **Set Range ON**. This enables the option on all the extensions. Conversely, to set the range off, select the option and select **Set Range OFF**.

**9.8** The extension features that can be programmed using this screen include the following:

- **Protected from Tones.** Extensions may send busy extension a call waiting tone, provided the busy extension is not protected against receiving call waiting tones. Any user may program his or her extension to block call waiting tones during a call.
- **Protected from Paging.** Protect a Keypad to prevent it from receiving pages. By default, all Keypads may be paged.
- **Protected from General Calling.** Allows you ring all extensions connected to the Encore System. The first extension to answer is connected and the call continues as a normal call. By default, all extension can receive General Calls. You can protect a extension to prevent it from receiving General Calls.
- **Extension Disconnected.** The system assumes that all available extension interfaces have devices connected to them. If an extension interface does not have a device connected, ensure correct system operation by disconnecting the extension interface in system programming.

---

**NOTE:** When a Keypad is connected to an extension interface that is programmed as disconnected, the Keypad display may appear as if the Keypad is connected. However, when the handset is lifted a busy tone is heard and no options will be displayed.

---

- **No Call Logging.** If the system is equipped with a Call Logging Interface Module, a printer or PC may be connected, which will maintain a record of incoming and outgoing calls made on the system. Details are printed as the calls are completed. If Call Logging is enabled, by default all calls from all extensions will be logged. However, individual extensions can be programmed to prevent their calls being logged.
- **No Trunk-To-Trunk.** You may prevent individual extensions from setting up trunk-to-trunk calls using Forward, Transfer, and Conference.
- **Personal Caller ID List.** You can allow up to 12 extensions to store five Caller ID numbers each. Each of these extensions will have a separate record of calls that ring on CO lines programmed to ring their extensions only. All leftover Caller ID storage locations will be allocated to the system-wide Central Storage.
- **Voice Messaging.** A Voice Messaging Module can be installed in the Encore KSU to provide Voice Messaging, Automated Attendant service, Answering Machine service, and customized Courtesy Service greetings. Place a check in this field for each extension that will have a voice message box.
- **COS Overridden by System Speed Dial.** You can allow extensions to override their toll restriction Class of Service when they dial system speed-dial numbers. By default, this feature is not activated on any extension. Entering numbers into the System Speed-Dial list and activating this feature on the extensions allows the restricted extensions to access these numbers.

---

**NOTE:** Numbers on an extension's personal speed-dial list cannot override the Class of Service restriction of the extension.

---



- **Restricted Used of PA.** External paging equipment (a paging amplifier and speaker) can be connected to the system. Users can then make announcements over the external paging equipment. Place a check in the box if you wish to restrict access to the external paging equipment from this extension.
- **Door Restrict.** The Encore System has a doorstrike relay output that can be used to operate a strikeplate mechanism, allowing users to open the door from their extensions. The doorstrike remains open until the Open the Door timer expires (defaults to five seconds). This feature determines whether the extension will be allowed to open the door.
- **Voice Mail Password.** View or change an extension's Voice Messaging password.
- **Reminder Call.** The extension user can set a Reminder Message to ring at a specific time. This field allows you to view or change the Reminder setting.
- **Extension Lock Code.** View or change an extension's Extension Lock password.
- **Language.** Show keyset displays in English, Spanish, or French. The default language is English. This option sets the Keyset's language. However, the keyset users can manually change the keyset display.
- **Default to mid volume.** Volume settings are defaulted to mid volume regardless of the volume setting at the keyset. To retain manual volume settings, remove the corresponding checkbox for the extension. All extensions are defaulted to mid-volume by default.
- **Keypad Feedback.** Provides keypad feedback tone. This option is ON by default. Once the DTMF tones are established, rather by connection established or by the inter-digit time out, the Keypad Feedback tone should be turned OFF automatically.

## D. PORT SWAPPING

**NOTE:** This feature is available in Real Time mode only.

**9.9** If an extension interface becomes faulty, you can swap its extension programming to a different extension. Calls for the faulty extension will be routed automatically to the new extension. The following screen shows the default and current positions of the extensions.

| Default Position | Current Position |
|------------------|------------------|
| 20               | 20               |
| 21               | 21               |
| 22               | 22               |
| 23               | 23               |
| 24               | 24               |
| 25               | 25               |
| 26               | 26               |
| 27               | 27               |
| 28               | 28               |
| 29               | 29               |
| 30               | 30               |
| 31               | 31               |

Swap

From:

To:

### 9.10 To move an extension:

1. Enter the extension numbers you want to swap in the **From** and **To** fields.
2. Select **Send** to save the change.
3. If you are on a Real Time connection, select the **Initialize** button to reset the values back to default.

## E. PERSONAL SPEED DIAL

**9.11** Personal speed-dial numbers can be stored for personal use. Keypad extensions can store up to 12 numbers and single-line extensions can store up to 10. The speed-dial numbers can be associated with names, if desired.

**9.12** The following screen allows you to access the individual extension speed dial tables and write, remove, or edit the contents. Simply highlight the field you wish to program and enter the new information.

The screenshot shows a window titled "Personal Speed Dial Numbers" with a sub-tab "Analog Extensions". It contains a table with the following structure:

| Ext | 20 Tel. No | 20 Name | 21 Tel. No | 21 Name |
|-----|------------|---------|------------|---------|
| 1   |            |         |            |         |
| 2   |            |         |            |         |
| 3   |            |         |            |         |
| 4   |            |         |            |         |
| 5   |            |         |            |         |
| 6   |            |         |            |         |
| 7   |            |         |            |         |
| 8   |            |         |            |         |
| 9   |            |         |            |         |
| 10  |            |         |            |         |
| 11  |            |         |            |         |
| 12  |            |         |            |         |

Below the table are buttons for "Send", "Receive", "View Changes", and "Close". A note at the bottom states: "Note: To write a Name there must be an associated Number".

**9.13** Numbers can contain up to 24 digits. To enter a pause in the number, use an underscore. For example, to pause between the outgoing digit "9" and the telephone number "961-9000," you would enter 9\_9619000. Names can have up to 10 characters.

---

**NOTE:** Do not use a pause as the first digit.

---

## F. PROGRAM KEYS/RESET KEYS TO DEFAULT SETTINGS

**9.14** There are eight Programmable keys across the top of each Keyset. These keys are pre-programmed as Line keys. You can program the keys to use any feature code or extension number.

- If you use a feature code, you can also program additional digits. If you are programming the key to call an external number, remember to precede the number with a 9, an Outgoing Group code (81-83), or a line code (51-58) to seize a line.
- If you assign an extension number to a Programmable key, the light in the key indicates the status of the extension. When the extension is in use, the light is lit.

**9.15** This screen has two tabs: Program Key(s) and Reset Key(s) to Default Settings.

|      | 20   | 21   | 22   |
|------|------|------|------|
| Key1 | Line | Line | Line |
| Key2 | Line | Line | Line |
| Key3 | Line | Line | Line |
| Key4 | Line | Line | Line |
| Key5 | Line | Line | Line |
| Key6 | Line | Line | Line |
| Key7 | Line | Line | Line |
| Key8 | Line | Line | Line |

### Program Key(s)

**9.16** The **Program Key(s)** tab, shown above, allows you to check or change the programmed settings in the keys of the specified extension. Valid entries are:

- **Line.** By default the keys select the line positions 1-8. Line key 1 selects Line 1, Line key 2 selects Line 2, etc.
- **Extension.** Put an extension number into the field.
- **Individual digits.** Enter a frequently dialed number.
- **Feature Key.** Create one-touch feature keys.
  - *Do not disturb.* Places the station in Do Not Disturb mode.
  - *Forward All Calls.* Forwards all call immediately. (When selected the forward number is requested.)
  - *Forward On Busy.* Forwards calls when the extension is in use. (When selected the forward number is requested.)
  - *Forward On No Answer.* Forwards call when the extension user does not answer the call before a timer expires. (When selected the forward number is requested.)
  - *Call Pick Up.* Picks up a ringing extension.
  - *External Call Pickup.* Picks up an outside call.
  - *Intercom Call.* Places a voice call to a Keyset.

- *General Call.* Places a general call to all phones.
- *Page All Keysets.* Places a page to Keypad speakers.
- *Public Address.* Places a page over the external paging equipment.
- *Extension Lock.* Locks the phone after the Extension Lock password is entered.
- *Reminder Call.* Sets a time for the phone to ring.
- *Open Door.* Releases the doorstrike relay.
- *Reset Phone.* Removes all phone settings and reverts to default (i.e., removes forwards, Do Not Disturb, etc.)
- *Call Park.* Parks a call.
- *Room Monitor.* Sets up the phone to allow room monitor function.

**9.17** Double-clicking on a key displays the associated line, extension, feature, or digits for the key in a window like the one shown below. You can view or edit the information shown.

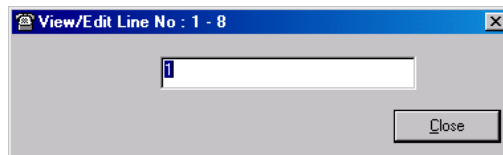

### Reset Keys to Default Settings

**NOTE:** This feature is available in Real Time mode only.

**9.18** The **Reset Key(s) to Default Settings** tab allows you to select specific keysets, then reset those keys to the default factory settings (Line Keys 1-8). Simply select the extensions you want to reset, then select **Send**.

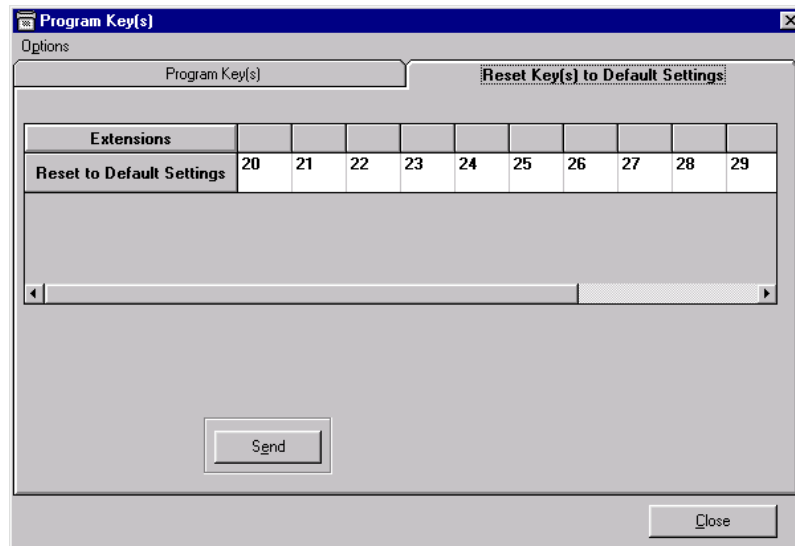

## G. PHONE STATUS

9.19 The Phone Status screen is shown below.

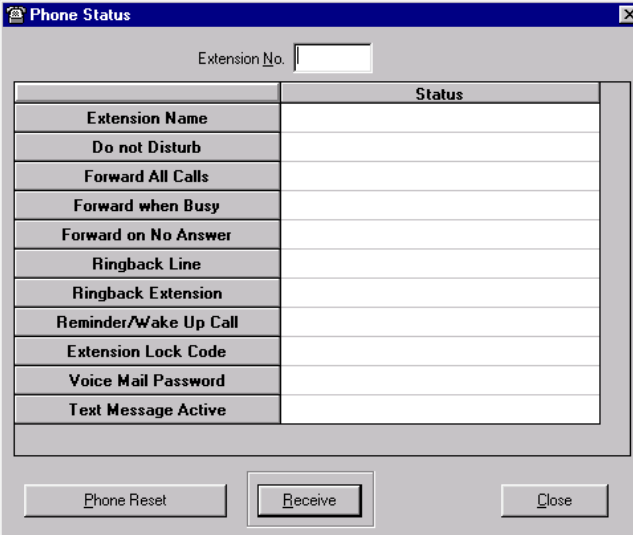

The screenshot shows a window titled "Phone Status" with a close button (X) in the top right corner. Below the title bar is a text field labeled "Extension No." with a cursor. Below this is a table with two columns: "Extension Name" and "Status". The table contains the following rows:

| Extension Name        | Status |
|-----------------------|--------|
| Do not Disturb        |        |
| Forward All Calls     |        |
| Forward when Busy     |        |
| Forward on No Answer  |        |
| Ringback Line         |        |
| Ringback Extension    |        |
| Reminder/Wake Up Call |        |
| Extension Lock Code   |        |
| Voice Mail Password   |        |
| Text Message Active   |        |

At the bottom of the window are three buttons: "Phone Reset", "Receive", and "Close".

9.20 You can see the parameters that are set on a specific extension position by entering the extension number in the **Extension No.** field and then selecting **Receive**.

9.21 If you wish to cancel Do Not Disturb, Forward, Ringback, Reminder, and Text Message for the displayed station, select the **Phone Reset** button.

## 10. RMS LINE PROGRAMMING

**10.1** If **Line Programming** is selected, the CO line programming options appear. The following table lists the available Line Programming options with their allowed values and defaults, if applicable.

**Table 5-3:** *RMS Line Programming Values*

| OPTION                                   | FEATURE                                                 | ALLOWED VALUES                                                                                  | DEFAULT VALUE                                |
|------------------------------------------|---------------------------------------------------------|-------------------------------------------------------------------------------------------------|----------------------------------------------|
| <b>Incoming Ringing Groups</b> (page 28) | Day/Night Incoming Ringing                              | 20-37 and Central Bell                                                                          | 20-25 Programmed for all Lines and Doorphone |
| <b>Line Access</b> (page 29)             | PSTN (outgoing access)                                  | Allows extensions to place outgoing calls                                                       | All extensions have access to Lines 1-6      |
| <b>PBX Access</b> (page 30)              | Access Groups, PBX Access Digits and PBX Ext. No Length | Access Digits<br>Extension Number Length                                                        | Not Programmed                               |
| <b>Line Settings</b> (page 31)           | Global, Optional, and Local Code line settings          |                                                                                                 |                                              |
| Global tab                               | Equipped                                                | 1-6                                                                                             | All Lines Equipped                           |
|                                          | Incoming Access Only                                    | On or Off                                                                                       | Off                                          |
|                                          | Link to Answering Machine                               |                                                                                                 |                                              |
|                                          | Courtesy Service Day                                    | Voice Module Source or Internal Source                                                          | Not Enabled                                  |
|                                          | Auto Attendant Day                                      |                                                                                                 |                                              |
|                                          | Outgoing Access Groups                                  | Outgoing Group 1 (9)<br>Outgoing Group 2 (81)<br>Outgoing Group 3 (82)<br>Outgoing Group 4 (83) | All Lines In Group 1                         |
|                                          | Courtesy Service Night                                  |                                                                                                 | Not Enabled                                  |
|                                          | Auto Attendant Night                                    |                                                                                                 |                                              |
| Optional tab                             | Tone Dialing                                            | On or Off                                                                                       | All Tone Dialing                             |
|                                          | Caller ID Detection                                     |                                                                                                 | ON                                           |
|                                          | Loop Calling                                            |                                                                                                 | Off                                          |
| Local Codes tab                          | Local Area Codes                                        | Up to 40 codes                                                                                  | None                                         |
| <b>Hunt Groups</b> (page 33)             | Assign extensions and lines to up to four hunt groups   |                                                                                                 | No Hunt Groups                               |
| <b>Alternative Routing</b> (page 34)     | Digit codes and Line assignments                        | On or Off                                                                                       | Alternative Routing Off                      |

## A. INCOMING RINGING

**10.2** Any or all extensions, and the Central Bell, can be programmed to receive ringing for incoming calls on the Lines and from the Doorphone. By default, all CO lines ring at extensions 20 to 25. Each line can be programmed to ring up to 18 extensions and a Central Bell. Each line may also be programmed to ring different extensions for Day and Night Modes.

**NOTE:** The Group Divert to System Box flag (page 5-39) looks at the Incoming Ringing Groups options below. The lowest number in the ringing group is not necessarily the first extension that is rang when a group divert to voice mail takes place. The call is diverted to the voice mail of the first station shown in the Incoming Ringing Groups table in RMS – not the number of the lowest station number in the table.

**10.3** The following screen allows you to select the extensions that will ring for each line and for the Doorphone.

|           | Central Bell                        | 1st Ext. | 2nd Ext. | 3rd Ext. | 4th Ext. | 5th Ext. | 6th Ext. | 7th Ext. | 8th Ext. | 9th Ext. |
|-----------|-------------------------------------|----------|----------|----------|----------|----------|----------|----------|----------|----------|
| Line 1    | <input checked="" type="checkbox"/> | 20       | 21       | 22       | 23       | 24       | 25       |          |          |          |
| Line 2    | <input type="checkbox"/>            | 20       | 21       | 22       | 23       | 24       | 25       |          |          |          |
| Line 3    | <input checked="" type="checkbox"/> | 20       | 21       | 22       | 23       | 24       | 25       |          |          |          |
| Line 4    | <input type="checkbox"/>            | 20       | 21       | 22       | 23       | 24       | 25       |          |          |          |
| Line 5    | <input checked="" type="checkbox"/> | 20       | 21       | 22       | 23       | 24       | 25       |          |          |          |
| Line 6    | <input type="checkbox"/>            | 20       | 21       | 22       | 23       | 24       | 25       |          |          |          |
| Doorphone | <input checked="" type="checkbox"/> | 20       | 21       | 22       | 23       | 24       | 25       |          |          |          |

**10.4** Place a check mark in the Central Bell box if you want the line to ring the Central Bell, then place a check in up to 18 extension numbers for each line and/or the doorphone.

**NOTE:** The Night screen is the same as the Day screen shown above.



## B. LINE ACCESS

10.5 The Line Access screen is shown below.

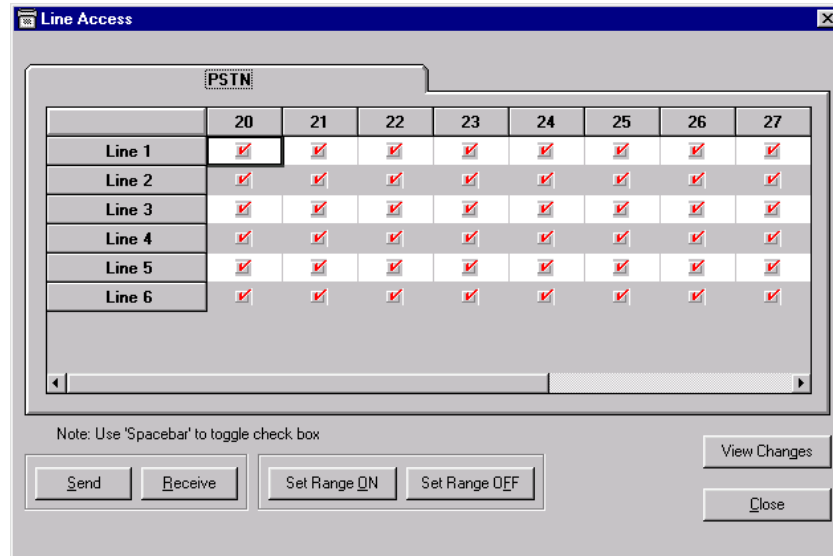

10.6 You can decide which lines each extension can use for outgoing calls. By default, all extensions have access to all lines. As a means of restricting outgoing calls, extensions can be prevented from having access to one or more CO lines for placing calls. Users attempting to place a call using a restricted CO line hear a busy signal.

10.7 Place check marks in the appropriate boxes to determine which extensions are allowed make outgoing calls on each line.

10.8 To select all extensions for a specific line, highlight the Line bar on the left. This highlights the entire line. To set ring in for all extensions for that line, select **Set Range ON**. Conversely, to disable ringing for all the extensions, highlight the Line X bar and select **Set Range OFF**.

## C. PABX ACCESS

**10.9** The PBX Access screen is shown below.

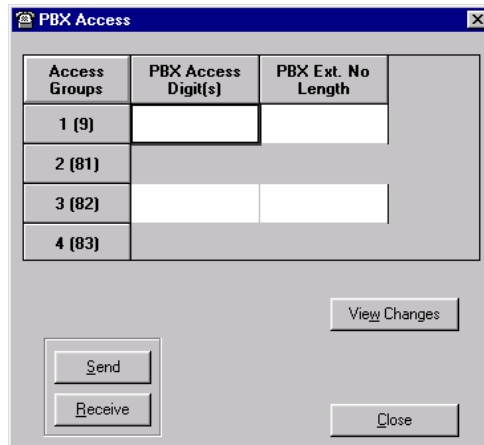

| Access Groups | PBX Access Digit(s) | PBX Ext. No Length |
|---------------|---------------------|--------------------|
| 1 (9)         |                     |                    |
| 2 (81)        |                     |                    |
| 3 (82)        |                     |                    |
| 4 (83)        |                     |                    |

Buttons: Send, Receive, View Changes, Close

**10.10** You can connect the Encore System to a parent PBX through its line interfaces. You can then program any of the four Line Groups to work with a parent PBX.

**10.11** When programming the Line Groups as PBX groups, you must tell the system what digits are required to select a line in the parent PBX. The system “absorbs” those digits when a call is placed and will not consider them part of the number when applying toll restrictions. (You can have a maximum of two digits). You must also tell the system how many digits are in the extension numbers on the PBX.

## D. LINE SETTINGS

**10.12** Three Line Setting tabs are provided: Global, Optional, and Local Codes. Each is described in detail in the following pages.

|                           | Line 1                              | Line 2                              | Line 3                              | Line 4                              | Line 5                              | Line 6                              |
|---------------------------|-------------------------------------|-------------------------------------|-------------------------------------|-------------------------------------|-------------------------------------|-------------------------------------|
| Equipped                  | <input checked="" type="checkbox"/> | <input checked="" type="checkbox"/> | <input checked="" type="checkbox"/> | <input checked="" type="checkbox"/> | <input checked="" type="checkbox"/> | <input checked="" type="checkbox"/> |
| Incoming Access Only      | <input type="checkbox"/>            | <input type="checkbox"/>            | <input type="checkbox"/>            | <input type="checkbox"/>            | <input type="checkbox"/>            | <input type="checkbox"/>            |
| Link to Answering Machine | <input type="checkbox"/>            | <input type="checkbox"/>            | <input type="checkbox"/>            | <input type="checkbox"/>            | <input type="checkbox"/>            | <input type="checkbox"/>            |
| Courtesy Service Day      | <input type="checkbox"/>            | <input type="checkbox"/>            | <input type="checkbox"/>            | <input type="checkbox"/>            | <input type="checkbox"/>            | <input type="checkbox"/>            |
| Auto Attendant Day        | <input type="checkbox"/>            | <input type="checkbox"/>            | <input type="checkbox"/>            | <input type="checkbox"/>            | <input type="checkbox"/>            | <input type="checkbox"/>            |
| Outgoing Access Groups    | 1                                   | 1                                   | 1                                   | 1                                   | 1                                   | 1                                   |

Before programming Courtesy Service Day/Night, you MUST PROGRAM the Courtesy Service source in the System Settings window

Note: Use 'Spacebar' to toggle check box

If CID Detect is On, you must define your local codes

View Changes

Send Receive

Close

### Global Settings

**10.13** A check mark in the box indicates that the field is enabled. Click on the field to place or remove the check mark. This tab allows you to set the following for each line:

- **Equipped.** The system assumes that all line interfaces have lines connected. If an interface does not have a connection, ensure correct operation by unequipping the line.
- **Incoming Access Only.** Lines can be designated as “incoming-only” lines to prevent them from being used for outgoing calls.
- **Link to Answering Machine.** The answering machine can be used to answer incoming calls and record messages for selected lines. It can be enabled for individual lines.
- **Courtesy Service Day/Night.** Used in systems where there may be delays in answering calls, and the customer wants to ensure that callers do not hang up before someone answers their call. It can be enabled for day and/or night mode.
- **Auto Attendant Day/Night.** Allows calls to ring directly through to an extension provided that the caller knows the extension number of the person they wish to contact. A Voice Messaging Module must be installed for this feature to operate. You can program individual lines to be answered with the Automated Attendant for day and night modes. Automated Attendant may only be set up if Customized Courtesy Service has not already been invoked.
- **Outgoing Access Groups.** Lines can be grouped together into up to four Outgoing Groups. Each Outgoing Group is associated with a code. These codes are 9, 81, 82, and 83, with Group 1 being associated with 9, etc. Dialing a code seizes a line from the associated Outgoing Group. (Lines can be in one Outgoing Group only. Selecting a line to be a member of a Group automatically removes it from all other Groups.)

**NOTE:** When dialing a speed-dial number, the system checks the Outgoing Line Groups for an available line. It begins checking with Group 1 and, if no lines are available, checks the rest of the groups in numerical order. To avoid having a speed-dial number dialed on a special-purpose line (FX, PBX, etc.), make sure those lines are in the highest numbered group.

## Optional Settings

10.14 The Optional Settings tab includes the following items:

|                     | Line 1                              | Line 2                              | Line 3                              | Line 4                              | Line 5                              | Line 6                              |
|---------------------|-------------------------------------|-------------------------------------|-------------------------------------|-------------------------------------|-------------------------------------|-------------------------------------|
| Tone Dialing        | MF                                  | MF                                  | MF                                  | MF                                  | MF                                  | MF                                  |
| Caller ID Detection | <input checked="" type="checkbox"/> | <input checked="" type="checkbox"/> | <input checked="" type="checkbox"/> | <input checked="" type="checkbox"/> | <input checked="" type="checkbox"/> | <input checked="" type="checkbox"/> |
| Loop Calling        | <input type="checkbox"/>            | <input type="checkbox"/>            | <input type="checkbox"/>            | <input type="checkbox"/>            | <input type="checkbox"/>            | <input type="checkbox"/>            |

Note: Use 'Spacebar' to toggle check box

If CID Detect is On, you must define your local codes

Buttons: Send, Receive, View Changes, Close

- **Tone Dialing.** The system can be installed with either DTMF or dial-pulse lines. Dial-pulse lines must be designated as such in database programming, because all lines are designated as DTMF (shown as MF) when the system is initialized.
- **Caller ID Detection.** Caller ID service is available from your telephone company. If you subscribe to this service, your network sends the telephone number, or telephone number and name, of outside callers (providing the caller has not blocked the number). You have the choice of displaying, or not displaying, this information on Keypad displays. At default, the system is not programmed to receive Caller ID information.
- **Loop Calling.** All lines are programmed by default to use standard Loop Start signaling. When a line is seized, the switch expects to hear dial tone and, if it does not, the line is disconnected. You can program CO lines to use Loop Calling if required.

## Local Codes

10.15 You can define up to 40 local area codes. It is necessary to program local area codes into the system so the system can recognize Caller ID numbers that must have the digit 1 added when they are redialed. The local area codes do not need to have the 1 added.

| Local Area Code |
|-----------------|
| 1               |
| 2               |
| 3               |
| 4               |
| 5               |
| 6               |
| 7               |
| 8               |
| 9               |

Note: Use 'Spacebar' to toggle check box

If CID Detect is On, you must define your local codes

Buttons: Send, Receive, Initialize, View Changes, Close

## E. HUNT GROUPS

**10.16** The Hunt Group feature allows you to have groups of extensions answering different lines. The calls to the Hunt Group are presented in cyclical order to the extensions in the group. That is, the first call is presented to the first extension on the list, the next to the second extension, and so on.

**10.17** Up to four hunt groups can be programmed. Each hunt group can have lines allocated to it. Place check marks in the appropriate boxes to assign lines to the Hunt Groups.

|         | Line 1                   | Line 2                   | Line 3                   | Line 4                   | Line 5                   | Line 6                   |
|---------|--------------------------|--------------------------|--------------------------|--------------------------|--------------------------|--------------------------|
| Group 1 | <input type="checkbox"/> | <input type="checkbox"/> | <input type="checkbox"/> | <input type="checkbox"/> | <input type="checkbox"/> | <input type="checkbox"/> |
| Group 2 | <input type="checkbox"/> | <input type="checkbox"/> | <input type="checkbox"/> | <input type="checkbox"/> | <input type="checkbox"/> | <input type="checkbox"/> |
| Group 3 | <input type="checkbox"/> | <input type="checkbox"/> | <input type="checkbox"/> | <input type="checkbox"/> | <input type="checkbox"/> | <input type="checkbox"/> |
| Group 4 | <input type="checkbox"/> | <input type="checkbox"/> | <input type="checkbox"/> | <input type="checkbox"/> | <input type="checkbox"/> | <input type="checkbox"/> |

**10.18** After the lines are selected, extensions are added to the group using the Hunt Group Extensions tab shown below. Place check marks in the appropriate boxes to assign the extensions to the Hunt Groups.

|         | Ext 20                   | Ext 21                   | Ext 22                   | Ext 23                   | Ext 24                   | Ext 25                   | Ext 26                   | Ext 27                   |
|---------|--------------------------|--------------------------|--------------------------|--------------------------|--------------------------|--------------------------|--------------------------|--------------------------|
| Group 1 | <input type="checkbox"/> | <input type="checkbox"/> | <input type="checkbox"/> | <input type="checkbox"/> | <input type="checkbox"/> | <input type="checkbox"/> | <input type="checkbox"/> | <input type="checkbox"/> |
| Group 2 | <input type="checkbox"/> | <input type="checkbox"/> | <input type="checkbox"/> | <input type="checkbox"/> | <input type="checkbox"/> | <input type="checkbox"/> | <input type="checkbox"/> | <input type="checkbox"/> |
| Group 3 | <input type="checkbox"/> | <input type="checkbox"/> | <input type="checkbox"/> | <input type="checkbox"/> | <input type="checkbox"/> | <input type="checkbox"/> | <input type="checkbox"/> | <input type="checkbox"/> |
| Group 4 | <input type="checkbox"/> | <input type="checkbox"/> | <input type="checkbox"/> | <input type="checkbox"/> | <input type="checkbox"/> | <input type="checkbox"/> | <input type="checkbox"/> | <input type="checkbox"/> |

**NOTE:** The lines and extensions programmed in a Hunt Group are exclusive to that Hunt Group and cannot be placed in another Hunt Group. Calls can be transferred to an individual extension in a Hunt Group from an extension outside the Hunt Group, but not to the Hunt Group as a whole.

## F. ALTERNATIVE ROUTING

**10.19** You can use Alternative Routing to have calls routed over specific lines (such as specialized common carriers or equal access lines), using special digits, if necessary. You can create up to 50 special Alternative Call Routing numbers.

**10.20** When the option is programmed the digits dialed by an extension are analyzed and, if they match one of the Digit Codes, the call is routed to an alternative network.

**10.21** Calls placed using Alternative Routing can be sent out on specific lines or any line. The digits dialed can be sent as dialed or they can be replaced by a programmed code. The Alternative Routing screen is divided into two tabs: Digit Codes and Lines.

|    | Dialed | Replace | Exclusive                |
|----|--------|---------|--------------------------|
| 1  |        |         | <input type="checkbox"/> |
| 2  |        |         | <input type="checkbox"/> |
| 3  |        |         | <input type="checkbox"/> |
| 4  |        |         | <input type="checkbox"/> |
| 5  |        |         | <input type="checkbox"/> |
| 6  |        |         | <input type="checkbox"/> |
| 7  |        |         | <input type="checkbox"/> |
| 8  |        |         | <input type="checkbox"/> |
| 9  |        |         | <input type="checkbox"/> |
| 10 |        |         | <input type="checkbox"/> |

### Digit Codes

**10.22** The following options are available from the Digit Codes tab:

- **Alternative Routing ON.** Place a check in this box to enable the Alternative Routing feature.
- **Dialed.** These are the codes that, when dialed, trigger the system to use alternative routing.
- **Replace.** If digits are entered in this field, the dialed digits are replaced with these digits when the call is placed.
- **Exclusive.** If checked, calls can only be sent on the lines selected for this code in the Lines tab (shown on [page 5-35](#)). If not checked, calls are routed on any available line, if none of the selected lines are available.

## Lines

**10.23** For each code entered on the previous page, the line(s) over which the call is to be routed must also be programmed in the Lines tab, shown below. Selecting the Lines tab displays the available lines and digit codes. Place a check mark in the appropriate lines for each digit code.

|    | Line 1                              | Line 2                              | Line 3                              | Line 4                              | Line 5                              | Line 6                              |
|----|-------------------------------------|-------------------------------------|-------------------------------------|-------------------------------------|-------------------------------------|-------------------------------------|
| 1  | <input checked="" type="checkbox"/> | <input checked="" type="checkbox"/> | <input checked="" type="checkbox"/> | <input checked="" type="checkbox"/> | <input checked="" type="checkbox"/> | <input checked="" type="checkbox"/> |
| 2  | <input checked="" type="checkbox"/> | <input checked="" type="checkbox"/> | <input checked="" type="checkbox"/> | <input checked="" type="checkbox"/> | <input checked="" type="checkbox"/> | <input checked="" type="checkbox"/> |
| 3  | <input checked="" type="checkbox"/> | <input checked="" type="checkbox"/> | <input checked="" type="checkbox"/> | <input checked="" type="checkbox"/> | <input checked="" type="checkbox"/> | <input checked="" type="checkbox"/> |
| 4  | <input checked="" type="checkbox"/> | <input checked="" type="checkbox"/> | <input checked="" type="checkbox"/> | <input checked="" type="checkbox"/> | <input checked="" type="checkbox"/> | <input checked="" type="checkbox"/> |
| 5  | <input checked="" type="checkbox"/> | <input checked="" type="checkbox"/> | <input checked="" type="checkbox"/> | <input checked="" type="checkbox"/> | <input checked="" type="checkbox"/> | <input checked="" type="checkbox"/> |
| 6  | <input checked="" type="checkbox"/> | <input checked="" type="checkbox"/> | <input checked="" type="checkbox"/> | <input checked="" type="checkbox"/> | <input checked="" type="checkbox"/> | <input checked="" type="checkbox"/> |
| 7  | <input checked="" type="checkbox"/> | <input checked="" type="checkbox"/> | <input checked="" type="checkbox"/> | <input checked="" type="checkbox"/> | <input checked="" type="checkbox"/> | <input checked="" type="checkbox"/> |
| 8  | <input checked="" type="checkbox"/> | <input checked="" type="checkbox"/> | <input checked="" type="checkbox"/> | <input checked="" type="checkbox"/> | <input checked="" type="checkbox"/> | <input checked="" type="checkbox"/> |
| 9  | <input checked="" type="checkbox"/> | <input checked="" type="checkbox"/> | <input checked="" type="checkbox"/> | <input checked="" type="checkbox"/> | <input checked="" type="checkbox"/> | <input checked="" type="checkbox"/> |
| 10 | <input checked="" type="checkbox"/> | <input checked="" type="checkbox"/> | <input checked="" type="checkbox"/> | <input checked="" type="checkbox"/> | <input checked="" type="checkbox"/> | <input checked="" type="checkbox"/> |

Note: Use 'SpaceBar' to toggle check box

Buttons: Send, Receive, Range ON, Range OFF, View Changes, Alt Routing ON: , Close

## 11. RMS SYSTEM PROGRAMMING

**11.1** When you select **System Programming** the system-wide programming options appear. The following table lists the available options, with their allowed values and defaults, if applicable. Instructions for programming each option is given in the following pages.

**Table 5-4:** RMS System Programming Values and Timers

| SECTION                             | PROGRAMMING OPTION                                 | ALLOWED VALUES                                     | DEFAULT VALUE                               |
|-------------------------------------|----------------------------------------------------|----------------------------------------------------|---------------------------------------------|
| <b>System Settings</b><br>(page 37) | Weekend Service                                    |                                                    | Off                                         |
|                                     | Flashing hold LED                                  |                                                    | On                                          |
|                                     | Call Logging                                       | On or Off                                          | Off                                         |
|                                     | Store all calls                                    |                                                    |                                             |
|                                     | Doorphone fitted                                   |                                                    |                                             |
|                                     | System Voicebox On (Answering Machine)             |                                                    |                                             |
|                                     | 911 & Extension Sending                            |                                                    |                                             |
|                                     | Night Service                                      |                                                    |                                             |
|                                     | Night Service Time ON                              | HH:MM                                              | Not programmed                              |
|                                     | Night Service OFF                                  |                                                    |                                             |
|                                     | Music on hold                                      | Internal source, External source, Tone, or Silence | Internal source                             |
|                                     | Programming Position                               | Any Extension                                      | Extension 20                                |
|                                     | PA Position                                        |                                                    | Paging PA not equipped (0)                  |
|                                     | System Programming Password                        | XXXX                                               | 1111                                        |
|                                     | Set V24 Baud Rate                                  | 4800, 9600, 19200                                  | 19200                                       |
|                                     | Courtesy Service Source                            | System or Voice Module                             | System (system if no voice module detected) |
|                                     | Sales Telephone Number                             | Your sales telephone number                        | Not programmed                              |
| Service Telephone Number            | Your service telephone number                      |                                                    |                                             |
| Message Capacity                    | Mail box message capacity from 10 – 50.            |                                                    |                                             |
| Group Divert to System Box          | Divert voice mail to system mail box (system wide) | Off                                                |                                             |
| <b>User Timers</b><br>(page 39)     | Timers:                                            |                                                    |                                             |
|                                     | Open the door                                      | 01 – 30 seconds                                    | 5 seconds                                   |
|                                     | Doorphone ring duration                            | 01 – 30 seconds                                    | 30 seconds                                  |
|                                     | Recall on hold                                     | 10 – 1800 seconds                                  | 90 seconds                                  |
|                                     | Forward on No Answer                               | 01 – 180 seconds                                   | 15 seconds                                  |
|                                     | Call Park                                          | 001 – 250 seconds                                  | 180 seconds                                 |
|                                     | Ringback time duration                             | 01 – 30 seconds                                    | 30 seconds                                  |
|                                     | Recall on transfer                                 | 001 – 180 seconds                                  | 90 seconds                                  |
|                                     | Courtesy Delay                                     | 01 – 30 seconds                                    | 30 seconds                                  |
|                                     | Auto Attendant Delay                               | 01 – 30                                            | 1 second                                    |
|                                     | Answering Machine Delay                            | 01 – 180 seconds                                   | 30 seconds                                  |
|                                     | VM Message Length                                  | 30 – 180 seconds                                   | 120 seconds                                 |

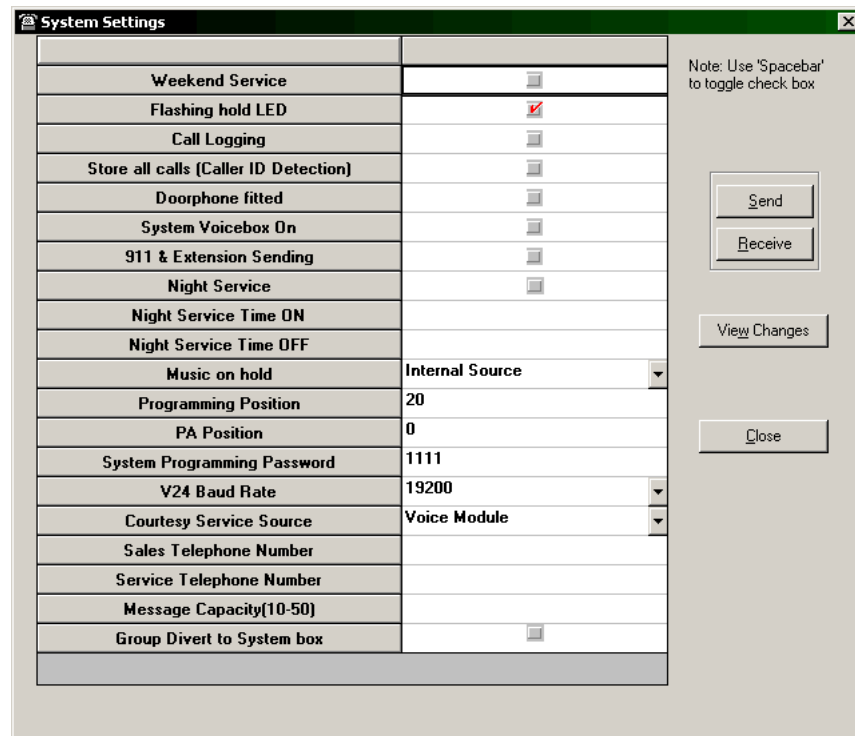

**Table 5-4: RMS System Programming Values and Timers (Continued)**

| SECTION                                                | PROGRAMMING OPTION                                                                    | ALLOWED VALUES       | DEFAULT VALUE  |
|--------------------------------------------------------|---------------------------------------------------------------------------------------|----------------------|----------------|
| <b>Exception &amp; Restriction Tables</b><br>(page 40) | Class Codes:                                                                          | 50 numbers per table | Not programmed |
|                                                        | Exception Table 5                                                                     |                      |                |
|                                                        | Restriction Table 6                                                                   |                      |                |
| <b>Program Caller ID Detection Number</b><br>(page 41) | Associate numbers with names and/or assign extensions                                 |                      |                |
| <b>System Speed Dial List</b><br>(page 42)             | Up to 200 numbers with names                                                          |                      |                |
| <b>System Date &amp; Time</b><br>(page 43)             | System date and time settings and receive from switch and transmit to switch settings | HH:MM MM/DD/YY       | 12:00 01/01/01 |

## A. SYSTEM SETTINGS

11.2 The System Settings screen is shown below.



11.3 For features that have on/off settings, place a check mark in the box to enable the feature or remove the check to disable it. For features that offer a choice of setting, scroll to the desired setting.

- **Weekend Service.** The Weekend Service feature ensures that if Night Service is invoked on a Friday evening, the system remains in Night Mode until Monday morning
- **Flashing hold LED.** When a call is placed on Hold, you can decide if the associated Line key light is to flash or remain steady on all other Keysets. The default setting is that the light flashes.

- **Call Logging.** If the system is equipped with a Call Logging Interface Module, a printer or PC may be connected, that will maintain a record of incoming and outgoing calls made on the system. Details are printed as the calls are completed. Call Logging is disabled by default on power up.
- **Store all calls (Caller ID Detection).** The system Caller ID Storage can capture either all calls or unanswered calls only. If this option is checked, it will capture all calls.
- **Doorphone fitted.** You can equip your Encore System with a Doorphone. The Doorphone has a button which, when pressed, rings at programmed extensions, and has a microphone/speaker for communication. With a Doorphone installed at your entrance area, anyone visiting your premises can call when they arrive and you can speak to them before you let them in.
- **System Voicebox On.** This service acts as an answering machine. It can be used answer incoming calls and record messages for selected lines. It can be enabled or disabled in this screen.
- **911 & Extension Sending.** This feature sends the extension number, that dialled 911, to the network. When this symbol ◆ is displayed, the System sends the extension digits to the network. If the symbol ◇ is displayed, the System *will not* send the digits to the network (default setting).
- **Night Service.** The Automatic Night Service feature allows you to set the times at which the system automatically enters Night Mode and when it reverts to Day Mode. (The operator also has the ability to manually turn on or off Night Mode.)
- **Night Service Time ON.** Specify the time to start Night Service.
- **Night Service Time OFF.** Specify the time to stop Night Service.
- **Music on hold.** When an external call is placed on hold, you can choose between supplying music, a tone or silence to the caller. The music source can be internal, in which case it is integrated in the system and cannot be changed, or external, in which case an external source must be connected to your system. Internal callers will always hear tones when on hold. While the system is in Day Mode, if both Music-On-Hold and Courtesy Service are programmed, the Courtesy Service message and music will be played in rotation to callers on hold. In Night Mode, the Courtesy Service message and hold tones will be played.

---

**NOTE:** In the previous operation of Auto Attendant, (where, if it was not available to answer) the call would be answered by internal courtesy source, as a back-up; this is no longer applicable. If the Courtesy Service is programmed to use the internal source, the music-on-hold option is automatically set to the internal source and cannot be changed to an external source. However, if the Courtesy Service is programmed to use the Voice Module, music-on-hold can use the external source.

---

- **Programming Position.** System programming can only be carried out at one Keypad (the Programming Extension). By default, extension 20 is the Programming Extension. The Programming Extension can be changed to any other extension if required.
- **PA Position.** Set the extension connected to the external paging equipment.
- **System Programming Password.** The default System Programming Password (1111) can be changed to any four-digit number.
- **V24 Baud Rate.** The V24 interface baud rate can be set to 4800, 9600 or 19200 bps for Call Logging.

- **Courtesy Service Source.** The system can be set to play a pre-recorded greeting (Internal option) or a customized greeting (Voice Module option).
- **Sales and Service Telephone Numbers.** If desired, you can program the telephone numbers for your Sales and/or Service personnel so that customers can easily call them.
- **Message Capacity.** You can change the mail box message capacity, from the default of 20 messages per mail box, to a higher or lower amount, depending on demand.
- **Group Divert to System Box.** Allows you to enable a divert incoming voice mail to the system mail box. This feature is available for incoming calls to groups with more than one extension (when a forward on no answer to the voice module is enabled on any of the phones in the group). The call is diverted to the system mail box instead of the individual's mail box. This is a system-wide flag.

**NOTE:** The Group Divert to System Box flag looks at the Incoming Ringing Groups options in RMS (page 5-28). The lowest number in the ringing group is not necessarily the first extension that is rang when a group divert to voice mail takes place. The call is diverted to the voice mail of the first station shown in the Incoming Ringing Groups table in RMS – not the number of the lowest station number in the table.

## B. USER TIMERS

11.4 The User Timers screen is shown below.

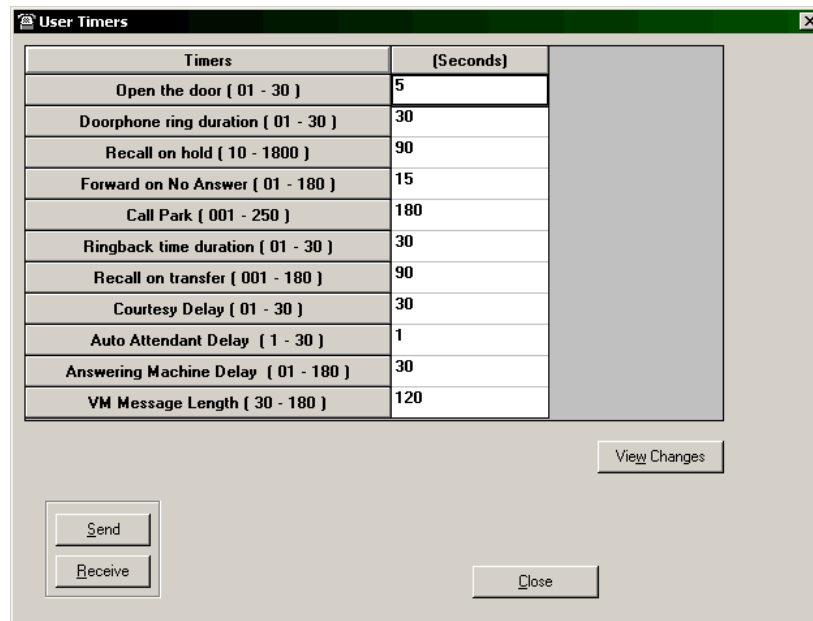

11.5 The following chart shows each timer with its purpose, range, and default value.

**Table 5-5:** RMS Programming User Timers

| TIMER                   | PURPOSE                                                                                                                    | RANGE     | DEFAULT    |
|-------------------------|----------------------------------------------------------------------------------------------------------------------------|-----------|------------|
| Open the door           | The amount of time the doorstrike relay will remain open following activation.                                             | 01 – 30   | 5 seconds  |
| Doorphone ring duration | The amount of time extensions will ring when a call is made from the Doorphone.                                            |           | 30 seconds |
| Recall on hold          | The time that elapses before a call, which has been placed on hold, rings back to the extension that put the call on hold. | 10 – 1800 | 90 seconds |

**Table 5-5:** RMS Programming User Timers (Continued)

| TIMER                   | PURPOSE                                                                                                                                                                                                             | RANGE     | DEFAULT     |
|-------------------------|---------------------------------------------------------------------------------------------------------------------------------------------------------------------------------------------------------------------|-----------|-------------|
| Forward on No Answer    | The time that elapses before a call ringing at an extension is forwarded when Forward on No Answer is set.                                                                                                          | 01 – 180  | 15 seconds  |
| Call Park               | The time that elapses before a call, which has been placed on Park, rings back to the extension that parked the call.                                                                                               | 001 – 250 | 180 seconds |
| Ringback time duration  | The amount of time an extension will ring when Ringback has been invoked.                                                                                                                                           | 01 – 30   | 30 seconds  |
| Recall on transfer      | The time that elapses before a call, which has been transferred and not answered, rings back to the extension that attempted the transfer.                                                                          | 001 – 180 | 90 seconds  |
| Courtesy Delay          | The time that elapses before an unanswered incoming call is sent to the Courtesy Service.                                                                                                                           | 01 – 30   | 30 seconds  |
| Auto Attendant Delay    | The time that elapses before an unanswered incoming call is sent to the Answering Machine or Automated Attendant greeting.                                                                                          |           | 01 second   |
| Answering Machine Delay | If the Answering Machine timer is less than five seconds (0 is not allowed), the group of extensions is rung for five seconds, then the answering machine starts (the timer is treated as if it were five seconds). | 01 – 180  | 30 seconds  |
| VM Message Length       | The amount of time allowed per voice-mail message. The confirm option only appears after you have entered a valid value.                                                                                            | 30 – 180  | 120 seconds |

### C. EXCEPTION AND RESTRICTION TABLES

**11.6** The Exceptions and Restriction Tables screen is shown below.

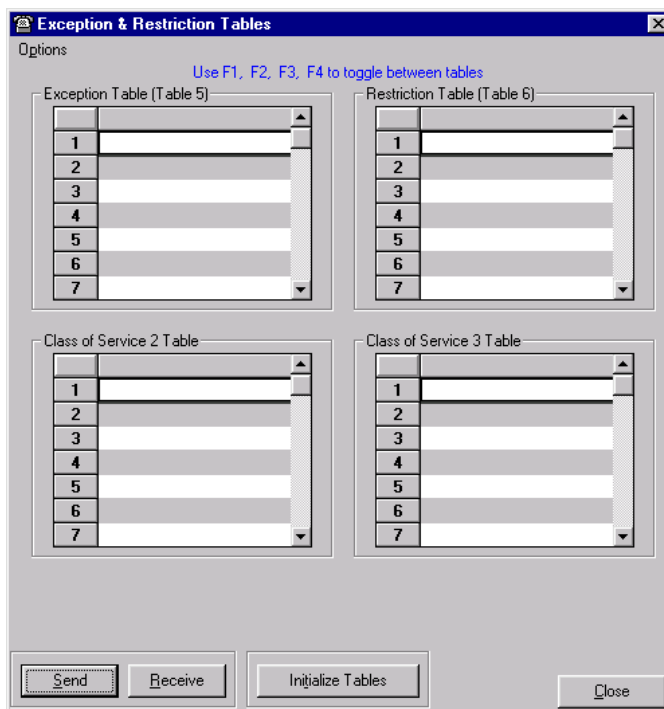

**11.7** As a means of controlling costs, each extension can be programmed for a toll restriction Class of Service. This screen allows you to define the numbers that will be restricted by the system and also permits the inclusion of exemption numbers which might otherwise be restricted or allowed by global class of service settings.

**11.8** The four Tables are numbered 2, 3, 5, and 6 to correspond with the associated Classes of Service. They can be programmed with up to 50 numbers each. Tables 2, 3, and 6 contain restricted numbers; Table 5 contains allowed numbers.

**11.9** A number can contain up to 13 digits. You can use a pound (#) in the code to indicate that any number of digits will follow (for example, 1# restricts all toll calls that begin with “1,” and 1800# restricts all calls beginning with “1-800”).

**11.10** The following chart summarizes the Classes of Service and the Tables that they use:

**Table 5-6:** *Classes of Service and Associated Tables*

| CLASS | TYPE OF RESTRICTION                                                       | TABLE                              |
|-------|---------------------------------------------------------------------------|------------------------------------|
| 1     | No restriction                                                            | N/A                                |
| 2     | Restrict codes in Table 2 (can be combined with Classes 5 and/or 6)       | Table 2 - Restricted Numbers       |
| 3     | Restrict codes in Table 2 and 3 (can be combined with Classes 5 and/or 6) | Tables 2 and 3 -Restricted Numbers |
| 4     | Internal and Emergency calls only                                         | N/A                                |
| 5     | Allow codes (can be combined with Classes 2, 3, and/or 6)                 | Table 5 - Allowed Numbers          |
| 6     | Restrict codes (can be combined Class 2, 3, and/or 5)                     | Table 6 - Restricted Numbers       |

#### D. PROGRAM CALLER ID DETECTION NUMBER

**11.11** The following screen allows specific incoming calls to be identified by their Caller ID and routed to specific extensions.

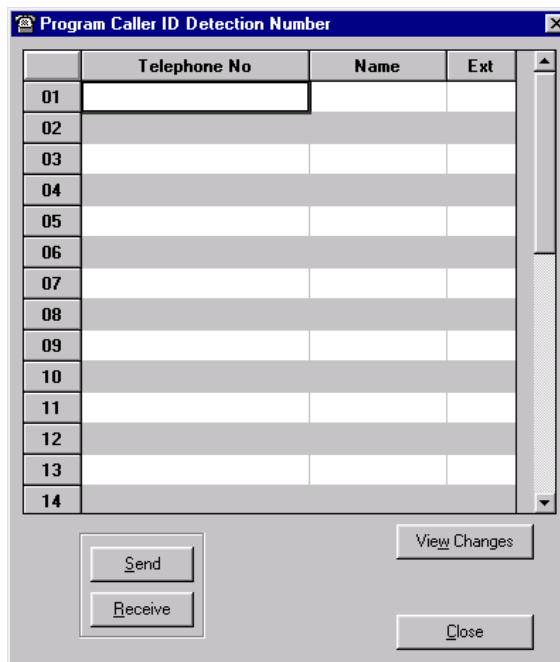

**11.12** Up to thirty names, each with a maximum of 10 characters (including spaces), may be associated with telephone numbers. When a Caller ID number with an associated name is received, the name rather than the number is displayed.

**11.13** In addition, an extension number may be associated with a Caller ID telephone number. In this case an incoming call from that number will ring at only that extension. If the extension

is busy and has Call Waiting Tones turned off, the call rings the incoming ringing group programmed for that line.

- **Telephone No.** Enter the telephone number as it will appear in the Caller ID, including the area code.
- **Name.** Enter an associated name of up to 10 characters.
- **Ext.** If you wish to associate the number with an extension, enter the desired extension number in this field.

## E. SYSTEM SPEED DIAL LIST

**11.14** The following screen allows you to add, delete, and edit the system speed dial numbers.

|     | Telephone No | Name |
|-----|--------------|------|
| 001 |              |      |
| 002 |              |      |
| 003 |              |      |
| 004 |              |      |
| 005 |              |      |
| 006 |              |      |
| 007 |              |      |
| 008 |              |      |
| 009 |              |      |
| 010 |              |      |
| 011 |              |      |
| 012 |              |      |

**11.15** You can program up to 200 system speed-dial numbers and names. Users of the system may then access these numbers, provided they are not restricted from dialing the number because of their Class of Service.

- **Telephone No.** Up to 24 digits may be stored in any location.
- **Name.** A name of up to ten characters, including spaces, can be used for each entry.
- **Goto Speed Dial.** To jump directly to a particular speed-dial number, enter the three-digit location code in the window and select the **Goto Speed Dial** button.

## F. SYSTEM DATE AND TIME

**11.16** Using the following screen, you can send the date and time from the Remote Management Software PC to the system or receive the information from the system.

**11.17 Computer Time Setting.** This shows the current time and date on your PC.

**11.18 Receive From Switch.** Select **Receive**. The date and time on the remote system is displayed.

**11.19 Transmit To Switch.** You can send the time and/or date, as follows.

- **Date.** Enter the date in MM/DD/YY format, (e.g., December 31 2001 as 12/31/01). Or select **Copy Local Date** to use your PC's date setting. Then select **Send**.
- **Time.** Enter the correct time in 24-hour format, (e.g., 2:00 PM as 14:00). Or select **Copy Local Time** to use your PC's time setting. Then select **Send**.

## 12. EXTENSIONS PROGRAM PLANNING SHEETS

**12.1** Program planning sheets are also provided at the end of the keyset programming chapter, beginning on page 4-32.

### Call Handling/Extension Names

| EXTENSION | NAME | CALL FORWARD TYPE/NO. | HOT LINE NO. | MANAGER (IF SECTY) |
|-----------|------|-----------------------|--------------|--------------------|
| 20        |      |                       |              |                    |
| 21        |      |                       |              |                    |
| 22        |      |                       |              |                    |
| 23        |      |                       |              |                    |
| 24        |      |                       |              |                    |
| 25        |      |                       |              |                    |
| 26        |      |                       |              |                    |
| 27        |      |                       |              |                    |
| 28        |      |                       |              |                    |
| 29        |      |                       |              |                    |
| 30        |      |                       |              |                    |
| 31        |      |                       |              |                    |
| 32        |      |                       |              |                    |
| 33        |      |                       |              |                    |
| 34        |      |                       |              |                    |
| 35        |      |                       |              |                    |
| 36        |      |                       |              |                    |
| 37        |      |                       |              |                    |



**Classes of Service/Pickup Groups**

| EXTENSION | CLASSES OF SERVICE/TABLES | PICKUP GROUP |
|-----------|---------------------------|--------------|
| 20        |                           |              |
| 21        |                           |              |
| 22        |                           |              |
| 23        |                           |              |
| 24        |                           |              |
| 25        |                           |              |
| 26        |                           |              |
| 27        |                           |              |
| 28        |                           |              |
| 29        |                           |              |
| 30        |                           |              |
| 31        |                           |              |
| 32        |                           |              |
| 33        |                           |              |
| 34        |                           |              |
| 35        |                           |              |
| 36        |                           |              |
| 37        |                           |              |

**Enabled/Disabled Features**

Indicate which extensions will have each of the features *enabled* by placing a check mark in the box.

| PROGRAMMING OPTION         | 20 | 21 | 22 | 23 | 24 | 25 | 26 | 27 | 28 | 29 | 30 | 31 | 32 | 33 | 34 | 35 | 36 | 37 |
|----------------------------|----|----|----|----|----|----|----|----|----|----|----|----|----|----|----|----|----|----|
| Tone Protect               |    |    |    |    |    |    |    |    |    |    |    |    |    |    |    |    |    |    |
| Page Protection            |    |    |    |    |    |    |    |    |    |    |    |    |    |    |    |    |    |    |
| General Call Protection    |    |    |    |    |    |    |    |    |    |    |    |    |    |    |    |    |    |    |
| Extension Disconnect       |    |    |    |    |    |    |    |    |    |    |    |    |    |    |    |    |    |    |
| No Call Logging            |    |    |    |    |    |    |    |    |    |    |    |    |    |    |    |    |    |    |
| No Trunk-to-Trunk Calls    |    |    |    |    |    |    |    |    |    |    |    |    |    |    |    |    |    |    |
| Personal Caller ID List    |    |    |    |    |    |    |    |    |    |    |    |    |    |    |    |    |    |    |
| Voice Messaging            |    |    |    |    |    |    |    |    |    |    |    |    |    |    |    |    |    |    |
| System Speed Dial Override |    |    |    |    |    |    |    |    |    |    |    |    |    |    |    |    |    |    |
| Restrict Use Of PA         |    |    |    |    |    |    |    |    |    |    |    |    |    |    |    |    |    |    |
| Door Restrict              |    |    |    |    |    |    |    |    |    |    |    |    |    |    |    |    |    |    |
| Voice Mail Password        |    |    |    |    |    |    |    |    |    |    |    |    |    |    |    |    |    |    |
| Reminder Call              |    |    |    |    |    |    |    |    |    |    |    |    |    |    |    |    |    |    |
| Extension Lock Code        |    |    |    |    |    |    |    |    |    |    |    |    |    |    |    |    |    |    |
| Voice Message Ports        |    |    |    |    |    |    |    |    |    |    |    |    |    |    |    |    |    |    |
| Language                   |    |    |    |    |    |    |    |    |    |    |    |    |    |    |    |    |    |    |

### Personal Speed Dial Numbers

Make a copy of this chart for each extension.

| LOCATION | NUMBER | NAME |
|----------|--------|------|
| 1        |        |      |
| 2        |        |      |
| 3        |        |      |
| 4        |        |      |
| 5        |        |      |
| 6        |        |      |
| 7        |        |      |
| 8        |        |      |
| 9        |        |      |
| 10       |        |      |
| 11       |        |      |
| 12       |        |      |

### Programmable Keys

Make a copy of this chart for each extension.

| LOCATION | FUNCTION | DIGITS (IF NEEDED) |
|----------|----------|--------------------|
| 1        |          |                    |
| 2        |          |                    |
| 3        |          |                    |
| 4        |          |                    |
| 5        |          |                    |
| 6        |          |                    |
| 7        |          |                    |
| 8        |          |                    |

### 13. TRUNK PROGRAM PLANNING SHEETS

#### Extensions with Incoming Ringing

##### Day Mode

|        | 20 | 21 | 22 | 23 | 24 | 25 | 26 | 27 | 28 | 29 | 30 | 31 | 32 | 33 | 34 | 35 | 36 | 37 | Central Bell |
|--------|----|----|----|----|----|----|----|----|----|----|----|----|----|----|----|----|----|----|--------------|
| Line 1 |    |    |    |    |    |    |    |    |    |    |    |    |    |    |    |    |    |    |              |
| Line 2 |    |    |    |    |    |    |    |    |    |    |    |    |    |    |    |    |    |    |              |
| Line 3 |    |    |    |    |    |    |    |    |    |    |    |    |    |    |    |    |    |    |              |
| Line 4 |    |    |    |    |    |    |    |    |    |    |    |    |    |    |    |    |    |    |              |
| Line 5 |    |    |    |    |    |    |    |    |    |    |    |    |    |    |    |    |    |    |              |
| Line 6 |    |    |    |    |    |    |    |    |    |    |    |    |    |    |    |    |    |    |              |
| Line 7 |    |    |    |    |    |    |    |    |    |    |    |    |    |    |    |    |    |    |              |
| Line 8 |    |    |    |    |    |    |    |    |    |    |    |    |    |    |    |    |    |    |              |

##### Night Mode

|        | 20 | 21 | 22 | 23 | 24 | 25 | 26 | 27 | 28 | 29 | 30 | 31 | 32 | 33 | 34 | 35 | 36 | 37 | Central Bell |
|--------|----|----|----|----|----|----|----|----|----|----|----|----|----|----|----|----|----|----|--------------|
| Line 1 |    |    |    |    |    |    |    |    |    |    |    |    |    |    |    |    |    |    |              |
| Line 2 |    |    |    |    |    |    |    |    |    |    |    |    |    |    |    |    |    |    |              |
| Line 3 |    |    |    |    |    |    |    |    |    |    |    |    |    |    |    |    |    |    |              |
| Line 4 |    |    |    |    |    |    |    |    |    |    |    |    |    |    |    |    |    |    |              |
| Line 5 |    |    |    |    |    |    |    |    |    |    |    |    |    |    |    |    |    |    |              |
| Line 6 |    |    |    |    |    |    |    |    |    |    |    |    |    |    |    |    |    |    |              |
| Line 7 |    |    |    |    |    |    |    |    |    |    |    |    |    |    |    |    |    |    |              |
| Line 8 |    |    |    |    |    |    |    |    |    |    |    |    |    |    |    |    |    |    |              |

#### Extensions with Outgoing Line Restriction

|        | 20 | 21 | 22 | 23 | 24 | 25 | 26 | 27 | 28 | 29 | 30 | 31 | 32 | 33 | 34 | 35 | 36 | 37 |
|--------|----|----|----|----|----|----|----|----|----|----|----|----|----|----|----|----|----|----|
| Line 1 |    |    |    |    |    |    |    |    |    |    |    |    |    |    |    |    |    |    |
| Line 2 |    |    |    |    |    |    |    |    |    |    |    |    |    |    |    |    |    |    |
| Line 3 |    |    |    |    |    |    |    |    |    |    |    |    |    |    |    |    |    |    |
| Line 4 |    |    |    |    |    |    |    |    |    |    |    |    |    |    |    |    |    |    |
| Line 5 |    |    |    |    |    |    |    |    |    |    |    |    |    |    |    |    |    |    |
| Line 6 |    |    |    |    |    |    |    |    |    |    |    |    |    |    |    |    |    |    |
| Line 7 |    |    |    |    |    |    |    |    |    |    |    |    |    |    |    |    |    |    |
| Line 8 |    |    |    |    |    |    |    |    |    |    |    |    |    |    |    |    |    |    |

**PBX Lines**

| LINE GROUP | ACCESS DIGIT(S) | EXTENSION LENGTH |
|------------|-----------------|------------------|
| 1 (9)      |                 |                  |
| 2 (81)     |                 |                  |
| 3 (82)     |                 |                  |
| 4 (83)     |                 |                  |

**Line Settings**

|        | EQUIPPED? | INCOMING ONLY? | ANSWERING MACHINE? | COURTESY SERVICE? (DAY/NIGHT) | AUTO ATTENDANT? | OUTGOING GROUP # |
|--------|-----------|----------------|--------------------|-------------------------------|-----------------|------------------|
| Line 1 |           |                |                    |                               |                 |                  |
| Line 2 |           |                |                    |                               |                 |                  |
| Line 3 |           |                |                    |                               |                 |                  |
| Line 4 |           |                |                    |                               |                 |                  |
| Line 5 |           |                |                    |                               |                 |                  |
| Line 6 |           |                |                    |                               |                 |                  |
| Line 7 |           |                |                    |                               |                 |                  |
| Line 8 |           |                |                    |                               |                 |                  |

**Optional Settings**

|        | LOOP CALLING | CALLER ID DETECTION | TONE DIALING |
|--------|--------------|---------------------|--------------|
| Line 1 |              |                     |              |
| Line 2 |              |                     |              |
| Line 3 |              |                     |              |
| Line 4 |              |                     |              |
| Line 5 |              |                     |              |
| Line 6 |              |                     |              |
| Line 7 |              |                     |              |
| Line 8 |              |                     |              |

**Local Codes**

Enter up to 40 local codes.

|  |  |  |  |
|--|--|--|--|
|  |  |  |  |
|  |  |  |  |
|  |  |  |  |
|  |  |  |  |
|  |  |  |  |
|  |  |  |  |
|  |  |  |  |
|  |  |  |  |
|  |  |  |  |
|  |  |  |  |
|  |  |  |  |
|  |  |  |  |
|  |  |  |  |
|  |  |  |  |
|  |  |  |  |
|  |  |  |  |
|  |  |  |  |
|  |  |  |  |
|  |  |  |  |
|  |  |  |  |
|  |  |  |  |
|  |  |  |  |
|  |  |  |  |
|  |  |  |  |

**Hunt Groups**

|        | HUNT GROUP | EXTENSIONS |
|--------|------------|------------|
| Line 1 |            |            |
| Line 2 |            |            |
| Line 3 |            |            |
| Line 4 |            |            |
| Line 5 |            |            |
| Line 6 |            |            |
| Line 7 |            |            |
| Line 8 |            |            |

**Alternative Routing**

| DIGIT CODES | DIALED DIGITS | REPLACE DIGITS | EXCLUSIVE LINE? | LINE(S) |
|-------------|---------------|----------------|-----------------|---------|
| 1           |               |                |                 |         |
| 2           |               |                |                 |         |
| 3           |               |                |                 |         |
| 4           |               |                |                 |         |
| 5           |               |                |                 |         |
| 6           |               |                |                 |         |
| 7           |               |                |                 |         |
| 8           |               |                |                 |         |
| 9           |               |                |                 |         |
| 10          |               |                |                 |         |

## 14. SYSTEM PROGRAM PLANNING SHEETS

### System-Wide Features

| PROGRAMMING OPTION                     | ALLOWED VALUES                                             | PROGRAMMED VALUE |
|----------------------------------------|------------------------------------------------------------|------------------|
| Weekend Service                        | On or Off                                                  |                  |
| Flashing Hold LED                      |                                                            |                  |
| Call Logging                           |                                                            |                  |
| Store All Calls (Caller ID)            |                                                            |                  |
| Doorphone                              |                                                            |                  |
| System Voicebox (Answering Machine) On |                                                            |                  |
| 911 & Extension Sending                |                                                            |                  |
| Night Service                          |                                                            |                  |
| Night Service On and Off Times         | HH:MM (24-Hour format)                                     |                  |
| Music On Hold                          | Internal source, External source, Tone on hold, or Silence |                  |
| Programming Position                   | Any equipped extension                                     |                  |
| Paging Amplifier Position              | Any extension                                              |                  |
| System Programming Password            | Four digits                                                |                  |
| Set V24 Baud Rate                      | 4800, 9600, 19200                                          |                  |
| Courtesy Service Source                | Voice Module or Internal                                   |                  |
| Sales Telephone Number                 |                                                            |                  |
| Service Telephone Number               |                                                            |                  |
| Message Capacity                       | 10 – 50                                                    |                  |
| Group Divert to System Box             | On or Off                                                  |                  |

### User Timers

| TIMER                   | RANGE     | DEFAULT     | NEW VALUE |
|-------------------------|-----------|-------------|-----------|
| Open the door           | 01 – 30   | 5 seconds   |           |
| Doorphone ring duration |           | 30 seconds  |           |
| Recall on hold          | 10 – 1800 | 90 seconds  |           |
| Forward on No Answer    | 01 – 180  | 15 seconds  |           |
| Call Park               | 001 – 250 | 180 seconds |           |
| Ringback time duration  | 01 – 30   | 30 seconds  |           |
| Recall on transfer      | 001 – 180 | 90 seconds  |           |
| Courtesy Delay          | 01 – 30   | 30 seconds  |           |
| Auto Attendant Delay    |           | 01 second   |           |
| Answering Machine Delay | 01 – 180  | 30 seconds  |           |
| VM Message Length       | 30 – 180  | 120 seconds |           |

**Class of Service Tables**

**Table 2 - Restricted Numbers for Class of Service 2**

Enter up to 50 numbers.

|  |  |  |  |  |
|--|--|--|--|--|
|  |  |  |  |  |
|  |  |  |  |  |
|  |  |  |  |  |
|  |  |  |  |  |
|  |  |  |  |  |
|  |  |  |  |  |
|  |  |  |  |  |
|  |  |  |  |  |
|  |  |  |  |  |
|  |  |  |  |  |

**Table 3 - Restricted Numbers for Class of Service 3**

Enter up to 50 numbers.

|  |  |  |  |  |
|--|--|--|--|--|
|  |  |  |  |  |
|  |  |  |  |  |
|  |  |  |  |  |
|  |  |  |  |  |
|  |  |  |  |  |
|  |  |  |  |  |
|  |  |  |  |  |
|  |  |  |  |  |
|  |  |  |  |  |
|  |  |  |  |  |

**Table 5 - Restricted Numbers for Class of Service 5**

Enter up to 50 numbers.

|  |  |  |  |  |
|--|--|--|--|--|
|  |  |  |  |  |
|  |  |  |  |  |
|  |  |  |  |  |
|  |  |  |  |  |
|  |  |  |  |  |
|  |  |  |  |  |
|  |  |  |  |  |
|  |  |  |  |  |
|  |  |  |  |  |
|  |  |  |  |  |

**Table 6 - Restricted Numbers for Class of Service 6**

Enter up to 50 numbers.

|  |  |  |  |  |
|--|--|--|--|--|
|  |  |  |  |  |
|  |  |  |  |  |
|  |  |  |  |  |
|  |  |  |  |  |
|  |  |  |  |  |
|  |  |  |  |  |
|  |  |  |  |  |
|  |  |  |  |  |
|  |  |  |  |  |
|  |  |  |  |  |
|  |  |  |  |  |
|  |  |  |  |  |
|  |  |  |  |  |
|  |  |  |  |  |
|  |  |  |  |  |
|  |  |  |  |  |
|  |  |  |  |  |
|  |  |  |  |  |
|  |  |  |  |  |
|  |  |  |  |  |
|  |  |  |  |  |
|  |  |  |  |  |
|  |  |  |  |  |
|  |  |  |  |  |
|  |  |  |  |  |
|  |  |  |  |  |
|  |  |  |  |  |
|  |  |  |  |  |

**Caller ID Numbers with Names**

| <b>NUMBER</b> | <b>ASSOCIATED NAME</b> | <b>SEND TO EXTENSION</b> |
|---------------|------------------------|--------------------------|
|               |                        |                          |
|               |                        |                          |
|               |                        |                          |
|               |                        |                          |
|               |                        |                          |
|               |                        |                          |
|               |                        |                          |
|               |                        |                          |
|               |                        |                          |
|               |                        |                          |
|               |                        |                          |
|               |                        |                          |
|               |                        |                          |
|               |                        |                          |
|               |                        |                          |
|               |                        |                          |
|               |                        |                          |
|               |                        |                          |
|               |                        |                          |
|               |                        |                          |
|               |                        |                          |
|               |                        |                          |
|               |                        |                          |
|               |                        |                          |
|               |                        |                          |
|               |                        |                          |
|               |                        |                          |
|               |                        |                          |
|               |                        |                          |
|               |                        |                          |
|               |                        |                          |
|               |                        |                          |
|               |                        |                          |
|               |                        |                          |
|               |                        |                          |
|               |                        |                          |
|               |                        |                          |
|               |                        |                          |
|               |                        |                          |
|               |                        |                          |
|               |                        |                          |
|               |                        |                          |
|               |                        |                          |
|               |                        |                          |
|               |                        |                          |
|               |                        |                          |
|               |                        |                          |
|               |                        |                          |
|               |                        |                          |
|               |                        |                          |
|               |                        |                          |
|               |                        |                          |
|               |                        |                          |
|               |                        |                          |
|               |                        |                          |



**System Speed-Dial Numbers**

| DIAL | NUMBER | DIAL | NUMBER | DIAL | NUMBER | DIAL | NUMBER | DIAL | NUMBER |
|------|--------|------|--------|------|--------|------|--------|------|--------|
| 7001 |        | 7041 |        | 7081 |        | 7121 |        | 7161 |        |
| 7002 |        | 7042 |        | 7082 |        | 7122 |        | 7162 |        |
| 7003 |        | 7043 |        | 7083 |        | 7123 |        | 7163 |        |
| 7004 |        | 7044 |        | 7084 |        | 7124 |        | 7164 |        |
| 7005 |        | 7045 |        | 7085 |        | 7125 |        | 7165 |        |
| 7006 |        | 7046 |        | 7086 |        | 7126 |        | 7166 |        |
| 7007 |        | 7047 |        | 7087 |        | 7127 |        | 7167 |        |
| 7008 |        | 7048 |        | 7088 |        | 7128 |        | 7168 |        |
| 7009 |        | 7049 |        | 7089 |        | 7129 |        | 7169 |        |
| 7010 |        | 7050 |        | 7090 |        | 7130 |        | 7170 |        |
| 7011 |        | 7051 |        | 7091 |        | 7131 |        | 7171 |        |
| 7012 |        | 7052 |        | 7092 |        | 7132 |        | 7172 |        |
| 7013 |        | 7053 |        | 7093 |        | 7133 |        | 7173 |        |
| 7014 |        | 7054 |        | 7094 |        | 7134 |        | 7174 |        |
| 7015 |        | 7055 |        | 7095 |        | 7135 |        | 7175 |        |
| 7016 |        | 7056 |        | 7096 |        | 7136 |        | 7176 |        |
| 7017 |        | 7057 |        | 7097 |        | 7137 |        | 7177 |        |
| 7018 |        | 7058 |        | 7098 |        | 7138 |        | 7178 |        |
| 7019 |        | 7059 |        | 7099 |        | 7139 |        | 7179 |        |
| 7020 |        | 7060 |        | 7100 |        | 7140 |        | 7180 |        |
| 7021 |        | 7061 |        | 7101 |        | 7141 |        | 7181 |        |
| 7022 |        | 7062 |        | 7102 |        | 7142 |        | 7182 |        |
| 7023 |        | 7063 |        | 7103 |        | 7143 |        | 7183 |        |
| 7024 |        | 7064 |        | 7104 |        | 7144 |        | 7184 |        |
| 7025 |        | 7065 |        | 7105 |        | 7145 |        | 7185 |        |
| 7026 |        | 7066 |        | 7106 |        | 7146 |        | 7186 |        |
| 7027 |        | 7067 |        | 7107 |        | 7147 |        | 7187 |        |
| 7028 |        | 7068 |        | 7108 |        | 7148 |        | 7188 |        |
| 7029 |        | 7069 |        | 7109 |        | 7149 |        | 7189 |        |
| 7030 |        | 7070 |        | 7110 |        | 7150 |        | 7190 |        |
| 7031 |        | 7071 |        | 7111 |        | 7151 |        | 7191 |        |
| 7032 |        | 7072 |        | 7112 |        | 7152 |        | 7192 |        |
| 7033 |        | 7073 |        | 7113 |        | 7153 |        | 7193 |        |
| 7034 |        | 7074 |        | 7114 |        | 7154 |        | 7194 |        |
| 7035 |        | 7075 |        | 7115 |        | 7155 |        | 7195 |        |
| 7036 |        | 7076 |        | 7116 |        | 7156 |        | 7196 |        |
| 7037 |        | 7077 |        | 7117 |        | 7157 |        | 7197 |        |
| 7038 |        | 7078 |        | 7118 |        | 7158 |        | 7198 |        |
| 7039 |        | 7079 |        | 7119 |        | 7159 |        | 7199 |        |
| 7040 |        | 7080 |        | 7120 |        | 7160 |        | 7200 |        |



# RMS Maintenance

| <i>CONTENTS</i>                        | <i>PAGE</i> |
|----------------------------------------|-------------|
| <b>1. Introduction</b> .....           | <b>6-2</b>  |
| <b>2. Cross Point Images</b> .....     | <b>6-3</b>  |
| A. Extension Crosspoint Maps .....     | 6-3         |
| B. Line Crosspoint Map .....           | 6-4         |
| <b>3. Call Statistics</b> .....        | <b>6-5</b>  |
| A. Lines .....                         | 6-5         |
| B. Extensions .....                    | 6-5         |
| <b>4. Software States</b> .....        | <b>6-6</b>  |
| A. Lines .....                         | 6-6         |
| B. Extensions .....                    | 6-6         |
| <b>5. System Phone Monitor</b> .....   | <b>6-7</b>  |
| <b>6. Trace</b> .....                  | <b>6-8</b>  |
| <b>7. System Reset</b> .....           | <b>6-9</b>  |
| <b>8. System Tests</b> .....           | <b>6-10</b> |
| A. Initiate System Tests .....         | 6-10        |
| B. Read System Tests .....             | 6-10        |
| <b>9. Pro-Active Maintenance</b> ..... | <b>6-11</b> |
| <b>10. System Timers</b> .....         | <b>6-13</b> |

## 1. INTRODUCTION

**1.1** This chapter describes the Diagnostics, Pro-Active Maintenance, and System Timers portions of the Remote Management Software.

**1.2** The **Diagnostics** drop-down menu, which is only available in Real Time mode, includes the following options:

- Allows you to see system activity using Extension and Line Cross Point Images, System Phone Monitor, and Trace
- Shows usage and statistics in Call Statistics and Software States
- Allows you to reset the system (System Reset) and run system tests (Initiate System Tests and Read Test Results)

**1.3** **Proactive Maintenance** allows you to:

- Program Service Center Numbers and Dial-up Center Numbers
- Set up Alarm Report Time, Alarm Threshold, Line Reseize and Confidence Calls
- Assign a Customer ID

**1.4** System Timers are preset and should not need to be adjusted. However, if necessary you can adjust them using the System Timers screen.

## 2. CROSS POINT IMAGES

**2.1** The cross points are the main switching mechanism in the system. All calls and system speech paths are routed through the system cross points. This diagnostic tool is used to verify connections through the system and can be used to debug crosstalk problems and internal switching failures.

### To access cross point images:

1. From the Diagnostics drop-down menu in the Real Time tab, select Extension and Line Cross Point Images.

When you select **Receive Cross Point Data** in either of the following windows, the Remote Management Software will begin polling the system. If it sees a crosspoint in use, it will show a red mark in the corresponding box.

2. To stop polling, select **Stop Receive**. To exit from the screen, select **Close**.

### A. EXTENSION CROSSPOINT MAPS

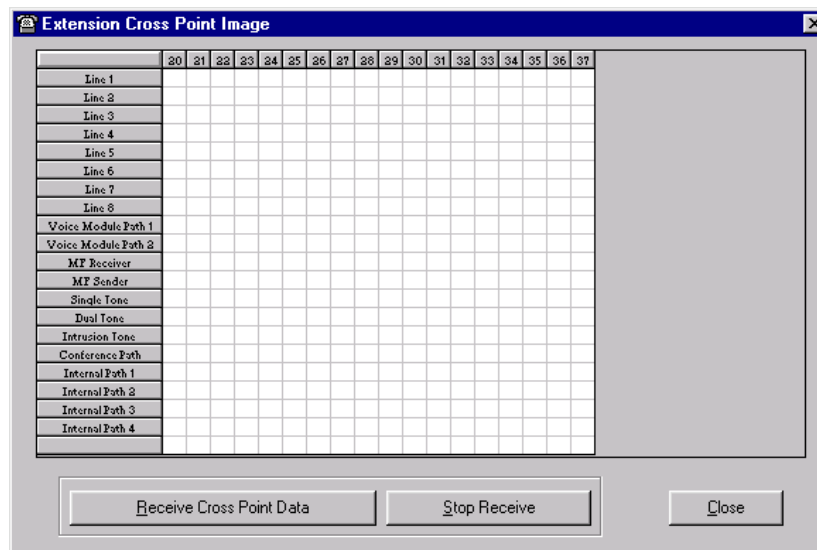

**2.2** The list on the left side of the Extension Cross Point Image window includes the following items:

- Lines 1 -8
- Voice Mail Paths 1 and 2 (valid only when a Voice Messaging Module is installed)
- MF (DTMF) Receiver
- MF (DTMF) Sender
- Single Tone
- Dual Tone
- Intrusion Tone
- Conference Path
- Internal Paths 1-4

**2.3** The available extensions are listed across the top of the window.

**NOTE:** An “internal path” is only in use when the call is connected (i.e., when 2 extensions are talking).

## B. LINE CROSSPOINT MAP

2.4 The Line Cross Point Image screen is shown below.

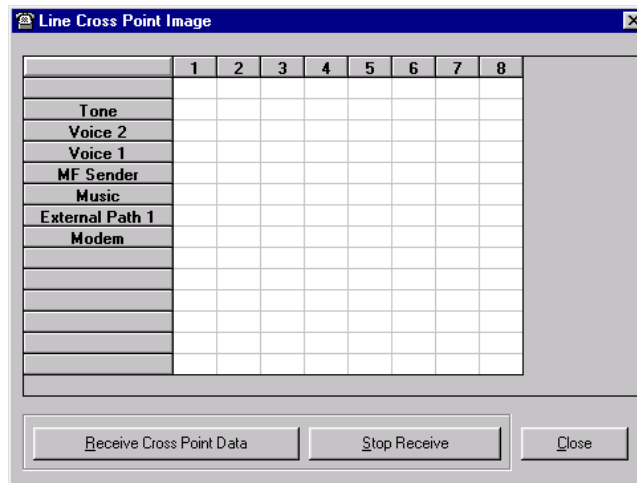

2.5 The following options are shown in the left column of the window:

- Tone
- Voice 1 and 2 (voice path)
- MF (DTMF) Sender
- Music
- External Path 1
- Modem

2.6 The available lines are listed across the top of the window.

### 3. CALL STATISTICS

3.1 When Call Statistics is selected, a matrix of the number of calls made, received, and answered is displayed. The screen has two tabs for Lines and Extensions. Statistics are shown for the period since they were last cleared.

#### A. LINES

3.2 The **Lines** tab lists all available lines and the categories for Incoming, Answered, and Outgoing Calls. When you select **Receive**, the Remote Management Software updates the statistics with information from the system. To clear the statistics, select the **Clear** button.

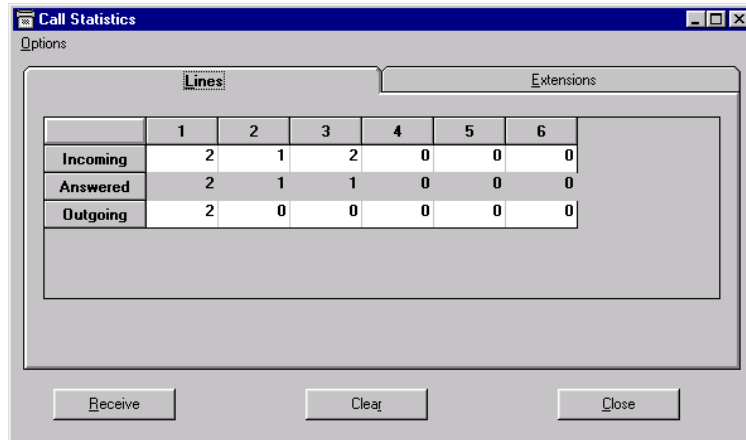

#### B. EXTENSIONS

3.3 The **Extensions** tab lists all available extensions and the categories for Incoming, Answered, and Outgoing Calls. When you select **Receive**, the Remote Management Software updates the statistics with information from the system. To clear the statistics, select the **Clear** button.

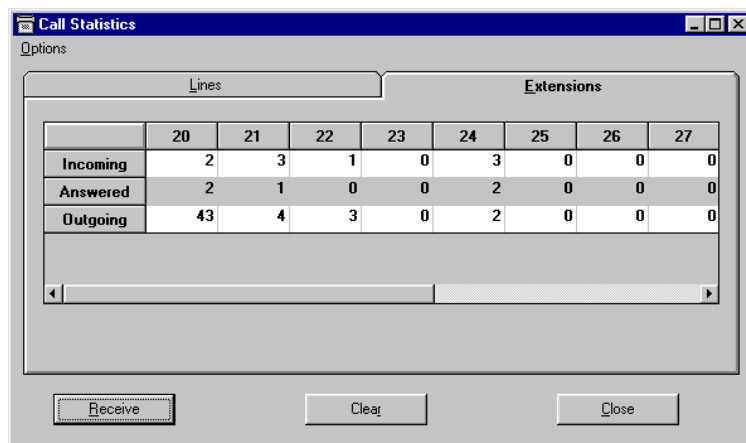

## 4. SOFTWARE STATES

4.1 The Software States screen allows you to verify the operating conditions on Lines and Extensions. The screen provides two tabs: Lines and Extensions. When you select **Receive**, the Remote Management Software begins polling the system for the line or extension status information from the system. To end polling, select **Stop**. To exit, select **Close**.

### A. LINES

4.2 The **Lines** tab lists available lines and whether they are in the Available or Busy state.

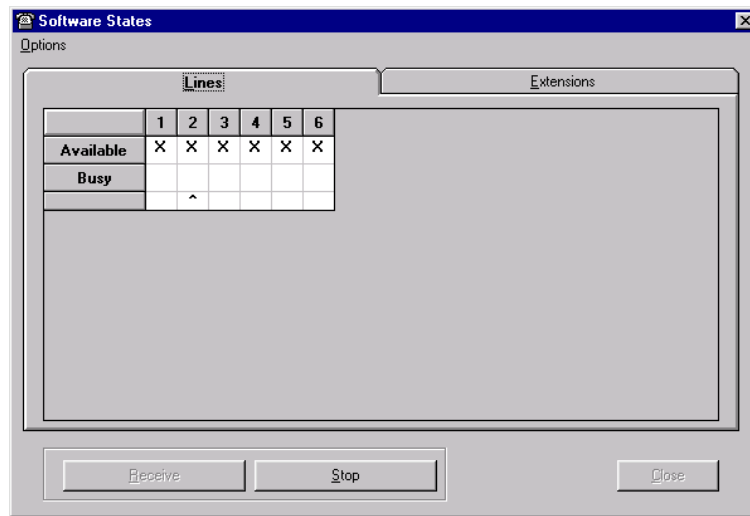

### B. EXTENSIONS

4.3 The **Extensions** tab lists all available extensions and the following states:

- No State (unequipped)
- Initial
- Reserved
- Idle
- Ringing
- Busy
- Established
- Other

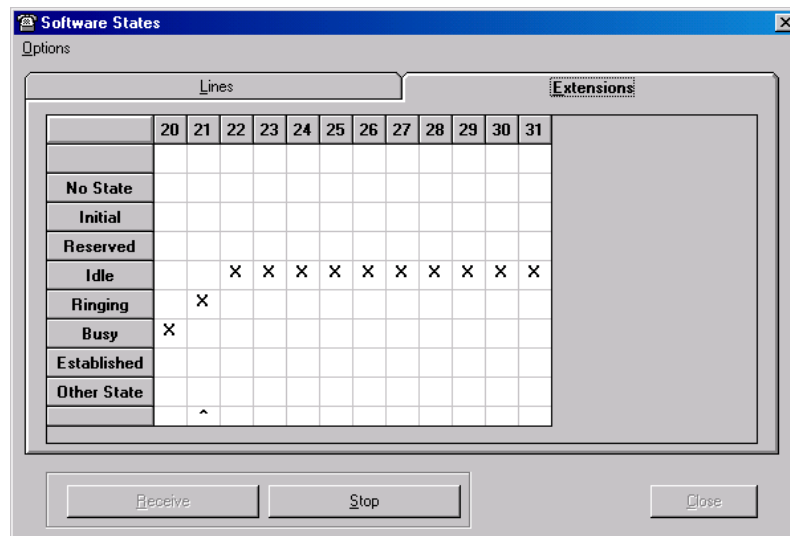



## 5. SYSTEM PHONE MONITOR

5.1 The System Phone Monitor screen is shown below.

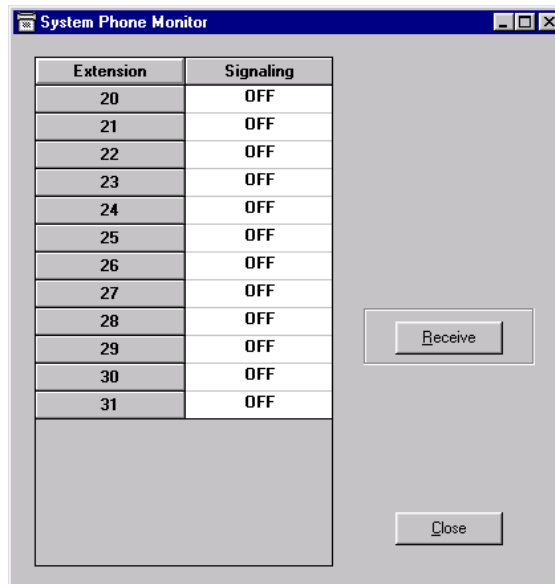

5.2 When System Phone Monitor is selected, an extension list is displayed with a second column called "Signaling" that indicates which connections have a Keypad that is communicating with the KSU. Every time you select **Receive**, the Remote Management Software checks the system and updates the information (the information will not change until you click on **Receive** again).

- If four-wire Keypad signaling is detected at the extension, ON is displayed in the second column.
- If two-wire single-line phone signaling is detected, OFF is shown.

## 6. TRACE

6.1 The Trace screen is shown below.

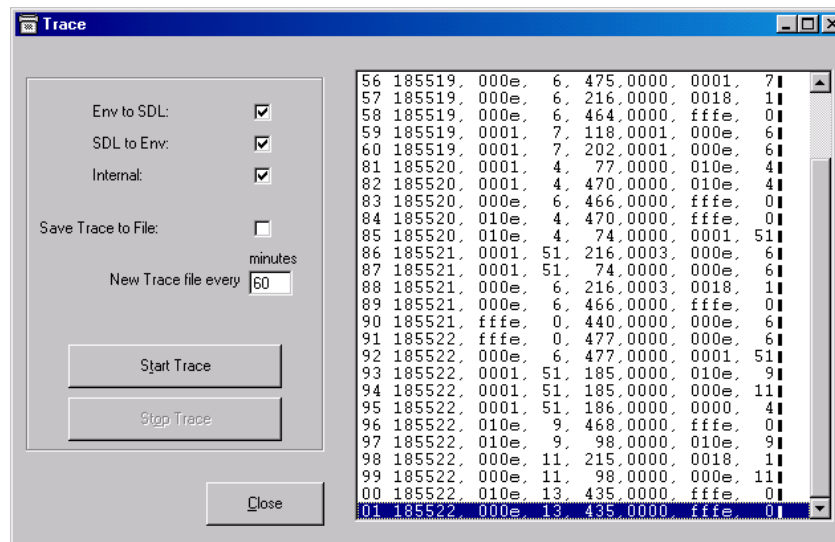

6.2 A trace allows the system to output information on how the software is operating. The system outputs its status as a trace record. This record shows the system status and allow diagnostics to be carried out. These traces are normally requested by Inter-Tel in the event of problem occurring within the system or with the environment in which it is operating. Inter-Tel personnel have access to the utility that is required for interpreting these traces.

6.3 When you select Trace, you must first choose the types of traces you want to perform, then you select **Start Trace**.

6.4 There are types of trace, Env to SDL, SDL to Env and internal. These options allow output traces to indicate how the software is interacting with the system during call handling and signaling.

6.5 You can save the trace information to a file by selecting **Save Trace To File**.

## 7. SYSTEM RESET

### CAUTION

Possible Data Loss Hazard. There are two system reset options available – **Warm** resets the system and cuts off all established calls and **Cold** resets the system, cuts off all established calls *and removes all programming from the system*. These are complete system resets, not individual extension resets. They should be used with extreme care, preferably only as directed by your service consultant.

#### To perform a system reset:

1. In RealTime mode, select Diagnostics > **System Reset**.
2. If necessary, select either the **Warm** or **Cold** reset button.



**NOTE:** After resetting the system to default, please wait about 10 seconds before entering System Programming to configure Extension Voice Boxes.

## 8. SYSTEM TESTS

**8.1** Using Remote Management Software, the system can be instructed to carry out a self-test with a delay of 1-60 minutes. The results of the test can be read when complete.

**8.2** The self-test checks the DTMF receivers and sender, dial-tone detector, CO Line seizing, and Caller ID detectors. If all three DTMF receivers fail to detect DTMF then the DTMF Sender is deemed faulty. If the dial-tone detector fails then line fault counters are reset to zero.

### A. INITIATE SYSTEM TESTS

**8.3** When you select Initiate System Tests, the following screen appears.

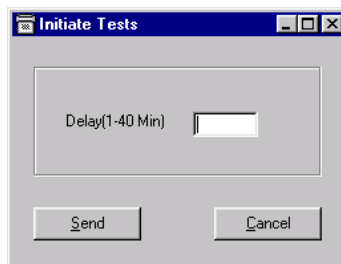

**8.4** Enter the **Delay** in minutes (1-40) and then select **Send** to close the connection between your PC and the System and begin the test. The delay allows you to alert system users to the upcoming test or to arrange specific conditions to be enabled on the system. When the delay expires, the system will perform its test. This test causes the Keyset line LEDs to flash in sequence.

### B. READ SYSTEM TESTS

**8.5** After a System Test has been completed, select Read System Tests to see the results. The following screen appears, showing which components passed or failed.

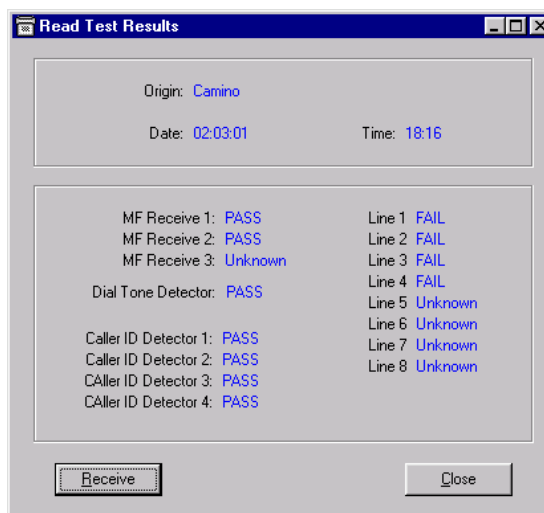

## 9. PRO-ACTIVE MAINTENANCE

### 9.1 Encores Proactive Maintenance involves:

- **Automatic fault detection.** During normal operation, Encore monitors for line faults. If a fault is detected (e.g. dial-tone not detected) then a fault counter is increased for that line. However, one successful operation of a line resets the fault counter for that line. Should the fault counter on any one line exceed a pre-programmed alarm threshold, the fault is automatically reported in an Alarm call.
- **Scheduled alarm self-test.** In addition to the above, Encore may be configured to carry out a self-test once each day at a pre-programmed time. After such a test, results are analyzed and, if a fault is detected, an alarm call is made.
- **Alarm call.** A fault-free line is seized and one of the pre-programmed Dial Up Numbers is dialed. If answered within 30 seconds, the system modem is configured to establish a connection. When connection is established with the Remote Management Software PC at the Service Center, Encore sends its alarm report. When the report is complete, the Encore will release the line. If a connection is not established within 30 seconds or if the line is released before the Encore has completed its transmission, then the call will be re-attempted at a later pre-programmed time. The alarm report consists of header (Encore), information describing the system, a fault history with description and time, and date of each fault. An Alarm report will look like this:

```
Encore
Software Revision NET USA 1.54/54
Main Board Revision 5522.09500-x
Extension Board Revision 5510.09500-x
PSTN Interface Board 5507.09500-x
Extension Board Revision 5510.09500-x
PSTN Interface Board 5507.09500-x
Voice Mail Board Revision 5519.09500-x
Customer ID 87654321
FAULT CALL:02
12 03:50 12:12:98
51 03:55 02:12:98
31 03:50 28:11:98
END OF TEXT
```

The alarm codes are defined as follows:

| ALARM NAME               | CODE | ALARM NAME             | CODE |
|--------------------------|------|------------------------|------|
| Layer 1 fault access 1   | 11   | Dial tone fault Line 5 | 35   |
| Layer 1 fault access 2   | 12   | Dial tone fault Line 6 | 36   |
| Layer 1 fault access 3   | 13   | Dial tone fault Line 7 | 37   |
| Layer 1 fault access 4   | 14   | Dial tone fault Line 8 | 38   |
| Layer 2 fault access 1   | 21   | MF Sender fault        | 40   |
| Layer 2 fault access 2   | 22   | MF Receiver 1 fault    | 51   |
| Layer 2 fault access 3   | 23   | MF Receiver 2 fault    | 52   |
| Layer 2 fault access 4   | 24   | MF Receiver 3 fault    | 53   |
| Dial tone detector fault | 30   | CID detector 1 fault   | 71   |
| Dial tone fault Line 1   | 31   | CID detector 2 fault   | 72   |
| Dial tone fault Line 2   | 32   | CID detector 3 fault   | 73   |
| Dial tone fault Line 3   | 33   | CID detector 4 fault   | 73   |
| Dial tone fault Line 4   | 34   | Dial tone fault Line 5 | 35   |

- **Confidence call.** A confidence call is made once every three months (January, April, July, and October) at the time and date scheduled in this screen. the call is placed as described for the Alarm call. The Confidence report consists of header (Encore), information describing the system, and the words “Confidence Call.” A Confidence report will look like this:

```
Encore
Software Revision NET USA 1.54/54
Main Board Revision 5522.09500-x
Extension Board Revision 5510.09500-x
PSTN Interface Board 5507.09500-x
Extension Board Revision 5510.09500-x
PSTN Interface Board 5507.09500-x
Voice Mail Board Revision 5519.09500-x
Customer ID 87654321
CONFIDENCE CALL:01
END OF TEXT
```

**9.2** When you select Pro-Active Maintenance, the screen shown on the next page provides access to the maintenance features. The programming can be done off line for transmission at a later date or programming can be done while connected to a system.

**9.3** Enter the information in the Pro-Active Maintenance screen as described below:

| Service Center Numbers |  |
|------------------------|--|
| 1                      |  |
| 2                      |  |
| 3                      |  |
| 4                      |  |

| Dial-up Center Numbers |  |
|------------------------|--|
| 1                      |  |
| 2                      |  |
| 3                      |  |
| 4                      |  |

Alarm Report Time [HHMM]  Alarm Threshold(1-99)

Line Reseize Time(5-60 Min)  Confidence Call Day(1-28)

Customer ID:

Note: All will be Sent or Received

- **Service Center Numbers.** If the Encore System being programmed is set up to recognize Caller ID, it will automatically transfer calls from these numbers to the system modem.
- **Dial Up Centers.** Numbers the Encore System dials when a fault is detected. These should be the numbers of service centers with Remote Management Software-equipped PCs that are ready to receive the calls. When an Alarm or Confidence call is placed by the system, it will try the number 1 on the list first. If that number is unavailable, it will try the other numbers in numerical order.
- **Alarm Report Time.** Enter a time in 24-hour clock format. This is the time at which the system automatically runs its system self-tests and sends an Alarm report to one of the programmed Dial Up Center numbers, if a fault is detected.

- **Alarm Threshold.** (from 1 - 99) determines how many times in succession a fault must be detected on a line before an Alarm report is generated. CO line interface faults and Caller ID faults are deemed to be line faults. Other faults such as DTMF Sender failure will initiate a call whenever they are detected.
- **Confidence Call Day.** Day of the month (1-28) that the system is to place a call to the Dial Up Number to report in that it is still operating.
- **Line Reseize Time.** Amount of time, in minutes, that determines how long the system waits before dialing the Dialup Number when an Alarm or Confidence call fails. Each of the programmed Dial Up Numbers is tried, in sequence. If all of the numbers are busy, the system waits again, for this amount of time, before attempting to redial the first number.
- **Customer ID.** Used to identify the system when it makes an Alarm or Confidence call to a Dial Up Number.

## 10. SYSTEM TIMERS

10.1 The System Timers screen is shown below.

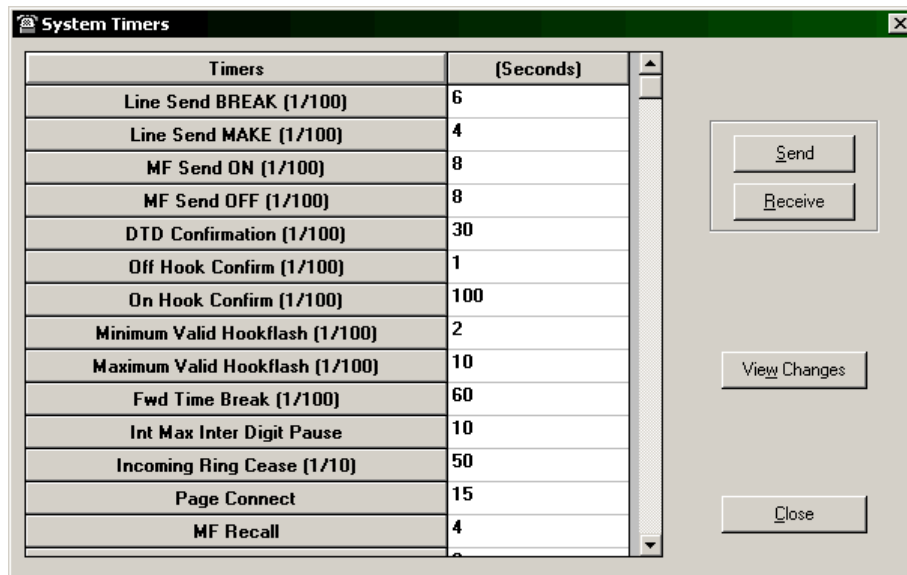

10.2 There are 22 timers in the Encore System that can be modified. Numbers shown in brackets (above) indicate that the time period is in a fraction of a second. Where no figure is shown, the time is programmed in seconds. The timers are defined in the following table.

Table 6-1: RMS Maintenance System Timers

| TIMER                    | DEFINITION                                                                                      | DEFAULT |
|--------------------------|-------------------------------------------------------------------------------------------------|---------|
| Line Send BREAK (1/100)  | Line "break" time when Pulse dialing is used on the line.                                       | 6       |
| Line Send MAKE (1/100)   | Line "make" time when Pulse dialing is used on the line.                                        | 4       |
| MF Send On (1/100)       | Length of time the DTMF tone is on when a digit is dialed.                                      | 8       |
| MF Send Off (1/100)      | Length of time the DTMF tone is off when a digit is dialed.                                     | 8       |
| DTD Confirmation (1/100) | Minimum length of time that dial tone must be detected.                                         | 30      |
| Off Hook Confirm (1/100) | Phone must be off hook for this amount of time for the system to recognize that it is off hook. | 1       |
| On Hook Confirm (1/100)  | Phone must be on hook for this amount of time for the system to recognize that it is on hook.   | 100     |

**Table 6-1: RMS Maintenance System Timers (Continued)**

| TIMER                                | DEFINITION                                                                                                                                                                                                                                                     | DEFAULT |
|--------------------------------------|----------------------------------------------------------------------------------------------------------------------------------------------------------------------------------------------------------------------------------------------------------------|---------|
| Minimum Valid Hookflash (1/100)      | Phone must be on hook for at least this amount of time for the system to recognize a hookflash.                                                                                                                                                                | 2       |
| Maximum Valid Hookflash (1/100)      | Maximum amount of time a phone can be on hook for the system to recognize a hookflash.                                                                                                                                                                         | 10      |
| Fwd Time Break (1/100)               | Break duration when timed break is the forward recall signal.                                                                                                                                                                                                  | 60      |
| Int Max Inter Digit Pause            | Amount of time between digits during dialing.                                                                                                                                                                                                                  | 10      |
| Incoming Ring Cease (1/10)           | When a ringing signal is not detected on a line for this amount of time, the call is considered to be disconnected.                                                                                                                                            | 50      |
| Page Connect                         | A user is allowed to speak over the external paging speakers for this length of time.                                                                                                                                                                          | 15      |
| MF Recall                            | Amount of time a DTMF receiver is made available to an extension after the user places a call on hold.                                                                                                                                                         | 4       |
| CID Display Date & Time              | Determines the amount of time the Caller ID date information is displayed.                                                                                                                                                                                     | 2       |
| Call Waiting Indication On/Off       | Amount of time a Call Waiting message is displayed.                                                                                                                                                                                                            | 1       |
| System Programming Duration          | Programming Extension returns to idle if inactive for this length of time.                                                                                                                                                                                     | 60      |
| Ext/Idle Display Refresh             | Idle display refresh frequency.                                                                                                                                                                                                                                | 5       |
| Dialing Pause                        | Used when the system is storing and redialing digits dialed from a single-line phone. If dialing starts before dial tone is detected, this is the amount of time allowed after the last digit has been dialed, before the line switches back to the extension. | 1       |
| External Call Timer (Minutes) (1/10) | Amount of time the system will supervise a line and check for disconnect on a trunk-to-trunk call. (Setting this timer to 0 disables line supervision.)                                                                                                        | 5       |
| Line Supervision (1/100)             | The signal length, the system is monitoring, to disconnect (time break) from the network.                                                                                                                                                                      | 60      |
| EPS on-hook Confirmation (1/100)     | Amount of time, after you place the handset on hook, that the system knows the call is completed and the system acknowledges the disconnect.                                                                                                                   | 10      |



# Troubleshooting

| CONTENTS                                                          | PAGE       |
|-------------------------------------------------------------------|------------|
| <b>1. Introduction</b> .....                                      | <b>2-2</b> |
| <b>2. Outgoing Calls</b> .....                                    | <b>2-2</b> |
| A. Cannot Make External Calls From An Extension .....             | 2-2        |
| B. Unable To Make Or Receive Calls During Power Failure .....     | 2-2        |
| C. No Dial Tone .....                                             | 2-2        |
| D. A Line Not Being Accessed For Outgoing Calls .....             | 2-2        |
| E. Cannot Obtain An Outside Line On A Single-Line Telephone ..... | 2-2        |
| <b>3. Incoming Calls</b> .....                                    | <b>2-3</b> |
| A. No Incoming External Calls Are Being Received .....            | 2-3        |
| B. No Incoming Calls .....                                        | 2-3        |
| <b>4. Internal Calls</b> .....                                    | <b>2-3</b> |
| <b>5. Keypad Features</b> .....                                   | <b>2-3</b> |
| A. Keypad Handsfree Mode Does Not Appear To Work .....            | 2-3        |
| B. Keypad Shows “Waiting for SYNC” .....                          | 2-3        |
| C. Keypad Display Shows Digits That Were Not Dialed .....         | 2-3        |
| <b>6. System Features</b> .....                                   | <b>2-4</b> |
| A. Night Service Unable To Operate .....                          | 2-4        |
| B. Cannot Program System Options .....                            | 2-4        |
| C. Calls Not Forwarded .....                                      | 2-4        |
| D. Feature Not Working .....                                      | 2-4        |
| <b>7. System, Line, or Extension Failure</b> .....                | <b>2-4</b> |
| <b>8. Replacing the CPU</b> .....                                 | <b>2-5</b> |
| <b>9. Power Supply Replacement</b> .....                          | <b>2-5</b> |
| <b>10. Customer Support</b> .....                                 | <b>2-6</b> |
| A. Technical Support .....                                        | 2-6        |
| B. Emergency Assistance .....                                     | 2-6        |
| C. Diagnostics .....                                              | 2-6        |
| <b>11. Defective Unit Return Policy</b> .....                     | <b>2-6</b> |

## 1. INTRODUCTION

**1.1** This section of the manual describes the troubleshooting information in the event of a system or station instrument malfunction. System repair is limited to replacing parts (keysets, circuit cards, cables, power supply, etc.).

## 2. OUTGOING CALLS

**2.1** This section details outgoing call issues.

### A. CANNOT MAKE EXTERNAL CALLS FROM AN EXTENSION

**2.2** Extension Lock may have been activated. To unlock the extension:

1. Lift the handset on the affected extension and enter the unlock code (**41**).
2. Then enter the extension's Extension Lock password (at default the password is 123). If necessary, Extension Lock passwords can be viewed from the Programming Extension (see [page 4-22](#)).

### B. UNABLE TO MAKE OR RECEIVE CALLS DURING POWER FAILURE

**2.3** The customer is not using the proper extension or is trying to use a Keyset. Power failure service is available on single-line sets at Extension 24 (Line 1), Extension 25 (Line 2), Extension 31 (Line 5), and Extension 37 (Line 7).

1. Locate a power failure extension.
2. Use a single-line set to make and receive calls.

### C. NO DIAL TONE

**2.4** The line may not be connected or programmed properly.

1. Check the line wiring and connection to the KSU.
2. Check that the extension has not been disconnected through programming. See [page 4-21](#) for procedure.

### D. A LINE NOT BEING ACCESSED FOR OUTGOING CALLS

**2.5** There may be a programming problem.

1. Check to see if the line has been programmed for incoming calls only. See [page 4-26](#) for procedure.
2. Check to see if the line has been disconnected in programming. See [page 4-21](#) for procedure.
3. If using a Line Key to access the line, check that the key is programmed for line access. See [page 3-14](#) for procedure.

### E. CANNOT OBTAIN AN OUTSIDE LINE ON A SINGLE-LINE TELEPHONE

**2.6** Extension Lock may have been activated. To unlock the extension:

1. Lift the handset on the affected extension and enter the unlock code (**41**).
2. Then enter the extension's Extension Lock password (at default the password is 123). If necessary, Extension Lock passwords can be viewed from the Programming Extension (see [page 4-22](#)).

### 3. INCOMING CALLS

3.1 This section details incoming call issues.

#### A. NO INCOMING EXTERNAL CALLS ARE BEING RECEIVED

3.2 This may be caused by programming or installation errors.

1. Check that the extension is programmed to ring. See [page 4-25](#) for procedure.
2. Check that the extensions has not been programmed for “Do Not Disturb.” See [page 3-40](#) for procedure.
3. Check that the Keypad is plugged in to the telephone socket.
4. Check that the Keypad is using the correct extension number.

#### B. NO INCOMING CALLS

3.3 Check that all extensions programmed to ring are not programmed for Do Not Disturb or Call Forward by resetting the extension. (Reset cancels call forwarding, reminder calls, and do not disturb settings.)

1. Lift the handset and enter the reset code (**157**).
2. Hang up.

### 4. INTERNAL CALLS

4.1 This section details internal call issues.

#### Cannot Contact A Particular Extension

4.2 Make sure Do Not Disturb or Call Forwarding are not set by resetting the extension. (Reset cancels call forwarding, reminder calls, and the do not disturb settings.)

1. Lift the handset and enter the reset code (**157**).
2. Hang up.

### 5. KEYPAD FEATURES

5.1 This section details keypad feature issues.

#### A. KEYPAD HANDSFREE MODE DOES NOT APPEAR TO WORK

5.2 The user may have programmed the Keypad for Headset use or may have Handsfree Mode disabled.

1. Press the **PROGRAM** key then select **Headset Mode** followed by **Headset Off**.
2. Press the **PROGRAM** key then select **Handsfree Answer** followed by **Set H/free Answer**.

#### B. KEYPAD SHOWS “WAITING FOR SYNC”

5.3 The extension is not properly terminated at the connector. See [page 2-9](#) for more information.

#### C. KEYPAD DISPLAY SHOWS DIGITS THAT WERE NOT DIALED

5.4 DTMF digits picked up by the speakerphone or the handset of a Keypad may be displayed. Also if another device (such as a butt set) is monitoring a line the Keypad is dialing on, the acoustic feedback loop may cause a single digit to be redialed many times. An analog speakerphone dialing close to a Keypad may also cause the Keypad to pick up the DTMF digits and display them. If this happens, avoid dialing in speakerphone mode if another source of DTMF is nearby.

## 6. SYSTEM FEATURES

**6.1** This section details system feature issues.

### A. NIGHT SERVICE UNABLE TO OPERATE

**6.2** The customer may be attempting to activate night service from wrong extension. Only extension 20 can activate or deactivate night service. See [page 3-44](#) for details.

### B. CANNOT PROGRAM SYSTEM OPTIONS

**6.3** Customer may be unable to carry out programming because they have forgotten or do not know the Programming password.

1. Try using the default password: 1111.
2. If this does not work, you must use the Remote Management Software to access the system to check and confirm the password with customer.

### C. CALLS NOT FORWARDED

**6.4** Calls will not forward if there is a problem with the destination station.

1. Make sure a forwarding destination has been programmed. See [page 3-34](#) for procedure.
2. Make sure the forwarding destination is not forwarded to another destination. If a forwarding chain has been set up (for example, Extension 20 forwards to Extension 21 which is forwarded to Extension 22, etc.) the forward only goes to first forwarding destination (Extension 21 in the example), but does not go to the other extensions because chained forwards are not recognized.

### D. FEATURE NOT WORKING

**6.5** It could be caused by user error, programming error, or extension programming.

1. Make sure the user is performing the steps correctly. Refer to the Features chapter ([page 3-1](#)) for procedures.
2. Check the system programming, and ensure the relevant feature is activated. See the Keypad Programming chapter ([page 4-1](#)) or the RMS Programming chapter ([page 5-1](#)) for procedures.
3. Reset the extension, as follows, then retry the feature:
  - a. Lift the handset and enter the reset code (**157**).
  - b. Hang up.

## 7. SYSTEM, LINE, OR EXTENSION FAILURE

**7.1** Follow these steps for overall system troubleshooting:

1. Check that the system is plugged in.
2. Carefully remove the KSU cover and see if the Vital Activity LED is flashing. (See [page 2-32](#).)
3. Check that all system expansion cards are properly installed in their connectors. (See [page 2-13](#).)
  - If the problem is with line access, replace the Line Card, reset the system, and retry.
  - If the problem is with a line or extension connection from an Extension Card, replace the Card, reset the system, and retry.
4. Check all CPU cabling connections. (See [page 2-7](#).)

## 8. REPLACING THE CPU

**8.1** Follow these steps when replacing a faulty CPU:

1. Record the system configuration and administration programming. (If you have Remote Management Software, save the database as a backup. Refer to [page 5-5](#) for information.)
2. Disconnect power from the system.
3. Disconnect the Power Supply connection.
4. Label all extension cabling (to aid in reattachment).
5. Disconnect the extension cables.
6. Unplug the Extension Cards, if installed.
7. Unscrew the retaining screws and remove the CPU board.
8. Insert the replacement CPU and the retaining screws.
9. Reinstall any Extension Cards.
10. Reconnect the extension cabling.
11. Reconnect the power.
12. Reprogram the system as required. (If you have Remote Management Software, you can upload the database. Refer to [page 5-5](#) for information.)

## 9. POWER SUPPLY REPLACEMENT

**9.1** The Power Supply Unit is located in the KSU. It connects directly to the CPU. Should it be necessary to replace the Power Supply Unit the procedure is as follows:

### CAUTION

Electric Shock Hazard. Electrical power must be disconnected before removing or installing the Power Supply Unit. Failure to remove the power source to the power supply could result in electric shock injury.

1. Unplug the system power cord.
2. Remove the Power Supply Unit cover.
3. Disconnect the power cord from the Power Supply Unit.
4. Disconnect the two Power Supply Unit connections from the CPU.
5. Unscrew the two retaining screws and lift out the Power Supply Unit.
6. Insert the new Power Supply Unit.
7. Replace the two retaining screws.
8. Reconnect the two Power Supply Unit connections to the CPU.
9. Reconnect the power cord to the Power Supply Unit.
10. Replace the Power Supply Unit cover.
11. Plug in the system power cord.

## 10. CUSTOMER SUPPORT

**10.1** Customer support is provided through Inter-tel Customer Support, after hours emergency assistance, and diagnosis through the Remote Management Software.

### A. TECHNICAL SUPPORT

**10.2** If problems persist when installing or servicing Inter-Tel equipment: While on site and with the proper troubleshooting tools available, certified technicians may contact Inter-Tel Customer Support Department for assistance. They can be reached from 7:00 A.M. to 5:00 P.M. Mountain Standard Time at 888-777-3279 (888-777-EASY).

**10.3** Endusers should contact the company that sold and now services their system.

### B. EMERGENCY ASSISTANCE

**10.4** After office hours and on weekends, call 480-961-0277 and leave your message with the voice mail service. A Customer Support Product Specialist will return your call as soon as possible, usually within an hour. Please remember that this is an emergency number for *critical system problems only*. Sales questions, equipment orders, etc., can only be handled during normal business hours.

### C. DIAGNOSTICS

**10.5** For advanced troubleshooting purposes, the Remote Management Software includes special diagnostics. If a problem cannot be resolved, Customer Support may instruct the technician to perform certain diagnostic procedures.

## 11. DEFECTIVE UNIT RETURN POLICY

**11.1** A fault report must be completed describing the fault in detail and attached to any equipment sent back for repair. For complete information on returning equipment, refer to the current Inter-Tel *Repair and Return Policy* (document part no. 835.1065). This document includes specific information on the following subjects: warranty, procedures to follow when returning equipment, equipment damaged in shipment, insurance, repair policy, and advance replacement policy.

# Replacement Parts

| <i>CONTENTS</i>             | <i>PAGE</i> |
|-----------------------------|-------------|
| 1. Introduction .....       | 8-2         |
| 2. Ordering Procedure ..... | 8-2         |
| 3. Basic Systems .....      | 8-2         |
| 4. Parts List .....         | 8-3         |

## 1. INTRODUCTION

1.1 This section provides the information necessary to order and stock replacement parts for the Inter-Tel Encore System.

## 2. ORDERING PROCEDURE

2.1 When ordering equipment for the Inter-Tel Encore System, provide the following information to the order processing clerk:

- Company name
- Purchase order number
- Required date of shipment
- Part number(s) of equipment ordered
- Quantity required

## 3. BASIC SYSTEMS

3.1 The following basic system packages are available:

| PACKAGE                    | PART NUMBER |
|----------------------------|-------------|
| Encore 2x6 with 4 Keysets  | 618.9001    |
| Encore 4x12 with 4 Keysets | 618.9002    |
| Encore 6x18 with 4 Keysets | 618.9003    |



## 4. PARTS LIST

4.1 The following table lists all available system components with their part numbers.

**Table 8-1:** *System Components and Related Part Numbers*

| ITEM                                                                  | MAX PER SYSTEM | PART NUMBER                      |
|-----------------------------------------------------------------------|----------------|----------------------------------|
| Line Card                                                             | 4              | 618.2100                         |
| Extension Card                                                        | 2              | 618.2200                         |
| Voice Module:<br>English Prompts<br>French Prompts<br>Spanish Prompts | 1              | 618.2310<br>618.2311<br>618.2312 |
| Courtesy Service Language Card:<br>English<br>French<br>Spanish       | 1              | 618.2500<br>618.2501<br>618.2502 |
| Encore Keypad                                                         | 18             | 618.4001                         |
| Doorphone                                                             | 1              | 618.3000                         |
| Call Logging Kit (v.24)                                               | 1              | 618.6001                         |
| Remote Management Software for Service Centers                        | As needed      | 827.9368                         |
| Spare CPU                                                             | As needed      | 618.2000                         |
| Spare Power Supply Unit                                               | As needed      | 618.0100                         |
| Installation, Programming, and Maintenance Manual                     | As needed      | 618.8000                         |
| User Guide                                                            | As needed      | 618.8002                         |
| Getting Started Guide                                                 | As needed      | 618.8014                         |
| Encore Training Kit                                                   | As needed      | 618.8006                         |



# Index

## Symbols

911, sending extension with 4-15

## A

### Access

- line 5-29
- PBX 5-30
- Access Groups 5-31
- Adapter 5-3
- Alarm Call 6-11
- Alarm Report Time 6-12
- Alarm Self-Test 6-11
- Alarm Threshold 6-13
- Alternative Call Routing 3-9, 4-29, 4-39
- Alternative Routing 5-34–5-35, 5-49
- Answering Machine 3-20, 3-45, 4-39, 5-31
  - lines 4-28
- Area Codes 5-32
- Automated Attendant 3-19, 4-30, 4-39, 5-31, 5-49
- Automatic Fault Detection 6-11

## B

Busy Signal 3-20

## C

### Cabling 2-7, 2-19

- connection to the KSU 2-19
- terminating at extension locations 2-9
- terminating at extensions 2-9

### Call

- alarm 6-11
- confidence 6-12
- loop 5-32
- protected from general 5-20
- reminder 5-21
- store all Caller ID 5-38
- Call Forward 3-33, 3-34
  - all calls 3-34
  - cancel 3-34
  - follow me 3-35
  - hunt group 3-46
  - to voice message box 3-19, 3-20
  - troubleshooting 7-4
- Call Handling 5-17
- Call Logging 2-31, 3-47, 4-21, 5-38
  - blocking 5-20
  - enable/disable 4-11
  - interface 2-31
  - interface speed 4-14
  - troubleshooting 4-21
- Call Park 3-30
- Call Pick-Up 3-29
- Call Processing Signals 2-10

- Call Restriction
  - line access 3-6
  - system speed dial override 4-20
- Call Statistics 6-5
- Call Transfer 3-32
- Call Waiting 3-31
  - tone protection 3-32
  - tones 3-31, 4-18

### Caller ID 3-7

- detection 4-31, 5-32, 5-38
  - number 5-41
  - programming 5-41
- displays 3-7
- names and routing 4-29
- numbers with names 4-40, 5-50
- personal list 5-20
- storage 3-8, 4-13, 4-20

### Calling

- speed dial 3-27

### Calls

- voice mail, transferring to 3-33

### Camp On 3-24

### Capacities 1-7

### Central Bell 2-30, 4-25

- ringing 4-25

### Class of Service 2-33, 3-6, 4-18, 4-36, 5-18, 5-44

- exceptions and restrictions 5-40–5-41
- overridden by system speed dial 5-20
- tables 4-13, 4-34

### CO Lines 2-22, 3-5, 4-31, 4-40

- cabling 2-7

### Cold Reset 6-9

### COM Port Setup 5-5

### Completing the Installation 2-32

### Conference 3-35

### Conference Calls 3-35

### Confidence Call 6-12, 6-13

### Configuration 5-6, 5-11

### Connection

- local 5-8
- setting up 5-8
- to the KSU 5-9

### Connectors 2-19

### Consultation 3-31

### Courtesy Service 3-18, 4-28, 4-39, 5-31

- greeting source and lines 4-28
- source 5-39

### CPU replacement 7-5

### Crosspoint Map 6-3

- extension 6-3
- line 6-4

### Customer ID 6-13

### Customer Support 7-6

### Customer Training 2-38

## D

### Database 5-5, 5-10

- reset to factory 5-5
- send 5-13

### Database Protection 3-10

### Date 4-7, 5-43

Day/Night Mode 3-5, 3-44  
Default Settings for Keys 5-24, 5-25  
Defective Unit Return Policy 7-6  
Deferred Mode 5-7  
Detection

- automatic fault 6-11
- program caller ID 5-41

Diagnostics 7-6  
Dial Tone 3-20  
Dial Up Centers 6-12  
Dial-Pulse Signaling 3-5  
Digit Codes 5-34  
Display 3-11

- language 3-14

Display Keys 3-12  
Display Messages 3-39  
Do Not Disturb 3-40  
Door Open 3-17  
Door Restrict 5-21  
Doorphone 2-27, 3-17, 4-13, 5-38

- calls 3-17

Doorstrike 2-28, 3-17, 4-19  
Download Flash 5-12  
Drop-Down Menus 5-5  
DTMF Tone Dialing 4-31

## E

---

Edit Keys 3-13  
Emergency Assistance 7-6  
Enabled/Disabled Features 5-45, 5-46  
Environment 2-4, 2-5  
Equipped Lines 4-26, 4-38, 5-31, 5-48  
Exceptions 5-19  
Expansion Card 2-13

- installation 2-13

Extension Card 1-4, 2-15  
Extension Lock 3-41  
Extension Numbers 3-4  
Extension Reset 3-42  
Extensions 2-23, 3-11, 5-19–5-21, 5-24, 6-5, 6-6

- cabling 2-7
- connections 2-23
- crosspoint maps 6-3
- disconnected 4-21, 5-20
- features 1-7
- incoming ringing 4-37, 5-47

Keysets 3-11  
lock code 5-21  
names 5-17  
numbers 3-4  
outgoing restrictions 4-38, 5-47  
programming 4-16–4-23, 5-16–5-26  
signals and tones 3-20  
troubleshooting 7-4  
user names 4-18  
Extension-To-Extension Calling 3-24  
External Music-On-Hold 2-29  
External Paging 4-13

## F

---

Factory Default Database 5-5  
Fault Detection 6-11  
FCC Regulations 1-xv  
Feature Codes 3-3–3-4  
Feature Key 5-24  
Feature Keys 3-3  
Feature Summary 1-6  
Features 1-6, 4-37

- enabled/disabled 5-45, 5-46
- system-wide 2-35, 4-32, 5-50
- troubleshooting 7-4

File Menu 5-5  
Flash Download 5-12  
Flashing Hold LED 5-37  
Flexible Incoming Ring Assignment 3-5  
Follow Me Forwarding 3-35  
Forward 3-33, 3-34

- all calls 3-34
- cancel 3-34
- follow me 3-35
- hunt group 3-46
- recall 3-39
- to voice message box 3-19, 3-20
- troubleshooting 7-4

Forwarding Options 5-17  
Function Keys 3-13

## G

---

General Call 3-25, 4-19  
General Call Protection 5-20  
Global Settings 5-31  
Greetings

- planning sheet, recording on 2-36, 4-35
- recording 3-21, 3-22
- system, recording 4-11

Grounding the KSU 2-16  
Groups

- hunt 5-33, 5-49
- outgoing access 5-31
- pickup 5-18, 5-19

## H

---

Handsfree 3-15

- enable/disable 3-23
- troubleshooting 7-3

Handsfree Key 3-15  
Hardware 1-4, 5-2  
Headset 2-25, 3-16  
Headsets 2-25  
Hold 3-30

- flashing LED 5-37
- music 5-38

Hookflash Over a CO Line 3-39  
Hot Line 5-17  
Hot Line Extension 3-17, 4-23  
Hunt Groups 3-46, 4-27, 4-39, 5-33, 5-49

- forwarding 3-46

## I

Incoming Access Only 5-31  
 Incoming Calls 7-3  
     ringing 4-25  
 Incoming Ringing 3-5, 4-37, 5-28, 5-47  
 Incoming-Only Lines 4-26, 4-38  
 Initiate System Tests 6-10  
 Installation  
     checklist 2-3  
     completing 2-32  
     planning 2-4  
 Intercom Calls 3-24, 3-37, 4-19  
 Internal Calls 3-23, 3-24, 7-3  
     placing 3-24  
     placing/receiving 3-24  
     receiving 3-24  
     troubleshooting 7-3  
 Internal Paging 3-36, 3-37  
 Intrude 3-44

## K

Key Confirmation 5-21  
 Key Service Unit (KSU) 1-4, 2-11  
     description 2-11  
     wall-mounting 2-18  
 Keypad 3-13  
 Keypad Edit Keys 3-13  
 Keys  
     feature 5-24  
     program 5-24  
     reset to default 5-24, 5-25  
 Keypad 1-5, 2-24, 3-11  
     adjusting 3-16  
     baseplate 2-25  
     connection 2-24  
     design features 2-24  
     display contrast 3-13  
     display language 3-14  
     extension programming 4-16–4-23  
     features 7-3  
         troubleshooting 7-3  
     handsfree 3-23, 7-3  
     handsfree enable/disable 3-23  
     installation 2-24  
     line programming 4-24–4-31  
     system programming 4-5–4-15  
     wall-mounting 2-25  
 KSU connection 5-9

## L

Language 3-14, 4-7, 5-21  
 LED for hold 5-37  
 Lightning Protection 2-16  
 Limited Warranty 1-xix  
 Line 5-24  
 Line Access 3-6  
     troubleshooting 7-2  
 Line Card 1-4, 2-14  
 Line Groups 4-39

Line Key 3-14  
     lights 4-10  
 Line Keys 3-14  
 Line Programming 4-24–4-31  
 Line Reseize Time 6-13  
 Lines 5-35, 6-5, 6-6  
     access 5-29  
     configuration 4-31, 4-40  
     connections 2-22  
     crosspoint map 6-4  
     dial pulse 3-5  
     equipped 5-31, 5-48  
     features 3-5  
     outgoing restrictions 4-38, 5-47  
     PBX 5-48  
     programming 5-27–5-35  
     settings 5-31–5-32  
     supervised 2-5, 3-5  
     troubleshooting 7-4  
 Liquid Crystal Display (LCD) 2-24, 3-11  
 Local Area Codes 4-14, 4-35, 5-32  
 Local Connection 5-8  
 Location 2-4  
 Lock Extension 3-41  
 Logging 5-20, 5-38  
 Long-Line Extension 2-26  
 Loop Calling 4-31, 5-32  
 Loop Resistance Tests 2-9

## M

Main Distribution Frame (MDF) 2-18, 2-19  
     layout 2-8  
 Main Screen 5-4  
 Maintenance 6-11  
 Manager/Secretary 3-43, 4-23  
 Material Return Authorization (MRA) 1-xix, 7-6  
 Menus  
     drop-down 5-5  
     file 5-5  
     options 5-5  
 Message Waiting Light 3-13  
 Messages 3-39  
     accessing 3-21  
     remote access 3-22  
     system voice mail, diverting to 4-15  
 Mode  
     deferred 5-7  
     real time 5-7, 5-8  
 MRA  
     see Material return authorization (MRA)  
 Music On Hold 5-38  
 Music-On-Hold 2-29, 3-23  
     option 4-10  
     source 4-10  
 Mute Key 3-15

## N

Names 2-33, 5-17, 5-44  
 Night Mode 3-5, 3-44, 4-9  
     troubleshooting 7-4

Night Service 5-38  
No Call Logging 5-20  
No Trunk-To-Trunk 5-20  
Numbers  
    Caller ID detection 5-41–5-42  
    equipped lines and telephone 5-48  
    personal speed dial 5-23  
    service center 6-12  
    system speed dial 5-42, 5-51

## O

Operation with a Parent PBX 3-9  
Operator Extension 3-44  
    feature codes 3-4  
Operator-Only Codes 3-4  
Optional Equipment 2-26  
Optional Settings 5-32  
Options Menu 5-5  
Ordering Procedure 8-2  
Outgoing Access Groups 5-31  
Outgoing Calls 7-2  
Outgoing Line Access 3-4, 3-6  
Outgoing Line Groups 3-5, 4-26  
Outgoing Line Restriction 4-25, 4-38, 5-47  
Outside Calls 3-26  
    header 3-25  
    placing 3-26  
    receiving 3-26  
    ring back 3-29  
    troubleshooting 7-2  
Override System Speed Dial 5-20

## P

Paging 3-36, 3-37, 4-13, 4-19  
    equipment 2-30  
    external 3-36, 3-37, 4-13  
        restriction 4-22  
    intercom calls 4-19  
    keysets 3-37  
    protected from 5-20  
    responding to 3-36  
    restricted use 5-21  
Paging Answer 3-36  
Paging Position 5-38  
Park 3-30  
Parts  
    list 8-2  
    ordering 8-2  
Parts List 8-3  
Password 3-42, 4-22, 5-21  
    changing 3-42  
    extension lock 3-42  
    system programming 4-7  
PBX 3-9, 3-39  
    access 4-27, 5-30  
    lines 4-39, 5-48  
    operation 3-9  
PC Requirements 5-2  
Personal Caller ID List 5-20

Personal Speed Dial  
    see Speed Dial  
Phone Monitor 6-7  
Phone Status 5-26  
Pick-Up Groups 4-20  
Pickup Groups 5-18–5-19  
Port Setup 5-5  
Port Swapping 4-22, 5-22  
Power Failure 2-10, 3-10  
    telephones 3-10  
    troubleshooting 7-2  
Power Supply 2-4  
    replacement 7-5  
Pre-Dial Mode 3-27  
Pro-Active Maintenance 6-11  
Programmable Keys 3-14  
Programming 2-31, 4-4  
    keys 5-24  
    line 5-27  
    real time 5-10  
    system 5-36  
    system timer 6-13  
Programming Extension 4-3, 4-8  
Programming Position 5-38  
Protection  
    from General Call 5-20  
    from Paging 5-20  
    from Tones 5-20

## R

Read System Tests 6-10  
Real Time Mode 5-7, 5-8, 5-10–5-14  
Recall  
    forward 3-39  
    tones 3-20  
    transfer 3-32  
Redialing 3-28  
Redirecting Ringing Calls 3-33  
Reminder Call 3-40, 5-21  
Remote Access 3-22  
Required Hardware 5-2  
Requirements for PC 5-2  
Reseize Time 6-13  
Reset  
    cold 6-9  
    database to default 5-5  
    keys to default 5-24–5-25  
    station 3-42  
    system 4-14, 6-9  
    warm 6-9  
Restrict Door 5-21  
Restrictions 5-19  
    outgoing line 5-47  
    paging 5-21  
Return Policy 7-6  
Ring Back 3-25, 3-29  
    extension 3-25  
    line 3-29  
Ring Signals 2-10  
Ring Tones 3-15

- Ringling 3-5, 4-37, 5-47
      - incoming 5-28, 5-47
      - tones 3-15
    - Ringling Call Light 3-13
    - RMS
      - connection, setting up 5-8
      - deferred mode 5-7
      - extensions, programming 5-16–5-26
        - call handling and extension name 5-17
        - class of service and pickup groups 5-18–5-19
        - extension settings 5-19–5-21
        - keys, reset to default 5-24–5-25
        - personal speed dial 5-23
        - phone status 5-26
        - port swapping 5-22
      - KSU, connecting to 5-9
      - line programming 5-27–5-35
        - hunt groups 5-33
        - incoming ringing 5-28
        - line access 5-29
        - line settings 5-31–5-32
        - PABX access 5-30
        - routing, alternative 5-34–5-35
      - programming introduction 5-14–5-15
      - programming screen, real-time 5-10–5-14
      - real-time mode 5-8
      - system programming 5-36–5-53
        - caller ID detection number 5-41–5-42
        - exception and restriction tables 5-40–5-41
        - system date and time 5-43
        - system settings 5-37–5-39
        - system speed dial list 5-42
        - user timers 5-39–5-40
    - RMS Software
      - main screen 5-4
      - menus 5-5–5-6
    - Room Monitor 3-43
    - Routing, Alternative 5-34, 5-49
    - Running Cable 2-7
  - S**
  - Safety Regulations 1-xvii
  - Sales Number 3-28, 4-15, 4-36
  - Sample System Layout 2-8
  - Scheduled Alarm Self-Test 6-11
  - Scroll Keys 3-12
  - Secretary 5-17
  - Secretary/Manager 3-43, 4-23
  - Self-Test 6-11
  - Service Center Numbers 6-12
  - Service Number 3-28, 4-15, 4-36
  - Set Range OFF 5-15
  - Set Range ON 5-15
  - Setting Up the Connection 5-8
  - Settings
    - global 5-31
    - line 5-31
    - optional 5-32
    - reset keys to default 5-24, 5-25
    - system 5-37
  - Setup for COM port 5-5
  - Signals and Tones 2-10, 3-20
  - Single-Line Sets 2-26, 3-16
    - feature codes 3-4
  - Software Installation
    - RMS, installing 5-3
    - RMS, upgrading 5-4
    - upgrading 2-37
  - Software license agreement 1-xx–1-xxii
  - Software States 6-6
  - Source of Courtesy Service 5-39
  - Speakerphone 2-24
  - Speed Dial 3-27, 3-38
    - numbers 3-38
    - override COS 5-20
    - personal 5-23
    - station 3-38
    - system 3-38, 4-8, 4-20, 5-42, 5-51
      - override toll restriction 4-20
  - Statistics 6-5
  - Status 5-26
  - Store All Calls 5-38
  - Supervised CO lines 2-5, 3-5
  - Supplies Needed 2-6
  - Swapping Extensions 4-22
  - Swapping Ports 5-22
  - System Capacities 1-7
  - System Configuration 5-6, 5-11
  - System Features 1-6, 7-4
    - troubleshooting 7-4
  - System Greetings 4-11
  - System Hardware 1-4
  - System Installation Checklist 2-3
  - System Layout 2-8
  - System Phone Monitor 6-7
  - System Programming 5-36–5-53
    - password 5-38
  - System Programming Password 4-7
  - System Reset 4-14, 6-9
  - System Settings 5-37–5-39
  - System Speed Dial
    - see Speed Dial
  - System Speed-Dial 4-8
    - override toll restriction 4-20
  - System Tests 6-10
    - initiate 6-10
    - read 6-10
  - System Time and Date 4-7, 5-43
  - System Timers 4-12, 4-32, 5-50, 6-13
    - programming 6-13
  - System Troubleshooting 7-4
  - System Voicebox On 5-38
  - System-Wide Features 2-35, 4-32, 5-50
  - System-Wide Programming 4-5–4-15
    - troubleshooting 7-4
- T**
- Technical Support 7-6
- Telephone Numbers 5-48

Tests

- initiate 6-10
- read 6-10
- system 6-10

Text Entry 3-13

Thresholds for alarms 6-13

Time 4-7

Time and Date 5-43

Timers 4-12, 4-32, 5-50

- system 5-50, 6-13
- user 5-39

Toll Restriction 3-6

- classes of service 3-6
- speed dial override 4-20

Tone Dialing 4-31, 5-32

Tone Protection 5-20

Tones 3-20

Tools and Supplies 2-6

Tools Needed 2-6

Trace 6-8

Transfer 3-32

- external 3-32
- internal 3-32
- recalls 3-32
- reverse 3-29
- to voicemail 3-33

Troubleshooting 7-2

Trunk-To-Trunk 3-32, 3-33, 5-20

- prohibited calls 4-22

## U

---

Unsupervised lines 2-5, 3-5

Upgrading the system software 2-37

User Timers 5-39–5-40

## V

---

V24 Adapter 5-3

- baud rate 5-38

V24 Baud Rate 4-14

Viewing Changes 5-15

Voice mail capacity 4-15

Voice mail, diverting messages to 4-15

Voice mail, monitoring 3-21

Voice Messaging 3-20, 5-20

- box 4-21
  - access 3-21
  - assignments 4-21
  - forward to 3-19

- card removal and messages 3-19

- features 3-19

- password 5-21

Voice Messaging Module 1-4, 2-13, 3-19

- archived messages in 3-19

Voicebox (Answering Machine) 5-38

Volume Key 3-15

## W

---

Waiting for SYNC 7-3

Wall-Mounting

- keyset 2-25

- KSU 2-18

Warm Reset 6-9

Weekend Service 3-5, 4-9, 5-37

Wiring 2-19

- for power failure operation 2-10

- technique 2-19





Part No. 618.8000  
Issue 4.0, July 2002

