

Lucent Technologies
Bell Labs Innovations



DEFINITY[®]

Enterprise Communications Server

Release 7

Console Operations

555-230-700
Comcode 108383837
Issue 4
June 1999

Notice

Every effort was made to ensure that the information in this book was complete and accurate at the time of printing. However, information is subject to change.

Your Responsibility for Your System's Security

Toll fraud is the unauthorized use of your telecommunications system by an unauthorized party, for example, persons other than your company's employees, agents, subcontractors, or persons working on your company's behalf. Note that there may be a risk of toll fraud associated with your telecommunications system and, if toll fraud occurs, it can result in substantial additional charges for your telecommunications services.

You and your system manager are responsible for the security of your system, such as programming and configuring your equipment to prevent unauthorized use. The system manager is also responsible for reading all installation, instruction, and system administration documents provided with this product in order to fully understand the features that can introduce risk of toll fraud and the steps that can be taken to reduce that risk. Lucent Technologies does not warrant that this product is immune from or will prevent unauthorized use of common-carrier telecommunication services or facilities accessed through or connected to it. Lucent Technologies will not be responsible for any charges that result from such unauthorized use.

Lucent Technologies Fraud Intervention

If you *suspect that you are being victimized* by toll fraud and you need technical support or assistance, call Technical Service Center Toll Fraud Intervention Hotline at 1 800 643-2353.

Federal Communications Commission Statement

Part 15: Class A Statement. This equipment has been tested and found to comply with the limits for a Class A digital device, pursuant to Part 15 of the FCC Rules. These limits are designed to provide reasonable protection against harmful interference when the equipment is operated in a commercial environment. This equipment generates, uses, and can radiate radio-frequency energy and, if not installed and used in accordance with the instructions, may cause harmful interference to radio communications. Operation of this equipment in a residential area is likely to cause harmful interference, in which case the user will be required to correct the interference at his own expense.

Part 68: Network Registration Number. This equipment is registered with the FCC in accordance with Part 68 of the FCC Rules. It is identified by FCC registration number AS593M-13283-MF-E. Refer to "Federal Communications Commission Statement" in "About This Book" for more information regarding Part 68.

Canadian Department of Communications (DOC)

Interference Information

This digital apparatus does not exceed the Class A limits for radio noise emissions set out in the radio interference regulations of the Canadian Department of Communications.

Le Présent Appareil Numérique n'émet pas de bruits radioélectriques dépassant les limites applicables aux appareils numériques de la class A prescrites dans le règlement sur le brouillage radioélectrique édicté par le ministère des Communications du Canada.

Trademarks

DEFINITY is a registered trademark of Lucent Technologies.

Ordering Information

Call: Lucent Technologies BCS Publications Center
Voice 1 800 457-1235 International Voice 317 322-6416
Fax 1 800 457-1764 International Fax 317 322-6699

Write: Lucent Technologies BCS Publications Center
2855 N. Franklin Road
Indianapolis, IN 46219

Order: Document No. 555-230-700
Comcode 108383837
Issue 4, June 1999

For additional documents, refer to the "Introduction."

You can be placed on a standing order list for this and other documents you may need. Standing order will enable you to automatically receive updated versions of individual documents or document sets, billed to account information that you provide. For more information on standing orders, or to be put on a list to receive future issues of this document, contact the Lucent Technologies Publications Center.

European Union Declaration of Conformity

The "CE" mark affixed to the DEFINITY® equipment described in this book indicates that the equipment conforms to the following European Union (EU) Directives:

- Electromagnetic Compatibility (89/336/EEC)
- Low Voltage (73/23/EEC)
- Telecommunications Terminal Equipment (TTE) i-CTR3 BRI and i-CTR4 PRI

For more information on standards compliance, contact your local distributor.

Comments

To comment on this document, return the comment card at the front of the document.

Acknowledgment

This document was prepared by Product Documentation Development, Lucent Technologies, Denver, CO.

Contents

Contents **iii**

<u>1</u>	<u>Introduction</u>	<u>1</u>
	■ <u>Conventions Used in This Document</u>	<u>2</u>
	■ <u>Security Measures</u>	<u>2</u>
<u>2</u>	<u>Understanding the Console Layout</u>	<u>5</u>
	■ <u>Physical Layout of Your Console</u>	<u>5</u>
	<u>Outside-Lines Buttons Area</u>	<u>7</u>
	<u>Call Appearance Buttons</u>	<u>8</u>
	<u>Dialing Keypad</u>	<u>9</u>
	<u>Features</u>	<u>11</u>
	<u>The Display</u>	<u>12</u>
	<u>Displaying in Normal Mode</u>	<u>14</u>
	<u>Ringer-Volume Control Area</u>	<u>18</u>
	<u>Selector Console</u>	<u>19</u>
	<u>Tones Heard Through Handset or Headset</u>	<u>21</u>
<u>3</u>	<u>Operating the Console</u>	<u>23</u>
	■ <u>Activating the Console</u>	<u>24</u>
	■ <u>Deactivating the Console</u>	<u>24</u>
	■ <u>Transferring Calls to Internal Extensions</u>	<u>24</u>
	■ <u>Transferring Calls to Outside Numbers</u>	<u>25</u>
	■ <u>Placing Callers on Hold</u>	<u>26</u>
	■ <u>Connecting Two or More Callers</u>	<u>26</u>
	■ <u>Answering Emergency Calls</u>	<u>27</u>
<u>4</u>	<u>Using the Features</u>	<u>29</u>
	■ <u>Speeding Up the Console</u>	<u>29</u>
	<u>Using Auto Start</u>	<u>29</u>
	<u>Speed Dialing</u>	<u>30</u>
	<u>Holding Calls Automatically</u>	<u>31</u>
	■ <u>Handling Multiple-Party Calls</u>	<u>31</u>
	<u>Connecting Multiple Callers</u>	<u>31</u>
	<u>Locking Out the Console Operator</u>	<u>32</u>
	<u>Recalling the Console Operator</u>	<u>32</u>
	<u>Paging with Deluxe Voice Paging</u>	<u>33</u>

■ Answering Calls for Another Party	34
Backing Up the Console Operator	35
Routing Calls Through the Console Operator	35
Covering Calls from the Console	35
Forwarding All Calls	36
Parking Calls	37
■ Paging for Called Parties	38
Parking Calls	38
Chime Paging	39
Paging with Voice Paging	41
Paging with Deluxe Voice Paging	42
■ Assisting Callers with Special Tools	43
Using Call Waiting	43
Split-Swap	44
Interrupting a Call	45
Overriding Diversion Features	46
Emergency Notification to Digital Telephones	46
Providing Emergency Notification to the Operator	48
Providing Emergency Access to the Operator	48
Placing a Series of Calls	49
■ Managing Outside Lines	50
Controlling Access to Outside Lines	50
Displaying Outside Line Information	51
Choosing Outside Lines	52
■ Using Features for Internal Use	52
Restricting Calls	52
Activating Don't Split	54
Testing Phone System Components	55
Accessing Individual Console Operators	55
Using the Internal Directory	56
Assigning Main Console Operators	57
Leaving Messages	57
Retrieving Messages	58
Using Night Service	59
Routing Calls Economically	60

	<u>Using Visually Impaired Attendant Service</u>	<u>63</u>
<u>5</u>	<u>Centralized Attendant Service</u>	<u>65</u>
	■ <u>Identifying Differences in a CAS Environment</u>	<u>65</u>
	<u>Using CAS-Associated Tones</u>	<u>66</u>
	<u>Using a CAS Display</u>	<u>66</u>
	<u>Using CAS Operating Procedures</u>	<u>67</u>
	<u>Transferring CAS Calls</u>	<u>67</u>
	<u>Placing Calls on Remote Hold</u>	<u>68</u>
	<u>Using CAS Backup Service</u>	<u>68</u>
	<u>Using CAS Night Service Operations</u>	<u>68</u>
<u>6</u>	<u>Routine Maintenance</u>	<u>71</u>
	■ <u>Testing the Console</u>	<u>71</u>
	■ <u>Cleaning Your Console</u>	<u>72</u>
	■ <u>Commercial Power Failure</u>	<u>72</u>
<u>GL</u>	<u>Glossary and Abbreviations</u>	<u>73</u>
<u>IN</u>	<u>Index</u>	<u>79</u>

Introduction

1

If you are a console operator, this book is for you! It is designed to show you the physical layout of your computer, how to perform standard and specialty functions, and how to maintain and clean your console. It also provides information specific to operating your console in a Centralized Attendant Service (CAS) environment.

NOTE:

This guide does not cover operations associated with Hospitality Services and Automatic Call Distribution (ACD). Information on these groups of features can be found in the following documents:

- *DEFINITY Enterprise Communications Server and GuestWorks Release 7 — Hospitality Operations, Issue 5, 555-230-723*
- *DEFINITY Enterprise Communications Server Generic 1, Generic 3, and System 75 — Automatic Call Distribution (ACD) Agent Instructions, Issue 5, 555-230-722*
- *DEFINITY Enterprise Communications Server Generic 1, Generic 3, and System 75 — Automatic Call Distribution (ACD) Supervisor Instructions, Issue 4, 555-230-724*
- *DEFINITY Enterprise Communications Server Release 7 — Console Operations Quick Reference, Issue 3, 555-230-890*

The rest of this book includes:

- [Chapter 2, “Understanding the Console Layout”](#) describes and illustrates the basic and enhanced versions of the two console models. It also describes information that appears on the console’s display and tones heard at the console.

- [Chapter 3, “Operating the Console”](#) contains step-by-step instructions for placing calls, transferring calls, placing callers on hold, placing conference calls, and handling emergency calls.
- [Chapter 4, “Using the Features”](#) describes of features associated with the console and provides step-by-step instructions where applicable.
- [Chapter 5, “Centralized Attendant Service”](#) describes CAS operations for handling CAS calls, CAS night service, and CAS backup procedures.
- [Chapter 6, “Routine Maintenance”](#) describes routine procedure for testing the console, cleaning the console; also contains information for handling the console after a commercial power failure.
- [Glossary and Abbreviations](#) provides an alphabetical listing and brief definitions of words and terms used with the attendant console and communications systems.
- [Index](#) provides an alphabetical listing of the information within this guide. For ease of use, all key words within a title or term are listed.

Conventions Used in This Document

- Console buttons are shown as: CANCEL
- Console lamps are shown as: Attd
- Alphanumeric displays appear as:

a=	TOM BROWN	3062
----	-----------	------

Security Measures

For detailed information on securing your systems from unauthorized use please refer to *BCS Products Security Handbook*. This document addresses security issues related to consoles including:

- Procedures for console operators when they receive hangup or silence calls
- Physical security
- Class of service
- Facility restriction levels and alternate facility restriction levels
- Console operator-controlled phones

1	Introduction	
	<i>Security Measures</i>	3

- Rerouting calls to console operators
- Changing barrier codes
- Sending calls to console operators
- Console operator-controlled remote access
- Sending reports to console operators

1	Introduction	
	<i>Security Measures</i>	

4

Understanding the Console Layout

2

Your console is a powerful communications tool. With it, you function as a communications hub by managing calls and performing a variety of special functions. The goal of this chapter is to familiarize you with the console layout.

At the end of this chapter, you will be able to describe the layout of your console.

Physical Layout of Your Console

At first glance, your console may look like an oversized phone with a few too many buttons and lamps (lights). While your console can function like a phone, it also manages several additional functions. In fact, your console, with its many buttons and lamps, has functional groups designed to manage outside lines, incoming calls, and special features.

Two types of consoles are described in this chapter: the 302A/B and the 302C console. The following section contains drawings of 302A/B and 302C consoles followed by information on their layout.

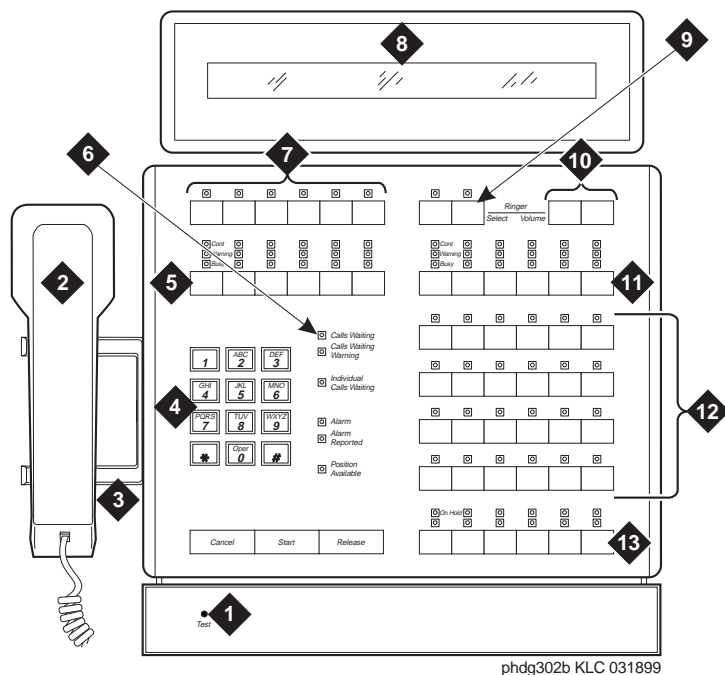

Figure Notes:

- | | |
|---|-----------------------------|
| 1. Lamp Test Switch | 8. Display |
| 2. Handset | 9. Select Button |
| 3. Handset Cradle | 10. Volume Control Buttons |
| 4. Call Processing Area | 11. Outside-line Buttons |
| 5. Outside-line Buttons | 12. Feature Buttons |
| 6. Warning Lamps and Call Waiting Lamps | 13. Call Appearance Buttons |
| 7. Display Buttons | |

Figure 1. 302A/B Console

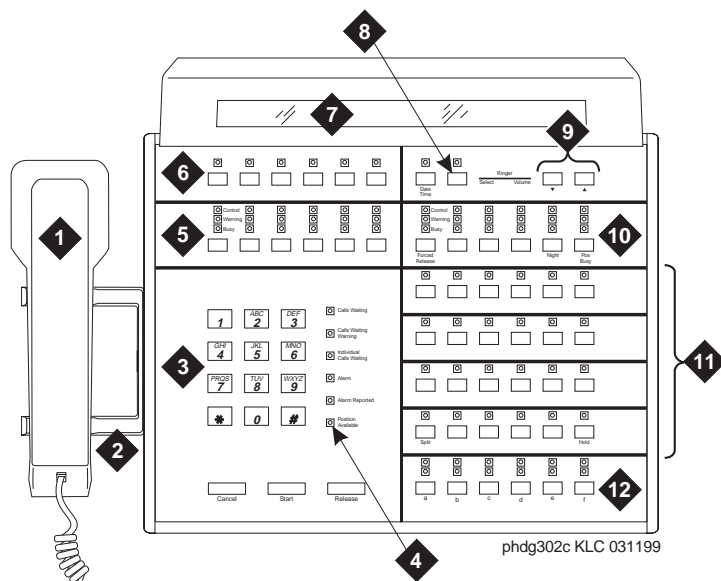

Figure Notes:

- | | |
|---|-----------------------------|
| 1. Handset | 7. Display |
| 2. Handset Cradle | 8. Select Button |
| 3. Call Processing Area | 9. Volume Control Buttons |
| 4. Warning Lamps and Call Waiting Lamps | 10. Outside-line Buttons |
| 5. Outside-line Buttons | 11. Feature Buttons |
| 6. Display Buttons | 12. Call Appearance Buttons |

Figure 2. 302C Console

Outside-Lines Buttons Area

The outside-lines buttons area allows you to choose an outside line or can be dedicated for paging system users. The outside-lines buttons area includes:

- Labeled buttons representing outside lines
- A Busy lamp that lights when all outside lines are busy

- A Warning lamp that lights when a predetermined number of outside lines are busy
- A Control lamp indicating that an outside line is in use

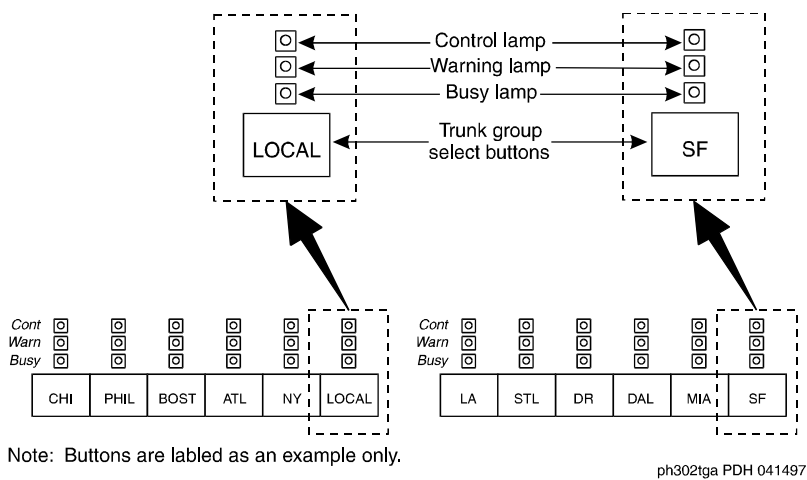

Figure 3. Sample Outside-Lines Buttons Area

Call Appearance Buttons

The call appearance buttons allow you to answer calls, place calls, or place calls on hold. It includes:

- A call appearance button for answering or placing calls
- An Atnd lamp that lights when you answer or place a call. This lamp flashes when an incoming call comes to the console, or when a transferred call returns to the console.
- A Hold lamp that lights when you place a call on hold. This lamp flashes when a call remains on hold longer than the acceptable time limit that is programmed on your console.

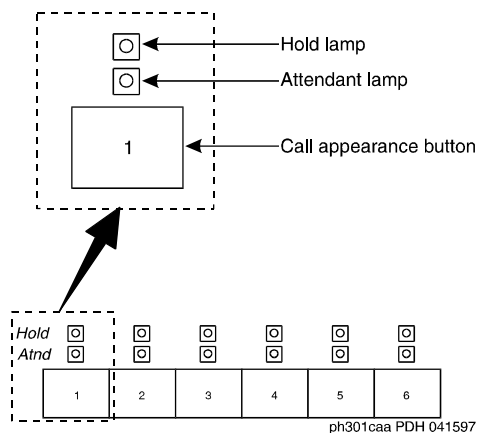

Figure 4. Call Appearance Buttons and Lamps

Dialing Keypad

The dialing keypad has several buttons and lamps used for processing calls or notifying you of calls that are waiting to be answered, system-detected alarms, and lines that are available for placing calls.

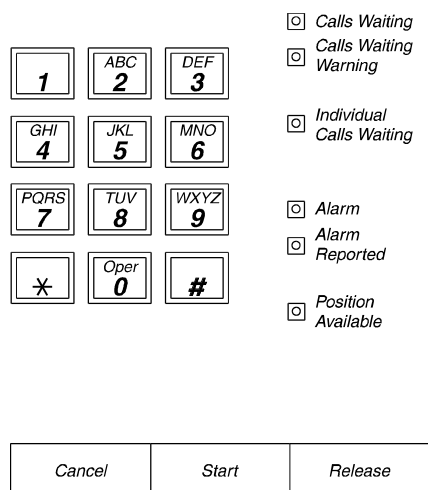

Figure 5. Call Processing Area

The call-appearance buttons allow you to:

- Cancel a call

The CANCEL button allows you to abort a call procedure without disconnecting parties who are on the line.

- Start a call

The START button allows you to initiate a call or to transfer a call.



NOTE:

If you have Autostart, you can begin a call without pressing any button.

- End a call

The RELEASE button disconnects you from a call and prepares the console for the next call.

The Call Processing lamps notify you that the following conditions exist:

Table 1. Call Processing Indicators

Lamp Name	Condition	Meaning	Action
Alarm	Lighted	Maintenance required	System automatically contacts your maintenance provider
Alarm/ Alarm Reported	Lighted	Successful communication to your maintenance provider	n/a
	Flashing	Unsuccessful communication to your maintenance provider	Contact your system manager
	Dark	Maintenance problem resolved	n/a
Calls Waiting	Lighted	Call is waiting to be answered	Answer call at your earliest convenience

Continued on next page

Table 1. Call Processing Indicators (Continued)

Lamp Name	Condition	Meaning	Action
Calls Waiting Warning	Lighted	Maximum number of calls are in the waiting queue	Answer calls as soon as possible or get assistance
Individual Calls Waiting	Lighted	Call to your personal extension needs to be answered	Answer call as soon as possible
Pos Avail	Lighted	Console available for incoming calls	n/a
	Dark	One of the following conditions exists: <ul style="list-style-type: none"> ■ You are on a call. ■ A call has arrived at the console. ■ The handset or headset is unplugged. ■ You pressed the POS BUSY button. ■ You placed the system in night-service mode. 	n/a

Features

The features area of your console allows you to perform standard and specialty operations. Your console is configured with features purchased by your company. Your system manager can provide a list of features available to you. For specific feature information, refer to [Chapter 4, “Using the Features”](#).

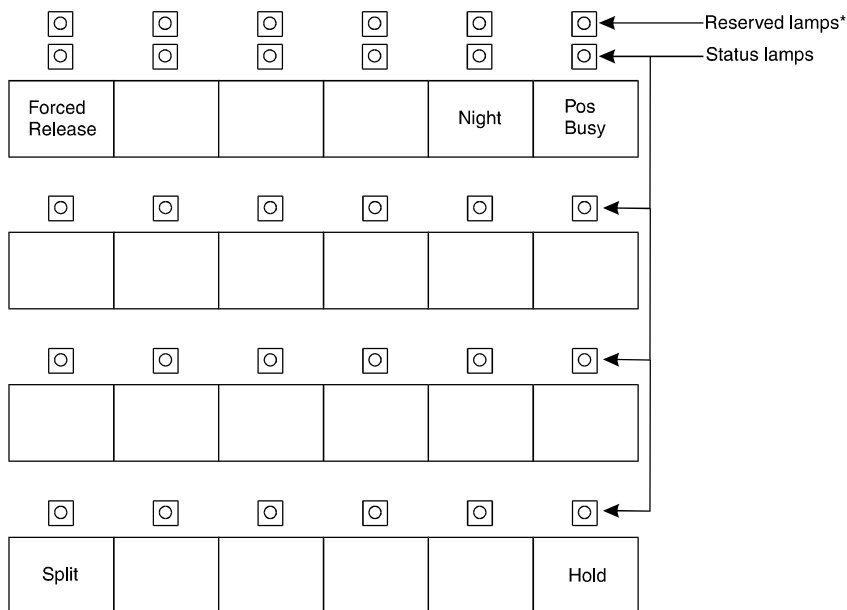

*Reserved lamps are on basic console only.
 Note: Unlabeled buttons are available for assignment.

ph310ffb PDH 041597

Figure 6. Feature Button Area

The Display

The alphanumeric display provides information about callers, called parties, call status, and call features. Your console has 9 buttons in the display area that function as different modes for viewing information. On the basic console, they are located on the display module. On the enhanced console, they are located on the main console.

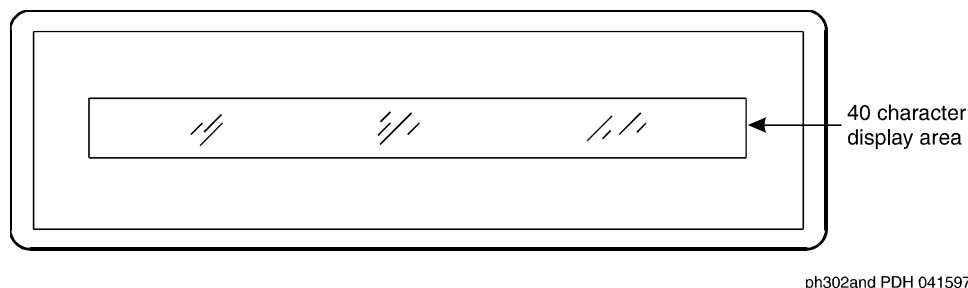
**Figure 7. Display**

These display mode buttons are as follows:

**NOTE:**

Your system manager may change the function of each button.

- **NORMAL MODE** (comes with every console)

This button displays call-related information for active, incoming calls and console-originated calls. For more information on information that displays in normal mode, refer to [Displaying in Normal Mode](#) later in this chapter.

- **INSPECT MODE**

This button displays call-related information for held calls when you are on another call.

- **DATE TIME**

This button displays the current time of day and date for five seconds.

- **TIMER (Elapsed Time)**

This button displays elapsed time in hours, minutes, and seconds. Timing begins when you press the **TIMER** button and stops when you press the button again. The elapsed time information disappears when you press the button a third time.

- **COVER MSG RT (Coverage Message Retrieval)**

This button retrieves Leave Word Calling (LWC) messages for system users. Leave Word Calling allows callers to leave messages for called parties on a message system that you can access from your console.

- NEXT MSG

This button displays the next stored LWC message. If you are in Cover Msg Rt mode, the display shows END OF MESSAGES or NEXT TO REPEAT. If you are in Integrated Directory mode, it displays the next caller's name.

- DELETE MSG (Message)

This button deletes the displayed message.

- INTGRTD DIRECTORY (Integrated Directory)

This button displays users' names and extensions from the system directory.

- MAKE CALL

This button automatically returns calls from messages left in LWC. It also automatically calls currently-displayed Integrated Directory listings.

- STORED NUMBER

This button displays the code required for accessing an outside line (usually a 9), or the extension number of the facility that the BUSY button monitors. To access this information:

1. Press the STORED NUMBER button
2. Press the BUSY button.

Displaying in Normal Mode

Call-related information includes:

- Incoming-call button associated with the call

One of six buttons, labeled **a** through **f**, lights when a call comes to your console. In the following sample, the lamp that lights is **a**.

```
a= TOM BROWN 3062
```

- Caller identification

For internal calls, the display shows the caller's name or the identification assigned to the phone in use, and the caller's extension. In the following sample, the caller is Tom Brown who is at extension 3062.

```
a= TOM BROWN 3062
```

For outside calls, the display shows the kind of outside line used and the outside line's assigned access code. In the following sample, the access code for the local outside line is 8.

```
b= OUTSIDE CALL 8
```

- Called-party identification

For incoming calls, the display shows the called party's name and extension. In the following sample, the called party is Liz Via who is at extension 4328.

```
e= OUTSIDE CALL to LIZ VIA at EXT 4328
```

For outside calls, the display shows the kind of outside line used and the outside line's access code. In the following sample, the access code the line used is a WATS line, with access code 101.

```
b= WATS 101
```

- Calling party identification for outbound calls

For an outgoing call, the display shows the called party's name and extension. In the following sample, the called party is Jeff Morrow who is at extension 4032.

```
a= JEFF MORROW 4032
```

If only name information is available, the following displays.

```
a= JEFF MORROW 4032
```

If only number information is available, the following displays.

```
a= 3304 3304
```

If neither the name or the number is available, the following displays.

```
a= 3304
```

OR

```
a = OUTSIDE LINE NAME TRUNK ID
```

If the call gets redirected, the following displays.

```
a= 3304 COVER
```

System user's calling privileges

Your system manager assigns calling privileges for all system users. A 2-digit number assigned by your system manager, followed by a hyphen and 4-alpha characters that identify the user's calling privileges. The 4-alpha characters are listed in [Table 2](#).

Table 2. Calling Privilege Identifiers

4-alpha character	Meaning
ORIG	The user cannot place any calls from their phone.
OTWD	The user cannot place calls on outside lines from their phone.
TOLL	The user cannot place long distance calls from their phone.
NONE	The user has no calling restrictions.

- Call purpose

Call-purpose information identifies features that are in use. [Table 3](#) defines call-purpose identifiers.

Table 3. Call Purpose Identifiers

Identifier	Description
B or b	Displays when called parties do one of the following: <ul style="list-style-type: none"> ■ Do not answer ■ Send their calls to coverage ■ Are active on a call that uses temporary bridged appearance
co	An internal user who doesn't have calling privileges for outside lines attempts to make an outgoing call.
cs	An internal user who doesn't have internal calling privileges attempts to make a call to another internal phone.
ct	A caller attempts to call a user who cannot receive calls.

Table 3. Call Purpose Identifiers (Continued)

Identifier	Description
d	Displays when called parties do one of the following: <ul style="list-style-type: none"> ■ Do not answer ■ Send their calls to coverage ■ Are unavailable and have a temporary bridged appearance.
f	System users forward their calls to you.
ic	The system redirects calls to you due to a problem with the system or because your system manager has programmed calls made to specified extensions to come to you.
ld	Incoming calls that are listed in the phone book and are placed directly to a system user's extension.
n	Night service is on and the call goes to the night service station.
na	Consoles are in night service mode.
rc	A held call returns to the console.
rt	An unanswered, transferred call returns to the console.
sc	A caller places repeated calls on the same line without disconnecting.
s	Displays when a called system user temporarily sends all their calls to coverage.
tc	A caller attempts to make an outgoing call on an outside line that you control. The call redirects to you.

- Call status

Call-status displays the phone call's current status. [Table 4](#) identifies call status indicators and describes when they occur.

Table 4. Call Status Identifiers

Identifier	Description
Ringing	The dialed call rings.
Wait	The Attendant Call Waiting feature is available.
Wait, [I] Intrusion Allowed	The Attendant Call Waiting and Intrusion features are available.
Busy	An extension is busy or out of service and neither the Attendant Call Waiting nor the Intrusion features are allowed.
Busy, [I] Intrusion Allowed	An extension is busy or out of service and the Attendant Call Waiting feature is not allowed.

**NOTE:**

If your system has Integrated Services Digital Network (ISDN) — Primary Rate Interface (PRI), refer to [Chapter 4, “Using the Features”](#), for display information associated with ISDN-PRI.

Ringer-Volume Control Area

The ringer-volume control area provides volume control for:

- Incoming calls
- Timed reminder tones (notification that a call needs additional attention)
- Call waiting tones (notification that a call is waiting to be answered)
- Emergency access to attendant calls (not Crisis Alert calls)

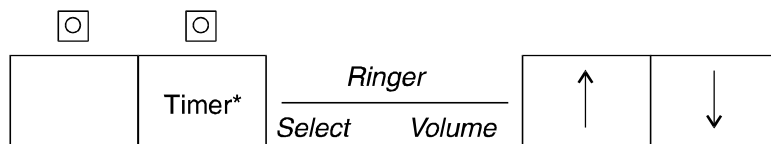

* "Timer" is the default value for this button. However, this value may be changed via system administration, resulting in a different button name.

ph302rvc PDH 041697

Figure 8. Ringer Volume Control Area (enhanced console)

The ringer volume control area has an ▲(up) button, a ▼(down) button, and a SELECT button. To adjust the volume on your console:

1. Press and release the ▲(up) button) or ▼(down) button to activate the display.
 The display exhibits a bar graph and identifies the tone to be adjusted.
2. Press the SELECT button to choose the type of tone that you wish to adjust.
3. Press and release the ▲(up) button to increase the volume or the ▼(down) button to decrease the volume.
4. Press any other button on the console to complete or cancel this task.

Selector Console

The Selector Console allows you to transfer calls and determine the status of an extension. It has two groups of buttons and lamps: the Hundreds Group Select (HGS) and the Direct Extension Selection (DXS) with Busy Lamp Field (BLF).

The basic console has 8 HGS buttons; the enhanced console has 20. You use them in conjunction with the DXS buttons to dial an extension. For example, if you wish to transfer a call to extension 3452, press the HGS button labeled 34, then press the DXS button labeled 52.

The 100 DXS buttons are labeled from 00 to 99. When combined with the HGS buttons, they provide up to 800 possible extensions for the basic console and up to 2000 possible extensions for the enhanced console. For more information on how to transfer calls, refer to [“Transferring Calls to Internal Extensions” on page 24](#).

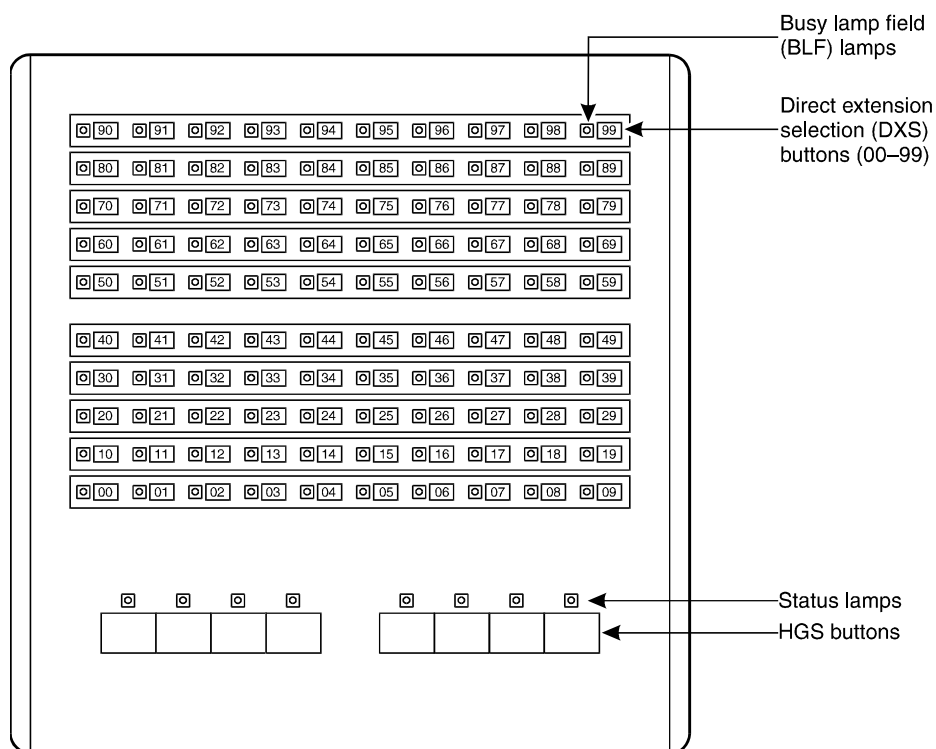

ph26bsc PDH 041897

Figure 9. Selector Console Area

Determining Extension Number Status

You can determine the status of an extension by pressing the two buttons necessary to complete the extension and looking at the lamp to the left of the appropriate DXS button.

- If the lamp is dark, the extension is idle.
- If the lamp is lighted, the extension is in use. You can still transfer a call if system users have more than one line available. Ask your system manager about the phones in your company.
- If the extension is busy, you hear a busy tone.

- If a station has the SAC feature active and is busy, the DXS/BLF lamps remain steady until the station is no longer busy. At that time, the lamp goes to a flashing mode. The PC Console alerts by changing colors on the icon for the associated extension.

Tones Heard Through Handset or Headset

When you operate the console, you hear tones through the handset or headset that can indicate progress or status of a call, or identify types of incoming calls. [Table 5](#) describes the tones available on your console.

Table 5. Ringing and Tones Descriptions

Tone Name	Pitch	Frequency	Meaning
Ringback	Low	15 times a minute	A transferred call comes back to the console.
Special Ringback	Low	Single	Calls are waiting to be answered.
Busy	Low	60 times a minute	The called extension is busy.
Fast Busy	Low	120 times a minute	A caller dialed an incorrect number or called a phone that cannot be called.
Confirmation	n/a	Three short bursts	The operation requested (activated or deactivated) is accepted.
Coverage	n/a	One short burst	A call to one extension rings at a different extension.
Dial	Low	Continuous steady tone	A phone is ready to use.
Intercept	On-Off, high and low	Siren-type “Dee-Do”	A caller dialed a number incorrectly or called a phone that cannot be called.
Reorder	Low	120 times a minute	All trunks within a particular trunk group are busy or that a requested feature is not available.

Continued on next page

Table 5. Ringing and Tones Descriptions (Continued)

Tone Name	Pitch	Frequency	Meaning
Call Waiting Ringback	Low	15 times a minute with decreasing volume during the last 0.2 second	A call is waiting at the console and the called party has been notified that the call is waiting.
Incoming Call Ringing	On-off, low	0.5 second	An incoming call is waiting to be answered.
Calls Waiting (Queued Calls)	On-off, low	0.25 second	One or more incoming calls are waiting to be answered.
Timed Reminder (Attendant Recall)	high	On for 0.5 second; off for 1 second	A single-party call is on hold for longer than the time allowed by your company. This tone also occurs when someone on a conference call calls you or an unanswered transferred call returns to you.
Emergency Access Ringing	On-Off, high and low	Siren-like	A tone that indicates an emergency. This ringing tone is heard on the latest models of the basic console and all models of the enhanced console.

Operating the Console

3

As a console operator, you spend the majority of your day placing calls, transferring calls, and putting callers on hold. You might also place a conference call or handle communications for an unexpected emergency. This section describes and provides step-by-step procedures for these operations. Before you read the rest of this section, check with your system manager to see if you work in a Centralized Attendant Service (CAS) environment. If you work in a CAS environment, be sure to read [Chapter 5, “Centralized Attendant Service”](#).

This chapter refers to “principal” consoles. A principal console is the main console used at your company. If your company has only one console, it is considered to be the principal console. If your work environment utilizes more than one console, your system manager assigns one console as “principal.” Principal consoles can control features, such as night service, for all consoles in the system.

At the end of this chapter, you will be able to:

- Identify standard features available on your console
- Perform standard functions available on your console

For additional information on console operations, refer to *DEFINITY ECS Console Operations Quick Reference*.

Activating the Console

Activating the console refers to preparing the console for human control.

To activate the console:

1. Plug in the handset or the headset.
2. Select one of the following two options:
 - If you are at the principal console, press the NIGHT button if the Night lamp is lit.
 - If you are not at the principal console, press the POS BUSY button.

Deactivating the Console

Deactivating the console refers to preparing the console to operate automatically after hours.

To deactivate the console:

1. Select one of the following two options:
 - If you are at the principal console, press the NIGHT button.
 - If you are not at the principal console, press the POS BUSY button.
2. Unplug the handset or the headset.

Transferring Calls to Internal Extensions

You may receive outside calls that you need to transfer to internal extensions or internal callers may need for you to transfer them to an extension. The process for both types of calls is the same.

To transfer calls to internal extensions:

1. Press the lighted call appearance button.
2. Greet the caller.
3. Press the START button.

 **NOTE:**

If the Auto Start feature is administered at your console, you do not need to press the START button.

4. Press the desired buttons on the selector console to dial the desired extension.

5. Select one of the following options:

- Press the RELEASE button as soon as the call starts to ring.

or

- Announce the call to the called party.
 - If the called party accepts the call, press the RELEASE button.
 - If the called party declines to talk to the caller, press the SPLIT button to reconnect to the caller.
- Follow your company's procedures for taking messages.
- Press the RELEASE button.

or

- If the called party is busy or does not answer, press the CANCEL button to reconnect with the caller.
- Follow your company's procedures for taking messages.
- Press the RELEASE button.

Transferring Calls to Outside Numbers

You may receive calls that you need to transfer to outside calls from internal callers or you may need to transfer one outside call to another outside number. The process for both types of calls is the same.

To transfer a call to an outside number:

1. Press the lighted call appearance button.
2. Greet the caller.
3. Access an outgoing line by pressing an outside line button or by dialing an outside line access code (many companies use 9 to access an outside line).
4. Select one of the following options:

- Press the RELEASE button if the caller plans to complete the call.

or

- Dial the desired party using the dialing keypad, then press the RELEASE button as soon the call starts to ring.

or

- Announce the call to the called party.
 - If the called party accepts the call, press the RELEASE button.

— If the called party declines to talk to the caller, press the SPLIT button to reconnect to the caller.

Follow your company's procedures for taking messages.

Press the RELEASE button.

or

- If the called party is busy or does not answer, press the CANCEL button to reconnect with the caller.
- Follow your company's procedures for taking messages.
- Press the RELEASE button.

Exceptions:

Two conditions impact your ability to transfer callers to outside parties. You cannot transfer calls to outside parties if:

- All outside lines are busy.
- The caller does not have calling privileges for the outside line requested.

Placing Callers on Hold

You can place up to 6 calls on hold. You should place callers on hold if you cannot service them immediately, or if you need to get back to the caller with information.

To place a call on hold:

1. Press the lighted call appearance button.
2. Greet the caller.
3. Press the HOLD button.

To reenter a call that is on hold:

1. Press the call appearance button that is on hold.
2. Talk to the party.

A single-party call that is on hold returns to the console automatically when it has been on hold for too long.

Connecting Two or More Callers

You can connect two or more parties with the attendant console. Connecting two or more callers is usually used for conference calls or to connect callers who cannot call each other.

To use connect two or more parties:

1. Call internal or external party number 1.
2. Press the START button.
3. Call the internal or external party number 2.
4. Press the SPLIT button. Both parties are connected.
5. Repeat steps 2 through 4 for additional parties.
6. Press the HOLD button.

Answering Emergency Calls

You may need to manage communication for an emergency. You can process emergency calls in the same way as regular calls. However, the console alerts you of an emergency call with the following information:

- The Emergency lamp flashes.
- The siren-like emergency tone sounds.
- The display identifies the calling party and shows EMERG.

Be sure to ask your system manager for the emergency procedures used in your company.

3	Operating the Console <i>Answering Emergency Calls</i>	28
----------	---	----

Using the Features

4

You might find yourself working at an organization that requires you to know more than the standard operating procedures outlined in the previous chapter. For example, you may be the guardian of your company's long distance calls.

This chapter covers features available at your console. You may not have every feature described in this chapter. To obtain a list of your company's features and their associated access codes, check with your system manager.

Information for each feature discussed in this chapter includes a brief feature description, an example that illustrates the feature, the feature's official name, and step-by-step procedures for using the feature.

The examples in this chapter are based on a fictitious company, Widgets, Inc., that produces self-cleaning bathtubs. The console operator for Widgets, Inc., Pat, manages calls for this 500-employee company.

Speeding Up the Console

Your system manager can program features described in this section to save time in a fast-paced environment. Features in this section reduce the number of buttons you must press to complete an operation.

Using Auto Start

You can initiate a calling procedure by pressing any button on your dial keypad without pressing the START button.

Example

Phone calls to Widgets, Inc. exceed 300 per day. Pat scrambles constantly to meet the demands of incoming calls. The system manager, Kelly Ratliffe, programs Auto Start to save Pat precious seconds.

Feature Name

Auto Start

Procedures

Your system manager programs this feature into your console to occur automatically.

Speed Dialing

With speed dialing, you can dial a frequently-used number by entering a code or pressing a button. You can use it to:

- Place local, long-distance, or international calls
- Activate features
- Access computer equipment at another location

Example

Pat orders office supplies for the executive offices. She purchases all Widget, Inc. supplies from the same vendor. So, Pat asks the system manager Kelly Ratliffe to add the vendor's number to the abbreviated dialing list. Kelly programs the new number and gives Pat the code assigned to the vendor's number. Now, Pat dials *12 every time she wants to call the office supply vendor.

Feature Name

Abbreviated Dialing

Procedures

To use speed dialing:

1. Obtain an abbreviated dialing list from your system manager.
2. Press the code or button assigned by your system manager to reach a desired number.

Holding Calls Automatically

Your console automatically places a call on hold when you answer another call.

Example

Widgets, Inc. is conducting an infomercial on their self-cleaning bathtubs. Pat's console is unusually busy. So, the system manager, Kelly Ratliffe, programs Pat's console to place calls on hold automatically when Pat answers another call. Pat answers the first incoming call and asks the party to hold. Then she presses the CALL APPEARANCE button for the next incoming call, placing the first caller on hold.

Feature Name

Hold-Automatic

Procedures

Your system manager programs hold-automatic to work on all consoles in your system.

Handling Multiple-Party Calls

This section covers features associated with connecting 2 to 5 callers on one call. It includes connecting callers, parking callers, locking the console operator out of multi-party calls, accessing operators from a conference call, and paging system users to add them to an existing conference call.

Connecting Multiple Callers

You can connect up to five callers on a single call.

Example

Two bathtub distributors want identical contract upgrades with Widgets, Inc. Company president Randy Foxworthy commissions Pat to set up a conference call with him, two sales representatives, and the two distributors. Pat uses the procedures listed below to connect all five callers.

Feature Name

Attendant Conference

Procedures

To place a conference call:

1. Call internal or external party number 1.
2. Press the START button.
3. Call the internal or external party number 2.
4. Press the SPLIT button. Both parties are connected.
5. Repeat steps 2 through 4 for additional parties.
6. Press the HOLD button.

Locking Out the Console Operator

Your system manager programs the console to prevent you from reentering a multi-party call that you initiated. Parties on these calls, however, can contact you.

Example

Widgets Inc. is undergoing a merger. Company president Randy Foxworthy requests numerous conference calls to discuss highly confidential information. To protect the confidentiality of the conversations, the system manager, Kelly Ratliffe, programs the console with Attendant Lockout. Because no one can enter the conference call, Randy can conduct his calls with guaranteed privacy.

Feature Name

Attendant Lockout

Procedures

Your system manager programs this feature into your console to work automatically. If you try to reenter the call, the Hold lamp for this call:

1. Flutters for 2 seconds
2. Returns to a solid, lighted state

Recalling the Console Operator

System users who are on multi-party calls that are held at the console can recall you for assistance.

Example

Robert Planter, vice president of public relations, is on a conference call with musician, Larry Browning, and stand-up comedian, Cindy Wittner, to plan for a community fund-raising event. Robert wants Larry and Cindy to present their ideas to coworker Jay Winstead so Robert calls Pat to add Jay to the call.

Feature Name

Attendant Recall

Procedures

To recall the operator from multi-party calls from a phone with one line:

- Press the RECALL button.

or

- Flash the switch hook.

To recall the operator from multi-party calls from a phone with more than one line:

- Press the CONFERENCE button.

or

- Press the TRANSFER button.

Paging with Deluxe Voice Paging

This feature combines Call Park and Loudspeaker Paging features. With deluxe loudspeaker paging, you can page a system user to call the extension where their call is parked or have them call you. If the system user calls you, you can add them to an existing conference call.

You can page called parties in up to nine locations or use a single, designated access code or button to page the called party in all 9 locations at once. Your system manager designates codes for each paging zone by assigning:

- Outside line buttons (see [Table 1 on page 6](#) or [Table 2 on page 7](#) for more information) to function as paging buttons

or

- A sequence of numbers on your dial keypad that serves as the paging access code

Example

Robert Planter, vice president of public relations, is on a conference call with musician, Larry Browning, and stand-up comedian, Cindy Wittner, to plan for an upcoming community fund-raising event. Robert wants Larry and Cindy to present their ideas to executive vice president Cathi Henrique. Pat pages Cathi. When Cathi answers her page, Pat adds her to the existing conference call.

Feature Name

Loudspeaker Paging Access — Deluxe

Procedures

To page individuals:

1. Tell the caller that you are going to page the called party.
2. Press one of the following:
 - PAGE 1 through PAGE 9
 - PAGE ALL, if provided
 - Keypad buttons to dial an access code
3. Page the called party, telling them which extension to call to get their call.

If you plan to connect the paged party to an existing conference call:

1. Tell them to call your extension.
2. Press the line where the conference call resides.
3. Press the SPLIT button.
4. Press the HOLD button.

Unanswered pages return to you for further assistance. If the allotted time for paging announcements expires during the page, the call disconnects and you hear an intercept tone (alternating high-low, siren-like tone or fast busy tone).

Answering Calls for Another Party

This section covers ways to answer calls from your phone when they ring to a different phone. It includes features that your system manager sets up to operate automatically and features that you must set up each time you use them.

Backing Up the Console Operator

Your system manager can program your overflow calls to ring to one or more designated phone.

Example

The marketing department just launched an infomercial about Widget, Inc.'s self-cleaning bathtubs. Consequently, the phones are "ringing off the hook". Chris answers Pat's overflow calls at his own phone.

Feature Name

Attendant Backup

Procedures

Your system manager programs this information into your console to occur automatically.

Routing Calls Through the Console Operator

Your system manager can designate up to 50 listed directory numbers to come directly to you.

Example

Widgets, Inc. president Randy Foxworthy wants Pat to screen all calls for him. Kelly Ratliffe, system manager, programs all of Randy's calls to come directly to Pat. When a salesman calls, Pat takes a message. When Randy's wife calls, Pat sends the call through to Randy.

Feature Name

Multiple Listed Directory Numbers

Procedures

Your system manager programs this information into your console to occur automatically.

Covering Calls from the Console

Your system manager designates unanswered calls to specified phones to ring through to you.

Example

Widgets, Inc. takes great pride in providing human contact for all persons calling customer service representatives. The system manager, Kelly Ratliffe, has programmed all customer service representative phones to go to coverage. When Suzanne Jones, customer service representative, is busy on a call, an incoming call routes to Pat.

Feature Name

Call Coverage

Procedures

[Table 6](#) describes the information that displays on your display when call coverage calls come to your console.

Table 6. Call Coverage Display Information

Display	Meaning
B or b	The called party is already on a call. Your console displays the caller's number and the unanswered phone's number.
d	Nobody answered this phone or the calling party sent the call to coverage. Your console displays the caller's number and the unanswered phone's number.
s	All calls that come to this number are sent temporarily to coverage.

Forwarding All Calls

You can forward all calls or remove forwarding for all calls for any extension in the system except the console.

Exception:

Ask your system manager if you work in a Distributed Communications System (DCS) environment. If you do, the forwarded-to telephone number must not:

- Be longer than 10 digits. The 10 digits can include a 3-digit access code followed by a typical 7-digit telephone number.
- Include authorization codes. Authorization codes cannot be in the forwarded-to telephone number.

Example

Bob Sisterkey, quality assurance specialist at Widgets, Inc., had to leave the office in a hurry for a personal emergency. He is expecting an important phone call, so he calls Pat and asks her to forward his calls to another member of his team. Pat uses the call forwarding all calls procedures to forward his calls to his team member.

Feature Name

Call Forwarding All Calls

Procedures

To forward all calls for an extension:

1. Press the **START** button.
2. Dial the forwarding all calls access code.
3. Dial the extension of the phone to be forwarded.
4. Dial the forwarded-to number.
5. Select one of the following options:
 - If you hear a confirmation tone (3 short bursts of tone) indicating that the procedure is successful, press the **RELEASE** button.
 - If you hear an intercept tone (alternating high-low, siren-like tone or fast busy tone) indicating that the procedure is unsuccessful, press the **CANCEL** button to try again.

To deactivate call forwarding all calls for a particular extension:

1. Press the **START** button.
2. Dial the forwarding all calls access code.
3. Dial the extension you want to deactivate.
4. Press the **RELEASE** button.

Parking Calls

You can put an incoming call on hold at one extension, then retrieve it from any other phone in the system. Your console has up to 10 dedicated extensions for parking calls.

Example

Rick Foylund, company arbitrator, is away from his desk when a call comes in for him. Pat pages Rick to tell him that he can call extension 5432 to answer his call. Rick dials his company's call park feature access code then 5432 to answer his call.

Feature Name

Call Park

Procedures

To park a call:

1. Press the **START** button.
2. Select one of the following options:
 - Dial the Call Park access code.or
 - Press the button your system administrator assigned to call park.
3. Use the dial keypad or the selector console to dial the extension where you want to park the call.
4. Select one of the following options:
 - If you hear a confirmation tone (3 short bursts of tone), the call is parked. Press the **RELEASE** button.
 - If you hear a busy tone, a call is already parked at the dialed extension. Press the **CANCEL** button to try again.

Paging for Called Parties

This section covers 3 methods for paging system users and includes Call Park information necessary for 2 of these methods.

Parking Calls

You can put an incoming call on hold at one extension then retrieve it from any other phone in the system. Your console has up to 10 extensions dedicated for parking calls.

Example

Rick Foylund, company arbitrator, is away from his desk when a call comes in for him. Pat places the call on hold at one of her 10 call park extensions. Pat pages Rick to tell him the number to dial to answer his call.

Feature Name

Call Park

Procedures

To park a call:

1. Press the **START** button.
2. Select one of the following options:
 - Dial the Call Park access code.or
 - Press the button your system administrator assigned to call park.
3. Use the dial keypad or the selector console to dial the extension where you want to park the call.
4. Select one of the following options:
 - If you hear a confirmation tone (3 short bursts of tone), the call is parked. Press the **RELEASE** button.
 - If you hear a busy tone, a call is already parked at the dialed extension. Press the **CANCEL** button to try again.

Chime Paging

When called parties are not at their phones, you can page them with coded chime signals. The chimes coincide with the paged party's extension. For example, paging someone from extension 113 generates chimes that:

1. Chime once followed by a pause
2. Chime once again followed by a pause
3. Chime three successive times followed by a pause

The chime sequence repeats up to 3 times. If the paged party does not answer, the call returns to you for further assistance.

You can page called parties in up to 9 locations or use a single, designated access code or button to page the called party in all 9 locations at once. Your system manager designates codes for each paging zone by assigning:

- The outside line buttons to function as paging buttons

or

- A sequence of numbers on your dial keypad that serves as the paging access code

Example

Rick Foylund, company arbitrator, is away from his desk when a call comes in for him. Pat pages Rick with code calling access. Rick hears his extension, 113, chimed and calls Pat to answer the page.

Feature Name

Code Calling Access

Procedures

To page using chimes:

1. Tell the caller that you are going to page the called party.
2. Press the **START** button.
3. Dial the code calling access code.
4. Dial the paged party's extension.
5. Select one of the following options:
 - If you hear a confirmation tone (3 short bursts of tone), the call parks on paged party's extension, and the system pages the called party.
 - To drop out of the call before the paged and calling parties are connected, press the **RELEASE** button.
 - To establish a 3-way call, wait for the called party to answer; then press **Split**.
 - To hold the call on the console, press the **HOLD** button.

or

- If you hear a busy tone, press the **CANCEL** button.
 - Report that the line is busy to the caller.
 - Take a message.
 - Press the **RELEASE** button.

Paging with Voice Paging

When called parties are away from their phones, you can page them with loudspeaker paging by parking their call then voice paging them to the extension where you parked their call. If called parties do not answer their pages, their calls automatically return to you for further assistance.

You can page called parties in up to 9 locations or use a single, designated access code or button to page the called party in all 9 locations. Your system manager designates codes for each paging zone by assigning:

- Outside line buttons to function as paging buttons

or

- A sequence of numbers on your dial keypad that serves as the paging access code

Example

Rick Foylund, company arbitrator, is away from his desk when a call comes in for him. Pat parks the call for Rick and pages him to let him know which extension he needs to call to answer the page.

Feature Name

Loudspeaker Paging Access

Procedures

To page individuals:

1. Tell the caller that you are going to page the called party.
2. Press one of the following:
 - PAGE buttons
 - PAGE ALL button, if provided
 - Keypad buttons to dial an access code
3. Page the called party, to tell them which extension to call to answer their call.

Unanswered pages return to you for further assistance. If the allotted time for paging announcements expires during the page, the call disconnects and you hear an intercept tone (alternating high-low, siren-like tone or fast busy tone).

Paging with Deluxe Voice Paging

This feature combines call park and loudspeaker paging. You can page a caller to call an extension or call you. You also can add a paged party to an existing conference call.

You can page called parties in up to 9 locations or use a single, designated access code or button to page the called party in all 9 locations. Your system manager designates codes for each paging zone by assigning:

- Outside line buttons to function as paging buttons

or

- A sequence of numbers on your dial keypad

Example

Robert Planter, vice president of public relations, is on a conference call with musician, Larry Browning, and stand-up comedian, Cindy Wittner, to plan for an upcoming community fund-raising event. Robert wants Larry and Cindy to present their ideas to executive vice president Cathi Henrique. Pat pages Cathi. When Cathi answers her page, Pat adds her to the existing conference call.

Feature Name

Loudspeaker Paging Access — Deluxe

Procedures

To page individuals:

1. Tell the caller that you are going to page the called party.
2. Press one of the following:
 - PAGE
 - PAGE ALL, if provided
 - Keypad buttons to dial an access code
3. Page the called party and tell them which extension to call to answer their call.

If you plan to connect the paged party to an existing conference call:

1. Tell them to call your extension.
2. Press the line where the conference call resides.

4 Using the Features

Assisting Callers with Special Tools

43

3. Press the SPLIT button.
4. Press the HOLD button.

Unanswered pages return to you for further assistance. If the allotted time for paging announcements expires during the page, the call disconnects and you hear an intercept tone (alternating high-low, siren-like tone or fast busy tone).

Assisting Callers with Special Tools

This section covers features that allow you to provide special assistance to callers. It includes ways to hold callers on the line, interrupt an existing call, override existing features designed to block incoming calls, assist callers who need to reach a series of system users, or manage emergency calls.

Using Call Waiting

When you transfer a call to a busy line, the call returns to the console until the busy line becomes available. When the busy line becomes available, the call automatically rings through. If the line does not become available, the call rings back to you for further attention.

Example

A customer, John Steele, places a call to customer service representative Leah Hoffguard. Leah is serving another client, but hears a beep in her ear indicating that she just received an incoming call. Pat notifies the caller that Leah's line is busy. Leah brings her current call to closure and John's call automatically rings through to her extension.

Feature Name

Attendant Call Waiting

Procedures

To notify callers that the party they called is busy:

1. Press the SPLIT button. The called party hears a call-waiting ringback tone.
2. Inform the caller that the called extension is busy, and that their call is waiting to be answered.
3. Press the RELEASE button.

4. One of the following options occurs:

- The call automatically rings through when the busy line becomes available.
- If the line does not become available within the time preset by your system manager, the call rings back to you. To try to transfer again, repeat steps 1 through 3.

Split-Swap

You can alternate between active and split calls by pressing the SPLIT-SWAP button. This operation happens only if you have a split call and an active call, and both calls are in the talking state. If you press the SPLIT-SWAP button during non-talking states (for example, dialing, ringing states, and so forth), then the split-swap operation is denied. For outgoing trunk calls, the state of the trunk is considered to be in talking state once the trunk is cut-through or the trunk answer supervision timer times out.

The SPLIT button lamp remains lit during the split-swap operation and the SPLIT button lamp flutters if the split-swap operation is denied. The Split-Swap lamp stays off during the split-swap operation.

During the split-swap operation, if you:

- press the SPLIT button, then all parties are joined in conference and further presses of the SPLIT button or the SPLIT-SWAP button are denied.
- press the RELEASE button, then the active call and the split call are connected.
- press the HOLD button, then the active call and the split call are connected, and the connected call is put on hold.
- press the CANCEL button, then the active will drop and the split away party joins with you as the active call.

Example

George calls you and you press the START button and dial Harry, who answers. At this point, George is split away, and Harry and you are in conversation. If you wish to consult with George, but do not want Harry on the same call with George, then you can press the SPLIT-SWAP button which will split Harry away and George is in conversation with you. If you press the SPLIT-SWAP button again, then Harry will be active with you and George is split away.

Feature Name

Split-Swap

Procedures

To activate split-swap:

1. Press the SPLIT-SWAP button.

To deactivate split-swap, do one of the following:

1. Press the SPLIT button and all parties are joined in conference.
2. Press the RELEASE button and the active call and the split call are connected.
3. Press the HOLD button and the active call and the split call are connected and the connected call is put on hold.
4. Press the CANCEL button and the active call drops and the split away party joins with you as the active call.

Interrupting a Call

You can interrupt someone who is on a call.

Example

Telemarketer Sara Adams has a son, Rob, who just broke his leg. Rob's high school coach calls Sara to let her know that they are taking Rob to the hospital. Pat assists Rob's coach by interrupting Sara's existing call. Now Rob's coach can talk to Sara.

Feature Name

Attendant Intrusion

Procedures

To interrupt a call:

1. Dial the desired busy party.
2. Press the INTRUSION button.
3. Give message to called party.
4. Press the RELEASE button.

Exception:

If you interrupt a call with a caller on your line:

- Dial the desired busy party.
- Press the INTRUSION button.

4 Using the Features

Assisting Callers with Special Tools

46

- Press the SPLIT button.
- Press the RELEASE button.

Overriding Diversion Features

Sometimes system users divert their incoming calls to another phone. For example, a user might forward calls to another extension for a lunch break. With this feature, you can bypass a diversion feature to access a desired party. Diversion features include Send All Calls, Call Coverage, Call Forward, and Busy Don't Answer.

Example

The vice president of design and development, Renee Gebner, is working on a tight deadline. She needs uninterrupted time to complete her project, so she forwards all incoming calls to her voice mail. Pat receives an urgent call for Renee and overrides the call forwarding that Renee implemented to reach her at her extension.

Feature Name

Attendant Override of Diversion Features

Procedures

To override diversion features:

1. Press the OVERRIDE button.
2. Dial the desired number.
3. Proceed with your current operation.

Emergency Notification to Digital Telephones

Your system manager dedicates one or more digital telephones to serve as emergency numbers. When system users dial an emergency number (for example, 911), these telephones get notified that an emergency call was made.

Example

Edward Murrow, Widgets, Inc. salesman, just fell down a flight of stairs breaking his leg. Tom Bronaw, who was nearby, calls the emergency extension. As soon as the call is made, all digital telephones with an assigned CRSS-ALERT button are notified with a continuous ring. The following information appears on Pat's display:

```
e= TOM ROBERTS 3041 EMRGENCY
```

Feature Name

Crisis Alert — Every User Responds

Procedures

If you work for a company that has more than one digital telephone and you receive an emergency call, the following occurs at all digital telephones and the attendant console:

1. The CRSS-ALERT button flashes and a continuous ring alerts the designated digital station. The display shows the current crisis alert, overwriting any current display.
2. Because each digital station must acknowledge each alert, each user pushes the CRSS-ALERT button, turning off the ringing and changing the lamp to a steady state.
3. The user records the crisis alert information.
4. The user pushes the NORMAL DISPLAY MODE button and the lamp turns off and the display clears.

Feature Name

Crisis Alert — Single User Responds

Procedures

If you work for a company that has more than one digital telephone and you receive an emergency call, the following occurs at all digital telephones and the attendant console:

1. The CRSS-ALERT button flashes and a continuous ring alerts the designated digital station. The display shows the current crisis alert, overwriting any current display.
2. Because each digital station receives the alert, one user pushes the CRSS-ALERT button, turning off the ringing and clearing the alert from all other stations.

4 Using the Features

Assisting Callers with Special Tools

48

3. The user records the crisis alert information.
4. The user pushes the NORMAL DISPLAY MODE button and the lamp turns off and the display clears.

Providing Emergency Notification to the Operator

Your system manager dedicates an attendant consoles to service emergency calls. When system users dial an emergency number (for example, 911), the console is notified that an emergency call was made.

Example

Jeff Springer, Widgets, Inc. salesman, has just suffered from a heart attack. Bill O'Connor, who works nearby, dials 911. As soon as the call is made, the following information appears on Pat's display:

a= TOM ROBERTS 3041 EMRGNCY

She also hears a siren-like tone.

Feature Name

Crisis Alert to Attendant Console

Procedures

If the attendant receives an emergency call, the following occurs:

1. The CRSS-ALERT button flashes and a continuous ring alerts the attendant console. The display shows the current crisis alert, overwriting any current display.
2. The attendant pushes the CRSS-ALERT button, turning off the ringing.
3. The attendant records the crisis alert information.
4. The attendant pushes the CRSS-ALERT button, changing the lamp to a steady state.
5. The attendant pushes the CRSS-ALERT button and the lamp turns off and the display clears.

Providing Emergency Access to the Operator

Your system manager can administer the switch to allow emergency access calls to the attendant console operator.

Example

Linda Mahoney, Widgets, Inc. spokesperson, has just suffered from a heart attack. Tom Roberts, who works nearby, calls the company's emergency access to attendant feature access code (FAC). As soon as the call is made, the following information appears on Pat's display:

```
a=<Name>           Ext<ext>  00 in EMRG Q
```

She also hears a siren-like tone.

Feature Name

Emergency Access to Attendant

Procedures

If you work for a company that has more than one console and you receive an emergency call, the following occurs at all consoles:

1. A user takes the handset off-hook or dials the feature access code.
 - If the user took the handset off-hook, the call automatically rings at the attendant console after a predetermined amount of time (usually 10 seconds after dial tone stops). The call rings at the console with a louder-than-normal volume. If the guest dialed the feature access code, the call rings immediately at the attendant console.
 - The following displays:

```
a=<Name>           Ext<ext>  00 in EMRG Q
```

2. Follow your local procedures for handling emergencies.

NOTE:

Even if the attendant console is in night service, the call still rings at the attendant console, but it can be answered at the backup telephone with Trunk Answer Any Station, or from a designated emergency redirection telephone.

Placing a Series of Calls

You can manage serial calls for parties who call you from outside lines, needing to speak to a series of system users without hanging up. With this feature, the caller returns to you when the first called party hangs up. You then can transfer the caller to the next party and continue the process until all calls are complete.

Examples

Widgets, Inc. researcher Susan Bealan is in a remote part of the world locating natural resources for manufacturing environmentally-safe bathtub cleanser. She needs to talk to several people at Widgets, Inc. and wants to ensure that she does not lose contact with the company's phone system. Pat uses serial calling to connect Susan on multiple calls.

Feature Name

Attendant Serial Calling

Procedures

To manage a serial call:

1. Answer the call.
2. Press the SERIAL button.
3. Press the START button.
4. Dial the desired extension.
5. Press the RELEASE button.
When the call is complete, it returns to the console.
6. Repeat steps 1 through 5 until all calls are made.
7. Press the SERIAL button to terminate a serial call.

Managing Outside Lines

This section provides feature information for managing outside lines. It describes two types of networks and includes ways to control outside line access, ways to view outside line calling information, and ways to record outside-call information.

Controlling Access to Outside Lines

You can control system users' access to 6 (basic console) or 12 (enhanced console) outside lines. If a user attempts to use one of these outside lines, they automatically redirect to you.

Example

In an effort to increase their profit margins, Widgets, Inc. institutes a controlled long-distance calling plan. Only three customer service representatives may use long distance service and they may only call Widget, Inc. distributors. Pat screens all outgoing customer service calls and when appropriate dials the long-distance numbers for the representatives.

Feature Name

Attendant Control of Trunk Group Access

Procedures

Your system manager programs this information into your console to occur automatically. When a controlled trunk group access call occurs, the display provides you with the following information:

```
a= LINDA WAGNER LOCAL tc
```

- The name of the calling line (a=)
- The calling party's name (Linda Wagner)
- The type of outside line that the calling party tried to access (Local)
- The type of call purpose in use (tc = you have control of outside lines for this call)

Displaying Outside Line Information

This feature provides call information about outside calls. This information appears on your display. When parties on the other end of the call do not have this feature, or faulty transmission causes information to be lost, information may not appear as you expect.

With this feature, the following information appears on your display:

- Calling party's number
The full number, including the area code, of the calling party
- Calling party's name
The name associated with the calling party's phone
- Called party's number
The full number, including the area code, of the called party
- Called party's name
The name associated with the called party's number

4 Using the Features

Using Features for Internal Use

52

- Special call status information (designated by MISCID in this chapter)

Information about the changing status of a call

NOTE:

Sometimes a billing number displays for a calling or called number. For example, the billing number for a pay phone might display rather than the pay phone number.

Choosing Outside Lines

You can select a specific group of outside lines for an outgoing call.

Example

Widgets, Inc. frequently communicates with its parent company, Widgets International, located in Chicago. The system manager, Kelly Ratliffe, assigns one of the buttons in the outside lines select area to Widgets International. To call someone in Widgets International, Pat presses the outside line button labeled Chicago and dials the 7-digit phone number, without having to dial 1 and the area code.

Feature Name

Attendant Direct Trunk Group Selection

Procedures

To select an outside line:

1. Press the desired outside line button.
2. Dial the desired number.

Using Features for Internal Use

This section covers features that you might use internally for a variety of reasons. These reasons may range from restricting calls, to providing system user telephone lists, to testing your equipment. It also includes information specific to accessing console operators and working with non-phone equipment.

Restricting Calls

You can activate or deactivate calling restrictions for individual phones or groups of phones. [Table 7](#) lists the restrictions you can control:

Table 7. Calling Restrictions

Call Type	Users Cannot Do the Following:
Outbound calls	Place outside calls from these phones.
All Calls	Place or receive any calls from these phones.
Station-to-Station	Receive or place internal calls from these phones.
Termination	Receive calls on these phones.
Toll	Place toll calls, but they can place free local calls on these phones.

These restrictions override user privileges established by your system manager. Toll restriction can be substituted for outbound or station-to-station restrictions by your system manager.

Example

Lynn Johnston, telemarketing manager, is starting a special marketing push for out-of-state business. He schedules 3 of his finest telemarketers to place long-distance calls for 4 days. Rather than change the system setup for phone calls, he asks Pat to deactivate outbound call restrictions for these three telemarketers.

Feature Name

Controlled Restrictions

Procedures

To manually activate a restriction:

1. Press the **START** button.
2. Dial the feature access code for controlled restrictions.
3. Dial one of the following restriction code numbers:
 - 1 = Outbound calls/toll calls
 - 2 = All calls
 - 3 = Termination
 - 4 = Phone-to-phone/toll calls
4. Dial the extension you wish to restrict.

5. Select one of the following options:

- If you hear a confirmation tone (3 short bursts of tone), press the RELEASE button.
- If you hear an intercept tone (alternating high-low, siren-like tone or fast busy tone), the extension is already restricted, or you dialed an incorrect code. Press the CANCEL button to retry.

To deactivate a restriction:

1. Press the START button.
2. Dial the restriction deactivation code.
3. Dial one of the following restriction code numbers:

- 1 = Outbound calls/toll calls
- 2 = All calls
- 3 = Termination
- 4 = Phone-to-phone/toll calls

4. Dial the extension that is no longer to be restricted.

5. Select one of the following options:

- If you hear a confirmation tone (3 short bursts of tone), press the RELEASE button.
- If you hear an intercept tone (alternating high-low, siren-like tone or fast busy tone), the extension is already restricted, or you dialed an incorrect code. Press the CANCEL button to retry.

Activating Don't Split

You can disable auto start by pressing the DONT SPLIT button. Don't split allows the system to send dialed touch-tone digits. Some telecommunications equipment requires touch-tone digits to function properly.

Example

Pat needs to call home to retrieve messages from her answering machine. To retrieve these messages, she must press the DONT SPLIT button, disabling auto start. Now, she can access messages from her answering machine.

Feature Name

Don't Split

Procedures

To use don't split:

1. Press the DONT SPLIT button.
2. Dial the desired number.

To deactivate don't split:

1. Press the CANCEL button.

Testing Phone System Components

You can place calls to test 4 components of your phone system:

- Outside lines
- Touch-tone phones
- Time slots
- System tones

Example

System manager Kelly Ratliffe is organizing a department move for accounting. To ensure that all phones are working properly, Kelly asks Pat to test the phones involved in the move. Pat uses facility test call procedures to verify that the phones are functioning properly.

Feature Name

Facility Test Call

Procedures

If you are authorized to perform these 4 tests, your system manager can provide detailed procedures located in the maintenance manuals for your switch.

Accessing Individual Console Operators

Your system manager assigns a personal extension to each console in your system, so that users can dial console operators directly. If you have this feature you can also:

- Be a member of a hunt group (when one line is busy, the system searches for the next available line)

4 Using the Features

Using Features for Internal Use

56

- Activate and deactivate functions associated with hunt groups. (Ask your system manager for more information.)
- Have two calls waiting in your individual call waiting queue

Example

Widgets, Inc. is consolidating telecommunications with parent company, Widgets International. Since the companies are located in different cities, system manager Kelly Ratliffe assigns personal extensions to each console operator. Jonathan Livingston, a telemarketer, has a question specific to Widgets, Inc., so he calls Pat directly.

Feature Name

Individual Attendant Access

Procedures

Your system manager programs console operator extensions to work the same as all other extensions in the system.

Using the Internal Directory

You can retrieve names and their associated extensions from your console. The number of names and extension depends on your switch type and release.

Example

New Widgets, Inc. employee Linda Cassanov needs to find the extension for president Randy Foxworthy but she has not yet received a company telephone directory. She uses the procedures outlined for Integrated Directory to find Randy's number.

Feature Name

Integrated Directory

Procedures

To search for an extension corresponding to a known name:

1. Press the INTGRTD DIRECT button.

appears

2. Press the letters of the desired name on your keypad.

Names with their corresponding extensions appear.

4 Using the Features

Using Features for Internal Use

57

3. Press the NEXT button to advance to the next name.
4. Select one of the following options:
 - Press the MAKE CALL button to call the displayed number.
 - If entered name is not in directory,
 appears.
5. Press another display mode button to exit Integrated Directory mode.

Assigning Main Console Operators

Your system manager designates a console operator from a multi-branch system to answer calls from more than one branch location. Console operators, located at each branch, can answer calls for their branch, but not another branch.

Example

Since Widgets, Inc. combined operations with Widgets International, system manager Kelly Ratliffe programs the console at Widgets International with the capability to answer calls at Widgets, Inc. too. Pat can still answer calls from Widgets, Inc., but cannot answer calls that go to Widgets International. On the other hand, Lee Miller, Widgets International operator, can answer calls for both sites.

Feature Name

Inter-PBX Attendant Calls

Procedures

Follow normal calling procedures.

Leaving Messages

Internal users can leave short, preprogrammed “call me” messages for other internal users. When the system stores a message, the Message Waiting lamp on the called party’s phone lights.

Example

At Widgets, Inc. Pat receives numerous calls for president Randy Foxworthy that require personal attention. When Randy is unavailable to take these calls, Pat uses leave word calling to notify Randy that he has a call that she must discuss with him.

Feature Name

Leave Word Calling

Procedures

To store a message when a phone is busy or a call goes unanswered:

1. Press the START button.
2. Dial the desired extension.
Called party's phone is busy or goes unanswered.
3. Press the LWC button. This leave a preprogrammed "call me" message.
4. Hang up.

To cancel a message you left for a system user:

1. Press the START button.
2. Press the LWC CANCEL button.
3. Dial extension number where message was left.
4. Select one of the following options:
 - If you hear a confirmation tone (3 short bursts of tone), press the RELEASE button.or
 - If you hear a reorder tone (fast busy tone), press the CANCEL button to try again.

Retrieving Messages

You can retrieve messages for other system users. Other system users may or may not be able to retrieve their own messages.

Example

Rich Winston, manager of Widgets, Inc. self-cleaning bathtub manufacturing, needs to retrieve leave word calling messages left for him on his assembly line phone. He calls Pat and Pat sees the following information on her display:

CARTER ANN 2/7 10:45a 2 CALL 3124

Pat tells Rich that Ann Carter called him two times; the last time she called was at 10:45 on February 7; and Ann wants Rich to call her back at extension 3124.

Feature Name

Message Retrieval

Procedures

To retrieve messages:

1. Press the COVER MSG RT button.
Messages display on the display.
2. Read messages, if any, to the system user.
3. Press one of the following buttons for more options:
 - NEXT — Displays the next stored message or displays **END OF MESSAGES**
 - DELETE MSG (Delete Message) — Deletes the displayed message
 - MAKE CALL — Automatically returns the call requested by the currently displayed message

Using Night Service

Your console can automatically answer incoming calls without your assistance.

Example

Widgets, Inc. has a prerecorded message for people who call after hours. When Pat leaves work each night, she places the console in night service and callers hear the after hours message.

Feature Name

Night Service

Procedures

To activate Night Service:

1. Press the NIGHT button.

To deactivate Night Service:

1. Press the NIGHT button.

Routing Calls Economically

Your system can route outgoing calls in the most economical way based on the time of day and the day of the week. Your system manager designates one of up to eight routing plans as the standard routing plan for each day of the week. Your system manager, however, may alter the routing plan with manual or clocked manual override.

Manual Override

When you activate Manual Override, the currently-active routing plan changes immediately to a new plan. The new plan remains in effect until you manually deactivate the override or until the next scheduled routing plan takes effect.

Clocked Manual Override

This option lets your system manager specify the day and time to override the scheduled time-of-day routing plan. Your system manager can also specify a deactivate day and time, or can manually deactivate clocked manual override.

Example

System manager Kelly Ratliffe saves considerable money for Widgets, Inc. by designing automated paths for calls to follow at certain times of the day on certain days of the week. She programs calls placed before 10:00 a.m. from Maine to route through the Los Angeles outside line, and calls placed after 3:00 p.m. from Los Angeles to route through the Portland, Maine line. Widgets, Inc. receives night rates for Portland, Maine calls made before 10:00 a.m. and evening rates for Los Angeles calls made after 3:00 p.m.

Feature Name

Time-of-Day Routing

Procedures

Your system manager programs this information into your console to occur automatically. However, your system manager may ask you to change the normal routing plan. This plan can be changed up to 6 times each day for each day of the week. The two options available for changing the daily routing plan are:

- Immediate Manual Override
- Clocked Manual Override

Your system manager can tell you which option(s) you have and when the option(s) should be activated.

Immediate Manual Override

When you activate this option, the currently active routing plan is changed immediately to a new plan. The new plan remains in effect until the override is deactivated manually or until the next scheduled routing plan takes effect.

To activate Immediate Manual Override:

NOTE:

The Immediate Override lamp is lit if this option is already active.

1. Press the Immediate Override button.
 - The Immediate Override lamp lights.
 - The first line of display shows:
OLD ROUT PLAN: x ENTER NEW PLAN:
(Where x is a number from 1 through 8 that identifies the routing plan currently in effect.)
2. Use the touch-tone buttons to enter the number (from 1 through 8) of the new routing plan.
 - The Immediate Override lamp remains steadily lighted
 - Display updates to:
OLD ROUTE PLAN: x ENTER NEW PLAN: y
(Where y is the number you just entered.)

NOTE:

If you pressed any button other than the 1 through 8 buttons on the dialpad, the Immediate Manual Override attempt is denied; the display returns to the Normal mode. You must repeat step 1 to try again.

3. Press the Immediate Override or Normal Mode button.
 - The Immediate Override lamp remains steadily lighted.
 - Immediate Manual Override is active.

To deactivate Immediate Manual Override:

1. Press the Immediate Override button.
 - The Immediate Override lamp goes out.
 - Scheduled daily routing plan goes into effect immediately.

Clocked Manual Override

This option lets you specify the day and time to override the scheduled Time-of-Day routing plan. You also can specify a deactivate day and time, or you can manually deactivate Clocked Manual Override.

In the following procedure, a number from 1 through 8 specifies the desired routing plan; a number from 1 through 7 specifies the day (1 is for Sunday and 7 is for Saturday). The time is specified in military hours (0000 for 1:00 a.m. and 2359 for midnight).

To activate Clocked Manual Override:

NOTE:

The Clocked Override lamp is lit if this option is already active.

1. Press the Clocked Override button.
 - The Clocked Override lamp lights.
 - First line of display shows:
ENTER ACTIVATE ROUTE PLAN, DAY & TIME
2. Use the touch-tone dialpad to enter the following in the order shown:
Press the 1 through 8 button (to specify the routing plan) and the 1 through 7 button (to specify the day) 0000 through 2359 (to specify the hour).
 - The Clocked Override lamp remains steadily lighted.
 - Display shows:
ROUTE PLAN: x FOR: yyy ACT-TIME: zz:zz

(Where x is the routing plan number, yyy is the 3-letter abbreviation for the day of the week, and zz:zz is the activation hour.)

NOTE:

If you enter any invalid information, the Clocked Manual Override attempt is denied; the display returns to the Normal mode. You must repeat step 1 to try again.

To enter a deactivate date:

1. Press the Clocked Override to confirm activation input data and to enter deactivation time.
 - The Clocked Override lamp remains steadily lighted.
 - Display shows:
ENTER DEACTIVATION DATE & TIME

2. Enter the following in the order shown:
 - 1 through 7 (to specify the day)
 - 0000 through 2359 (to specify the hour)
 - Display shows:

```
ROUTE PLAN: x FOR: yyyy DEACT-TIME: zz:zz
```

(Where x is the routing plan number, yyy is the 3-letter abbreviation for the day of the week, and zz:zz is the activation hour.)
3. Press the Clocked Override or Normal Mode button.
 - The Clocked Override lamp remains steadily lighted.
 - Clocked Manual Override is active.

To manually deactivate Clocked Manual Override:

1. Press the Clocked Override button.
 - The Clocked Override lamp goes out.
 - Scheduled daily routing plan goes into effect immediately.

Using Visually Impaired Attendant Service

Your console provides 8 buttons for voiced feedback for visually-impaired console-operators. [Table 8](#) lists the 8 buttons and their function:

Table 8. Using VIAS Buttons

Button Name	Voiced Function
ACTIVATION/DEACTIVATION	Tells how to activate or deactivate this feature.
CONSOLE STATUS	Console's current status
DISPLAY STATUS	Display information
LAST OPERATION	Last completed operation
LAST VOICED MESSAGE	Last message or digit sent to the console
DIRECT TRUNK GROUP SELECTION STATUS	Available outside lines
CLASS OF RESTRICTION	Current caller's calling privileges
INSPECT	Tells what features are assigned to other buttons

 **NOTE:**

This feature requires at least one speech processor circuit pack to be installed into a system port carrier, since you can perform VIAS capabilities with speech synthesis messages that system users voice to you.

The HELP number for visually impaired users is 1-800-233-1222.

Example

Pat is taking a leave of absence from Widgets, Inc. Her replacement, Lindsey Buller, is visually impaired. Kelly Ratliffe, system manager, programs her console with VIAS, and acquaints her with the location of each VIAS button. Lindsey must ensure that she activates the VIAS feature each day. A call comes in for president Randy Foxworthy and unfortunately, Lindsey forgets who just called. Lindsey simply presses the LAST VOICED MESSAGE button to find out who just called.

Feature Name

VIAS

Procedures

To use visually impaired services:

1. Press the ACTIVATION/DEACTIVATION button to activate the service for the console.
2. Press one of the buttons listed above.
3. Press the ACTIVATION/DEACTIVATION button to deactivate the service.

 **NOTE:**

System initialization, does not automatically activate VIAS. After a warm RESTART button operation, VIAS remains activated.

RECOVERY and cold RESTART button operations do not automatically activate VIAS even if it was activated before the RECOVERY or RESTART button attempt.

When the attendant console busyouts and VIAS is active, VIAS automatically deactivates.

Centralized Attendant Service

5

Centralized Attendant Service (CAS) allows multi-switch systems at more than one location to consolidate console operators at one location. This location is “CAS main.” The other locations, typically without console operators, are CAS branches.

Identifying Differences in a CAS Environment

Managing calls in the CAS environment is primarily the same as in standard environments. However, some differences occur, because CAS environments use a dedicated outside line to manage branch calls. This section identifies the differences between standard operations and CAS operations and describes how to use features in a CAS environment.

The following features do not function in a CAS environment:

- Attendant Auto-Manual Splitting
- Attendant Conference

The following features function differently in a CAS environment.

- Tones
- Display
- Transferring calls
- Night service

Using CAS-Associated Tones

In addition to the standard console tones, a CAS console has the following call identification tones:

Table 9. Ringing and Tones Descriptions

Tone	Pitch	Frequency	Meaning
Listed Directory Number	on-off, low	three short bursts	Identifies a call from an outside line
“0”	on-off, low	single	Identifies a branch location call to the console operator
Recall on Call Waiting	low	single	Routes unattended calls on call waiting to you
Recall on Remote Hold	on-off, low	4–6 cycles	Routes unattended remote hold calls to you
Recall on Don’t Answer	medium	.25 second	Routes unanswered calls to you
Incoming Call Identification	determined by system manager	determined by system manager	Identifies the calling branch location

Using a CAS Display

In addition to standard display information, you can view the following incoming calls information from branch locations:

Table 10. Incoming Branch Location Displays

Type of Call	Display Shows
Listed Directory Number	Incoming outside line name
Dial 0	Caller’s name and extension
Remote hold recall	Caller’s name and extension
Others (Including Coverage Calls)	Name and number of the outside line dedicated for handling branch calls.

Using CAS Operating Procedures

Operating procedures for CAS environments work similarly to standard environments. However, transferring calls, placing calls on hold, console backup services, and night service function differently in CAS environments. The following section describes these procedures in detail.

Transferring CAS Calls

To transfer CAS calls:

1. Press the CALL APPEARANCE button.
2. Listen for a call identification tone (if provided by the branch).
3. Press the START button.
4. Listen for a dial tone.



NOTE:

Do not continue until you hear a dial tone. The call does not go through if you proceed before the dial tone sounds.

5. Dial the requested internal or external number.
6. Select one of the following options:
 - If you are not going to announce the call, press the RELEASE button as soon as the call starts to ring.

or

- If you are going to announce the call, wait for the called party to answer. When the called party accepts the call, press the RELEASE button.

If the called party declines to talk to the caller, press the CANCEL button to reconnect with the caller.

Explain to the caller that the called party is not available; take a message or ask the caller to try again later; then press the RELEASE button.

or

- If the called party, is busy or doesn't answer, press the CANCEL button to reconnect with the caller.

Explain to the caller that the called party cannot be reached. If the caller wants to wait, transfer the call again; then press the RELEASE button.

If the caller does not want to wait, take a message and press the RELEASE button.

Placing Calls on Remote Hold

When calls for a branch location need to be placed on hold, you should use remote hold (not hold). Using remote hold frees the outside line that your system manager dedicated for branch calls.

To place calls on remote hold:

1. Press the START button.
2. Dial the remote hold feature access code.
3. Listen for confirmation tone (3 short bursts of tone).
4. Press the RELEASE button.

Using CAS Backup Service

In addition to standard backup service, phones at remote branch locations can serve as backup phones for a CAS console.

Using CAS Night Service Operations

In addition to standard night service operations, phones with multiple or single lines at remote branch locations can answer night service calls. Below are descriptions for handling night calls from phones with multiple or single lines.

Multi-Line Phone — Night Service Operations

Handling night service calls from multi-line phones is similar to transferring calls from a console. You can transfer calls from a multi-line phone with:

- A FLASH button.
- A CONFERENCE button.
- A TRANSFER button.

Transferring CAS Calls

To transfer a CAS call from a multi-line phone:

1. Press the call appearance button where the green lamp is flashing.

2. Listen for call identification tone (if provided by the branch).
3. Answer the call.
4. Select one of the following options:
 - Press the FLASH button. Flash lamp lights for 2 seconds.
 - Press the CONFERENCE button.
 - Press the TRANSFER button.
5. Dial the requested number.
6. End the call by hanging up or by pressing another call appearance button, the DISCONNECT button, or the DROP button.

If your phone has a display, it may also be have an OUTSIDE LINE button. By pressing the OUTSIDE LINE button while on an active call you can view the branch name, or the name of an outside line.

Placing CAS Calls on Remote Hold

To place a CAS call on remote hold from a multi-line phone:

1. Select one of the following options:
 - Press the FLASH button.
 - Press the CONFERENCE button.
 - Press the TRANSFER button.
2. Dial the remote hold feature access code.
3. Select one of the following options:
 - Hang up.

or

- Press one of the following:
 - CALL APPEARANCE button
 - DISCONNECT button
 - DROP button

Cancelling CAS Calls

To cancel a CAS call from a multi-line phone:

1. Select one of the following options:
 - Press the FLASH button

- Press the CONFERENCE button
- Press the TRANSFER button

The transferred call drops, or remote hold deactivates.

Single-Line Phone — Night Service Operations

If a single-line phone performs night service, the user flashes the switchhook to transfer CAS calls. You can place CAS calls on remote hold any time a caller wishes to wait; however, CAS calls cannot be placed on hold at a single-line phone.

Transferring CAS calls

To transfer a CAS call from a single-line phone:

1. Answer the call.
2. Flash the switchhook.
3. Dial the requested extension number.
4. Hang up.

Placing CAS calls on Remote Hold

To place a CAS call on remote hold from a single-line phone:

1. Answer the call.
2. Flash the switchhook.
3. Dial the remote hold feature access code.
4. Listen for the remote hold confirmation tone (3 short bursts of tone).
5. Hang up.

Routine Maintenance

6

Routine testing and cleaning for your console is quite simple. This chapter provides step-by-step procedures for testing your console, describes cleaning procedures, and discusses what you need to do in the case of a power outage.

Testing the Console

It is important for you to test your console's display and console lamps weekly. If a problem occurs with the display or one of the lamps, notify your system manager.

To test the display and the lamps on a 302A/B console:

1. Open the panel on the front of the console (see [Figure 1 on page 6](#) or [Figure 2 on page 7](#)).
2. Press and hold the lamp test switch (located at the left front of the console). The following should occur:
 - All lamps in the display should light.
 - Each row of lamps on the console and the selector console should light and go dark in sequence from top to bottom.
 - The timed-reminder tone (high-pitched, .5 second tone) sounds.
3. Release the Lamp Test switch.
 - Lamps return to their former state.
 - The timed-reminder tone silences.
4. Close the panel.

To test the display and lamps on a 302C console:

1. Press the POS BUSY and VOLUME UP button simultaneously.
2. When finished, press POS BUSY to place console back in service

Cleaning Your Console

To clean the console, use a slightly-dampened paper towel or soft cloth. Oily substances on the console may require considerable rubbing or the use of a mild cleaner, such as window cleaner or desk and office cleaner. If you use a cleaner, do not apply it directly to the console; instead, apply it to the cloth, then rub it onto the console.

Do not spill any type of liquid on the console. Liquids spilled on the console damage the electronic components.

Commercial Power Failure

If commercial power fails, the system's battery backup keeps your console operating for a short time. When this short time expires, the power failure transfer automatically activates, and the console does not function. When power returns, consoles return to normal operation.

When power fails, all active calls and all calls on hold are lost. Also, a power failure affects the following features that require corrective action:

- Attendant Control of Trunk Group Access — Reestablish control of desired outside lines.
- Call Forwarding All Calls — Reactive Call Forwarding All Calls for desired extension numbers.
- Controlled Restrictions — Reestablish control of desired phones or groups of phones.
- Night Service — Reactivate Night Service as desired.

Glossary and Abbreviations

A

AAR

See [Automatic Alternate Routing \(AAR\)](#).

Abbreviated Dialing (AD)

A feature that allows callers to place calls by dialing just one or two digits.

AAR

Automatic Alternate Routing

ACD

See [Automatic Call Distribution \(ACD\)](#).

access code

A 1-, 2-, or 3-digit dial code used to activate or cancel a feature, or access an outgoing trunk.

ACD

See [Automatic Call Distribution \(ACD\)](#). ACD also refers to a work state in which an agent is on an ACD call.

AD

See [Abbreviated Dialing \(AD\)](#).

administer

To access and change parameters associated with the services or features of a system.

administration terminal

A terminal that is used to administer and maintain a system. See also [terminal](#).

appearance

A software process that is associated with an extension and whose purpose is to supervise a call. An extension can have multiple appearances. Also called call appearance, line appearance, and occurrence. See also [call appearance](#).

ARS

See [Automatic Route Selection \(ARS\)](#).

attendant

A person at a console who provides personalized service for incoming callers and voice-services users by performing switching and signaling operations. See also [attendant console](#).

attendant console

The workstation used by an attendant. The attendant console allows the attendant to originate a call, answer an incoming call, transfer a call to another extension or trunk, put a call on hold, and remove a call from hold. Attendants using the console can also manage and monitor some system operations. Also called console. See also [attendant](#).

Automatic Alternate Routing (AAR)

A feature that routes calls to other than the first-choice route when facilities are unavailable.

Automatic Call Distribution (ACD)

A feature that answers calls, and then, depending on administered instructions, delivers messages appropriate for the caller and routes the call to an agent when one becomes available.

Automatic Call Distribution (ACD) split

A method of routing calls of a similar type among agents in a call center. Also, a group of extensions that are staffed by agents trained to handle a certain type of incoming call.

Automatic Route Selection (ARS)

A feature that allows the system to automatically choose the least-cost way to send a toll call.

B

barrier code

A security code used with the Remote Access feature to prevent unauthorized access to the system.

BLF

Busy Lamp Field

bridge (bridging)

The appearance of a phone's extension at one or more other phones.

bridged appearance

A call appearance on a phone that matches a call appearance on another phone for the duration of a call.

C

call appearance

1. For the attendant console, six buttons, labeled a–f, used to originate, receive, and hold calls. Two lights next to the button show the status of the call appearance.
2. For the phone, a button labeled with an extension and used to place outgoing calls, receive incoming calls, or hold calls. Two lights next to the button show the status of the call appearance.

Call Detail Recording (CDR)

A feature that uses software and hardware to record call data (same as CDRU).

CAS

Centralized Attendant Service or Call Accounting System

CDR

See [Call Detail Recording \(CDR\)](#).

Class of Restriction (COR)

A feature that allows up to 64 classes of call-origination and call-termination restrictions for phones, voice-terminal groups, data modules, and trunk groups. See also [Class of Service \(COS\)](#).

Class of Service (COS)

A feature that uses a number to specify if voice-terminal users can activate the Automatic Callback, Call Forwarding All Calls, Data Privacy, or Priority Calling features. See also [Class of Restriction \(COR\)](#).

communications system

The software-controlled processor complex that interprets dialing pulses, tones, and keyboard characters and makes the proper connections both within the system and external to the system.

The communications system itself consists of a digital computer, software, storage device, and carriers with special hardware to perform the connections. A communications system provides voice and data communications services, including access to public and private networks, for telephones and data terminals on a customer's premises. See also [switch](#).

confirmation tone

A tone confirming that feature activation, deactivation, or cancellation has been accepted.

console

See [attendant console](#).

COR

See [Class of Restriction \(COR\)](#).

COS

See [Class of Service \(COS\)](#).

coverage call

A call that is automatically redirected from the called party's extension to an alternate answering position when certain coverage criteria are met.

D

Direct Extension Selection (DXS)

A feature on an attendant console that allows an attendant direct access to phones by pressing a group-select button and a DXS button.

E

external call

A connection between a communications system user and a party on the public network or on another communications system in a private network.

F

FAC

Feature Access Code

facility

A telecommunications transmission pathway and associated equipment.

feature

A specifically defined function or service provided by the system.

feature button

A labeled button on a telephone or attendant console used to access a specific feature.

I

inside call

A call placed from one telephone to another within the local communications system.

Integrated Services Digital Network (ISDN)

A public or private network that provides end-to-end digital communications for all services to which users have access by a limited set of standard multipurpose user-network interfaces defined by the CCITT. Through internationally accepted standard interfaces, ISDN provides digital circuit-switched or packet-switched communications within the network and links to other ISDNs to provide national and international digital communications. See also [Integrated Services Digital Network Primary Rate Interface \(ISDN-PRI\)](#).

Integrated Services Digital Network Primary Rate Interface (ISDN-PRI)

The interface between multiple communications systems that in North America includes 24 64-kbps channels, corresponding to the North American digital signal level-1 (DS1) standard rate of 1.544 Mbps. The most common arrangement of channels in ISDN-PRI is 23 64-kbps B-channels for transmitting voice and data and 1 64-kbps D-channel for transmitting associated B-channel call control and out-of-band signaling information. With nonfacility-associated signaling (NFAS), ISDN-PRI can include 24 B-channels and no D-channel. See also [Integrated Services Digital Network \(ISDN\)](#).

intercept tone

A tone that indicates a dialing error or denial of the service requested.

internal call

A connection between two users within a system.

ISDN trunk

A trunk administered for use with ISDN-PRI. Also called ISDN facility.

L

line

A transmission path between a communications system or CO switching system and a phone or other terminal.

line appearance

See [appearance](#).

LWC

Leave Word Calling

M

multiappearance phone

A terminal equipped with several call-appearance buttons for the same extension, allowing the user to handle more than one call on that same extension at the same time.

N

network

A series of points, nodes, or stations connected by communications channels.

P

PBX

Private branch exchange

PRI

See [Primary Rate Interface \(PRI\)](#).

Primary Rate Interface (PRI)

A standard ISDN frame format that specifies the protocol used between two or more communications systems. PRI runs at 1.544 Mbps and, as used in North America, provides 23 64-kbps B-channels (voice or data) and one 64-kbps D-channel (signaling). The D-channel is the 24th channel of the interface and contains multiplexed signaling information for the other 23 channels.

principal

A terminal that has its primary extension bridged on one or more other terminals.

principal (user)

A person to whom a telephone is assigned and who has message-center coverage.

private network

A network used exclusively for the telecommunications needs of a particular customer.

public network

The network that can be openly accessed by all customers for local and long-distance calling.

Q

queue

An ordered sequence of calls waiting to be processed.

S

SAC

Send All Calls

simulated bridged appearance

The same as a temporary bridged appearance; allows the terminal user (usually the principal) to bridge onto a call that had been answered by another party on his or her behalf.

single-line phone

A phone served by a single-line tip and ring circuit (models 500, 2500, 7101A, 7103A).

split

See [AD](#).

status lamp

A green light that shows the status of a call appearance or a feature button by the state of the light (lit, flashing, fluttering, broken flutter, or unlit).

switch

Any kind of telephone switching system. See also [communications system](#).

switchhook

The buttons located under the receiver on a phone.

system administrator

The person who maintains overall customer responsibility for system administration. Generally, all administration functions are performed from the Management Terminal. The switch requires a special login, referred to as the system administrator login, to gain access to system-administration capabilities.

T

TAAS

Trunk Answer from Any Station

terminal

A device that sends and receives data within a system. See also [administration terminal](#).

U

Uniform Dial Plan (UDP)

A feature that allows a unique 4- or 5-digit number assignment for each terminal in a multiswitch configuration such as a DCS or main-satellite-tributary system.

Index

Numerics

- 302A/B console diagram, [6](#)
 - 302C console diagram, [7](#)
-

A

- abbreviated dialing, [30](#)
 - see speed dialing, [30](#)
- accessing individual operators, [55](#)
- activating don't split
 - see don't split, [54](#)
- activating the console, [24](#)
- alarm lamp, [10](#)
- alarm reported lamp, [10](#)
 - maintenance communications, [10](#)
- alarms
 - alarm reported lamp, [10](#)
 - alarm, maintenance required, [10](#)
- alphanumeric display
 - call purpose, [16](#)
 - call status, [17](#)
 - calling privileges, [16](#)
 - cover msg rt button, [13](#)
 - date time button, [13](#)
 - delete msg, [14](#)
 - incoming call button, [14](#)
 - inspect mode button, [13](#)
 - intgrtd directory, [14](#)
 - make call button, [14](#)
 - next button, [14](#)
 - normal mode button, [13](#)
 - stored number buttons, [14](#)
 - timer button, [13](#)
- answering emergency calls, [27](#)
- atnd lamp, [8](#)
- attendant backup, [35](#)
 - see backing up the console, [35](#)
- attendant call waiting, [43](#)
 - see using call waiting, [43](#)
- attendant conference, [31](#)
 - see connecting multiple callers, [31](#)
- attendant control of trunk group access, [50](#), [72](#)
 - see controlling access to outside lines, [50](#)
- attendant direct trunk group selection, [52](#)
 - see choosing outside lines, [52](#)
- attendant intrusion, [45](#)
 - see interrupting a call, [45](#)
- attendant lockout, [32](#)
 - see locking out the operator, [32](#)
- attendant override of diversion features, [46](#)
 - see overriding diversion features, [46](#)

- attendant recall, [32](#)
 - see recalling the operator, [32](#)
 - attendant serial calling, [49](#)
 - see placing a series of calls, [49](#)
 - auto start, [24](#), [29](#)
 - automatic alternate routing and automatic route selection, [52](#)
 - see choosing the best route for calls, [52](#)
-

B

- backing up the console, [35](#)
 - branch locations, [66](#)
 - busy lamp, [7](#)
 - busy lamp field (BLF), [19](#)
 - buttons
 - cancel, [10](#)
 - cover msg rt, [13](#)
 - date time, [13](#)
 - delete msg, [14](#)
 - feature button area, [12](#)
 - incoming call, [14](#)
 - inspect mode, [13](#)
 - intgrtd directory, [14](#)
 - make call, [14](#)
 - next, [14](#)
 - normal mode, [13](#)
 - release, [10](#)
 - start, [10](#)
 - stored number, [14](#)
 - timer, [13](#)
-

C

- call appearance button, [8](#)
- call appearance buttons, [8](#)
 - atnd lamp, [8](#)
- call appearance buttons
 - hold lamp, [8](#)
- call coverage, [35](#)
 - see covering calls from the console, [35](#)
- call forwarding all calls, [36](#), [72](#)
 - see forwarding all calls, [36](#)
- call park, [37](#)
 - see parking calls, [37](#)
- call processing indicators
 - alarm lamp, [10](#)
 - alarm reported lamp, [10](#)
 - call waiting lamp, [10](#)
 - calls waiting warning, [11](#)
 - individual calls waiting lamp, [11](#)
 - pos avail lamp, [11](#)
- call purpose, [16](#)
- call purpose identifiers, [16](#)
- call status, [17](#)
- call status identifiers, [18](#)

- call waiting warning, [11](#)
- called-party identification, [15](#)
- caller information, [14](#)
- call-handling buttons
 - cancel, [10](#)
 - release, [10](#)
 - start, [10](#)
- calling other console operators, [57](#)
- calling privilege identifiers, [16](#)
- calls waiting lamp, [10](#)
- cancel button, [10](#)
- cancelling CAS calls, [69](#)
- CAS alphanumeric display, [66](#)
- CAS backup service, [68](#)
- CAS night service, [68](#)
 - using multi-line phones, [68](#)
- CAS night service operations, [68](#)
- CAS tones, [66](#)
- chime paging, [39](#)
- choosing outside lines, [52](#)
- choosing the best route for calls, [52](#)
- cleaning the console, [72](#)
- clocked manual override, [62](#)
- code calling access, [39](#)
 - see chime paging, [39](#)
- commercial power failure, [72](#)
- conference calls, [26](#)
- connecting callers, [26](#)
- connecting multiple callers, [31](#)
- console
 - 302A/B, [5](#), [6](#)
 - 302C, [5](#), [7](#)
 - activating the, [24](#)
 - cleaning the, [72](#)
 - deactivating the, [24](#)
 - layout, [5](#)
 - selector console area, [19](#)
 - testing the 302A/B, [71](#)
 - testing the 302C, [72](#)
 - tones, [21](#)
- control lamp, [8](#)
- controlled restrictions, [52](#), [72](#)
 - restricting calls, [52](#)
- controlling access to outside lines, [50](#)
- conventions used in document, [2](#)
- cover msg rt button, [13](#)
- covering calls from the console, [35](#)
- crisis alert, [48](#)
 - providing emergency notification to the operator, [48](#)
 - see emergency notification to digital telephones, [46](#)
 - single user responds, [47](#)

D

- date time button, [13](#)
- deactivating the console, [24](#)
- delete msg button, [14](#)

dialing keypad area, [9](#)
direct extension selection (DXS), [19](#)
display, [12](#)
 called-party identification, [15](#)
 caller information, [14](#)
 diagram, [12](#)
don't split, [54](#)

E

emergency calls, [27](#)
emergency notification
 every user responds, [46](#)
exceptions
 transferring, [26](#)
extension number status, [20](#)

F

feature access codes, [29](#)
feature button area, diagram, [12](#)
forwarding all calls, [36](#)

H

hold, [31](#)
 placing calls on, [26](#)
hold lamp, [8](#)
hold-automatic, [31](#)
 see holding calls automatically, [31](#)
holding calls automatically, [31](#)
hundreds group select (HGS), [19](#)

I

immediate manual override, [61](#)
incoming call button, [14](#)
individual attendant access, [55](#)
 accessing individual operators, [55](#)
individual calls waiting, [11](#)
inspect button, [13](#)
integrated directory, [56](#)
 using the internal directory, [56](#)
Inter-PBX attendant calls, [57](#)
 calling other console operators, [57](#)
interrupting a call, [45](#)
intgrtd directory button, [14](#)

L

- lamp-test switch, [6](#)
 - leave word calling, [57](#)
 - leaving messages, [57](#)
 - leaving messages, [57](#)
 - locking out the operator, [32](#)
 - loudspeaker paging, [41](#)
 - paging with voice paging, [41](#)
 - loudspeaker paging access — deluxe, [33](#), [42](#)
 - paging with deluxe voice paging, [33](#), [42](#)
-

M

- make call button, [14](#)
 - message retrieval, [58](#)
 - retrieving messages, [58](#)
 - multi-line phone handling, [68](#)
 - multiple listed directory numbers, [35](#)
 - routing calls through the operator, [35](#)
-

N

- next button, [14](#)
 - night service, [59](#), [72](#)
 - using night service, [59](#)
 - normal mode, [14](#)
 - call purpose, [16](#)
 - call status, [17](#)
 - called-party identification, [15](#)
 - caller information, [14](#)
 - calling privileges, [16](#)
 - incoming call button, [14](#)
 - normal mode button, [13](#)
 - normal mode displays, [14](#)
-

O

- outside line buttons
 - busy lamp, [7](#)
 - outside lines buttons
 - control lamp, [8](#)
 - diagram, [8](#)
 - warning lamp, [8](#)
 - overriding diversion features, [46](#)
-

P

- paging with deluxe voice paging, [33](#), [42](#)

paging with voice paging, [41](#)
parking calls, [37](#)
placing a series of calls, [49](#)
placing calls on hold, [26](#)
placing remote-hold calls, [68](#)
pos avail, [11](#)
position available, see pos avail, [11](#)
principal, [23](#)
principal console, [23](#)
providing emergency access to the operator, [48](#)
providing emergency notification to the operator, [48](#)

R

recalling the operator, [32](#)
release button, [10](#)
remote hold, [68](#), [69](#), [70](#)
restricting calls, [52](#)
retrieving messages, [58](#)
ringer volume, [18](#)
ringing and tones descriptions, [21](#)
ringing descriptions, [21](#)
routing calls economically, [60](#)
 clocked manual override, [62](#)
 immediate manual override, [61](#)
routing calls through the operator, [35](#)

S

security measures, [2](#)
select button, [7](#)
selector console area, [19](#)
 diagram, [20](#)
single-line phone night service, [70](#)
speed dialing, [30](#)
split-swap, [44](#)
start button, [10](#)
stored number button, [14](#)
system user calling privileges, [16](#)

T

terminating a call
 release button, [10](#)
testing facilities, [55](#)
testing the 302A/B console, [71](#)
testing the 302C console, [72](#)
time-of-day routing, [60](#)
 clocked manual override, [62](#)
 immediate manual override, [61](#)
 routing calls economically, [60](#)
timer
 select button, [7](#)

timer button, [13](#)
tones, [21](#)
 CAS-associated tones, [66](#)
transferring calls, [24](#), [25](#)
 externally, [25](#)
 internally, [24](#)
 outside numbers, [25](#)
transferring CAS calls, [67](#), [68](#), [70](#)

U

user calling privileges, [16](#)
using call waiting, [43](#)
using night service, [59](#)
using the internal directory, [56](#)

V

VIAS, *see* Visually Impaired Attendant Service
Visually Impaired Attendant Service, [63](#)
volume
 ringer volume control, [18](#)
volume control, [18](#)

W

warning lamp, [8](#)

