

COMDIAL

Installation Instructions For The Analog Terminal Interface (ATI-D)

TABLE OF CONTENTS

Chapter 1 Introduction	1-1
General Information	1-1
Unit Description	1-1
Specifications	1-2
Chapter 2 Installation and Programming	2-1
Section 1 Installation	2-1
Mounting Considerations	2-1
Mounting Procedure	2-1
Installation Procedure	2-2
Verifying Proper Installation	2-2
Installing OPX Long Loop Adapter For Off-Premise Service	2-4
Installing ExecuMail and ExecuMail Jr. Voice Mail Interface	2-5
Section 2A Programming Requirements for the ExecuMail System	2-6
Programming Options	2-6
Programming Procedures	2-7
Section 2B Programming Requirements for the Industry-Standard Telephone	2-9
Programming Options	2-9
Programming Procedures	2-10
Section 2C Programming for System Interconnection	2-11
Chapter 3 Operation	3-1
Section 1 Industry-Standard Telephone Operation	3-1
Chapter 4 Maintenance	4-1
Technical Assistance And Repair Service	4-1

LIST OF ILLUSTRATIONS

Figure 1. Outline Drawing	2-1
Figure 2. Connection Details	2-2
Figure 3a. IST Interconnection	2-3
Figure 3b. System Interconnection	2-3
Figure 4. IST Interconnection (with OPX Adapter)	2-4
Figure 5. System Interconnection (with ExecuMail or ExecuMail Jr.)	2-5

CHAPTER 1 INTRODUCTION

GENERAL INFORMATION

This publication describes the features, applications, installation, specifications, and operation of the Comdial Analog Terminal Interface (ATI-D). The ATI-D is a multipurpose, on-premise accessory for the digital telephone system. It has dual circuits that provide the following features:

- **INDUSTRY-STANDARD TELEPHONE (IST) INTERFACE** - This feature adapts most industry-standard telephone (IST) devices to the digital telephone system. The ATI-D will accept both tone (DTMF) and pulse (rotary) dialing from these devices.
- **SYSTEM INTERCONNECTION** - This feature allows two digital telephone systems to be connected to each other using two ATI-Ds and on-premise wiring. When interconnected, either telephone system treats the other telephone system as an IST device. The two telephone systems are not integrated together and do not share features.
- **MODEM ADAPTER** - This feature allows the flow of switched data between a data source and a data receiver through the digital telephone system.
- **VOICE MAIL/ANSWERING MACHINE INTERFACE** - This feature allows the Comdial ExecuMail and ExecuMail Jr. systems, as well as other automated answering devices to be connected to the digital telephone system.

CAUTION

The ATI-D by itself does not support any off-premise service. Never connect the ATI-D to a telephone company-supplied line unless an acceptable OPX long loop adapter is installed. Refer to page 2-4 for adapter installation instructions.

CAUTION

Digital telephone system software revision 11A or later is required for support of ExecuMail or ExecuMail Jr. Do not attempt to connect any ExecuMail package to a Comdial digital telephone system using earlier software revisions (check the label on the system software cartridge for the number/letter designation that follows "SW" to determine the software revision level.)

UNIT DESCRIPTION

The ATI-D is housed in a self-contained metal enclosure that can be wall mounted if desired (see Figure 1). The ATI-D is powered by the digital telephone system through the station port connections and employs an internal ringing generator to generate a ringing signal for an IST. Dual, high-quality, low-loss, balanced, telephone transmission circuitry supports two IST inputs.

One 2-pair cable (four-wire) is used to connect the ATI-D to two common equipment station ports. A single pair of wires is used to connect the external analog IST equipment to the ATI-D. Modular connectors are provided to allow quick connections.

Each ATI-D circuit will drive a load with a maximum ringer equivalence number (REN) of 2.0, thus allowing more than one IST connection at each interface input. Check the REN number of the connected IST equipment so as not to exceed the capacity of the ATI-D. Improper operation may result if the REN maximum of the ATI-D is exceeded.

The ATI-D supports a wide variety of IST equipment such as 500 and 2500-type telephones, cordless telephones, Comdial ExecuMail and ExecuMail Jr., answering machines, FAX machines, and data modems.

SPECIFICATIONS

ELECTRICAL

Power requirements:	Supplied by the common equipment
Ringin voltage:	55 VAC Nominal @ 20 Hz (45 VAC minimum) Power rated to maximum REN = 2.0
Battery feed voltage:	24 VDC nominal
Loop current limits between ATI-D and IST interface:	20 ma min. at 620 ohms 70 ma max. at 0 ohms
DC loop limits from ATI-D to industry standard interface per port:	620 ohms maximum including interfaced telephony device. (Approximately 4000 feet with #26 AWG twisted-pair cable and 300 ohm device load.) (Approximately 500 feet if two IST devices are connected in parallel on same tip and ring pair.)
DC loop limits from ATI-D to ExecuMail or ExecuMail Jr. voice mail system:	Approximately 1000 feet with #26 AWG twisted-pair cable.
Cable insulation resistance:	30,000 ohms minimum
Cable requirement ATI-D to common equipment:	2-pair twisted cable; 25 feet maximum length. (Both common equipment station ports must always be connected to the ATI-D for every installation, and they must be paired in sequence -- 12 & 13, 14 & 15, etc.)
Cable terminations:	623-type, 4-conductor minijacks
Dialing:	Industry-standard DTMF or Dial pulse (rotary) with nominal make/break ratio of 40/60 @ 10 PPS
Ringin cadence:	Outside calls = 2 second on - 4 seconds off Intercom calls = Two bursts: 1 second on - .5 second off, 1 second on - 3.5 seconds off

ENVIRONMENTAL

Operating temperature:	32-122 F (0-50 C)
Humidity:	90 % relative, non-condensing

MECHANICAL

Height:	2.375 inches
Width:	8.062 inches
Length:	11.125 inches
Weight:	4 lbs. (plus 2 lbs. for packing material)

INDUSTRY/REGULATORY STANDARDS

FCC registered and listed for safety compliance as part of digital telephone system

FCC certified, Part 15 (class A)

CHAPTER 2 INSTALLATION AND PROGRAMMING

SECTION 1 INSTALLATION

MOUNTING CONSIDERATIONS

1. The ATI-D can be attached to any sturdy, flat surface.
2. The distance between the ATI-D and the common equipment must be 25 feet or less.
3. The mounting location must be secure and dry and have adequate ventilation. The temperature range of the location must be within 32-122° F (0-50° C).
4. If the mounting surface is damp or if it is concrete or masonry material, a backboard must be attached to it before mounting the ATI-D. Suitable mounting backboards are available commercially or can be constructed out of 1/2-inch plywood cut to size.
5. Tools and hardware required for mounting the ATI-D include:
 - Fasteners - wood screws (1/4 x 1-inch round head), toggle bolts, or wall anchors.
 - Screwdriver - to match fasteners.
 - Electric drill - if prepared holes are required.
 - Connecting tool - for fastening wires to a type-66 connector block.
 - Crimping tool - for 623-type modular plugs.

MOUNTING PROCEDURE

1. Unpack and carefully inspect the ATI-D for shipping damage. Notify the shipper immediately of any damage found. Verify that the package contains all parts and accessories needed for proper installation and operation.
2. If a backboard is required at the mounting location, attach it securely to provide a stable mounting surface.
3. Use the base of the ATI-D as a template or measure for mounting hole locations per the dimension details shown in Figure 1.
4. Drill holes of a proper size to accommodate the hardware being used into the mounting surface. If necessary, prepare these holes with inserts, anchors or other attachment devices as dictated by the type of mounting surface.
5. Insert the two top screws into the mounting surface and tighten them to within approximately 1/8-inch of the surface.
6. Hang the ATI-D on the top screws using the mounting holes located on the rear of the cabinet. Note that these holes are elongated with an enlargement at one end. This feature allows the cabinet to snap down on the screws to secure the mounting when the cabinet is hung on them.
7. Insert a third screw through the mounting tab located on the lower edge of the cabinet and into the mounting surface; tighten it into place.

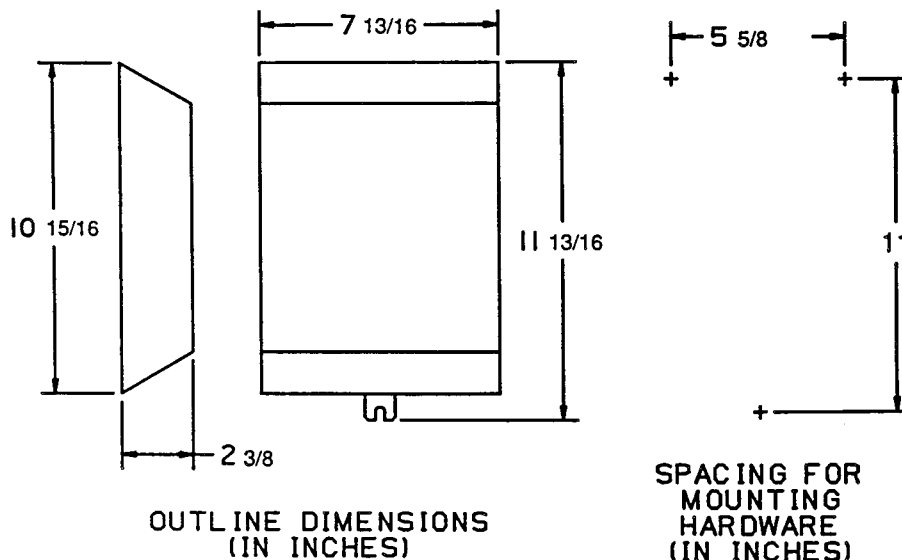

Figure 1. Outline Drawing

INSTALLATION PROCEDURE

Install the ATI-D per the typical application diagrams shown in Figures 2, 3a, and 3b and according to the following instructions.

- Route the necessary cabling and connect the ATI-D to the common equipment per the connections detailed in Figure 2 and the proper application diagram shown in Figure 3a or 3b (see Figure 4 if an OPX adapter is being installed).

NOTE: Both station ports must be connected to the ATI-D, even if only one IST device is being used.

CAUTION

Be careful when connecting the wiring between the common equipment and the ATI-D. Be sure to connect the common equipment station ports to the COMMON EQUIPMENT (KSU) jack on the ATI-D. Damage to the ATI-D could occur if this wiring is mistakenly connected to the IST jack.

- A grounding wire is not required for operation; however, one is desirable for decreasing radio frequency interference and electrostatic discharge susceptibility. A ground stud is provided on the ATI-D housing for this purpose. Connect a #10 or #12, insulated, solid copper wire between this ground stud and a reliable earth ground.

VERIFYING PROPER INSTALLATION

Use a voltmeter to check for the presence of voltage on the ATI-D IST jack. Refer to Figure 2 for pin-out locations of the TIP and RING leads.

1. Be sure wiring between ATI-D and common equipment station ports is installed.
2. Measure for DC voltage on IST jack:
 - Measure between TIP leads and common equipment grounding stud.
 - Measure between RING leads and common equipment grounding stud.
 - Measure between TIP leads and RING leads.
 - The measured voltage must be within following limits:

MEASUREMENT	VOLTAGE
Tip to Ground	+3 to +11 VDC
Ring to Ground	-13 to -21 VDC
Tip to Ring	+23 to +25 VDC

(The TIP lead is positive with respect to the RING lead.)

COMMON EQUIPMENT JACK
 • CONNECTION PORT FOR TWO PAIRED COMMON EQUIPMENT STATIONS
 • JACK PIN-OUT IS AS FOLLOWS:

PIN 1	NO CONNECTION
PIN 2	ODD NUMBER STATION (TIP)
PIN 3	EVEN NUMBER STATION (TIP)
PIN 4	EVEN NUMBER STATION (RING)
PIN 5	ODD NUMBER STATION (RING)
PIN 6	NO CONNECTION

WIRE EVEN NUMBER STATION PORT TO PIN 3 & 4.

WIRE ODD NUMBER STATION PORT TO PINS 2 & 5.

IST JACK
 • CONNECTION PORT FOR TWO 24 VOLT COMPATIBLE IST DEVICES
 • JACK PIN-OUT IS AS FOLLOWS:

PIN 1	NO CONNECTION
PIN 2	TIP 2
PIN 3	TIP 1
PIN 4	RING 1
PIN 5	RING 2
PIN 6	NO CONNECTION

WIRE IST 1 TO PINS 3 & 4
 WIRE IST 2 TO PINS 2 & 5.

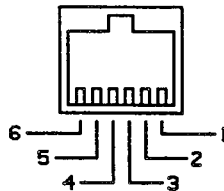
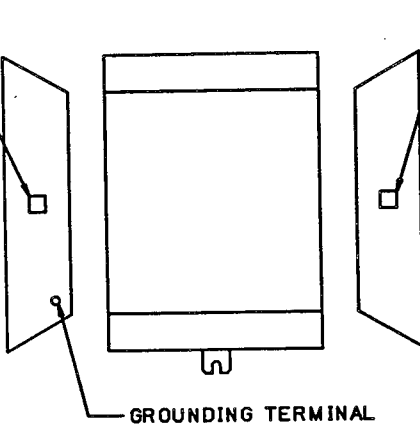

AW140

PIN LOCATIONS ON JACKS - FRONT VIEW

Figure 2. Connection Details

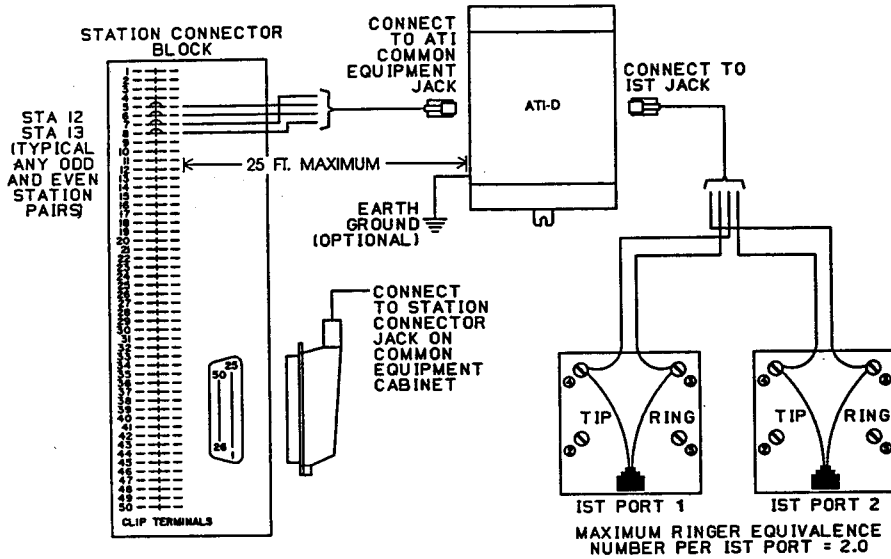

AW141

Figure 3a. IST Interconnection (Typical)

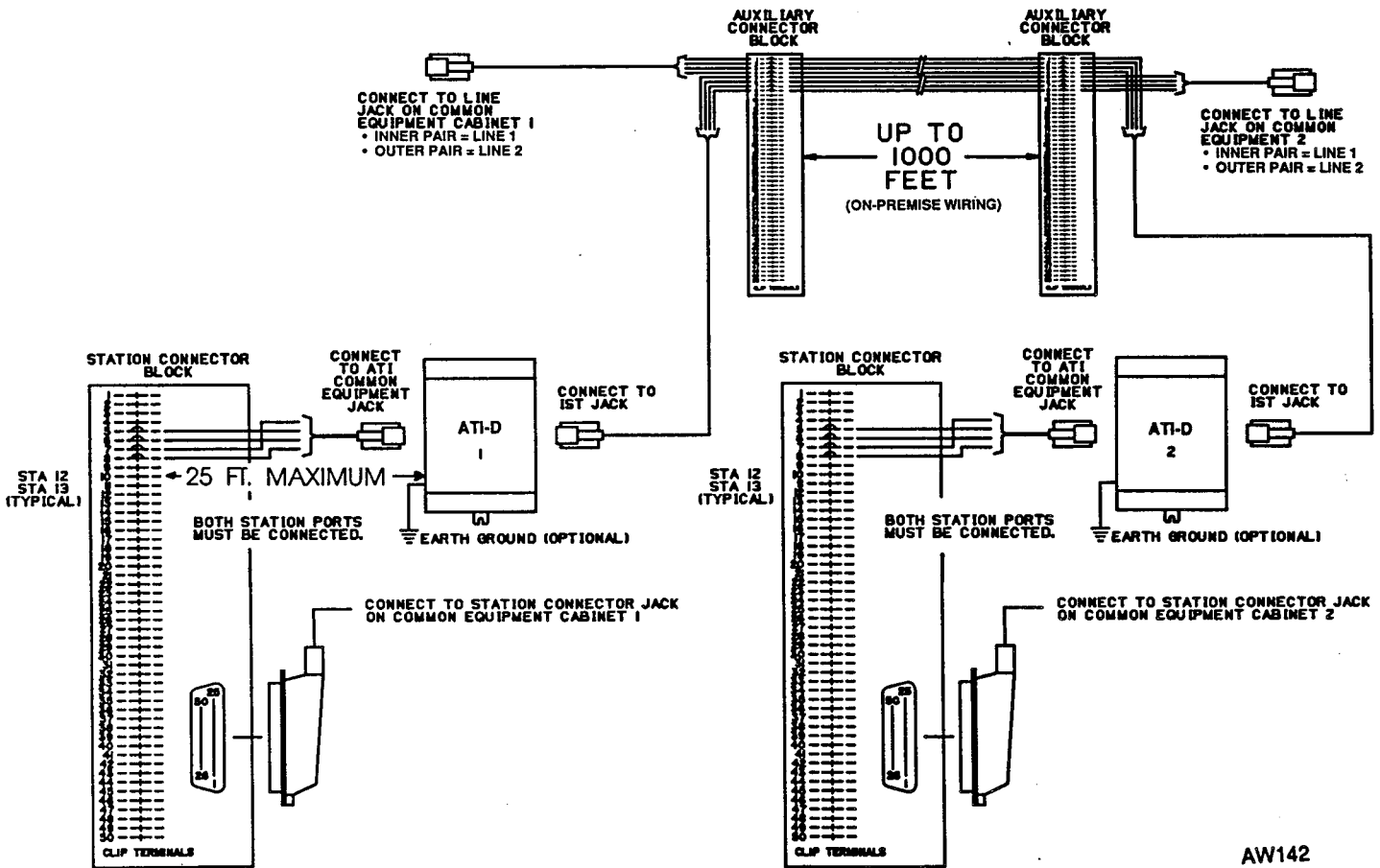

AW142

Figure 3b. System Interconnection (Typical)

INSTALLING OPX LONG LOOP ADAPTER FOR OFF-PREMISE SERVICE

An OPX long loop adapter connects to a single telephone line and can greatly extend the line's loop length (the Proctor Model 46222 adapter*, for example, can extend line length to 30,000 feet). In addition, such units can be used to interconnect key systems (to share central office lines and system features).

CAUTION

When an adapter is connected to an off-premise extension (OPX), the telephone line routed to the OPX must have primary protectors installed in series with the tip/ring pair to protect both the user and the equipment from transient voltage spikes that can travel through the cable. The telephone company offers basic protection against this condition, but it is usually designed to protect the central office circuits and cannot be relied upon to protect common

equipment. To help insure that external overvoltage surges do not damage the system, it is recommended that gas discharge tubes or similar primary protection devices be installed and properly grounded on the telephone line from the adapter to the off-premise extension.

To install the OPX long loop adapter:

- Follow manufacturer's instructions for unpacking, inspecting, mounting and wiring the adapter unit.
- Plug a modular cable into the system jack on the adapter and connect the opposite end of the cable to the IST jack on the ATI-D.
- Plug a modular cord into the telephone jack on the adapter and connect the opposite end of the cord to the OPX line (see Figure 4).
- Plug the adapter power cord into a standard 117 VAC, 3-wire electrical outlet.

*Proctor & Associates Company, Redmond, WA.

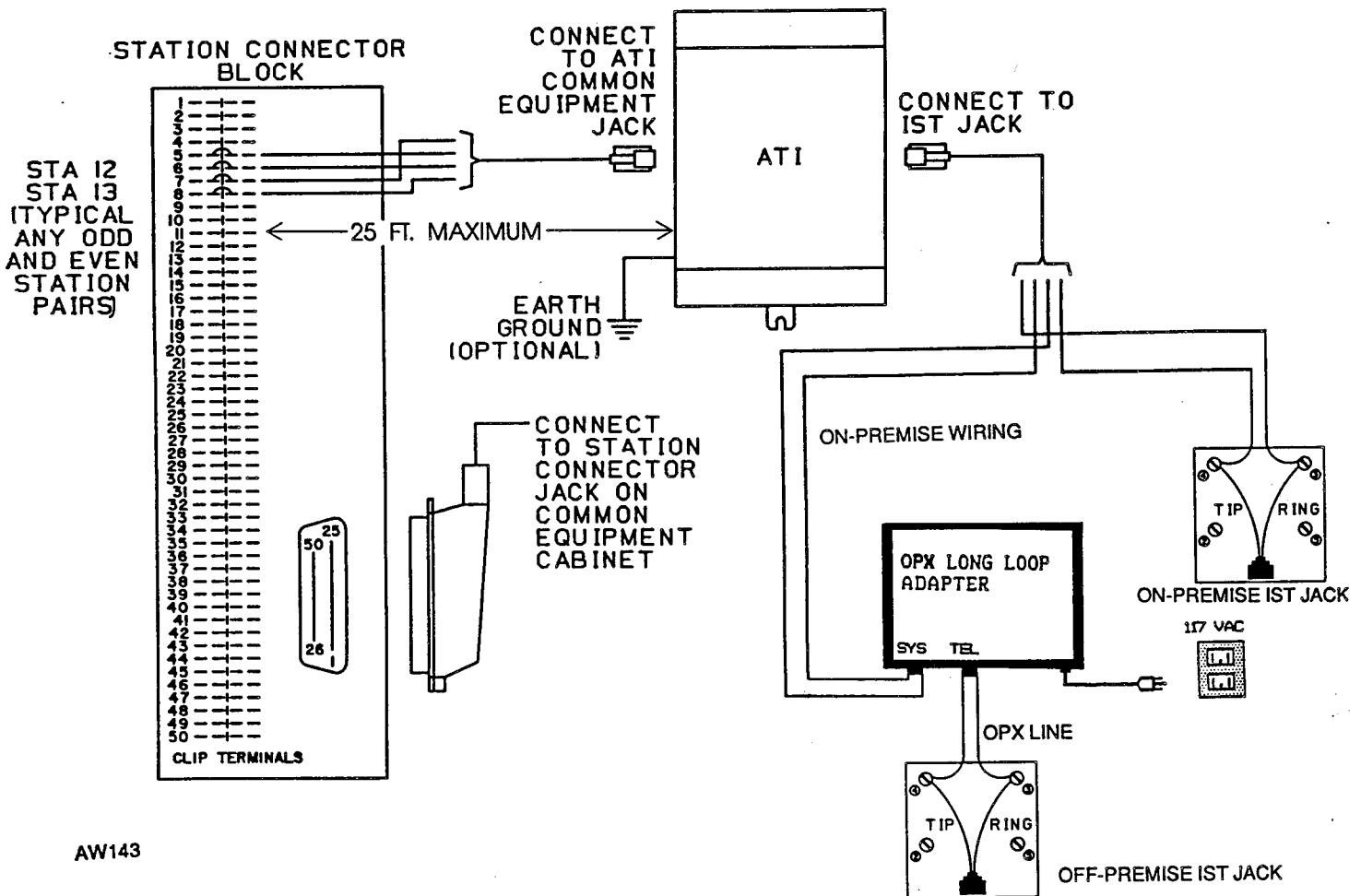

AW143

Figure 4. IST Interconnection (with OPX Adapter)

INSTALLING EXECUMAIL AND EXECUMAIL JR. VOICE MAIL INTERFACE

The ATI-D provides interfacing for a Comdial ExecuMail or ExecuMail Jr. voice processing system. The ATI-D, using paired station ports (such as 12 & 13 or 14 & 15), will support two ExecuMail ports; the configuration is shown in Figure 4 below. To

complete the digital system KSU and ExecuMail interface, program the digital system ports connected to the ExecuMail system as voice mail ports, then configure the ExecuMail system according to the type of switch used (both procedures are described on page 2-7). For complete programming information, refer to Section 2A of this chapter.

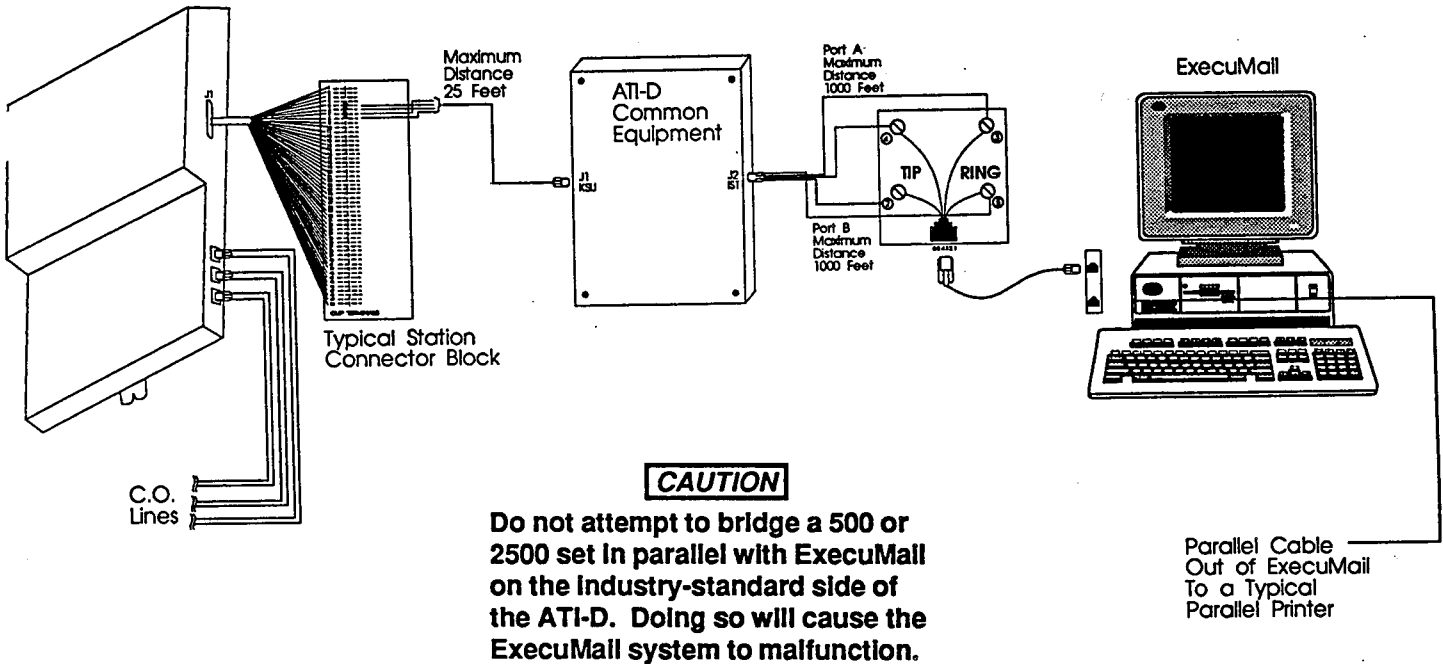

Figure 5. System Interconnection (with ExecuMail or ExecuMail Jr.)

SECTION 2A PROGRAMMING REQUIREMENTS FOR THE EXECUMAIL SYSTEM (Integrated with a digital telephone system)

PROGRAMMING OPTIONS

The ATI-D provides interfacing for a Comdial ExecuMail or ExecuMail Jr. system. Certain features must be programmed at the station port through which any ExecuMail system is being interfaced. The following information applies to ExecuMail only; instructions for installing ExecuMail Jr. appear in the programming section of the *ExecuMail Jr. Installer's Guide* (Comdial publication IMI 66-095.01).

Required Programming

Following are initial programming steps that must be followed before you can begin optional programming:

VOICE MAIL PORT

This programming feature is required to enable the station port through which the ExecuMail system is being interfaced, for ExecuMail operation (voice mail port).

NOTE: This feature is automatically disabled if the ATI-D is replaced with a multiline telephone at the programmed station port. Disable the station port as a voice mail port when it is used for IST operation.

Optional Programming

AUTOMATED ATTENDANT

The ExecuMail system automatically answers any line that is ringing at a voice mail port. As the default, the system automatically enables ringing line preference for any port the programmer identifies as a voice mail port. You must choose a ringing assignment for the lines assigned to the voice mail port before the ExecuMail system can provide the automatic attendant feature.

AUTOMATIC TRANSFER OF VOICE MAIL

Arrange for an immediate connection to a station after it answers a call that is transferred from the ExecuMail system.

NOTE: Activating the screen and/or confirm options provided by ExecuMail precludes choosing the immediate transfer mode, since screen and confirm modes require a slight delay for proper operation.

HUNT GROUPS

Assign a station port to a hunt group so that, when that station is busy, it will ring at the next idle station in the group. If all ports in a hunt group are busy, the system will return a busy tone to the caller. Assigning all ExecuMail ports to a circular hunt group takes advantage of the system's multiple-port interface capability; create a circular hunt group by linking all ExecuMail ports together and then linking the last ExecuMail port in the hunt group to the first ExecuMail port in the hunt group.

For example, with the ExecuMail connected to station ports 13, 14, 15, and 16, place port 13 in a hunt group and link 14 to it, place 14 in a hunt group and link 15 to it, place 15 in a hunt group and link 16 to it, and finally place 16 in a hunt group and link 13 to it to complete the circle. With this arrangement, a call will first try to ring at port 13 and will then try all other ports in the circle.

VOICE MAIL LINE ID

Program the lines to be answered by the ExecuMail system with identification (ID) numbers. These numbers allow the ExecuMail system to identify which line it is answering. The ID numbers that are assigned here must match the ID numbers that are selected as part of ExecuMail system programming.

VOICE MAIL TRANSFER ON BUSY

A busy system station may need to be alerted if the ExecuMail system is attempting a call transfer to it instead of having the call automatically routed to a voice mail box. This program feature allows a station (usually the attendant station) to be programmed for this option.

PROGRAMMING PROCEDURES

Procedures for programming the station port for ExecuMail support are given below for reference purposes. For complete station port programming details, refer to the system manual for the Comdial digital telephone system being used.

To enter class of service programming at system station 10,

Press ITCM * # 7 4 6 *.

Required Programming for Digital Telephone Systems

The following programming steps must be completed before you begin optional programming:

VOICE MAIL PORT

NOTE: The station that is being used for programming cannot be programmed as a voice mail port.

1. Dial 53. "STATION FEATURES"
2. Dial 32. "VOICE MAIL PORT "
3. Select station ports to be programmed
 - Station 12- 57: Dial 12 - 57
4. Press SPKR to end.

SWITCH SET-UP THROUGH EXECUMAIL

After you've programmed the system's voice mail port, you will need to configure ExecuMail for proper switch set-up. To do so,

1. Turn on ExecuMail and wait for the Comdial Banner screen to appear on the VDT screen.
2. Press F2.
3. Type TOM and press ENTER.
4. Press CTRL and S simultaneously.
5. On line 1, type COMDIAL and press ENTER.
6. Respond to prompt to choose the appropriate switch.
7. After responding to all prompts, reboot the computer by turning it off for 30 seconds and then turning it back on.

See Comdial publication IMI 66-095.01, *ExecuMail Jr. Installer's Guide*, for information about required programming for ExecuMail Jr.

Optional Programming for Digital Telephone Systems

AUTOMATED ATTENDANT

Direct Ringing

1. Dial 54. "STALINE CONFIG."
2. Dial 1. "DIRECT RING "
3. Select line ports for direct ringing:
 - Line port 1-14 = Dial 01 - 14 or press A1 - A14
 - Line port 15, 16 = Dial 15, 16 or press B1, B2.
 - Line port 17 - 24 = Dial 17 - 24

-OR-

Press HOLD, then press A1 - A8
4. Dial # when all line ports are selected.
5. Select station ports to be programmed:
 - Station 12- 57: Dial 12 - 57
6. Dial * when all station ports are selected.
 - OR-
 - Dial * * for next station/line ringing assignment.
 - OR-
 - Dial * * * for configuration mode.

Delayed Ringing

1. Dial 54. "STALINE CONFIG."
2. Dial 2. "DELAY RING "
3. Select line ports for delayed ringing:
 - Line port 1-14 = Dial 01 - 14 or press A1 - A14
 - Line port 15, 16 = Dial 15, 16 or press B1, B2
 - Line port 17 - 24 = Dial 17 - 24

-OR-

Press HOLD, then press A1 - A8
4. Dial # when all line ports are selected.
5. Select station ports to be programmed:
 - Station 12- 57: Dial 12 - 57
6. Dial * when all station ports are selected.
 - OR-
 - Dial * * for next station/line ringing feature.
 - OR-
 - Press SPKR to end.

Night Transfer (of ringing)

1. Dial 54. "STALINE CONFIG"
2. Dial 3. "NIGHT RING"
3. Select line ports:
 - Line port 1-14 = Dial 01 - 14 or press A1 - A14
 - Line port 15, 16 = Dial 15, 16 or press B1, B2.
 - Line port 17 - 24 = Dial 17 - 24

-OR-

Press HOLD, then press A1 - A8
4. Dial # when all line ports are selected.
5. Select station ports to be programmed:
 - Station 12 - 57: Dial 12 - 57
6. Dial * when all station ports are selected.
 - OR-

Continued on next page . . .

Dial * * for next station/line feature.

-OR-

Press SPKR to end.

AUTOMATIC TRANSFER OF VOICE MAIL

1. Dial 25 . "V MAIL AUTO XFER"
2. Press A1 to toggle between enable and disable.
(LED On = Enable)
-OR-
Dial 1 to enable (A1 LED on).
Dial 2 to disable.
3. Dial * for configuration mode.

HUNT GROUPS

1. Dial 53. "STATION FEATURES"
2. Dial 18. "ITCM HUNT LINK"
3. Select first linking station:
-For station 11-57, dial 12 - 57.
4. Select second linking station:
-For station 11-57, dial 12 - 57.
5. Dial * for another link or press SPKR to end.

VOICE MAIL LINE ID

1. Dial 43. "VOICE MAIL LN ID"
2. Select line port :
-Line port 1-14 = Dial 01 - 14 or Press A1 - A14
-Line port 15, 16 = Dial 15, 16 or press B1, B2
-Line port 17-24 = Dial 17 - 24
-OR-
Press HOLD, then press A1 - A8
3. Dial # to clear current ID.
4. Dial ID number (6 digit maximum).
5. Dial * for further ID assignment.
-OR-
Dial * * for configuration mode.

VOICE MAIL TRANSFER ON BUSY

1. Dial 53. "STATION FEATURES"
2. Dial 31. "VMAIL XFR ON BSY"
3. Select station ports to be programmed.
-Station 11 - 57: Dial 12 - 57
4. Press SPKR to end.

SECTION 2B PROGRAMMING REQUIREMENTS FOR THE INDUSTRY-STANDARD TELEPHONE

PROGRAMMING OPTIONS

The ATI-D provides the interfacing capability required to connect most IST equipment to a station port of a Comdial digital telephone system.

The IST provides basic intercom service coupled with the ability to access outside lines. Through programming, the IST acts as an intercom-only telephone or as a full-featured business telephone. The station port through which the IST is being interfaced can be programmed either for prime intercom or for prime line automatic and idle line preference. Default is for prime intercom. The station port can also be programmed for outside line ringing as required and to match the type of dialing method employed by the IST.

PRIME INTERCOM

On key configured systems, line access for call origination is extended to the IST by a system telephone through the use of the call transfer feature. **Outside line ringing** can be provided to the IST even though it is programmed for prime intercom access. To do this, program the station port for the ringing line preference feature and enable ringing for all desired lines.

On hybrid configured systems, access to outside lines is made available through line group access. With line group access, the IST user dials the group access code over the intercom line to access an outside line for use. The common equipment then selects one of the grouped idle lines for use in the order from the highest numbered line to the lowest numbered line.

PRIME LINE AUTOMATIC OR IDLE LINE PREFERENCE

Program an outside line as a prime line at the station port through which the IST is being interfaced, or program the station port for idle line preference and then program one of the assigned idle lines as a prime line.

With both prime line automatic and idle line preference, the IST has outside line dial tone when the handset is lifted. **Outside line ringing** can be enabled at the IST station port that is programmed for prime line automatic or for idle line preference. Alternately, the ringing line preference feature can be enabled for the station port.

The intercom line is also available to an IST that has outside line access. After going off-hook, the IST user obtains intercom dial tone by performing a hookflash or by pressing the TAP button if one is available. To perform a hookflash, press and release the hookswitch. This action either drops the outside line (if no digits are dialed after lifting the handset) or places it on hold (if digits were dialed) and provides intercom dial tone.

ATI-D DISTINCTIVE RINGING

Intercom calls that ring at equipment connected through an ATI-D have a different cadence than outside calls have. Intercom ring cadence is: 1 sec. on, .5 sec. off, 1 sec. on, 3.5 sec. off. Outside call ring cadence is: 2 sec. on, 4 sec. off. If desired, disable this distinctive ringing feature to make the intercom ring cadence the same as that for outside calls.

THROUGH DIALING

The station port through which the IST is being interfaced can be programmed for through-dialing or the feature can be disabled. The feature is automatically enabled when an ATI-D is connected to the station port. If the IST is a dual-tone multifrequency (DTMF) tone dial device, dialing tones generated by it pass through the ATI-D, the common equipment and onto a tone dial compatible telephone line. In this case, the station port must have through-dialing enabled.

If a rotary telephone is used, the through-dialing feature must be disabled.

PROGRAMMING PROCEDURES

Procedures that enable you to program the station port for prime line automatic, idle line preference, ringing line preference, to assign ringing to assigned lines, to set the ringing style, and to disable/enable through-dialing are given below for reference purposes. For complete station port programming details, refer to the system manual for the Comdial digital telephone system being used.

NOTE: The procedures detailed below are for using a programming station with designated A and B programming buttons. When using a station with designated L buttons, refer to the following conversion chart: A1 - A14 = L1 - L14 B1 = L15 B2 = L16

To enter class of service programming at system station 10,

Press ITCM * # 7 4 6 *.

RINGING LINE PREFERENCE

1. Dial 53. "STATION FEATURES"
2. Dial 09. "RING LINE PREF."
3. Select station ports to be programmed:
 - Station 11- 57: Dial 12 - 57
4. Dial * for next station feature.
- OR-
- Dial * * for configuration mode.

PRIME LINE (also prime group or prime Intercom)

1. Dial 53. "STATION FEATURES"
2. Dial 15. "PRIME LINE "
- 3a. Assign prime line. "PRIME LINE XX "
 - Line port 1-14 = Dial 01 - 14 or press A1 - A14
 - Line port 15, 16 = Dial 15, 16 or press B1, B2
 - Line port 17 - 24 = Dial 17 - 24

-OR-

Press HOLD, then press A1 - A8
- 3b. Assign prime group:
 - Dial 51-54 for gps. 1-4. "PRIME LINE GRP X"
- 3c. Assign prime intercom:
 - Dial 50 for intercom line. "PRIME INTERCOM"
4. Select station ports to be programmed:
 - Station 12- 57: Dial 12 - 57.
5. Dial * for next prime line, group, or intercom assignment.
- OR-
- Dial * * for next station feature.
- OR-
- Dial * * * for configuration mode.

IDLE LINE PREFERENCE

1. Dial 54. "STA/LINE CONFIG."
2. Dial 7. "IDLE LINE PREF."
3. Select line ports for idle line preference.
 - Line port 1-14 = Dial 01 - 14 or press A1 - A14
 - Line port 15, 16 = Dial 15, 16 or press B1, B2
 - Line port 17 - 24 = Dial 17 - 24

-OR-

Press HOLD, then press A1 - A8
4. Dial # when all line ports are selected.
5. Select station ports to be programmed:
 - Station 12- 57: Dial 12 - 57
6. Dial * when all station ports are selected.
7. Dial * * for next station/line feature.
- OR-
- Dial * * * for configuration mode.

FLEXIBLE RINGING ASSIGNMENTS

Direct Ringing

1. Dial 54. "STA/LINE CONFIG."
2. Dial 1. "DIRECT RING "
3. Select line ports for direct ringing:
 - Line port 1-14 = Dial 01 - 14 or press A1 - A14
 - Line port 15, 16 = Dial 15, 16 or press B1, B2
 - Line port 17 - 24 = Dial 17 - 24

-OR-

Press HOLD, then press A1 - A8
4. Dial # when all line ports are selected.
5. Select station ports to be programmed:
 - Station 12- 57: Dial 12 - 57
6. Dial * when all station ports are selected.
- OR-
- Dial * * for next station/line ringing assignment.
- OR-
- Dial * * * for configuration mode.

Delayed Ringing

1. Dial 54. "STA/LINE CONFIG."
2. Dial 2. "DELAY RING "
3. Select line ports for delayed ringing:
 - Line port 1-14 = Dial 01 - 14 or press A1 - A14
 - Line port 15, 16 = Dial 15, 16 or press B1, B2
 - Line port 17 - 24 = Dial 17 - 24

-OR-

Press HOLD, then press A1 - A8
4. Dial # when all line ports are selected.
5. Select station ports to be programmed:
 - Station 12- 57: Dial 12 - 57
6. Dial * when all station ports are selected.
- OR-
- Dial * * for next station/line ringing feature.

-OR-

Dial * * * for configuration mode.

Night Transfer (of ringing)

1. Dial 54. "STA/LINE CONFIG"
2. Dial 3. "NIGHT RING"
3. Select line ports:
 - Line port 1-14 = Dial 01 - 14 or press A1 - A14
 - Line port 15, 16 = Dial 15, 16 or press B1, B2
 - Line port 17 - 24 = Dial 17 - 24

-OR-

Press **HOLD**, then press **A1 - A8**

4. Dial # when all line ports are selected.
5. Select station ports to be programmed:
 - Station 12 - 57: Dial 12 - 57
6. Dial * when all station ports are selected.

-OR-

Dial * * for next station/line feature.

-OR-

Dial * * * for configuration mode.

ATI-D DISTINCTIVE RINGING

1. Dial 53. "STATION FEATURES"
2. Dial 33. "DIST. RING ON "
3. Press A1 to toggle between enable and disable (LED On = Enable).

-OR-

Dial 1 to Enable. "DIST. RING ON "
Dial 2 to Disable. "DIST. RING OFF "

4. Dial * for next station feature.

-OR-

Dial * * for configuration mode.

THROUGH DIALING

1. Dial 53. "STATION FEATURES"
2. Dial 07. "ATI-D THRU DIALING"
3. Select station ports to be programmed:
 - Station 12- 57: Dial 11 - 57
4. Dial * for next station feature.

-OR-

Dial * * for configuration mode.

SECTION 2C PROGRAMMING FOR SYSTEM INTERCONNECTION

When interconnecting two digital telephone systems together with ATI-Ds (one ATI-D for each system), program the station ports that connect to the ATI-D with the same features as described for an IST (see page 2-10).

Program the line ports that connect to the on-premise wiring as central office line ports. Other line features as described in the line configuration section of the system manual can be programmed as desired.

CHAPTER 3 OPERATION

SECTION 1 INDUSTRY-STANDARD TELEPHONE OPERATION

Your industry-standard telephone (IST) can have either outside line dial tone or intercom dial tone when taken off-hook. The type of dial tone received is determined by how your IST is installed and programmed.

These operating instructions assume that intercom dial tone is available when the handset is lifted. If, instead, outside line dial tone is available, press and release the hookswitch (or press the TAP button if available) to obtain the intercom dial tone.

ANSWERING CALLS

ANSWERING A CALL

- Lift handset.

CALL PICKUP ANSWERING

To answer a call that you hear ringing at another station,

- Lift handset. Listen for intercom dial tone.
- Dial * 4.
- Dial number of ringing station.

To answer a call that is ringing at any station in your pick-up group,

- Lift handset. Listen for intercom dial tone.

- Dial # 4.

LINE ANSWER FROM ANY STATION

When the attendant station has enabled the night transfer (of ringing) feature, an outside call can be answered from any station in the system.

- Hear ringing (loud ringer, night transfer station, etc.).
- Lift handset. Listen for intercom dial tone.
- Dial 80
- Answer call.

MAKING CALLS

INTERCOM CALLING

With intercom as prime line

- Lift handset. Listen for intercom dial tone.
- Dial station extension number.

With outside line as prime line and idle line preference

- Lift handset. Listen for outside line dial tone.
- Press and release hookswitch (flash), or press TAP button if available. Listen for intercom dial tone.
- Dial station extension number.

OUTSIDE LINE CALLING

With intercom as prime line

NOTE: The system must be configured as a hybrid system for this feature to be available.

- Lift handset. Listen for intercom dial tone.
- Dial line group access code
 - 9 = group 1
 - 81 = group 2

82 = group 3

83 = group 4

- Listen for outside line dial tone.
- Dial number.

With outside line as prime line and idle line preference

- Lift handset. Listen for outside line dial tone.
- Dial number.

AUTOMATIC DIALING

Speed Dialing

With intercom as prime line

NOTE: The station must be configured with idle line preference for this feature to work properly since the last line used could be busy and therefore not be available for use when needed.

- Lift handset. Listen for intercom dial tone.
- Press and release hookswitch (flash), or press TAP button if available. Dial tone will stop.
- Dial 0 - 1 for station speed dial.

- Dial * 01 - * 99 for system speed dial.
- Hang up handset to end call.

With outside line as prime line and idle line preference

- Lift handset. Listen for outside line dial tone.
- Press and release hookswitch (flash), or press TAP button if available.
- Listen for intercom dial tone.
- Press and release hookswitch (flash), or press TAP button if available. Dial tone will stop.
- Dial 0 - 1 for station speed dial.
- Dial * 01 - * 99 for system speed dial.
- Hang up handset to end call.

Last Number Redial

With Intercom as prime line

NOTE: The station must be configured with idle line preference for this feature to work properly since the last line used could be busy and therefore not be available for use when needed.

- Lift handset. Listen for intercom dial tone.
- Press and release hookswitch (flash), or press TAP button if available. Dial tone will stop.
- Dial # for last number redial.

With outside line as prime line and idle line preference

- Lift handset. Listen for outside line dial tone.
- Press and release hookswitch (flash), or press TAP button if available.
- Listen for intercom dial tone.
- Press and release hookswitch (flash), or press TAP button if available. Dial tone will stop.
- Dial # for last number redial.

LINE GROUP QUEUING

NOTE: The system must be configured as a hybrid system for this feature to be available.

To queue for a busy line group,

- Lift handset. Listen for intercom dial tone.
- Dial line group access code (9. 81, 82, 83).
- Hear busy tone.
- Dial * 8 and hang up. When line group is free, your IST will sound several quick ring bursts.
- Lift handset, hear line dial tone, and place call.

To answer line queuing ring-back,

- Hear several quick ring bursts.
- Lift handset, hear dial tone on line, and place call.

To cancel queuing,

- Lift handset. Hear intercom dial tone.
- Dial # 8.
- Hang up.

HOLDING CALLS

To place an outside call on hold or to retrieve a held call,

- Establish call.
- Press and release hookswitch (flash), or press TAP button if available. (If IST has HOLD button available, press it.)

CALL PARK

To park an outside call for retrieval,

- While on line, press and release hookswitch (flash), or press TAP button if available. Outside call is placed on hold and intercom dial tone sounds.
- Dial *.
- Dial park orbit access code (91 - 99).
- Hang up.

To retrieve a parked call,

- Hear announcement of park orbit number.
- Pick up handset. Listen for intercom dial tone.
- Dial #91-99.
- Answer call.

To place a call for retrieval at a particular station (direct station hold),

- While on line, press and release hookswitch (flash), or press TAP button if available. Outside call placed on hold and intercom dial tone sounds.
- Dial * 9 0 plus extension number of station to receive parked call.

To take back the call after placing it on direct station hold,

- Lift handset. Listen for intercom dial tone.
- Dial * 4 plus the extension number of hold receiving station.

To retrieve direct hold call that has been placed for pick-up at IST,

- Hear announcement of held call.
- Lift handset. Listen for intercom dial tone.
- Dial # 9 0.

TRANSFERRING CALLS

SCREENED TRANSFER

To transfer an outside call to a system station,

- Answer outside call.
- Press and release hookswitch (flash), or press TAP button if available. Outside call is placed on hold automatically.
- Dial extension number of party to be transferred to.
- When intercom party answers, announce call.
- Hang up handset.

If the called party is busy or does not answer,

- Press and release hookswitch (flash), or press TAP button if available. Outside call is retrieved.

UNSCREENED TRANSFER

To transfer an outside call to a system station,

- Answer outside call.
- Press and release hookswitch (flash), or press TAP button if available. Outside call is placed on hold automatically.
- Dial extension number of party to be transferred.
- Listen for ring back.
- Hang up handset. If transferred call is not answered after a pre-programmed length of time, it will ring back at your IST.

To answer recall of transferred call,

- Lift handset when you hear ringing.

CONFERENCING

You can set up a conference between the IST and two system stations or between the IST station, a system station, and one outside line.

To conference with two system stations,

- Lift handset. Listen for intercom dial tone.
- Make first call.
- Press and release hookswitch (flash), or press TAP button if available. Call is placed on hold automatically.
- Make second call.
- Press and release hookswitch (flash), or press TAP button if available. Conference is established.

To conference with an outside line and a system station,

NOTE: When setting up a conference call with an outside line and an inside station, call the outside line first.

- Make call on outside line call (as instructed earlier).
- Press and release hookswitch (flash), or press TAP button if available. Call is placed on hold automatically.
- Listen for intercom dial tone, and dial station extension number.
- Press and release hookswitch (flash), or press TAP button if available. Conference is established.

NOTE: Conference volume level is dependent upon the quality of the external line.

To drop out of a conference,

- Hang up.

MESSAGING

LCD MESSAGING

System supplied messages can be set from your IST to be displayed at a calling LCD speakerphone. The IST cannot display messages.

To turn on message,

- Lift handset. Listen for intercom dial tone.
- Dial * 02
- Dial message code number (1 - 0). See attendant for list of messages available.
- Hang up handset.

NOTE: The default messages of "BACK AT" and "CALL" may be provided for use:

If "BACK AT" is provided as message 1, then dial time in twelve-hour format after dialing message access code 1.

If "CALL" is provided as message 2, then dial extension that calls are forwarded to after dialing message access code 2.

To turn off message,

- Lift handset. Listen for intercom dial tone.
- Dial # 02.
- Hang up.

STATION-TO-STATION MESSAGING

If IST has BLF appearance at another station, a call-back message indication can be left at that station.

To activate messaging,

- Make intercom call and hear ring-back tone.
- Dial * 7. BLF light at called station flutters.

To cancel messaging,

- Lift handset. Listen for intercom dial tone.
- Dial # 7.
- Dial extension number of station at which message call-back indication was left.
- Hang up.

MESSAGE WAITING (MW) LIGHT

With the message wait originate ability enabled by class of service programming, you can use your IST to turn on a message waiting light at a system telephone.

To turn on MW light,

- Lift handset. Listen for intercom dial tone.
- Dial * 3.
- Dial extension number of station to be alerted. (The MW light of called station will flash.)

To turn off MW light,

- Lift handset. Listen for intercom dial tone.
- Dial # 3.
- Dial extension number of station that was alerted. (The MW light of called station will turn off.)

PAGING

EXTERNAL PAGING

(Requires external paging unit)

- Lift handset. Listen for intercom dial tone.
- Dial 89.
- Make paging announcement and hang up.

ALL-CALL AND ZONE PAGING

To page,

- Lift handset. Listen for intercom dial tone.
- Dial zone number - (84, 85, 86, or 87 for all-call).
- Make announcement.

- Hang up handset or wait on line for an answer (meet-me answerback of page).

MEET-ME PAGE (Answerback of Page)

To answer all-call or zone paging,

- Lift handset. Listen for intercom dial tone.
- Dial 88.
- Meet paging party on line for private conversation.

CALL FORWARD

You can designate any system station to be the recipient of just the intercom calls and prime line calls that are directed to your IST or the recipient of all the calls that are directed to your IST.

CALL FORWARD - PERSONAL

To forward Intercom calls and prime line to another telephone,

- Lift handset. Listen for intercom dial tone.
- Dial * 05.
- Dial extension number of telephone to which calls are to be forwarded.

To cancel Intercom call and prime line forwarding,

- Lift handset. Listen for intercom dial tone.
- Dial #05.

CALL FORWARD - ALL

To forward all calls to another telephone,

- Press Lift handset. Listen for intercom dial tone.
- Dial * 5.
- Dial extension number of station to which calls are to be forwarded.

To cancel all call forward,

- Lift handset. Listen for intercom dial tone.
- Dial # 5.

***NOTE:** For each call received during call forward, a ring reminder (short ring burst) sounds at the IST to remind the user that calls are being forwarded.*

AUTOMATIC CALL-BACK

To arrange for the system to call back when a busy telephone becomes idle,

- Make intercom call. Hear busy signal.
- Dial * 6.
- Hang up. Your IST will ring when called telephone becomes idle.

To answer call-back ring,

- Lift handset. Called telephone will ring.

To cancel automatic call back before it rings,

- Lift handset. Listen for intercom dial tone.
- Dial # 6.
- Hang up.

CALL WAITING

A call waiting tone can be sent to a busy station while your IST waits on line for an answer.

To activate call waiting,

- Make intercom call and receive busy signal.
- Dial * 0 1. (Called and calling parties hear three short tone bursts.)
- Wait on line for an answer.

To cancel call waiting.

- Hang up handset.

To answer a call waiting tone that sounds at your IST,

- Hear three short tone bursts over existing conversation.

- Finish present call or place it on hold by pressing and releasing hookswitch (flash), or by pressing TAP button if available.
- Hang up. Waiting call will begin ringing.
- Lift handset to answer.
- Hang up when call is completed. Return to previous call, if on hold, by pressing and releasing hookswitch (flash), or pressing TAP button if available.

***NOTE:** If the call is not retrieved, press and release hookswitch (flash), or press TAP button if available, a second time.*

SERVICE OBSERVING

Your IST can be arranged by system class of service programming so that you can monitor a conversation at another station in an un-announced and muted manner.

- Lift handset. Listen for intercom dial tone.
- Dial # 03.
- Dial extension number of station to be monitored.
- Hang up when finished.

PULSE/TONE SWITCHING

If the local telephone service is pulse (rotary) but tone generation is required during the call, convert to tone while dialing as follows:

- Press # at point in dialing sequence where conversion to tone is required. (System will switch back to pulse dialing when call is ended.)

NOTE: Pulse/Tone switching can be programmed into speed dial numbers by pressing a # at the desired point in the stored number.

EXECUTIVE OVERRIDE

If enabled by system programming, you can break into a conversation at a system station from your IST.

- Make an intercom call, and hear busy signal.

- Dial * 03. A warning tone will sound at the called station.
- Join in-progress call.

ACCOUNT CODE OPERATION

Account codes are assigned by SMDA class of service programming and are used by the system to identify calls by category, or special grouping, for SMDA call reporting purposes. Enter an account code while on line either before an outgoing call is dialed, after the distant party has hung up, or during a call. Account code entry is voluntary. If it is not entered, an outgoing call will still go through or an incoming one can still be completed. To enter an account code, first dial the entry code. After doing this, dial the account code number.

OUTGOING CALL

- Lift handset. Listen for intercom dial tone.
- If necessary, dial 9 for outside dial tone.
- Dial number to be called.
- Press * 0 4. Line is automatically placed on hold.

- Dial account code. Listen for dial tone. If error tone sounds, check account code for validity and re-enter correct code.

INCOMING CALL (Or During Any Call)

- Answer call.
- Press and release hookswitch (flash), or press TAP button if available. Incoming call is automatically placed on hold and intercom dial tones sounds.
- Dial * 0 4.
- Dial account code. Entering a correct code automatically reconnects you to the call.

If error tone sounds check account code for validity and re-enter correct code.

To return to call without entering the correct code, press and release hookswitch (flash), or press TAP button if available.

STATION USER PROGRAMMING

STATION SPEED DIAL PROGRAMMING

Station speed dial numbers can be stored by the station user for later redial. The storage locations are keypad digits 0 through 9 on the station. Before attempting to program, decide on the following items: (1) the number or feature to be stored, (2) which storage location will be used (0 - 9), (3) the circuit that the call will go over (individual line or intercom).

To program numbers,

- Lift handset. Listen for intercom dial tone.
- Press * * 2.
- Dial a memory location (0 through 9). Listen for fast tone bursts.
- Dial 1 - 4 for line groups, for line group pre-selection.

-OR-

- If no pre-selection is desired, dial 0 (system will choose last line used at calling station or prime line if one is assigned to calling station).

-OR-

- dial 6 for intercom preselect.
- Dial the number sequence to be stored. (Up to sixteen digits can be stored).
- Press and release hookswitch to store a flash if required.

Example: Store a telephone number under location 0 with no line preselection. The number is 1(804)555-2222. Program as follows:

* , * , 2 , 0 , 0 , 1 , 8 , 0 , 4 , 5 , 5 , 5 , 2 , 2 , 2 , 2 .

- Hang up.

To store another number,

- Repeat the procedure for each speed dial location.

CHAPTER 4 MAINTENANCE

TECHNICAL ASSISTANCE AND REPAIR SERVICE

TECHNICAL ASSISTANCE

Should you experience difficulty with installation or operation, and have made an attempt to isolate the problem using information provided herein, or should you encounter problems at a later date which cannot be resolved by referring to this manual, call the Comdial Technical Service staff. They can be reached at 1-800-366-8224 between the hours of 8:00 AM and 8:00 PM Eastern time, Monday through Friday.

When calling for technical assistance, you should be at the job site and have in your possession, as a minimum, an accurate volt/ohm/milliamp meter and a copy of this manual.

REPAIR SERVICE

FCC regulations do not permit repair of customer owned equipment by anyone except the manufacturer or their authorized agent. The ATI-D is not warranted as a field repairable item.

If the ATI-D needs repair subsequent to the warranty period, it may be returned to Comdial. Comdial will, at their option, either repair the defective equipment or replace it with a remanufactured unit. This repair will be done at a fixed charge. For information on this charge, call or write to the following address:

Comdial
P.O. Box 7266
Charlottesville, VA 22906
Attention: Repair Department
Telephone: (800) 877-4448

When returning equipment for repair, pack it carefully to prevent damage. Any damages during shipment will be the responsibility of the purchaser. The equipment should be shipped freight or postage prepaid. The shipping address is:

Comdial
1180 Seminole Trail
Charlottesville, VA 22901
Attention: Repair Department

PUBLICATION INDEX

ATI-D Distinctive Ringing	2-8, 2-9, 2-11	Mounting Considerations	2-1
Automated Attendant Programming	2-6, 2-7	Mounting Procedure	2-1
Automatic Transfer Of Voice Mail	2-6, 2-8	Night Transfer (of Ringing)	2-7, 2-11
Connection Details	2-4	Off-Premise Extension (OPX)	2-3
Delayed Ringing, Programming	2-7, 2-10	Operation	3-1
Direct Ringing, Programming	2-7, 2-10	Operation, IST	3-1
Electrical	1-2	Outline Drawing	2-2
Environmental	1-2	Prime Intercom	2-9
ExecuMail Programming Procedures	2-10	Prime Line	2-10
ExecuMail System	2-10	Prime Line Automatic or Idle Line Preference	2-9
Flexible Ringing Assignment	2-10	Programming Options, ExecuMail System	2-6
General Information	1-1	Programming Procedures, ExecuMail System	2-7
Hunt Groups	2-6, 2-8	Programming Procedures, IST	2-8
Idle Line Preference or Prime Line Automatic	2-8, 2-9	Programming Requirements for the ExecuMail System	2-6
Idle Line Preference	2-8, 2-10	Programming Requirements for the Industry-Standard Telephone	2-9
Industry/Regulatory Standards	1-2	Programming, System Interconnection	2-11
Installing ExecuMail and ExecuMail Jr. Voice Mail Interface	2-5	Remote Location Extension	2-3
Installing OPX Long-Loop Adapter for Off-Premise Service	2-4	Ringling Line Preference	2-9, 2-10
Installation, ATI-D	2-1	Specifications	1-2
Installation and Programming	2-1	Switch Set-Up Through ExecuMail	2-7
Installation Procedure	2-2	System Interconnection	2-6, 2-11
Introduction	1-1	Technical Assistance And Repair Service	4-1
IST Interconnection	2-5	Through Dialing	2-9, 2-11
IST Operation	3-1	Unit Description	1-1
IST Programming Options	2-9	Verifying Proper Installation	2-2
IST Programming Procedures	2-10	Voice Mail Interface, Installing the ExecuMail	2-5
IST Programming Requirements	2-9	Voice Mail Line ID	2-6, 2-8
Maintenance	4-1	Voice Mail Transfer On Busy	2-6, 2-8
Mechanical	1-2	Voice Mail Port	

READERS COMMENT FORM

Cut along Line

Publication No. _____ Issue No. _____ Addendum _____

Title _____

How did you use this publication?

Product familiarization

Training

Installation

Maintenance

Other _____

Please check specific criticism(s), give page number(s), and explain below:

Clarification on page(s) _____

Error on page(s) _____

Addition on page(s) _____

Deletion on page(s) _____

Comments: _____

Thank you for your cooperation. If a reply is required, please check:

Name _____ Date _____

Your Function _____

Company _____

Address _____

City, State _____ Zip _____

Cut Along Line

COMDIAL

Made right in the USA

Cut Along Line

Fold



NO POSTAGE
NECESSARY
IF MAILED
IN THE
UNITED STATES

BUSINESS REPLY MAIL
FIRST CLASS MAIL PERMIT NO.594
CHARLOTTESVILLE, VA 22906

POSTAGE WILL BE PAID BY ADDRESSEE

COMDIAL
TECHNICAL PUBLICATIONS DEPARTMENT
P O BOX 7266
CHARLOTTESVILLE VA 22906-7266



Fold

Cut Along Line