

ViewSonic®

Cine5000 DLP Projector



ViewSonic®

- User Guide
- Guide de l'utilisateur
- Bedienungsanleitung
- Guía del usuario
- Guida dell'utente
- Guia do usuário
- Användarhandbok
- Käyttöopas
- Руководство пользователя
- 使用手冊
- 使用手冊

Model No. : VS11481

Compliance Information

For U.S.A.

This device complies with part 15 of the FCC Rules. Operation is subject to the following two conditions: (1) The device may not cause harmful interference, and (2) this device must accept any interference received, including interference that may cause undesired operation.

This equipment has been tested and found to comply with the limits for a Class B digital device, pursuant to part 15 of the FCC Rules. These limits are designed to provide reasonable protection against harmful interference in a residential installation. This equipment generates, uses, and can radiate radio frequency energy, and if not installed and used in accordance with the instructions, may cause harmful interference to radio communications. However, there is no guarantee that interference will not occur in a particular installation. If this equipment does cause harmful interference to radio or television reception, which can be determined by turning the equipment off and on, the user is encouraged to try to correct the interference by one or more of the following measures:

- Reorient or relocate the receiving antenna.
- Increase the separation between the equipment and receiver.
- Connect the equipment into an outlet on a circuit different from that to which the receiver is connected.
- Consult the dealer or an experienced radio/TV technician for help.

FCC Warning

To assure continued FCC compliance, the user must use grounded power supply cord and the cables which are included with the equipment or specified. Also, any unauthorized changes or modifications not expressly approved by the party responsible for compliance could void the user's authority to operate this device.

For Canada

- This Class B digital apparatus complies with Canadian ICES-003.
- Cet appareil numérique de la classe B est conforme à la norme NMB-003 du Canada.

For European Countries

CE Conformity

 The device complies with the requirements of the EEC directive 89/336/EEC as amended by 92/31/EEC and 93/68/EEC Art.5 with regard to "Electromagnetic compaty", and 73/23/EEC as amended by 93/68/EEC Art.13 with regard to "Safety."

User Information for all Countries

Notice: Use the cables which are included with the unit or specified.

Following information is only for EU-member states:

The mark shown to the right is in compliance with the Waste Electrical and Electronic Equipment Directive 2002/96/EC (WEEE).



The mark indicates the requirement NOT to dispose the equipment as unsorted municipal waste, but use the return and collection systems according to local law.

Important Safety Instructions

1. Read these instructions completely before using the equipment.
2. Keep these instructions in a safe place.
3. Heed all warnings.
4. Follow all instructions.
5. Do not use this equipment near water. Warning: To reduce the risk of fire or electric shock, do not expose this apparatus to rain or moisture.
6. Clean with a soft, dry cloth. If further cleaning is required, see “Cleaning the Display” in this guide for further instructions.
7. Do not block any ventilation openings. Install the equipment in accordance with the manufacturer’s instructions.
8. Do not install near any heat sources such as radiators, heat registers, stoves, or other devices (including amplifiers) that produce heat.
9. Do not attempt to circumvent the safety provisions of the polarized or grounding-type plug. A polarized plug has two blades with one wider than the other. A grounding type plug has two blades and a third grounding prong. The wide blade and the third prong are provided for your safety. If the plug does not fit into your outlet, consult an electrician for replacement of the outlet.
10. Protect the power cord from being tread upon or pinched, particularly at the plug, and the point where it emerges from the equipment. Be sure that the power outlet is located near the equipment so that it is easily accessible.
11. Only use attachments/accessories specified by the manufacturer.
12. Use only with the cart, stand, tripod, bracket, or table specified by the manufacturer, or sold with the equipment. When a cart is used, use caution when moving the cart/equipment combination to avoid injury from tipping over.
13. Unplug this equipment when it will be unused for long periods of time.
14. Refer all servicing to qualified service personnel. Service is required when the unit has been damaged in any way, such as: if the power-supply cord or plug is damaged, if liquid is spilled onto or objects fall into the unit, if the unit is exposed to rain or moisture, or if the unit does not operate normally or has been dropped.



Copyright Information

Copyright © ViewSonic® Corporation, 2006. All rights reserved.

Macintosh and Power Macintosh are registered trademarks of Apple Computer, Inc.

Microsoft, Windows, Windows NT, and the Windows logo are registered trademarks of Microsoft Corporation in the United States and other countries.

ViewSonic, the three birds' logo, OnView, ViewMatch, and ViewMeter are registered trademarks of ViewSonic Corporation.

VESA is a registered trademark of the Video Electronics Standards Association. DPMS and DDC are trademarks of VESA.

PS/2, VGA and XGA are registered trademarks of International Business Machines Corporation.

Disclaimer: ViewSonic Corporation shall not be liable for technical or editorial errors or omissions contained herein; nor for incidental or consequential damages resulting from furnishing this material, or the performance or use of this product.

In the interest of continuing product improvement, ViewSonic Corporation reserves the right to change product specifications without notice. Information in this document may change without notice.

No part of this document may be copied, reproduced, or transmitted by any means, for any purpose without prior written permission from ViewSonic Corporation.

Product Registration

To meet your future needs, and to receive any additional product information as it becomes available, please register your product on the Internet at: www.viewsonic.com. The ViewSonic® Wizard CD-ROM also provides an opportunity for you to print the registration form, which you may mail or fax to ViewSonic.

For Your Records

Product Name:	Cine5000 ViewSonic DLP Projector
Model Number:	VS11481
Document Number:	Cine5000-1_UG_ENG Rev. 1A 08-10-06
Serial Number:	_____
Purchase Date:	_____



The lamp in this product contains mercury.

Please dispose of in accordance with local, state or federal laws.

TABLE OF CONTENTS

1. Product Overview	4
1-1 Features	4
1-2 Package Contents	4
1-3 Main Unit	5
1-4 Control Panel	6
1-5 Rear Terminals	6
2. Installation	7
2-1 Turning on/off the projector	7
2-1-1 Starting up the projector	7
2-1-2 Shutting down the projector	7
2-1-3 LED Indication Status	7
2-2 Adjusting the Projector Image	8
2-2-1 Adjusting the Projected Height	8
2-2-2 Adjusting the Zoom and Focus	8
2-2-3 Adjusting the Projected Image Size	8
2-3 Operation	8
2-3-1 Connecting to a Personal Computer	8
3. Control Panel and Remote Control	9
3-1 Control Panel and Remote Control	9
3-1-1 Using Control Panel	9
3-1-2 Using the Remote Control	9
3-2 On-Screen Display Menu	10
3-2-1 How to Operate	10
3-2-2 Projector's OSD	10
4. Appendices	12
4-1 Troubleshooting	12
4-2 Maintenance	12
4-2-1 Replacing the Lamp	12
4-2-2 Cleaning the Projector	13
4-3 Specifications	14

PRODUCT OVERVIEW

1-1.FEATURES

- ◆ 250 W P-VIP lamp. Life 2000hrs at Boost mode, 3000hrs in Eco mode (200W).
- ◆ High efficiency cooling system with low system acoustic noise level.
- ◆ Lamp is easily replaceable by user.
- ◆ Manual zoom and focus lens with a 1:1.2 zoom ratio and 100% lens offset.
- ◆ 33" to 255" diagonal image size.
- ◆ 16.7million true colors.
- ◆ PC compatibility: VGA / SVGA / XGA / SXGA / MAC.
- ◆ Video compatibility: NTSC / PAL / SECAM / Composite / S-video / Component (YPbPr / YCbCr) / SDTV (480i) / EDTV (480p) / HDTV (576i, 576p, 720p, 1035i, 1080i).
- ◆ Auto image synchronization (auto-tracking / frequency / position adjustment / source detect).
- ◆ Automatically saves adjustments for future use.
- ◆ On-screen menu with a choice of 8 languages.
- ◆ Built-in 2W x 1 speaker
- ◆ Self-protection timer prevents hot re-strike of compact P-VIP lamp.
- ◆ Security feature: Kensington Lock.

1-2.PACKAGE CONTENTS

- ◆ Projector x 1

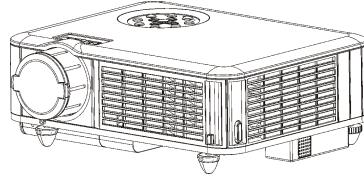

- ◆ PC Audio Cable x 1

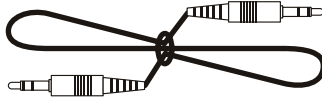

- ◆ Component Video Cable x 1

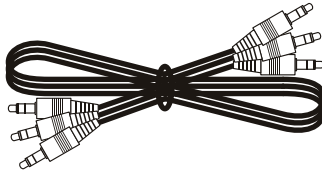

- ◆ Owner's Manual x1



- ◆ Soft Carry Bag x 1

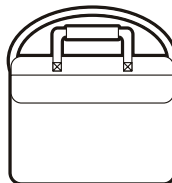

- ◆ CD Wizard x 1



- ◆ Power Cord (US/EU)

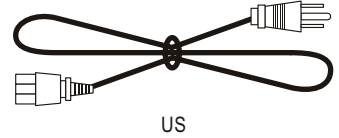

US

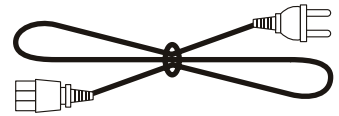

EU

- ◆ AAA Batteries x 2



- ◆ Remote Control x 1

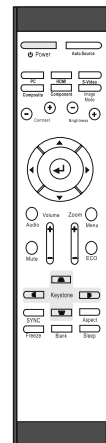

1-3.MAIN UNIT

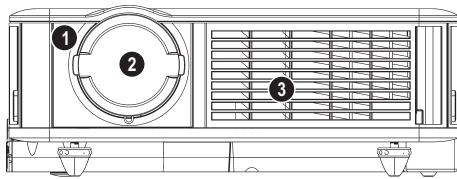

DRAWING 1

- ① IR Receiver (Front)
- ② Projection Lens
- ③ Hot Air Exhaust

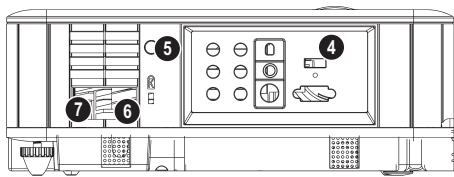

DRAWING 2

- ④ I/O Connection Panel
- ⑤ IR Receiver (Back)
- ⑥ AC Power Inlet
- ⑦ Power Switch

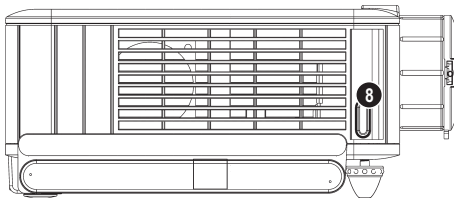

DRAWING 3

- ⑧ Elevator Button

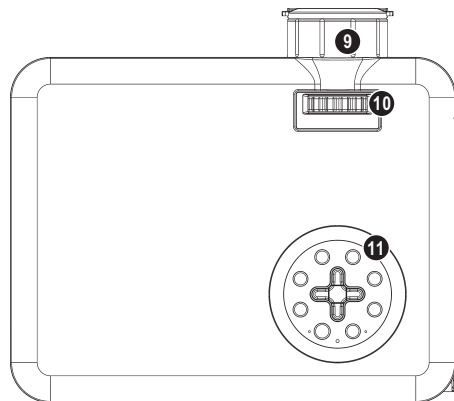

DRAWING 4

- ⑨ Focus Ring
- ⑩ Zoom Ring
- ⑪ Control Panel

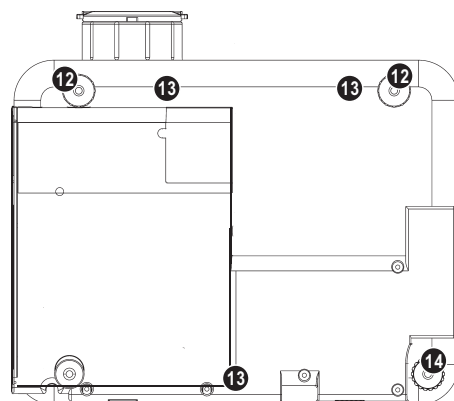

DRAWING 5

- ⑫ Elevator Feet
- ⑬ Ceiling Mount Screw Holes
- ⑭ Adjustable Foot

PRODUCT OVERVIEW

1-4. CONTROL PANEL

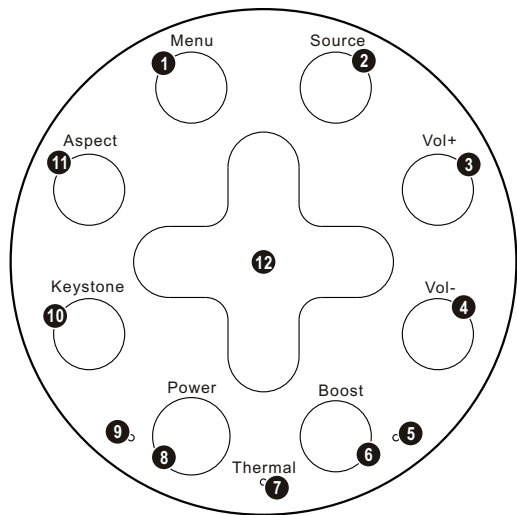

DRAWING 6

- 1 Menu
- 2 Source
- 3 Vol+
- 4 Vol-
- 5 Boost Mode Indicator
- 6 Boost
- 7 Thermal Indicator
- 8 Power
- 9 Power Indicator
- 10 Keystone
- 11 Aspect
- 12 Cursor

1-5. REAR TERMINALS

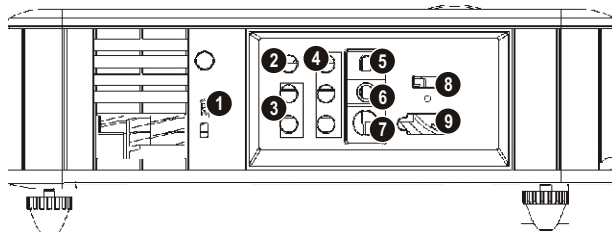

DRAWING 7

- 1 Kensington Lock
- 2 Composite Video Input
- 3 Audio Input (R / L)
- 4 Component Video Input
- 5 Trigger for Screen Relay (12V)
- 6 Audio Output
- 7 S-Video Input
- 8 HDMI Input
- 9 VGA Input

2 INSTALLATION

2-1. TURNING ON/OFF THE PROJECTOR

2-1-1. STARTING UP THE PROJECTOR

1. Ensure that the supplied power cord is securely connected at the AC inlet of the projector (Drawing 8) and power outlet.
2. Remove the lens cap.
3. Turn on the power switch. Ensure the "Power" indicator on the Control Panel is flashing blue, indicating the projector is in Standby mode.
4. Turn on the Lamp by pressing the "Power" button on the Control Panel or the "Power" button on the Remote Control. Ensure that the "Power" indicator is continuous blue, indicating the projector is on.
5. The start-up screen appears on the screen and starts to count down for 10 seconds.
6. The projector will detect the input source automatically.
7. Play your source device.

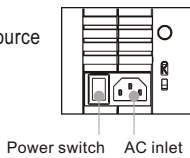

DRAWING 8

2-1-2. SHUTTING DOWN THE PROJECTOR

1. Turn off your source device first.
2. Press the "Power" button on the Control Panel or press the "Power" button on Remote Control, and a message "Power off the projector?" will show on the screen.
3. Promptly press the "Power" button again to confirm turning off the projector. Otherwise the message will disappear after 5 seconds.
4. The projector will begin a 100 seconds cooling down phase.

Note: Please don't turn off the power switch or disconnect the power cord during the cooling down period.
5. When the projector has cooled down, the "Power" indicator on the Control Panel will be flashing blue, indicating the projector is in Standby mode.
6. Turn off the power switch. Replace the lens cap.
7. Disconnect the power cord from the AC inlet of the projector and power outlet.

2-1-3. LED INDICATION STATUS

Condition	Power Indicator	Thermal Indicator	Normal/Boost Indicator	Note
1. Standby	Flashing Blue (1sec interval)	-	Green	Waiting for power on
2. Operating	Blue	-	-	Normal operation
3. Cooling	Blue	-	-	Cool lamp down for 100 sec
4. Boost Mode in Use	Blue	-	Green	Boost mode is being used
5. Fan Failure	Blue	Red (0.5sec interval)	-	Fan failure. There is a warning message displayed on the screen then the projector will turn itself off.
6. Overheating	Blue	Red (0.5sec interval)	-	Overheating in the projector: There is a warning message displayed on the screen then the projector will power itself off.
7. Overheating While Starting	Blue	Red (0.5sec interval)	-	The system will cool itself down for 8 sec automatically.
8. Lamp Cover Open	-	Red	-	If the lamp cover is not properly seated after changing a new lamp, the power can't be turned on.

INSTALLATION

2-2. ADJUSTING THE PROJECTED IMAGE

2-2-1. ADJUSTING THE PROJECTED HEIGHT

1. Press the Elevator buttons. (Drawing 3)
 2. Raise the projector to the desired display angle, allowing the legs to extend, release the buttons to lock them in position.
 3. Use the Adjustable foot (Drawing 5) at the rear of the unit to fine-tune the display angle.
 4. Use the "Keystone" button on the Remote Control or in the projector's OSD to correct any distortion caused by tilting the projector.
 5. There are two adjustable directions shown on the screen, one is vertical keystone correction, the other is horizontal keystone correction, use the cursor buttons to select the Vertical or Horizontal Keystone correction. (Drawing 10 and Drawing 11)
- Press "Right" cursor for increasing the value.
Press "Left" cursor for decreasing the value. (Drawing 9)

Keystone	
Ver. Keystone	0
Hor. Keystone	0

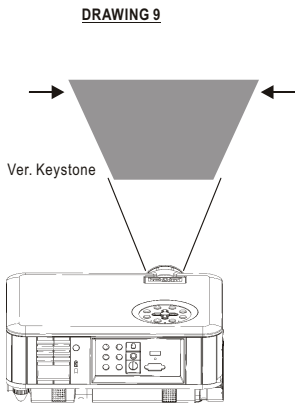

DRAWING 9

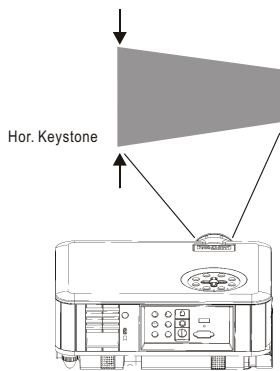

DRAWING 10



DRAWING 11

2-2-2. ADJUSTING THE ZOOM and FOCUS

Rotate the Zoom ring to adjust the image size. Rotate the Focus ring to focus the image. The projector will focus at distances from 1.5m (60in. / 5 ft.) to 10m (394 in. / 32.9 ft.). The optimum distance is from 1.5 m to 5 m (197 in. / 16.5 ft.).

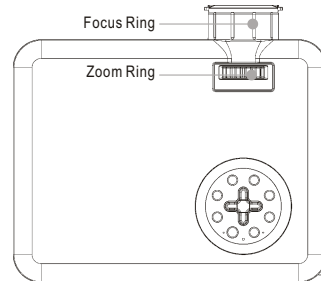

DRAWING 12

2-2-3. ADJUSTING THE PROJECTED IMAGE SIZE

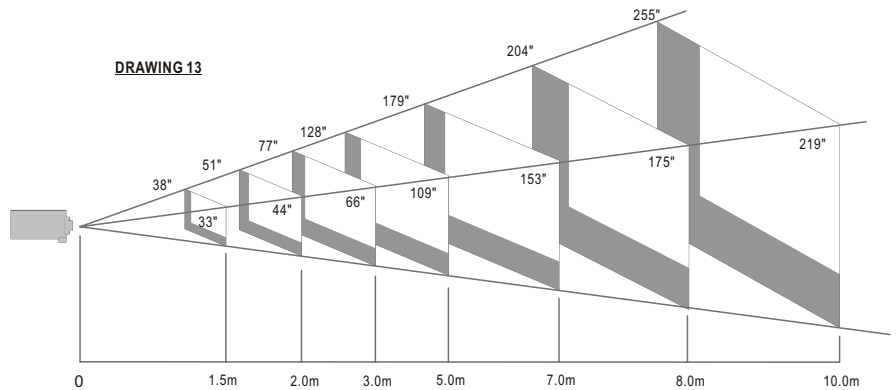

DRAWING 13

Distance To Screen (Meter/Inch)	1.5/60	2.0/79	3.0/118	5.0/197	7.0/276	8.0/315	10.0/394
Max. Screen Diagonal (Meter/Inch)	0.98/38	1.30/51	1.94/77	3.24/128	4.54/179	5.18/204	6.48/255
Min. Screen Diagonal (Meter/Inch)	0.83/33	1.11/44	1.67/66	2.78/109	3.89/153	4.44/175	5.55/219

2-3. OPERATION

2-3-1. CONNECTING TO A PERSONAL COMPUTER

◆ Connecting to a Notebook

1. Use the VGA cable to connect your Notebook to the projector. (Drawing 14)
2. Press the "Monitor Output" function key of your Notebook. (Fn+ or or or)
3. The projector will automatically detect the source. If not, please press the "Source" button on the Control Panel of the projector or on the Remote Control to select the computer source.

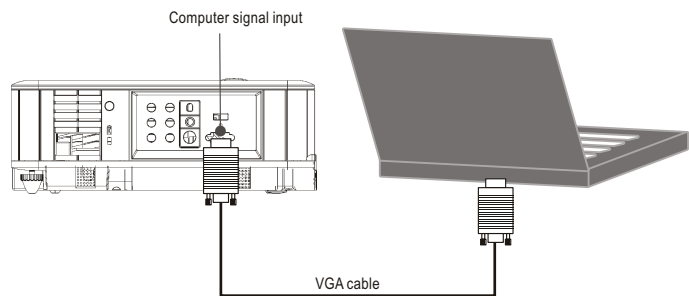

DRAWING 14

3 CONTROL PANEL AND REMOTE CONTROL

3-1. CONTROL PANEL AND REMOTE CONTROL

Control functions through the Control Panel and Remote Control.

3-1-1. USING CONTROL PANEL

- MENU:** Displays the OSD. Press again to exit the OSD.
- ASPECT:** Selects your desired aspect ratio.
- KEystone:** Adjusts image distortion caused by tilting the projector. (two directions adjustable)
- POWER:** Turns on or off the projector.
- BOOST:** High brightness mode.
- VOL-:** Decreases the volume.
- VOL+:** Increases the volume.
- SOURCE:** Selects "Composite Video", "S-Video", "Component-I Video (YCbCr)", "Analog YPbPr", "Computer", "HDMI" sources.
- UP:** Cursor function or makes an adjustment based on your selection of a function.
- LEFT:** Cursor function or makes an adjustment based on your selection of a function.
- DOWN:** Cursor function or makes an adjustment based on your selection of a function.
- RIGHT:** Cursor function or makes an adjustment based on your selection of a function.
- ENTER:** Confirms the selection.

NOTE: When press the "Down button" the display screen would automatically adjust it's image according to PC resolution.

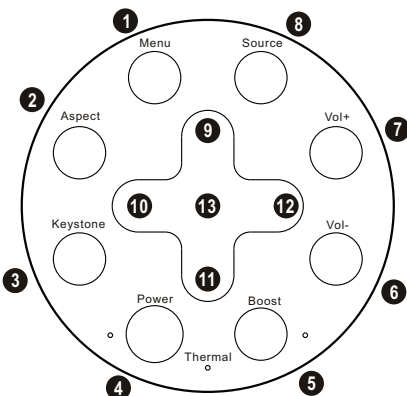

DRAWING 15

3-1-2. USING THE REMOTE CONTROL

- Power:** Turns On / Off the projector.
- Auto Source:** Selects PC, HDMI, S-Video, Component-I and Video (YCbCr), Analog YPbPr, Composite
- PC:** Directly connect to PC mode.
- HDMI:** Directly connect to HDMI mode.
- S-Video:** Directly connect to S-Video mode..
- Composite:** Directly connect to Video mode.
- Component:** Directly connect to Video mode.
- Image mode:** Selects your desired image mode in Vivid, Normal, Movie and User.
- Contrast +:** Adjusts the contrast of image.
- Contrast -:** Adjusts the contrast of image.
- Brightness -:** Adjust the brightness of projected picture images.
- Brightness +:** Adjust the brightness of projected picture images.
- Up:** Moves up when selecting item.
- Left:** Moves left when selecting item.
- Enter:** Confirms your selection.
- Right:** Moves right when selecting item.
- Down:** Moves down when selecting item.
- Audio:** Button to select audio function in OSD
- Mute:** Mutes the audio output. Press once for Mute on, press again for Mute off.
- Vol +:** Increase the volume of either the speaker.
- Vol -:** Decrease the volume of either the speaker.
- Zoom +:** Magnifies the image size.
- Zoom -:** Magnifies the image size.
- Menu:** Presses once to display the OSD. Press again to exit the OSD.

- ECO:** ECO mode for saving lamp life.
- Keystone V+:** Adjust image distortion in Vertical direction.
- Keystone H -:** Adjust image distortion in Horizontal direction.
- Keystone H +:** Adjust image distortion in Horizontal direction.
- Keystone V -:** Adjust image distortion in Vertical direction.
- SYNC:** To re-scan the image mode.
- Aspect:** Select your desired aspect ratio (native/4:3/16:9)
- Freeze:** Freeze the image. (With programs still running)
- Blank:** Displays a blank screen instead of the current image.
- Sleep:** Turns off the projector automatically after a period.

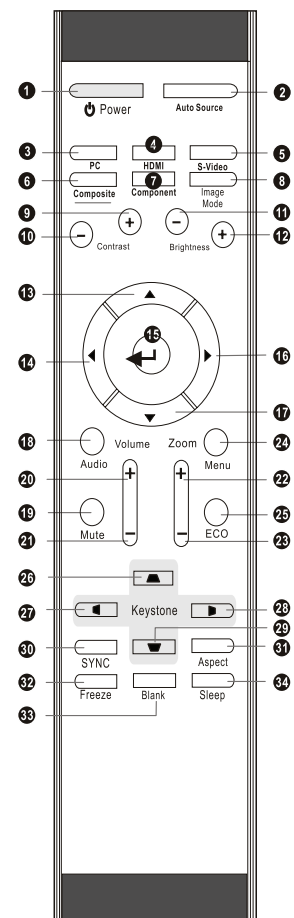

DRAWING 17

CONTROL PANEL AND REMOTE CONTROL

3-2.ON-SCREEN DISPLAY MENU

3-2-1.HOW TO OPERATE

1. Press the "Menu" button on the Remote Control or Control Panel to enter the ON-Screen Display (OSD) menu.
2. When the OSD is displayed, use "Cursor" buttons on the Control Panel or on the Remote Control to choose the item you need.
3. Press the "Menu" button again to exit.

3-2-2.PROJECTOR'S OSD

3-2-2-1.MAIN MENU

Press the "Enter" button to enter the submenu, press it again to return to the main menu.

Main Menu includes:

- Image
- Display
- Audio
- System
- Language



DRAWING 18

3-2-2-2.IMAGE

◆ Computer Image (RGB)

Brightness: Adjusts the brightness of the image.

Contrast: Adjusts the contrast of the image.

Frequency: Adjusts the frequency to match the frequency of your computer's graphic card.

Tracking: Synchronizes the signal timing with your computer's graphic card.

Hor. Position: Moves the image's horizontal position.

Ver. Position: Moves the image's vertical position.

Image Mode: Chooses a mode you prefer.

Vivid: This mode is good for watching dynamic pictures.

Normal: This mode is the standard light engine mode.

Movie: This mode is good for movie pictures.

User: This mode allows you to adjust details of image. Press the "Right" button to enter the submenu.

Edge Enhancement: Adjusts the overall sharpness of the video signals.

Gamma: Adjusts the Gamma (mid-tone brightness) curve.

Noise Reduction: Adjusts signal noise reduction.

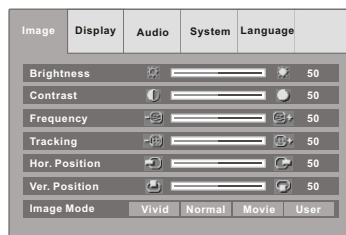

DRAWING 19

Submenu

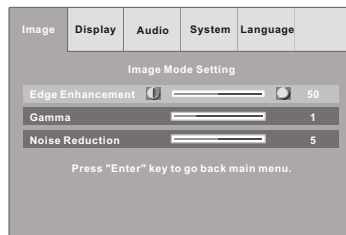

DRAWING 20

◆ Computer Image (HDMI & Component)

Brightness: Adjusts the brightness of the image.

Contrast: Adjusts the contrast of the image.

Image Mode: Chooses a mode you prefer.

Vivid: This mode is good for watching dynamic pictures.

Normal: This mode is the standard light engine mode.

Movie: This mode is good for movie pictures.

User: This mode allows you to adjust details of image. Press the "Right" button to enter the submenu.

Gamma: Adjusts the Gamma (mid-tone brightness) curve.

Noise Reduction: Adjusts signal noise reduction.



DRAWING 21

◆ Video Image (S-Video, Composite)

Brightness: Adjusts the brightness of the image.

Contrast: Adjusts the contrast of the image.

Color Satur.: Adjusts color saturation of the image.

Sharpness: Adjusts the sharpness of the image.

Tint: Adjusts the color balance of red and green.

Image Mode: Chooses a mode you prefer.

Vivid: This mode is good for watching dynamic pictures.

Normal: This mode is the standard light engine mode.

Movie: This mode is good for movie pictures.

User: This mode allows you to adjust details of image. Press the "Right" button to enter the submenu.



DRAWING 22

3-2-2-3.DISPLAY

Aspect Ratio: Selects your desired aspect ratio.

Zoom: Increases or reduces the size of the image.

Keystone: Adjusts image distortion caused by tilting the projector.

Color Temperature: Adjusts the color temperature of the image. A higher color temperature looks cooler. A lower color temperature looks warmer. When the color temperature is set to User mode, press "Down"

CONTROL PANEL AND REMOTE CONTROL

button to select Red, Green, or Blue adjustment.

Red, Green, Blue: Increases or decreases the value to find the desired color temperature.

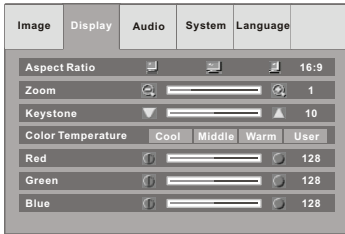

DRAWING 23

3-2-2-4. AUDIO

Volume: Adjusts the volume.

Treble: Adjusts the treble audio.

Bass: Adjusts the Bass audio.

Mute: Mutes the speaker.

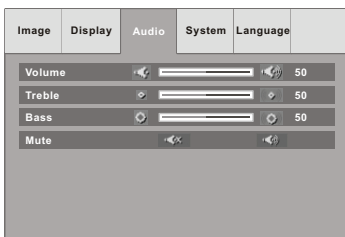

DRAWING 24

3-2-2-5. SYSTEM

OSD Location: Chooses the OSD location on the display screen.

Projection: Selects the projector's orientation.

Front: The factory default setting. For "tabletop" projection.

Front Ceiling: Inverts the image. For "ceiling mounted" projection.

Rear: Reverses the image. For "tabletop" rear projection.

Rear Ceiling: Reverses and inverts the image. For "ceiling mounted" rear projection.

Lamp Hours: Displays the cumulative lamp operation time.

Lamp Reset: Resets the lamp operation time after changing lamps.

Auto Source: Detects the input source automatically.

Factory Reset: Resets projector's parameters to the default settings.

Over Scan: Select your desired mode video or PC to do the over scan.

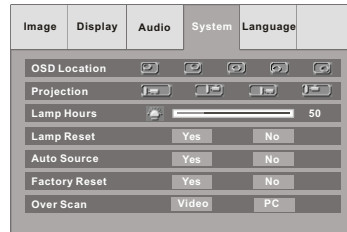

DRAWING 25

3-2-2-6. LANGUAGE

Select the OSD Language you need.



DRAWING 26

4 APPENDICES

4-1. TROUBLE SHOOTING

- No images appears
 - ◆ Check the power cable connection at the power inlet of the projector and at the wall outlet.
 - ◆ Confirm that the main power switch at the rear of the projector is in the "on" position.
 - ◆ Check the Power indicator. (Section 3-1)
 - ◆ Confirm that the lens cap has been removed.
 - ◆ Make sure the source device is properly connected to the projector, and is outputting a signal.
 - ◆ Press "Source" button on either the projector or the Remote Control to ensure that the correct source is selected.
- Image is blurred
 - ◆ Ensure the distance between the projector and the screen is within the focus range of the lens. (Section 2-2)
 - ◆ Adjust the focus ring.
- Image is too dark
 - ◆ Adjust the contrast or brightness in the image menu of projector properly.
 - ◆ Has the lamp reached the end of its life? If so replace the lamp.
- Computer image is unstable or the projector isn't projecting the whole image
 - ◆ Enter the "Image" menu to adjust the tracking or frequency.
 - ◆ Verify that the computer's output resolution to the projector is less than or equal to 1280 x 768.
- Image is stretched
 - ◆ Adjust the "Aspect Ratio" in the OSD of projector.
- No sound
 - ◆ Make sure the Mute option in Audio menu is off.

- ◆ Make sure the Audio setup menu or speaker setup menu in DVD player's OSD is set properly.
 - ◆ Make sure the speaker option in audio menu is set as required.
- Remote control does not work
 - ◆ Install new batteries.
 - ◆ Make sure there are no obstacles between you and the projector's IR receivers.
 - ◆ Make sure you are attempting to operate it within its usable range. (Drawing 17)
 - The color of image is not correct
 - ◆ Please reset all settings.

4-2. MAINTENANCE

4-2-1. REPLACING THE LAMP

When the lamp's total working time accumulates to over 1850 hours, the on-screen display (OSD) will deliver a message recommending that you replace the lamp. Please contact a service center to replace the lamp as soon as possible, or refer to the following instructions to replace it yourself.

◆ TO REPLACE THE LAMP

- Turn off the projector by pressing the "Power" button.
- Allow the projector to cool down for at least one hour.
- Switch off the power and disconnect the power cord.
- Loosen the screw on the lamp cover and remove the lamp cover. (Drawing 27)
- Loosen three screws on the lamp module (Drawing 28) remove the lamp module by pulling on the handle. (Drawing 29)
- Insert a new lamp module (Drawing 30) into the socket: make sure it is in position.
- Reverse steps 4 and 5.

- Ensure that the lamp cover is securely attached and flush with the bottom of the unit. The unit will not operate with the cover incorrectly installed.
- Reset the lamp timer.

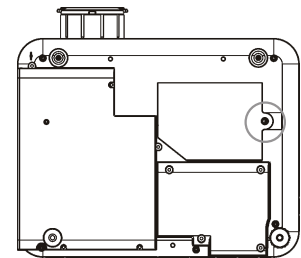

DRAWING 27

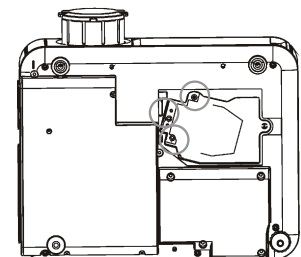

DRAWING 28

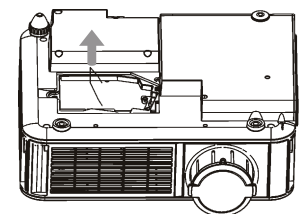

DRAWING 29

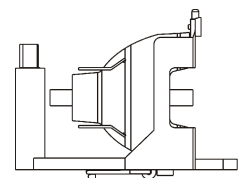

DRAWING 30

◆ **To reset the lamp timer**

1. Press the Menu button on control panel or Remote Control.
2. Go into the system menu and move the cursor to the lamp reset item.
3. Select "Yes" to execute the lamp reset and the lamp hours will reset to 0 hour.

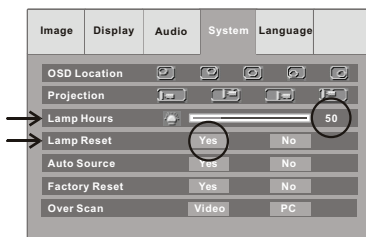

DRAWING 31

◆ **IMPORTANT**

- * Do not touch the lamp immediately after it has been used: it will be extremely hot. Allow the fan to finish its cooling process, then turn the projector off, and disconnect the power cord. Then allow at least one hour for the lamp to cool down before handling.
- * Do not remove any screws other than the lamp cover screw and the lamp housing screws. Removing other screws could result in electric shock.
- * Although the mercury content of the lamp is minuscule, spent lamps should be treated as hazardous waste. Consult federal, state/provincial or local regulations for proper disposal.

◆ **CAUTION**

Continuing to use the lamp after the replace the lamp message has been displayed on the screen may result in the lamp exploding. If this occurs, pieces of glass may scatter inside the projector, and out into the room. If this occurs, do not touch them, as the pieces of glass may cause injury. The bulb contains a small amount of mercury: ventilate the area well. Contact your dealer for servicing: do not attempt to service the projector yourself.

4-2-2. CLEANING THE PROJECTOR

◆ **Cleaning the cabinet**

Turn off projector and unplug the power cord from the projector before cleaning the outer cabinet.

Wipe lightly with a soft, dry cloth. If the cabinet is very dirty, clean it with a soft, dampened cloth using mild commercial cleaner and finish with a dry cloth. Do not use liquid or aerosol cleaners.

◆ **Cleaning the lens**

Clean the lens carefully by using a blower or lens paper to prevent creating any scratches on lens.

APPENDICES

4-3. SPECIFICATION

Color system	NTSC / PAL / SECAM / NTSC4.43
Computer Compatibility	SXGA (Compression) / XGA / SVGA / VGA / Mac
Screen Size (Diagonal)	33"-255"
Throw Distance	1.5m 10m
DMD Panel	Single 0.65" DMD
Number of Pixels	983,040(1280x768)
Projection Lens	F2.4, Zoom Ratio: 1.2:1
Projection Lamp	250 W / 2000 Hours (Boost Mode), 200 W / 3000 Hours (Eco Mode)
Digital Keystone	+/- 16 Degrees (Vertical), +/- 7 Degrees (Horizontal)
Front Elevation	Up to 10 Degrees
Scanning Frequency	Automatic Frequency Control H sync. 15kHz-82kHz, V sync. 50Hz-85Hz
Operating Temperature	5°C to +35°C
Input	D-Sub 15-pin x 1 (VGA) RCA Jack x 3 (Component Video), RCA x 1 (Composite Video) Mini DIN 4-pin x 1 (S-Video), RCA x 2 (R, L-mono) HDMI x 1 (Digital Video & Audio)
Output	3.5mm mini Jack x 1: Audio out 3.5mm DC Power Jack x 1 (12V Trigger for Screen Relay)
Audio	2W x 1
Power Supply	100 - 240V, 50 - 60Hz
Power Consumption	330W
Dimensions (W x D x H)	333 x 295 x 123mm
Net Weight	4.5 kg (10 lb)
Regulations	1. EMC - FCC Class B, CE Class B, CCC Class B 2. Safety - UL, cUL, TUV, CB, NOM, GOST, SASO
Accessories	Power Cord Audio Cable Component Video Cable Remote Control Soft Carry Bag for Projector

Customer Support

For technical support or product service, see the table below or contact your reseller.

Note : You will need the product serial number.

Country/ Region	Web Site	T=Telephone F=Fax	E-mail
United States	www.viewsonic.com/support/	T= 800 688 6688 F= 909 468 1202	service.us@viewsonic.com
Canada	www.viewsonic.com/support	T= 866 463 4775	service.ca@viewsonic.com
United Kingdom	www.viewsoniceurope.com/uk	T= 0207 949 0307	service.eu@viewsoniceurope.com
Europe, Middle East, Baltic countries, and North Africa	www.viewsoniceurope.com	Contact your reseller	service.eu@viewsoniceurope.com
Australia and New Zealand	www.viewsonic.com.au/support/	AUS= 1800 880 818 NZ= 0800 008 822	service@au.viewsonic.com
Singapore/ Malaysia/ Thailand	www.viewsonic.com.sg/support/	T= 65 6461 6044	service@sg.viewsonic.com
South Africa/Other countries	www.viewsonic.com	T= 886 2 2246-3456 F= 886 2 2249-1751	service@sd.viewsonic.com
Hong Kong	www.hk.viewsonic.com/support/	T= 852 3102 2900	service@hk.viewsonic.com
Macau	www.hk.viewsonic.com/support/	T= 853 700 303	service@hk.viewsonic.com
Korea	www.viewsonic.com	T= 080 2659 080	service@kr.viewsonic.com

Limited Warranty

ViewSonic® Projector

What the warranty covers:

ViewSonic warrants its products to be free from defects in material and workmanship during the warranty period. If a product proves to be defective in material or workmanship during the warranty period, ViewSonic will at its sole option repair or replace the product with a like product. Replacement product or parts may include remanufactured or refurbished parts or components.

How long the warranty is effective:

North and South America: Three (3) years warranty for all parts excluding the lamp, three (3) years for labor, and ninety (90) days for the original lamp from the date of the first consumer purchase. Europe except Poland: Three (3) years warranty for all parts excluding the lamp, three (3) years for labor, and ninety (90) days for the original lamp from the date of the first consumer purchase. Poland: Two (2) years warranty for all parts excluding the lamp, two (2) years for labor, and ninety (90) days for the original lamp from the date of the first consumer purchase. Other regions or countries: Please check with your local dealer or local ViewSonic office for the warranty information.

Lamp warranty subject to terms and conditions, verification and approval. Applies to manufacturer's installed lamp only. All accessory lamps purchased separately are warranted for 90 days.

Who the warranty protects:

This warranty is valid only for the first consumer purchaser.

What the warranty does not cover:

1. Any product on which the serial number has been defaced, modified or removed.
2. Damage, deterioration or malfunction resulting from:
 - a. Accident, misuse, neglect, fire, water, lightning, or other acts of nature, unauthorized product modification, or failure to follow instructions supplied with the product.
 - b. Repair or attempted repair by anyone not authorized by ViewSonic.
 - c. Any damage of the product due to shipment.
 - d. Removal or installation of the product.
 - e. Causes external to the product, such as electric power fluctuations or failure.
 - f. Use of supplies or parts not meeting ViewSonic's specifications.
 - g. Normal wear and tear.
 - h. Any other cause which does not relate to a product defect.
3. Any product exhibiting a condition commonly known as "image built-in" which results when a static image is displayed on the product for an extended period of time.
4. Removal, installation, and set-up service charges.

How to get service:

1. For information about receiving service under warranty, contact ViewSonic Customer Support. You will need to provide your product's serial number.
2. To obtain warranted service, you will be required to provide (a) the original dated sales slip, (b) your name, (c) your address, (d) a description of the problem, and (e) the serial number of the product.
3. Take or ship the product freight prepaid in the original container to an authorized ViewSonic service center or ViewSonic.
4. For additional information or the name of the nearest ViewSonic service center, contact ViewSonic.

Limitation of implied warranties:

There are no warranties, express or implied, which extend beyond the description contained herein including the implied warranty of merchantability and fitness for a particular purpose.

Exclusion of damages:

ViewSonic's liability is limited to the cost of repair or replacement of the product. ViewSonic shall not be liable for:

1. Damage to other property caused by any defects in the product, damaged based upon inconvenience, loss of use of the product, loss of time, loss of profits, loss of business opportunity, loss of goodwill, interference with business relationships, or other commercial loss, even if advised of the possibility of such damages.
2. Any other damages, whether incidental, consequential or otherwise.
3. Any claim against the customer by other party.

Effect of state law:

This warranty gives you specific legal rights, and you may also have other rights which vary from state to state. Some states do not allow limitations on implied warranties and/or do not allow the exclusion of incidental or consequential damages, so the above limitations and exclusions may not apply to you.

Sales outside the U.S.A. and Canada:

For warranty information and service on ViewSonic products sold outside of the U.S.A. and Canada, contact ViewSonic or your local ViewSonic dealer.

Warranty Projectors Rev. 1d

4.3: Projector Warranty

1 of 1

Release Date: 03-31-05

