

Parts List and Wiring Diagrams

Model PH-44 Headset



The PH-44 headset is a super lightweight, dual sided headset for the ultimate in day-long comfort. The PH-44 features a high quality dynamic earphones with a dynamic noise cancelling microphone on an adjustable boom that can be bent to practically any mouth-to-mic position. The unit has a straight cord and is available in various connector configurations.

Specifications

Receiver Type Dynamic
 Receiver Impedance 300 ohms
 Microphone Type Dynamic
 Microphone Impedance 200 ohms
 Weight 5.1 ozs
 Cord 6 ft. straight

Parts List

ITEM NO.	DESCRIPTION	QTY	PART NO.
1	Windscreen	1	59835-000
2	PT-Pan Head Screw, KA15 x 6(.236) LG., Black	4	590404-360
3	Glider Spring	2	64305-000
4	Housing Assy.	1	64308-106
5	Housing Assy.	1	64308-110
6	Glider Assy.	2	64310-000
7	Cord Amp Assy.	1	64311-054
8	Boom Mic / Housing Assy.	1	800499-101
9	Headband Assy.	1	64352-033
10	Housing, Rear	1	800504-001
11	Ear Cushion	2	590626-000
	Connector, PH-44, XLR-4F	1	35320-004
	Connector, PH-44R, XLR-4M	1	35398-004
	Connector, PH-44R5, XLR-5M	1	35398-005
	Connector, PH-44A5, XLR-5F	1	35320-005
	Connector, PH-44R6, XLR-6M	1	35398-009

Exploded View

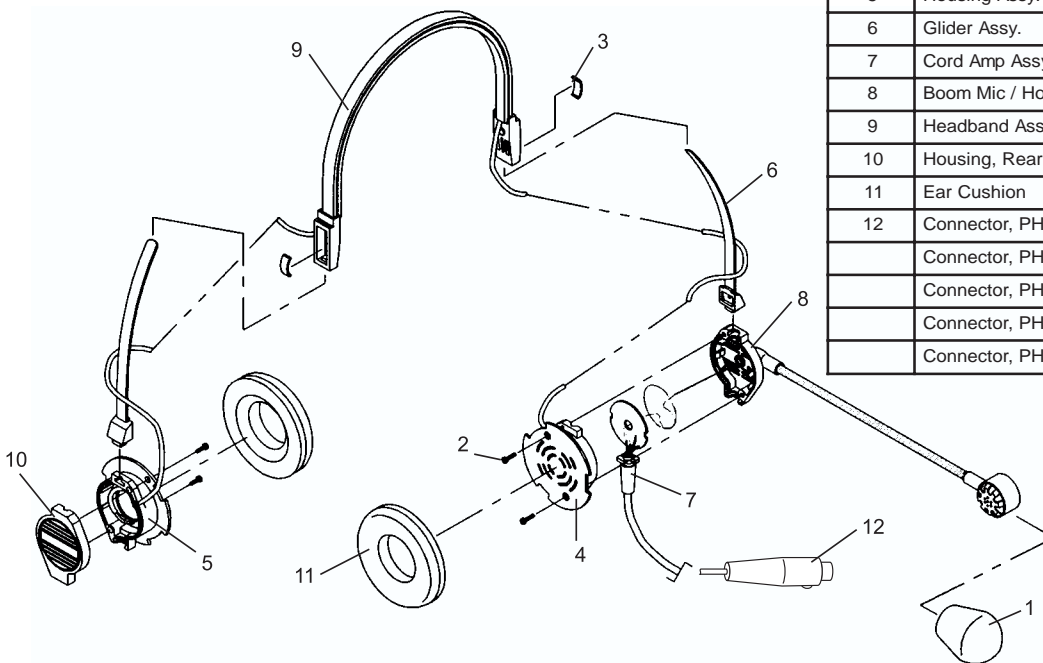

Wiring Diagram

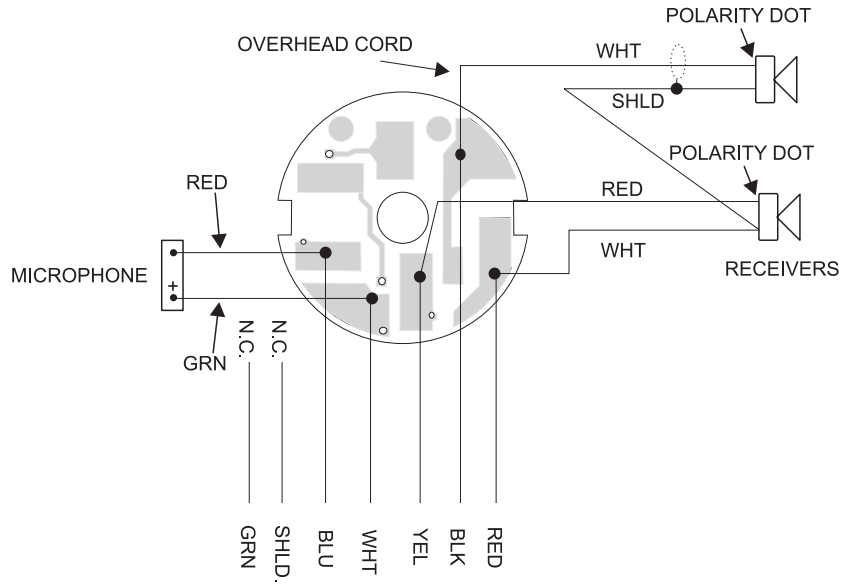

Connector Wiring

PH-44

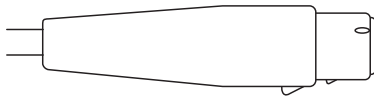

4 Pin Female

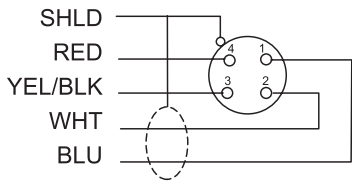

300853-400

PH-44R

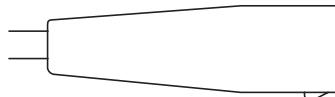

4 Pin Male

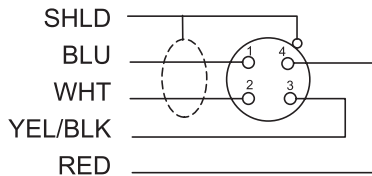

300853-401

PH-44A5

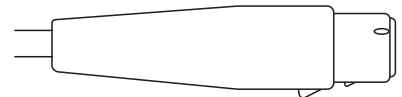

5 Pin Female

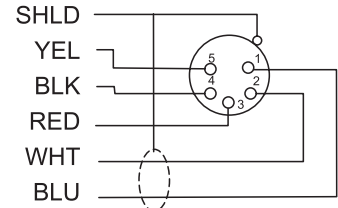

300853-500

PH-44R5

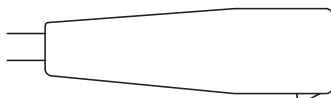

5 Pin Male

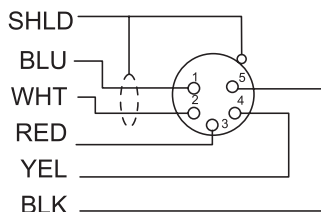

300853-501

PH-44R6

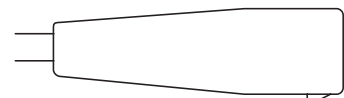

6 Pin Male

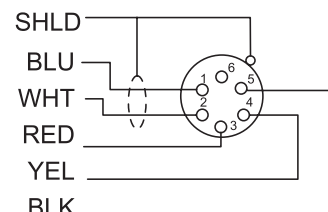

300853-600

TELEX®