

Parts List and Wiring Diagrams

Model PH-1 Headset (64438 Series)



The PH-1 headset is a medium weight, full cushion, single sided headset for the ultimate in day-long comfort. The PH-1 features a high quality monaural dynamic earphone with dynamic noise cancelling microphone on adjustable ball joint boom that can be positioned on either side of the head. The unit has a straight cord and is available in various connector configurations.

Specifications

Receiver Type Dynamic
 Impedance 150 ohms
 Microphone Type Dynamic
 Impedance 150 ohms
 Weight 12 ozs
 Cord 6' straight

Parts List

ITEM NO.	DESCRIPTION	QTY	PART NO.
1	Headband Assy.	1	61162-046
2	Headband Spacer	1	63709-001
3	Slider Tip	1	61166-005
4	Headband	1	63801-001
5	Earcup-Yoke-Slider Assy	1	70398-034
6	Boom Assy	1	70398-001
7	Strain Relief	1	63465-006
8	Connector, PH-1 XLR-4F	1	35320-004
	Connector, PH-1R, XLR-4M	1	35398-004
	Connector, PH-1R5, XLR-5M	1	35398-005
9	Cushion	1	64442-000
10	Cord Unit	1	63988-063
11	Terminal	1	54462-001
12	Screw, No. 6-20 x 1/4	1	51856-008
13	Ball Half	1	63451-003
14	Ball Joint Spring	1	63453-000
15	Hex Spacer	2	57907-000
16	Foam Liner	1	63763-000
17	Screw, No. 4-40 x 1/4	2	51845-038
18	Ear Cushion	1	63444-001
19	Ear Cushion Cover	1	35772-000
20	Receiver Element/Earplate Assy	1	70398-035
21	Foam	1	70608-000
22	Slider	1	64440-001
23	Screw, No. 2-28 x 3/8	1	51856-002
24	Mic Housing Cover	1	63460-005
25	Foam	1	63124-018
26	Mic Element Assy	1	61585-037
27	Mic Housing	1	63459-005
28	Contact Tension Spring	1	63455-000

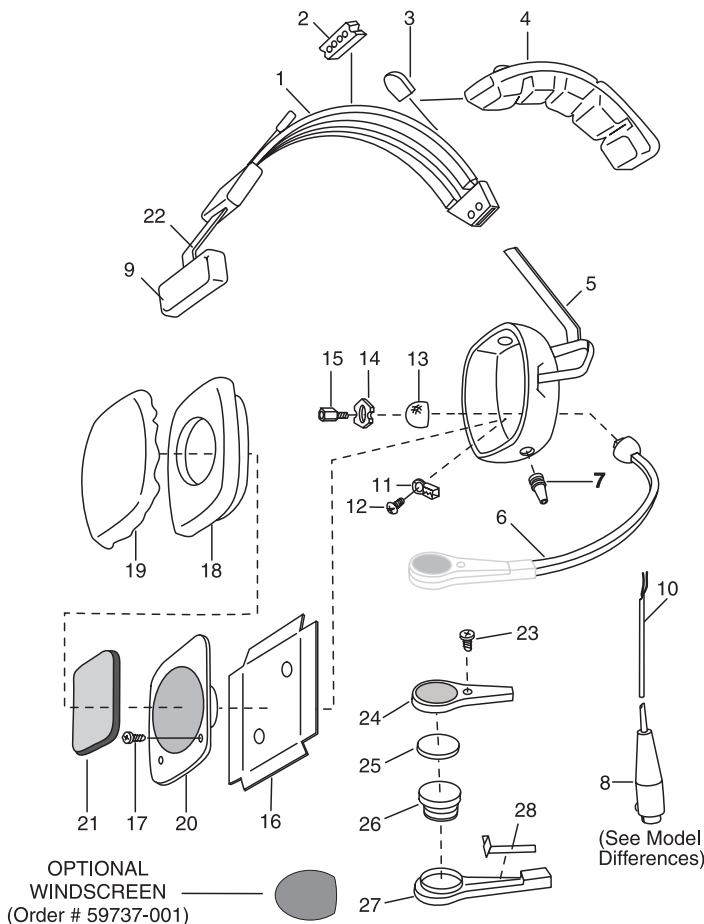

Wiring Diagram

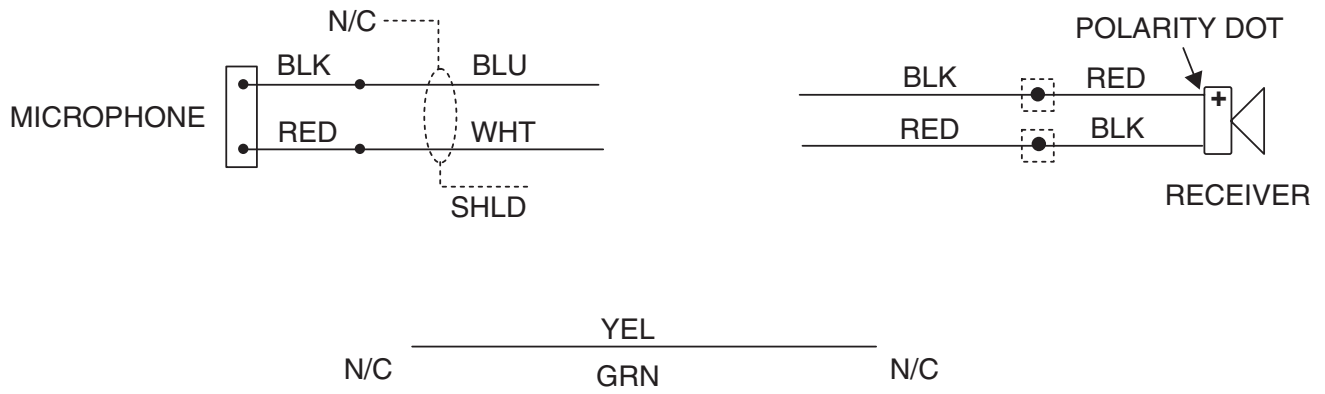

Connector Wiring

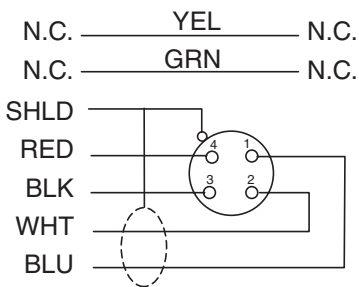
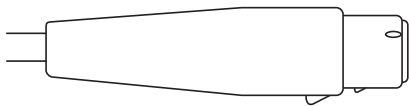

64438-100

PH-1

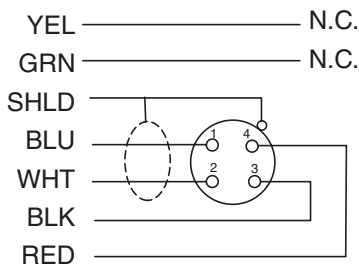
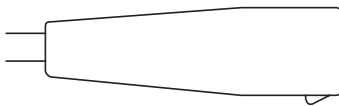

64438-102

PH-1R

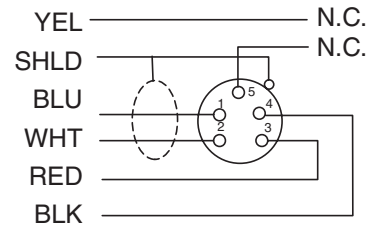
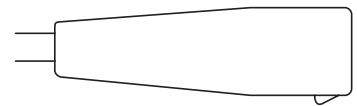

64438-103

PH-1R5

