

## 372 SPL Computer



**U S E R G U I D E**

### **372 SPL Computer User's Guide**

© June 2000 Symetrix, Inc.

All rights reserved.

Printed in the United States of America

Symetrix Part Number 53372-0A00

The information in this guide is subject to change without notice. Symetrix, Inc. shall not be liable for technical or editorial errors or omissions contained herein; nor is it liable for incidental or consequential damages resulting from the furnishing, performance, or use of this material.

Mention of third-party products is for informational purposes only and constitutes neither an endorsement nor a recommendation. Symetrix assumes no responsibility with regard to the performance or use of these products.

Under copyright laws, no part of this user guide may be reproduced or transmitted in any form or by any means, electronic or mechanical, without permission in writing from Symetrix, Inc. If, however, your only means of access is electronic, permission to print one copy is hereby granted. Permission to copy the Architects and Engineers Specifications for written proposals specifying equipment for sound reinforcement systems is, also, granted.

Symetrix, Inc.  
14926 35th Avenue West  
Lynnwood WA 98037-2303  
USA

Tel: 425.787.3222

Fax: 425.787.3211

Web: [www.symetrixaudio.com](http://www.symetrixaudio.com)

Email: [symetrix@symetrixaudio.com](mailto:symetrix@symetrixaudio.com)



<b>Before You Begin</b>	<b>2</b>	Gap Threshold	20
What Ships in the Box	2	Force Sense Time	20
Getting Help	2	AGC	20
Optional Rackmount Accessories	2	Trigger Input	21
Notational Conventions in this User Guide	2	Setup Unlocked	21
Operational Safety Summary	3		
Equipment Markings	3		
<b>Features of the 372</b>	<b>4</b>	<b>Calibrating the 372</b>	<b>22</b>
 		<b>Conditions Under Which the 372 Will Not Sense</b>	<b>23</b>
<b>Checklist of Tasks for Hardware Connections, System Setup, and Calibration</b>	<b>5</b>	<b>Signal Flow Diagram</b>	<b>24</b>
 		<b>Input and Output Connector Wiring</b>	<b>25</b>
<b>Making Hardware Connections</b>	<b>6</b>	<b>Troubleshooting</b>	<b>26</b>
Overview of Rear Panel Connectors and Connections	6	<b>Hardware Specifications</b>	<b>28</b>
Sensing Speaker Considerations	8	<b>Architects and Engineers Specifications</b>	<b>29</b>
372 Basic Connection	9	<b>Warranty</b>	<b>30</b>
Connecting an External Relay to Drive Amplifiers Larger than 200W	10	<b>Service</b>	<b>31</b>
Connecting Up to 20 Slaves	11	<b>Declaration of Conformity</b>	<b>32</b>
Connecting an External Relay to Attach Slaves	12		
Connecting a Push Button Switch to Force or Prevent Sensing	13		
<b>System Setup</b>	<b>14</b>		
Overview of Front Panel	14		
How System Setup Works	15		
Description of Menu Features	16		
Operating Mode	16		
Status	18		
History	18		
Listen	18		
Set MIN Limit	19		
Set MAX Limit	19		
Averaging Time	19		
Gain: Sense Ratio	19		



## What Ships in the Box

- The 372 unit
- One PS-3 or PS-3E (export version) power supply
- This user's guide
- A warranty card  
You can register online at [www.symetrixaudio.com](http://www.symetrixaudio.com)

When you register the 372, you get 4 extra years of warranty coverage.

## Getting Help

If you have questions beyond the scope of this guide, contact our Customer Service Department in the following ways:

**T** US customers (888) 349-3222  
International customers (425) 787-3222  
6:00 am to 4:30 pm Monday through Friday, Pacific Time

**F** (425) 787-3211  
[tech@symetrixaudio.com](mailto:tech@symetrixaudio.com)  
[www.symetrixaudio.com](http://www.symetrixaudio.com)

## Optional Rackmount Accessories

MODEL	ITEM	DESCRIPTION
<b>RM-3</b>	<b>19" Rackmount Tray</b>	<b>1U shelf</b>
<b>FP-3</b>	<b>Filler Panel</b>	<b>Covers unused half of rack tray when one 372 unit is mounted</b>
<b>PY-3</b>	<b>Y Power Cable</b>	<b>Connects a 372 with any other 300 Series product</b>

Contact your dealer or Symetrix for purchasing information.

## Notational Conventions in this User Guide

- Note** Identifies information that needs extra emphasis. Generally supplies extra information to help you to better use the 372.
- CAUTION** Identifies information that, if ignored, may cause damage to the 372 or other equipment in your system.
- WARNING** Identifies information that, if ignored, may be hazardous to your health or that of others.
- SMALL CAPS** Controls, switches or other markings on the chassis of the 372.
- Bold Face** Indicates menu option in the 372 LCD display.



## Operator Safety Summary

Follow all warnings and instructions. Install in accordance with the manufacturer's instructions.

**Power Source** This product is intended to operate from a Symetrix PS-3 or PS-3E power supply.

**Grounding** The chassis of this product is grounded through the grounding conductor of the PS-3 or PS-3E power cord. To avoid electric shock, plug the power cord into a properly wired receptacle before making any connections to the product. A protective ground connection, by way of the grounding conductor in the power cord, is essential for safe operation. Do not defeat the safety purpose of the grounding plug. The grounding plug has two blades and a third grounding prong. The third prong is provided for your safety. When the provided plug does not fit your outlet, consult an electrician for replacement of the obsolete outlet.

**Danger from Loss of Ground** If the protective ground connection is lost, all accessible conductive parts, including knobs and controls that may appear to be insulated, can render an electric shock.

**Proper Power Cord** Use only the power cord and connector specified for the product and your operating locale. Use only a cord that is in good condition. Protect the power cord from being walked on or pinched, particularly at the plug, convenience receptacle, and the point where the cord exits from the apparatus.

**Operating Location** Do not operate this equipment under any of the following conditions: explosive atmospheres, in wet locations, in inclement weather, improper or unknown AC mains voltage, or if improperly fused. Do not install near any heat source such as radiators, heat registers, stoves, or other apparatus (including amplifiers) that produce heat. Unplug this apparatus during lightning storms or when unused for long periods of time.

**Stay Out of the Box** To avoid personal injury (or worse), do not remove the product covers or panels. Do not operate the product without the covers and panels properly installed. Only use accessories specified by the manufacturer. Clean only with a damp cloth.

**User-serviceable parts** There are no user serviceable parts inside the 372. In case of failure, refer all servicing to the factory. Servicing is required when the 372 has been damaged in any way, such as when a power supply cord or plug is damaged, liquid has been spilled or objects have fallen into the apparatus, the apparatus has been exposed to rain or moisture, does not operate normally, or has been dropped.

## Equipment Markings



**WARNING:** TO REDUCE THE RISK OF FIRE OR ELECTRIC SHOCK DO NOT EXPOSE THIS EQUIPMENT TO RAIN OR MOISTURE

**AVIS:** RISQUE DE CHOC ELECTRIQUE NE PAS OUVRIR

SEE OWNERS MANUAL. VOIR CAHIER D'INSTRUCTIONS.  
No user serviceable parts inside. Refer servicing to qualified service personnel.  
Il ne se trouve à l'intérieur aucune pièce pouvant être réparée l'utilisateur.  
S'adresser à un réparateur compétent.

The lightning flash with arrowhead symbol within an equilateral triangle is intended to alert the user of the presence of uninsulated "dangerous voltage" within the product's enclosure that may be of sufficient magnitude to constitute a risk of electric shock to persons. The exclamation point within an equilateral triangle is intended to alert the user of the presence of important operating and maintenance (servicing) instructions in the literature accompanying the product (i.e., this user's guide).

### CAUTION

**To prevent electric shock, do not use the polarized plug supplied with the unit with any extension cord, receptacle, or other outlet unless the blades can be fully inserted.**



<b>Uses Speakers for Noise Sensing</b>	In less than 1 second, the Symetrix 372 temporarily opens up the amplifier connection and routes the loudspeakers to a preamplifier for the purpose of measuring changes in the ambient noise level. Samples during absence of page and/or music audio, or at preset intervals.
<b>Headphone Monitoring</b>	Monitor the sense signal using a separate front panel headphone output.
<b>5 Operating Modes</b>	<p><b>MUSIC</b> Music only or music + page. Use Gap and/or Force Sense Time.</p> <p><b>PAGE</b> Only paging and announcement audio. Use Force Sense Time at preset intervals.</p> <p><b>SLAVE</b> Forces all 372 units in a multi-zone system to execute a sense sample at the same time.</p> <p><b>HISTORY</b> Records and displays the lowest and highest SPL readings from when the unit was last reset.</p> <p><b>BYPASS</b> Bypasses the gain control of the SPL controller and the AGC.</p>
<b>Signal Path</b>	Controls mono or stereo signals through Euroblock connectors.
<b>Programmable Sensing Operation</b>	Select the auto-sense mode and/or the time interval between sense samples.
<b>Simple Calibration</b>	Use step-through menus on the front panel LCD. Perform calibration under typical installation conditions. No waiting for the quietest or noisiest ambient environment.
<b>AGC Control</b>	Enables or disables auto leveling of input signals.
<b>Ambient Adjustment</b>	Choose an adjustment ratio of SPL change vs. program level change.
<b>Sense Signal Monitoring</b>	<p>Display numeric reading and relative bargraph of the signal appearing at the sense terminals.</p> <p>Listen to sense signal with headphones connected to front panel mono output.</p>
<b>Gain Controls</b>	Set minimum and maximum limits for SPL gain range. Gain range is +20 to -30 db.
<b>Averaging Time</b>	Choose integration time of the running average SPL.



# Checklist of Tasks for Hardware Connections, System Setup, and Calibration

	REQUIRED	RECOMMENDED	OPTIONAL	TASK TO DO
HARDWARE CONNECTIONS	●			Connecting input sources
	●			Connecting output sources (use Symetrix 303 for unbalanced outputs)
	●			Connecting speaker for sensing and music/paging
			◆	Connecting speaker for either music or paging; does not sense
			◆	Connecting an external relay if maximum amplifier voltage and wattage exceeded
			◆	Connecting slave 372s
			◆	Connecting a switch or contact closure to manually force or prevent sensing
SYSTEM SETUP	●			Choose <b>Operating Mode*</b>
			◆	View calibration <b>Status</b>
			◆	Collect <b>History</b> of highest and lowest SPLs
	●			Set gain level in <b>Listen</b>
	●			<b>Set MIN limit</b> (gain)
	●			<b>Set MAX limit</b> (gain)
		■		Specify number of samples in <b>Averaging Time</b>
		■		Specify <b>Gain: Sense Ratio</b>
	●			Set <b>Gap Threshold</b>
	●			Specify time for <b>Force Sense Time</b>
			◆	Enable <b>AGC</b>
		◆	Specify type of <b>Trigger Input</b>	
	■		Lock or <b>Unlock Setup</b>	
CALIBRATION	●			Equating ambient noise level to 0 db (Unity) gain

\*Bold face indicates menu name in LCD display

# Making Hardware Connections



- | **Overview of Rear Panel Connectors and Connections** | Sensing Speaker Considerations
- | 372 Basic Connection | Connecting an External Relay to Drive Amplifiers Larger than 200W
- | Connecting Up to 20 Slaves | Connecting an External Relay to Attach Slaves
- | Connecting a Push Button Switch to Force or Prevent Sensing

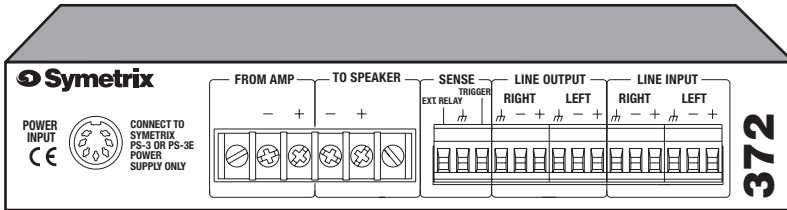

## Overview of Rear Panel Connectors and Connections

CONNECTION	CONNECTOR TYPE	WHAT IT DOES								
<b>Power Input</b>	7-pin DIN connector	Accepts power only from Symetrix PS-3 or PS-3E power supply.								
<b>FROM AMP</b>	2 terminal barrier strip	<p>Accepts signal from power amplifier. This output may be grounded or bridged. 8A maximum current rating. If your speaker load exceeds the following ratings, you will need to use an external relay (See Connecting an External Relay to Attach Slaves).</p> <p><b>MAX AMPLIFIER OUTPUT RATINGS</b></p> <table style="margin-left: 20px;"> <tr> <td>16 ohms</td> <td>400W</td> </tr> <tr> <td>70V</td> <td>300W</td> </tr> <tr> <td>8 ohms</td> <td>200W</td> </tr> <tr> <td>4 ohms</td> <td>100W</td> </tr> </table>	16 ohms	400W	70V	300W	8 ohms	200W	4 ohms	100W
16 ohms	400W									
70V	300W									
8 ohms	200W									
4 ohms	100W									
<b>TO SPEAKER</b>	2 terminal barrier strip	Delivers signal to loudspeaker system. Do not ground either of these terminals.								
<b>SENSE</b>	<b>EXT RELAY</b> Euroblock terminals	Open-collector drive signal for external sense relay. Can power amplifiers larger than 200W at 8 ohms (See Connecting an External Relay to Attach Slaves). Controls as many as 20 slave 372 units directly from the EXT RELAY output of the master 372. This output can also drive the TRIGGER input.								
	<b>GROUND</b> Euroblock terminals	Ground return for external relay and trigger.								
	<b>TRIGGER</b> Euroblock terminals	Active low input forces sense event. Can force or prevent a sense event manually (See Connecting a Push Button Switch to Force or Prevent Sensing). Is internally pulled to the 5V supply by way of a 20k ohm resistor. From this connection attach slave 372 units to the master 372.								



Symetrix 372 SPL Computer User's Guide  
**Making Hardware Connections**



- | **Overview of Rear Panel Connectors and Connections** | Sensing Speaker Considerations
- | 372 Basic Connection | Connecting an External Relay to Drive Amplifiers Larger than 200W
- | Connecting Up to 20 Slaves | Connecting an External Relay to Attach Slaves
- | Connecting a Push Button Switch to Force or Prevent Sensing

CONNECTION	CONNECTOR TYPE	WHAT IT DOES
<b>LINE OUTPUT</b>	Euroblock terminals	<p>These connectors deliver a differential balanced output at 200 ohm source impedance. For unbalanced use, use the positive line output terminals and the ground terminals. Ignore (float) the minus output terminals.</p> <p>The output stage is a pair of opamps, with the plus and minus output terminals at 180° antiphase with each other. It emulates a grounded center-tap transformer. The series build-out resistors are 100 ohms in each leg.</p> <p>For wiring diagram, see the section Input and Output Connector Wiring.</p>
<b>LINE INPUT</b>	Euroblock terminals	<p>Balanced input for the 372. 20k ohm balanced bridging. For unbalanced sources, connect the minus input terminal to the source ground at the source.</p> <p><i>Note</i> <i>Feeding unbalanced inputs directly from balanced outputs is not recommended due to the possibility of ground loops. You may want to use the Symetrix 303 isolation transformer to break the ground connection and eliminate the ground loop.</i></p> <p><i>With unbalanced sources, it is preferable to carry the low side of the input all the way back to the ground connection of the source.</i></p> <p>For wiring diagram, see the section Input and Output Connector Wiring.</p>

# Making Hardware Connections



| Overview of Rear Panel Connectors and Connections | **Sensing Speaker Considerations**  
| 372 Basic Connection | Connecting an External Relay to Drive Amplifiers Larger than 200W  
| Connecting Up to 20 Slaves | Connecting an External Relay to Attach Slaves  
| Connecting a Push Button Switch to Force or Prevent Sensing

## Sensing Speaker Considerations

### Speaker Location

If a sensing speaker is located near a localized noise source that is not typical for the ambient noise level of the controlled zone, the 372 determines that the zone is noisier than it really is. For example, the noise from a large machine of some sort, or maybe a kids play area, or a video game. The solution is to have the speakers that are near the noise source driven directly from the amplifier so that they are not used for sensing.

### 70V Systems

In a 70V system, the signal level returned by the speakers when the 372 is sensing is higher, because of the step-up action of the line transformers. With highly-efficient speakers, this may present the problem of overloading the sense input of the 372. Use the **Listen** mode to check the level of the signal while the 372 senses. You may need to lower the gain position of the AMBIENT SENSE GAIN switch. More information about the gain setting is found in **Listen** under the section System Setup.

A common practice in 70V systems is to provide autotransformers or L-pads after the line transformer to allow local volume control. These controls should not be used with the 372. Allowing any sort of signal level control after the 372 invalidates your calibration settings. If you must provide a local control, then ensure that the controlled zone is a minor part of the entire system. In this controlled zone, volume level will not be ideal and sensing should not be used.

Also, it is imperative that every speaker and transformer in the system operate in-phase.

### 4, 8, and 16 Ohm Systems

In these speaker impedance systems, the signal levels returned to the 372 are low. Use the **Listen** mode to check the level of the signal while the 372 senses. You may need to select the high gain position of the AMBIENT SENSE GAIN switch.

# Making Hardware Connections



- | Overview of Rear Panel Connectors and Connections
- | Sensing Speaker Considerations
- | **372 Basic Connection** | Connecting an External Relay to Drive Amplifiers Larger than 200W
- | Connecting Up to 20 Slaves | Connecting an External Relay to Attach Slaves
- | Connecting a Push Button Switch to Force or Prevent Sensing

## 372 Basic Connection

### Signal I/O Connections

These connectors are designed for use with bare wire. Do not tin strand wires before inserting them into the connectors.

If using unbalanced connections, see wiring diagram in the section Input and Output Connector Wiring.

#### Note

*Feeding unbalanced inputs directly from balanced outputs is not recommended due to the possibility of ground loops. An option is to use the Symetrix 303 isolation transformer to break the ground connection and eliminate the ground loop.*

- 1 Connect your line-level source to the rear-panel input connectors.

These connectors may be driven from a balanced or unbalanced source. When using an unbalanced source, connect the output minus terminal to ground either at the source or at the 372.

- 2 Connect the outputs as required.

These connectors deliver a differential balanced output signal. For unbalanced use, use the positive line output terminals and the ground terminals. Ignore (float) the minus output terminals.

### Amplifier and Speaker Connections

- 3 Connect your amplifier and speakers to the barrier strip connectors.

The speaker and amplifier connections are earth-free (floating).

The 372 treats the speaker connections after its sensing relay as if they were a balanced line. Do not ground either side of the speaker line. It is OK if the one side of the amplifier output is grounded.

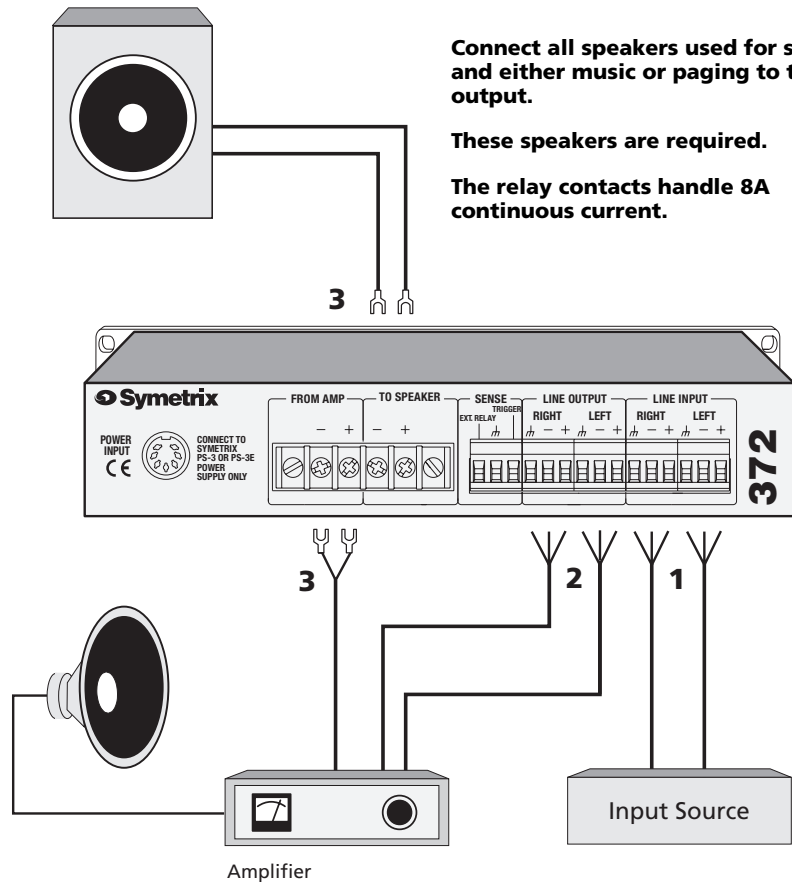

**Connect all speakers used for sensing and either music or paging to this output.**

**These speakers are required.**

**The relay contacts handle 8A continuous current.**

**Connect all speakers that do not sense to the amplifier output.**

**Use these speakers for only music or paging.**

**These speakers are optional.**

# Symetrix 372 SPL Computer User's Guide

## Making Hardware Connections



| Overview of Rear Panel Connectors and Connections | Sensing Speaker Considerations  
 | 372 Basic Connection | **Connecting an External Relay to Drive Amplifiers**  
**Larger than 200W** | Connecting Up to 20 Slaves | Connecting an External Relay to Attach Slaves  
 | Connecting a Push Button Switch to Force or Prevent Sensing

### Connecting an External Relay to Drive Amplifiers Larger than 200W

When controlling amplifiers larger than 200W, you must use an external DPDT relay. The internal relay of the 372 cannot handle more than 8A of load current.

#### RECOMMENDED MAXIMUM AMPLIFIER WATTAGES

400W	16 ohms
300W	70V
200W	8 ohms
100W	4 ohms

You must supply power for the relay and the relay must have a back-biased 1N4002 diode connected across its coil to absorb the back EMF from the relay coil. The transistor has a 60V VCE rating (MPSA 06).

The 24V version of the Potter & Brumfield PRD11DGO works well. Its DPDT contacts are rated at 30A.

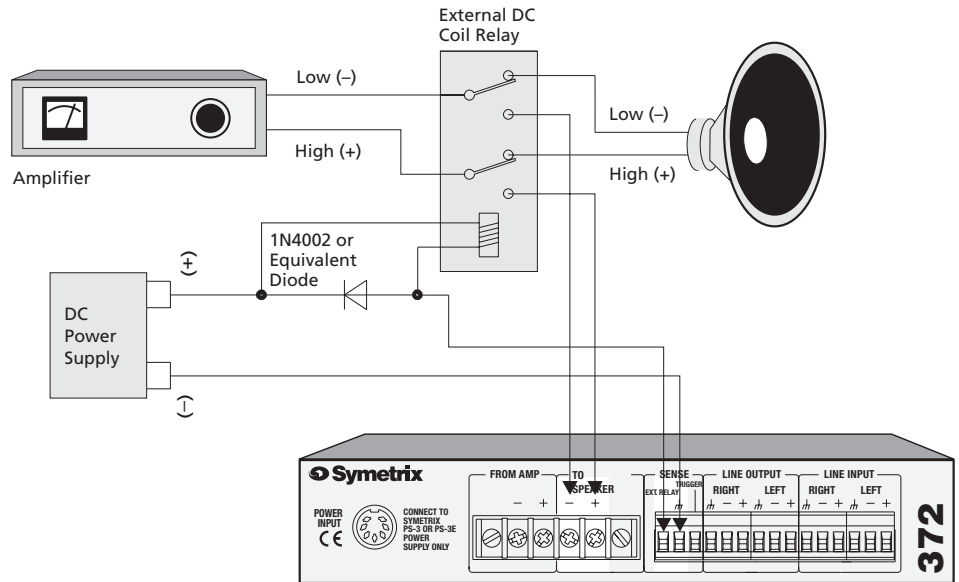

# Symetrix 372 SPL Computer User's Guide

## Making Hardware Connections



- | Overview of Rear Panel Connectors and Connections
- | Sensing Speaker Considerations
- | 372 Basic Connection
- | Connecting an External Relay to Drive Amplifiers Larger than 200W
- | **Connecting Up to 20 Slaves**
- | Connecting an External Relay to Attach Slaves
- | Connecting a Push Button Switch to Force or Prevent Sensing

### Connecting Up to 20 Slaves

A master 372 can direct any number of slave 372 units to take an ambient sample. You can parallel slave 372 units directly together from the master unit to enable you to sense at the same time in adjacent or multiple installation zones. If the slave 372 units are in remote locations, use an external relay to connect the slaves to the master unit (see Connecting an External Relay to Attach Slaves).

As many as 20 slave 372 units may be controlled directly from the EXT RELAY output of the master 372.

#### MAXIMUM CABLE LENGTH

Depends upon the difference in ground potential (if any) between the individual units.

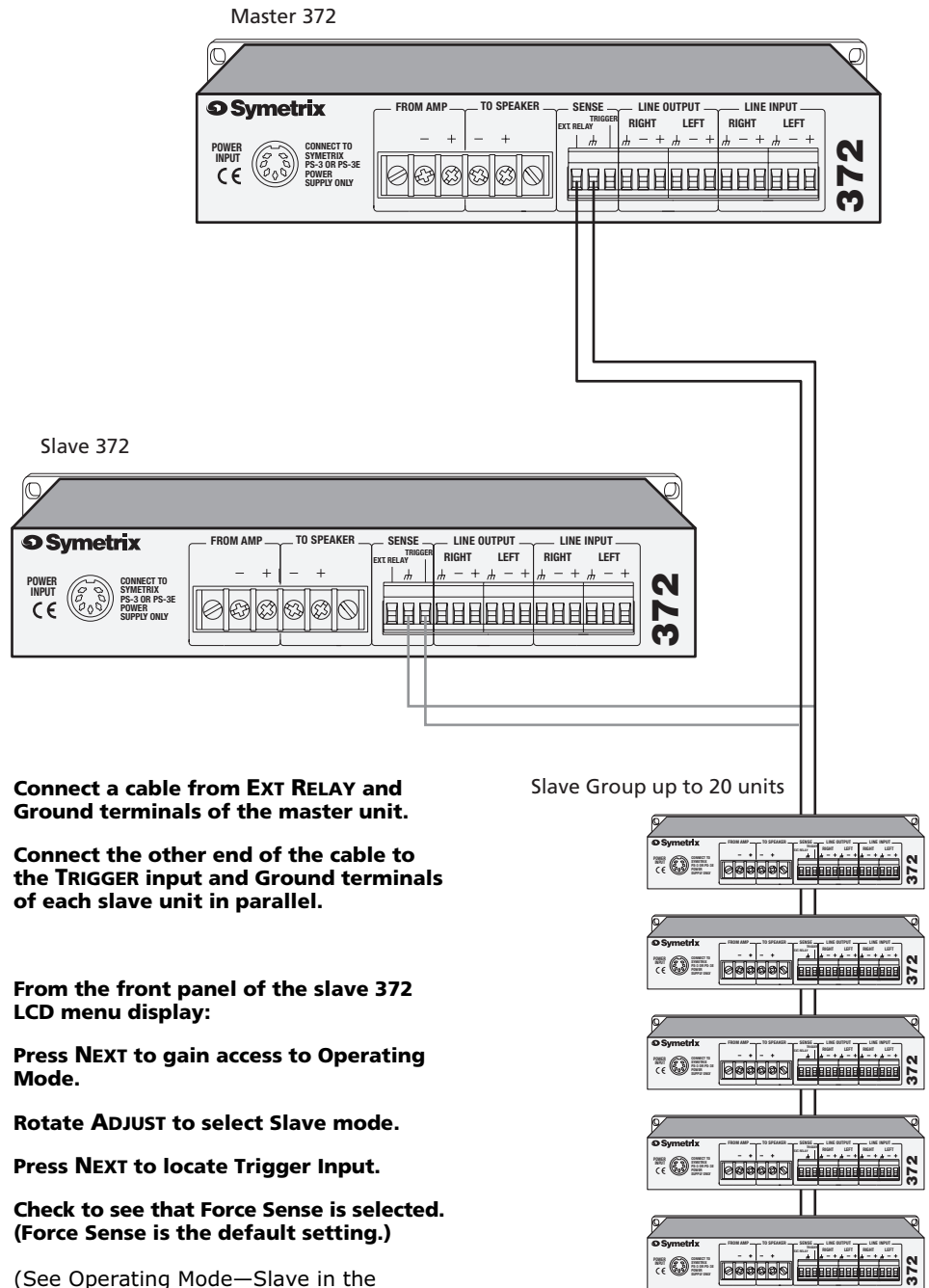

# Symetrix 372 SPL Computer User's Guide

## Making Hardware Connections



- | Overview of Rear Panel Connectors and Connections
- | Sensing Speaker Considerations
- | 372 Basic Connection
- | Connecting an External Relay to Drive Amplifiers Larger than 200W
- | Connecting Up to 20 Slaves
- | **Connecting an External Relay to Attach Slaves**
- | Connecting a Push Button Switch to Force or Prevent Sensing

### Connecting an External Relay to Attach Slaves

#### Use an External Relay:

To connect more than 20 slave 372 units together from the master unit to sense at the same time in adjacent or multiple installation zones.

—or—

To connect slave 372 units in remote locations from the master unit.

If some of the slave units are a long distance away from the master, a direct connection might give rise to ground loop problems. To avoid this, use an external relay to isolate the connection between the master and the distant slaves.

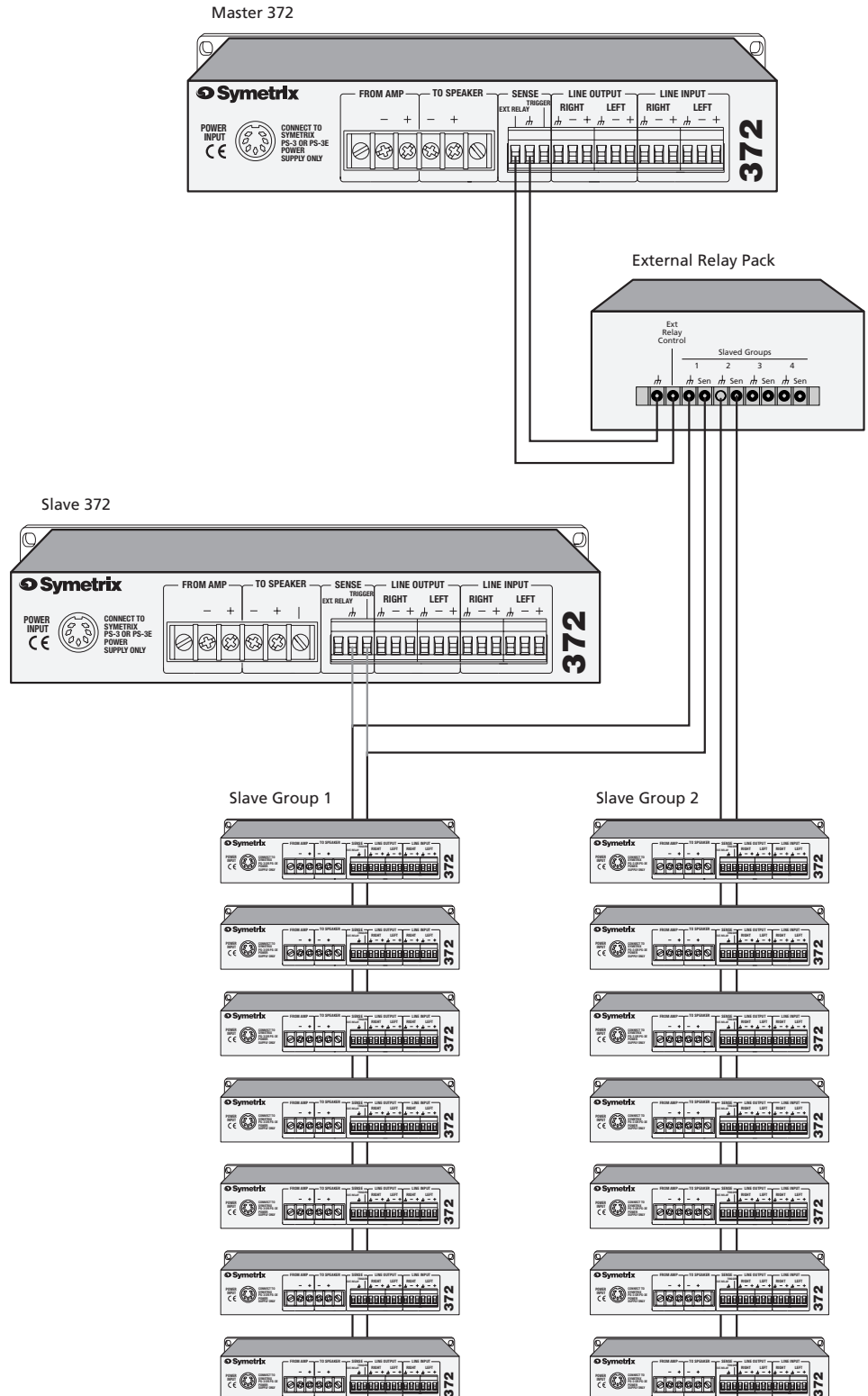

**Connect a cable from EXT RELAY and Ground terminals of the master unit to the External Relay control and Ground terminals on the rear panel of the external relay.**

**Connect cables from the external relay outputs to the TRIGGER and Ground terminals of each slave unit in parallel.**

**From the front panel of the slave 372 LCD menu display:**

**Press NEXT to gain access to Operating Mode.**

**Rotate ADJUST to select Slave mode.**

**Press NEXT to locate Trigger Input.**

**Check to see that Force Sense is selected. (Force Sense is the default setting.)**

(See Description of Menu Features, Operating Mode—Slave in the section System Setup for additional information)

# Making Hardware Connections



- | Overview of Rear Panel Connectors and Connections
- | Sensing Speaker Considerations
- | 372 Basic Connection
- | Connecting an External Relay to Drive Amplifiers Larger than 200W
- | Connecting Up to 20 Slaves
- | Connecting an External Relay to Attach Slaves
- | **Connecting a Push Button Switch to Force or Prevent Sensing**

## Connecting a Push Button Switch to Force or Prevent Sensing

You can manually prevent sensing or manually control sensing by using a push button switch.

In conjunction with the TRIGGER connection on the rear panel, you must also choose **Trigger Input** in the LCD menu display to enable either a force sense or prevent sense event.

**Prevent Sense** is useful in the **Music** mode during voice announcements, in conjunction with an external contact closure. In Music mode the 372 has no other way to know if an announcement is happening.

An example of an external contact closure might be a spare set of contacts on a push-to-talk microphone. The 372 is prevented from sensing the ambient room level whenever these contacts are pressed closed. Otherwise, a timed sense event might "cut off" the announcer when he/she is speaking.

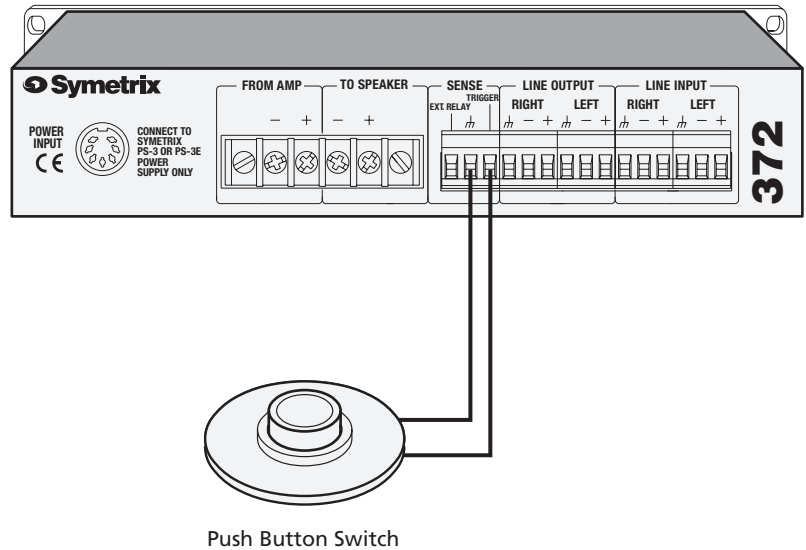

### To Force a Sense Event

Connect a momentary contact closure between the TRIGGER and Ground terminals.

From the front panel of the slave 372 LCD menu display:

Press **NEXT** to gain access to Trigger Input.

Check to see that **Force Sense** is selected. (Force Sense is the default setting.)

(For additional information, see in the section System Setup, Description of Menu Features—Trigger Input)

### To Prevent a Sense Event

Connect a normally-open set of switch or relay contacts between the TRIGGER and Ground terminals.

From the front panel of the slave 372 LCD menu display:

Press **NEXT** to gain access to Trigger Input.

Rotate **ADJUST** to select Prevent Sense.

(For additional information, see in the section System Setup, Description of Menu Features—Trigger Input)

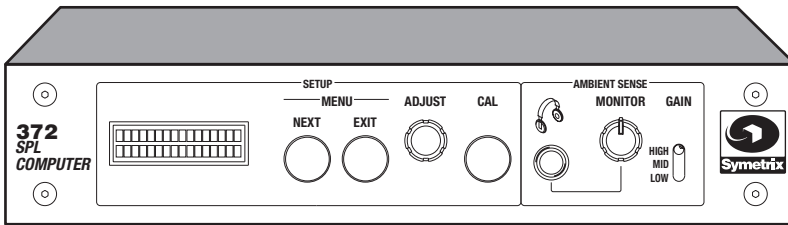

## Overview of Front Panel

CONTROL	CONTROL TYPE	WHAT IT DOES
<b>SETUP</b>	LCD menu display	Two line display shows levels and settings of selected menu feature.
	<b>NEXT</b>	From normal operation, the first press enters the setup mode; subsequent presses step through the setup process.
	<b>EXIT</b>	Exits the setup mode. The unit reverts to normal operation.
	<b>ADJUST</b>	Rotary control used in setup mode for parameter setting.
	<b>CAL</b>	Press to have the 372 read the current ambient level and equate this reading to 0 db (Unity) gain. Displays the relative ambient reading which it considers as normal. CAL is only active in normal operating mode and when setup is unlocked.
<b>AMBIENT SENSE</b>	Headphone jack	1/4 inch TRS jack suitable for headphone impedances of 60 ohms or higher, stereo or mono. Enables listening to the output of the sensing system when 372 is in <b>Listen</b> mode. Helpful for troubleshooting or for figuring out what the 372 is listening to. For more information, see Description of Menu Features, Operating Mode—Listen.
	<b>MONITOR</b>	Adjusts the volume level at the headphone jack.
	<b>GAIN</b>	3-position switch adjusts the sensitivity of the sensing circuitry to accommodate different conditions. Set the gain level while in the <b>Listen</b> mode. For more information, see Description of Menu Features, Operating Mode—Listen.
	<b>Note</b>	<b>Once the 372 has been set up, do not change the AMBIENT SENSE GAIN position.</b>





## How System Setup Works

Use the two push buttons, NEXT and EXIT, with the parameter adjustment knob, ADJUST, to gain access to menu setup options in the LCD display.

- 1 Press NEXT to enter the setup mode.
- 2 Rotate ADJUST to select a specific value or choice.
- 3 Press NEXT again to gain access to another menu option. Subsequent presses of Next change menu options.
- 4 Press EXIT to end the setup process, save any changes made, and return the unit to normal operation.  
—or—  
Allow 30 seconds of inactivity, after which the unit returns to normal operation. (Does not apply while using the **Listen** feature.)
- 5 After setup is complete, calibrate the unit (See the section Calibrating the 372).

REQUIRED	RECOMMENDED	OPTIONAL	MENU FEATURE IN LCD DISPLAY
●			Choose <b>Operating Mode*</b>
		◆	View calibration <b>Status</b>
		◆	Collect <b>History</b> of highest and lowest SPLs
●			Set gain level in <b>Listen</b>
●			<b>Set MIN limit</b> (gain)
●			<b>Set MAX limit</b> (gain)
	■		Specify <b>Averaging Time</b>
	■		Specify <b>Gain: Sense Ratio</b>
●			Set <b>Gap Threshold</b>
●			Specify time for <b>Force Sense Time</b>
		◆	Enable <b>AGC</b>
		◆	Specify type of <b>Trigger Input</b>
	■		Lock or <b>Unlock Setup</b>

*\*Bold face indicates menu name in LCD display*



## Description of Menu Features

PRESS NEXT TO SELECT MENU FEATURE	ROTATE ADJUST TO SELECT VALUE OR CHOICE	DESCRIPTION
● <b>Operating Mode</b>	<b>Music</b>	<p><b>This mode considers everything as if it were music, even though it may contain a mix of music and announcement audio.</b></p> <p>Varies the gain of this program channel to match the ambient noise level.</p> <p><i>How Sampling Works</i>—Takes SPL measurements during silent portions in the program material. If the 372 doesn't find gaps, then it forces a sense period (samples for about 0.75 seconds) after which, it restores the program channel signal.</p> <p><i>How You Can Control Sampling</i>—You can force a sense period manually and select the time of the forced event. See <b>Trigger Input</b> in this section to enable this feature.</p> <p>Can also perform simple <b>AGC</b> on the input signal to improve the consistency of the output level. See AGC in this section to enable this feature.</p>
	<b>Page</b>	<p><b>Select this mode if you are doing paging or announcement audio only.</b></p> <p>Varies the gain of the program channel to match the ambient noise level.</p> <p><i>How Sampling Works</i>—The presence of audio in the program channel prevents sampling from taking place. Sampling stays "locked out" until the program channel has remained silent for at least 20 seconds. In the rare event that a page or announcement begins while sampling is taking place (samples for about 0.75 seconds), the current sense cycle/period will complete and then further sampling is prevented.</p> <p><i>How You Can Control Sampling</i>—If your application cannot tolerate paging interruptions, you can force sensing to occur after a page announcement. See <b>Force Sense Time</b> in this section to enable this feature.</p> <p>Can perform simple <b>AGC</b> on over-threshold compression on the paging signal at 3:1 ratio on signals above 0 dBu (defeatable). See AGC in this section to enable this feature.</p>

REQUIRED      RECOMMENDED      OPTIONAL





## Description of Menu Features continues

PRESS NEXT TO SELECT MENU FEATURE	ROTATE ADJUST TO SELECT VALUE OR CHOICE	DESCRIPTION
<b>Operating Mode continues</b>	<b>Slave</b>	<p><b>Select this mode if you want to designate the 372 unit as a slave. Slave units connected to a master 372 unit enable you to sense at the same time in adjacent or multiple installation zones.</b></p> <p>This mode senses only in response to an external sense command received by way of the TRIGGER input connector on the rear panel of the slave.</p> <p>As many as 20 slave 372 units may be controlled directly from the EXT RELAY output of the master 372. Connect a cable from EXT RELAY and Ground terminals of the master unit to the TRIGGER input and Ground terminals of each slave unit in parallel (See Connecting Up to 20 Slaves).</p> <p>More than 20 slave 372 units may be controlled using an external relay (See Connecting an External Relay to Attach Slaves).</p> <p>If some of the slave units are a long distance away from the master, a direct connection might give rise to ground loop problems. To avoid this, use an external relay to isolate the connection between the master and the distant slaves (See Connecting an External Relay to Attach Slaves).</p> <p>On the front panel of the slave units, press NEXT to locate <b>Trigger Input</b> in the LCD menu display. Check to see that <b>Force Sense</b> is selected. Force Sense is the default setting.</p>
	<b>History</b>	<p><b>Select this mode if you only want the 372 to collect data about the highest and lowest ambient SPL in the installation zone(s).</b></p> <p>The 372 does not perform any gain control in this mode. You can determine the start of the history period or collection of data. See <b>History</b> later in this section to reset or start the collection of the relative SPL history.</p> <p>To view the current SPL readings, see <b>Listen</b>.</p>
	<b>Bypass</b>	<p><b>Select this mode when you want to leave the 372 physically connected in the signal path, only pass the signal unaltered, and never take SPL samples.</b></p> <p>This feature is useful if you encounter setup problems in an installation. You can temporarily disable the 372 until you have the time to correct the problem. Or when the action of the 372 is temporarily unwanted, for example, when an unusual event is taking place.</p> <p>You can view your control settings in this mode. Any changes you make to your control settings in this mode, will not take effect.</p> <p>The gain is always held at unity (0 dB) in Bypass mode. Bypass mode is not a hard-wire bypass.</p>

REQUIRED      RECOMMENDED      OPTIONAL





## Description of Menu Features continues

PRESS NEXT TO SELECT MENU FEATURE	ROTATE ADJUST TO SELECT VALUE OR CHOICE	DESCRIPTION
◆ <b>Status</b>		<b>Displays the current calibration status of the 372.</b>
	<b>Cal Level</b>	Ambient signal level measured at the last sense period.
	<b>Min Level</b>	Minimum gain that the 372 is permitted to have.
	<b>Max Level</b>	Maximum gain that the 372 is permitted to have.
◆ <b>History</b>	<b>Reset to Zero</b>	<p><b>Displays numeric readings of the highest and lowest SPLs from whenever the 372 unit was calibrated or from when the setting was last reset.</b></p> <p>Resetting the 372 to <b>Zero</b> starts a new history period, where the 372 begins to collect the highest and lowest relative SPL readings.</p>
	● <b>Listen</b>	<p><b>Select Listen in order to set the gain level.</b></p> <p>There is a 2 second delay prior to entering this function. The 372 switches the system into Listen mode, silencing the speakers and using them as microphones to read the ambient sound level.</p> <p>The relative SPL reading then displays in numeric form and, also, as a bargraph.</p> <p>Adjust the AMBIENT SENSE GAIN switch on the front panel until the indicated level is higher than at least -40 dB, but no more than 0 dB. This setting range allows the 372 to have enough valid information to control the system gain.</p> <p><b>Note</b> <i>Once the 372 has been set up, the AMBIENT SENSE GAIN switch position should never be changed.</i></p> <p>In this mode, you can plug in headphones to listen to the ambient sound the 372 reads. Adjust the volume of the headphones by rotating MONITOR.</p> <p>The headphone is a helpful troubleshooting tool for identifying noise sources that may be misdirecting the 372 or hum and noise picked up in the speaker wiring that may be causing sense errors.</p>

REQUIRED      RECOMMENDED      OPTIONAL





## Description of Menu Features continues

PRESS NEXT TO SELECT MENU FEATURE	ROTATE ADJUST TO SELECT VALUE OR CHOICE	DESCRIPTION
● <b>Set MIN Limit</b>	<b>Select value</b>	<p><b>To adjust the lowest gain setting that the 372 uses.</b></p> <p>This ensures a known minimum level from the sound system, even if the ambient drops to dead silence.</p>
● <b>Set MAX Limit</b>	<b>Select value</b>	<p><b>To adjust the highest gain setting that the 372 uses.</b></p> <p>This ensures that the sound system stays out of clipping even if the ambient level exceeds your wildest expectations.</p>
■ <b>Averaging Time</b>	<b>1, 2, 4, or 8</b>	<p><b>To average together the number of samples to make a gain change.</b></p> <p>Select the number of samples you want the 372 to use. Longer running averages make the system respond more to the trend of the ambient level rather than the most recent sample.</p>
■ <b>Gain: Sense Ratio</b>	<b>0.5:1, 1:1, 1.5:1, or 2:1</b>	<p><b>Refers to the change in gain of the 372 versus the change in the ambient.</b></p> <p><b>0.5:1</b> changes gain 0.5 dB for every dB change in the ambient. This makes the sound system louder in response to increases in the ambient, but never tries to out-shout the crowd.</p> <p><b>1:1</b> matches gain changes to the ambient noise level.</p> <p><b>1.5:1</b> changes gain 1.5 dB for every 1 dB increase in the ambient noise level.</p> <p><b>2:1</b> changes gain 2 dB for every 1 dB increase in the ambient noise level.</p> <p>At high ambient levels, the 372 can easily out-shout the crowd if the control settings allow it. To limit the 372's ability to out-shout the crowd, pick a lower maximum gain in <b>Set MAX Limit</b>.</p> <p>At lower ambient levels, the 372 might let the sound system get lost in the ambient. To avoid this, choose a higher (closer to 0 dB) minimum gain in <b>Set MIN Limit</b>.</p>

REQUIRED      RECOMMENDED      OPTIONAL





## Description of Menu Features continues

PRESS NEXT TO SELECT MENU FEATURE	ROTATE ADJUST TO SELECT VALUE OR CHOICE	DESCRIPTION
● <b>Gap Threshold</b>	<b>Select value</b>	<p><b>To set the minimum signal level needed for the 372 to not detect silence in the program channel.</b></p> <p>In <b>Music</b> mode, the 372 senses anytime that the music program level falls below the <b>Gap Threshold</b> setting. If there are no gaps in the program, then the 372 senses at the interval set by the <b>Force Sense Time</b>, which ranges from never to 30 minutes. See Force Sense Time.</p> <p>In <b>Page</b> mode, the 372 senses when directed by the <b>Force Sense Time</b> or by an external trigger source. Use <b>Gap Threshold</b> to prevent sensing activity during paging. If a page is in progress, the 372 will not interrupt it for sensing.</p>
● <b>Force Sense Time</b>	<b>Never, 1, 3, 5, 10, 20, or 30 minutes</b>	<p><b>To force a sensing period when the program material is too dense to contain sufficient gaps for silence sensing.</b></p> <p>Selections in <b>Music</b> mode.</p>
	<b>Sense After Page, 1, 3, 5, 10, 20 or 30 minutes</b>	<p>Selections in <b>Page</b> mode.</p> <p>Choose <b>Sense After Page</b> in situations where paging is frequent and uninterruptible. This selection triggers a sense period about 20 seconds after the paging signal level falls below the <b>Gap Threshold</b> setting.</p> <p>You can also force a sense period manually by using an external trigger source or contact closure connected to TRIGGER on the rear panel (See Connecting a Push Button Switch to Force or Prevent a Sense Event).</p>
◆ <b>AGC</b>	<b>Enable or Disable</b>	<p><b>Performs simple AGC on the input signal(s).</b></p> <p>In <b>Music</b> mode, this action consists of low-ratio expansion for signal levels below 0 dBu and moderate-ratio compression for signal levels above 0 dBu. This can be useful in reducing the dynamic range of signal sources such as CD players.</p> <p>In <b>Page</b> mode, this action performs over-threshold compression at 3:1 ratio for signals over 0 dBu as referred to the input. This can be useful in keeping the sound system out of clipping, or for reducing the surprise factor caused by a loud talker.</p>

REQUIRED      RECOMMENDED      OPTIONAL





## Description of Menu Features continues

PRESS NEXT TO SELECT MENU FEATURE	ROTATE ADJUST TO SELECT VALUE OR CHOICE	DESCRIPTION
◆ <b>Trigger Input</b>		<p><b>You can manually prevent sensing or manually control sensing by using this feature in conjunction with the hardware connection, TRIGGER, on the rear panel.</b></p>
	<b>Force Sense</b>	<p>Forces a sense period when the program material is too dense to contain sufficient gaps for silence sensing. Operates independently of <b>Gap Threshold</b>. On the rear panel, connect a momentary contact closure between the TRIGGER and Ground terminals to initiate an ambient level sense event (See Connecting a Push Button Switch to Force or Prevent Sensing).</p>
		—or—
	<b>Prevent Sense</b>	<p>Enables slave 372s connected to a master 372 to sense at the same time in adjacent or multiple zones (See <b>Slave</b> mode in this section and in the section Making Hardware Connections, see Connecting Up to 20 Slaves).</p> <p>Useful in <b>Music</b> mode during voice announcements, in conjunction with an external contact closure. In Music mode the 372 has no other way to know if an announcement is happening.</p> <p>Connect to the TRIGGER input a normally-open set of switch or relay contacts between the TRIGGER and Ground terminals on the rear panel. An example of this might be a spare set of contacts on a push-to-talk microphone. Whenever these contacts are pressed closed, the 372 is prevented from sensing the ambient room level. Otherwise, a timed sense event might “cut off” the announcer when he/she is speaking (See Connecting a Push Button Switch to Force or Prevent Sensing).</p>
	<b>Not Used</b>	Disables the trigger pin.
■ <b>Setup Unlocked</b>	<b>Unlock or lock</b>	<p><b>Choose to protect front panel LCD menu settings from being altered.</b></p> <p>To lock, press and hold CAL while rotating ADJUST. Once it's locked, pressing NEXT shows the current settings. Any attempt to alter settings results in the display of the message “Setup is Locked.”</p> <p>To unlock, press NEXT until the display reads “Setup Is Locked.” Press and hold CAL while rotating ADJUST. The front panel is now unlocked.</p>

REQUIRED      RECOMMENDED      OPTIONAL





## To calibrate the 372

- 1** Choose a time when the ambient noise in the area being controlled is at a typical level.
- 2** On the front panel, press CAL.  
The 372 reads the current ambient level and equates this reading to 0 dB (Unity) gain.
- 3** When calibration is finished, the 372 displays the relative ambient SPL reading which it considers as "Normal."

Whenever the SPL of the environment is at this level, the program channel of the 372 will be at 0 dB (Unity) gain. As the ambient SPL becomes less, the 372 lowers its gain. Conversely, when the SPL increases, the gain of the 372 increases.

Only perform calibration when the setup for the 372 is unlocked (See **Setup Unlocked** in section System Setup). Pressing CAL when the setup is locked causes the 372 to report the most current relative calibration level. No settings are altered.



## Conditions Under Which the 372 Will Not Sense



Because the 372 uses the speakers of a sound system as sensing microphones, the sound system is briefly disabled every time a reading is taken. To keep these interruptions to a minimum, the 372 follows several rules to prevent sensing under specific conditions.

### The 372 Will Not Take Samples When:

- 1** In **Music** mode, whenever the program audio is above the **Gap Threshold** level. (You can override the Gap Threshold level by manually controlling sensing. See in Description of Menu Features, **Trigger Input—Force Sense** in the section System Setup.)
- 2** In **Page** mode, whenever the program audio is above the **Gap Threshold** level.
- 3** In **Page** mode, for about 20 seconds after any program signal above the **Gap Threshold** level has disappeared.
- 4** In any mode, for about 4 seconds after the last sample was taken.
- 5** In any mode, as long as the TRIGGER input is grounded, if **Prevent Sense** has been selected for **Trigger Input** in the LCD menu display.
- 6** In **Bypass** mode.

# Signal Flow Diagram

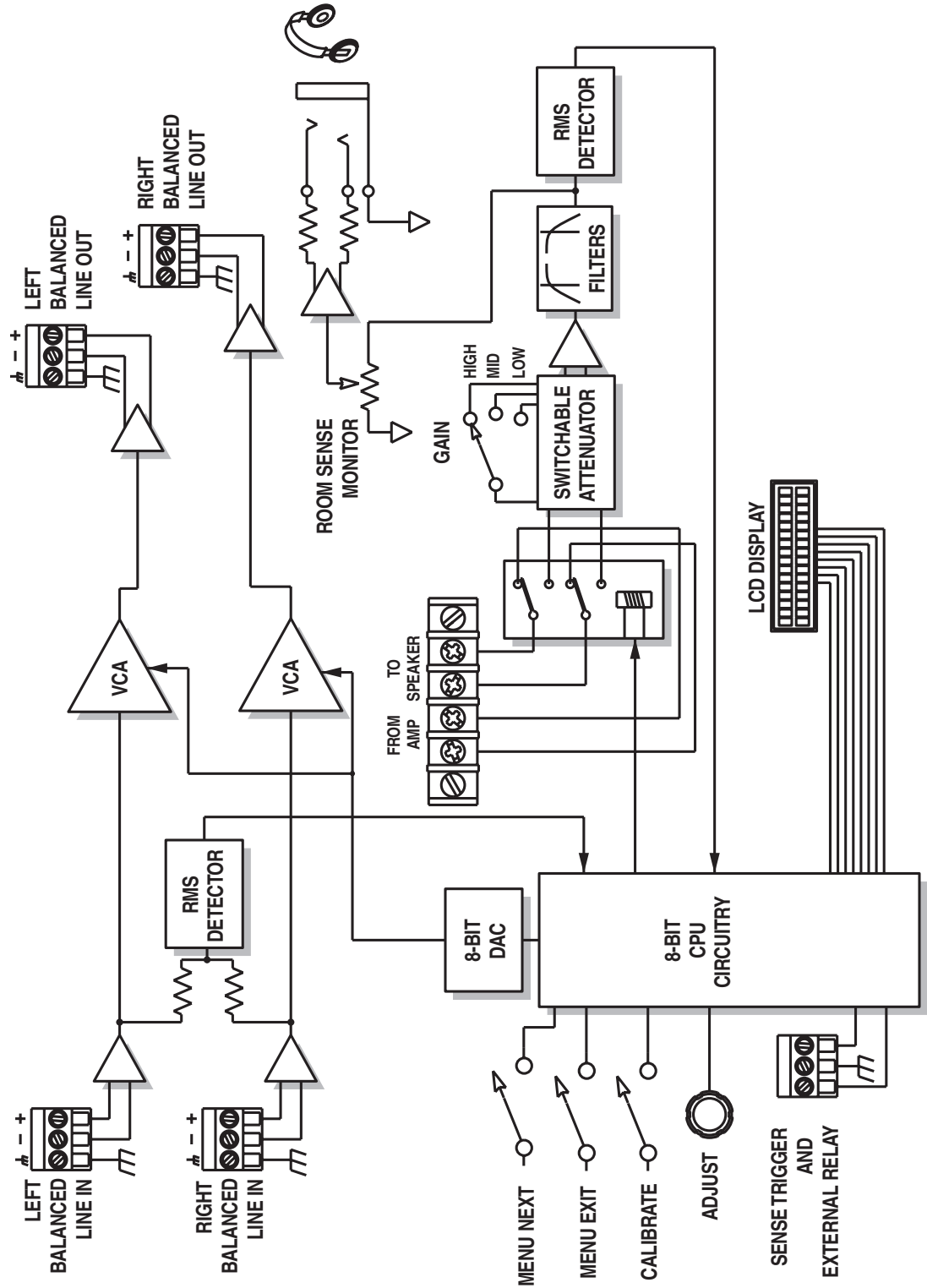



METHOD	CONNECTOR	CHANNEL	
<b>Balanced Terminal Strip</b>			<b>Input</b>
<b>Balanced Female XLR</b> Pin 1 = Not Connected Pin 2 = High Pin 3 = Low Connector Shield = Not Connected			<b>Input</b>
<b>Balanced TRS Plug</b> Tip = High Ring = Low Sleeve = Shield			<b>Input</b>
<b>Unbalanced TS Plug</b> Tip = High Sleeve = Low + Shield			<b>Input</b>
<b>Unbalanced RCA Plug</b> Tip = High Sleeve = Low Cable Shield = Not Connected			<b>Input</b>
<b>Balanced Male XLR</b> Pin 1 = Circuit Ground Pin 2 = High Pin 3 = Low			<b>Output</b>
<b>Unbalanced TS Plug</b> Tip = High Sleeve = Shield Wire Low = Not Connected			<b>Output</b>



SYMPTOM	PROBABLE CAUSE / WHAT TO DO
<b>No output signal</b>	<p>Check cables and connections. Check to see if:</p> <ul style="list-style-type: none"> <li>Inputs are driving outputs, and outputs are driving inputs.</li> <li>There is a signal coming from the source and that it is getting to the 372.</li> <li>The signal chain after the 372 is functioning.</li> </ul> <p>Check if the LCD display is on and unit is plugged in.</p>
<b>Unit will not calibrate</b>	<p>Check that input levels are normal.</p> <p>In <b>Listen</b> mode, use headphones to hear what the 372 reads. Set position of AMBIENT SENSE GAIN switch between -40 and 0 dB.</p> <p>Check sensing speaker connections.</p>
<b>Music always plays too loud</b>	<p>Check levels in <b>Set MIN Limit</b> and/or <b>Set MAX Limit</b>.</p>
<b>Unit seems to have no effect</b>	<p>Check the ratio setting in the LCD menu display for <b>Gain: Sense Ratio</b>. At <b>0.5:1</b>, the gain changes are very subtle. Choose a larger value for more change.</p> <p>Check if level is set too low in <b>Set MAX Limit</b>.</p>
<b>Unit never senses, even during silence</b>	<p>Check if <b>Gap Threshold</b> is set too low.</p> <p>Check if <b>Bypass</b> mode or <b>Slave</b> mode is selected in <b>Operation Mode</b>. Change mode to <b>Music</b> or <b>Page</b>.</p>
<b>Unit loses the beginnings of paging messages</b>	<p><b>Gap Threshold</b> set too high. Select <b>Sense After Page</b>.</p>
<b>Unit does not accurately adjust system as ambient noise changes</b>	<p>Hum induced in speaker wiring. Check if speaker wiring is routed adjacent to AC wiring.</p> <p>In <b>Listen</b> mode, use headphones to check ambient noise level.</p> <p>Check if speaker is mounted near continuous noise source.</p> <p>Check that all speakers are operating in-phase.</p> <p><i>Note</i> The accuracy of the 372 is only as good as the quality of your speakers.</p>
<b>Unit senses during paging</b>	<p><b>Gap Threshold</b> set too high; choose a lower value.</p>
<b>Hum or buzz in output</b>	<p>Check input connector wiring.</p> <p>Check for a ground loop problem. Inspect related system equipment grounding to see that all system components are on the <b>same</b> AC ground.</p>



## SYMPTOM

## PROBABLE CAUSE

**Distortion**

Check input signal for distortion.

Check if line input signal may be too hot.

Check if page mic signal may be too hot.

Check if the sound system has sufficient power for the SPL that you are trying to attain.

If using a high setting for **Set MAX Limit**, you may be overloading the input to your amplifier; select a lower value.

Check if something else is clipping in the signal chain.

**Noise (hiss)**

Check input signal levels and level control settings.

Check gain settings on downstream equipment for presence of noise in input signal.

**No audio**

Check if the unit is plugged in.

Check if the unit is in **Listen** mode.



**Input/Output**

Maximum Input Level	+20 dBu balanced, +20 dBu unbalanced
Program Input Impedance	>20k ohms balanced, >10k ohms unbalanced
Input Common Mode Rejection	>40 dB line inputs
Maximum Output Level	+26 dBu balanced (20k ohm load) +22 dBm balanced (600 ohm load)
Output Impedance	200 ohms balanced, 100 ohms unbalanced

**Performance Data**

Program Frequency Response	20 Hz to 20 kHz, +0, -1 dB
Program Path THD+N	<.025% (+4 dBu in, +4 dBu out)
Output Gain	+20, -30 dB
Sense Channel Frequency Response	-3 db at 300 Hz and 6000 Hz 3-pole Butterworth
Sense Channel Gain	selectable unity, +20 dB, +40 dB
Additional Headphone Monitor Gain	28 dB maximum
Program Channel Output Noise	-95 dBu @ unity gain, typical

**Connections**

Program Inputs, Outputs	Euroblock
Power In	7-pin DIN
External Trigger, External Relay	Euroblock
Headphone	1/4 in. TRS, will drive mono or stereo headphones
Internal Relay	double pole, contacts rated 8A maximum

**Physical**

Size (H x W x D)	1/2 rack unit 1.75 in. x 8.5 in. x 6.5 in., 4.445 cm x 21.59 cm x 15.875 cm
Shipping Weight	4.5 lbs

**Electrical**

Power Requirements	10W maximum, Symetrix PS-3 or PS-3E only
PS-3	115V, 60 Hz AC nominal
PS-3E	230V, 50 Hz to 60 Hz AC nominal

*Note*

*In the interest of continuous product improvement, Symetrix, Inc. reserves the right to alter, change, or modify these specifications without prior notice.*



The Ambient Level Controller (ALC) shall control the output level of the sound system in response to the observed acoustical noise level within the controlled space during system operation. These measurements shall be made during silent portions of the program material. Provision shall be made to alter the noise sensing protocol to make the noise level measurement under timer or external control and to accommodate musical or paging program signals.

The ALC shall utilize the loudspeakers of a sound system as microphones to sense the ambient noise level. Provision shall be made for the user to monitor the audio signal used by the ambient sense system by using headphones. The ALC shall be capable of operating from sound systems using direct loudspeaker drive or constant voltage distribution.

The ALC shall provide user-adjustable parameters to alter the way that it responds to changes in the ambient noise level. These parameters are: minimum and maximum gain through the device, silence sensing threshold, noise sensing protocol, gain:sense ratio, program AGC or compression, and averaging time. In addition, the

ALC shall provide music or paging signal modes, bypass mode, slave mode for linking multiple units, and a history mode that collects and displays ambient noise history from the controlled space.

The ALC shall provide two independent line level balanced inputs and outputs that control two audio signals. The maximum input level shall be +20 dBu and the maximum output level shall be +26 dBu (+22 dBm into 600 ohms) balanced. The balanced input impedance shall be 20,000 ohms and the output source impedance shall be 200 ohms balanced, 100 ohms unbalanced. The gain control range shall be -30 dB to +20 dB. The frequency response shall be 20 Hz to 20 kHz +0/-1 dB with THD+N less than 0.25% at +4 dBu over the same range of frequencies. The output noise of the device shall be less than -95 dBu (20 kHz noise bandwidth, unity gain). The input and output configuration shall be active balanced.

The speaker switching relay contacts shall be rated at 8A.

Screw terminals shall be used for all connections except for the speaker connections which shall utilize a barrier-style terminal strip. In addition to the audio input/output connections, there shall be connections provided for a sense trigger input and an open-collector sense trigger output.

A front panel power indicator shall be provided. A liquid crystal display shall be provided to communicate operating parameters and setup information with the user.

The ALC shall occupy half of the width of one rack space and shall be housed in a metal enclosure. It shall use an external, safety agency approved, power supply. The Ambient Level Controller shall be the Symetrix model 372 SPL Computer.



## Important Information Regarding Your Warranty

We would like to offer you an incentive to complete our product registration form. Either fully complete and mail your product registration card or register online at [www.symetrixaudio.com](http://www.symetrixaudio.com). You will then have a total of 5 years of warranty coverage, under the terms and limitations as set forth below, without additional cost.

If you don't register your product, you will still receive one year of warranty coverage, but it only takes a minute to fill out the card or register online and we won't share your personal information with others.

Following are the terms and limitations of the Symetrix warranty.

## Warranty

Symetrix, Inc. expressly warrants to the original purchaser ("Buyer"), subject to the terms and conditions set forth below, that the Product will be free from defects in material and workmanship as a result of normal commercial use for one (1) year from the date of purchase. This warranty will be automatically extended (subject to the additional limitations set forth below) for an additional four years if the Warranty Registration is completed and returned to Symetrix (or completed online) within thirty (30) days of the date of delivery.

Symetrix's warranty obligation is limited to the repair, replacement, or refund at Symetrix's sole discretion, of the part or parts of the Product which may thus prove defective in materials or workmanship within one year from date of purchase (or five years from the date of purchase if Buyer has registered its purchase as provided above) under normal use and which our examination discloses to our satisfaction to be thus defective, provided that Buyer gives Symetrix prompt notice of its warranty claim and satisfactory proof thereof.

Symetrix will make every reasonable effort to ensure that parts are available to support the repair of our products under warranty. In the event that a product or

component part thereof becomes obsolete, unavailable or irreparable, Symetrix reserves the right to refund a prorated portion of the purchase price in full satisfaction of all warranty claims. A refund of the purchase price is prorated as follows: 100% through year one, 80% through year two, 60% through year three, 40% through year four and 20% through year five.

In order to serve you better we request that the Buyer shall, prior to shipping Product to Symetrix for warranty service, contact Symetrix and secure a Return Authorization Number that shall be included with the returned Product. This will facilitate our efforts to keep track of your Product and process your warranty repair as quickly as possible. Buyer will prepay all freight charges to ship the Product to Symetrix for warranty inspection and service. This warranty is subject to Symetrix's inspection of the Product at its facilities and, upon Symetrix's request, satisfactory proof of purchase (dated copy of original retail dealer's invoice.)

Symetrix reserves the right to effect repairs to the product with reconditioned components/parts. Products once repaired under warranty will be shipped to Buyer freight prepaid by Symetrix via United Parcel Service (surface) or any similar shipper, to any location designated by buyer within the Continental United States. At Buyer's request and expense Product will be returned via airfreight. Outside the continental United States, repaired or replaced products will be returned freight collect.

THIS WARRANTY IS EXPRESSLY IN LIEU OF ALL OTHER WARRANTIES EXPRESS OR IMPLIED, ARISING BY LAW OR OTHERWISE (INCLUDING, WITHOUT LIMITATION ANY OBLIGATIONS OF THE SELLER WITH RESPECT TO CONSEQUENTIAL DAMAGES) INCLUDING THE WARRANTIES OF MERCHANTABILITY AND FITNESS FOR USE AND OF ALL OTHER OBLIGATIONS OR LIABILITIES ON OUR PART, AND WE NEITHER ASSUME, NOR AUTHORIZE ANY OTHER PERSON TO ASSUME FOR US, ANY OTHER LIABILITY IN CONNECTION WITH THE SALE OF THE PRODUCT. THIS WARRANTY SHALL NOT APPLY TO THIS PRODUCT OR ANY PART THERE OF WHICH HAS BEEN SUBJECT TO ACCIDENT, NEGLIGENCE, ALTERATION, ABUSE, OR

MISUSE. WE MAKE NO WARRANTY WHATSOEVER IN RESPECT TO ACCESSORIES OR PARTS NOT SUPPLIED BY US. THE TERM "ORIGINAL PURCHASER," AS USED IN THIS WARRANTY SHALL BE DEEMED TO MEAN THAT PERSON OR COMPANY THAT ORIGINALLY PURCHASED THE PRODUCT.

This Symetrix product has been designed and manufactured for use in professional and studio audio systems and is not intended for other usage. This warranty only applies to Buyers using the Product in professional and studio audio systems. With respect to others, including but not limited to consumers for personal, family, or household use, **Symetrix expressly disclaims all warranties, including but not limited to warranties of merchantability and fitness for a particular purpose and the express warranties as otherwise provided herein.**

Symetrix reserves the right to modify the design or make additions to, or improvements to, its product lines without making similar upgrades to Product purchased by Buyer. Symetrix does not authorize any third party, including any dealer or sales representative, to assume any liability, effect any repairs or modifications to the Product, or make any additional warranties or representation regarding the Product or Product information on behalf of Symetrix.

Symetrix's total liability on any claim, whether in contract, tort (including negligence) or otherwise arising out of, connected with, or resulting from the manufacture, sale, delivery, resale, repair, replacement or use of Product will not exceed the purchase price of the Product or any part thereof which gives rise to the claim. In no event will Symetrix be liable for any incidental or consequential damages including but not limited to damage for lost revenue, cost of capital, claims of customers for service interruptions or failure to supply, and costs and expenses incurred in connection with labor, overhead, transportation, installation or removal of products or substitute facilities or supply houses as a result of Product failure.

This limited warranty gives Buyer certain rights. Buyer may have additional rights under applicable law.





## Where to Get Service

### If outside of the USA

If you have determined that your 372 requires repair services and you live outside of the United States, please contact your local Symetrix dealer or distributor for instructions on how to obtain service.

### If inside the USA

Symetrix will perform in-warranty or out-of-warranty service on any product it has manufactured for a period of five years from date of manufacture. If you reside in the USA, then proceed as follows:

## In-Warranty Repairs

Repairs made in-warranty will cost you only one-way freight charges. We'll prepay the return (surface) freight. Of course, if the repair is due to operator error, parts and labor will be charged. If there are charges for the repair costs, you will pay for the return freight. All charges will be COD unless you have made other arrangements (prepaid, Visa, or Mastercard). For more information see the section Warranty.

## Out-of-Warranty Repairs

If the warranty period has passed, you'll be billed for all necessary parts, labor, packaging materials, and freight charges.

## To Get Your 372 Unit Repaired (US customers only)

- 1 Call Customer Service Department for a return authorization (RA) number.  
**(888) 349-3222 or (425) 787-3222**, Monday through Friday,  
6:00 am – 4:30 pm Pacific Time.  
Have your serial number ready to give to the customer service representative.
- 2 Pack the unit in its original packaging materials.
- 3 Include your name, address, daytime telephone number, and a brief statement of the problem.
- 4 Write the RA number on the outside of the box.
- 5 Ship the unit to Symetrix, freight prepaid.  
**We do *not* accept freight collect shipments.**

**Symetrix, Inc.**  
**14926 35th Ave West**  
**Lynnwood WA 98037**

## If You Don't Have Factory Packaging Materials

If you send us your product in substandard packaging, we will charge you for factory shipping materials. If you don't have the factory packaging materials, do the following:

- 1 Select an oversized carton.
- 2 Wrap the unit in a plastic bag, and surround it with bubble-wrap.
- 3 Pack the box full of Styrofoam peanuts. Be sure there is enough clearance in the carton to protect the rack ears.

We will return the unit in Symetrix packaging.



We, Symetrix, Inc.

14926 35th Avenue West, Lynnwood, Washington USA

declare under our sole responsibility that the product:

**372 SPL Computer**

to which this declaration relates, is in conformity with the following standards:

EN 55103-1

Electromagnetic Compatibility—Generic Emission Standard  
Part 1: Residential, Commercial, and Light Industry

EN 55103-2

Electromagnetic Compatibility—Product Family Standard for Audio, Video, and  
Entertainment Lighting Control Apparatus for Professional Use  
Part 2: Immunity

**PS-3E** power supply complies with this code:

EN 60065

Safety Requirements for Mains Operated Electronic and Related Apparatus for  
Household and Similar General Use

The technical construction file is maintained at:

Symetrix, Inc.

14926 35th Avenue West  
Lynnwood, WA 98037-2303  
USA

The authorized representative located within the European Community is:

**World Marketing Associates**

P.O. Box 100

St. Austell, Cornwall, PL26 6YU, UK

Date of issue: June 30, 2000

Place of issue: Lynnwood, Washington USA

Authorized signature:

Dane Butcher, President



301	Low Distortion Compressor/Limiter
302	Dual Microphone Preamplifier
303	Interface Amplifier
304	Headphone Amplifier
305	Distribution Amplifier (1x4)
306	Preamp/Ducker
307	Dual Isolation Transformer
308	VCA Volume Control/Loudness EQ
372	SPL Computer
402	Dual Output Delay
420	Stereo Power Amplifier
421M	AGC-Leveler
422	Stereo AGC-Leveler
440	Foreground Audio Controller
450	Dual Zone Priority Mixer
501	Peak-RMS Compressor/Limiter
501-01	Peak-RMS Compressor/Limiter
506E	Headphone Amplifier
527E	Voice Processor
528E	Voice Processor
531E	Graphic Equalizer
532E	Graphic Equalizer
533E	Graphic Equalizer
551E	5-Band Parametric EQ
552E	Dual 5-Band Parametric EQ
562E	Windowing Expander/Gate
565E	Dual Compressor/Limiter/Expander
571	SPL Computer
571S	SPL Computer Slave
572	SPL Computer
581E	Distribution Amplifier (4x4)
606	Delay F/x Machine
610	Broadcast Audio Delay
628	Digital Voice Processor
9022	2x2 DSP Engine
RC-1	628 Remote Control
RC-2	440 Remote Control
RC-610	Remote Control