

# ***Data Projector***

---

Operating Instructions

***VPL-FX52/FX52L***

# WARNING

**To reduce the risk of fire or electric shock, do not expose this apparatus to rain or moisture.**

**To avoid electrical shock, do not open the cabinet. Refer servicing to qualified personnel only.**

## **THIS APPARATUS MUST BE EARTHED.**

**WARNING:** THIS WARNING IS APPLICABLE FOR USA ONLY. If used in USA, use the UL LISTED power cord specified below. DO NOT USE ANY OTHER POWER CORD.

Plug Cap	Parallel blade with ground pin (NEMA 5-15P Configuration)
Cord	Type SJT, three <b>16 or 18 AWG wires*</b>
Length	Minimum 1.5 m (4 ft .11 in.), Less than 2.5 m (8 ft .3 in.)
Rating	Minimum <b>10 A, 125 V*</b>

Using this unit at a voltage other than 120V may require the use of a different line cord or attachment plug, or both.

To reduce the risk of fire or electric shock, refer servicing to qualified service personnel.

**WARNING:** THIS WARNING IS APPLICABLE FOR OTHER COUNTRIES.

- 1 Use the approved Power Cord (3-core mains lead) / Appliance Connector / Plug with earthing-contacts that conforms to the safety regulations of each country if applicable.
- 2 Use the Power Cord (3-core mains lead) / Appliance Connector / Plug conforming to the proper ratings (Voltage, Ampere).

If you have questions on the use of the above Power Cord / Appliance Connector / Plug, please consult a qualified service personnel.

If you have questions on the use of the above Power Cord / Appliance Connector / Plug, please consult a qualified service personnel.

## **For the customers in the USA**

This equipment has been tested and found to comply with the limits for a Class A digital device, pursuant to Part 15 of the FCC Rules. These limits are designed to provide reasonable protection against harmful interference when the equipment is operated in a commercial environment. This equipment generates, uses, and can radiate radio frequency energy and, if not installed and used in accordance with the instruction manual, may cause harmful interference to radio communications. Operation of this equipment in a residential area is likely to cause harmful interference in which case the user will be required to correct the interference at his own expense.

You are cautioned that any changes or modifications not expressly approved in this manual could void your authority to operate this equipment.

The shielded interface cable recommended in this manual must be used with this equipment in order to comply with the limits for a digital device pursuant to Subpart B of Part 15 of FCC Rules.

This device complies with part 15 of the FCC Rules. Operation is subject to the following two conditions: (1) this device may not cause harmful interference, and (2) this device must accept any interference received, including interference that may cause undesired operation.

## **For the customers in Europe**

### **WARNING**

This is a Class A product. In a domestic environment, this product may cause radio interference in which case the user may be required to take adequate measures.

## **For the customers in Canada**

This Class A digital apparatus complies with Canadian ICES-003.

## Voor de klanten in Nederland



Gooi de batterij niet weg  
maar lever deze in als klein  
chemisch afval (KCA).

### **WARNING**

When installing the unit, incorporate a readily accessible disconnect device in the fixed wiring, or connect the power cord to socket-outlet which must be provided near the unit and easily accessible.

If a fault should occur during operation of the unit, operate the disconnect device to switch the power supply off, or disconnect the power cord.

### **CAUTION**

**RISK OF EXPLOSION IF BATTERY IS  
REPLACED BY AN INCORRECT  
TYPE.**

**DISPOSED OF USED BATTERIES  
ACCORDING TO THE  
INSTRUCTIONS.**

### **For safety**

Be sure to attach the air filter to the projector.

---

# Table of Contents

---

## **Overview**

Precautions .....	5
Notes on Installation and Usage .....	7
Unsuitable Installation .....	7
Usage in High Altitude .....	8
Unsuitable Conditions .....	8
Features .....	9
Location and Function of Controls .	10
Front .....	10
Rear/Bottom .....	10
Control Panel .....	11
Connector Panel .....	13
Remote Commander .....	14

---

## **Setting Up and Projecting**

Installation Example .....	17
Connecting the Projector .....	18
Connecting with a Computer or a VCR .....	18
To connect to a video GBR/ Component equipment ....	20
Selecting the Menu Language .....	21
Projecting .....	23
Effective Tools for Your Presentation .....	28

---

## **Adjustments and Settings Using the Menu**

Using the MENU .....	29
The PICTURE SETTING Menu .....	30
The INPUT SETTING Menu .....	32
The SET SETTING Menu .....	34

The MENU SETTING Menu .....	35
The INSTALL SETTING Menu .....	35
The INFORMATION Menu .....	36

---

## **Operation and Administration using a Network**

Accessing the Projector from a Computer .....	37
Checking the Status of the Projector	37
Controlling the Projector from a Computer .....	38
Setting Up the Projector .....	38

---

## **Maintenance**

Replacing the Lamp .....	42
Cleaning the Air Filter .....	43
Troubleshooting .....	45
Messages List .....	47

---

## **Others**

Specifications .....	49
Index .....	56

---

# Precautions

## Warning

The Installation Manual contained in the CD-ROM is for dealers. If customers perform the installation described in this manual, an accident may occur, causing serious injury. Never install it by yourself. For installation, be sure to consult with a Sony dealer.

---

## On safety

- Check that the operating voltage of your unit is identical with the voltage of your local power supply. If voltage adaptation is required, consult with qualified Sony personnel.
- Should any liquid or solid object fall into the cabinet, unplug the unit and have it checked by qualified Sony personnel before operating it further.
- Unplug the unit from the wall outlet if it is not to be used for several days.
- To disconnect the cord, pull it out by the plug. Never pull the cord itself.
- The wall outlet should be near the unit and easily accessible.
- The unit is not disconnected from the AC power source (mains) as long as it is connected to the wall outlet, even if the unit itself has been turned off.
- Do not look into the lens while the lamp is on.
- Do not place your hand or objects near the ventilation holes — the air coming out is hot.
- Be careful not to catch your fingers by the adjuster when you adjust the height of the projector. Do not push hard on the top of the projector with the adjuster out.

---

## On illumination

- To obtain the best picture, the front of the screen should not be exposed to direct lighting or sunlight.
- Ceiling-mounted spot lighting is recommended. Use a cover over fluorescent lamps to avoid lowering the contrast ratio.

- Cover any windows that face the screen with opaque draperies.
- It is desirable to install the projector in a room where floor and walls are not of light-reflecting material. If the floor and walls are of reflecting material, it is recommended that the carpet and wall paper be changed to a dark color.

---

## On preventing internal heat build-up

- After you turn off the power with the I / ⏻ key on the control panel or on the Remote Commander, do not disconnect the unit from the wall outlet while the cooling fan is still running.
- Do not disconnect the AC power cord from the wall outlet while the fan is still running. (For dealers)

## Caution

The projector is equipped with ventilation holes (intake) and ventilation holes (exhaust) at the front. Do not block or place anything near these holes, or internal heat build-up may occur, causing picture degradation or damage to the projector.

---

## On cleaning

- To keep the cabinet looking new, periodically clean it with a soft cloth. Stubborn stains may be removed with a cloth lightly dampened with a mild detergent solution. Never use strong solvents, such as thinner, benzene, or abrasive cleansers, since these will damage the cabinet.
- Avoid touching the lens. To remove dust on the lens, use a soft dry cloth. Do not use a damp cloth, detergent solution, or thinner.
- Clean the filter at regular intervals.

---

## On repacking

- Save the original shipping carton and packing material; they will come in handy if you ever have to ship your unit. For maximum protection, repack your unit as it was originally packed at the factory.

---

## On LCD projector

- The LCD projector is manufactured using high-precision technology. You may, however, see tiny black points and/or bright points (red, blue, or green) that continuously appear on the LCD projector. This is a normal result of the manufacturing process and does not indicate a malfunction.

## For dealers

Please read throughly this Safety Regulations and Installation Manual contained in the CD-ROM for safe installation.

---

## On safety

- Avoid using an extension cord with a low voltage limited since it may cause the short-circuit and physical incidents.
- To carry the projector, be sure to use the carrying handle. Do not hold other parts of the projector, especially the lens, nor catch your finger between the handle, floor, and the projector.
- Do not catch your finger between the unit and surface of the floor when moving the projector installed on the floor.
- Be careful not to catch your finger in the cooling fan.
- Do not carry the projector with the cabinet on and with its cover open.

---

## On installation

- When the projector is mounted on the ceiling, the Sony PSS-620 Projector Suspension Support must be used for installation.
- Allow adequate air circulation to prevent internal heat build-up. Do not place the unit on surfaces (rugs, blankets, etc.) or near materials (curtains, draperies) that may block the ventilation holes. Leave space of more than 50 cm (19 <sup>3</sup>/<sub>4</sub> inches) between the wall and the projector. Be aware that room heat rises to the ceiling; check that the temperature near the installation location is not excessive.

- Install the projector on the floor or ceiling. Any other installation causes a malfunction such as color irregularity or shortening lamp life.
- Do not install the unit in a location near heat sources such as radiators or air ducts, or in a place subject to direct sunlight, excessive dust or humidity, mechanical vibration or shock.
- To avoid moisture condensation, do not install the unit in a location where the temperature may rise rapidly.
- Be sure to secure the cabinet cover firmly when installing to the ceiling firmly.

# Notes on Installation and Usage

## Unsuitable Installation

Do not install the projector in the following situations. **These installations may cause malfunction or damage** to the projector.

### Poorly ventilated

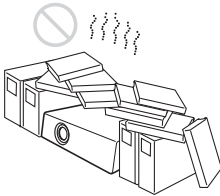

- Allow adequate air circulation to prevent internal heat build-up. Do not place the unit on surfaces (rugs, blankets, etc.) or near materials (curtains, draperies) that may block the ventilation holes.
- When the internal heat builds up due to the block-up, the temperature sensor will function with the message “High temp.! Lamp off in 1 min.” The power will be turned off automatically after one minute.
- Leave space of more than 50 cm (19 <sup>3</sup>/<sub>4</sub> inches) around the unit.
- Be careful that the ventilation holes may inhale tininess such as a piece of paper.

### Highly heated and humid

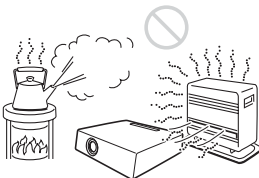

- Avoid installing the unit in a location where the temperature or humidity is very high, or temperature is very low.
- To avoid moisture condensation, do not install the unit in a location where the temperature may rise rapidly.

### Subject to direct cool or warm air from an air-conditioner

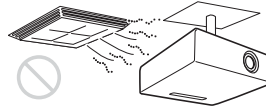

Installing in such a location may cause malfunction of the unit due to moisture condensation or rise in temperature.

### Near a heat or smoke sensor

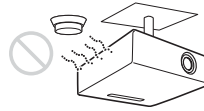

Malfunction of the sensor may be caused.

### Very dusty, extremely smoky

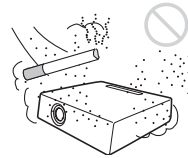

Avoid installing the unit in a very dusty or extremely smoky environment. Otherwise, the air filter will become obstructed, and this may cause a malfunction of the unit or damage it. Dust preventing the air passing through the filter may cause a rise in the internal temperature of the unit. Clean the filter periodically.

## Usage in High Altitude

When using the projector at an altitude of 1,500 m (4,921 feet) or higher, turn on “High Altitude Mode” in the INSTALL SETTING menu. Failing to set this mode when using the projector at high altitudes could have adverse effects, such as reducing the reliability of certain components.

### Note on the screen

When using a screen with an uneven surface, stripes pattern may rarely appear on the screen depending on the distance between the screen and the projector or the zooming magnifications. This is not a malfunction of the projector.

## Unsuitable Conditions

Do not use the projector under the following conditions.

### Topping the unit

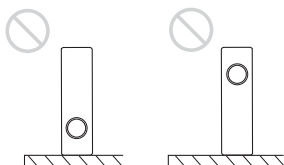

Avoid using as the unit topples over on its side. It may cause malfunction.

### Tilting right/left

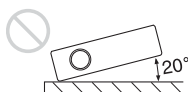

Avoid using as the unit tilts more than 20 degrees. Do not install the unit other than on the floor or ceiling. These installations may cause malfunction.

## Blocking the ventilation holes



Avoid using something to cover over the ventilation holes (exhaust/intake); otherwise, the internal heat may build up.

### Note

When using a screen with an uneven surface, stripes pattern may rarely appear on the screen depending on the distance between the screen and the projector or the zooming magnifications. This is not a malfunction of the projector.



---

# Features

---

## High brightness, high picture quality

- **High brightness**

The high aperture ratio LCD panel with a microlens and the 300 W lamp provide high brightness (light output 6000 ANSI lumen) and excellent uniformity on the picture.

- **High resolution**

By adopting three 1.3-inch high definition panel, approximately 790,000-pixels XGA panels, the resolutions of 1024 × 768 pixels for RGB input, and 750 horizontal TV lines for video input.

- **High picture performance**

The DDE (Dynamic Detail Enhancer) technology, originally developed by Sony, enables converting interlace format video signals to progressive format, allowing you to obtain a detailed picture.

The technology also reproduces the film sources in 2-3 Pull-Down format with smooth picture movement.

The internal RGB enhancer provides sharper RGB pictures. The 10-bit 3D Digital Gamma correction for good picture uniformity is also provided.

---

## Convenient and flexible setup

- **Power zoom/power focus lens and the lens shift function**

The projector is equipped with a 1.3-times power zoom and power focus lens\*, which allows you to change the size of the projected image without having to move the projector. The lens shift function enables you to install the projector in a wide range of locations, without worrying about trapezoid distortion. Also, three optional lenses are available for the projector, depending on your setup condition.

\*For VPL-FX52 (with standard lens) only

- **Center positioned lens**

The projector is designed to locate the lens in the center of the unit. This enables an easy setup, as the lens center aligns with the center of the screen.

- **Tilt installation (in front and rear)**

You can install the projector by tilting it 90 degrees at the rear or 90 degrees in front. You can use a mirror for rear projection.

- **Direct Power On/Power Off function**

The AC power for the entire system can be turned on and off by means of a breaker or other switch.

- **Twin stack installation**

Thanks to the lens shift function, two projectors can be stacked, which improves the brightness of the image.

- **System expandability using a network**

Connection to a LAN allows you to obtain projector status information such as the lamp timer or to control the projector away from the installation location via a Web browser.

Also, this projector enables the sending of mail that contains messages on the time for replacement of the projector lamp, error occurrences, etc., to mail addresses that have been specified. This projector corresponds with SNMP.

---

## Multi scan compatibility

- **DVI, 5BNC and HD D-sub 15 pin connectors**

The projector has the DVI (Digital Visual Interface) connector, the digital input connector, which allows you to connect to the digital RGB equipment equipped with the DVI output. The 5BNC input connectors allow you to connect to workstation output high-resolution signals and to connect to a computer from a long distance.

- **Accept various input signals**

The projector accepts video signals of the composite, S video and component, and can also display the VGA, SVGA, XGA, SXGA, SXGA+ and UXGA (60 Hz) signals.

The projector has 46 preset data for input signals in the memory.

- **Compatible with six color systems**

NTSC 3.58, PAL, SECAM, NTSC 4.43<sup>1)</sup>, PAL-M or PAL-N color system can be selected automatically.

---

1)NTSC4.43 is the color system used when playing back a video recorded on NTSC on an NTSC4.43 system VCR.

# Location and Function of Controls

## Front

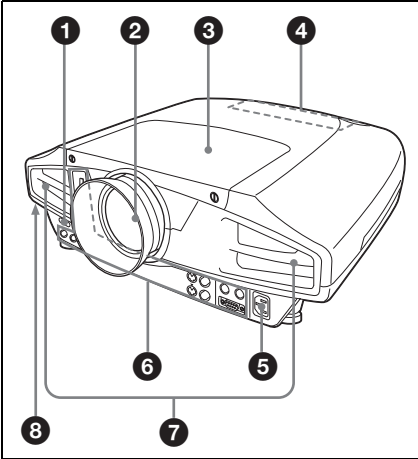

## Rear/Bottom

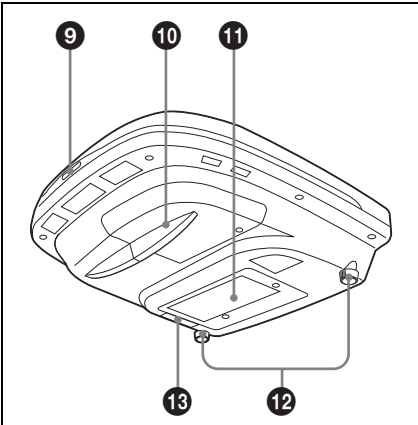

### 1 Front remote control detector

### 2 Lens

Remove the lens cap before projection.

\* The lens for VPL-FX52L are not supplied.

### 3 Lens cover

### 4 Control panel

For details, see “Control Panel” on page 11.

### 5 AC IN socket

Connects the supplied AC power cord.

### 6 Connector panel

For details, see “Connector Panel” on page 13.

### 7 Ventilation holes (exhaust)

#### Notes

- Do not place anything near the ventilation holes as it may cause internal heat build-up.
- Do not block the ventilation holes (intake/exhaust). Otherwise, internal heat build-up may occur, causing a fire or damage to the projector.
- Do not place your hand or objects near the ventilation holes — the air coming out is hot.

### 8 Security lock

Connects to an optional security cable (Kensington's<sup>1)</sup>).

Home page address:  
<http://www.kensington.com/>

### 9 Rear remote control detector

### 10 Lamp cover

### 11 Ventilation holes (intake)

1)Kensington is a registered trademark of Kensington Technology Group.

## 12 Adjuster

Use the adjusters to keep the projector level if it is installed on an uneven surface.

Adjust the height so that the projector becomes level. The projector is raised by turning the adjusters clockwise, or it is lowered by turning them counterclockwise.

## 13 Air filter

For details, see “Cleaning the Air Filter” on page 43.

### Note

To maintain optimal performance, **clean the air filter periodically.**

## Control Panel

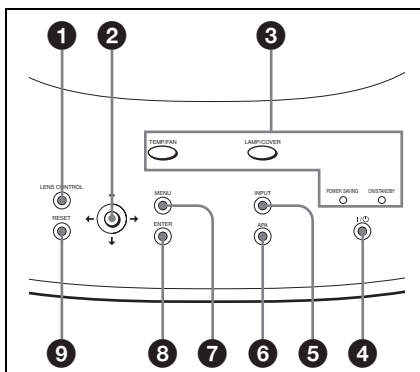

### 1 LENS CONTROL key

Enters the focus, zoom or shift adjustment mode. Next adjust them using the arrow keys. Each time you press the key, the mode changes to LENS FOCUS, LENS ZOOM and LENS SHIFT in order. The mode currently selected is displayed on the screen.

- **LENS FOCUS:** Enters the focus adjustment mode. Next adjust the focus using the arrow keys. Press the **↑** or **→** key to focus on a picture further back, and the **↓** or **←** key to focus on a forward picture. The LENS FOCUS does not work when you attach the optional lens.
- **LENS ZOOM:** Enters the zoom adjustment mode. Next adjust the picture size using the arrow keys. Press the **↑** or **→** key to enlarge the picture size, and the **↓** or **←** key to reduce it. The LENS ZOOM does not work when you attach the optional lens.
- **LENS SHIFT:** Enters the shift adjustment mode. Next adjust the vertical position of the picture using the arrow keys. Press the **↑** or **→** key to move the picture upward, and the **↓** or **←** key to move it downward.

## 2 Arrow keys (↑/↓/←/→)

Used to adjust focus, zoom and shift, or to move the cursor or make various adjustments in the menu.

## 3 Indicators

### TEMP (Temperature)/FAN

- Lights up when temperature inside the projector becomes unusually high.
- Flashes when the fan is broken.

### LAMP/COVER

- Lights up when the lamp has reached the end of its life or becomes a high temperature.
- Flashes when the lamp cover or air filter is not secured firmly.

### POWER SAVING

Lights up when the projector is in the power saving mode. When “Power Saving” in the SET SETTING menu is set to ON, the projector goes into the power saving mode if no signal is input for 10 minutes. Although the lamp goes out, the cooling fan keeps running. In the power saving mode, any key does not function for the first 40 seconds. The power saving mode is canceled when a signal is input or any key is pressed.

### ON/STANDBY

- Lights in red when the AC power cord is plugged into the wall outlet. Once in the standby mode, you can turn on the projector with the I / ⏻ key.
- Lights in green when the power is turned on.
- Flashes in green from the projector is turned on until the projector is ready to operate. Also, flashes in green while the cooling fan is cooling after the power is turned off with the I / ⏻ key. The fan runs for about 120 seconds after the power is turned off.
- The ON/STANDBY indicator flashes quickly for the first 40 seconds. During this time, you cannot light up the ON/STANDBY indicator with the I / ⏻ key.

*For details on the LAMP/COVER and the TEMP/FAN indicators, see page 33.*

## 4 I / ⏻ (on / standby) key

Turns on the projector when the projector is in the standby mode. The ON/STANDBY indicator lights in green when the power is turned on.

When turning off the power, press the I / ⏻ key twice following the message on the screen, or press and hold the key for about one second.

*For details on steps for turning off the power, see “To turn off the power” on page 27.*

## 5 INPUT key

Selects the input signal. Each time you press the key, the input signal switches as follows:

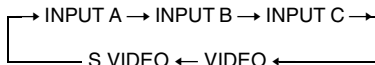

## 6 APA (Auto Pixel Alignment) key

Pressing this key while a signal from a computer is being input automatically adjusts the picture so that it can be seen clearly. This function also simultaneously adjusts the screen size and makes up/down and left/right shift adjustments.

### Note

Press the APA key when the full image is displayed on the screen. If the projected image includes a large black area around the periphery, the APA function will not function properly and in some cases, portions of the image may not be displayed.

- You can cancel the adjustment by pressing the APA key again while “Adjusting” appears on the screen.
- The picture may not be adjusted properly depending on the kinds of input signals.
- Adjust the items “Dot Phase,” “H Size” and “Shift” in the INPUT SETTING menu when you adjust the picture manually.

## 7 MENU key

Displays the on-screen menu. Press again to clear the menu.

## 8 ENTER key

Enters the settings of items in the menu system.

## 9 RESET key

Resets the value of an item back to its factory preset value. This key functions when the menu or a setting item is displayed on the screen.

## Connector Panel

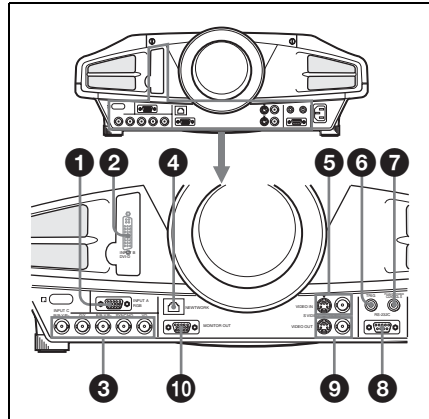

### 1 INPUT A connectors (HD D-sub 15-pin, female)

Connects to the monitor output on a computer.

### 2 INPUT B connector (RGB (DVI)) (DVI-D)

Connects to a computer equipped with DVI (digital) output connector with a DVI cable.

### 3 INPUT C connectors

5BNC input connectors (R/R-Y/Pr, G/Y, B/B-Y/Pb, SYNC/HD, VD connectors) (BNC type): Connect to a high-resolution computer or VCR where signals are transmitted long distances; for example, when the projector has been hung from the ceiling. According to the connected equipment, computer, component (R-Y/Y/B-Y), HDTV or DTV (DTV GBR, DTV YPbPr) signal is selected.

### 4 NETWORK connector (RJ-45)

Connect to a computer on the same LAN with the LAN cable when you use the networking function of this projector.

#### CAUTION

For safety, do not connect the connector for peripheral device wiring that might have excessive voltage to this port. Follow the instructions for this port.

## 5 VIDEO IN connectors

Connect to external video equipment such as a VCR.

**S VIDEO (mini DIN 4-pin):** Connects to the S video output (Y/C video output) on video equipment.

**VIDEO (BNC type):** Connects to the composite video output.

## 6 TRIG (trigger output) jack (monaural minijack)

The signal is transmitted from this jack to the connected equipment whether the projector is on or off. (This is not a power source for external equipment.) Approximately 12 V DC signal is output when the projector power is on. The signal is 0 volt level output when the projector power is off.

## 7 CONTROL S/PLUG IN POWER (DC 5V output) jack (stereo minijack)

Connects to the control S out jacks of the Sony equipment.

Connects to the CONTROL S OUT jack on the supplied Remote Commander when using it as a wired Remote Commander. In this case, you do not need to install the batteries in the Remote Commander, since the power is supplied from this jack.

## 8 RS-232C connector (D-sub 9-pin, female)

Connects to a computer to operate the projector from the computer.

## 9 VIDEO OUT connectors

**S VIDEO (mini DIN 4-pin):** Used as loop-through output via the S VIDEO IN connector.

**VIDEO (BNC type):** Used as loop-through output via the VIDEO IN connector.

## 10 MONITOR OUT connector (HD D-sub 15-pin, female)

Outputs signals from the selected channel and computer signals only from among the signals from the INPUT A or INPUT C RGB connector. This connector does not output any signals from the INPUT B connector.

## Remote Commander

The keys which have the same names as on the control panel function identically.

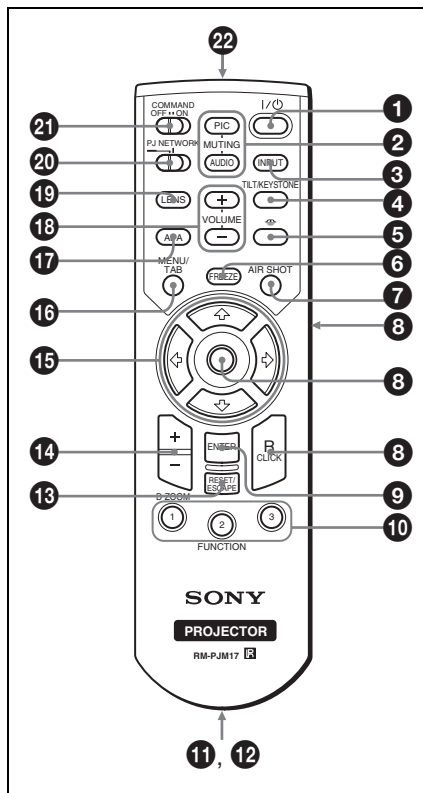

### 1 I / $\odot$ key

### 2 MUTING keys

- **PIC:** Cuts off the picture. Press again to restore the picture.
- **AUDIO:** This key does not work in the unit.

### 3 INPUT key

### 4 TILT/KEystone key

Adjusts the vertical trapezoidal distortion of the image manually. Use the arrow keys ( $\uparrow/\downarrow/\leftarrow/\rightarrow$ ) for adjustment.

- 5**  **(Memory Stick) key**  
This key does not work in the unit.
- 6** **FREEZE key**  
This key freezes the projected image. Press again to unfreeze the image. (available for computer signals only)
- 7** **AIR SHOT key**  
This key does not work in the unit.
- 8** **Keys that emulate a mouse**  
This key does not work in the unit.
- 9** **ENTER key**
- 10** **FUNCTION 1/2/3 keys**  
This key does not work in the unit.
- 11** **Strap holder**  
Attaches the supplied strap.
- 12** **CONTROL S OUT jack (stereo mini-jack)**  
Connects to the CONTROL S IN jack on the projector with the connecting cable (not supplied) when using the Remote Commander as a wired one. In this case, you do not need to install the batteries since the power is supplied via the CONTROL S IN jack on the projector.
- 13** **RESET/ESCAPE key**  
Functions as a RESET key.  
Resets the value of an item to its factory preset value or returns the enlarged image to its original size. This key functions when the menu or a setting item is displayed on the screen.
- 14** **D ZOOM +/- key**  
Enlarges the image at a desired location on the screen.
- 15** **Arrow keys (↑/↓/←/→)**
- 16** **MENU/TAB key**  
Functions as a MENU key.
- 17** **APA (Auto Pixel Alignment) key**  
Automatically adjusts a picture to its clearest while a signal is input from a computer.  
*For details, see “Smart APA” in the SET SETTING menu on page 34.*
- 18** **VOLUME +/- keys**  
This key does not work in the unit.
- 19** **LENS key**  
This has the same function as the LENS CONTROL key on the control panel.
- 20** **PJ/NETWORK (Projector/Network) selector switch**  
Set this switch to PJ always.
- 21** **COMMAND ON/OFF switch**  
When this switch is set to OFF, no key on the Remote Commander function. This saves the battery power.
- 22** **Infrared transmitter**

---

## Battery installation

- 1 Push and slide to open the lid, then install the two size AA (R6) batteries (supplied) with the correct polarity.

While pressing the lid, slide it.

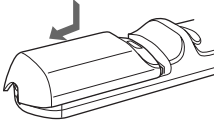

Be sure to install the battery from the ⊖ side.

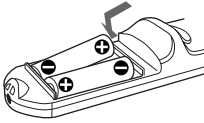

- 2 Replace the lid.

### Notes on batteries

- Make sure that the battery orientation is correct when inserting batteries.
- Do not mix an old battery with a new one or different types of batteries.
- If you will not use the Remote Commander for a long time, remove the batteries to avoid damage from battery leakage. If batteries have leaked, remove them, wipe and dry the battery compartment, and replace the batteries with new ones.

### Notes on Remote Commander operation

- Make sure that nothing obstructs the infrared beam between the Remote Commander and the remote control detector on the projector.
- The operation range is limited. The shorter the distance between the Remote Commander and the projector is, the wider the angle within which the commander can control the projector.



# Installation Example

- The following table indicates an example of installing the standard lens supplied with VPL-FX52.
- When you use VPL-FX52L (Lens are not supplied), be sure refer to the operating instructions of "Installation Manual for Dealers".

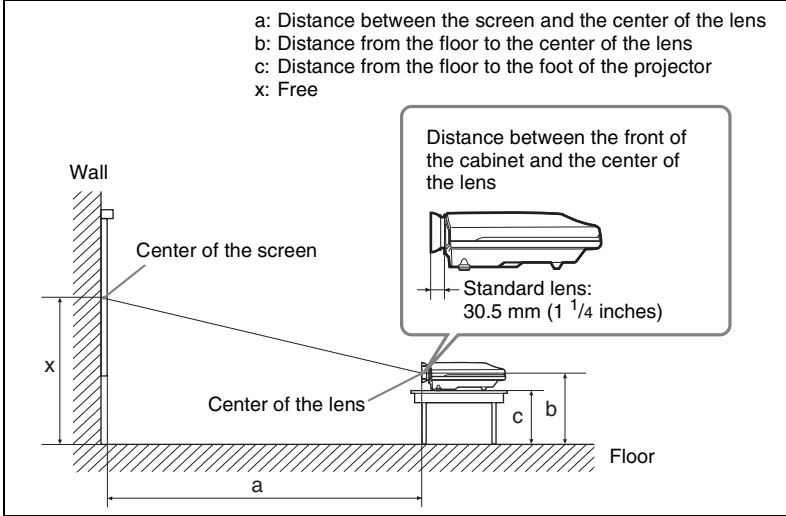

Setting Up and Projecting

Unit: mm (inches)

Screen size (inches)	40	60	80	100	120	150	180	200	250	300	
a	Minimum Distance	1490 (58 <sup>3</sup> / <sub>4</sub> )	2280 (89 <sup>7</sup> / <sub>8</sub> )	3060 (120 <sup>1</sup> / <sub>2</sub> )	3850 (151 <sup>3</sup> / <sub>8</sub> )	4630 (182 <sup>3</sup> / <sub>8</sub> )	5810 (228 <sup>7</sup> / <sub>8</sub> )	6980 (274 <sup>7</sup> / <sub>8</sub> )	7770 (306)	9730 (383 <sup>1</sup> / <sub>8</sub> )	11690 (460 <sup>3</sup> / <sub>8</sub> )
	Maximum Distance	1820 (71 <sup>3</sup> / <sub>4</sub> )	2780 (109 <sup>1</sup> / <sub>2</sub> )	3740 (147 <sup>3</sup> / <sub>8</sub> )	4700 (185 <sup>1</sup> / <sub>8</sub> )	5660 (222 <sup>7</sup> / <sub>8</sub> )	7100 (279 <sup>3</sup> / <sub>8</sub> )	8540 (336 <sup>3</sup> / <sub>8</sub> )	9500 (374 <sup>1</sup> / <sub>8</sub> )	11900 (468 <sup>3</sup> / <sub>8</sub> )	14300 (563 <sup>1</sup> / <sub>8</sub> )
b	Minimum Distance	x-305 (x-12 <sup>1</sup> / <sub>8</sub> )	x-457 (x-18)	x-610 (x-24 <sup>1</sup> / <sub>8</sub> )	x-762 (x-30)	x-914 (x-36)	x-1143 (x-45)	x-1372 (x-54 <sup>1</sup> / <sub>8</sub> )	x-1524 (x-60)	x-1905 (x-75 <sup>1</sup> / <sub>8</sub> )	x-2286 (x-90 <sup>1</sup> / <sub>8</sub> )
	Maximum Distance	x									
c	Minimum Distance	x-417 (x-16 <sup>1</sup> / <sub>2</sub> )	x-569 (x-22 <sup>1</sup> / <sub>2</sub> )	x-722 (x-28 <sup>1</sup> / <sub>2</sub> )	x-874 (x-34 <sup>1</sup> / <sub>2</sub> )	x-1026 (x-40 <sup>1</sup> / <sub>2</sub> )	x-1255 (x-49 <sup>1</sup> / <sub>2</sub> )	x-1484 (x-58 <sup>1</sup> / <sub>2</sub> )	x-1636 (x-64 <sup>1</sup> / <sub>2</sub> )	x-2017 (x-79 <sup>7</sup> / <sub>16</sub> )	x-2398 (x-94 <sup>1</sup> / <sub>2</sub> )
	Maximum Distance	x-102 (x-4 <sup>1</sup> / <sub>8</sub> )									

**To calculate the installation measurement (unit: mm)**

SS: screen size diagonal (inches)

a (minimum) =  $\{(SS \times 50.127/1.3102) - 73.9\} \times 1.025$

a (maximum) =  $\{(SS \times 64.519/1.3102) - 107.9\} \times 0.975$

b (minimum) =  $x - (SS/1.3102 \times 9.984)$

c (minimum) =  $x - (SS/1.3102 \times 9.984 + 112)$

---

# Connecting the Projector

## When you connect the projector, make sure to:

- Turn off all equipment before making any connections.
- Use the proper cables for each connection.
- Insert the cable plugs firmly; loose connections may increase noise and reduce performance of picture signals. When pulling out a cable, be sure to pull it out from the plug, not the cable itself.

## Connecting with a Computer or a VCR

This section describes how to connect the projector to a computer or video equipment.

For more information, refer to the computer's instruction manual.

### Notes

- The projector accepts VGA, SVGA, XGA, SXGA, SXGA+ and UXGA (60 Hz) signals. However, we recommend that you set the output mode of your computer to XGA mode for the external monitor.
- If you set your computer, such as a notebook type, to output the signal to both your computer's display and the external monitor, the picture of the projector may not appear properly. Set your computer to output the signal to only the external monitor. *For details, refer to the computer's operating instructions supplied with your computer.*
- If you connect a computer that can use the DDC function to the INPUT C connector on this unit, the picture of the projector may not be displayed properly. In that case, change the setting on your computer to disable the DDC function.
- This projector is compatible with a DDC2B (Digital Data Channel 2B). If your computer is compatible with a DDC, turn the projector on according to the following procedures.
  - 1** Connect the projector to the computer by using the HD D-sub 15-pin cable or DVI cable.
  - 2** Turn the projector on.
  - 3** Start the computer.

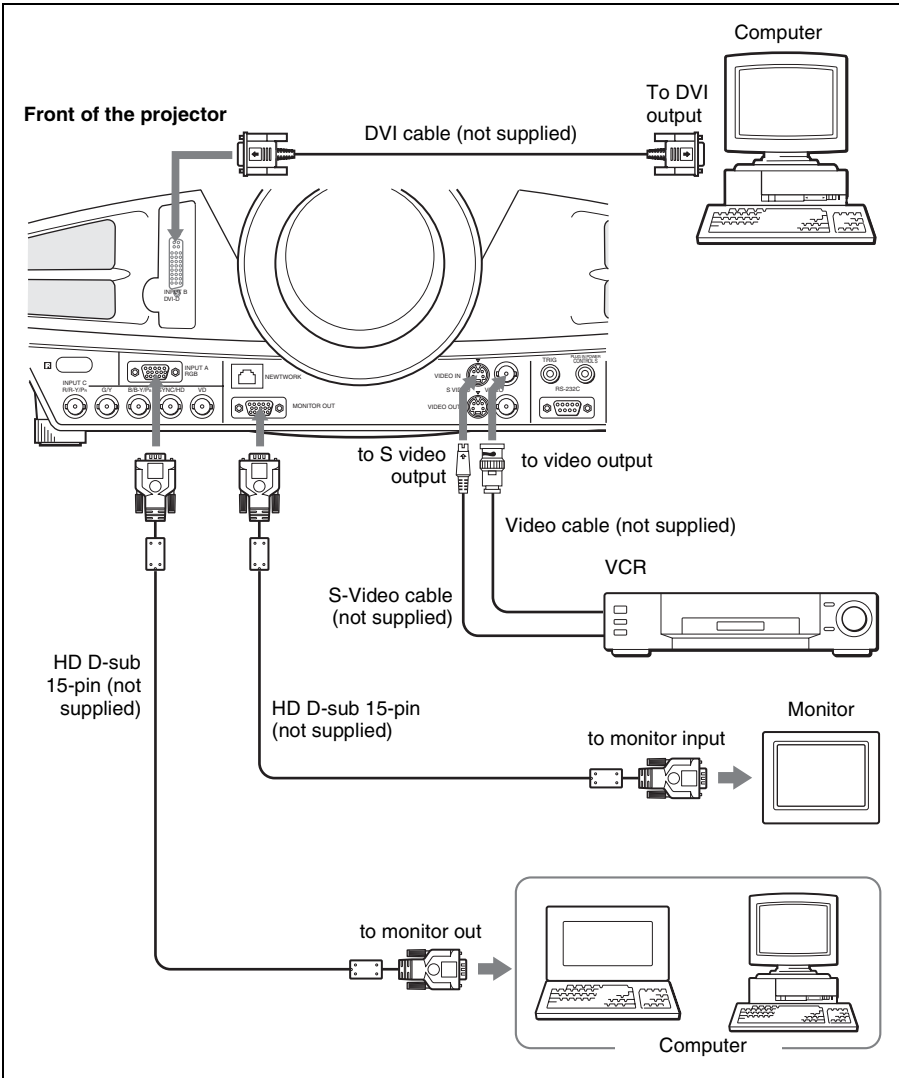

**Note**

- When connecting a Macintosh<sup>1)</sup> computer equipped with video output connector of a type having two rows of pins to the connector, use a commercially available plug adaptor.

.....  
 1) Macintosh is a registered trademark of Apple Computer Inc.

## To connect to a video GBR/Component equipment

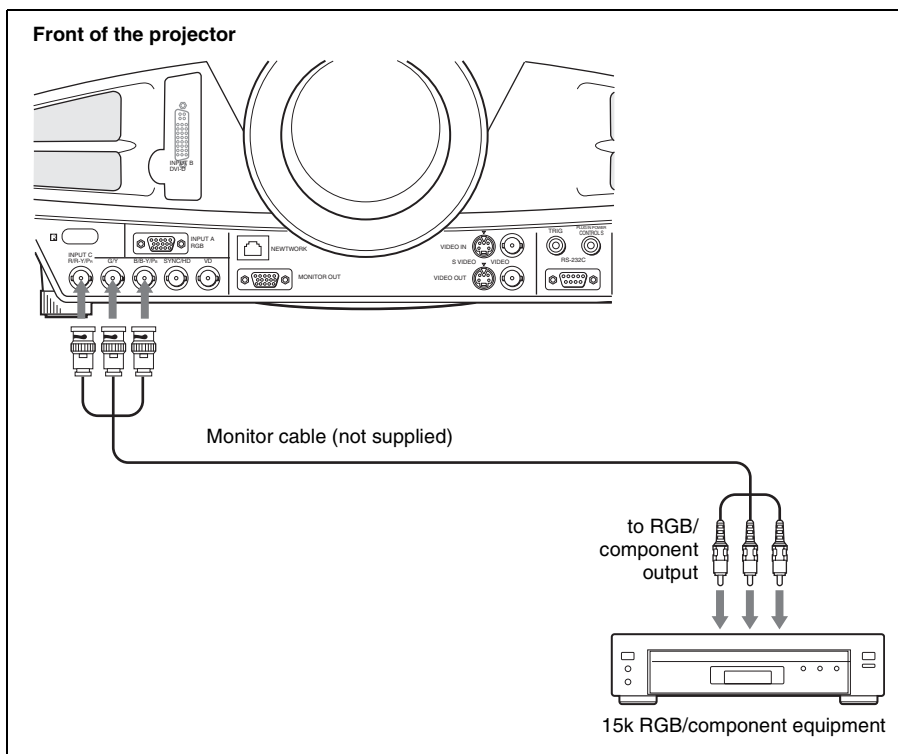

### Notes

- When you connect the unit to a video GBR output connector, select video GBR or component with the Input-C Signal Sel. setting in the SET SETTING menu.
- Use the composite sync signal when you input the external sync signal from video GBR/component equipment.

# Selecting the Menu Language

You can select one of nine languages for displaying the menu and other on-screen displays. The factory setting is English.

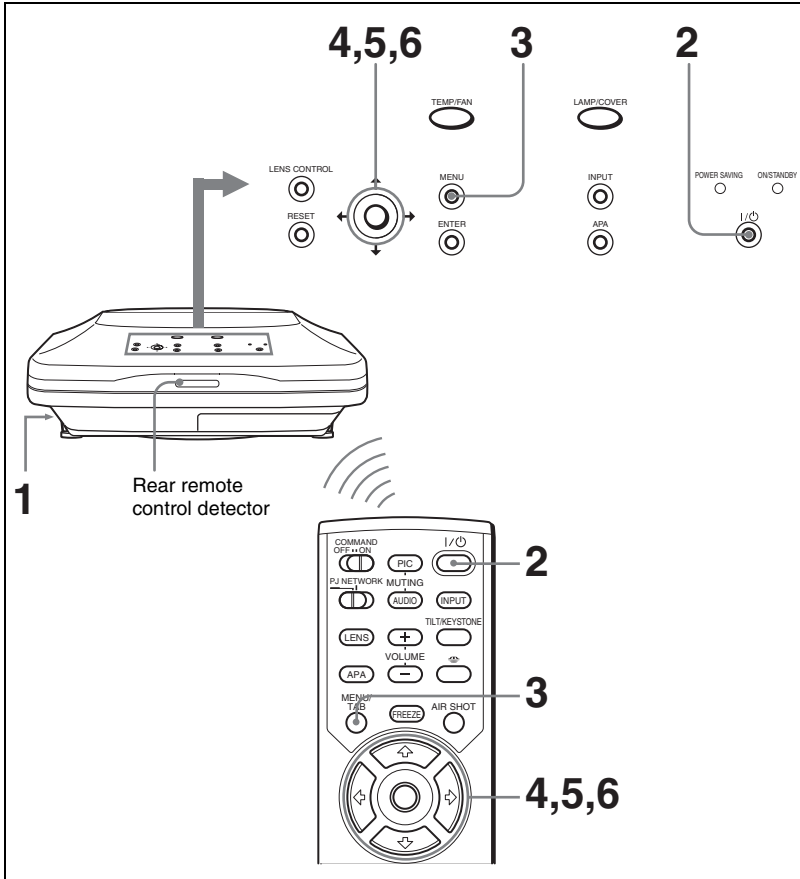

- 1** Plug the AC power cord into a wall outlet.
- 2** Press the I / ⏻ key to turn on the projector.
- 3** Press the MENU key.  
The menu appears.  
The menu presently selected is shown as a yellow button.

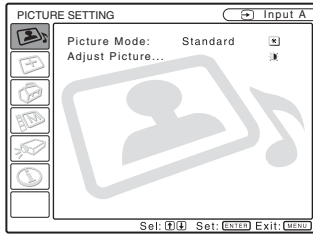

- 4 Press the **↑** or **↓** key to select the MENU SETTING menu, then press the **→** or ENTER key.  
The selected menu appears.

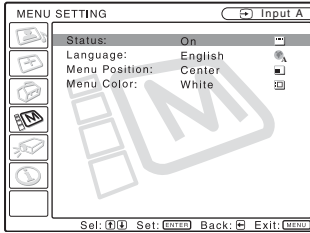

- 5 Press the **↑** or **↓** key to select “Language,” then press the **→** or ENTER key.

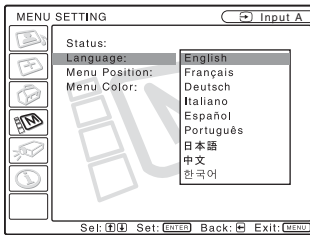

- 6 Press the **↑** or **↓** key to select a language, then press the **←** or ENTER key.  
The menu changes to the selected language.

### To clear the menu

Press the MENU key.

The menu disappears automatically if a key is not pressed for one minute.

# Projecting

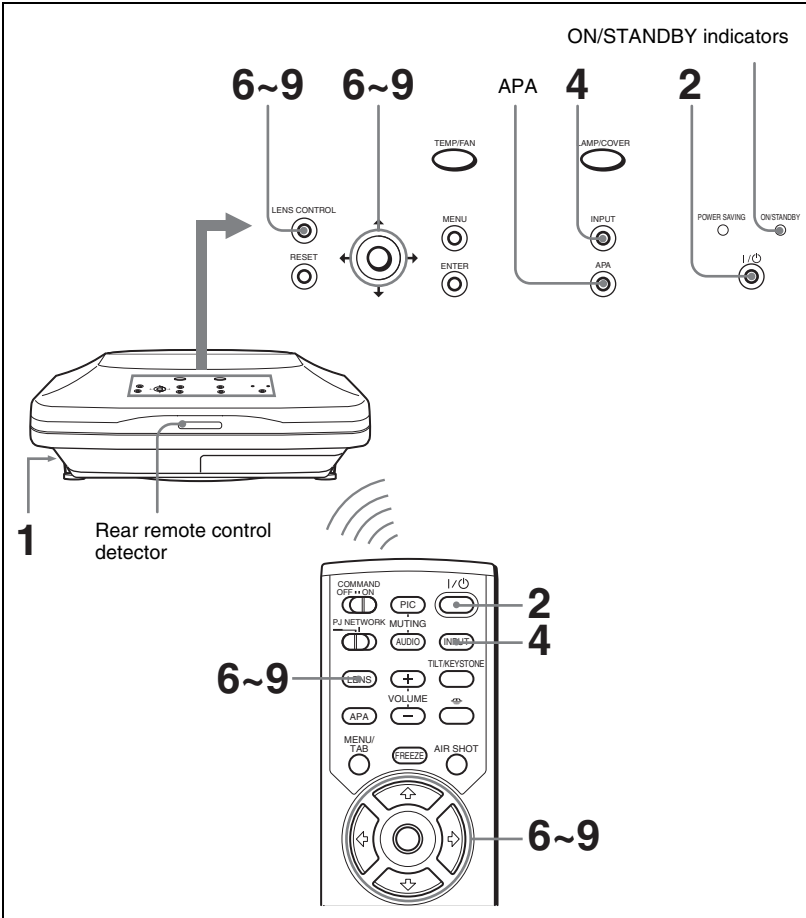

- 1** Plug the AC power cord into a wall outlet, then connect all equipment. The ON/STANDBY indicator lights in red and the projector goes into standby mode.
- 2** Press the I / ⏻ key. The ON/STANDBY indicator lights in green after it flashes for about several seconds.
- 3** Turn on the equipment connected to the projector.

**4** Press the INPUT key to select the input source.

To input from	Press INPUT to display
Computer etc., connected to the INPUT A connector	INPUT A
Computer etc., connected to the INPUT B (digital) connector	INPUT B
Computer etc., connected to the INPUT C connector	INPUT C
Video equipment connected to the VIDEO input connector	VIDEO
Video equipment connected to the S VIDEO input connector	S VIDEO

Smart APA (Auto Pixel Alignment) adjusts the picture of the connected equipment so that it is projected clearly.





**Notes**

- If “Auto Input Search” is set to “On”, the projector searches for the signals from the connected equipment and displays the input channel where the input signals are found.

*For details, see “Auto Input Search” in the SET SETTING menu on page 34.*

- The smart APA is effective for the analog input signal from a computer only.

**5** Switch the equipment to be connected to output to the projector.

Depending on the type of your computer, for example a notebook, or an all-in-one LCD type, you may have to switch the computer to output to the projector by pressing certain keys (e.g.,  ,  , etc.), or by changing your computer’s settings.

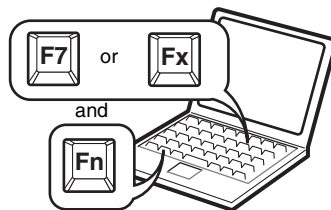

**Note**

The key for switching the computer to output to the projector varies depending on the type of a computer.

**6** Press the LENS key on the Remote Commander or LENS CONTROL key on the control panel repeatedly to display “LENS FOCUS.” Then press the arrow keys to adjust.



- 7 Press the LENS key on the Remote Commander or LENS CONTROL key on the control panel repeatedly to display “LENS ZOOM.” Then press the arrow keys to adjust.
- 8 Press the LENS key on the Remote Commander or LENS CONTROL key on the control panel repeatedly to display “LENS FOCUS.” Then press the arrow keys to adjust again.
- 9 Press the LENS key on the Remote Commander or LENS CONTROL key on the control panel repeatedly to display “LENS SHIFT.” Then press the arrow keys to adjust.

**Note**

A powered zoom/powered focus function is available for the standard lens. If you use the optional lens, adjust the zoom/focus with the lens ring.

**Attention**

Looking into the lens when projecting may cause injury to your eyes.

**To mute the picture**

Press the PIC MUTING key on the Remote Commander. Press again to restore the picture.

**To get the clearest picture**

The picture quality can be adjusted automatically when projecting the analog signal from the computer.

- 1 Project a still picture from the computer.
- 2 Press the APA key.  
“Complete!” appears on the screen when the picture is adjusted properly.

**Notes**

- Press the APA key when the full image is displayed on the screen. If the projected image includes a large black area around the periphery, the APA function will not function properly and in some cases, portions of the image may not be displayed.
- When you switch the input signal or re-connect a computer, press the APA key again to adjust the picture again.
- You can cancel the adjustment by pressing the APA key again while “ADJUSTING” appears on the screen.
- The picture may not be adjusted properly depending on the kinds of input signals.
- Adjust the items in the INPUT SETTING menu when you adjust the picture manually.

**Using the security lock**

The projector is equipped with a security lock function. When the AC power cord is inserted into the wall outlet and you turn the power of the projector on, you are required to input the previously set password. If you do not input the correct password, you will not be able to project the picture.

## Note

You will not be able to use the projector if you forget your password and the password administrator is not available. Be please aware that using the security lock can prevent valid usage in such cases.

- 1 Press the MENU key and then, in the INSTALL SETTING menu, turn on the security lock setting.
- 2 Enter the password.  
Use the MENU, ↑/↓/←/→, and ENTER keys to enter the four-digit password. (The default setting is “ENTER, ENTER, ENTER, ENTER.”)  
Next, the screen for entering the new password is displayed. (Enter the password at this screen even if you want to keep the current password.)

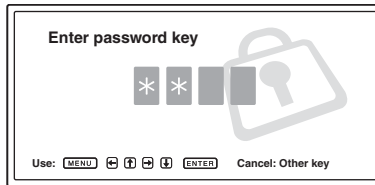

- 3 Enter the password again to confirm.  
If “Invalid Password!” is displayed on the menu screen, perform again from step 1.

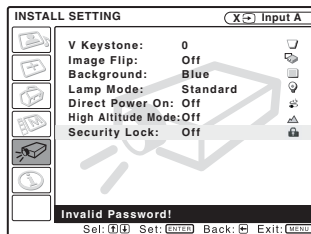

- 4 Turn the main power off and disconnect the AC power cord.  
The security lock is set to on, then it becomes effective. The screen for entering the password is displayed when the power is turned on the next time.

## Security certification

When the screen for entering the password is displayed, enter the password that was set. If you fail to enter the correct password after three tries, the projector cannot be used. In this case, press the I / ⏻ key to turn off the power.

## To cancel the security lock

- 1 Press the MENU key, then turn off the “Security Lock” setting in the INSTALL SETTING menu.

- 2 Enter the password.  
Enter the password that was set.

**Note**

If you call the customer service center because you have forgotten the password, you will need to be able to verify the projector's serial number and your identity. (This process may differ in other countries.) Once your identity has been confirmed, we will provide you with the password.

**To turn off the power**

- 1 Press the I / ⏻ key.  
“POWER OFF? Please press I / ⏻ key again.” appears to confirm that you want to turn off the power.

**Note**

A message disappears if you press any key except the I / ⏻ key, or if you do not press any key for five seconds.

- 2 Press the I / ⏻ key again.  
The ON/STANDBY indicator flashes in green and the fan continues to run for about 120 seconds to reduce the internal heat. Also, the ON/STANDBY indicator flashes quickly for the first 40 seconds. During this time, you will not be able to light up the ON/STANDBY indicator with the I / ⏻ key.
- 3 Unplug the AC power cord from the wall outlet after the fan stops running and the ON/STANDBY indicator lights in red.

**When you cannot confirm the on-screen message**

When you cannot confirm the on-screen message in a certain condition, you can turn off the power by holding the I / ⏻ key for about one second.

**Direct Power On/Off function**

If you will be using a circuit breaker to turn the power for the entire system on and off, set the direct power on function to “On”. When you turn off the power, you can also just unplug the power cord without pressing the I / ⏻ key.

**On air filter**

To maintain optimal performance, **clean the air filter whenever you replace the lamp.**

## Effective Tools for Your Presentation

### To enlarge the image (Digital Zoom function)

You can select a point in the image to enlarge. This function works when a signal from a computer is input.

- 1 Press the D ZOOM + key on the Remote Commander.  
The digital zoom icon appears the center of the image.

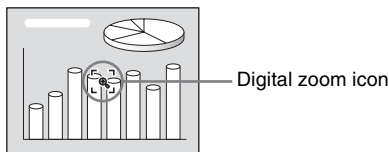

- 2 Move the icon to the point on the image you want to enlarge. Use the arrow key (↑/↓/←/→) to move the icon.

- 3 Press the D ZOOM + key again.  
The image where the icon is located is enlarged. The enlargement ratio is displayed on the screen for a few seconds.  
By pressing the + key repeatedly, the image size increases (ratio of enlargement: max. 4 times.)

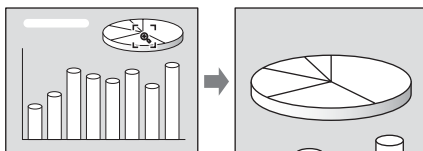

Use the arrow key (↑/↓/←/→) to scroll the enlarged image.

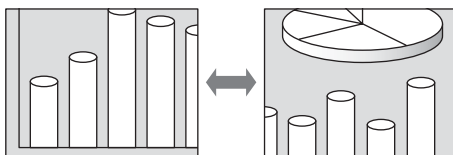

### To return the image back to its original size

Press the D ZOOM – key.

Just pressing the RESET key returns the image back to its original size immediately.

### To freeze the image projected (Freeze function)

Press the FREEZE key. "FREEZE" appears when the key is pressed. This function works when a signal from a computer is input.

To restore the original screen, press the FREEZE key again.

# Using the MENU

The projector is equipped with an on-screen menu for making various adjustments and settings. The setting items are displayed in a pop-up menu or in a sub menu. If you select an item name followed by dots (...), a sub menu with setting items appear. You can change the tone of the menu display and the menu language displayed in the on-screen menu.

To change the menu language, see “Selecting the Menu Language” on page 21.

## Display items

Input signal indicator



Input signal setting indicator

Picture adjustment menu

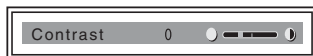

### Input signal indicator

Shows the selected input channel. is displayed when no signal is input. You can hide this indicator using “Status” in the MENU SETTING menu.

### Input signal setting indicator

For Input C: Shows “Computer”, “Component” or “Video GBR”.

**1** Press the MENU key.

The menu appears.

The menu presently selected is shown as a yellow button.

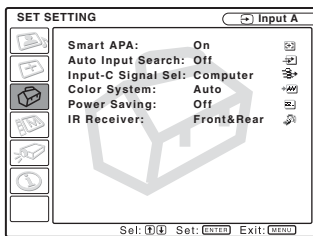

**2** Use the or key to select a menu, then press the or ENTER key.

The selected menu appears.

**3** Select an item.

Use the or key to select the item, then press the or ENTER key.

The setting items are displayed in a pop-up menu or in a sub menu.

### Pop-up menu

Menu    Setting items    Selected input signal

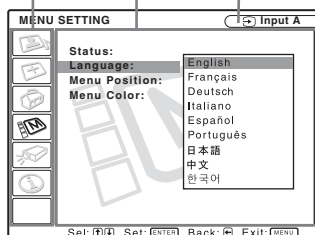

### Sub menu

Menu    Setting items

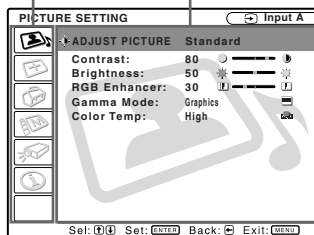

- 4 Make the setting or adjustment on an item.
- When changing the adjustment level:  
To increase the number, press the **↑** or **→** key.  
To decrease the number, press the **↓** or **←** key.  
Press the ENTER key to restore the previous screen.
  - When changing the setting:  
Press the **↑** or **↓** key to change the setting.  
Press the ENTER or **←** key to restore the previous screen.

---

### To clear the menu

Press the MENU key.  
The menu disappears automatically if a key is not pressed for one minute.

---

### To reset items that have been adjusted

Press the RESET key on the Remote Commander.  
“Complete!” appears on the screen and the **settings appearing on the screen are reset to their factory preset values.**

- Items that can be reset are:
- “Contrast,” “Brightness,” “Color,” “Hue,” “Sharpness” and “RGB Enhancer” in the Adjust Picture... menu.
  - “Dot Phase,” “H Size,” and “Shift” in the Adjust Signal... menu.

---

### About the memory of the settings

The settings are automatically stored in the projector memory.

---

### If no signal is input

If there is no input signal, “Cannot adjust this item.” appears on the screen.

---

### About the menu display

You can set the display position of the menu, intensity of the background picture and tone of the menu items as you like.

*For details, see “The MENU SETTING Menu” on page 35.*

---

## The PICTURE SETTING Menu

The PICTURE SETTING menu is used for adjusting the picture or volume. Items that cannot be adjusted depending on the input signal are not displayed in the menu.

*For details on the unadjustable items, see page 52.*

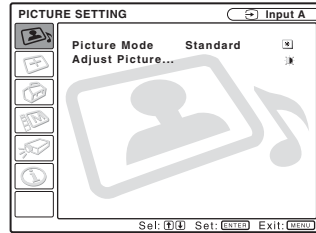

---

### Menu Items

---

#### Picture Mode

Selects the picture mode.

**Dynamic:** Emphasizes the contrast to produce a “dynamic” picture.

**Standard:** Normally select this setting. If the picture has roughness with the “Dynamic” setting, this setting reduces the roughness.

---

#### Adjust Picture... Menu Items

The unit can store the setting values of the following sub menu items for each “Dynamic” or “Standard” picture mode separately.

---

## Adjust Picture...

### When the video signal is input

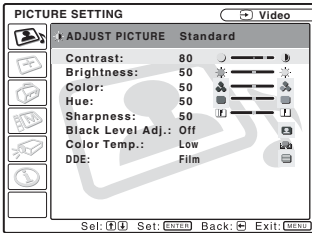

### When the RGB signal is input

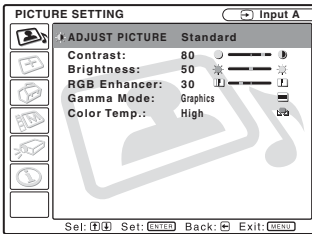

---

### Contrast

Adjusts the picture contrast. The higher the setting, the greater the contrast between a dark portion and a bright portion of the picture. The lower the setting, the lower the contrast.

---

### Brightness

Adjusts the picture brightness. The higher the setting, the brighter the picture. The lower the setting, the darker the picture.

---

### Color

Adjusts color intensity. The higher the setting, the greater the intensity. The lower the setting, the lower the intensity.

---

### Hue

Adjusts color tones. The higher the setting, the picture becomes greenish. The lower the setting, the picture becomes purplish.

---

### Sharpness

Adjusts the picture sharpness. The higher the setting, the sharper the image. The lower the setting, the softer the image.

---

### RGB Enhancer

Adjusts the picture sharpness when RGB signals are input.

The higher the setting, the sharper the picture. The lower the setting, the softer the picture.

---

### Black Level Adj.

Using black level adjustment results in a vivid image with clearly defined light and dark areas. Set the black compensation in accordance with the image source.

**High:** Strong black compensation

**Low:** Weak black compensation

**Off:** No black compensation

---

### Gamma Mode

Selects a gamma correction curve.

**Graphics:** Improves the reproduction of halftones. Photos can be reproduced in natural tones.

**Text:** Contrasts black and white. Suitable for images that contain lots of text.

---

### Color Temp.

Adjusts the color temperature.

**High:** Makes the white color bluish.

**Low:** Makes the white color reddish.

## DDE (Dynamic Detail Enhancer)

Selects the reproduction format of the input video signals according to the video sources.

**Off:** Plays back the video signal in an interlace format without converting.

**Progressive:** Converts an interlace format video signal to a progressive format.

**Film:** Reproduces the 2-2, 2-3 Pull-Down film sources with smooth picture movement. When the video signal with a format other than the 2-2, 2-3 Pull-Down is input, “Progressive” is automatically selected.

# The INPUT SETTING Menu

The INPUT SETTING menu is used to adjust the input signal.

Items that cannot be adjusted depending on the input signal are not displayed in the menu.

*For details on the unadjustable items, see page 52.*

## When the video signal is input

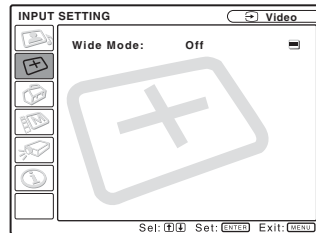

## When the RGB signal is input

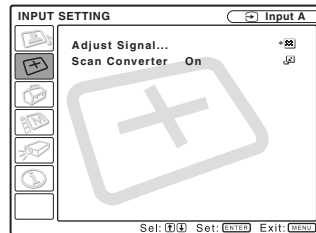

## MENU Items

### Wide Mode

Sets the aspect ratio of the picture. When inputting 16:9 (squeezed) signal from equipment such as a DVD player, set to On.

**Off:** When the picture with ratio 4:3 is input.

**On:** When the picture with ratio 16:9 (squeezed) is input.

### Note

Note that if the projector is used for profit or for public viewing, modifying the original picture by switching to the wide mode may constitute



an infringement of the rights of authors or producers, which are legally protected.

## Adjust Signal... Menu Items

### Dot Phase

Adjusts the dot phase of the LCD panel and the signal output from a computer.

Adjust the picture further for finer picture after the picture is adjusted by pressing the APA key.

Adjust the picture to where it looks clearest.

### H Size

Adjusts the horizontal size of picture output from a connector. The higher the setting, the larger the horizontal size of the picture. The lower the setting, the smaller the horizontal size of the picture. Adjust the setting according to the dots of the input signal.

*For details on the suitable value for the preset signals, see page 53.*

### Shift

Adjusts the position of the picture. H adjusts the horizontal position of the picture. V adjusts the vertical position of the picture. As the setting for H increases, the picture moves to the right, and as the setting decreases, the picture moves to the left.

As the setting for V increases, the picture moves up, and as the setting decreases, the picture moves down. Use the ← or the → key to adjust the horizontal position and the ↑ and ↓ key for the vertical position.

### Scan Converter

Converts the signal to display the picture according to the screen size.

**On:** Displays the picture according to the screen size. The picture will lose some clarity.

**Off:** Displays the picture while matching one pixel of input picture element to that of the LCD. The picture will be clear but the picture size will be smaller.

#### Note

When XGA, SXGA, SXGA+ or UXGA signal is input, this item will not be displayed.

## About the Preset Memory No.

This projector has 46 types of preset data for input signals (the preset memory). When a preset signal is input, the projector automatically detects the signal type and recalls the data for the signal from the preset memory to adjust it to an optimum picture. The memory number and signal type of that signal are displayed in the INFORMATION menu (See page 36). You can also adjust the preset data through the INPUT SETTING menu.

This projector has 20 types of user memories into which you can save the setting of the adjusted data for an unpreset input signal. When an unpreset signal is input for the first time, a memory number is displayed as 0. When you adjust the data of the signal in the INPUT SETTING menu, it will be registered to the projector. If more than 20 user memories are registered, the newest memory always overwrites the oldest one.

*See the chart on page 53 to find if the signal is registered to the preset memory.*

Since the data is recalled from the preset memory about the following signals, you can use these preset data by adjusting “H Size.” Make fine adjustment by adjusting “Shift.”

Signal	Memory No.	SIZE
Super Mac-2	23	1,312
SGI-1	23	1,320
Macintosh 19"	25	1,328
Macintosh 21"	27	1,456
Sony News	36	1,708
PC9821 1,280 × 1,024	36	1,600
WS Sunmicro	37	1,664

#### Note

When the aspect ratio of input signal is other than 4:3, a part of the screen is displayed in black.

# The SET SETTING Menu

The SET SETTING menu is used for changing the settings of the projector.

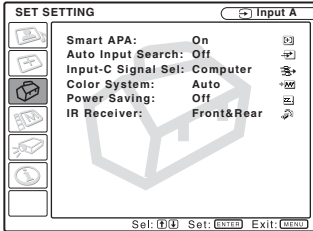

## Menu Items

### Smart APA

Activates or deactivates the Smart APA<sup>1)</sup>.

**On:** Normally select this setting. When a signal is input from a computer, the APA functions automatically so that the picture can be seen clearly. Once the specified analog input signal has been adjusted by the Smart APA, it will not be readjusted even when the cable is disconnected and connected again or the input channel is changed. You can adjust the picture by pressing APA key on the Remote Commander even if the Smart APA set to “On.”

**Off:** The APA functions when you press the APA key on the Remote Commander.

1) The APA (Auto Pixel Alignment) automatically adjusts “Dot Phase,” “H Size” and “Shift” in the INPUT SETTING menu for the input signal from a computer.

### Auto Input Search

Normally set to “Off.”

When set to “On,” the projector detects input signals in the following sequence: Input-A/ Input-B/Input-C/Video/S-Video. It indicates the input channel when the power is turned on or the INPUT key is pressed.

### Input-C Signal Sel.

Selects either a computer signal, a component signal or a video GBR signal (15k RGB, DTV, HDTV) for the signal that is input to the INPUT C connector.

### Color System

Selects the color system of the input signal. If you select “Auto,” the projector detects the color system of the input signal automatically. If the picture is distorted or colorless, select the color system according to the input signal.

### Power Saving

When set to “On,” the projector goes into power saving mode if you do not operate the unit for 10 minutes with no signal input.

### IR Receiver

Selects the remote control detectors (IR receiver) on the front and rear of the projector.

**Front&Rear:** Activates both the front and rear detectors.

**Front:** Activates the front detector only.

**Rear:** Activates the rear detector only.

# The MENU SETTING Menu

The MENU SETTING menu is used for changing the settings of the projector.

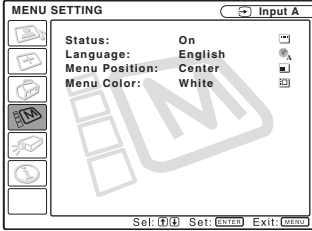

## Menu Items

### Status (on-screen display)

Sets up the on-screen display.

**On:** Shows all of the on-screen displays.

**Off:** Turns off the on-screen displays except for the menus, a message when turning off the power, and warning messages.

### Language

Selects the language used in the menu and on-screen displays. Available languages are: English, Français, Deutsch, Italiano, Español, Português, Japanese, Chinese and Korean.

### Menu Position

Selects the display position of the menu from Top Left, Bottom Left, Center, Top Right and Bottom Right.

### Menu Color

Selects the tone of the menu display from Black or White.

# The INSTALL SETTING Menu

The INSTALL SETTING menu is used for changing the settings of the projector.

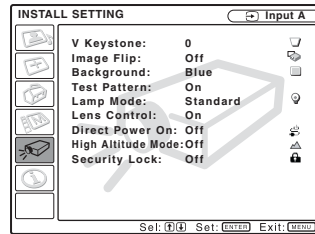

## Menu Items

### V Keystone

Corrects the trapezoid caused by the projection angle. If the base edge is longer, set a negative value; if the upper edge is longer, set a positive value to square the image.

### Image Flip

Flips the image on the screen horizontally and/or vertically.

**Off:** The image does not flip.

**HV:** Flips the image horizontally and vertically.

**H:** Flips the image horizontally.

**V:** Flips the image vertically.

### Background

Select the background color of the screen when no signal is input to the projector. Select Black or Blue.

Normally set to "Blue."

### Test Pattern

When set to "On," a test pattern is displayed on the screen during "Lens Zoom" adjustment, "Lens Focus," "Side Shot," or "V Keystone."

---

## Lamp Mode

Sets the lamp brightness in the projection.

**High:** Illuminates the projected image brightly.

**Standard:** Reduces fan noise and power consumption. The brightness of the projected image will be lower compared with the “High” setting.

---

## Lens Control

When set to “Off,” the LENS key on the Remote Commander, and the LENS CONTROL key on the projector do not function.

---

## Direct Power On/Off function

If you will be using a circuit breaker to turn the power for the entire system on and off, set the direct power on function to “On”. When you turn off the power, you can also just unplug the power cord without pressing the I /  key.

---

## High Altitude Mode

**Off:** Use this setting when using the projector at normal altitudes.

**On:** Use this setting when using the projector at an altitude of 1,500 m (4,921 feet) or higher.

---

## Security Lock

Turns on the projector’s security lock function.

**Off:** Turns off the security lock function.

**On:** Turns on the security lock function, which locks the projector once a password has been set.

*For details, see “Using the security lock” on page 25.*

---

# The INFORMATION Menu

The INFORMATION menu displays the horizontal and vertical frequencies of the input signal and the used time of the lamp.

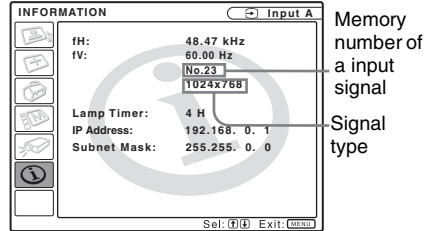

---

## Menu Items

---

### fH

Displays the horizontal frequency of the input signal.

The displayed value is approximate.

---

### fV

Displays the vertical frequency of the input signal.

The displayed value is approximate.

---

### Lamp Timer

Indicates how long the lamp has been turned on.

---

### IP Address

Displays the IP address that is set for the projector.

---

### Subnet Mask

Displays the subnet mask that is set for the projector.

---

### Note

These only display on the screen.

# Accessing the Projector from a Computer

You can check the present status of the projector on a computer display and control the projector from a computer. Also, the projector enables the sending of mail that contains messages on the time for replacement of the projector lamp, error occurrences, etc., to mail addresses that have been specified.

## Before operating

Confirm that the projector is connected to the LAN, then turn on the projector. For details on connection, consult with your network administrator.

- 1 Start Internet Explorer 5.0 (or later versions) on your computer.
- 2 Type "http://xxx.xxx.xxx.xxx (the IP address of the projector)" as the "Address," then press the ENTER key.

*You can confirm the IP address of the projector in the "Information menu" on page 36.*

### note

When you access the projector via a Web browser, do not use a proxy server.

Enter the IP address here.

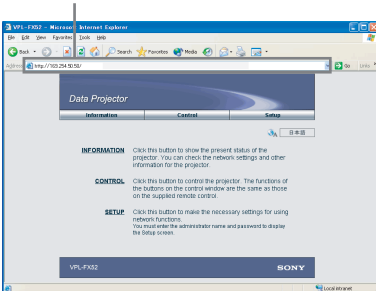

# Checking the Status of the Projector

## Click "Information."

You can check the information and present status of the projector on a computer display. You can check the information and status in the window, but you cannot change the settings.



Operation and Administration using a Network

## INFORMATION

The present status of the projector is displayed.

## MENU

The present settings of the projector are displayed.

# Controlling the Projector from a Computer

## Click “Control.”

You can perform various adjustments and settings of the projector on a computer display.

The function of the buttons in the windows are the same as those on the remote control supplied with the projector.

The present setting status is indicated

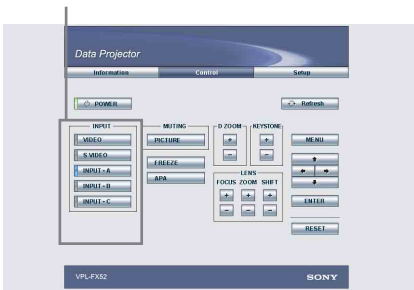

If you change the setting using the remote control, click “Refresh” in the upper right-hand corner of the window to update the status.

# Setting Up the Projector

## Click “Setup.”

The Password Properties dialog box appears.

The name of the “User” account is preset without a password to “root” at the factory. You can set the owner information, date and time, Mail Report, etc.

Click “Apply” in the lower part of each window to update the projector to the data input in each window.

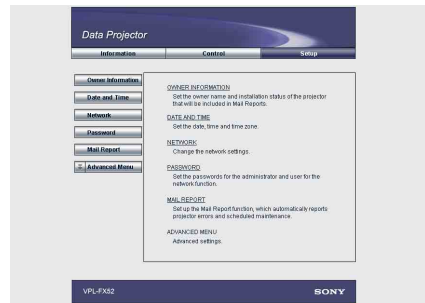

## Owner information

This information is used for the Mail Report function.

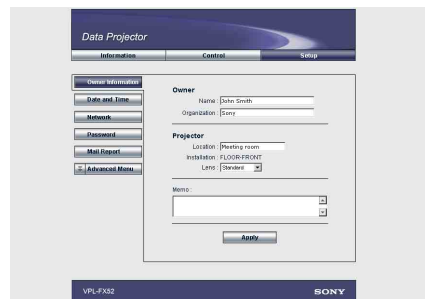

### Owner

Enter owner information.

### Projector

Enter the location and lens type of the projector.

## Memo

Enter a memo, if required.

## Setting the date and time

This setting is required for the Regular Report function.

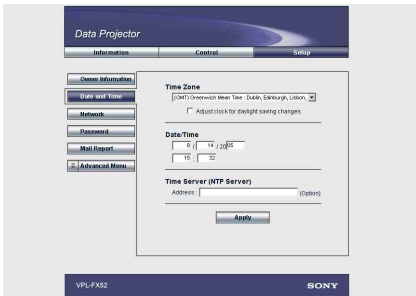

## Time Zone

Select the region in which you are using the projector.

## Date/Time

Set the date and time.

## Time Server

Enter the address of the time server when the time is set by a timer server.

## Network Settings

Enter the information for the network settings.

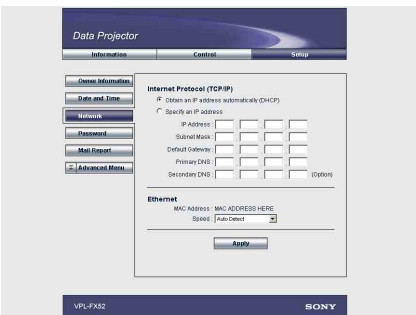

## Internet Protocol (TCP/IP)

Normally, set "Obtain an IP address automatically (DHCP)." If you select "Specify an IP address," set the necessary items.

## Ethernet

Select the communication speed or communication mode from the drop-down list. (Normally set to Auto.)

## Notes

- If the IP address is changed, you will not be able to access the network using an old IP address.
- To reset the settings of an item back to its factory settings, press the RESET, ENTER, ↓ and ENTER keys on the control panel in order within 5 seconds with the power on, and reset the settings depending on the messages displayed on the screen.

## Setting passwords for "Administrator" and "User"

You can set passwords for each "Administrator" and "User." The name of the "Administrator" account is preset to "root" at the factory. It cannot be changed.

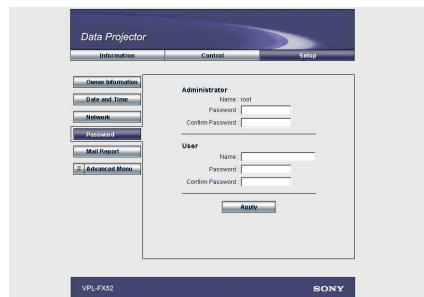

## Notes

- When you change the password, input a new password after deleting the password (\*\*\*\*\*) that was set.
- If you forget your password, consult with qualified Sony personnel.

## Settings for the Mail Report function

You can do the following with the Mail Report function.

- Periodically report the installation status of the projector, owner information, etc. You can specify the transmission days and times of e-mail messages (Regular report).
- Immediately report if any error occurs with the projector (Error Report).
- Send warning e-mail messages when a preset time for use of the projector lamp has been reached (Lamp Reminder).
- Send warning e-mail messages when a preset time for maintenance of the projector has been reached (Maintenance Reminder).

The screenshot shows the 'Data Projector' web interface. The 'Mail Report' section is expanded, showing the following settings:

- Report Timing:**
  - Regular Report: Report Time: All TO2
  - Date to send:  Every Week on Days (Mon, Tue, Wed, Thu, Fri, Sat, Sun)  Every Month on Day
  - Maintenance Report: Lamp Reminder: 9999 hour, Maintenance Reminder: 9999 hour, Elapsed Hours: [field] RESET
- Address:** Table with columns for Email Address, Report, and Timing. Rows for TO1, TO2, CC1, and CC2.
- Mail Form:**  Standard,  Simple
- Mail Account:** Mail Address: [field], Outgoing Mail Server (SMTP): [field], Requires Authentication:  Requires the use of POP Authentication before send email (POP before SMTP):  Incoming Mail Server (POP): [field], Account Name: [field], Password: [field], SMTP Authentication:  Account Name: [field], Password: [field], Send test mail:
- Check the contents of the mail message:**  View
- Apply:** [button]

## Report Timing field

### Regular Report

A report on the present status of the projector, installation status, etc. of the projector is periodically sent by e-mail. Set the timing for sending the e-mail messages as follows:

**AT:** Specify the time when e-mail is to be sent. Select the hour from the drop-down list.

**Every Week on Days:** Select this check box to send e-mail on the selected days every week.

**Mon/Tue/Wed/Thu/Fri/Sat/Sun:** Specify the days of the week when e-mail is to be sent. You can check two or more days.

**Every Month on Day:** Select this check box and select the day from the drop-down list to send e-mail on a pre-defined day every month. The Regular Report contains the product information, owner information, usage information (time) for the projector, lamp mode, memos, etc.

### Maintenance Report

**Lamp Reminder:** Select this check box and enter the limit for the number of hours the projector lamp is to be used in the text box. This information will be used to send e-mail informing you that replacement is required for the projector lamp when the preset time has been reached. You can specify a time between 1 and 9999 hours.

**Maintenance Reminder:** Select this check box and enter the hours of use before maintenance is required for the projector in the text box. You can specify a time between 1 and 99999 hours.

The elapsed time is displayed in the Elapsed Hours text box. Selecting the RESET and clicking "Apply" will reset the elapsed time to zero.

### Address field

### E-mail Address

Enter the e-mail addresses to which you want the e-mail messages to be sent in each text box. The projector allows you to send e-



mail to 4 different addresses. You can enter up to 64 characters for each address.

## Report Timing

**Regular:** Select this check box to arrange the sending of the Regular Report.

**Maintenance:** Select this check box to arrange the sending of an e-mail message that informs you of the number of hours the projector lamp has been used and the time when maintenance is required for the projector.

**Error:** Select this check box to arrange the sending of an error report if any problem occurs with the projector.

### Notes

- Even if days are specified in the Report Timing field, you still must select the Regular check box to receive the Regular Report. If the day preset in “Every Month on Day” does not exist in the month, you will receive the e-mail message on the last day of the month.
- You cannot specify the day of the week or day of the month if “Every Week on Days” or “Every Month on Day” is not selected.

## Mail Form field

Select the e-mail message type from “Standard” or “Simple.”

## Mail Account field

### Mail Address

Type the appropriate e-mail address. You can enter up to 64 characters.

### Outgoing Mail Server (SMTP)

Type the address of the SMTP server. You can enter up to 64 characters.

### Requires Authentication

Select this check box when the authentication is required for sending an e-mail.

### Requires the use of POP Authentication before send e-mail (POP before

SMTP): Select this check box to arrange for POP authentication to be performed before connecting to the SMTP server.

**Incoming Mail Server (POP3):** Type the address of the POP3 server.

**Account Name:** Type the mail account.

**Password:** Type the mail password.

**SMTP Authentication:** Select this check box to arrange for SMTP Authentication to be performed before connecting the SMTP server.

**Account Name:** Type the mail account.

**Password:** Type the mail password.

**Send test mail:** Select the Send check box, then click “Apply” to send an e-mail message as a test to confirm whether it is sent to the specified addresses.

### Notes

If the following items have not been set or are incorrectly set, an error message appears and the test e-mail message is disabled:

- Address in the Address field.
- “Mail Address” and “Outgoing Mail Server (SMTP)” in the Mail Account field.

For details on the mail settings, consult your network administrator.

## Check the contents of the e-mail

The contents of the e-mail message to be sent appear.

## Advanced setting

Click “Advanced Menu” to display the Advertisement button, PJ Talk button and SNMP button. These settings are mainly for administrative use. For details, consult with qualified Sony personnel.

### Note

You cannot use the following characters to enter the characters in the text box: “'”, “ ””, “\”, “&”, “<”, “>”

# Replacing the Lamp

The lamp used as a light source is a consumable product. When the lamp has burnt out or dims, or “Please replace the LAMP.” appears on the screen, replace the lamp with a new one. Use LMP-F300 Projector Lamp as the replacement lamp. The lamp life varies depending on conditions of use.

### Caution

The lamp becomes a high temperature after turning off the projector with the I / ⏻ key. **If you touch the lamp, you may scald your finger. When you replace the lamp, wait for at least an hour for the lamp to cool.**

### Notes

- If the lamp breaks, consult with qualified Sony personnel.
- Pull out the lamp by holding the handle. If you touch the lamp, you may be burned or injured.
- When removing the lamp, make sure it remains horizontal, then pull straight up. Do not tilt the lamp. If you pull out the lamp while tilted and if the lamp is broken, the pieces may scatter, causing injury.
- To erase a message, press any key on the control panel of the projector or on the remote commander.

- 1 Turn off the projector, and disconnect the AC power cord from the AC outlet.

### Note

When replacing the lamp after using the projector, wait for at least an hour for the lamp to cool.

- 2 Place a protective sheet (cloth) beneath the projector. Turn the projector over so you can see its underside.

### Note

Be sure that the projector is stable after turning it over.

- 3 Slide to open the lamp cover by loosening one screw with the Phillips screwdriver.

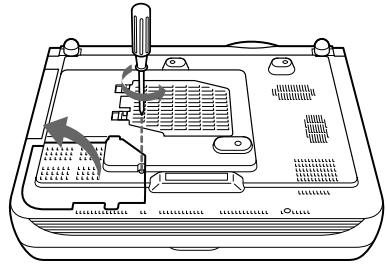

### Note

Be sure not to remove other screws, for safety reasons.

- 4 Loosen two screws on the lamp unit with the Phillips screwdriver.

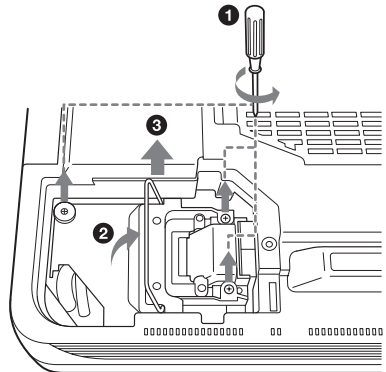

- 5 While holding the handle and keeping the lamp unit horizontal, pull straight up.

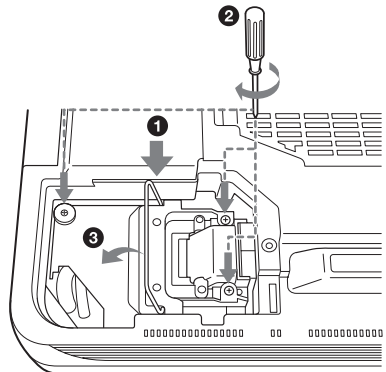

- 6 Insert the new lamp all the way in until it is securely in place. Tighten the two screws. Fold down the handle.

#### Notes

- Be careful not to touch the glass surface of the lamp.
- The power will not turn on if the lamp is not secured properly.
- When attaching the lamp, be careful not to overtighten the screws.

- 7 Close the lamp cover and tighten the screw.

#### Note

Be sure to attach the lamp cover securely as it was. If not, the projector cannot be turned on.

- 8 Turn the projector back over.
- 9 Connect the power cord and turn the projector to standby mode.
- 10 Press the following keys on the control panel in the following sequence for less than five seconds: RESET, ←, →, ENTER.

#### Caution

Do not put your hands into the lamp replacement spot, or not fall any liquid or object into it to avoid electrical shock or fire.

#### Disposal of the used lamp

##### For the customers in the USA

This product contains mercury. Disposal of this product may be regulated if sold in the United States. For disposal or recycling information, please contact your local authorities or Electronics Industries Alliance (<http://www.eiae.org>).

## Cleaning the Air Filter

The air filter should be cleaned whenever you replace the lamp. Remove all traces of dust from the outside of the ventilation holes with a vacuum cleaner. The time needed to clean the air filter will vary depending on the environment and on how the projector is used.

When it becomes difficult to remove the dust from the filter with a vacuum cleaner, remove the air filter and clean it.

- 1 Turn off the power and unplug the power cord.
- 2 Place a protective sheet (cloth) beneath the projector. Turn the projector over so you can see its underside.
- 3 Slide the air filter cover in the direction of the arrow and remove it.

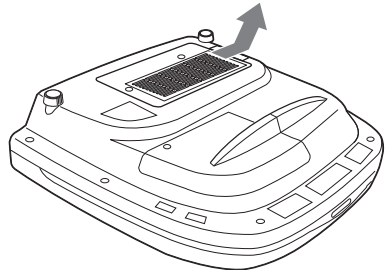

- 4 Remove the air filter from the 6 tabs of the air filter cover.

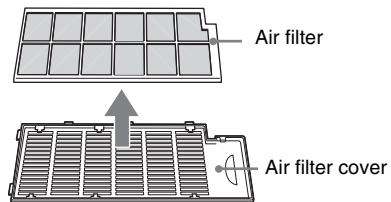

- 5 Clean the air filter with a vacume cleaner.
- 6 Insert in order of the air filter and the sheet into the six tabs of the air filter cover, and then attach the air filter cover to the projector.

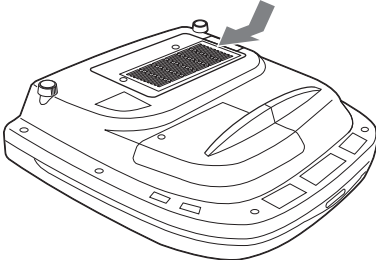

#### Notes

- If you neglect to clean the air filter, dust may accumulate, clogging it. As a result, the temperature may rise inside the unit, leading to a possible malfunction or fire.
- If the dust cannot be removed from the air filter, replace the air filter with the supplied new one.
- Be sure to attach the air filter cover firmly; the power will not be turned on if it is not closed securely.

# Troubleshooting

If the projector appears to be operating erratically, try to diagnose and correct the problem using the following instructions. If the problem persists, consult with qualified Sony personnel.

## Power

Symptom	Cause and Remedy
The power is not turned on.	<ul style="list-style-type: none"> <li>• The power has been turned off and on with the I / ⏻ key at a short interval. → Wait for about 40 seconds before turning on the power (see page 27).</li> <li>• The lamp cover is detached. → Close the lamp cover securely (see page 42).</li> <li>• The air filter cover is detached. → Close the air filter cover securely (see page 43).</li> </ul>
Both the LAMP/COVER and TEMP/FAN indicators light up.	<ul style="list-style-type: none"> <li>• The electrical system breaks down. → Consult with qualified Sony personnel.</li> </ul>

## Picture

Symptom	Cause and Remedy
No picture.	<ul style="list-style-type: none"> <li>• Cable is disconnected or the connections are wrong. → Check that the proper connections have been made (see page 18).</li> <li>• Input selection is incorrect. → Select the input source correctly using the INPUT key (see page 24).</li> <li>• The picture is muting. → Press the PIC MUTING key to release the muting function (see page 25).</li> <li>• The computer signal is not set to output to an external monitor or set to output both to an external monitor and a LCD monitor of a computer. → Set the computer signal to output <b>only</b> to an external monitor. → Depending on the type of your computer, for example a notebook, or an all-in-one LCD type, you may have to switch the computer to output to the projector by pressing certain keys or by changing your computer's settings. For details, refer to the computer's operating instructions supplied with your computer.</li> <li>• The signal is input from the computer to the INPUT C connector. → Confirm the setting of the DDC function of your computer (see page 18).</li> </ul>
The picture is noisy.	<ul style="list-style-type: none"> <li>• Noise may appear on the background depending on the combination of the numbers of dot input from the connector and numbers of pixel on the LCD panel. → Change the desktop pattern on the connected computer.</li> </ul>

Symptom	Cause and Remedy
The picture from INPUT C connector is colored strange.	<ul style="list-style-type: none"> <li>• Setting for Input-C Signal Sel. in the SET SETTING menu is incorrect.</li> <li>→ Select Computer, Video GBR or Component for Input-C Signal Sel. in the SET SETTING menu according to the input signal (see page 34).</li> </ul>
“Please check INPUT-C setting.” appears in spite of inputting the correct signal from INPUT C.	<ul style="list-style-type: none"> <li>• Setting for Input-C Signal Sel. in the SET SETTING menu is incorrect.</li> <li>→ Select Computer, Video GBR or Component for Input-C Signal Sel. in the SET SETTING menu according to the input signal (see page 34).</li> </ul>
On-screen display does not appear.	<ul style="list-style-type: none"> <li>• Status in the MENU SETTING menu has been set to Off.</li> <li>→ Set Status in the MENU SETTING menu to On (see page 35).</li> </ul>
Color balance is incorrect.	<ul style="list-style-type: none"> <li>• Picture has not been adjusted properly.</li> <li>→ Adjust the picture (see page 31).</li> <li>• Projector is set to wrong color system.</li> <li>→ Set Color System in the SET SETTING menu to match the color system being input (see page 34).</li> </ul>
The picture is too dark.	<ul style="list-style-type: none"> <li>• Contrast or Brightness has not been adjusted properly.</li> <li>→ Adjust the Contrast or Brightness in the PICTURE SETTING menu properly (see page 31).</li> <li>• The lamp has burnt or dims.</li> <li>→ Replace the lamp with a new one (see page 42).</li> </ul>
The picture is not clear.	<ul style="list-style-type: none"> <li>• Picture is out of focus.</li> <li>→ Adjust the focus (see page 24).</li> <li>• Condensation has occurred on the lens.</li> <li>→ Leave the projector for about two hours with the power on.</li> </ul>
The image extends beyond the screen.	<ul style="list-style-type: none"> <li>• The APA key is pressed although there are black edges around the image.</li> <li>→ Display the full image on the screen and press the APA key.</li> <li>→ Adjust Shift in the INPUT SETTING menu properly (see page 33).</li> </ul>
The picture flickers.	<ul style="list-style-type: none"> <li>• Dot Phase in the INPUT SETTING menu has not been adjusted properly.</li> <li>→ Adjust Dot Phase in the INPUT SETTING menu properly (page 33).</li> </ul>

## Remote Commander

Symptom	Cause and Remedy
The Remote Commander does not work.	<ul style="list-style-type: none"> <li>• The Remote Commander batteries are dead.</li> <li>→ Replace with a new battery (see page 16).</li> </ul>
The menu display does not appear even when you press the MENU key on the Remote Commander.	<ul style="list-style-type: none"> <li>• The PJ/NETWORK select switch on the Remote Commander is set to NETWORK.</li> <li>→ Set the PJ/NETWORK select switch to PJ, then press the MENU key.</li> </ul>

## Indicators

Symptom	Cause and Remedy
The LAMP/COVER indicator flashes.	<ul style="list-style-type: none"> <li>The lamp cover or the air filter cover is detached. → Attach the cover securely (see page 42).</li> </ul>
The LAMP/COVER indicator lights up.	<ul style="list-style-type: none"> <li>The lamp has reached the end of its life. → Replace the lamp (see page 42).</li> <li>The lamp becomes a high temperature. → Wait for 120 seconds to cool down the lamp and turn on the power again (see page 27).</li> <li>The electrical system breaks down. → Consult with qualified Sony personnel.</li> </ul>
The TEMP/FAN indicator flashes.	<ul style="list-style-type: none"> <li>The fan is broken. → Consult with qualified Sony personnel.</li> </ul>
The TEMP/FAN indicator lights up.	<ul style="list-style-type: none"> <li>The internal temperature is unusually high. → Check to see if nothing is blocking the ventilation holes.</li> </ul>
Both the LAMP/COVER and TEMP/FAN indicators light up.	<ul style="list-style-type: none"> <li>The electrical system breaks down. → Consult with qualified Sony personnel.</li> </ul>

## Messages List

### Warning Messages

Use the list below to check the meaning of the messages displayed on the screen.

Message	Meaning and Remedy
High temp.! Lamp off in 1 min.	<ul style="list-style-type: none"> <li>Internal temperature is too high. → Turn off the power. → Check to see if nothing is blocking the ventilation holes.</li> </ul>
Frequency is out of range!	<ul style="list-style-type: none"> <li>This input signal cannot be projected as the frequency is out of the acceptable range of the projector. → Input a signal that is within the range of the frequency.</li> <li>The resolution setting of the output signal of a computer is too high. → Set the setting of output to XGA (see page 18).</li> </ul>
Please check INPUT-C setting.	<ul style="list-style-type: none"> <li>You have input RGB signal from the computer when Input-C Signal Sel. in the SET SETTING menu is set to Component. → Set Input-C Signal Sel. correctly (see page 34).</li> </ul>
Please replace the LAMP.	<ul style="list-style-type: none"> <li>It is time to replace the lamp. → Replace the lamp.</li> <li>To erase a message → Press any key on the control panel of the projector or on the remote commander.</li> <li>If this message appears again after you replace the lamp, the lamp replacement process is not complete. → Perform the operations in steps 9 and 10 on page 43.</li> </ul>

## Caution Messages

Use the list below to check the meaning of the messages displayed on the screen.

<b>Message</b>	<b>Meaning and Remedy</b>
No Input	<ul style="list-style-type: none"><li>• No input signal → Check connections (see page 18).</li></ul>
Not applicable!	<ul style="list-style-type: none"><li>• You have pressed the wrong key. → Press the appropriate key.</li></ul>



# Specifications

## Optical characteristics

Projection system	3 LCD panels, 1 lens, 3 primary color shutter system
LCD panel	1.3-inch TFT SONY LCD panel with micro-lens array 2,359,296 pixels (1,024 × 768 pixels × 3)
Lens	1.3 times zoom lens (powered) f 50.8 to 64.0 mm/F 1.7 to 2.0 * The lens for VPL-FX52L are not supplied.
Lamp	300 W
Projection picture size	Range: 40 to 300 inches (diagonal measure)
Light output	ANSI lumen <sup>1)</sup> 6,000 lm
Projecting distance (Floor Installation) of VPL-FX52 (with standard lens)	40-inches: 1490 to 1820 mm (4.9 to 6 feet) 60-inches: 2280 to 2780 mm (7.5 to 9.1 feet) 80-inches: 3060 to 3740 mm (10.0 to 12.3 feet) 100-inches: 3850 to 4700 mm (12.6 to 15.4 feet) 120-inches: 4630 to 5660 mm (15.1 to 18.6 feet) 150-inches: 5810 to 7100 mm (19.1 to 23.3 feet) 180-inches: 6980 to 8540 mm (22.9 to 28.0 feet) 200-inches: 7770 to 9500 mm (25.5 to 31.2 feet) 250-inches: 9730 to 11900 mm (32 to 39.0 feet) 300-inches: 11690 to 14300 mm (38.4 to 46.9 feet)

1) ANSI lumen is a measuring method of American National Standard IT 7.228.

## Electrical characteristics

Color system	NTSC <sub>3.58</sub> /PAL/SECAM/ NTSC <sub>4.43</sub> /PAL-M/PAL-N system, switched automatically/ manually
Resolution	750 horizontal TV lines (Video input) 1,024 × 768 dots (RGB input)
Acceptable computer signals <sup>1)</sup>	fH: 19 to 92 kHz

fV: 48 to 92 Hz  
(Maximum input resolution signals: UXGA 1,600 × 1,200 fH: 75kHz, fV: 60Hz)

- 1) Set the resolution and the frequency of the signal of the connected computer within the range of acceptable preset signals of the projector.

Compatible video signal  
15k RGB 50/60Hz,  
Progressive Component 50/60Hz  
DTV (480/60I, 575/50I, 1,080/60I, 480/60P, 575/50P, 1,080/50I, 720/60P, 720/50P, 540/60P), Composite video, Y/C video

## Input/Output

### VIDEO INPUT

VIDEO: BNC type  
Composite video: 1 V<sub>p-p</sub> ±2 dB sync negative (75 ohms terminated)  
S VIDEO: Y/C mini DIN 4-pin type  
Y (luminance): 1 V<sub>p-p</sub> ±2 dB sync negative (75 ohms terminated)  
C (chrominance): burst 0.286 V<sub>p-p</sub> ±2 dB (NTSC) (75 ohms terminated), burst 0.3 V<sub>p-p</sub> ±2 dB (PAL) (75 ohms terminated)

VIDEO OUT VIDEO: Loop-through BNC type  
Loop-through output from the VIDEO IN connector  
S VIDEO: Loop-through mini DIN 4-pin type (male)  
Loop-through output from the S VIDEO IN connector

INPUT A Analog RGB: HD D-sub15-pin (female)  
R: 0.7 V<sub>p-p</sub> ±2 dB (75 ohms terminated)  
G: 0.7 V<sub>p-p</sub> ±2 dB (75 ohms terminated)  
G with sync: 1 V<sub>p-p</sub> ±2 dB sync negative (75 ohms terminated)  
B: 0.7 V<sub>p-p</sub> ±2 dB (75 ohms terminated)  
SYNC/HD:  
Composite sync input: 1-5 V<sub>p-p</sub> high impedance, positive/negative  
Horizontal sync input: 1-5 V<sub>p-p</sub> high impedance, positive/negative

	VD: Vertical sync input: 1-5 Vp-p high impedance, positive/ negative	VPL-FX52L: 480 × 169 × 464 mm (19 × 6 <sup>5</sup> / <sub>8</sub> × 18 <sup>3</sup> / <sub>8</sub> inches) (w/h/d) (with the projection parts)
INPUT B	Digital RGB: DVI-D (TM-DS)	Mass
INPUT C	Analog RGB/component: 5BNC (female) R/R-Y: 0.7 Vp-p ±2 dB (75 ohms terminated) G: 0.7 Vp-p ±2 dB (75 ohms terminated) G with sync/Y: 1 Vp-p ±2 dB sync negative (75 ohms terminated) B/B-Y: 0.7 Vp-p ±2 dB (75 ohms terminated) SYNC/HD: Composite sync input: 1-5 Vp-p high impedance, positive/ negative Horizontal sync input: 1-5 Vp-p high impedance, positive/ negative VD: Vertical sync input: 1-5 Vp-p high impedance, positive/ negative	VPL-FX52: Approx. 10.5 kg (23 lb 4 oz) VPL-FX52L: Approx. 9.1 kg (20 lb 1 oz)
MONITOR OUT	HD D-sub 15-pin (female) R, G, B: Gain Unity: 75 ohms SYNC/HD, VD: 4 Vp-p (open), 1 Vp-p (75 ohms) *DIGITAL RGB signal is not output from MONITOR OUT terminal.	Power requirements AC 100 to 240 V, 4.0 A - 1.6 A, 50/60 Hz
TRIG	Minijack Power on: 12 V DC, output impedance: 4.7 kilohms Power off: 0 V	Power consumption Max. 400 W in standby mode: 7 W (when network function is operating)
RS-232C	D-sub 9 pin (female)	Heat dissipation 1,365 BTU
CONTROL S IN/PLUG IN		Operating temperature 0°C to 35°C (32°F to 95°F)
POWER	Stereo minijack, 5 Vp-p, plug-in power 5 V DC	Operating humidity 35% to 85% (no condensation)
NETWORK	RJ-45: 10BASE-T/100BASE-TX Safety regulations UL60950, cUL (CSA No. 60950), FCC Class A, IC Class A, NEMKO (EN60950), CE (LVD, EMC), C-Tick	Storage temperature -20°C to 60°C (-4°F to 140°F)
		Storage humidity 10% to 90%
		Supplied accessories Remote Commander (1) Size AA (R6) batteries (2) Lens cap (1) (for VPL-FX52 with standard lens only) AC power cord (1) Air filter (for replacement) (one pair of filters) Operating Instructions, Installation Manual for Dealers (CD-ROM) (1) Quick Reference Manual (1) Safety Regulations (1) Security Label (1) Warranty Card (1)

Design and specifications are subject to change without notice.

---

## Optional accessories

- Projector Lamp  
LMP-F300 (for replacement)
- Projector Suspension Support  
PSS-620
- Signal Interface Cable  
SIC10 (5 × BNC (male) ↔ 5 ×  
BNC (male))
- Projection Lens  
Long focus zoom lens VPLL-ZM101  
F = 2.0  
f = 89 to 133.5 mm  
Manual focus/zoom

---

## General

Dimensions VPL-FX52: 480 × 169 × 502 mm  
(19 × 6 <sup>5</sup>/<sub>8</sub> × 19 <sup>7</sup>/<sub>8</sub> inches)  
(w/h/d) (with the projection  
parts)

Projection screen size  
40 to 300 inches  
Projection distance  
100 inches: 6810 to 10030 mm  
200 inches: 13840 to 20270 mm  
300 inches: 20870 to 30500 mm  
Maximum external dimensions  
100 × 100 × 222 mm (W × H × D)  
Weight  
1810 g

Fixed short focus lens VPLL-FM21  
(for rear projection (Optical Axis Angle: 0 degree))  
F = 2.0  
f = 24.5 mm  
Manual focus

Projection screen size  
40 to 300 inches  
Projection distance  
100 inches: 1800 mm  
200 inches: 3690 mm  
300 inches: 5580 mm  
Maximum external dimensions  
140 × 140 × 233 mm (W × H × D)  
Weight  
1850 g

Short focus zoom lens VPLL-ZM31  
F = 1.9  
f = 41.4 to 45.6 mm  
Manual focus/zoom

Projection screen size  
40 to 300 inches  
Projection distance  
100 inches: 3150 to 3300 mm  
200 inches: 6410 to 6710 mm  
300 inches: 9680 to 10120 mm  
Maximum external dimensions  
154 × 154 × 252 mm (W × H × D)  
Weight  
3140 g

*Some of the items may not be available in some areas. For details, please consult your nearest Sony office.*

## Pin assignment

### INPUT A connector RGB input connector (HD D-sub 15-pin, female)

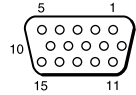

1	R/R-Y	9	N.C.
2	G/Y	10	GND
3	B/B-Y	11	GND
4	GND	12	DDC/SDA
5	GND	13	HD/C.Sync
6	GND (R)	14	VD
7	GND (G)	15	DDC/SCL
8	GND (B)		

### RS-232C connector (D-sub 9-pin, female)

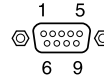

1	DCD	6	DSR
2	RXDA	7	RTS
3	TXDA	8	CTS
4	DTR	9	RI
5	GND		

### Input B connector DVI connector (DVI-D, female)

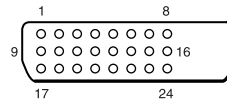

1	T.M.D.S. Data2 -	14	+5 V Power
2	T.M.D.S. Data2 +	15	Ground (return for +5 V, HSync, and Vsync)

Others

3	T.M.D.S. Data2/4 Shield	16	Hot Plug Detect
4	T.M.D.S. Data4 -	17	T.M.D.S. Data0 -
5	T.M.D.S. Data4 +	18	T.M.D.S. Data0 +
6	DDC Clock	19	T.M.D.S. Data0/5 Shield
7	DDC Data	20	T.M.D.S. Data5 -
8	Analog Vertical Sync	21	T.M.D.S. Data5 +
9	T.M.D.S. Data1 -	22	T.M.D.S. Clock Shield
10	T.M.D.S. Data1 +	23	T.M.D.S. Clock +
11	T.M.D.S. Data1/3 Shield	24	T.M.D.S. Clock -
12	T.M.D.S. Data3 -		
13	T.M.D.S. Data3 +		

## Input signals and adjustable/ setting items

### PICTURE SETTING menu

Item	Input signal			
	Video or S video (Y/C)	Com- ponent	Video GBR	Com- puter
Contrast	●	●	●	●
Brightness	●	●	●	●
Color	● (excluding monochrome signal)	●	●	-
Hue	● (NTSC 3.58/4.43 only) (excluding monochrome signal)	●	●	-
Sharpness	●	●	●	-
RGB Enhancer	-	-	-	●

Item	Input signal			
	Video or S video (Y/C)	Com- ponent	Video GBR	Com- puter
Black Level Adj.	●	●	●	-
Gamma Mode	-	-	-	●
Color Temp	●	●	●	●
DDE	●	● (480/ 60i, 575/ 50i)	● (480/ 60i, 575/ 50i)	-

● : Adjustable/can be set

- : Not adjustable/cannot be set

### INPUT SETTING menu

Item	Input signal			
	Video or S video (Y/C)	Com- ponent	Video GBR	Com- puter
Dot Phase	-	-	-	●
H Size	-	● (for other than a 15 kHz signal)	● (for other than a 15 kHz signal)	●
Shift	-	● (for other than a 15 kHz signal)	● (for other than a 15 kHz signal)	●
Scan Conv	-	-	-	● (lower than SVGA)
Wide Mode	●	●	●	-

● : Adjustable/can be set

- : Not adjustable/cannot be set

## Preset signals

Memory No.	Preset signal		fH (kHz)	fV (Hz)	Sync	SIZE
1	Video 60 Hz		15.734	59.940	H-neg, V-neg	/
2	Video 50 Hz		15.625	50.000	H-neg, V-neg	
3	15k RGB/Component 60 Hz		15.734	59.940	S on G/Y or Composite sync	
4	15k RGB/Component 50 Hz		15.625	50.000		
5	HDTV		33.750	60.000		
6*	640 × 350	VGA mode 1	31.469	70.086	H-pos, V-neg	800
7*		VGA VESA 85 Hz	37.861	85.080	H-pos, V-neg	832
8*	640 × 400	PC-9801 Normal	24.823	56.416	H-neg, V-neg	848
9*		VGA mode 2	31.469	70.086	H-neg, V-pos	800
10*		VGA VESA 85 Hz	37.861	85.080	H-neg, V-pos	832
11*	640 × 480	VGA mode 3	31.469	59.940	H-neg, V-neg	800
12*		Macintosh 13"	35.000	66.667	H-neg, V-neg	864
13*		VGA VESA 72 Hz	37.861	72.809	H-neg, V-neg	832
14*		VGA VESA 75 Hz	37.500	75.000	H-neg, V-neg	840
15*		VGA VESA 85 Hz	43.269	85.008	H-neg, V-neg	832
16*	800 × 600	SVGA VESA 56 Hz	35.156	56.250	H-pos, V-pos	1,024
17*		SVGA VESA 60 Hz	37.879	60.317	H-pos, V-pos	1,056
18*		SVGA VESA 72 Hz	48.077	72.188	H-pos, V-pos	1,040
19*		SVGA VESA 75 Hz	46.875	75.000	H-pos, V-pos	1,056
20*		SVGA VESA 85 Hz	53.674	85.061	H-pos, V-pos	1,048
21*	832 × 624	Macintosh 16"	49.724	74.550	H-neg, V-neg	1,152
22*	1,024 × 768	XGA VESA 43 Hz	35.524	86.958	H-pos, V-pos	1,264
23*		XGA VESA 60 Hz	48.363	60.004	H-neg, V-neg	1,344
24*		XGA VESA 70 Hz	56.476	69.955	H-neg, V-neg	1,328
25*		XGA VESA 75 Hz	60.023	75.029	H-pos, V-pos	1,312
26*		XGA VESA 85 Hz	68.677	84.997	H-pos, V-pos	1,376
27*	1,152 × 864	SXGA VESA 70 Hz	63.995	70.019	H-pos, V-pos	1,472
28		SXGA VESA 75 Hz	67.500	75.000	H-pos, V-pos	1,600
29		SXGA VESA 85 Hz	77.487	85.057	H-pos, V-pos	1,568
30*	1,152 × 900	Sunmicro LO	61.795	65.960	H-neg, V-neg	1,504
31		Sunmicro HI	71.713	76.047	Composite sync	1,472
32*	1,280 × 960	SXGA VESA 60 Hz	60.000	60.000	H-pos, V-pos	1,800
33		SXGA VESA 75 Hz	75.000	75.000	H-pos, V-pos	1,728

Others

Memory No.	Preset signal		fH (kHz)	fV (Hz)	Sync	SIZE
34*	1,280 × 1,024	SXGA VESA 43 Hz	46.433	86.872	H-pos, V-pos	1,696
35		SGI-5	53.316	50.062	S on G	1,680
36*		SXGA VESA 60 Hz	63.974	60.013	H-pos, V-pos	1,696
37		SXGA VESA 75 Hz	79.976	75.025	H-pos, V-pos	1,688
38		SXGA VESA 85 Hz	91.146	85.024	H-pos, V-pos	1,728
39	1,600 × 1,200	UXGA VESA 60 Hz	75.000	60.000	H-pos, V-pos	2,160
43	480/60P	480/60P (Double frequency NTSC)	31.470	60.000	S on G	
44	575/50P	575/50P (Double frequency PAL)	31.250	50.000	S on G	
45	1,080/50I	1,080/50I	28.130	50.000		
47	720/60P	720/60P	45.000	60.000		
48	720/50P	720/50P	37.500	50.000		
50	540/60P	540/60P	33.750	60.000		
52	1,400 × 1,050	SXGA+	63.981	60.020	H-neg, V-neg	1,688

\* Digital input is supported for the signals marked with an asterisk. Those signals from No. 6 to No. 39 that are not marked with an asterisk are automatically output in accordance with the projector specifications.

#### Notes

- When a signal other than the preset signals shown above is input, the picture may not appear properly.
- Memory numbers 22 and 34 are interlace signals.
- When an SXGA+ signal is input, the image may extend beyond the edge of the screen. In this event, input a signal in which the image is not surrounded by a black area, and then unplug and then plug back in the connecting cable, or else press the INPUT key and select the input signal again.

## Warning on power connection

Use the supplied power cord when you use the projector in your country/region. Otherwise, use a proper power cord meeting the following specification.

	The United States, Canada		Continental Europe		UK, Ireland, Australia, New Zealand	Japan
Plug type	VM0233	290B	YP-12A	COX-07	_1)	YP332
Female end	VM0089	386A	YC-13B	COX-02	VM0310B	YC-13
Cord type	SJT	SJT	H05VV-F	H05VV-F	N13237/CO-228	VCTF
Rated Voltage & Current	10A/125V	10A/125V	10A/250V	10A/250V	10A/250V	7A/125V
Safety approval	UL/CSA	UL/CSA	VDE	VDE	VDE	DENAN
Cord length (max.)	4.5 m (177 1/4 inches)		-			

<sup>1)</sup> Use the correct plug for your country/region.

Others

# Index

## Numerics

5BNC input connectors ... 13

## A

Adjust Signal... .. 33

Adjuster ..... 11

Adjusting

    memory of the settings 30

    the picture ..... 25, 30

    the picture size/shift ... 33

Air filter ..... 43

APA (Auto Pixel

    Alignment) key ..... 12

Auto Input Search ..... 34

## B

Background ..... 35

Battery installation ..... 16

Black Level Adj. .... 31

Brightness ..... 31

## C

Color ..... 31

Color System ..... 34

Color Temp. .... 31

Connections

    computer or VCR ..... 18

    video GBR/Component

        equipment ..... 20

Contrast ..... 31

## D

DDE (Dynamic Detail

    Enhancer) ..... 32

Digital Zoom function .... 28

Direct Power On ..... 36

Direct Power On/Off ..... 36

Dot Phase ..... 33

## F

fH (Horizontal

    Frequency) ..... 36

fV (Vertical Frequency) . 36

## G

Gamma Mode ..... 31

## H

H Size ..... 33

High Altitude Mode ..... 36

Hue ..... 31

## I

Image Flip ..... 35

INPUT A connector ..... 13

INPUT B connector (RGB

    (DVI)) ..... 13

INPUT C connector ..... 13

INPUT SETTING Menu 32

Input-C Signal Sel. .... 34

INSTALL SETTING

    Menu ..... 35

Installation examples .... 17

    unsuitable conditions ... 8

    unsuitable installation .. 7

IP Address ..... 36

IR Receiver ..... 34

## L

Lamp Mode ..... 36

Lamp Timer ..... 36

Language ..... 35

Lens Control ..... 36

Location and function of

    controls

    connector panel ..... 13

    control panel ..... 11

    front ..... 10

    rear/bottom ..... 10

## M

Menu

    clearing the menu

        display ..... 30

    INFORMATION

        menu ..... 36

    INPUT SETTING

        menu ..... 32

    INSTALL SETTING

        menu ..... 35

    MENU SETTING

        menu ..... 35

    PICTURE SETTING

        menu ..... 30

    SET SETTING menu . 34

    Menu Color ..... 35

    Menu Position ..... 35

    Message

        caution ..... 48

        warning ..... 47

## N

NETWORK connector ... 13

## O

Optional accessories ..... 50

## P

Picture Mode ..... 30

PICTURE SETTING

    Menu ..... 30

Pin assignment ..... 51

    DVI connector ..... 51

    RGB input connector . 51

    RS-232C connector .... 51

Power

    Turn on ..... 23

Power Saving ..... 34

Projecting ..... 23

## R

Remote Commander ..... 14

Remote control detector

    front ..... 10

    rear ..... 10

Replacing the Lamp ..... 42

Reset

    resettable items ..... 30

    resetting the item ..... 30

RGB Enhancer ..... 31

## S

Scan Converter ..... 33

Screen size ..... 17, 49

Security Lock ..... 36

Selecting the Menu

    Language ..... 21

SET SETTING Menu .... 34

Sharpness ..... 31

Shift ..... 33

Smart APA ..... 34

Specifications ..... 49

Status ..... 35

Subnet Mask ..... 36



Supplied accessories .....50

**T**

Test Pattern .....35

Troubleshooting .....45

**U**

Using the MENU .....29

**V**

V Keystone .....35

Ventilation holes

  exhaust .....10

  intake .....10

**W**

Wide Mode .....32



Other

