

Live Content Producer

Operating Instructions

Software Version 1.30

ANYCAST STATION



AWS-G500

Table of Contents

Usage Notes	9
-------------------	---

Chapter 1 Overview

Features of This System	11
Example Applications	13
Names and Functions of Parts	15
Front Panel.....	15
Rear Panel.....	19
Side Panel	23
Other Parts	24
Operation Screen	25
Menu Operations	30
Operation screen (Text Typing Tool Software)	33

Chapter 2 Preparations

Installation/Default Settings	41
Installing the Unit	41
Fitting a Keyboard	42
Starting and Closing Down the Unit	44
Selecting the Keyboard Language.....	46
Setting the Time Zone	46
Setting the Date and Time	47
Adjusting the Display Brightness.....	47
Selecting the Video Output Signal Format.....	48
Connections	49
Connecting a Camera with VISCA Support.....	50
Connecting a Microphone	50
Connecting a Computer (RGB Input).....	51
Connecting a Camcorder	51
Connecting a VCR.....	52
Connecting an External Hard Disk.....	52
Connecting a Plasma Display/Projector/Monitor.....	53
Connecting an Amplifier	54
Preventing Accidental Cable Disconnection	54
Installing Option Modules	55
Settings Related to Input Signals	56
Relation Between Input Signals and System Components...	56
Video Signal Related Settings	57
Audio Signal Related Settings.....	59
Relation Between Program Output Display and Input and Output Formats	63

Chapter 3 Operations

Video Switching	65
Basic Basics of Video Switching	65
Basic Changing the Video with a Cut	66
Basic Changing the Video with a Effect Transition.....	68
Changing the Transition Time.....	72
Changing the Effect Pattern.....	73
Using Picture-in-Picture (PinP) for Combining Videos	73
Adjusting the Picture-in-Picture (PinP).....	75
Using Fade-to-Black (FTB).....	77
Using Color Bars and Color Mattes	78
Basic Using the Downstream Key (DSK) Function to Add Text or an Image	78
Showing a Logo on the Screen.....	82
Using Luminance Keying.....	84
Adjusting the Combined Video	86
Cropping Unwanted Portions From the Video Being Combined.....	87
Applying Edge Effects	87
Checking the Results of Combining Videos (Effect Preview).....	88
Giving Priority to Displaying the PVW Viewer.....	90
Creating a Title Graphic with the Text Typing Tool	91
Features of the Text Typing Tool Software	91
Flow of Operations	92
Starting Up.....	94
Closing Down	95
Standard Operations	95
File Operations	98
Working on Text Objects	104
Working on Line Objects	111
Shadow Operations.....	113
Background Color Operations (Creating Telop and Flip) ..	115
Color Operations	118
Object Layout	122
Adding and Deleting Sheets	125
Simulating the Keying Effects.....	125
Key Combination in the Anycast Station Main Software ..	127
Importing a Font File.....	129
Deleting a Font File	130
Controlling Cameras	132
Registering Cameras to be Controlled.....	132
Controlling Camera Manually	133
Storing a Camera Preset	134
Setting the Camera Control	137
Resetting the Camera.....	138
About Camera Tallies.....	139
Audio Mixing	141

Recording Video and Audio on an External Device	142
Recording Program Output on a VCR.....	142
Recording Inputs on an External Hard Disk.....	144
Operations on Files on the External Hard Disk.....	147
Disconnecting the External Hard Disk.....	150
Recovering an External Hard Disk.....	151
Using a Computer to Play Files Recorded on an External Hard Disk	153
Using the Intercom Function	154
Connecting the Intercom System.....	154
Speaking on the Intercom System	155
Monitoring Audio	156
Determining the Audio Signal Output Destinations.....	156
Displaying the Audio Signal Output Destinations	157
Monitoring Output Audio.....	158
Monitoring the Audio of a Particular Channel Only	159
Video/Audio Signal Adjustments and Settings	160
Adjusting Analog Video Input Signals.....	160
Making the Gradation of SDI Input Signals Appear Smooth (When Using the Serial Digital Interface Module).....	161
Adjusting the Clock Phase of RGB Signals	161
Adjusting Color Matte.....	161
Applying an Offset to the Program Output Video.....	162
Setting the RGB Output Signal Format.....	162
Applying Filters to the Program Output Video	163
Adjusting the Audio Input Signal Levels	164
Cutting High Frequency or Low Frequency.....	164
Adjusting the Equalizer	165
Using the Limiter or Compressor	166
Adjusting the Audio Left and Right Channel Balance	166
Adjusting the Output Levels for Each Destination.....	166
If the Output Video Is Delayed with Respect to the Audio	167
Adjusting the Output Using the Oscillator Signal.....	168
Saving and Loading Various Settings	170
Storable Data	170
Saving Various Settings Data.....	171
Loading Various Saved Settings Data.....	171
Deleting Various Saved Settings Data	172
Exporting Various Settings Data	173
Importing Various Settings Data	174
Importing and Deleting Files	175
Importable Files.....	175
Importing Graphics Files	175
Importing Logo Files	176
Deleting Files.....	177
Checking the Internal Hard Disk Remaining Capacity	178
Formatting an External Hard Disk	179
Formatting a “Memory Stick”	181

Formatting a USB Flash Memory	183
Streaming	185
What Is Streaming?	185
Configuring the Network Settings.....	186
Setting Live Streaming Transmission	188
Starting and Stopping Streaming.....	195
Settings Required for Viewing Streaming.....	195
Placing Streaming Links in a Web Site.....	197

Chapter 4 Appendix

Maintenance	199
Checking the Operating Software Version.....	199
Upgrading the Operating Software.....	200
Messages	203
Message Structure	203
List of Messages	205
Troubleshooting	211
“Memory Stick” Media	215
Notes on using “Memory Stick” media.....	215
About data.....	215
Notes on using “Memory Stick Duo”.....	215
Notes on using the Memory Select function.....	215
Specifications	216
Dimensions	219
Glossary	220
Index	223

Owner's Record

The model and serial numbers are located at the bottom.

Record these numbers in the spaces provided below. Refer to them whenever you call upon your Sony dealer regarding this product.

Model No. _____ Serial No. _____

WARNING

To reduce the risk of fire or electric shock, do not expose the unit to rain or moisture.

To avoid electrical shock, do not open the cabinet. Refer servicing to qualified personnel only.

THIS APPARATUS MUST BE EARTHED.

WARNUNG

Um Feuergefahr und die Gefahr eines elektrischen Schlages zu vermeiden, darf das Gerät weder Regen noch Feuchtigkeit ausgesetzt werden.

Um einen elektrischen Schlag zu vermeiden, darf das Gehäuse nicht geöffnet werden. Überlassen Sie Wartungsarbeiten stets nur qualifiziertem Fachpersonal.

DIESES GERÄT MUSS GEERDET WERDEN.

AVERTISSEMENT

Afin d'éviter tout risque d'incendie ou d'électrocution, ne pas exposer cet appareil à la pluie ou à l'humidité.

Afin d'écarter tout risque d'électrocution, garder le coffret

fermé. Ne confier l'entretien de l'appareil qu'à un personnel qualifié.

CET APPAREIL DOIT ÊTRE RELIÉ À LA TERRE.

WARNING

This unit has no power switch.

When installing the unit, incorporate a readily accessible disconnect device in the fixed wiring, or connect the power cord to a socket-outlet which must be provided near the unit and easily accessible.

If a fault should occur during operation of the unit, operate the disconnect device to which the power supply off, or disconnect the power cords.

WARNUNG

Dieses Gerät hat keinen Netzschalter.

Beim Einbau des Geräts ist daher im Festkabel ein leicht zugänglicher Unterbrecher einzufügen, oder das Netzkabel muß mit einer in der Nähe des Geräts befindlichen, leicht zugänglichen Wandsieckdose verbunden werden.

Wenn während des Betriebs eine

Funktionsstörung auftritt, ist der Unterbrecher zu betätigen bzw. das Netzkabel abzuziehen, damit die Stromversorgung zum Gerät unterbrochen wird.

AVERTISSEMENT

Cet appareil ne possède pas d'interrupteur d'alimentation.

Lors de l'installation de l'appareil, incorporer un dispositif de coupe dans le cablage fixe ou brancher le cordon d'alimentation dans une prise murale proche de l'appareil et facilement accessible.

En cas de problème lors du fonctionnement de l'appareil, enclencher le dispositif de coupe d'alimentation ou débrancher le cordon de la prise.

WARNING: THIS WARNING IS APPLICABLE FOR USA ONLY.

If used in USA, use the UL LISTED power cord specified below.

DO NOT USE ANY OTHER POWER CORD.

Plug Cap Parallel blade with ground pin
(NEMA 5-15P Configuration)

Cord Type SJT, three 16 or 18 AWG wires

Length	Minimum 1.5 m, Less than 2.5 m (8 ft 3 in)
Rating	Minimum 10 A, 125 V

Using this unit at a voltage other than 120 V may require the use of a different line cord or attachment plug, or both. To reduce the risk of fire or electric shock, refer servicing to qualified service personnel.

WARNING: THIS WARNING IS APPLICABLE FOR OTHER COUNTRIES.

1. Use the approved Power Cord (3-core mains lead) / Appliance Connector / Plug with earthing-contacts that conforms to the safety regulations of each country if applicable.
2. Use the Power Cord (3-core mains lead) / Appliance Connector / Plug conforming to the proper ratings (Voltage, Ampere).

If you have questions on the use of the above Power Cord / Appliance Connector / Plug, please consult a qualified service personnel.

AVERTISSEMENT:

1. Utiliser un cordon d'alimentation approuvé (conducteur d'alimentation 3 âmes)/ connecteur d'appareil/prise avec contacts de mise à la terre conforme aux règles de sécurité de chaque pays si applicable.
2. Utiliser un cordon d'alimentation approuvé (conducteur d'alimentation 3 âmes)/ connecteur d'appareil/prise conforme aux valeurs nominales (tension, ampérage) correctes.

S'adresser à un personnel de service qualifié pour toute question concernant l'emploi du cordon d'alimentation/connecteur d'appareil/prise cidessus.

WARNUNG:

1. Verwenden Sie Netzkabel(dreiadrig), Geräteanschlüsse und Netzkabelstecker mit Masseleitung, die den Sicherheitsrichtlinien des jeweiligen Landes entspricht.
2. Verwenden Sie Netzkabel (dreiadrig), Geräteanschlüsse und Netzkabelstecker mit Masseleitung, die den vor Ort herrschenden Spannungsanforderungen (Spannung, Stromstärke) entsprechen.

Bei Frage über die Eignung und Sicherheit von Netzkabeln (dreiadrig), Geräteanschlüssen und Netzkabelsteckern wenden Sie sich bitte an einen qualifizierten Electrotechniker.

For the customers in the USA

This equipment has been tested and found to comply with the limits for a Class A digital device, pursuant to Part 15 of the FCC Rules. These limits are designed to provide reasonable protection against harmful interference when the equipment is operated in a commercial environment. This equipment generates, uses, and can radiate radio frequency energy and, if not installed and used in accordance with the instruction manual, may cause harmful interference to radio communications. Operation of this equipment in a residential area is likely to cause harmful interference in which case the user will be required to correct the interference at his own expense.

You are cautioned that any changes or modifications not expressly approved in this manual could void your authority to operate this equipment.

The shielded interface cable recommended in this manual must be used with this equipment in order to comply with the limits for a digital device pursuant to Subpart B of Part 15 of FCC Rules.

IMPORTANT

The nameplate is located on the bottom

CAUTION

Danger of explosion if battery is incorrectly replaced.
Replace only with the same or equivalent type recommended by the manufacturer.
Dispose of used batteries according to the manufacturer's instructions.

IMPORTANT

La plaque signalétique se situe sous l'appareil.

ATTENTION

Risque d'explosion si la batterie n'est pas remplacée correctement.
Utilisez uniquement le même type de batterie ou une batterie équivalente recommandée par le fabricant.
Jetez les batteries usagées selon les instructions du fabricant.

WICHTIG

Das Namensschild befindet sich auf der Unterseite des Gerätes.

VORSICHT

Explosionsgefahr bei Verwendung falscher Batterien.

Batterien nur durch den vom Hersteller empfohlenen oder einen gleichwertigen Typ ersetzen.

Verbrauchte Batterien entsprechend den Anweisungen des Herstellers entsorgen.

For the customers in Europe

WARNING

This is a Class A product. In a domestic environment, this product may cause radio interference in which case the user may be required to take adequate measures.

Pour les utilisateurs en Europe

AVERTISSEMENT

Il s'agit d'un produit de Classe A. Dans un environnement domestique, cet appareil peut provoquer des interférences radio, dans ce cas l'utilisateur peut être amené à prendre des mesures appropriées.

Für Kunden in Europa

Warnung

Dies ist eine Einrichtung, welche die Funk-Entstörung nach Klasse A besitzt. Diese Einrichtung kann im Wohnbereich Funkstörungen verursachen; in diesem Fall kann vom Betreiber verlangt werden, angemessene Maßnahmen durchzuführen und dafür anzukommen.

Für Kunden in Deutschland

Dieses Gerät ist nur für den Gebrauch in Gewerbe und Leichtindustrie bestimmt.

For Customers in Taiwan only



廢電池請回收

Usage Notes

Copyright

Using this unit for video and/or audio switching, or distribution over the Internet or otherwise may in some cases require the permission of the copyright holder of the video or audio.

To protect copyright, observe the following points carefully when using this unit.

- When connecting a recording device to this and recording video or audio, carefully observe laws relating to copyright.
- Without the permission of the copyright holder, the showing or distribution of video or audio material of which the copyright is held by a third party, or the act of recording on the hard disk of this unit, sharing folders, and permitting of access to a private group or to the public is prohibited by law.
- Even with the right to show or distribute, the act of using this unit to edit original content with wipes or dissolves, for example, may be prohibited by law.
- With a software upgrade or functional extension, with the object of protecting copyright, the specifications for the video and audio signals that can be input may be changed without notice.

Points to check before using devices

- When recording or streaming valuable data, be sure to check the device connections beforehand, or carry out a streaming test, to make sure that the system is operating normally.
- If when using a camera or videocassette recorder, tape or similar there should be a failure in another device preventing recording, no responsibility can be taken for any loss of the material which was to have been recorded.
- Under copyright law, you may not use recorded video or audio other than for your personal enjoyment without the permission of the copyright holder. Note that at live performances, shows and exhibitions, even for your personal entertainment shooting may be restricted.

Regarding cables

Use cables (particularly generic RGB) which are as short as possible.

IEEE1394 (i.LINK) cables

Use cables with enhanced shielding, ferrite cores, and similar noise-reduction measures.

About the LCD Display

- Do not wipe the surface of the LCD display with a wet object. Water that gets inside the unit may cause it to malfunction.
- Do not set or drop objects on the LCD display. Also, do not put pressure on the display, such as by leaning on it with your hand or elbow.
- Condensation may form on the LCD display when the unit is moved from a cold place to a warm place, such as from the outdoors to room temperature. If condensation forms, thoroughly wipe off any moisture before using the unit. We recommend using tissues to wipe up any condensed moisture. If you wipe up the condensed moisture while the LCD display is still cold, the condensation may form again. Therefore it is best to wait until the LCD display has warmed up to room temperature.
- The LCD display is made with extremely high precision technology. Nonetheless, in some cases black dots may appear, and red, green, and blue dots may not disappear. In addition, depending on the angle the LCD display is viewed from, you may see stripes of irregular color or brightness. This is due to the construction of the LCD display and is not a malfunction.

External Hard disk

- The hard disk is vulnerable to vibration and shock. Be sure to install the hard disk in the best possible environment, following the operating instructions supplied with the drive.
- Even using the recommended hard disk, depending on the operating environment or conditions, or in the event of deterioration because of age, the full performance of the hard disk may not always be obtained.
- Even when using the recommended hard disk to store material, the characteristics of the hard

disk mean that frame drop or other problems may occur.

- To connect the recommended hard disk to this unit, use the interface cable supplied with the recommended hard disk.

Ensuring Good Performance From This Unit

Operation and Storage

Avoid using or storing the unit in the following places.

- Where it is subject to extremes of cold or heat (operating temperature 0°C to 40°C (32°F to 104°F))
- Where it is subject to direct sunlight for extended periods, or close to heating equipment (Note that the temperature inside a car with the windows closed on a summer day can exceed 50°C (122°F))
- In conditions of high humidity or much dust
- Where it is subject to severe vibration
- Close to a source of strong magnetic fields
- Close to a radio, television, or other source of powerful electromagnetic radiation

Install in a level place

This unit is designed to be operated in a level place. Do not turn it vertically, or incline at an angle of 20 degrees or more.

Do not apply strong shocks

Dropping the unit, or subjecting it to other strong shocks may cause it to break.

Do not obstruct the ventilation holes

To prevent the temperature from rising, do not, for example, wrap the unit in a blanket while operating.

Care of the unit

Clean dirt from the cabinet and panel by wiping gently with a dry cloth. If the unit is very dirty, wipe with a cloth steeped in a little neutral detergent, then wipe dry. Do not use alcohol, thinners, insecticides, or other volatile solvents, as this may cause the case to deform or damage the finish.

Shipping

Pack in the original carton, or similar packaging, to cushion the unit from violent shocks.

Features of This System

The Anycast Station Live Content Producer AWS-G500 is an audiovisual production system including camera control, video switching, and a live distribution system for the Internet. The following are the principal features.

All-in-One

AWS-G500 is light and conveniently portable, while combining video switching and audio mixing functions with video monitor and camera control, to provide an inclusive package for live content generation. Whereas previously it was necessary to assemble various devices, this is no longer necessary, and the time and effort required to install, connect, and adjust the equipment has been greatly reduced.

Video Switching

- You can switch among up to six video inputs: analog, DV, SDI (when using a serial digital interface module), and RGB.
- The system provides both mix (dissolve) and wipe transition effects, Picture-in-Picture for combining videos, and luminance keying functions.
- Before carrying out a switching operation, you can preview the next selected image in the PVW viewer.
- You can mix video using a maximum of five effects at one time, such as incorporating (keying) a separate video clip when switching between two video clips with a wipe or other transition effect, as well as superimposing text (downstream key) and displaying a copyright logo.

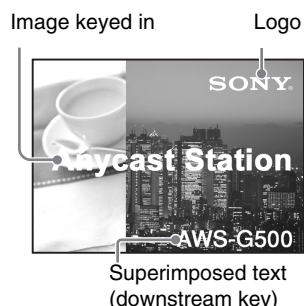

Text Typing Tool Software

The system includes installed text typing tool software, which allows easy creation of titles. Titles created with the text typing tool software can be used in the DSK (downstream key) or as luminance keys.

Audio Mixing

You can mix up to six audio inputs. Each channel is provided with a range of functions, including fader, input trim, filter equalizer, limiter, and compressor pan (balance), allowing the sound quality and level to be adjusted on each channel separately. In addition, each channel has a prefader listen function, allowing you to monitor the input audio before any effects are applied by the fader, and each output has a delay function to correct any discrepancies between the audio and video timing.

Remote Camera Control

- Using a camera with VISCA support, you can remotely control the camera movements, including panning, tilting, and zoom.
- The camera preset function allows you to store camera pan, tilt, and zoom settings. Using the camera preset function, you can immediately set the camera to the preset state when required just by pressing a button.

External Recording Material on an External Hard Disk

You can record (.avi) video material (video and audio) being input to the unit to an external hard disk connected to the i.LINK connector. By connecting the external hard disk containing the recorded material to a nonlinear editing system, you can go straight into editing operations, without the need to transfer data from video tape to the nonlinear editing system.

You can also play files recorded on the external hard disk as input source material.

This system can use two external hard disks as standard, or three with the addition of an option module, recording four channels (maximum six channels) simultaneously.

Streaming Broadcast

You can encode in Real Media streaming file format (.rm) in real time, for a live broadcast.

Example Applications

The following are examples of applications utilizing the functions of AWS-G500.

Event and presentation support

At seminars, events, and presentations you can use this unit to switch among camera inputs and data from a computer, while displaying the output on a projector or large monitor.

Principal functions used: video switching (such as cut switching or picture-in-picture), audio mixing, RGB input/output

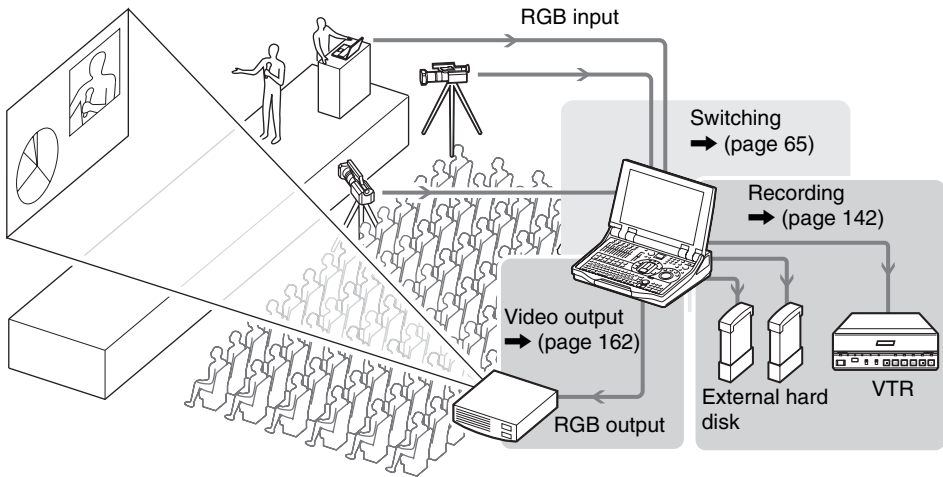

Internet live broadcast

This unit includes a streaming server function. For broadcast to small audiences (about 20 people) over an intranet, this unit can be used as the streaming server without requiring an external server.

Principal functions used: video switching (such as a wipe transition), audio mixing, streaming encode, streaming server

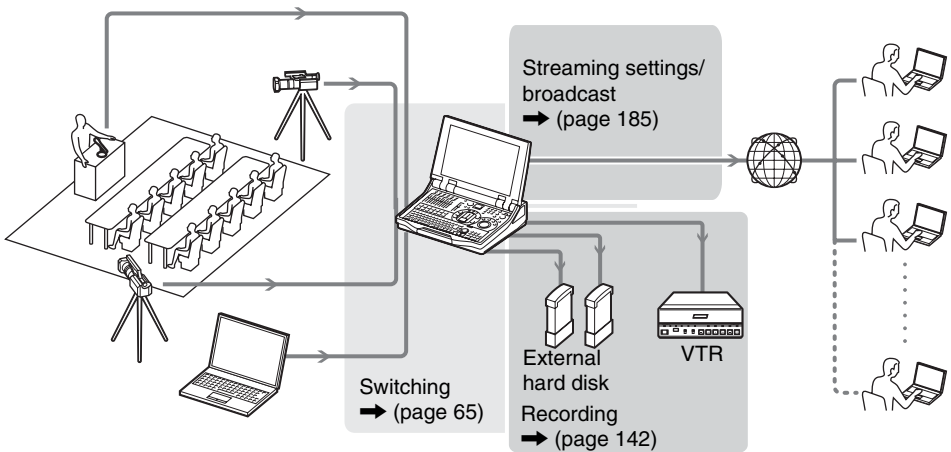

For the broadcast of things like live events to large audiences, you can broadcast via a streaming server (Helix server).

Principal functions used: video switching (such as a mix transition), audio mixing, streaming encode, camera presets.

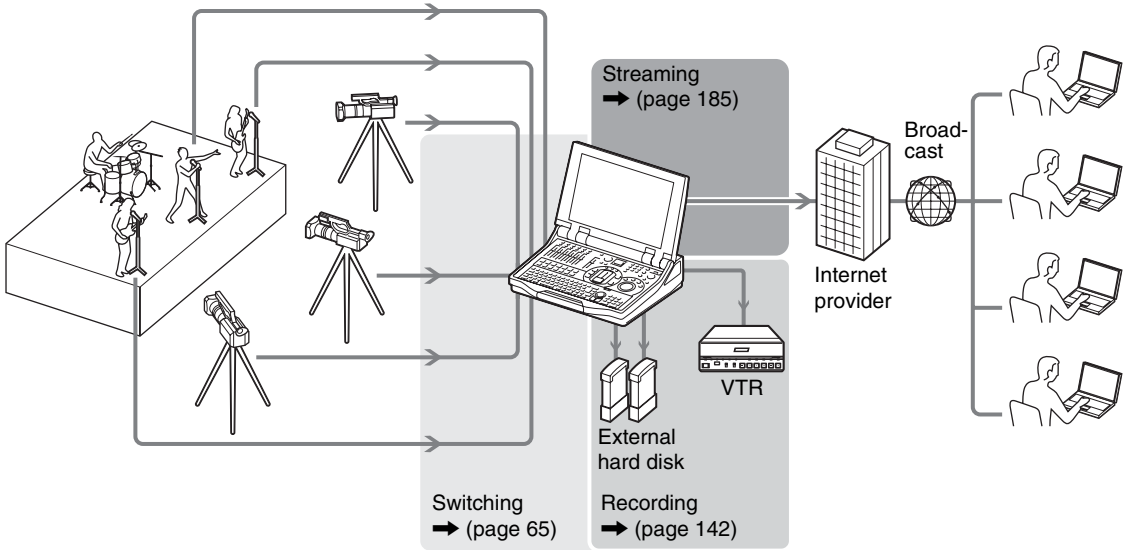

Names and Functions of Parts

Front Panel

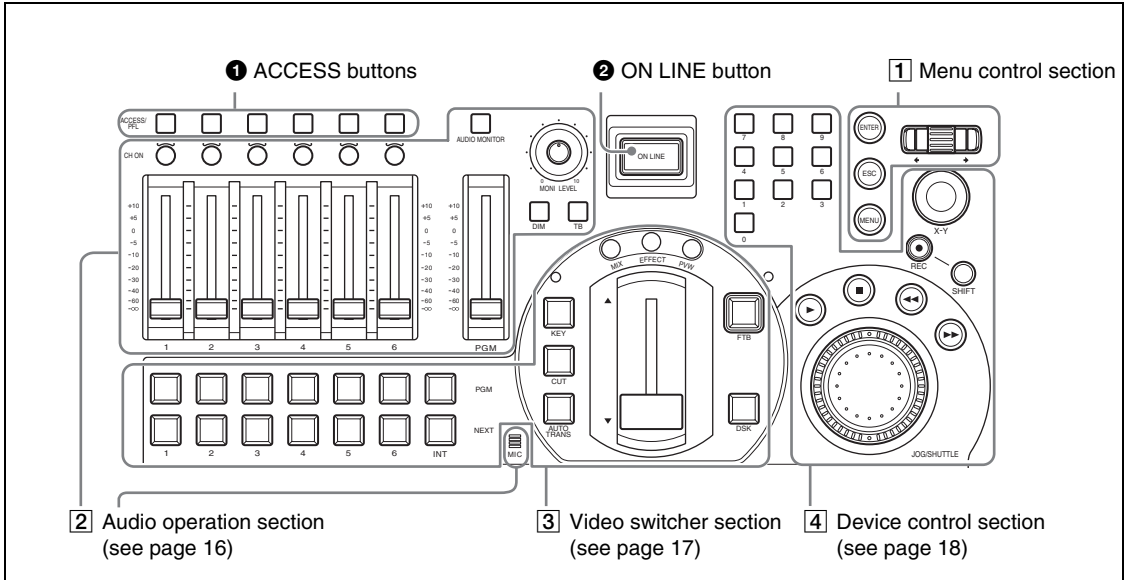

1 ACCESS buttons

These buttons display the ACCESS menu (page 30), and for audio monitoring (page 159). When you press an ACCESS button in one of columns 1 to 6, the ACCESS menu appears allowing adjustment of the related video and audio settings. If you hold down the ACCESS button in one of columns 1 to 6 for 0.5 seconds or more, you can monitor the audio assigned to the channel fader in the same column, and display the audio level meter for that channel only.

By holding down two or more ACCESS buttons simultaneously, you can monitor multiple audio channels.

2 ON LINE button

This button starts and stops streaming broadcast (page 195).

1 Menu control block

Use these controls to access the menus and settings.

For details of operations, see “Menu Operations” (page 30).

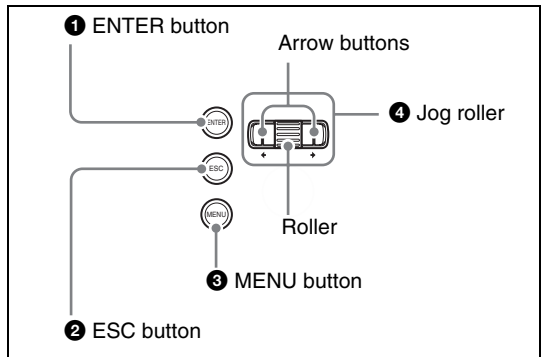

1 ENTER button

This button confirms an item or input value in menu operations.

2 ESC button

This button closes the current menu. In alphanumeric input mode, it cancels, and returns one level up the menu tree.



3 MENU button

This toggles the top menu on or off.

4 Jog roller

Turn the roller up and down to select a menu item. Pressing the roller like a button has the same effect as pressing the ENTER button. Use the arrow buttons when a menu operation requires movement to left or right.

2 Audio operation section

Use these controls for audio settings and operations.

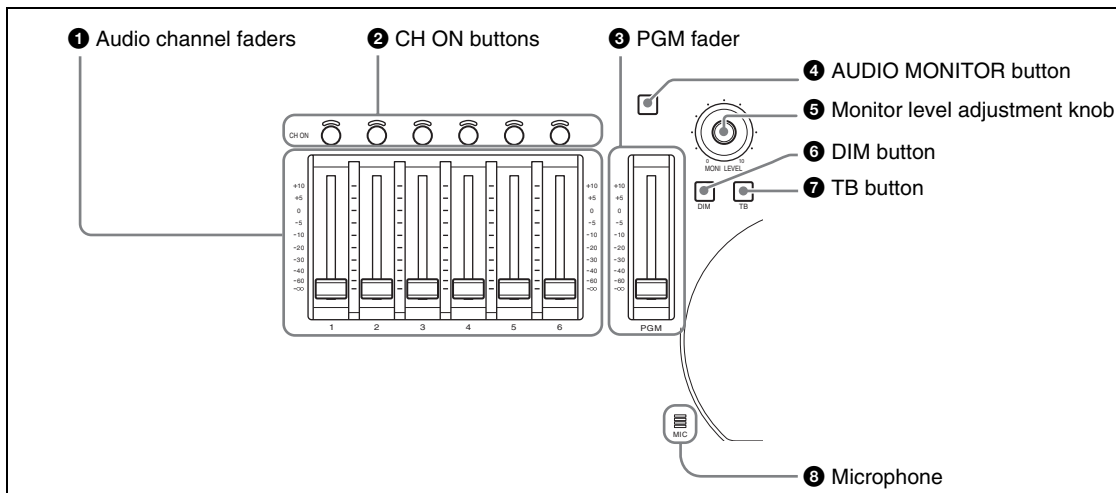

1 Audio channel faders

These buttons adjust the input levels of the audio assigned to channels 1 to 6, in the range from $-\infty$ to +10 dB (page 141).

For details of audio signal assignment, see “Audio Signal Related Settings” (page 59).

2 CH ON buttons

These buttons select whether the audio channels 1 to 6 are enabled or disabled.

Pressing a button enables the audio assigned to the corresponding audio channel. Channels for which the button is off are disabled (page 141).

3 PGM fader

This button adjusts the overall audio output level of the program output, in the range from $-\infty$ to +10 dB (page 141).

4 AUDIO MONITOR button

This button switches the monitoring target. Pressing it cycles the audio to be monitored through the sequence PGM → AUX1 → AUX2 → MIX → PGM (page 158).

5 Monitor level adjustment knob

This button adjusts the level of the monitor output and the output from the internal speakers and from the headphones (page 158).

6 DIM button

This button enables the “audio attenuate” function. This reduces each of the level of the monitor output and the output from the internal speakers and from the headphones by 20 dB.

7 TB button

This button lets you to speak while communicating on an external intercom system. While the TB button is lit, sound from the front panel microphone and headset microphone is output over the intercom system (page 155).

8 Microphone

This button lets you speak on an external intercom system. While the TB button is lit, sound from the microphone is output over the intercom system (page 155).

3 Video switcher section

This switches video.

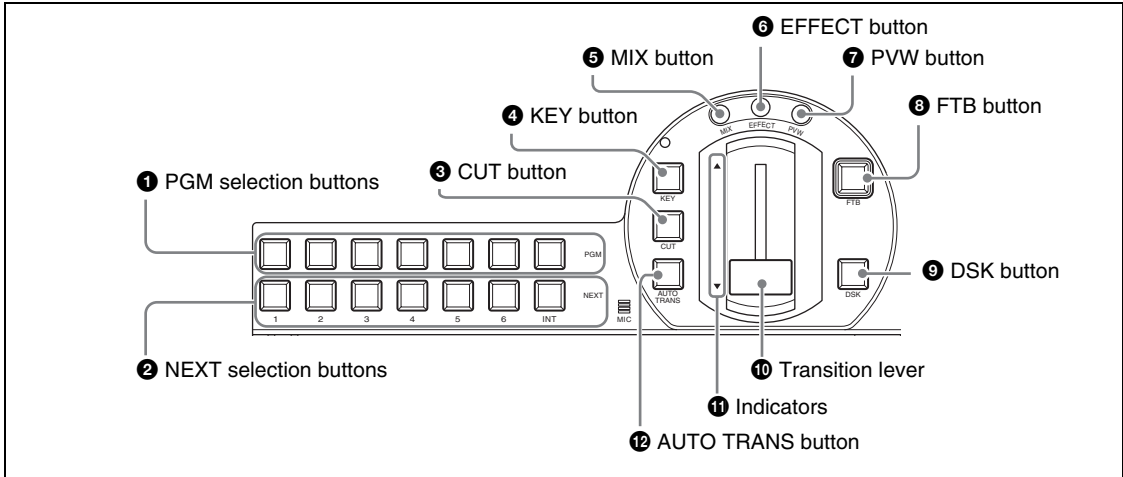

1 PGM selection buttons

These buttons select the video which will be displayed on the program output (page 66). Buttons 1 to 6 select the corresponding assigned video, and the INT button selects a video image generated internally by this unit (color matte, color bars, graphics files).

When you press one of these buttons, lighting it red, the video assigned to the button is sent to the program output.

For details of video assignment, see “Video Signal Related Settings” (page 57).

2 NEXT selection buttons

The NEXT selection buttons have the following functions.

- Selecting the video to be output on the program output after next switching transition (page 67)
- Selecting the video to be used for picture-in-picture (page 74)
- Selecting the video to be used when inserting a key in the program output (page 84)
- Specifying a camera to be controlled during camera control operations (page 133)
- Selecting the video for recording or playback (page 145, 147)

Buttons 1 to 6 select the corresponding assigned video, and the INT button selects a video image generated internally by this unit (color matte, color bars, graphics files).

3 CUT button

This button instantaneously switches the video (page 65).

4 KEY button

This button effectuates keying (pages 84). When this key lights green, the NEXT selection buttons, MIX button, AUTO TRANS button, CUT button, and transition lever are then assigned to keying.

5 MIX button

This button effectuates a dissolve (gradually blending a new video into the existing image). When applying an effect it gradually blends in the effect (page 69).

6 EFFECT button

This button enables an effect other than dissolve in a transition or when applying an effect (page 70). You can also use it as a shortcut to the [Effect Pattern] menu.

7 PVW button

With this button you can check the result of keying and picture-in-picture before switching it to program output, on the PVW viewer (page 88).

8 FTB button

This button fades the video in from or out to a black screen (“fade-to-black”) (page 77).

9 DSK button

This button add is used to images or text to the program output video (page 78). You can use it to superimpose text and so on.

10 Transition lever

This lever allows you to manually execute a transition or effect (page 69).

**11 Indicators (▽△)**

These indicators show the direction in which the transition lever is being moved. Moving the transition lever in the direction of the lit indicator starts the transition or effect.

However, supposing you press the AUTO TRANS button after moving the transition lever to the middle, for example, an inconsistency between the position of the fader and the application of the effect will arise and both indicators will light.

12 AUTO TRANS button

This button carries out an automatic transition with a preset transition time, either from one video to another or when applying an effect (page 69).

4 Device control section

Use these controls for remote control of a camera with VISCA support connected to this system (page 132) or hard disk operations (material recording, file playback) (page 144, 147).

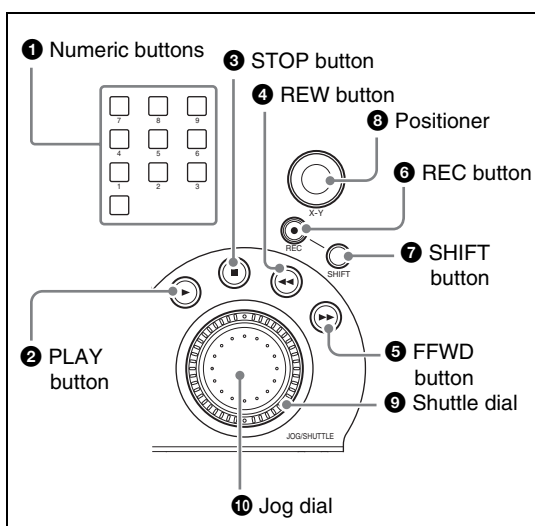
**1 Numeric buttons**

These buttons are used to save or recall a camera preset, or reset a camera (page 134, 138).

2 PLAY button

This button plays back a file at normal speed. Hold down the REC button and press this button, to start recording on the hard disk (page 144).

3 STOP button

This button stops file playback. Press shift and then press this button to switch the source viewer back from viewing a file on the hard disk to normal input (page 149).

During recording on the hard disk, hold down the REC button and press this button to stop recording (page 146).

4 REW button

During file playback, play back fast in the reverse direction. Each time you press, the reverse speed increases (in six steps) (page 149).

5 FFWD button

During file playback, play back fast in the forward direction. Each time you press, the playback speed increases (in six steps) (page 149).

6 REC button

This button is used to start or stop the external hard disk recording (page 145).

REC + PLAY button	Start hard disk recording
REC + STOP button	Stop hard disk recording

7 SHIFT button

This button is pressed while using other controls to perform the following operations.

SHIFT + jog dial	Aperture (iris) adjustment on camera with VISCA support
SHIFT + numeric button (1 to 6)	Set camera presets
SHIFT + numeric button (0)	Camera reset
SHIFT + REW button	Skip to the beginning of a file
SHIFT + FFWD button	Skip to the end of a file
SHIFT + STOP button	Close the file

8 Positioner

This control is used to pan or tilt the camera. You can also control the speed of the camera by adjusting how hard you press this button (page 134).

You can also change the picture-in-picture and logo display positions (page 76, 83).

9 Shuttle dial (outer ring)

This dial controls the camera zoom.

During file playback, turning this dial clockwise plays the file in the forward direction at a speed that corresponds to the amount the dial was turned (one of seven speeds) and turning this dial counterclockwise plays the file in the reverse direction at a speed that corresponds to the amount the dial was turned (one of seven speeds) (page 134, 149).

10 Jog dial (inner dial)

This dial controls the camera focus and iris. During file playback, turning this dial plays the file at a slow speed that corresponds to the speed at which the dial is turned (page 134, 149).

Rear Panel

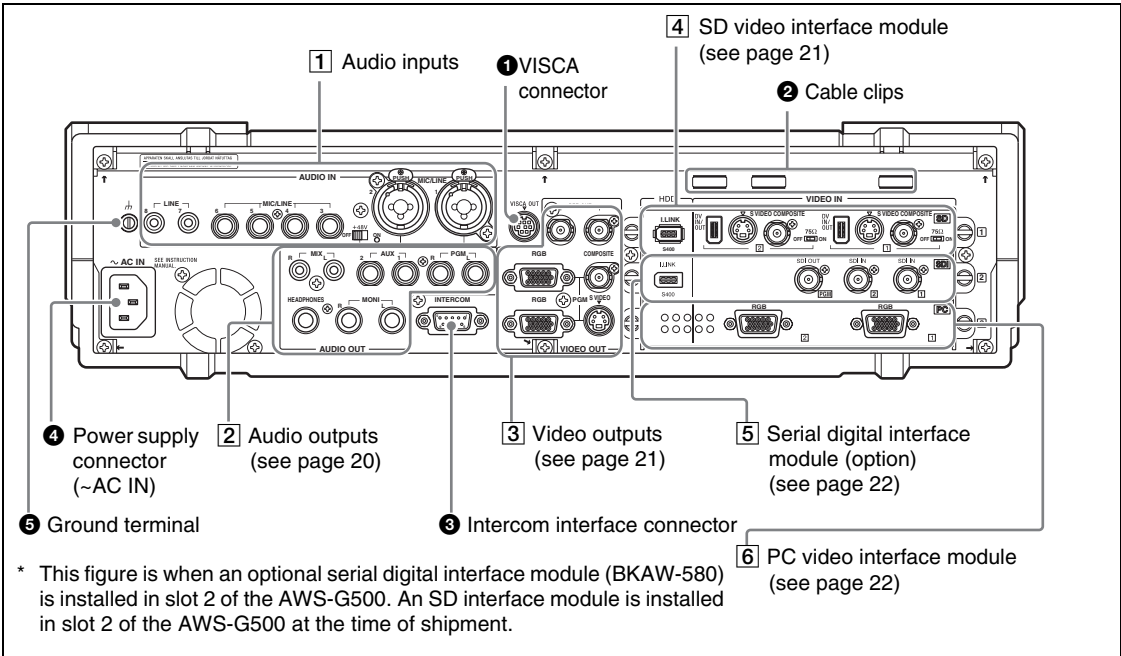

1 VISCA connector

To connect the chain of cameras with VISCA support to this unit for remote control operation, connect the VISCA cable (page 50).

2 Cable clips

Use these clips to prevent cables from accidentally disconnecting (page 54).

3 Intercom interface connector

Connect an external intercom system (page 155).

4 Power supply connector (~AC IN)

Use to connect to an AC outlet (page 41).

Caution

When using a DC-AC inverter, the use of a 50 Hz ($\pm 3\%$) or 60 Hz ($\pm 3\%$) sine wave is recommended. Do not use a general-purpose inverter with a square output waveform.

5 Ground terminal

When using this unit, connect the ground terminal to a grounding lead.

Caution

The ground terminal is close to the audio input connectors, so when connecting the grounding lead be careful not to touch the audio input connectors.

1 Audio inputs

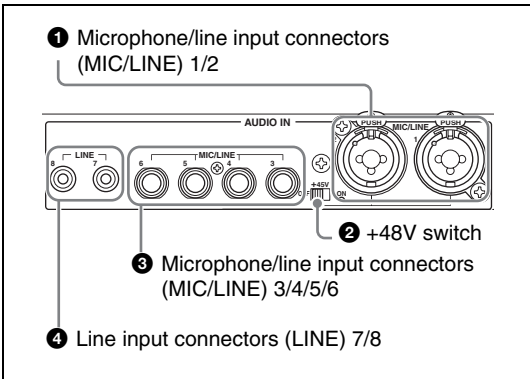

1 Microphone/line input connectors (MIC/LINE) 1/2 (XLR 3-pin, TRS shared balanced type)

Input an analog audio signal from a microphone or audio device.

2 +48V switch

Use this switch when a capacitor microphone requiring a power supply is connected to the microphone/line input connectors (MIC/LINE) 1/2. When this is in the ON position, +48V is supplied.

3 Microphone/line input connectors (MIC/LINE) 3/4/5/6 (TRS balanced type)

Input an analog audio signal from a dynamic microphone or audio device.

4 Line input connectors (LINE) 7/8 (RCA)

Input an analog audio signal from an audio device.

2 Audio outputs

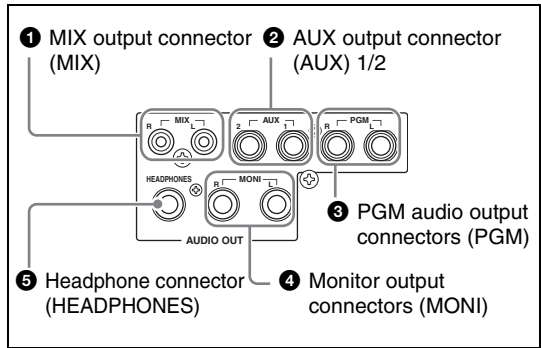

1 MIX output connector (MIX) L/R (RCA)

These connect to an external acoustic device to output audio signals (page 157).

2 AUX output connector (AUX) 1/2 (TRS, balanced)

These connect to an external acoustic device to output audio signals. The output level can be adjusted (page 156).

3 PGM audio output connectors (PGM) L/R (TRS, balanced)

These output the final audio (program audio) created by this unit (page 156).

4 Monitor output connectors (MONI) L/R (RCA)

These provide monitor outputs of any of the PGM/AUX1/AUX2/MIX audio (page 158).

5 Headphone connector (HEADPHONES) (standard phone jack)

This outputs one of the PGM/AUX1/AUX2/MIX audio (page 157).

The output level can be adjusted with the front panel monitor level adjustment knob (MONI LEVEL) (page 158).

3 Video outputs

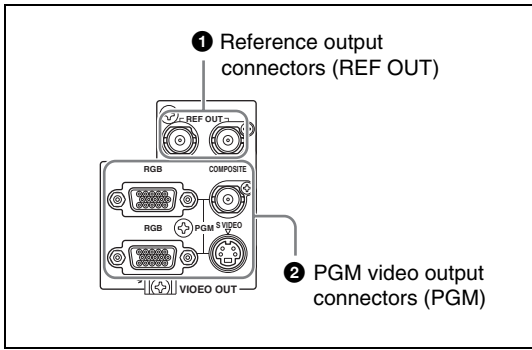

1 Reference output connectors (REF OUT) × 2

These output either a 59.94 Hz (NTSC) or 50 Hz (PAL) black burst signal to match the program output signal.

2 PGM video output connectors (PGM)

- Composite video output connector (COMPOSITE) (BNC) × 1
- S-video output connector (S VIDEO) (S connector) × 1
- RGB output connectors (RGB) (D-sub 15-pin) × 2

These output the final program (PGM) video. You can switch to NTSC or PAL (page 59). Connect a projector or external display. The following signals can be output (page 59).

- XGA (1,024 × 768) 60 Hz/75 Hz
- SXGA (1,280 × 1,024) 60 Hz
- 15k RGB 50 Hz/59.94 Hz

4 SD video interface module (BKAW-570)

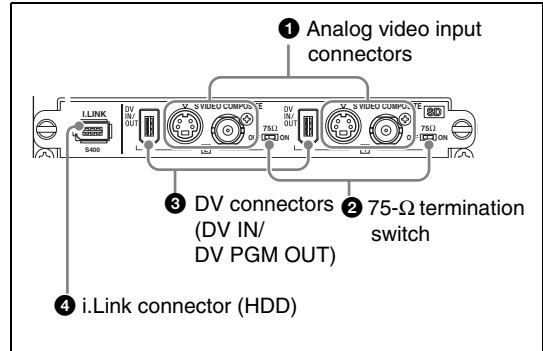

1 Analog video input connectors Composite video input connectors (COMPOSITE) (BNC) × 2

S-video input connectors (S connector) × 2
Input analog video signals.

2 75-Ω termination switch

Set this switch to the OFF position when using a loop-through connection for a video monitor or the like by connecting a branch connector to the composite video input connector (COMPOSITE).

Note

The factory default setting is ON.

Use the end of a sharp implement such as a pen to operate the switch.

3 DV connectors (DV IN/DV PGM OUT) (i.LINK 6-pin) × 2

Input and output digital video audio signals.

Notes

- Only one of the Composite/S Video/DV inputs can be used for each of IN1 and IN2.
- If the DV connector is set as the output, material cannot be recorded from composite and S-video connectors (page 143).

4 i.LINK connector (HDD) (i.LINK 6-pin) × 1

When a hard disk drive is connected, video input to the same module and audio with the same source number as the video can be recorded in combination (page 144).

5 Serial digital interface module (BKAW-580) (Option)

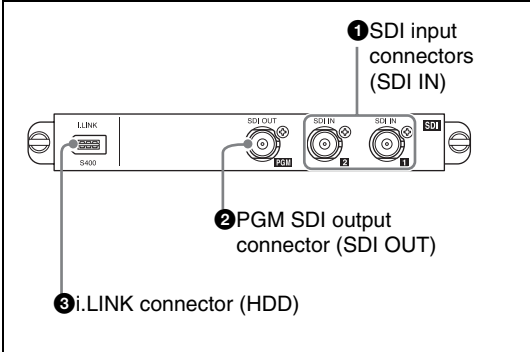

1 SDI input connectors (SDI IN) (BNC) × 2
Inputs SDI signals.

2 PGM SDI output connector (SDI OUT) (BNC) × 1

Outputs final video and audio (program video + audio) as SDI signals (page 143).

3 i.LINK connector (HDD) (i.LINK 6 pins) × 1

If an external hard disk is connected, you can record together both the video and the audio, which is assigned the same source number as the video, being input to the same module (page 144).

6 PC video interface module (BKAW-550)

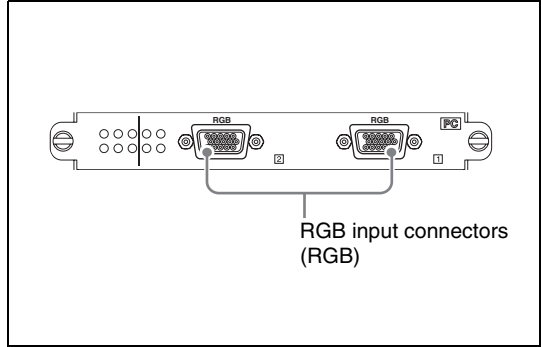

RGB input connectors (RGB) (D-sub 15-pin) × 2

Input analog RGB signals from a computer or other source. The following image size and frequency combinations are supported.

- XGA (1,024 × 768) 60 Hz 75 Hz
- SXGA (1,280 × 1,024) 60 Hz

Side Panel

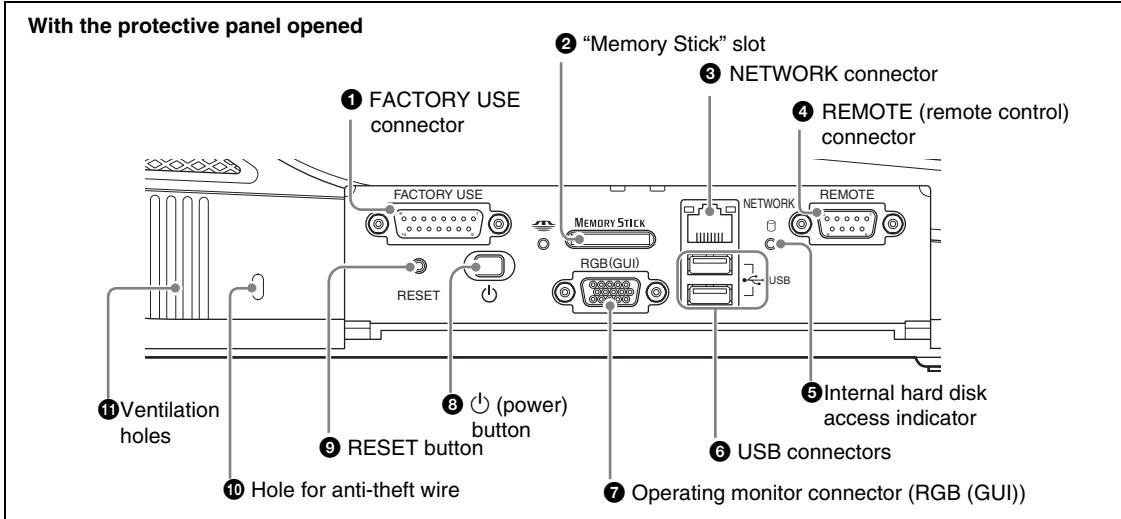

1 FACTORY USE connector

Output a tally signal. Connecting this connector and the tally connector of a CCU (camera control unit) or other device enables the tally lamp of the camera to light (page 139).

2 "Memory Stick" slot

This slot takes a "Memory Stick." Use it for upgrading the operating software (page 200), importing font files (page 129), exporting/importing job data (page 173 and 174), importing graphics files (page 175), etc. While the "Memory Stick" is being accessed, the access indicator to the left of the slot lights.

3 NETWORK connector (RJ-45)

Connect an external network adaptor or router. This supports 10Base-T and 100Base-TX Ethernet. The green indicator blinks while the network is active. An amber LED lights while the unit is connected by 100Base-TX.

Caution

When making Network connections

For safety, do not connect the Network connector to circuits which may be subjected to excessive voltage.

4 REMOTE (remote control) connector

This connector is provided for future functional expansion.

5 Internal hard disk access indicator

This indicator lights while the internal hard disk is being accessed.

6 USB connectors (USB) (USB compatible)

The upper connector is number 1, and the lower connector is number 2. Use these connectors to connect a USB keyboard. Also use them for connecting USB flash memory, upgrading the operating software (page 200), importing font files (page 129), exporting/importing job data (page 173 and 174), importing graphics files (page 175), etc. For details of the keyboards that can be used, consult your dealer or your Sony service representative. When using the text typing tool software, you can connect and use a USB mouse.

Caution

- These do not support input from a USB camera.
- A USB mouse cannot be used with the main software.

7 Operating monitor connector (RGB (GUI)) (D-Sub 15-pin)

This connector outputs the operation screen to an external display at WXGA (1,280 × 800) size, at 60 Hz. For information on which devices can be used, consult your dealer or your Sony service representative.

8 (power) button

This button powers the unit on or off. If you hold down the power button for at least 4 seconds, this forces a shutdown. After a forced shutdown, the settings of the unit may not be preserved.

9 RESET button

This button is provided for future functional expansion.



10 Hole for anti-theft wire

This hole accepts a standard anti-theft wire (3 mm × 7 mm).

11 Ventilation holes

Caution

Be careful not to obstruct the ventilation holes. If the ventilation holes are obstructed, the unit may overheat, leading to fire or breakdown.

Other Parts

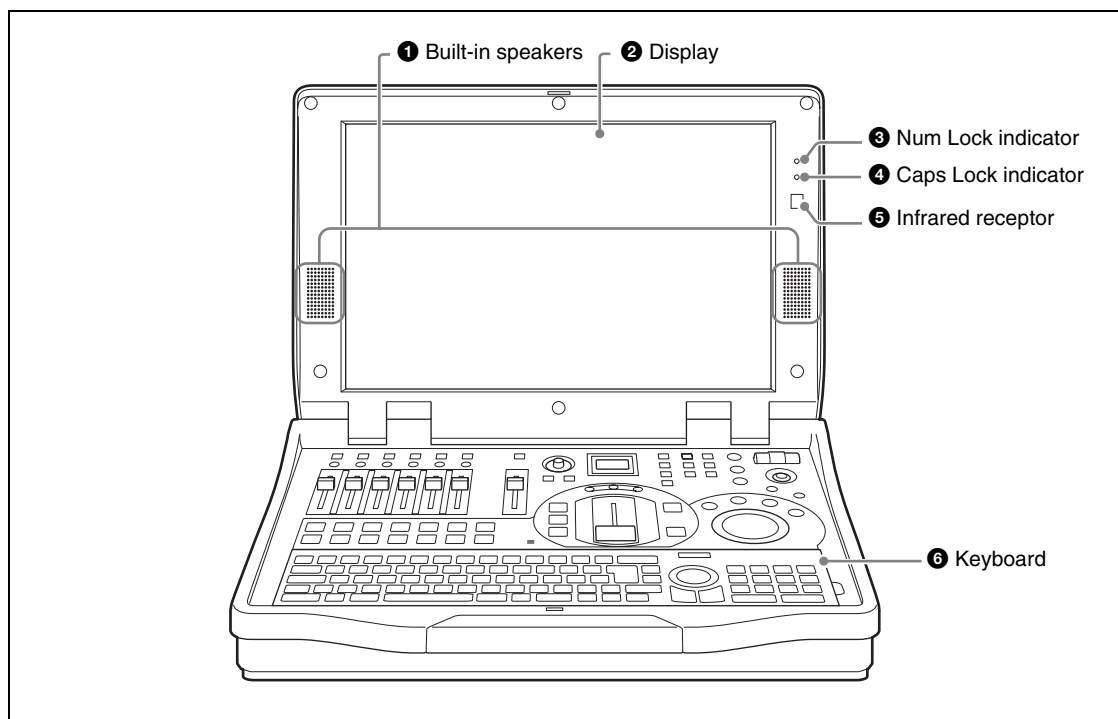

1 Built-in speakers

You can monitor the audio using these speakers. There is no output from the built-in speakers when a headphone is connected to the headphone connector.

2 Display

This shows the operation screen (page 25).

3 Num Lock indicator

This lights green when the unit is in Num Lock mode.

4 Caps Lock indicator

This lights green when the unit is in Caps Lock mode.

5 Infrared receptor

This accepts signals from the keyboard supplied with this unit (page 44).

6 Keyboard

Use this for text and numeric input. You can also use the keyboard for menu operations (page 31).

While the keyboard is mounted to the unit, the EXT POWER indicator on the keyboard lights green.

When using Esc and the F1 to F12 keys, hold down the Fn key and press the required key in the topmost row.

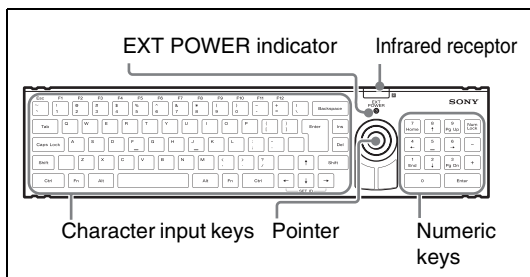

For details on changing the keyboard language, see “Selecting the Keyboard Language” (page 46).

Operation Screen



1 Menu display

This displays the top menus (page 30), the INT material selection menu (pages 79, 161), the camera guide menu (pages 133, 134), and the HDD guide menu (page 147).

2 Guidance object indication

The color of the guidance object indication has the following significance.

Amber: when a video subject to camera control (page 132) and external hard disk control (page 144) or INT is selected with the NEXT selection buttons (while the KEY button is not lit).

Green: when a video subject to camera control and external hard disk control or INT is specified with the NEXT selection buttons (while the KEY button is lit).

Off: when other than a video subject to camera control and external hard disk control or INT is specified with the NEXT selection buttons.

3 Audio level meter

When monitoring the any of the PGM/AUX1/AUX2/MIX audio outputs or Pre Fader Listen (PFL) result, this shows the audio level. An indication below the meter shows which of PGM/AUX1/AUX2/MIX or PFL is being monitored. When the level exceeds the meter range, the uppermost indicator lights red (page 158).

4 KEY ON

The indicator lights red during keying to program output video. The number (1 to 6) or "INT" of the source selected for keying appears.



1 PGM viewer

This shows a program output.

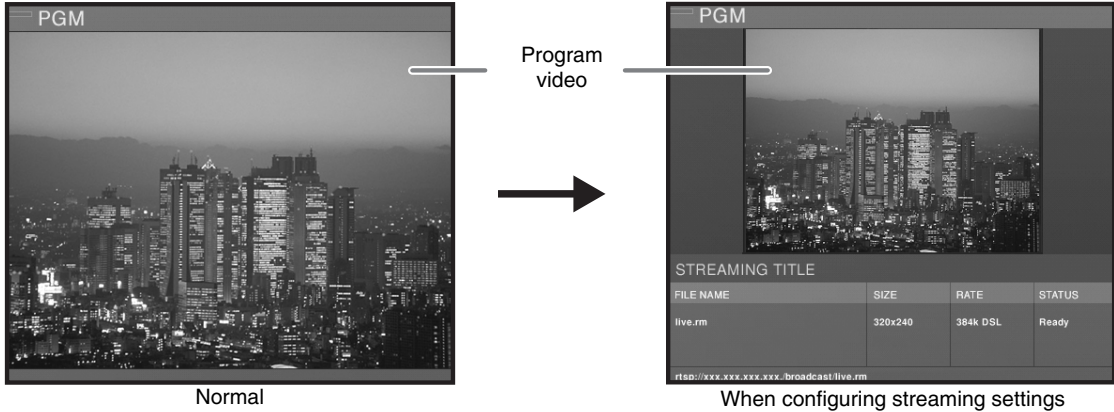

Program video

The program output video is shown at 480×360 pixels, 30 fps (25 fps for PAL). During streaming, the size is 320×240 pixels.

Caution

- Video displayed on the PGM viewer lags several frames behind the video output from the PGM video output connectors.
- In any of the video viewers displayed on the operation screen (PGM/PVW/source) the video may deteriorate, but this is an artifact of the display system. There is no effect on the video output from the program video output connectors.

2 PVW viewer

This shows a preview of the video.

This allows you to check the input video selected to be shown next, keying, or picture-in-picture result before switching to program output.



① What the preview is showing

Amber: when showing the video selected by the NEXT selection button.

Green: when showing the video selected by the NEXT selection button when the KEY button is lit (video with a key inserted).

② Preview video

Normally the video selected with the NEXT selection buttons is shown at 320×240 pixels, 15 fps (12 to 13 fps for PAL).

3 Status

The status shown here differs as follows depending on the video to be previewed.

When showing video from a remotely controlled VISCA compliant camera

The status of the VISCA compliant camera is shown.

No Response: communication cannot be established with the camera.

Initializing: appears at system startup and during camera reset.

When showing an INT graphics file

Loading: while file is loading

When playing a file on an external hard disk

The status of file operations is shown.

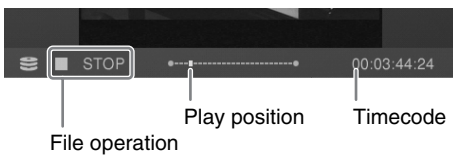

File operation indications

Opening: while opening a file

▶ PLAY: during playback

■ STOP: when stopped

|| STILL: when playback speed is set to zero with the shuttle dial or playback is stopped with the jog dial.

JOG: while using the jog dial.

▶▶ x2: fast forward (x2, x4, x8, x16, x32, x64)

◀◀ x2: fast reverse (x2, x4, x8, x16, x32, x64)

Note

The x1/8, x1/2, and x1 indications are also displayed while you are using the shuttle dial for playback operations.

Play position

This shows the file play position.

When the play position is at the beginning or end, ● of each end lights.

An icon appears on the right while auto repeat playback is set (page 150).

3 Streaming display

This shows the settings and status of the streaming broadcast.

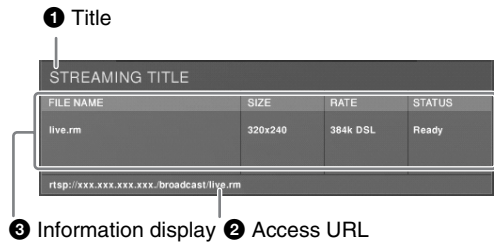

1 Title

This shows the streaming title.

2 Access URL

This appears when the unit is used as a server for a broadcast. Audience members can view the broadcast by accessing this URL.

3 Information display

This shows the following information:

FILE NAME: the file name of the broadcast

SIZE: video size set in the top menu

RATE: transfer rate set in the top menu

STATUS: the status of the server or encoder

Initializing	Starting server or encoder
Ready	Server started up, and encoder ready
Starting	Encoder connecting to server
Running	Encoding
Stopping	Ending the encoder
Reconnecting	While re-establishing a connection to the server.
Failed	When a connection failed to be established because of the settings of the unit, the status of the network or external server, etc.
Error	The encoder had failed to end, or an error occurred.

4 Source viewer

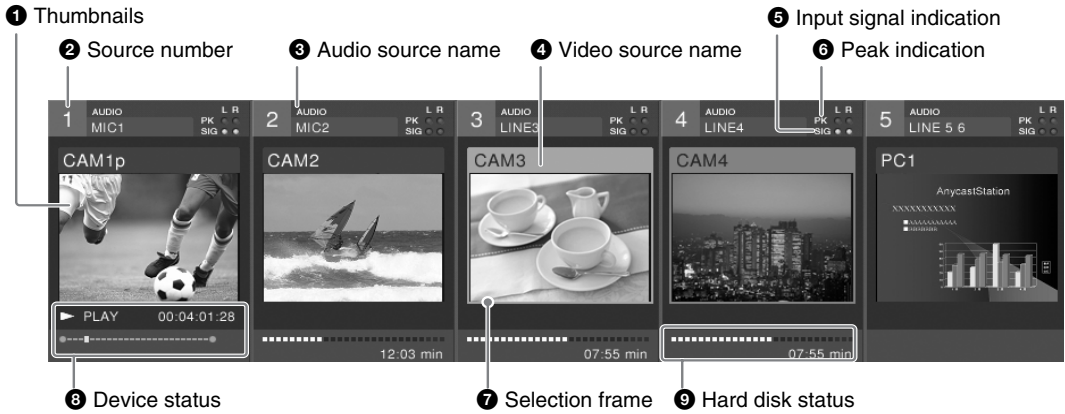

1 Thumbnails

These show the video assigned to the selection buttons at 160×120 pixels, at 10 fps (8 to 9 fps for PAL).

2 Source number

This is the number (1 to 6 and INT) assigned to the source (video or audio). These correspond to the PGM selection button, the NEXT selection button, and the audio channel fader numbers.

3 Audio source name

This shows the name of the audio signal assigned to the channel fader (page 59) or the file name on the external hard disk (page 147).

4 Video source name

In viewers 1 to 6, this shows the name of the video signal assigned to the selection button (page 57) or the file name on the external hard disk (page 147). For the INT viewer, this displays the color matte and color bars, or the graphics file name selected in the INT source selection menu.

5 Input signal indication

If the input level of the audio assigned to a channel fader is -60 dBFS or more, this lights green, and you can check that there is an audio input. For stereo you can check left and right channels separately; for monaural both channels are shown the same.

6 Peak indication

If the input level of the audio assigned to a channel fader is -8 dBFS or more, this lights red. For stereo you can check left and right channels separately; for monaural both channels are shown the same.

7 Selection frame

Depending on the selection state, the frame color changes.

Red: video selected with PGM selection button

Amber: video selected with NEXT selection button

Green: video selected with NEXT selection button when the KEY button is lit (video with a key inserted)

8 Device status

The content displayed differs as follows depending on the material.

Video from a VISCA-compatible camera being controlled remotely

Displays the VISCA-compatible camera's status.

No Response: communication cannot be established with the camera.

Initializing: appears at system startup and during camera reset.

INT graphics file

Loading: while file is loading

When playing a file on the external hard disk

The status of file operation is shown.

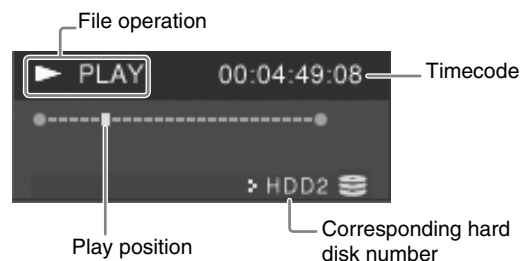

File operation indications

Opening: while opening a file

▶ **PLAY:** during playback

■ **STOP:** when stopped

|| **STILL:** when playback speed is set to zero with the shuttle dial or playback is stopped with the jog dial.

JOG: while using the jog dial.

▶▶ **x2:** fast forward (x2, x4, x8, x16, x32, x64)

◀◀ **x2:** fast reverse (x2, x4, x8, x16, x32, x64)

Note

The x1/8, x1/2, and x1 indications are also displayed while you are using the shuttle dial for playback operations.

Play position

This shows the file play position.

When the play position is at the beginning or end,

● of each end lights.

An icon appears on the right while auto repeat playback is set (page 150).

9 Hard disk status

When an external hard disk is connected, this shows the status of the hard disk, the remaining recording capacity, and the recording status.

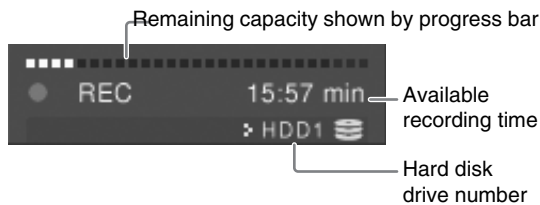

Recording operations

● || **REC PAUSE:** recording on standby

● **REC:** recording

Unformatted: error requiring formatting

Disk Full: no disk space left (200 MB or less)

File Number Full: the number of files that can be recorded has been exceeded

Device Error: it became impossible to recognize the hard disk during recording

REC Error: recording error

5 Effect display

This shows video transition effect types and patterns, and transition time (page 72).

Menu Operations

This unit includes top menus, which are used to make various operational settings, and ACCESS menus, which are used to make adjustments to the video and audio being input to this unit.

This section describes the basic operations common to these menus.

Displaying top menus and ACCESS menus

Top menus

Press the MENU button, to display the top menu in the menu display.

Top menu



When you select and confirm an item in the top menu, submenus appear, three levels deep.

Sub-menu



Note

You can set priority to be given to displaying the PVW viewer while submenus are open (page 90).

ACCESS menu

Press the ACCESS button corresponding to the number of input you want to adjust, to display the ACCESS menus, three levels deep, in the source viewer together with the viewer for that number.

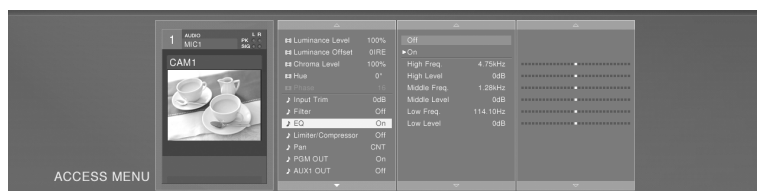



Menu operations

Selecting a menu item



Turn the jog roller up or down.
You can also use the ↑ and ↓ keys on the keyboard.

Streaming	
Disk Recording	
File Manager	↑
Job	
Video Frequency	58.94Hz
Video Input Assign	↓
Video Output	
Audio Input Assign	
Audio Output	

Confirming an item and proceeding to the next layer



Press the ENTER button.



Press the jog roller.

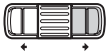

Press the → button by the jog roller.
You can also use the → key or ENTER key on the keyboard.

Pan / Tilt	Enable	Disable
Zoom	Enable	Disable
Focus	Auto	
Iris	Auto	
White Balance	Auto	

Returning to the higher level



Press the ← button by the jog roller.
You can also use the ← key on the keyboard.

Pan / Tilt	Enable	Disable
Zoom	Enable	Disable
Focus	Auto	
Iris	Auto	
White Balance	Auto	

Confirming a selection

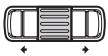

Press the ENTER button.
or
Press the jog roller.

You can also use the ENTER key on the keyboard.

Pan / Tilt	Enable	Disable
Zoom	Enable	Enable
Focus	Auto	
Iris	Auto	
White Balance	Auto	

Confirmation

Slider operation

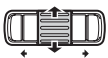

Turn the jog roller up or down.
You can also press ↑ or ↓ on the keyboard.





Entering numeric or text values

Moving the cursor to the next item:



Press the ← or → button by the jog roller.

You can also press the ← or → keys while holding down Ctrl on the keyboard.

2004/05/18 12:25



Entering numeric or text values:

Enter with the keyboard.

Confirmation:



Press the ENTER button.

or

Press the jog roller.



You can also use the ENTER key on the keyboard.

Closing a menu

For a top menu: Press the MENU button or ESC button.

For an ACCESS menu: Press the same ACCESS button used to display, or the ESC button.

Notes

- While a top menu is displayed, pressing the ACCESS button clears the top menu.
- While an ACCESS menu is displayed, pressing the MENU button clears the ACCESS menu.

Operation screen (Text Typing Tool Software)

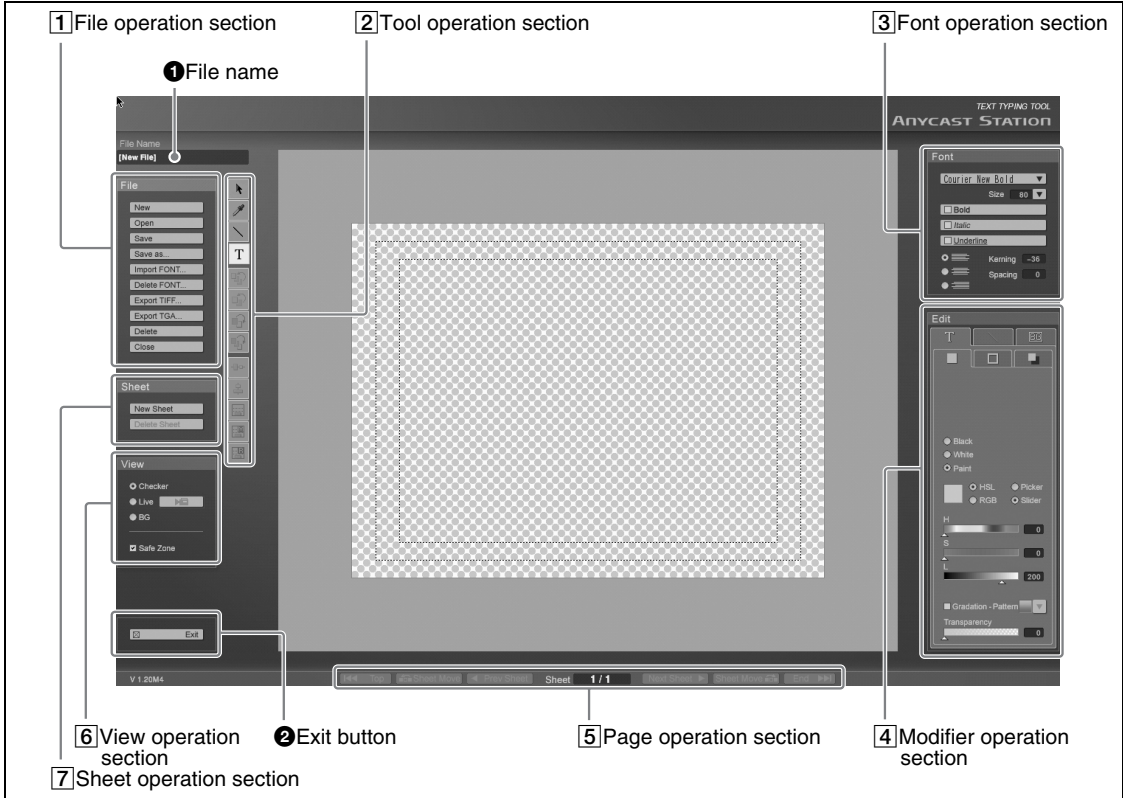

1 File name

This shows the name of the open file.

2 Exit button

Click this to exit the text typing tool software, and start the Anycast Station main software.

1 File operation section

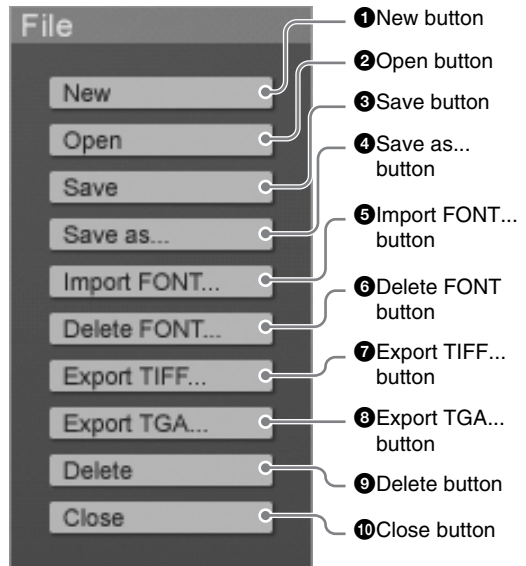

1 New button

This creates a new file (page 98).

2 Open button

This opens a previously saved file. A list of existing files appears (page 98).

3 Save button

This saves a file (page 99).

The file is also simultaneously saved in the Anycast Station main software, and the file name appears in the INT selection menu.

4 Save as... button

This saves the file with a different name (page 100).

5 Import FONT... button

This imports a font file from a “Memory Stick” or USB flash memory (page 129).

6 Delete FONT button

This deletes unwanted font files (page 130).

7 Export TIFF... button

This saves the open file to a “Memory Stick” or USB flash memory in TIFF format (page 102).

8 Export TGA... button

This saves the open file to a “Memory Stick” or USB flash memory in TARGA format (page 102).

9 Delete button

This deletes unwanted files (page 101).

10 Close button

This closes the open file, and displays a new sheet.

2 Tool operation section

Select the tools needed to create and edit an object.

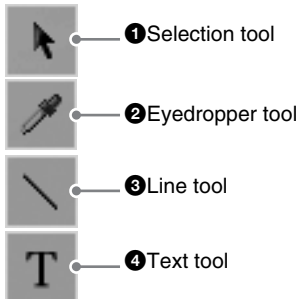
**1 Selection tool**

When you click this, the mouse pointer changes to , and you can select, adjust, and move an object (page 97).

An orange frame appears around the selected object.

2 Eyedropper tool

When you click this, the mouse pointer changes to , and you can set the color of the selected object to be the same as the color of another object or the background image (page 119).

3 Line tool

You can create a straight line.

You can create three types of line: solid, broken, and dotted.

4 Text tool

When you click this, you can create a text object (page 104).

Note

When the selection tool is selected, you can move the selected object with the keyboard arrow keys. Hold down the Shift key while pressing the arrow keys to speed up the movement.

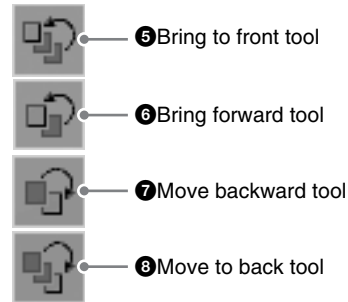
**5 Bring to front tool**

This brings the selected object to the front (page 122).

6 Bring forward tool

This brings the selected object one level forward (page 122).

7 Move backward tool

This moves the selected object one level back (page 122).

8 Move to back tool

This moves the selected object to the back (page 122).

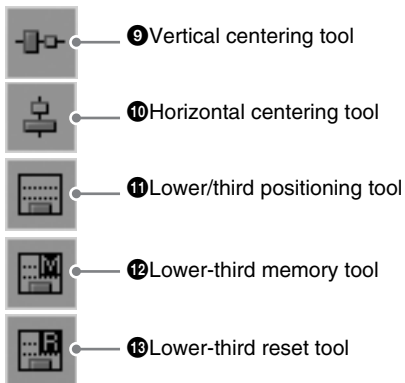

9 Vertical centering tool

This moves the selected object to the vertical center of the screen (page 123).

10 Horizontal centering tool

This moves the selected object to the horizontal center of the screen (page 123).

11 Lower-third positioning tool

This moves the selected object so that its lowest part is aligned to a predetermined position (page 123).

12 Lower-third memory tool

If you select an object and then click this tool, the lowest part of the selected object is set as the lower-third position.

13 Lower-third reset tool

Restores the lower-third position to its default setting.

3 Font operation section

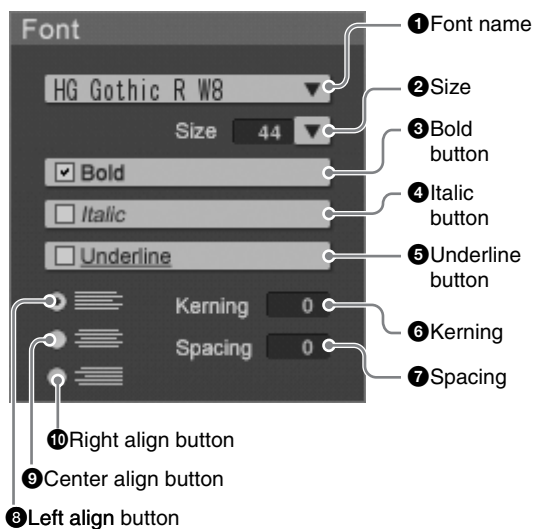

1 Font name

This selects the font for a text object (page 105). The currently selected font always appears.

2 Size

This selects the size of a text object (page 106).

3 Bold button

This sets the text object to bold face (page 107).

4 Italic button

This sets the text object to italic face (page 107).

5 Underline button

This underlines the text object (page 107).

6 Kerning

This sets the inter-character spacing of the text object (page 107).

7 Spacing

This sets the line spacing of the text object (page 108).

8 Left align button

Aligns a text object comprising multiple lines to the left (page 108).

9 Center align button

Aligns a text object comprising multiple lines to the center (page 108).

10 Right align button

Aligns a text object comprising multiple lines to the right (page 108).

4 Modifier operation section

Click the mark on a tab to select it, and bring it to the front.

The modifier operation section has three tabs: [Text], [Line], and [BG]. The [Text] tab and [Line] tab are further divided into three tabs.

■ Text tab

You can set the color and other settings of a text object. This tab is divided into the Color tab, Edge tab, and Shadow tab.

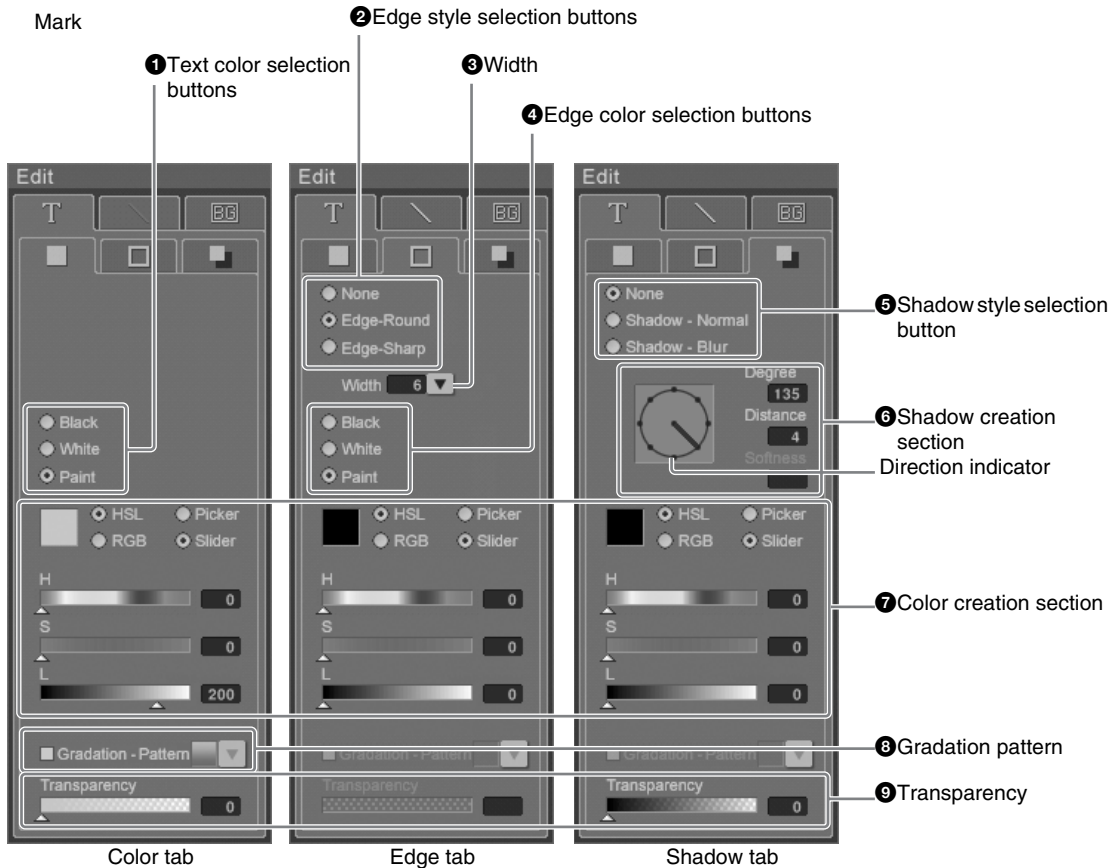

1 Text color selection buttons

Select the color of a text object (page 109).

2 Edge style selection buttons

Select whether the object has an outline ([None] for no outline), and select the shape of corners (page 110).

3 Width

Set the width of the outline. Select or enter a numeric value (page 110).

4 Edge color selection buttons

Select the color of the outline (page 110).

5 Shadow style selection button

Select whether the object has a shadow ([None] for no shadow), and select the style of the shadow (page 113).

6 Shadow creation section

Adjust the angle, distance, and degree of blurring of the shadow (page 113).

Direction indicator: Click this to move the needle, and change the direction of the shadow of the object to that of the needle.

Degree: Set a numerical value for the direction of the shadow.

Distance: Set a numerical value for the distance of the shadow.

Softness: Set a numerical value for the degree of blurring of the shadow.

7 Color creation section

When [Paint] is selected in the Color tab and Edge tab, you can create your own color for the outline and shadow of the object (page 118).

8 Gradation pattern

Apply gradation to the color of the object (page 121).

Line tab

You can set the color and other settings of a line object. This tab is divided into the Color tab, Edge tab, and Shadow tab.

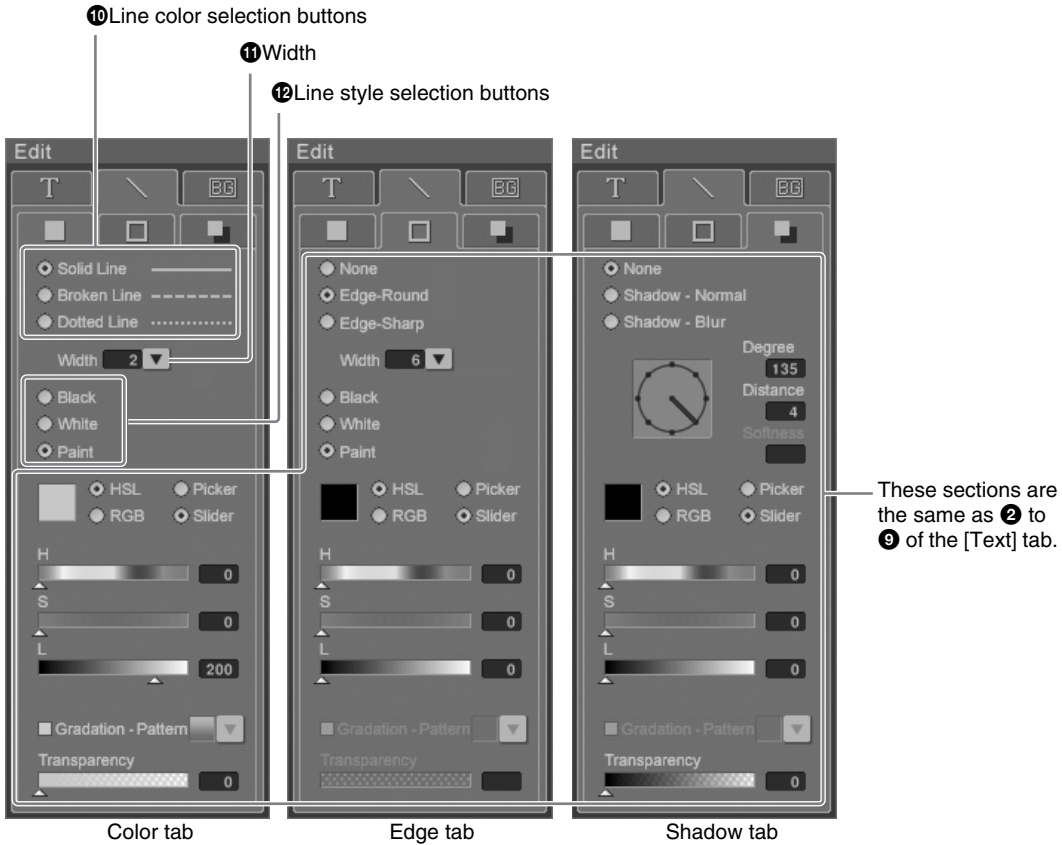

10 Line color selection buttons

Select the color of the line object (page 112).

11 Width

Set the line width of the line object. Select or enter a numeric value (page 112).

12 Line style selection buttons

Select the line style of the line object (page 113).

■ BG tab

You can set the background color.

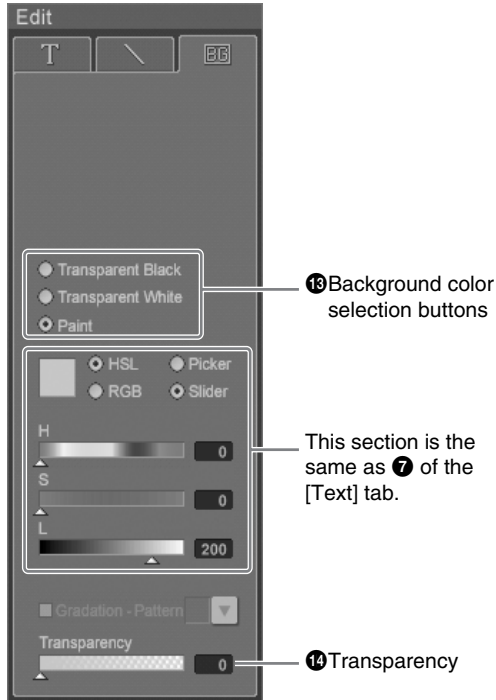

13 Background color selection buttons

Select the background color (page 115).

14 Transparency

Set the transparency of the background created with paint.

5 Page operation section

This is used for sheet display, sheet turning, and resequencing.

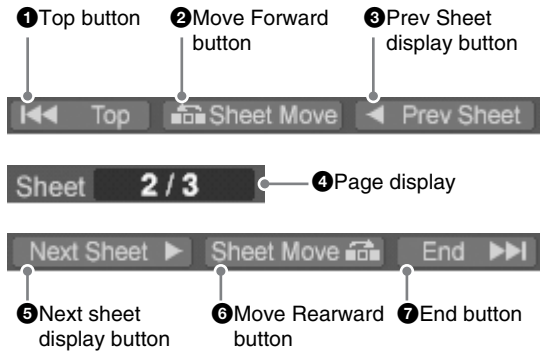

1 Top button

Click this to display the first sheet.

2 Move Forward button

Click this to exchange the currently displayed sheet with the previous sheet.

3 Prev Sheet button

Click this to display the previous sheet.

4 Page display

This shows the sheet number of the currently displayed sheet.

5 Next Sheet button

Click this to display the next sheet.

6 Move Rearward button

Click this to exchange the currently displayed sheet with the next sheet.

7 End button

Click this to display the last sheet.

6 View operation section

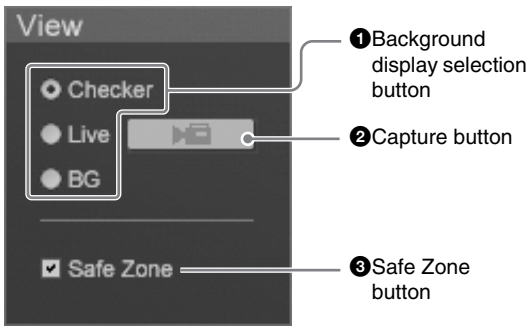

1 Background display selection button

Set the background display (page 126).

Checker: display a checkered pattern as the background.

Live: display the program output video of the main software (page 125).

BG: display the background selected on the [BG] tab (page 125 and 125).

2 Capture button

The program output video image of the main software is captured each time this button is clicked (page 126).

3 Safe Zone button

When this is selected, a dotted line shows the safe zone (page 127).

7 Sheet operation section

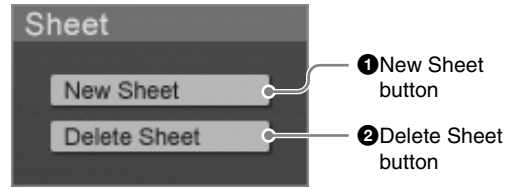

1 New Sheet button

This adds a sheet to the open file (page 125). You can create up to 99 sheets.

2 Delete Sheet button

This deletes the open sheet (page 125).



Installation/Default Settings

This section describes the procedure for installing the unit, connecting the power cord, starting up the system, and setting the date, time, and video output signal format.

Installing the Unit

Install the unit in a level place. The unit weighs about 17.7 lbs (8 kg). Check that the installation location is strong and spacious enough to accommodate the unit before installing.

There are ventilation holes on both sides of the unit. To ensure adequate air flow, there must be a space of at least 12 inches (300 mm) on each side of the unit.

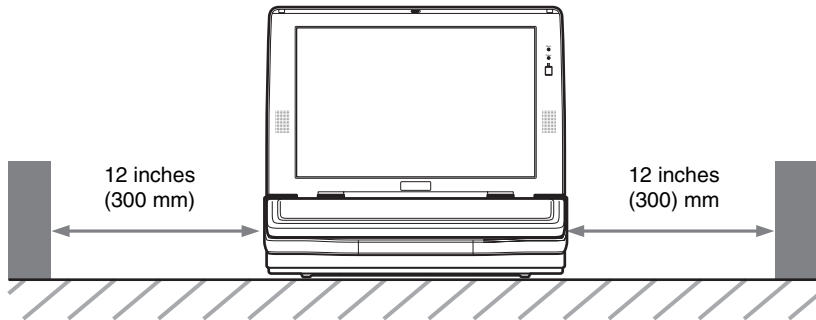

Connecting the power

Connect the power cord to the power inlet on the unit and the wall outlet.

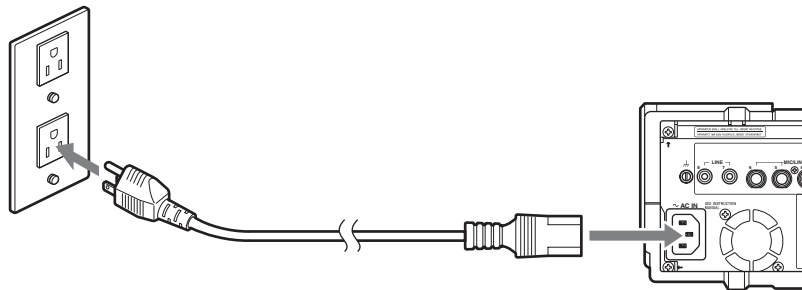

Note

Use a 3-pin - 2-pin conversion adaptor, if required.

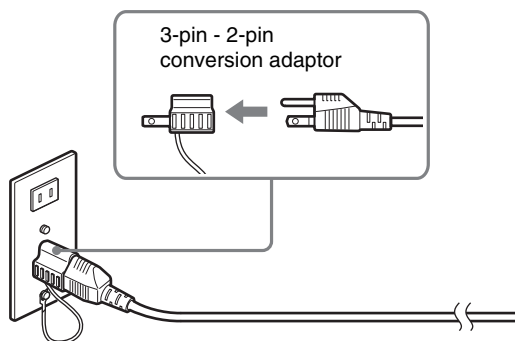
**Caution**

Connect the grounding lead of the 3-pin/2-pin adaptor to the ground terminal. If grounding is not possible, consult your dealer or your Sony service representative.

Fitting a Keyboard

To install the keyboard in this unit, align it with the keyboard space, with the keys upward, and slide in the direction shown by the arrow. Power is supplied to the keyboard from the main unit, and the EXT POWER indicator on the keyboard lights.

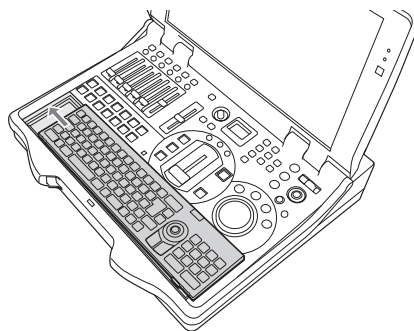
**Note**

When not using the keyboard, you can insert it upside down. In this case, no power is supplied to the keyboard.

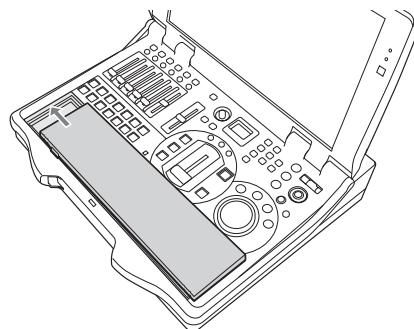



Using the keyboard away from the unit

You can use the keyboard away from the unit. In this case, it is necessary to insert a pair of standard batteries (CR2032) to power the keyboard.

Detaching the keyboard

Using the groove locating at the right of the keyboard space, lift the keyboard out.

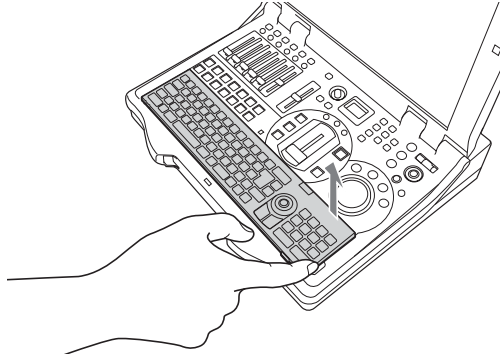

Inserting batteries in the keyboard

- 1 Detach the keyboard from the main unit.
- 2 Detach the battery holder from the keyboard.

Caution

To remove the battery holder, use the end of a sharp implement such as a pen.

- 3 Load two batteries (CR2032) in the battery holder, and insert in the keyboard.

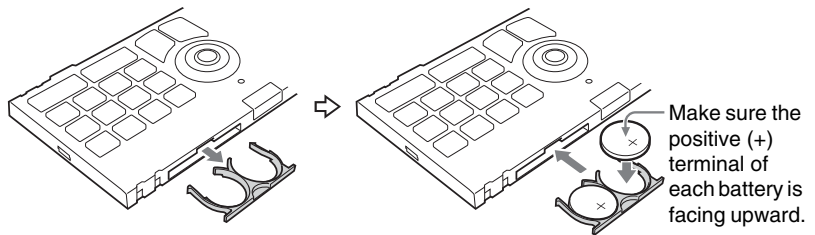

Caution

If batteries are inserted incorrectly, this may lead to electrolyte leakage or other damage. Note the following carefully.

- Check that the polarity is correct.
- Do not use new and old batteries together, or batteries of different types.
- Do not attempt to charge the batteries.
- When not using the keyboard for a long period, remove the batteries.
- If a battery should leak, remove any spilled fluid from the battery holder, before inserting a new battery.

Infrared transmitting range

The range over which the keyboard can operate with infrared control is shown in the following figure.

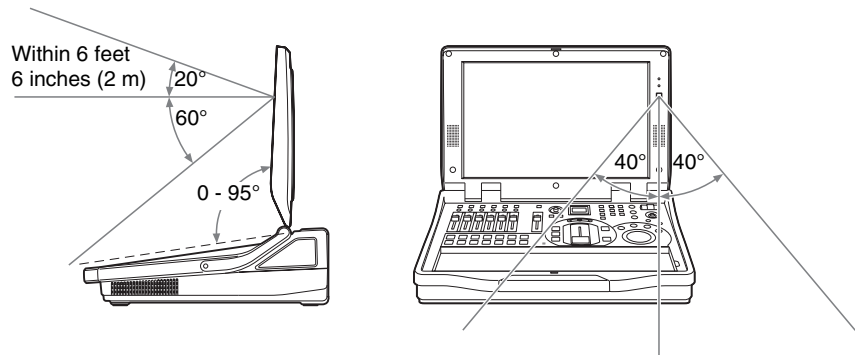

Starting and Closing Down the Unit

Starting

Press the  (power) button on the side panel.
The startup screen appears.

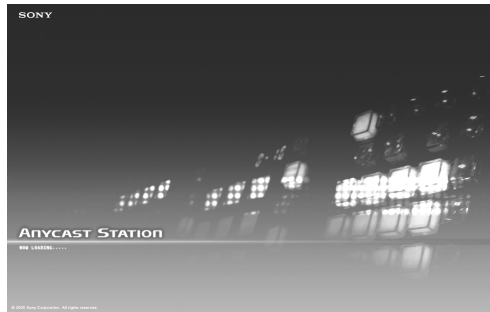

When the startup completes, the operation screen appears.

Caution

If the display is closed while the unit is operating, the temperature will rise, and this may cause failure.

Closing down

Press down the  (power) button on the side panel.
The following message appears.

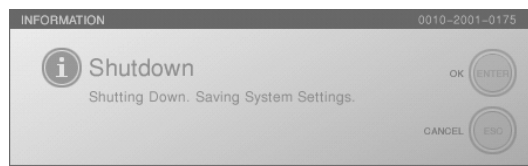

Notes

- The last set data is saved.
- If an external hard disk is connected, it is automatically unmounted (page 150).

This closes down the operating software, and powers off.
It takes a little while before the power turns off after the screen disappears.

Caution

If you hold down the power button for at least 4 seconds, this forces a shutdown.
After a forced shutdown, the settings of the unit may not be preserved.

Using the timer to shut down the system/Releasing the timer setting

- 1 While the Anycast Station main software is running, hold down the keyboard Alt and Ctrl keys, and press the T key.
The following confirmation message appears.

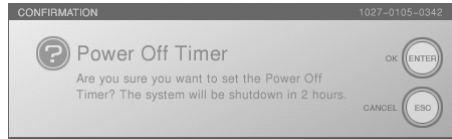

Note

It is not possible to use this function while the text typing tool software is running.

- 2 To set the timer, press the ENTER button.
To release the timer, press the ESC button.

When setting the timer

The timer indication appears to the right of "LOCAL TIME".



When the text entry tool is started, the timer display disappears, but the timer function continues to operate.

Note

The countdown appears from -120 min.

After two hours the system is powered off.

When releasing the timer

The timer display disappears.

Selecting the Keyboard Language

Set the language to correspond to the keyboard being used.
The default setting is “English.”

- 1 Press the MENU button.
- 2 In the top menu, select [Language].
- 3 Select the appropriate language from the list, and confirm.

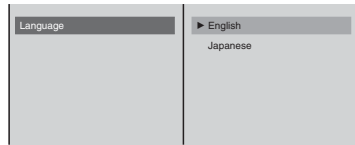

The operation screen appears as shown below.

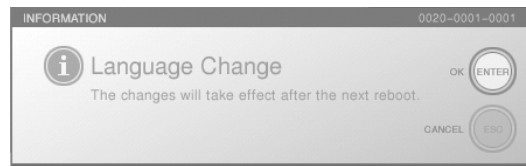

- 4 Confirm the message that appears, and press the ENTER button.
- 5 Press the MENU button to close the menu.
- 6 Restart the system.

Setting the Time Zone

Set the time zone for your geographical location.

- 1 Press the MENU button.
- 2 In the top menu, select [Date/Time].
- 3
 - ① Select [Time Zone], and confirm;
 - ② select the area, and confirm;
 - ③ select the region, and confirm.

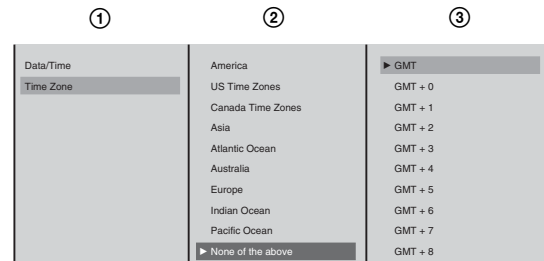

- 4 Press the MENU button to close the menu.

Note

The notation system for displaying time zone data in relation to GMT is based on the form POSIX minutes-west-of-GMT in which the hour decreases as you move east and increases as you move west.

Setting the Date and Time

Set the internal clock.

- 1 Press the MENU button.
- 2 In the top menu, select [Date/Time].
- 3 ① Select [Date/Time], and confirm; ② enter the date and time in the input box, and confirm.

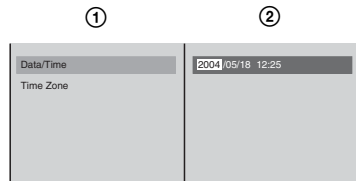

Using the arrow buttons on the jog roller (or the ← and → keys while holding the Ctrl key on the keyboard), select the item to change and enter a numeric value with the keyboard.

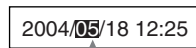

Each whole value between the separators (/, :, or space) is selected.

The time set in “Local Time” appears at the upper left of the operation screen.

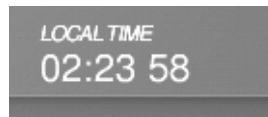

- 4 Press the MENU button to close the menu.

Caution

If this unit is operated for a long period, the clock may drift out of its correct setting. Resetting the clock at regular intervals is recommended.

Adjusting the Display Brightness

Adjust the brightness of the display on which the operation screen is shown.

- 1 Press the MENU button.
- 2 In the top menu, select [LCD Backlight].
- 3 Move the slider to adjust the brightness.



- 4 Press the MENU button to close the menu.

Selecting the Video Output Signal Format

Select the format of the signal output from the PGM output connectors (COMPOSITE/S VIDEO), SD video interface module DV connectors, and the reference output connector on the rear panel.

- 1 Press the MENU button.
- 2 In the top menu, select [Video Output].
- 3 ① Select [PGM OUT], and confirm; ② select the signal format, and confirm.

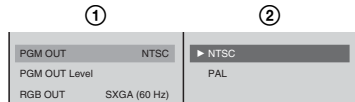

- 4 Press the MENU button to close the menu.

Caution

Carrying out this selection may cause momentary breakup of the output video.

Note

Video input in a different signal format than this setting can still be displayed (i.e., displaying a PAL video input when set to “NTSC” or vice versa), but the video quality cannot be guaranteed.

Connections

This section describes how to connect devices for video and audio input and output. The following figure shows an example system configuration and signal flow. Refer to the pages indicated for details of how to make connections. In addition, after connecting each device, you must configure settings on the unit for each input and output signal. See page 56 for details on the settings of each input and output signal.

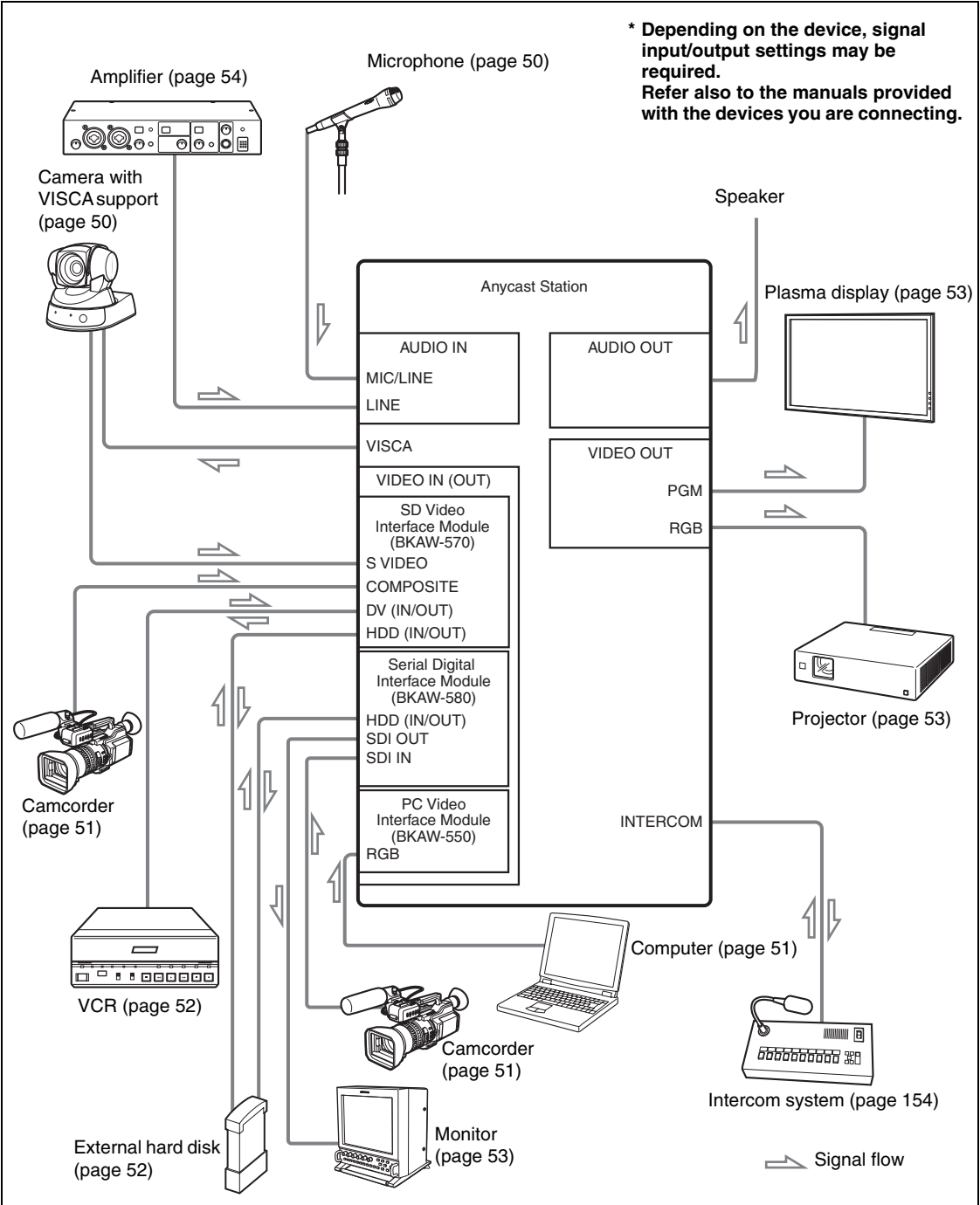

Caution

- Use the shortest possible cable type (especially with unregulated RGB). Shorter cables are recommended because, in general, using long cables to connect devices increases the risk of signal noise. Even when connecting this unit to another, it is best to use the shortest cables possible.
- Be careful with the connector portions of the interface modules, which may become hot depending on the conditions of operation.

Connecting a Camera with VISCA Support

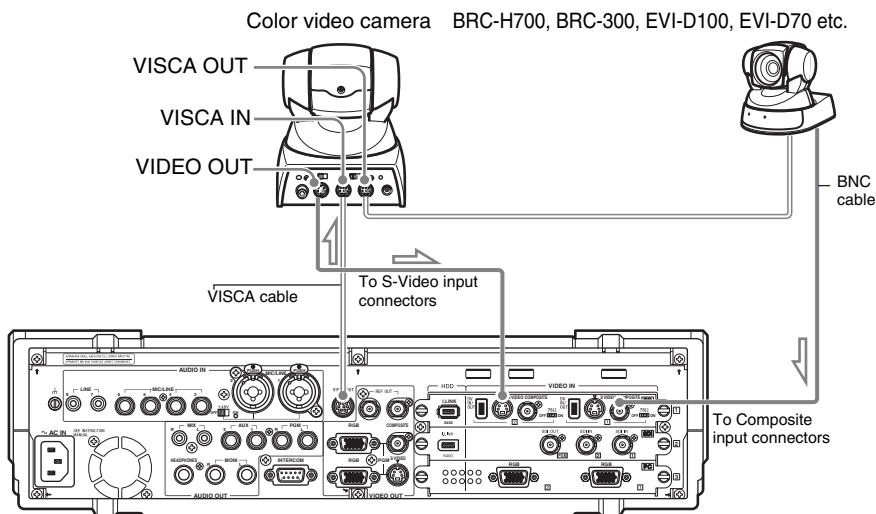
**Notes**

- VISCA cables up to 15 m (50 ft) are recommended to operate correctly.
- When connecting a BNC cable, an RCA-BNC adaptor is required.
- If the camera is a BRC-H700, connect it to the RGB input connector or the SDI input connector to correspond to the camera.

Connecting a Microphone

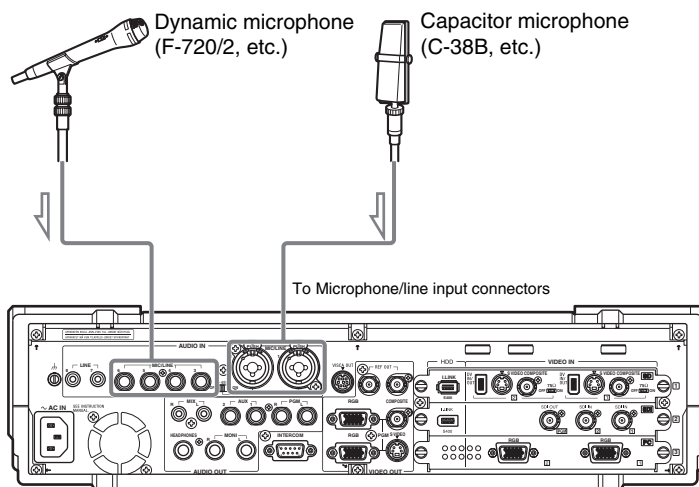

Connecting a Computer (RGB Input)

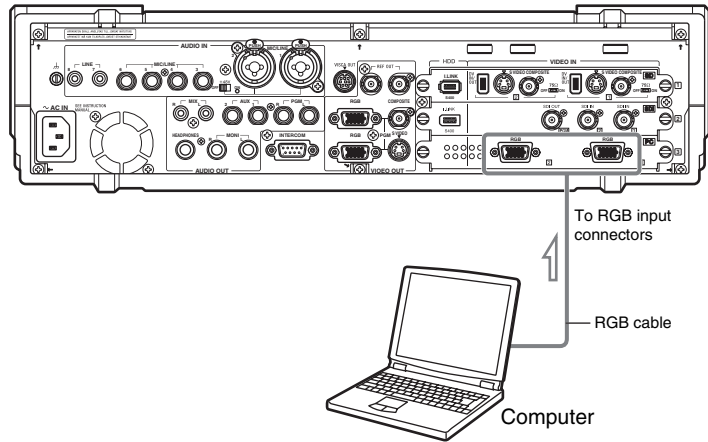

Note

To reduce the effects of external noise, use a cable with an attached ferrite core.

Connecting a Camcorder

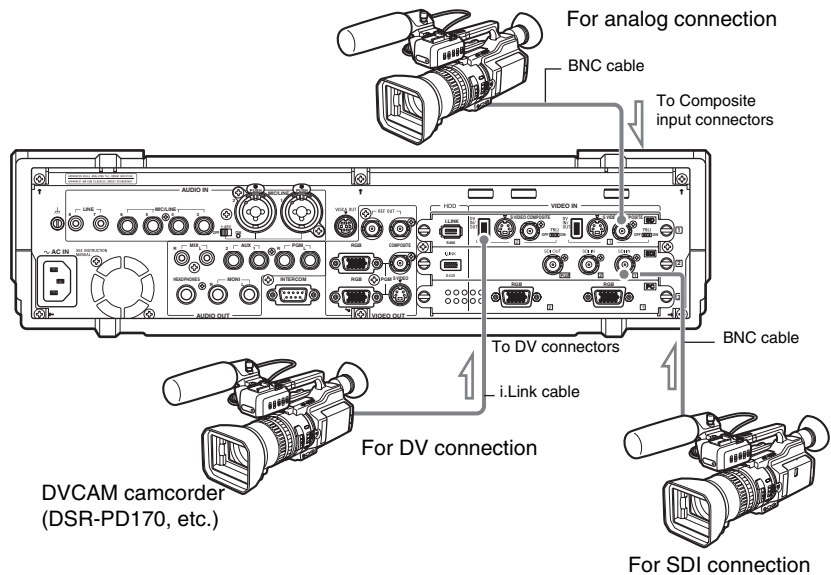

Note

i.LINK cables between 80 cm and 3.5 m (2.5 to 11.5 ft) are recommended.

Caution

- The frequency precision of the reference output signal is within 50 ppm. When building a system that includes devices such as a camera with a Gen Lock input, be sure to test it thoroughly before use.
- The color frame of the program output signal does not reflect the color frame sequence of the reference output signal.

- If video or audio is not output or signal noise occurs when connected to another DV device, the problem can often be resolved by reconnecting the cables or turning the DV device or the unit off and then on again.

Connecting a VCR

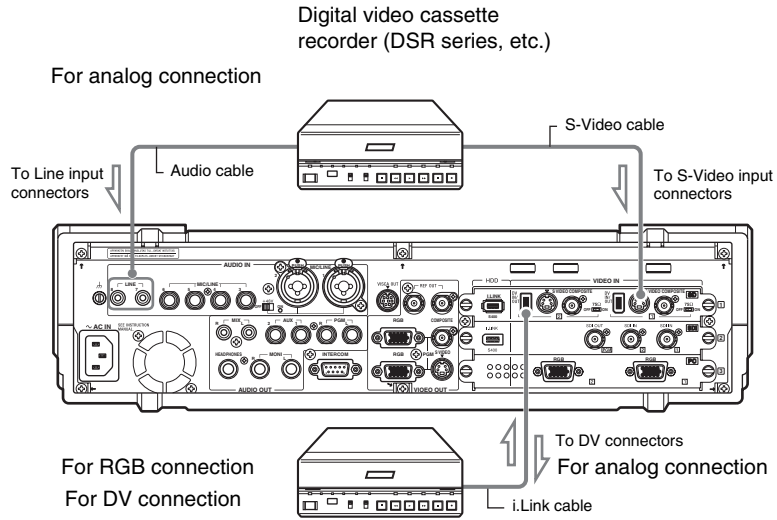

Note

i.LINK cables between 80 cm and 3.5 m (2.5 to 11.5 ft) are recommended.

Caution

- If when connected to another DV device the video or audio is not output, or there is noise, reconnect the cable, or power the DV device or this unit off and on again. This may solve the problem.
- It is not possible to connect more than one VCR to a single DV connector.

Connecting an External Hard Disk

For information about external hard disks, visit the following Anycast Station portal site:

<https://www.ecspert.sony.biz/ecsite/>

<https://servicesplus.us.sony.biz/SoftwarePlusSearch.aspx> (for the customers in the U.S.A.)

<https://www.sonybiz.net/anycast> (for the customers in Europe)

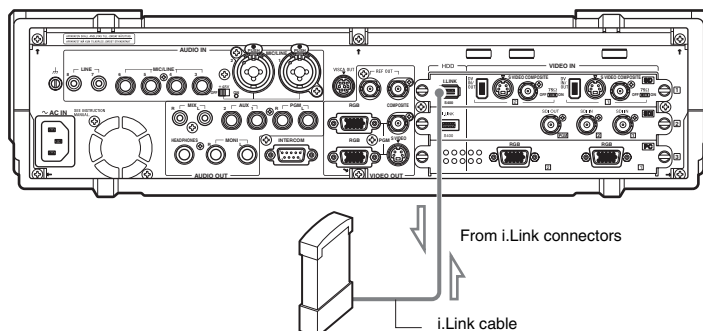



Caution

- If using a hard disk with a standby function, make sure that the standby function is disabled before connecting to this unit.
- Power on the connected hard disk before powering on this unit.
- Connect the i.LINK connector directly to the hard disk.
- It is not possible to connect more than one hard disk to a single i.LINK connector (daisy-chaining connection not possible).
- If you disconnect the i.LINK cable, or power off the hard disk without carrying out the necessary preparations for disconnecting the disk, then files may be corrupted, or the disk may need to be recovered. For details of unmounting, see “Disconnecting the External Hard Disk” (page 150).

Connecting a Plasma Display/Projector/Monitor

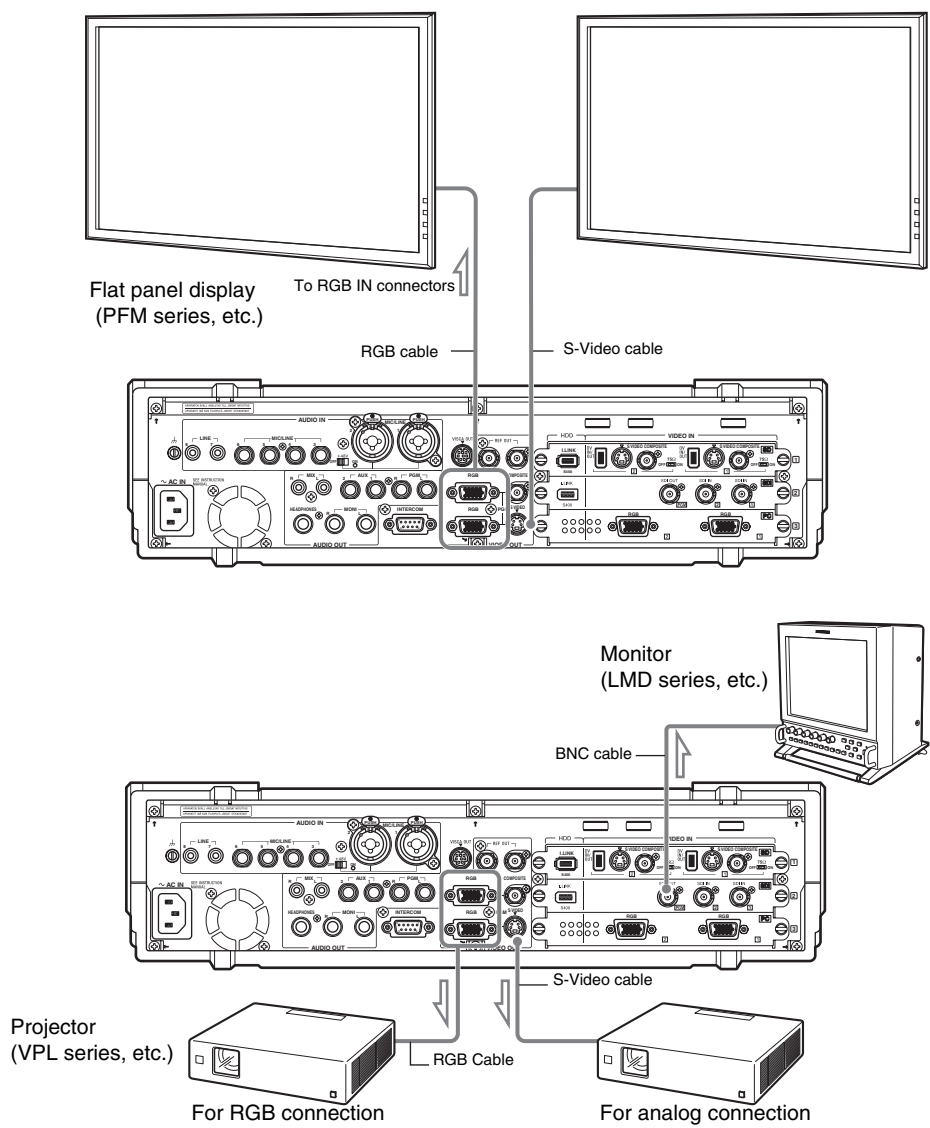

Notes

- For more information on setting the resolution/clock phase and format, see “Setting the RGB Output Signal Format” (page 162)
- To reduce the effects of external noise, use a cable with an attached ferrite core.

Connecting an Amplifier

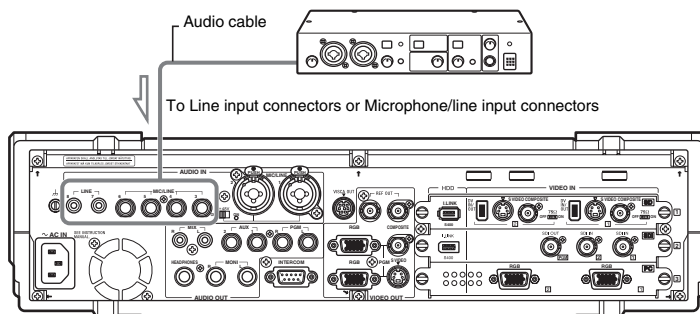

Preventing Accidental Cable Disconnection

Use the cable clip as necessary to secure cables and prevent accidental disconnection.

- 1 Using a flat head screwdriver, open the lever compartment as illustrated below.

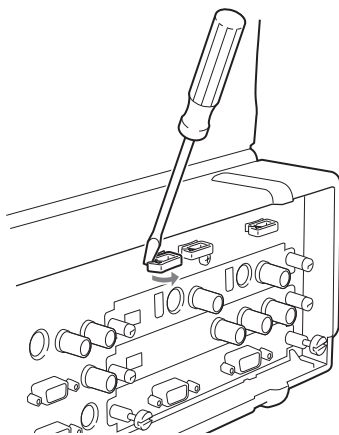

- 2 Pass the cables through the cable clip.
Allow some slack when routing the cables to prevent them from bending sharply.

- 3 Close the lever compartment.

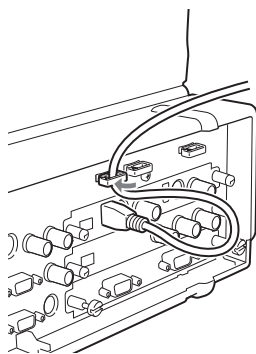

Installing Option Modules

To install an option module, first remove the interface module fitted to the unit as standard, and install the new interface in the slot.

Note

You can install an option module in any slot.

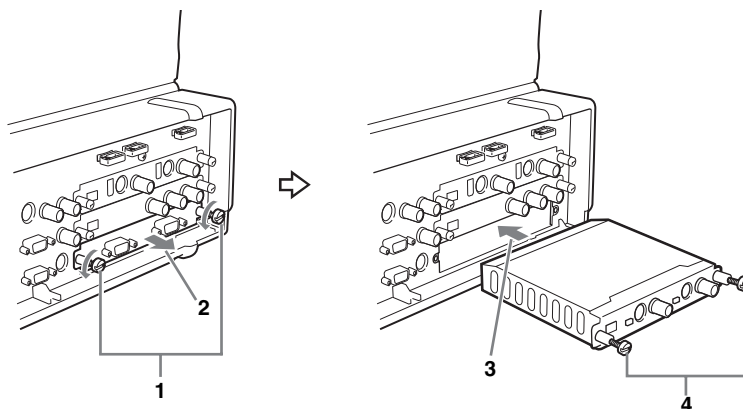

- 1 Loosen the two screws fixing the interface module fitted as standard.
- 2 Pull out the interface module.
- 3 Insert the option module into the slot.
- 4 Tighten the screws.

Caution

When installing an option module, always turn the unit off first. If you install an option module with the unit powered on, this may damage the option module.

Settings Related to Input Signals

These settings allow video and audio signals input from devices connected to the unit to be handled within the unit.

Relation Between Input Signals and System Components

You can assign input video and audio signals to buttons on the front panel and channel faders, then operate these to carry out switching, mixing, and combining. The operation screen continuously displays information about the video and audio input to this unit, and the video and audio program output. The following figure shows the relation between the input signals and system components, and the display on the operation screen.

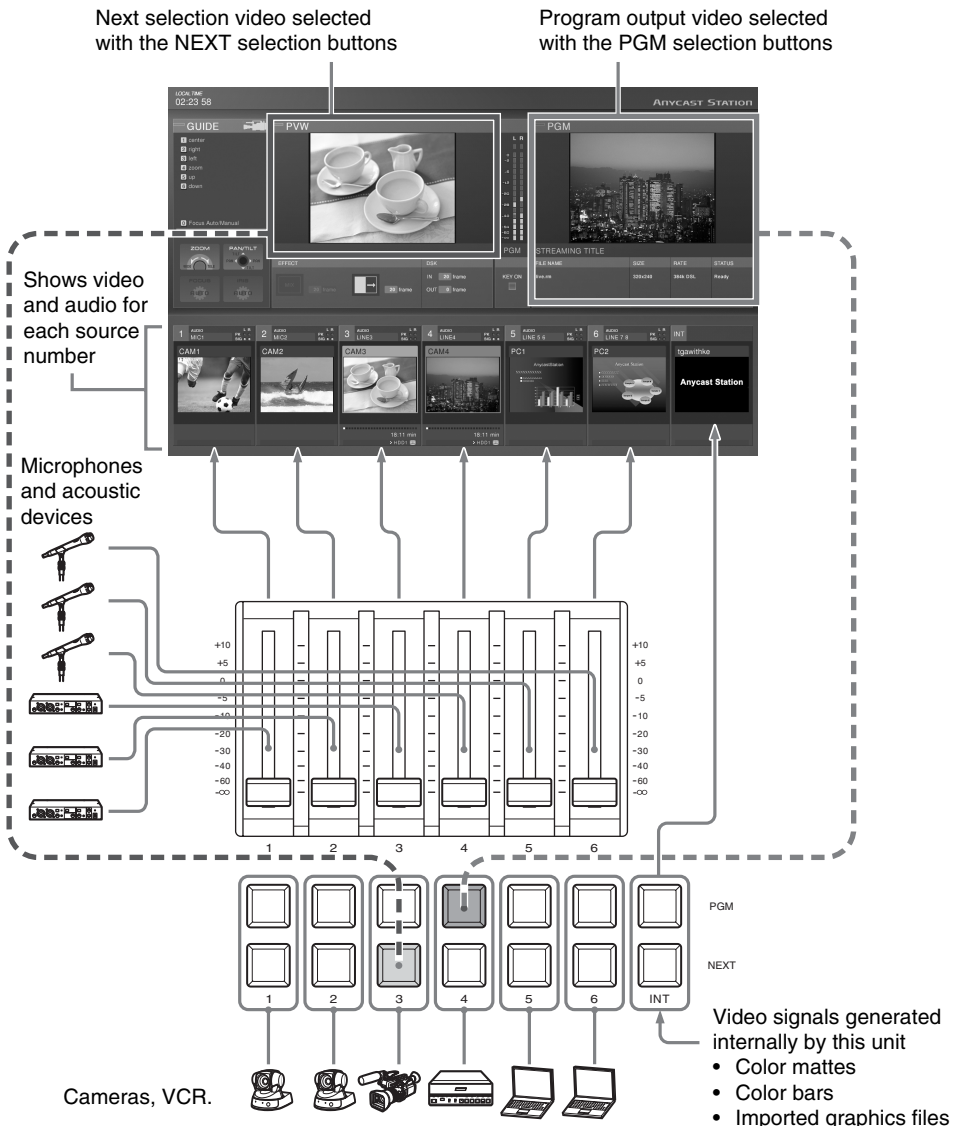

Video Signal Related Settings

These are preparations for handling video signals or the unit.

Assigning video input signals to the selection buttons

Assign video signals to the selection buttons 1 - 6 (PGM selection and NEXT selection buttons).

- 1 Press the MENU button.
- 2 In the top menu, select [Video Input Assign].
- 3 From the list select the number of the selection button, and confirm, then set the following items in the submenu.

Assigning a name for the video

Assign a name for the video. The name assigned here appears in the source viewer with the same number as the selection button.

- ① Select [Source Name], and confirm; ② enter the name in the input box, and confirm.

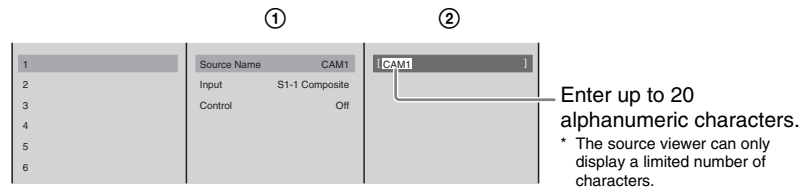

Specifying a video input connector

Specify the video input to be assigned to the selection button is input.

- ① Select [Input], and confirm; ② select the video input connector from the list, and confirm.

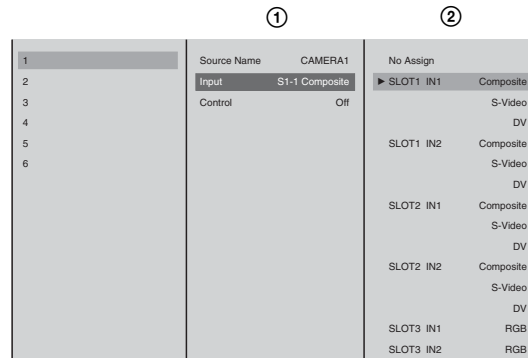

Notes

If a serial digital interface module is installed, the SDI input connectors appear in the list.

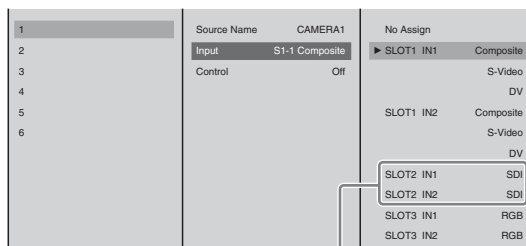

When installed in slot 2

Caution

- You can only use one of the following from the same video input on the same interface module: Composite (Composite video input connector), S-Video (S-Video input connector), or DV (DV connector).
- It is not possible to assign more than one selection button to a single video input connector. If you attempt to assign to a different selection button a video input connector which has already been assigned to a selection button, a confirmation message appears. If you then select [OK], the assignment switches to the new selection button, and the material viewer for the originally assigned selection button shows the indication “No Input Assign”.
- **About the DV signal lock time**
When DV is selected for the input video, there is a delay until the DV signal locks and the video appears.
- **When a serial digital interface module is installed**
You cannot assign the following audio to channel faders of source numbers assigned for video of SDI signals.
 - DV input audio
 - Audio of SDI signals input through the other SDI input connector.

Notes

- The items in the list depend on the interface module installed in this unit.
- For details of [Control] in the menu ①, see “Registering Cameras to be Controlled” (page 132).

- 4 If required, repeat step 3 similarly for the remaining selection buttons.
- 5 Press the MENU button to close the menu.

Audio Signal Related Settings

These are preparations for handling audio signals on the unit.

Assigning audio input signals to channel faders

Assign audio signals input from the audio input connectors or signals input from the interface modules of the rear panel to channel faders 1 to 6.

If you assign different audio signals to the left and right channels (L/R) of the channel faders, they become stereo faders, and if you assign the same audio signal to both channels, they become monaural faders.

Caution

If you assign DV signals or SDI signals, they become stereo faders.

- 1 Press the MENU button.
- 2 In the top menu, select [Audio Input Assign].
- 3 Select the channel fader number from the list, and confirm, then set the following items in the submenu.

Assigning a name

Assign a name to the audio signal. The name assigned here appears in the source viewer with the same number as the channel fader.

- ① Select [Source Name], and confirm; ② enter the name in the input box, and confirm.

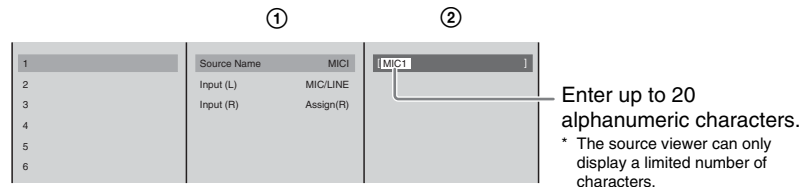

Specifying an audio input connector

Specify the audio signal to be assigned to the channel fader. For stereo audio, specify the source for each of the left and right channels separately.

For monaural audio, specify the same input for both left and right channels.

- ① Select [Input (L)], and confirm; ② select the audio input connector from the list, and confirm.

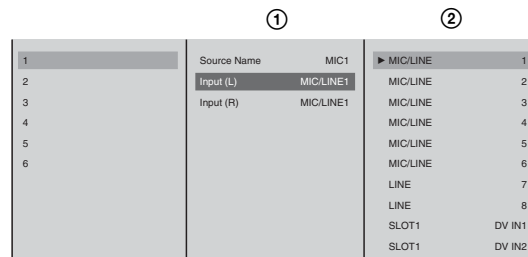

Notes

- If in [Input (L)] you select the DV input connector, the same input connector is automatically assigned to [Input (R)].
- **When a serial digital interface module is installed**
 - The SDI input connectors for individual channels are displayed.

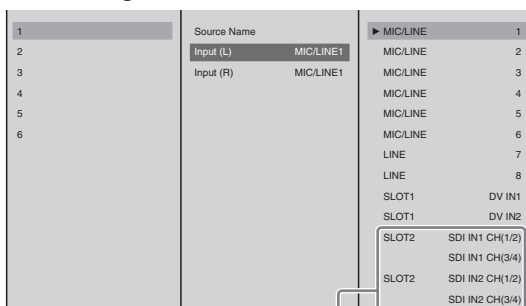

When installed in slot 2

- If you select CH (1/2) of the SDI input connector for either [Input (L)] or [Input (R)], CH (1) and CH (2) are assigned automatically to [Input (L)] and [Input (R)], respectively.

When you select CH (3/4) of the SDI input connector, CH (3) and CH (4) are assigned automatically to [Input (L)] and [Input (R)], respectively.

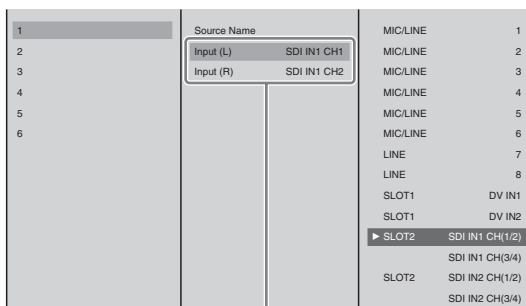

When CH (1/2) of SDI IN1 is assigned

Caution

- For DV input, it is not possible to assign more than one selection button to a single DV input connector. If you attempt to assign to a different selection button a DV input connector which has already been assigned to a selection button, a confirmation message appears. If you then select [OK], the assignment switches to the new selection button, and the originally assigned selection button returns to the default setting.
- **About the DV signal locking time**

When DV is selected for the input audio, there is a delay until the DV signal locks and the audio can be heard.
- **When a serial digital interface module is installed**
 - SDI embedded audio can only be assigned to the channel fader of the source number assigned to video that is input to the same SDI input connector. It cannot be combined with analog input video, DV input video, or video of the other SDI input connector.



- SDI embedded audio cannot be assigned simultaneously to CH (1/2) and CH (3/4) of the same SDI input connector.

Similarly, select [Input (R)], and confirm; select the audio input connector from the list, and confirm.

When the input audio signal reaches the reference level, the input signal indication in the source viewer lights green and you can confirm that there is an audio input.

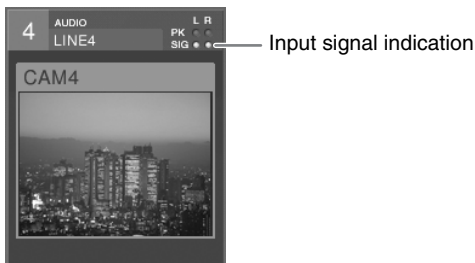

- 4 Press the MENU button to close the menu.

Setting the MIC/LINE level of an audio input

If the peak indication appears (when set to the default MIC/LINE level of “Middle (-20 dB)”)

If the input audio signal is too loud, the peak indication in the source viewer lights red.

In this case, since the MIC/LINE level exceeds the standard input level, use the following procedure to adjust it.

Example: When the peak indication has lit with MIC/LINE 2 connected to R and MIC/LINE 1 connected to L, as illustrated below.

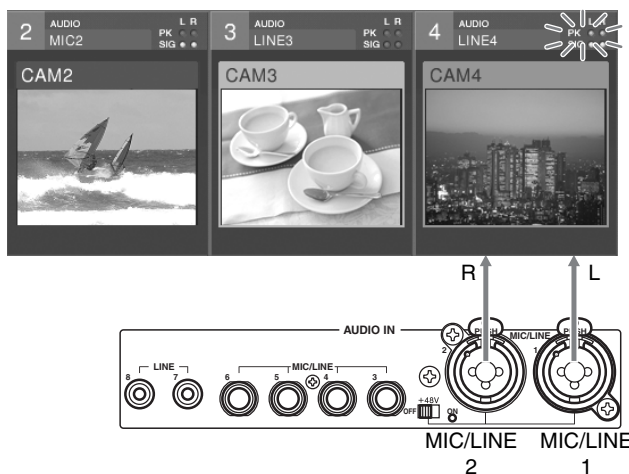

- 1 Press the MENU button.
- 2 In the top menu select [Audio MIC/LINE Level].



- 3** ① Select the number of the MIC/LINE input connector to which is connected the target audio signal, and confirm; ② select [High(+4dB)], and confirm.

In this example, both [MIC/LINE 1] and [MIC/LINE 2] are set to [High (+4dB)].

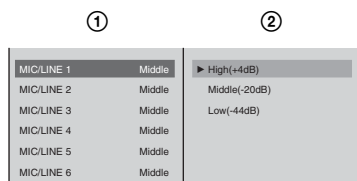

- 4** Press the MENU button to close the menu.

If no input signal indication appears (when set to the default microphone/line level of “Middle (-20 dB)”)

If no input signal indication appears in the source viewer even though an audio signal is input, the microphone/line level is not reaching the reference level. Using the same procedure as detailed in “If the peak indication appears” above, select the number of the microphone/line input connector, and at step 3-②, select [LOW (-44dB)], and confirm.



Relation Between Program Output Display and Input and Output Formats

Depending on the format and resolution of the input signal, the size and cropping of the output video is as follows.

Material with a 4:3 aspect ratio

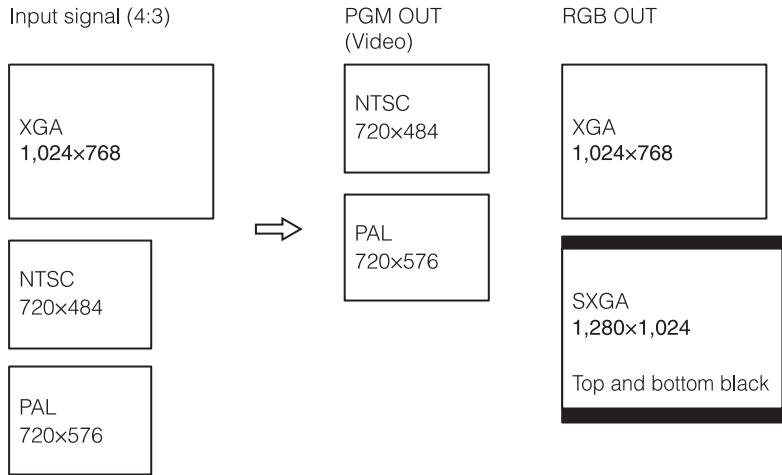

Material with a 5:4 aspect ratio

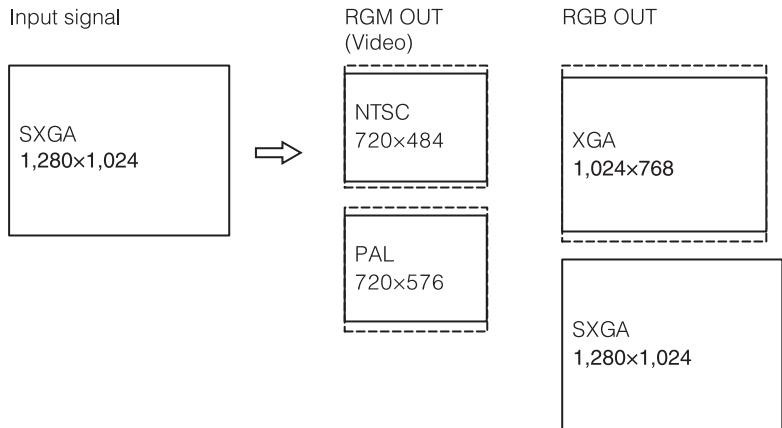



Video Switching

This section describes how to switch the video signals input to the unit, and output the final video (output program) from the PGM output connectors. With this unit, you can also apply some video effects.

Note

First, make the settings described in “Video Signal Related Settings” (page 57).

Basics of Video Switching

This section describes only the most basic switching operations. See the relevant sections for details of switching and effect operations.

Cut switching

This is the most basic and commonly used type of switching. The video changes instantaneously from A to B.

For details, see “Changing the Video with a Cut” (page 66).

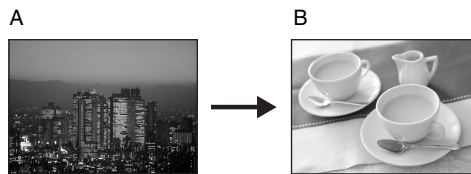

Switching with a transition effect

In a transition effect, the image gradually switches from one video to another through the application of one of various effects.

For details, see “Changing the Video with a Effect Transition” (page 68).

Changing the Video with a Cut

This switches the video instantaneously, with no added effects. This is the most basic form of switching.

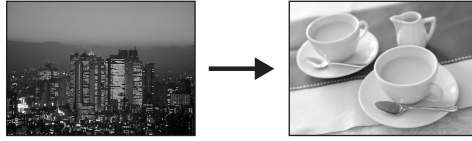

Basic operation for a video cut

There are two methods of making a cut, as follows.

- Switching directly by pressing a PGM selection button
 - Checking the next video in the PVW viewer, then pressing the CUT button
- The following diagram shows the flow of operations in carrying out a video cut.

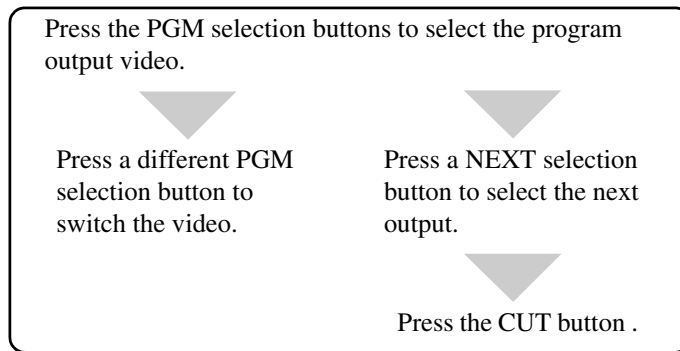

Switching directly by pressing a PGM selection button

To switch from one video to another, you can simply press the PGM selection button to which the new video is assigned.

- 1 In the source viewer, select the video for program output.



Example: You may select video 4.

- 2 Press the PGM selection button with the same number as the selected video.

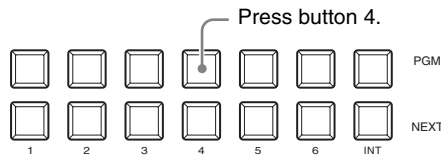

The PGM selection button you pressed lights red, and the selected video appears in the PGM viewer.

The same video as shown in the PGM viewer is now output from the PGM output connectors.



A red frame appears around the source viewer for the selected video.

- Determine on the next video, then repeat the procedure in step 2.

Switching with the CUT button after checking the next video in the PVW viewer

To switch while checking the new video in the PVW viewer, use the CUT button.

- In the source viewer, select the video you want to switch to (the next program output).



Example: You may want to switch to video 3. Current program output video

- Press the NEXT selection button with the same number as this video.

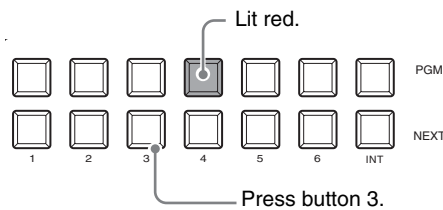

The NEXT selection button you pressed lights amber, and the selected video appears in the PVW viewer.



An amber frame appears around the source viewer for the next video.

3 Press the CUT button.

This interchanges the video in the PGM viewer and PVW viewer, and switches the program output video.

At the same time, the lit PGM selection button and NEXT selection button interchange, and the colors of the frames in the source viewer also interchange.

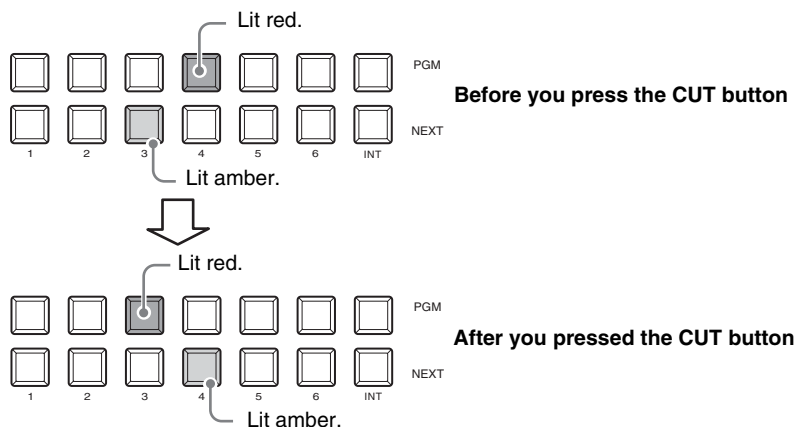

Each press of the CUT button interchanges the program output video and the NEXT selection video.

Changing the Video with a Effect Transition

Instead of an instantaneous cut, you can gradually switch from one video to another through the application of one of various effects.

Basic transition effect operations

The basic procedure for applying an effect to a transition is as follows.

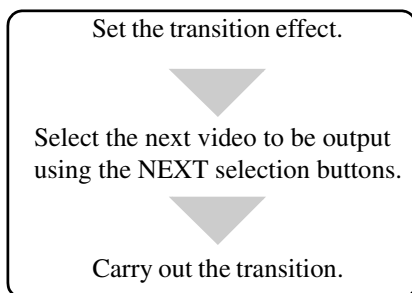

There are two ways of executing a transition:

- Automatic execution with the AUTO TRANS button
- Manual execution using the transition lever

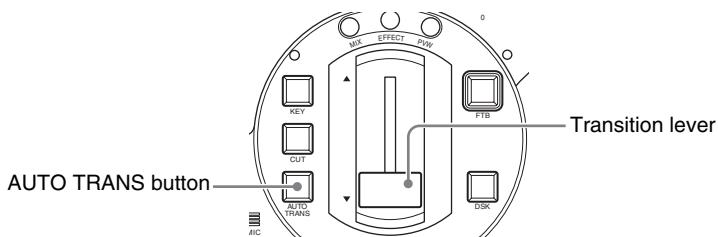

AUTO TRANS button

Pressing the AUTO TRANS button carries out the transition automatically, using the preset transition time.

Transition lever

Moving the transition lever in the direction shown by the LED indicators (Δ ∇) progresses the transition in sync with the lever movement.

Switching with a dissolve

In a dissolve, one video image fades into another.



Basic operation for a dissolve

The basic procedure for a dissolve is as follows.

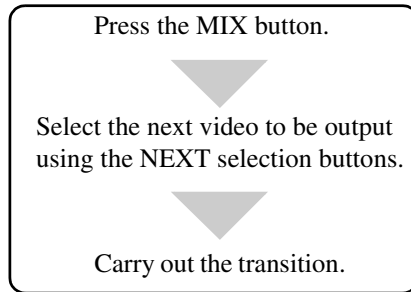

- 1 Press the MIX button.

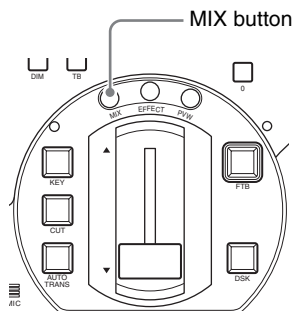

The MIX button lights amber, and the effect indication on the operation screen shows the current mix state (progress of the dissolve).



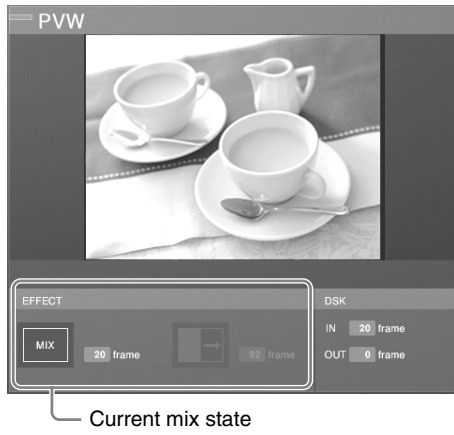

Notes

- The mix state shows the current transition time setting.
- You can still change the transition time at this point. To change the setting, follow the procedure in “Changing the Transition Time” (page 72).

2 Determine the next program output video, and select this with the NEXT selection button.

The selected video appears in the PVW viewer.

3 Carry out the transition with the AUTO TRANS button or transition lever.

The NEXT selection video dissolves into the program output video.



Each press of the AUTO TRANS button, or operation of the transition lever, carries out a dissolve transition from the program output video to the NEXT selection video.

Switching with a wipe

In a wipe, two video images occupy the display simultaneously, with the area occupied by one growing until it wipes out the other. You can choose from sixteen different wipe patterns.



Basic operation for a wipe transition

The basic procedure for a wipe transition is as follows.

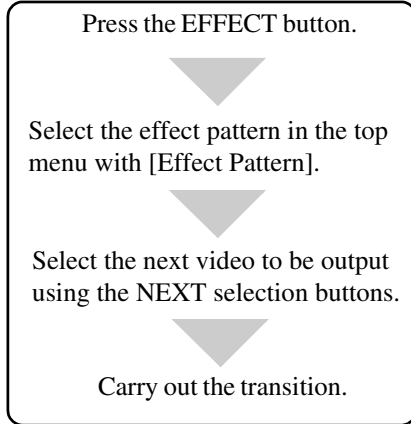

1 Press the EFFECT button.

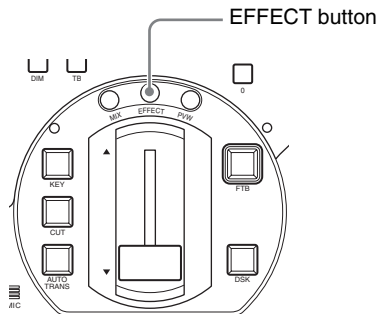

The EFFECT button lights amber, and the effect indication shows the current effect state.

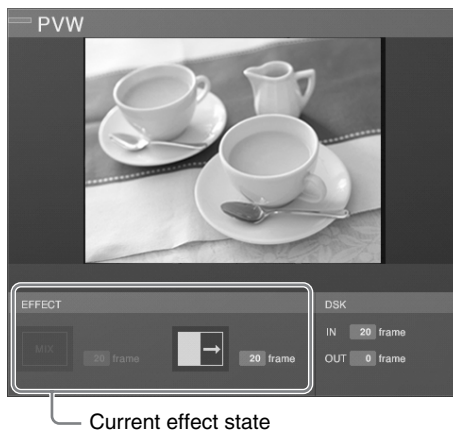

Notes

- The current effect state shows the transition time and effect pattern settings.
- You can change the transition time. To change the setting, follow the procedure in “Changing the Transition Time” (page 72).

- 2 Select the effect pattern.
To change the effect pattern, follow the procedure in “Changing the Effect Pattern” (page 73).
- 3 Determine the next program output video, and select this with the NEXT selection button.
The selected video appears in the PVW viewer.
- 4 Carry out the transition with the AUTO TRANS button or transition lever.
The program output video changes to the NEXT selection video by a wipe transition.



Each press of the AUTO TRANS button, or operation of the transition lever, the program output video changes to the NEXT selection video by a wipe transition.

Note

You can apply an edge effect to the wipe pattern. For details, see “Applying Edge Effects” (page 87).

Changing the Transition Time

Before carrying out a transition with the AUTO TRANS button, set the transition time.

- 1 Press the MIX button or EFFECT button.
The current settings appear in the effect display.
- 2 Press the MENU button.
- 3 In the top menu, select [Video Effect].
- 4 ① Select [Transition Time], and confirm; ② move the slider to set the transition time.

The transition time is set in frame units.

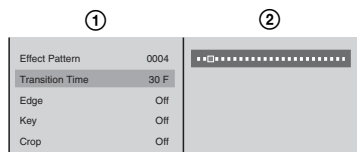

- 5 Press the MENU button to close the menu.
The set transition time appears in the effect display.

Changing the Effect Pattern

- 1 Press the EFFECT button.
The current settings appear in the effect display.

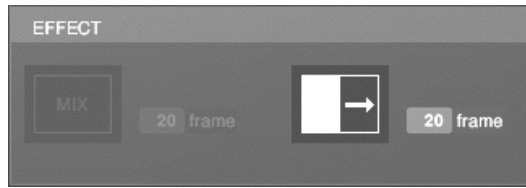

Note

Here you can also press the EFFECT button once more to recall the [Effect Pattern] menu, and skip from step 2 below as far as ① within step 4.

- 2 Press the MENU button.
- 3 In the top menu, select [Video Effect].
- 4 ① Select [Effect Pattern], and confirm; ② select the wipe pattern from the list, and confirm.

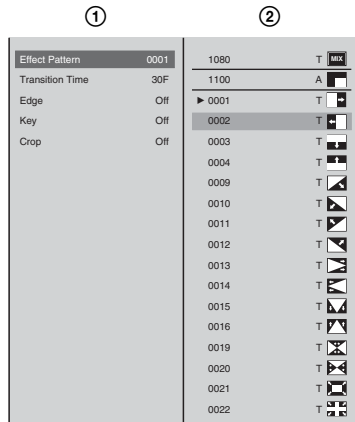

- 5 Press the MENU button to close the menu.

Note

You can also close the menu by pressing the EFFECT button.

The selected effect pattern appears in the effect display.

Using Picture-in-Picture (PinP) for Combining Videos

You can generate a picture-in-picture effect by embedding a video within another video.



Note

When you use a picture-in-picture for combining videos, you can check the results in the PVW viewer before program output. For details, see “Checking the Results of Combining Videos (Effect Preview)” (page 88).

Basic picture-in-picture operations

The basic procedure for using a picture-in-picture for combining videos is as follows.

Select a picture-in-picture from [Effect Pattern] of the top menu.

▼

Press a NEXT selection button to select a video to embed within the video.

▼

Execute the transition.

For details on executing transitions, see “Basic transition effect operations” (page 68).

- 1 Press the MENU button.
- 2 In the top menu, select [Video Effect].
- 3 ① Select [Effect Pattern] and confirm; ② select a picture-in-picture from the list and confirm.

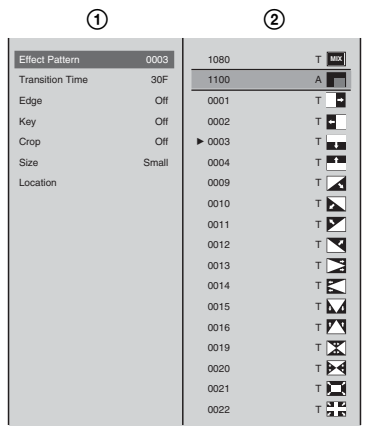

The picture-in-picture information appears in the effect display.

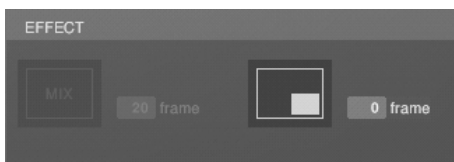

- 4 Press the MENU button to close the menu.
- 5 Decide which video to embed, and then press the corresponding NEXT selection button to specify the video.
The selected video is displayed in the PVW viewer.

Caution

When the following material is selected, the NEXT selection button flashes and the picture-in-picture effect is not applied.

- Material assigned to INT.
- Material being used for program output
- Material being used for keying.

- 6 Use the AUTO TRANS button, CUT button, or transition lever to execute the transition.

The NEXT selection video is embedded in the program output video.



The NEXT selection button changes to red when the transition is complete.

Press the AUTO TRANS button or CUT button once more or move the transition lever in the opposite direction to remove the embedded video and return the color of the NEXT selection button to orange.

Caution

The transition time is always 0%.

Notes

- You can crop the unwanted portions from the embedded video. For details, see “Cropping Unwanted Portions From the Video Being Combined” (page 87).
- You can apply an edge to the frame of the video to be embedded. For details, see “Applying Edge Effects” (page 87).

Adjusting the Picture-in-Picture (PinP)

You can set the size and display position of the video embedded using a picture-in-picture.

Note

You can make picture-in-picture adjustments while viewing the results in the PVW viewer before program output. For details, see “Checking the Results of Combining Videos (Effect Preview)” (page 88) and “Giving Priority to Displaying the PVW Viewer” (page 90).

Changing the size of the video embedded

- 1 Perform Steps 1 to 6 of “Basic picture-in-picture operations” (page 74).
- 2 Press the MENU button.
- 3 In the top menu, select [Video Effect].
- 4 ① Select [Size] and confirm; ② select a size and confirm.

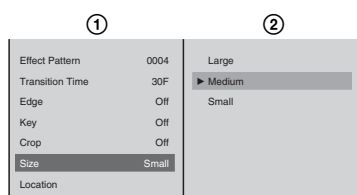

The meanings of these items are as follows.

- [Large]:** 1/4 of size
[Medium]: 9/64 of size
[Small]: 1/16 of size



- 5 Press the MENU button to close the menu.

Specifying the position to embed the video

- 1 Perform Steps 1 to 6 of “Basic picture-in-picture operations” (page 74).
- 2 Press the MENU button.
- 3 In the top menu, select [Video Effect].
- 4 ① Select [Location] and confirm; ② select [X] or [Y] and confirm; ③ specify the position with the slider while checking the PVW viewer.

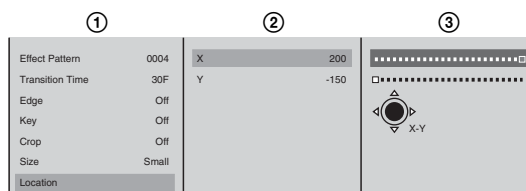

The meanings of these items are as follows.

[X]: Specify the horizontal position.

[Y]: Specify the vertical position.

Note

After Step ①, you can specify the vertical or horizontal position by just pressing the top, bottom, left, or right part of the positioner. (If you use the positioner, there is no need to select [X] and [Y].)

Caution

When adjusting the position of the picture-in-picture image up, down, left, or right, the image shifts in 10-point increments.

- 5 Press the MENU button to close the menu.

Using Fade-to-Black (FTB)

This fades the video in from or out to a black screen.

Press the FTB button.

This fades out the program output to a black screen, except for any superimposed logo.

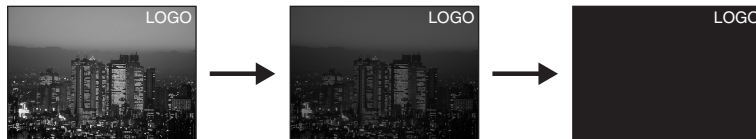

Press the FTB button once more to fade in the video from the black screen.

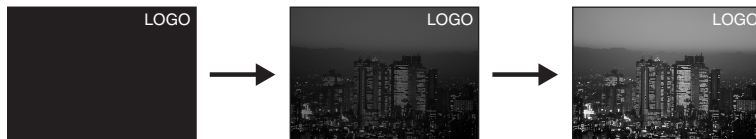

Note

While the screen is black, the PGM selection buttons change to amber.

Fading in a different video after fading out

- 1 After fading to a black screen, select a different video with the PGM selection buttons.
- 2 Press the FTB button.
This fades in the newly selected video.

Setting the Fade to Black transition time

- 1 Press the MENU button.
- 2 In the top menu, select [Fade To Black].

- 3** ① Select [Transition Time], and confirm; ② move the slider to set the transition time.

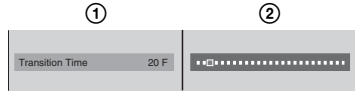

- 4** Press the MENU button to close the menu.

Using Color Bars and Color Mattes

The Internal Color Bar is provided for adjustment and test transmission. The Internal Color Matte is provided for a background.

- 1** Select the internal (INT) source using the NEXT buttons.
The INT source selection menu appears in the menu display.
- 2** Select the color bars or color matte you want to show, and confirm.

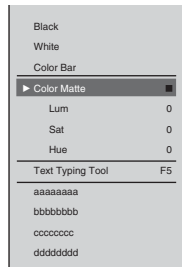

Note

This unit can output the following 2 color bars for each video output signal format setting.

- With NTSC: SMPTE color bar (75%)
- With PAL: EBU color bar (100%)

The selected internal video signal appears in the “INT” source viewer.

Note

You can change the color of the color matte. For details, see “Adjusting Color Matte” (page 161).

Using the Downstream Key (DSK) Function to Add Text or an Image

You can add text or an image to video that already includes an effect or combination.

This is useful for adding subtitles, for example.

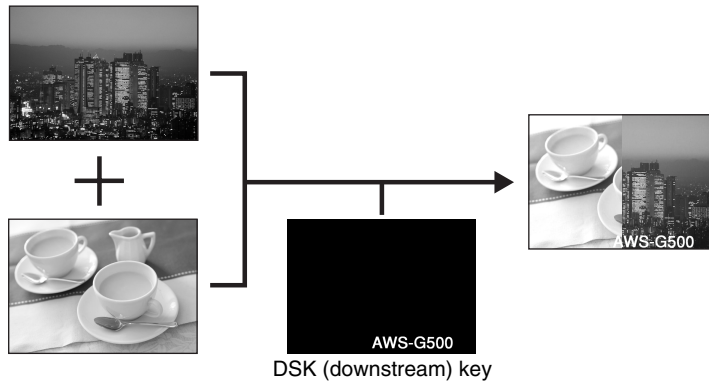

Basic downstream key operations

The basic procedure for downstream keying is as follows.

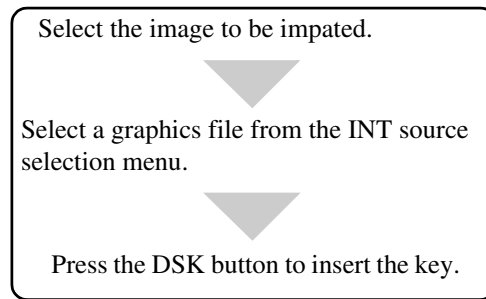

Inserting a downstream key

In order to use a downstream key for text or graphics, it must first be imported onto the internal hard disk of this unit. You can use the alpha channel of a graphics file in targa format as the key source, which allows high-quality downstream keying.

For details on importing a graphics file, see “Importing Graphics Files” (page 175).

- 1** Press INT in the NEXT selection buttons.
The INT source selection menu appears.
- 2** Use the jog roller to select a graphics file displayed in the lower part of the INT source selection menu, and confirm.

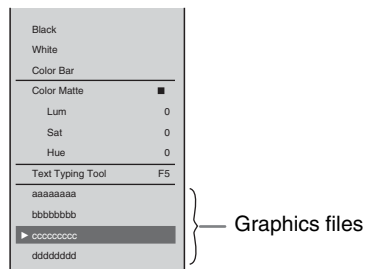

The selected graphics file appears in the “INT” source viewer.



Note

While the graphics file is being read in, the message “Loading...” appears at the bottom of the PVW viewer and in the device status in the source viewer.

3 Press the DSK button.

DSK button lights red, and the graphics file image appears in the PGM viewer.



If you press the DSK button once more, the inserted image is removed. Each press of the DSK button alternately inserts or removes the image.

Note

If you change the video to a black screen using FTB, no downstream key is output. In this case, the DSK button lights amber.

Setting the downstream key transition times

You can set the DSK transition times which are the times taken for the text or image to be gradually inserted, or to be gradually removed. These are set in frame units.

- 1** Press the MENU button.
- 2** In the top menu, select [DSK].
- 3** ① Select [On Trans. Time], and confirm; ② move the slider to set the time until the image appears.

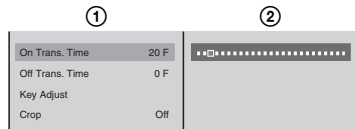

- 4** ① Select [Off Trans. Time], and confirm; ② move the slider to set the time to disappear.

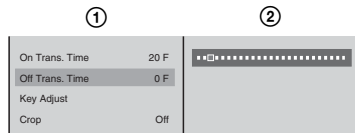

5 Press the MENU button to close the menu.

The DSK transition time setting appears in the DSK display of the effect display in the operation screen.



Adjusting the downstream key

You can adjust the parameters for inserting text or image, or crop unwanted portions.

- 1 Press the DSK button to insert the image.
- 2 Press the MENU button.
- 3 In the top menu, select [DSK].
- 4 In the submenu, set the following adjustment items.

Adjusting the outline of the text or image

① Select [Key Adjust], and confirm; ② select the item to adjust, and confirm; ③ adjust the sliders.

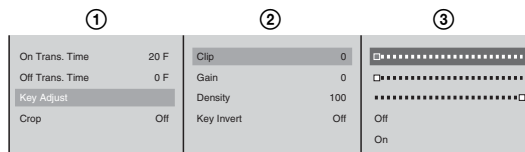

The items you can adjust are as follows.

[Clip]: Adjusts the threshold level for keying.

[Gain]: Adjusts the sharpness of the key outline.

[Density]: Adjusts the density of the text or image to be inserted.

Note

If you have recalled and adjusted a graphics file, the adjusted values of the graphics file change as follows depending on the next file recalled:

- When a file with no alpha channel is recalled: adjusted values remain unchanged.
- When a file with an alpha channel is recalled: values return to their default settings.

Inverting the key

You can invert the displayed parts and non-displayed parts of the combined material.

① Select [Key Adjust], and confirm; ② select [Key Invert], and confirm; ③ select [On], and confirm.

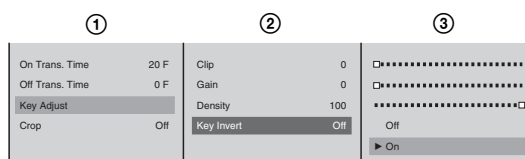

Cropping unwanted portions of the text or image

① Select [Crop], and confirm; ② select [On], and confirm; ③ select the side (top, bottom, left, or right) to be displayed, and confirm; ④ move the slider to crop.

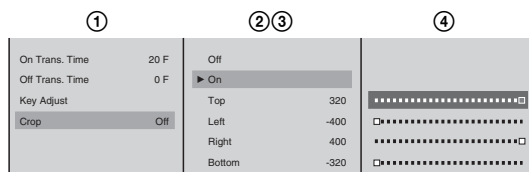

5 Press the MENU button to close the menu.

Showing a Logo on the Screen

For copyright protection purposes, you can superimpose a logo (160×120 pixel graphic) on the video.

When the logo is enabled, the logo is superimposed on the program output video.



Basic operation for showing a logo

The basic procedure for showing a logo is as follows.

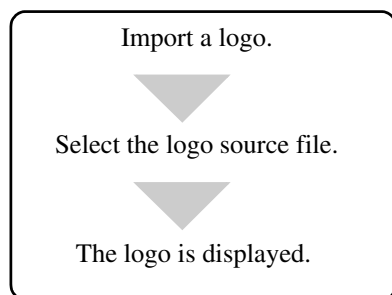

Showing a logo in the video

To show a logo, first it is necessary to import the logo file to the internal hard disk of this unit.

For details on importing a logo file, see “Importing Logo Files” (page 176).

- 1 Press the MENU button.
- 2 In the top menu, select [Logo].
- 3 ① Select [Logo Source], and confirm; ② select the logo file from the list, and confirm.

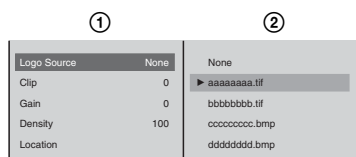

The image is inserted in both the PGM viewer and PVW viewer.

Note

By selecting a logo file from the list, it always appears in the program output video. If you do not want to show the logo, select [None].

- 4 Press the MENU button to close the menu.

Adjusting the logo display

Adjust the parameters for logo insertion, and set the logo position.

- 1 Show the logo.
For details of the operation, see “Showing a logo in the video” (page 82).
- 2 Press the MENU button.
- 3 In the top menu, select [Logo].
- 4 In the submenu, set the following adjustment items.

Adjusting the outline of the logo

- ① Select one of [Clip], [Gain], and [Density], and confirm; ② adjust the slider.

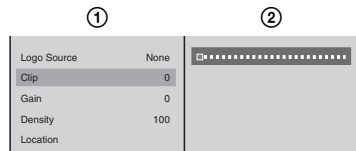

The items you can adjust are as follows.

[Clip]: Adjusts the threshold level for the logo key.

[Gain]: Adjusts the sharpness of the outline.

[Density]: Adjusts the density of the text to be inserted.

Note

When you have recalled a logo file and made adjustments, the logo file adjustment values for the logo file depend on the next recalled file as follows:

- When a file with no alpha channel is recalled: the adjustments are maintained as is.
- When a file with an alpha channel is recalled: the adjustments are returned to their default values.

Specifying the position of the logo display

- ① Select [Location], and confirm; ② select [X] or [Y], and confirm; ③ specify the position with the sliders.

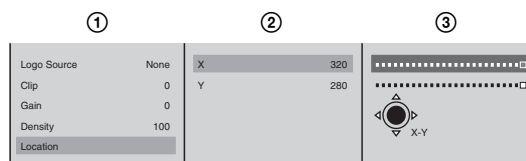

The meaning of these items are as follows.

[X]: Specifies the horizontal position.

[Y]: Specifies the vertical position.

Note

After Step ①, you can specify the vertical or horizontal position by just pressing the top, bottom, left, or right part of the positioner. (If you use the positioner, there is no need to select [X] and [Y].)

- 5 Press the MENU button to close the menu.

Using Luminance Keying

Video A and video B images are combined by comparing the components of brightness (luminance) to cut unneeded portions of the video B image. Generally, bright lettering is drawn on a black background, and this is used as the key.

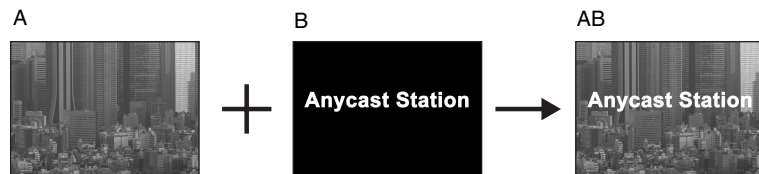

Note

Pressing the KEY button switches to key mode (the KEY button, NEXT selection buttons, MIX button and EFFECT button light green, and the AUTO TRANS button, CUT button, and transition lever now apply a keying operation).

Basic operation for luminance keying

The basic procedure for luminance keying is as follows.

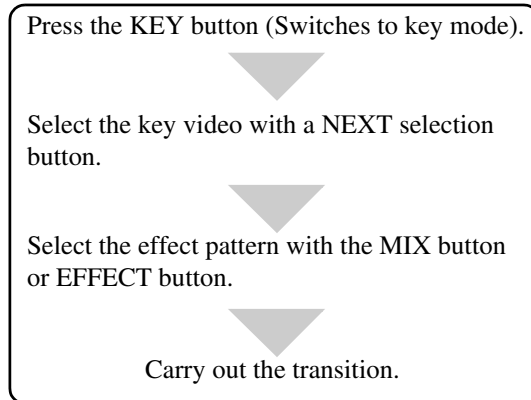

- 1 Press the KEY button.

The KEY button, NEXT selection buttons, and MIX button or EFFECT button light green and are now used for keying video.

- 2 Select the video for keying with the NEXT selection button.
A green frame appears around the selected video in the source viewer.

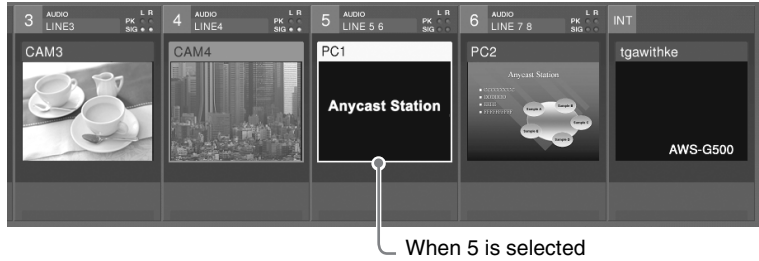

- 3 Press the MIX button or EFFECT button.
The button green, and the details of the current effect appear in the effect display.

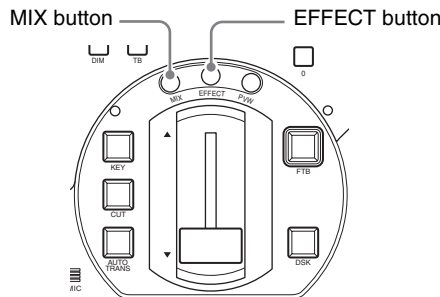

Notes

- You can change the transition time. To make this change, use the procedure in “Changing the Transition Time” (page 72).
- You can change the effect pattern. To make this change, use the procedure in “Changing the Effect Pattern” (page 73).
- In key mode, you can maintain the transition time, effect pattern, and edge adjustments for keying.

- 4 Apply the video effect using the AUTO TRANS button, CUT button, or transition lever.
This keys the NEXT selection into the program output video.



The “KEY ON” indicator on the operation screen lights red.



Press the AUTO TRANS button or CUT button once more, or operate of the transition lever in the opposite direction, to remove the combined video effect.

The “KEY ON” indicator on the operation screen also turns off. Each press of the AUTO TRANS button or CUT button or operation of the transition level alternately inserts or removes the video effect.

Adjusting the Combined Video

You can make keying adjustments while viewing the results in the PVW viewer before program output. For details, see “Checking the Results of Combining Videos (Effect Preview)” (page 88) and “Giving Priority to Displaying the PVW Viewer” (page 90).

- 1 Perform keying.
- 2 Press the MENU button.
- 3 In the top menu, select [Video Effect].
- 4 Select [Key], and confirm, then make the following settings in the submenu.

Sharpening the outline of the key

- ① Select one of [Clip], [Gain], and [Density], and confirm; ② adjust the slider.

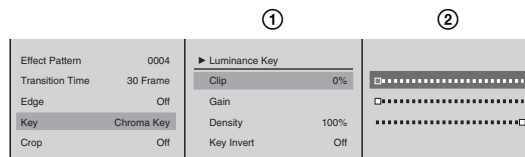

The meaning of these items are as follows.

[Clip]: Adjusts the threshold for background cutout.

[Gain]: Adjusts the sharpness of the outline.

[Density]: Adjust the density of the video to be combined.

Note

If you have recalled and adjusted a graphics file, the adjusted values of the graphics file change as follows depending on the next file recalled:

- When a file with no alpha channel is recalled: adjusted values remain unchanged.
- When a file with an alpha channel is recalled: values return to their default settings.

Inverting the luminance key

- ① Select [Key Invert], and confirm; ② select [On], and confirm.

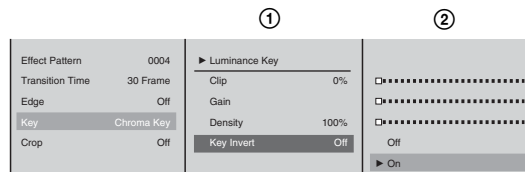

- 5 Press the MENU button to close the menu.

Cropping Unwanted Portions From the Video Being Combined

- 1 Combine videos using a picture-in-picture or keying.
- 2 Press the MENU button.
- 3 In the top menu, select [Video Effect].
- 4 ① Select [Crop], and confirm; ② select [On], and confirm; ③ select the side (top, bottom, left, or right) to crop, and confirm; ④ move the slider to crop.

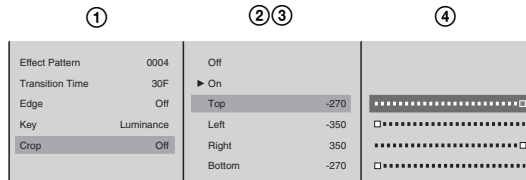

- 5 Press the MENU button to close the menu.

Applying Edge Effects

Apply an edge to a video border when using a wipe effect or to a picture-in-picture frame.

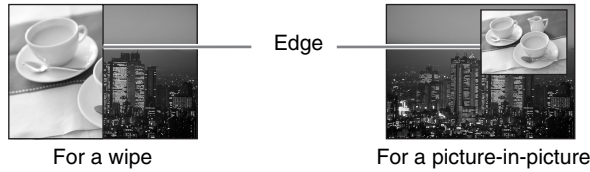

- 1 First set the effect pattern.
- 2 Press the MENU button.
- 3 In the top menu, select [Video Effect].
- 4 ① Select [Edge], and confirm; ② select [On], and confirm; ③ select the item to be set, and confirm; ④ adjust the slider.

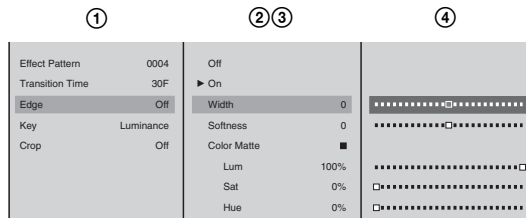

The meaning of these items are as follows.

[Width]: Adjusts the width of the border.

[Softness]: Adjusts the blurriness of the edge.

[Color Matte]: Changes the color of the border. Select [Lum] (luminance), [Sat] (saturation), or [Hue], and adjust the slider.

Checking the Results of Combining Videos (Effect Preview)

You can preview and adjust the results of executing picture-in-pictures and keying in the PVW viewer before program output.

You can set the PVW viewer to not be hidden while the menu is displayed when you are making adjustments. For details, see “Giving Priority to Displaying the PVW Viewer” (page 90).

Note

Press the PVW button to switch to PVW mode (in which the PVW viewer is used for effect preview).

Basic operation for previewing in the PVW viewer

The basic procedure for previewing in the PVW viewer is as follows.

For picture-in-picture

Select a picture-in-picture from [Video Effect] of the top menu.

For keying

Press the KEY button (the NEXT selection buttons switch to keying video selection).

Select the key video with a NEXT selection button.

Press the PVW button (switch to PVW mode).

Carry out the transition (switch to program output).

For picture-in-picture

1 Perform Steps 1 to 5 of “Basic picture-in-picture operations” (page 74).

2 Press the PVW button.

The PVW button lights orange and a preview of the results of combining videos is displayed in the PVW viewer.



Check and adjust the results of combining videos and perform the following operation to execute program output.

For details on making picture-in-picture adjustments, see “Adjusting the Picture-in-Picture (PinP)” (page 75).

- 3 Use the AUTO TRANS button, CUT button, or transition lever to combine the videos.

The results of combining videos are sent as program output and displayed in the PGM viewer.

The preview in the PVW viewer disappears (changes to the results of the next transition).



- 4 Press the PVW button to end PVW mode.

The PVW viewer returns to the video selected with the NEXT selection button.

For keying

- 1 Press the KEY button.
The KEY button, NEXT selection buttons, and MIX or EFFECT button light green, and are now used for keying video.
- 2 Press the NEXT selection button assigned to the video to be combined.
A green border appears around the selected video in the material viewer, and the video appears in the PVW viewer.



- 3 Press the PVW button, to switch to PVW mode.

The PVW button lights orange, and a preview of the combined result appears in the PVW viewer.



Check and adjust the combined result, use the following operation to switch to program output.

For details on making keying adjustments, see “Adjusting the Combined Video” (page 86).

- 4 With the AUTO TRANS button, CUT button, or transition lever, carry out the keying.

The combined result is sent to program output, and appears in the PGM viewer.

The preview in the PVW viewer disappears (changes to the result of the next transition).



- 5 Press the PVW button, to end PVW mode.

The PVW viewer returns to the video selected from the NEXT selection buttons.

Giving Priority to Displaying the PVW Viewer

With the default setting, the PVW viewer on the left is hidden when three levels of submenus of the top menu are displayed. If you give priority to displaying the PVW viewer, the preview is always viewable because the PVW viewer shifts to the right (and the PGM viewer is hidden) when three levels of submenus are displayed. The effect display below the PVW viewer also moves with the PVW viewer.

- 1 Press the MENU button.
- 2 Select [Display] in the top menu.
- 3 ① Select [Viewer Priority] and confirm; ② select [PVW] and confirm.



Creating a Title Graphic with the Text Typing Tool

Features of the Text Typing Tool Software

The text typing tool software is an application for creating simple titles. You can switch between the Anycast Station main software (the main software) and this application as you proceed.

- A file created with the text typing tool software is simultaneously saved in the Anycast Station main software, and can be used as a DSK (downstream key) or luminance key source.

Text typing tool software



Anycast Station main software

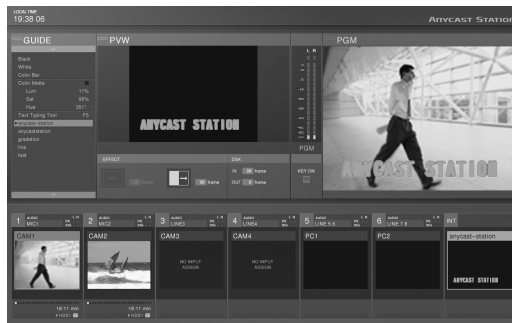

- By capturing one scene of the program output video and showing it as a background, you can get an impression of the final result of superimposing of the key, and position objects (characters and lines) accurately.

Sheets and files

In the text typing tool software, you create one title as a single sheet.

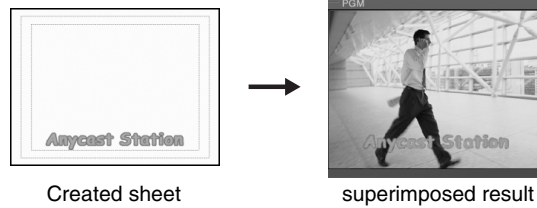

You can save multiple related sheets (for example, for a single program) together in a file.

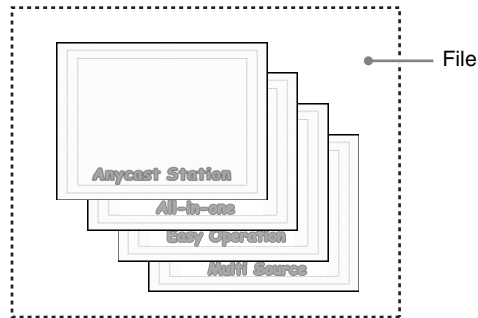

When creating similar title, you can copy a object to create the sheet, and therefore eliminate the trouble of creating a new file from scratch.

Flow of Operations

To use the text typing tool software, it is first necessary to upgrade the operating software (When the software version you are using is 1.00).

For details of how to upgrade, see the section “Upgrading the Operating Software” (page 200) in the Live Content Producer Operating Instructions.

- 1** Press the  (power) button on the side panel.
The operation screen appears.
- 2** Press the keyboard F5 (Fn+5) key.
You can work by switching between the Ancast Station main software and the text typing tool software.

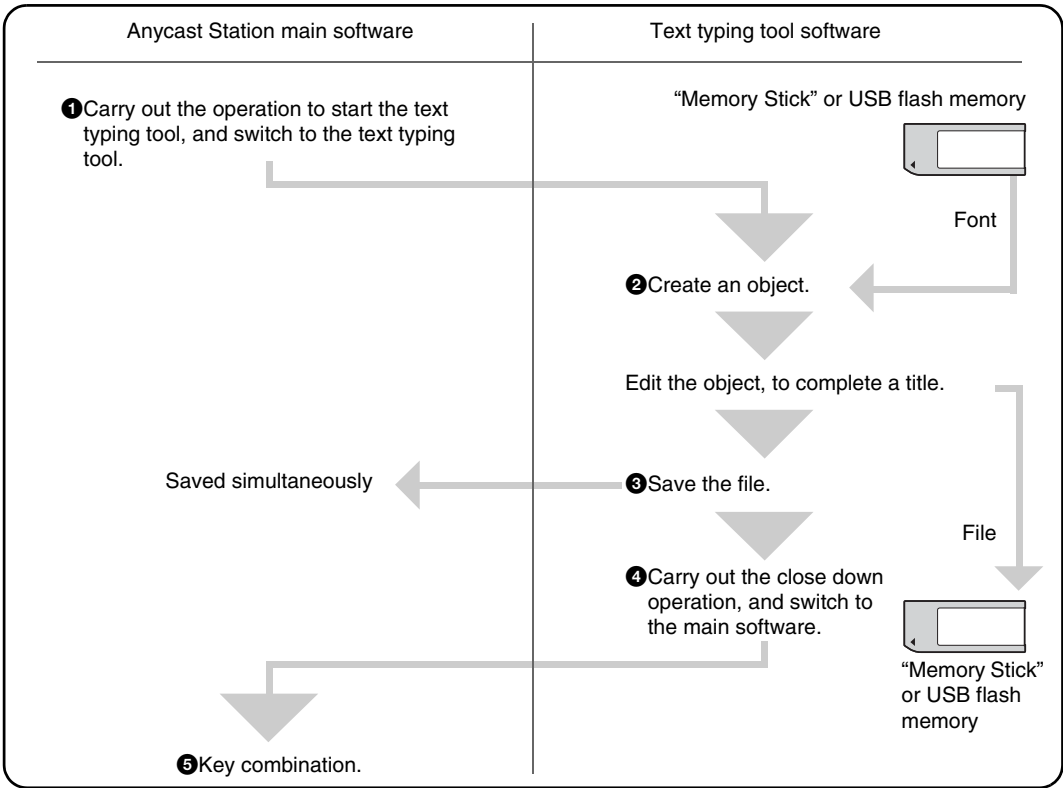

Note

With a "Memory Stick" or USB flash memory, you can import font files, and export created titles. You can use exported files on such as a computer.

Caution

- It is not possible to use a USB mouse with the Anycast Station main software.
- If the USB mouse does not respond in the text typing tool software, try disconnecting it and connecting to the other USB connector.

Starting Up

- 1 In the Anycast Station main software, press the “INT” NEXT selection button.
The INT material selection menu appears in the menu display.
- 2 Select [Text Typing Tool].

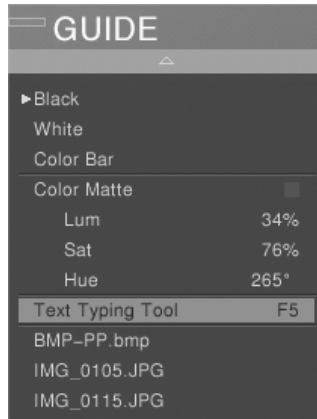

The following confirmation message appears.

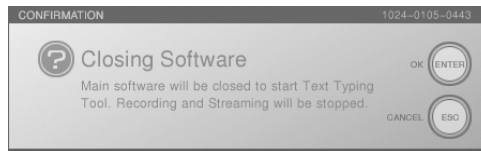

- 3 Press the ENTER button on the front panel.
The screen goes black and the text typing tool software starts.

Caution

- If you switch while using the Anycast Station main software, the image or sound may be distorted.
- If you switch while the Anycast Station main software is starting up, the system may not function correctly. Check that all viewers (PGM/PVW/material) have started up before switching to the text typing tool software.

Note

You can also use the keyboard F5 (Fn+5) key to switch to the text typing tool software.

Closing Down

To power off the unit

Press the  power button on the side panel.

The following message appears, the text typing tool software ends, and the power is turned off.

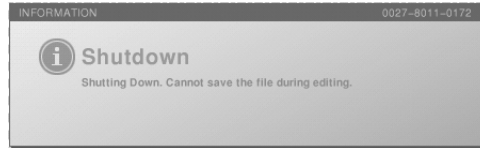

Caution

If there is a file in the process of creation, the program will end without saving it.

To close the text typing tool software and start the Anycast Station main software

- 1 Click the [Exit] button at the lower left of the screen.



The screen goes black and the Anycast Station main software starts.

Note

You can also use the keyboard F5 (Fn+5) key to switch to the Anycast Station main software.

In this case, following confirmation message appears.

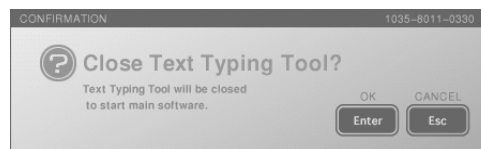

If a file is being created, a message appears to confirm whether to save the file.

- 2 Click the [Enter].

Standard Operations

This section describes standard operations used as various points in the text typing tool software.

Mouse operations

- By connecting a USB mouse to the USB connector on the side panel, you can carry out mouse operations.
- You can also carry out mouse operations with the pointer of the supplied keyboard.

Standard button operations

Click a button to carry out its function.

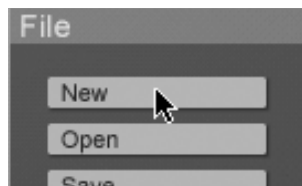

Standard checkbox operations

Click a checkbox to insert or remove the check mark. The function is active as long as a check mark is present.



Standard pull-down list operations

This section describes standard pull-down list operations.

Click the ▼ button to display the pull-down list.

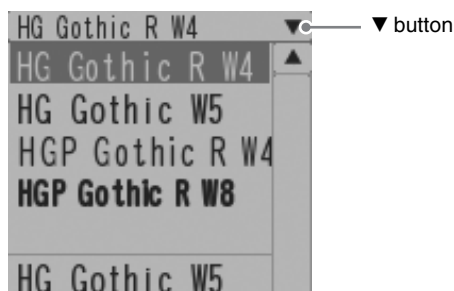

Standard keyboard operations

- The ↑ and ↓ keys move the focus (in reverse video) within the pull-down list.
- Press the Enter key to confirm the item which currently has the focus.
- Press the Fn+~ key (Esc) to cancel the selection, and close the pull-down list.

Standard operations for text input

The following are standard keyboard operations for text input.



Key	Operation
←, →	Move the cursor horizontally one position at a time.
↑	Move the cursor up one position at a time.
↓	Move the cursor down one position at a time.
Shift + ←, Shift + →	Select one character at a time, horizontally from the cursor position.
Delete	When there is a character selection: delete the selection. When there is no character selection: delete the character following the cursor.

Key	Operation
Backspace	When there is a character selection: delete the selection. When there is no character selection: delete the character before the cursor.
Enter	Newline
Esc	Remove the cursor leaving the characters unchanged.
Space	Insert a space.
Home	Move the cursor to the beginning.
End	Move the cursor to the end.
Alt + Enter	Confirm the entered text and exit the text input mode.

Standard tool operations

By clicking a tool in the tool operation section, you can use the function provided by the tool.

The tool operation continues until you select a different tool.

Other standard operations

The following standard operations can be carried out with the keyboard alone.

Key	Operation
Ctrl + z	Return to the previous state (Undo function)
Ctrl + y	Advance to the next state (Redo function)
Ctrl + x	Cut out an object
Ctrl + c	Copy an object In text input mode: copy the selected text
Ctrl + v	Paste an object In text input mode: paste the copied or cut text with the existing attributes where it is being pasted
Ctrl + a	Select all objects
Delete, Backspace	Delete an object

Object selection operations

- 1 Click the selection tool.
The icon turns green, and you can now select an object.



- 2 Click an object, or define a range by dragging.

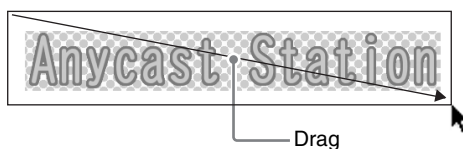

An orange border appears around the object.
This is the selected state.



Notes

- If you drag over a range, this selects all objects within the range.
- When there are multiple objects, you can use the keyboard Tab key to move the selection to the next object.

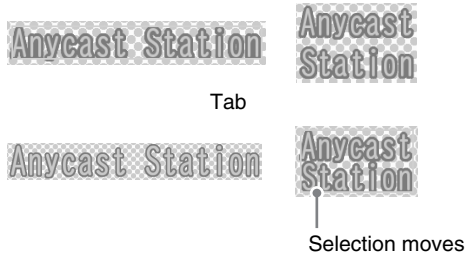

Press the Shift+Tab keys to move the selection in the reverse direction.

- Hold down the Shift key and click an object to add to the selection.
- Double-click on the selected text object to switch to text input mode (page 105).

File Operations

This section describes file operations, including saving and deleting titles created with the typing tool software, export, and so on.

Creating a new file

- 1 In the file operation section, click the [New] button.

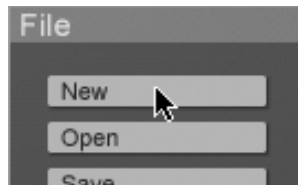

A new sheet appears.

Opening an existing file

- 1 In the file operation section, click the [Open] button.

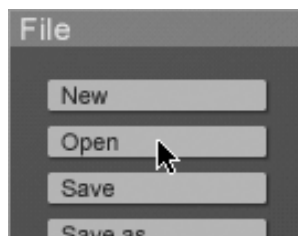

The [Open] screen appears.

- 2 Select the file name from the list.

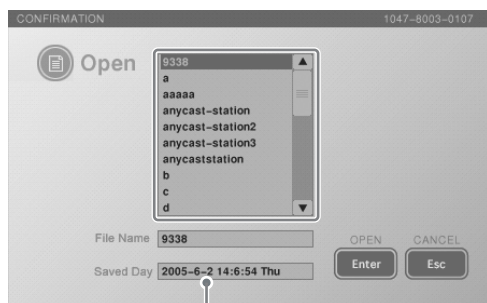

Last saved date of selected file

- 3 Click the [Enter].
This opens the selected file.

Note

If even one of the fonts used by the file you are opening has been deleted from the unit, a message appears to confirm whether to substitute any missing font with another font on the unit when displaying the file. Clicking [Enter] displays the font selection list. If you select a font and click enter, the selected font is used and the file opens. If multiple fonts have been deleted, all the fonts are substituted with the selected font.

Saving a file

- 1 In the file operation section, click the [Save] button.

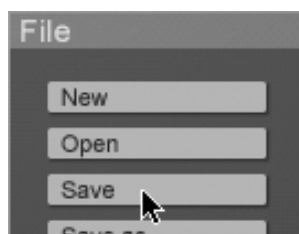

The [Save] screen appears.

- 2 Enter the file name in [File Name].

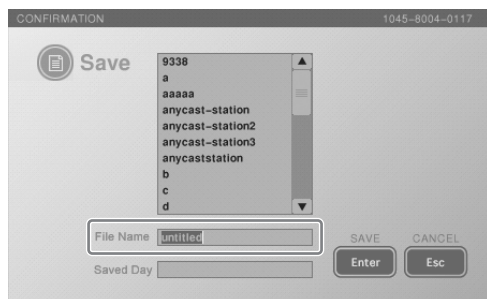

Caution

You can enter a file name as up to 20 alphanumeric characters, but there may not be room for the full name in text boxes or lists, or in the Anycast Station main software INT material selection menu.

3 Click the [Enter].

A message appears while saving, and the file is saved.

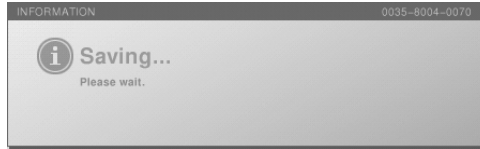

The file is simultaneously saved in the Anycast Station main software. In the Anycast Station main software, the saved file appears if you press the “INT” NEXT selection button.

Caution

If a file of the same name exists in the Anycast Station main software, it will be overwritten.

Notes

- When a file consisting of multiple sheets is saved, the second and subsequent sheets are named as follows with the file name + sheet number in the Anycast Station main software.

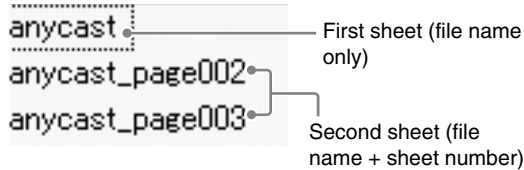

- A saved TIFF/TARGA file is saved with an alpha channel.

Saving a file with a new name

1 In the file operation section, click the [Save as...] button.

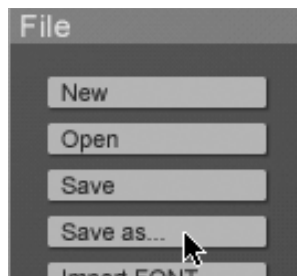

The [Save] screen appears.

- 2 Enter the file name in [File Name].

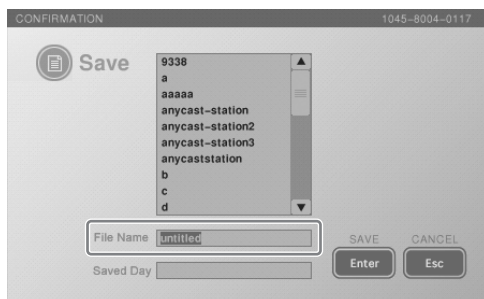

Caution

You can enter a file name as up to 20 alphanumeric characters, but there may not be room for the full name in text boxes or lists, or in the Anycast Station main software INT material selection menu.

- 3 Click the [Enter].

A message appears while saving, and the file is saved.

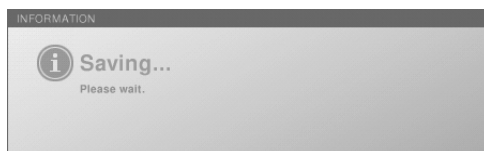

The file is simultaneously saved in the Anycast Station main software. In the Anycast Station main software, the saved file appears if you press the “INT” NEXT selection button.

Caution

If a file of the same name exists in the Anycast Station main software, it will be overwritten.

Deleting a file

- 1 In the file operation section, click the [Delete] button.

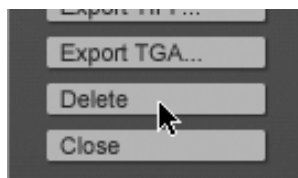

The [Delete] screen appears.

- 2 Select the file name from the list.

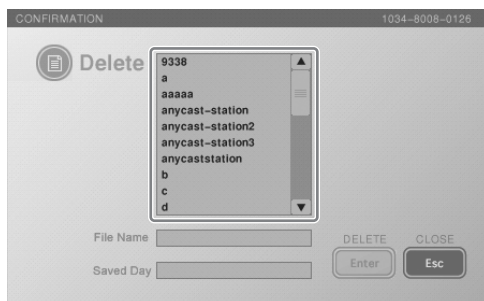

Note

You can select multiple files by clicking (or pressing the ↑ and ↓ keys) to select file names while holding down the Shift key or by dragging to select file names.

- 3 Click the [Enter].
The following confirmation message appears.

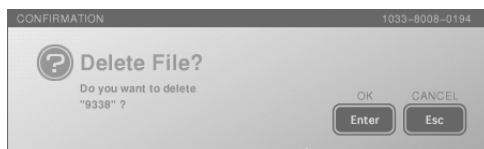

- 4 Click the [Enter].
This deletes the selected file.

Exporting a file

By exporting a file created in the text typing tool software to a “Memory Stick” or USB flash memory, you can use the file in another system. You can export the file in TIFF format or TARGA format at 1,280×960 size.

- 1 Insert the “Memory Stick” or USB flash memory in the rear panel “Memory Stick” slot or USB connector.
The upper USB connector is number 1, and the lower connector is number 2.

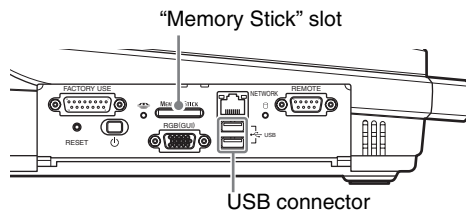

- 2 Open the file to be exported.
For the method of opening a file see “Opening an existing file” (page 98).

- 3** In the file operation section, click the [Export TIFF...] button , or [Export TGA...] button.



The following confirmation message appears.

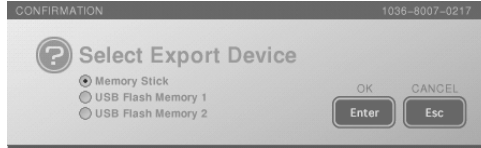

- 4** Select where to save the file, and click [Enter].
The following confirmation message appears.

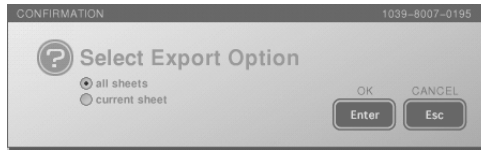

- 5** If the opened file includes multiple sheets, select either [all sheet] or [current sheet].

all sheet: export all sheets within the file.

current sheet: export the currently displayed sheet only.

Note

If there is only one sheet in the file, this message does not appear.

- 6** Click the [Enter].
The [Save] screen appears.

- 7** Enter the file name in [File Name].



8 Click the [Enter].

The following message appears, and the file is exported to the “Memory Stick” or USB flash memory.

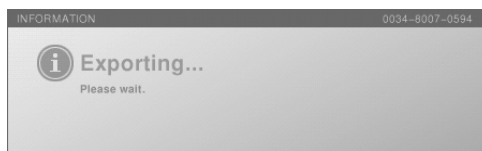
**Notes**

- When a file consisting of multiple sheets is exported, the second and subsequent sheets are named as follows with the file name + sheet number.

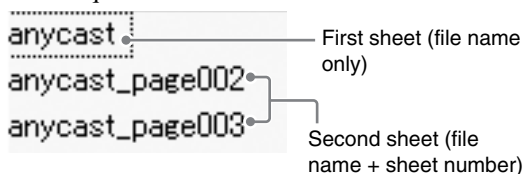

- An exported TIFF/TARGA file is saved with an alpha channel.

Working on Text Objects

This section describes how to create a text object, and then apply modifiers to the text.

Creating a text object

1 Click the text tool.

The icon turns green, and the system is now in text input mode (in which text input is possible).

**2** Click where you want to enter text.

The cursor appears.

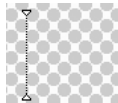
**3** Enter text from the keyboard.

As you enter text, it appears in a pink and black dotted frame.

**Notes**

- For details of confirming the text, see “Standard operations for text input” (page 96).
- If input with a font only supporting numerals, spaces are input.

Changing the text font

- 1 Click the selection tool, to select the text object (page 97).
An orange frame appears around the text object.



- 2 Click the ▼ button by the font name in the font operation section.

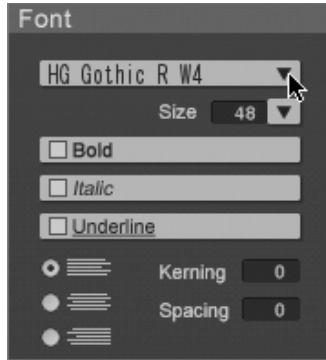

The pull-down list appears.

- 3 Select a font.

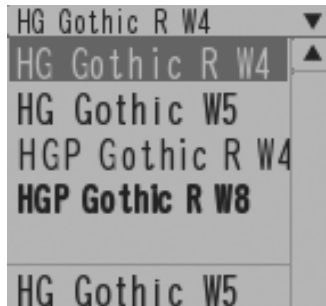

This changes the selected font.



Editing the text

- 1 Click the selection tool, to select the text object (page 97).
An orange border appears around the text object.



- 2 Double-click the selected text object.

The frame changes to a pink and black dotted line, and the cursor appears, switching to text input mode.



- 3 Edit the text.

Changing the font size

- 1 Click the selection tool, to select the text object (page 97).
An orange border appears around the text object.



- 2 Click the [Size] ▼ button in the font operation section.

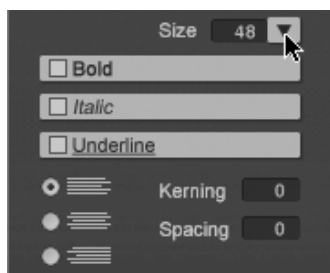

- 3 Select the size.

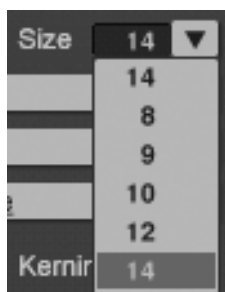

This changes the selected size.



Note

You can also change the size by directly entering a numeric value in the [Size] box.

Click the box, enter the numeric value from the keyboard, then press the Enter key.

Changing the font style

- 1 Click the selection tool, to select the text object (page 97).
An orange border appears around the text object.



- 2 Select a style in the font operation section.



This changes the selected style.

Bold

Anycast Station

Italic

Anycast Station

Underline

Anycast Station

Changing the spacing between characters

- 1 Click the selection tool, to select the text object (page 97).
An orange border appears around the text object.

Anycast Station

- 2 Click the [Kerning] input box in the font operation section, and enter the numeric value from the keyboard.



- 3 Press the Enter key.

This changes to the selected spacing.

Anycast Station

Note

The numeric value zero is the basepoint for the spacing. By entering a negative value, you can make the spacing narrower.

Changing the spacing between lines

- 1 Click the selection tool, to select the text object (page 97).
An orange border appears around the text object.



- 2 Click the [Spacing] input box in the font operation section, and enter the numeric value from the keyboard.



- 3 Press the Enter key.
This changes to the selected spacing.



Note

The numeric value zero is the basepoint for the spacing. By entering a negative value, you can make the spacing narrower.

Aligning text

You can align a text object with multiple lines to the left, to the right, or in the center.

- 1 Click the selection tool, and select the text object with multiple lines (page 97).
An orange border appears around the text object.

Note

The following figure shows left alignment as an example.



- 2 Click the center align button in the font operation section.



This center-aligns the text.



Changing the text color

- 1 Click the selection tool, to select the text object (page 97). An orange border appears around the text object.



- 2 Click one of the text color selection buttons in the Color tab of the [Text] tab.

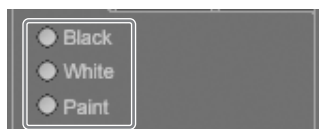

The text appears as follows.

Black



White



Paint



When [Paint] is selected, see the section “Creating a color in the color creation section” (page 118) on adjusting the color.

Making changes to the character outlines

- 1 Click the selection tool, to select the text object (page 97).
An orange border appears around the text object.



- 2 Select the Edge tab of the [Text] tab.
- 3 Make the following settings for the outline desired.

To change the style of the outline

Select the [Edge-Round] edge selection button for an outline with round corners and select the [Edge-Sharp] edge selection button for an outline with sharp corners.

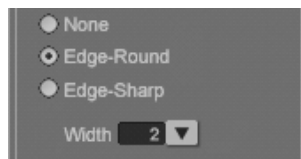

To change the color of the outline

For black or white, select the [Black] or [White] edge color selection button. To change the color to a desired color, create the color in the color creation section.



For details, see the section “Creating a color in the color creation section” (page 118).

To remove the character outlines

Select the [None] edge style selection button.
The outlines disappear.



To change the thickness of the outlines

Click the [Width] ▼ button, and select the thickness.



Working on Line Objects

This section describes how to create a line object, and then change the line style or color.

Creating a Straight Line

- 1 Click the line tool.



The icon turns green, and you can now draw a line.

- 2 Draw a line.

Click at the start position, and drag to draw the line.

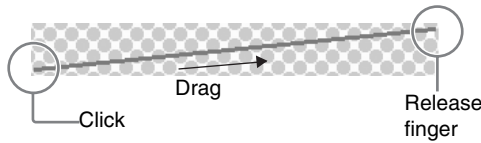

Notes

- If you drag with the Shift key held down, you can draw horizontal or vertical lines.
- Right-click to cancel the orange color selection frame.

Changing the length and direction of a straight line

Directly after creating a line object

You can change the length and direction of a line object while the line tool remains selected after the line object is created.

- 1 Point at either end of the line using the mouse.

The mouse pointer changes to .

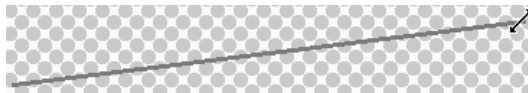

- 2 Click and drag.

An orange border appears around the line object, and you can change the length or direction of the line.

Already created line object

Use the selection tool to change the length and direction of a line object that has already been created.

- 1 Click the selection tool and select the line object (page 97).

An orange border appears around the line object.

- 2 Place the mouse pointer over either end of the line.

The mouse pointer changes to .

- 3 Click and drag.

Changing the line style

- 1 Click the selection tool, to select the line object (page 97).
An orange border appears around the line object.
- 2 Click one of the line style selection buttons on the Color tab of the [Line] tab.

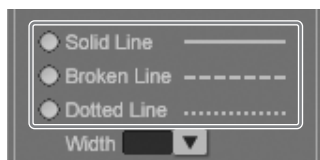

The line appears as follows.

Solid Line



Broken Line



Dotted Line



Changing the line thickness

- 1 Click the selection tool, to select the line object (page 97).
An orange border appears around the line object.
- 2 Click the [Width] ▼ button on the Color tab of the [Line] tab.

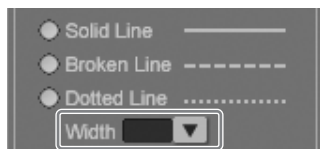

The pull-down list appears.

- 3 Select the thickness.
This changes the line to the selected thickness.

Note

You can also change the size by directly entering a numeric value in the [Width] box.
Click the box, enter the numeric value from the keyboard, then press the Enter key.

Changing the line color

- 1 Click the selection tool, to select the line object (page 97).
An orange border appears around the line object.
- 2 Click one of the line color selection buttons on the Color tab of the [Line] tab.



For details of color adjustment when the [Paint] is selected, see “Creating a color in the color creation section” (page 118).

Adding Outlines to Line Objects

- 1 Click the selection tool and select the line object (page 97).
An orange border appears around the line object.
- 2 Click the [Edge-Round] or [Edge-Sharp] edge style selection button on the Edge tab of the [Line] tab.

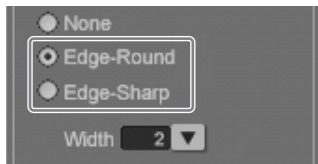

Select the [Edge-Round] edge selection button for an outline with round corners and select the [Edge-Sharp] edge selection button for an outline with sharp corners.

- 3 Set the color and width of the outline as necessary.

To change the color of an outline

For black or white, select the [Black] or [White] edge color selection button. To change the color to a desired color, create the color in the color creation section.

For details, see “Creating a color in the color creation section” (page 118).

To change the width of an outline

Click the [Width] ▼ button and select a width.

Shadow Operations

This section describes how to create shadows, and set the direction and distance, and adjust the degree of blurring.

Note

This section describes the example of a text object.

Applying a shadow

- 1 Click the selection tool, and select the object (page 97).
An orange border appears around the object.



- 2 Select the Shadow tab on the [Text] tab.

- 3 Select the [Shadow-Normal] or [Shadow-Blur] shadow type selection button.

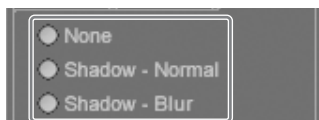

The following display appears.

Shadow - Normal



Shadow - Blur



Changing the shadow angle

- 1 Click the selection tool, and select the object with the shadow (page 97).
An orange border appears around the object.



- 2 Drag the direction indicator to the desired direction.



The shadow direction changes as follows.



Notes

- You can move the direction indicator needle in increments of 45° by dragging it while holding down the Shift key.
- You can also enter a numeric value in [Degree], to change the direction.

Changing the shadow distance

- 1 Click the selection tool, and select the object with the shadow (page 97).
An orange border appears around the object.



- 2 Enter a numeric value in [Distance].



The shadow distance changes as follows.



Changing the degree of blurring of a shadow

- 1 Click the selection tool, and select an object with shadow (Shadow - Blur) applied (page 97).
An orange border appears around the object.



- 2 Enter a numeric value in [Softness].



The degree of blurring of the shadow changes as follows.



Background Color Operations (Creating Telop and Flip)

Telop



Flip

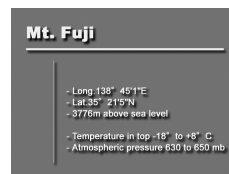

Creating a telop for keying (transparent for keying)

When the created title is used as a key source in the Anycast Station main software, the background is transparent (alpha value 100%), so that the background does not appear.

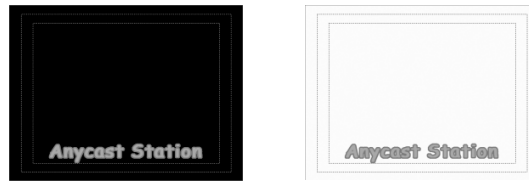

Note

In the Anycast Station main software viewer, the background appears as whichever of black and white it is set to, but when used as a key source, the background is transparent.

- 1 Select the [BG] tab.
- 2 Select the [Transparent Black] or [Transparent White] color selection button.

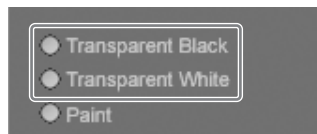

Note

To create a flip with a solid white or black background, select [Paint], and set black or white. For more details, see the section, “Creating a flip (for keying with a background color)” (page 117).

Creating a flip (for keying with a background color)

If you set any color for the background, when used as a key source in the Anycast Station main software, the background color appears unchanged.



- 1 Select the [BG] tab.
- 2 Select the [Paint] color selection button.

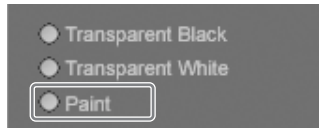

- 3 Create a color in the color creation section.

For details of color creation, see “Creating a color in the color creation section” (page 118).

The background changes to the selected color.

Notes

- If transparency is set, select [Live] and check the effect of the transparency.
- The screen and main software viewer are displayed without transparency when [BG] button of the view operation section is selected even if transparency is set. However, background transparency is set for actual keying.
- You can set a different background color for each sheet.

Color Operations

This section describes how to create a color.

Creating a color in the color creation section

In the color creation section of each tab of the modifier operation section, you can create any desired color.

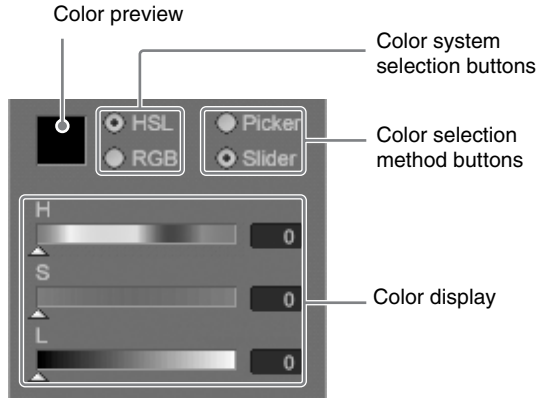

Use the following procedure to create a color.

- 1 Select [HSL] or [RGB] as the color system.
In each of these systems, you specify three parameters to create the color.

[HSL]

H: Hue
S: Saturation
L: Brightness

[RGB]

R: Red
G: Green
B: Blue

- 2 Select [Picker] or [Slider] depending on which color selection method you want to use.

Use the following procedure to specify the color.

When [Picker] is selected

Move the mouse pointer to the desired point in the color field and click, or specify the color by numeric value input.

When [HSB] is selected

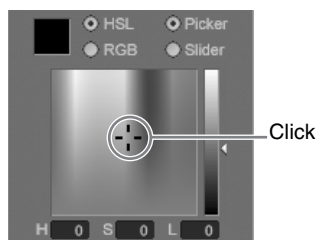

When [RGB] is selected

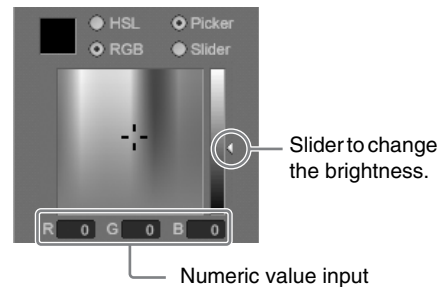

Note

If you move the slider (on the right of the color field) toward the top or bottom, then whatever color you select, only white or black will appear. Setting a value of about 200 makes it easiest to distinguish the colors.

When [Slider] is selected

Move the sliders, or specify the color by numeric value input.

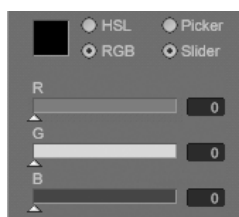
When [HSL] is selected**When [RGB] is selected****Note**

When [HSL] and [Slider] are selected, setting the [L] and [S] numeric value to about 200, and then moving the [H] slider makes it easier to distinguish the colors.

Changing the color using the Eyedropper tool

You can pick the color used by another object and then set that color as the color of the object.

- 1 Click the eyedropper tool.



The mouse pointer changes to an eyedropper.

- 2 Left-click the color you want to pick.



The color of the eyedropper width window changes to the color you picked.

Note

You can pick the color with the eyedropper from any part of the screen: background, text, character outline, line object, or captured image.

- 3 Right-click the place you want to change.
The color changes to the color you picked.



Note

After you select a color with the eyedropper tool, you can change the color of the color selection area to the color selected with the eyedropper tool if you place the mouse pointer within the color preview square in the color creation section and then right-click.



Changing the transparency

You can set a transparency value for the color of an object.

Note

This section describes the example of a text object color.

- 1 Click the selection tool, and select the object (page 97).
An orange border appears around the object.



- 2 Select the Color tab of the [Text] tab.

Notes

- To set color transparency for the shadow of an object, select the Shadow tab of the [Text] tab.
- To set color transparency for a line object, select the Color tab or Shadow tab of the [Line] tab.
- To set color transparency for the background, select the [BG] tab.

- 3 Move the [Transparency] slider, or enter a numeric value for the transparency.



The color of the text becomes transparent as follows.



Applying a color gradation

You can apply a gradation to the color of an object.

Note

This section describes the example of a text object color.

- 1 Click the selection tool, and select the object (page 97).
An orange border appears around the object.



- 2 Select the Color tab of the [Text] tab.

Note

To set gradation for a line object, select the Color tab of the [Line] tab.

- 3 Select the [Gradation-Pattern] check box.



This applies the color gradation as follows.



Changing the gradation pattern

- 1 Click the selection tool, and select the object with the gradation (page 97).
An orange border appears around the object.



- 2 Select the Color tab of the [Text] tab.
- 3 Click the [Gradation-Pattern] ▼ button.
The following patterns appear.

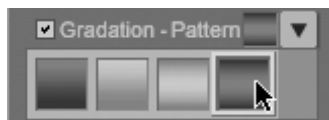

- 4 Select a pattern.
This changes the pattern.

ANYCAST STATION

Object Layout

This section describes how to change the object front-to-back positioning, and adjust the layout.

Changing the object front-to-back positioning

The tools used to carry out front-to-back positioning and their functions are as follows.

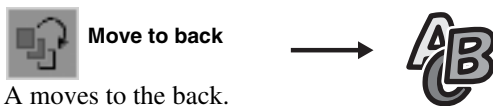
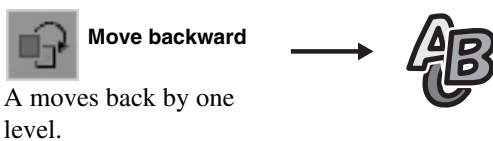
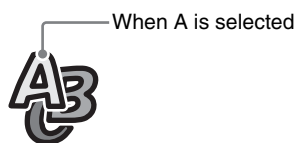
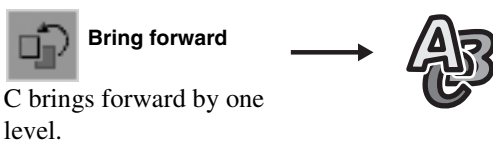
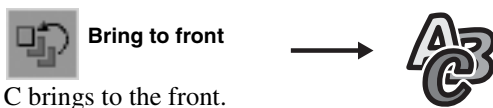
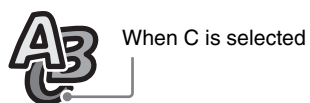

Example:
To move the object from the back to the front

- 1 Click the selection tool, and select the object to be moved.

Select the object at the back



An orange frame appears around the object, and it appears at the front.

- 2 Click the Move to front tool.
 This moves the selected object to the front.



Positioning objects

You can center the selected object vertically or horizontally within the frame. The tools used to carry out centering and their functions are as follows.



This centers vertically within the frame.

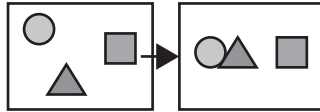

This centers horizontally within the frame.

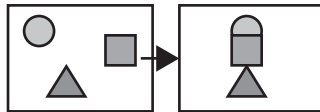

This positions the object so that its lowest part is aligned to a predetermined position.

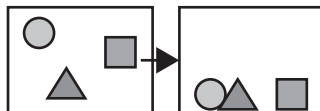

Setting the lower third position

Selecting an object and then clicking the lower third memory tool sets the lowest part of the selected object as the lower third position. To restore the lower third position to its default setting, click the lower third reset tool.

Note

With the default setting, the object is moved so that its lowest part is aligned to a position at the bottom of the safe zone inside the sheet.

Example: Centering an object vertically

- 1 Click the selection tool, to select the object you want to position.



- 2 Click the vertical centering tool.
This centers the selected object vertically.



Adding and Deleting Sheets

In the text typing tool software you can handle multiple sheets in a single file.

Adding a new sheet

- 1 Click the [New Sheet] button in the sheet operation section.

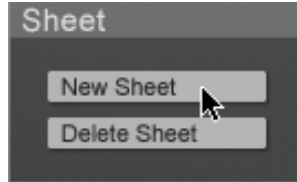

The following confirmation message appears.

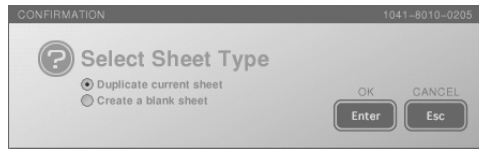

- 2 Select [Duplicate current sheet] or [Create a blank sheet].
Duplicate current sheet: Create a new sheet as a copy of the currently open sheet object .
Create a blank sheet: Create a new, blank sheet.
- 3 Click the [Enter].
 The new sheet is inserted as the next page after the open sheet.

Deleting a sheet

- 1 With the page operation section (page 38), display the sheet you want to delete.
- 2 Click the [Delete Sheet] button in the sheet operation section.



This deletes the displayed sheets.

Simulating the Keying Effects

By displaying an image captured from the program output video, or the checkered pattern as the background, you can check the keying effect of a created object.

Displaying a captured program output video image as the background

- 1 Open the file you want to simulate a keying effect.

For the method of opening the file, see “Opening an existing file” (page 98).



2 Select [Live] of the view operation section.

When you select [Live], the image captured from program output video when you switched from the main software appears in the background.

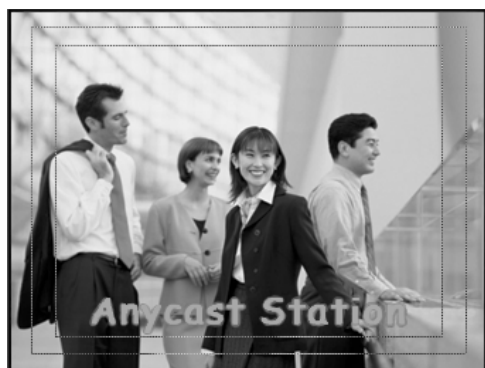

3 Click the [Capture] button in the view operation section.

Each time you click, this captures the current image.

Setting Background Display

You can set the background display as follows by selecting a background display selection button in the view operation section.

Background setting	Display effect
Checker	Checked pattern + object When the color selection button in the [BG] tab is [Paint]: checkered pattern + background of user-created background color (transparency and gradation settings: can be checked) + object
Live	Program output capture image + object If the [BG] tab color selection button is [Paint]: Program output capture image + background of user-created background color (transparency and gradation settings: can be checked) + object
BG	Background color set on the [BG] tab (transparency setting: cannot be checked) + object

For details on the [BG] tab settings and background display settings, see “Background Color Operations (Creating Telop and Flip)” (page 115).

Displaying the safe zone

The “safe zone” refers to the area of the frame within which an object can be inserted as a key in the program output video without risk of being outside the viewing limits on a connected output device.

When the [Safe Zone] checkbox in the view operation section is selected, the safe zone appears.

Unselect the checkbox to hide the safe zone.

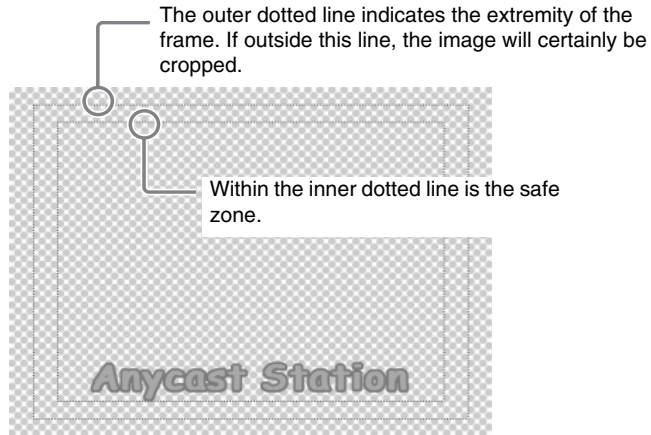

When 4:3

Key Combination in the Anycast Station Main Software

Start the Anycast Station main software, and use the file created in the text typing tool software for a keying.

- 1 Click the [Exit] button at the lower left of the screen.
This starts the Anycast Station main software.

Note

You can also use the keyboard F5 (Fn+5) key to switch to the Anycast Station main software.

For details, see “To close the text typing tool software and start the Anycast Station main software” (page 95).

- 2 Press the “INT” NEXT selection button.
The INT material selection menu appears.

3 Select the file or sheet, and confirm.

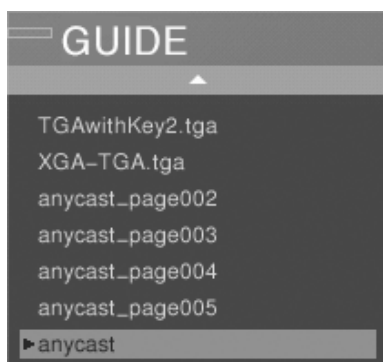

Notes

- If the file consists of multiple sheets, the first sheet is identified as the file name, and the second and subsequent sheets are identified as the file name + sheet number.
- Files created in the text typing tool software have no extension.

The selected sheet appears as the “INT” source viewer and PVW viewer.

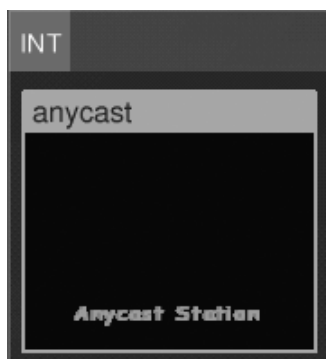

You can combine as a downstream key (DSK) or luminance key.

For details, see the section “Using the Downstream Key (DSK) Function to Add Text or an Image” (page 78) and “Using Luminance Keying” (page 84).

Importing a Font File

You can import a font file that has been saved on a “Memory Stick” or USB flash memory.

The font file must have been saved in the dedicated folder for fonts: MSSONY/PRO/LPS/ANYCAST/FONT.

- 1 Insert the “Memory Stick” or USB flash memory in the rear panel “Memory Stick” slot or USB connector.

The upper USB connector is number 1, and the lower connector is number 2.

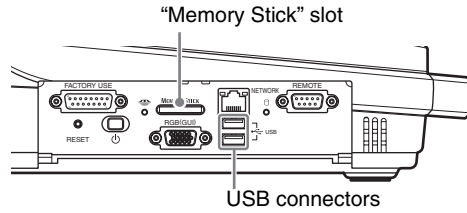

- 2 In the file operation section, click the [Import FONT...] button.

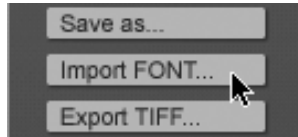

The following confirmation message appears.

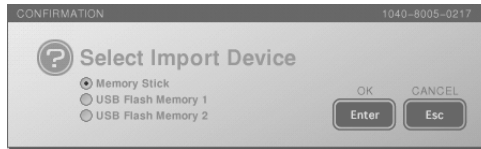

- 3 Select the inserted media, and click [Enter].
The font list appears.

- 4 Select the font file to import from the font list.

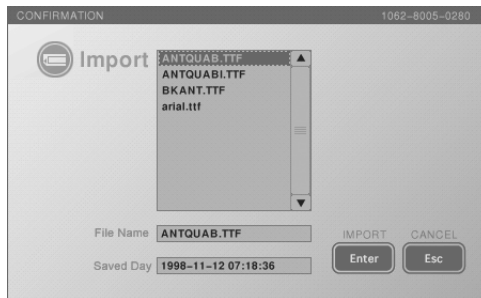

- 5 Click [Enter].
While importing, the following message appears.

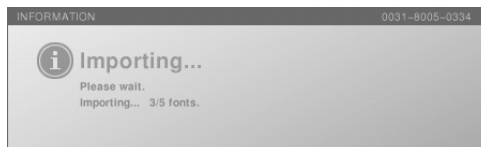

When the import is completed, a completion message appears, and the font is added to the [Font Name] list.

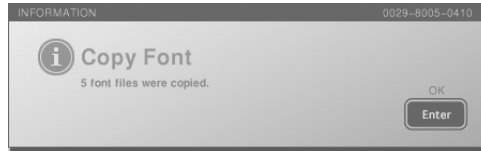

6 Click the [Enter].

Caution

- This imports all font files within the FONT directory of the “Memory Stick” or USB flash memory. If the same font file exists in this unit, it is overwritten.
- The only font files that can be imported are TrueType fonts, with a file extension “.ttf” or “.ttc”.
- Even if an imported font is one the user has purchased, for commercial use, such as providing telop on a broadcast, the permission of the provider of the font for commercial use of the font may be necessary. Note that the nine fonts provided with the Text Typing Tool may be used for commercial purposes without further formality. These fonts are true type fonts developed and sold by Ricoh Company, Ltd.

Deleting a Font File

You can delete a font file that was imported into the unit.

1 Click the [Delete FONT] button in the file operation section.

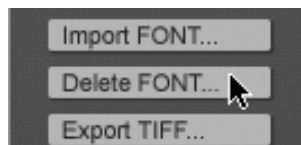

The font list appears.

2 Select the font file to delete from the font list.

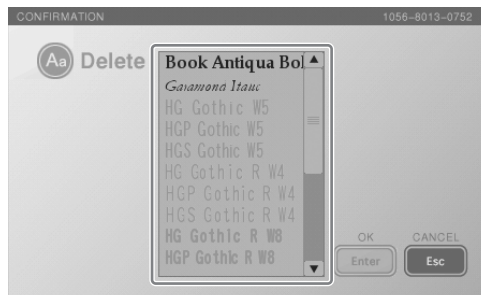

Notes

- You can select multiple font files by clicking (or pressing the ↓ and ↑ keys) to select file names while holding down the Shift key or by dragging to select file names.

- If you attempt to delete a font file while a file is open, the font files of fonts used by the file currently open cannot be selected.
- Fonts included in the same .ttc file are selected at the same time.

3 Click [Enter].

A confirmation message appears.

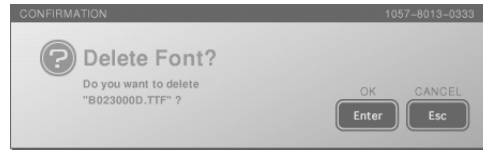

4 Click [Enter].

The specified font file is deleted.

Caution

Deleting a font clears the information for Undo and Redo operations.



Controlling Cameras

This unit is equipped with a VISCA controller. VISCA (Video System Control Architecture) is a technology used for connecting a video device to a controller, and controlling the video device from the controller. In this unit, you can remotely control a camera supporting VISCA protocol connected to the VISCA connector.

The remote control operations available include the following.

- Pan
- Tilt
- Zoom
- Focus
- Aperture (iris) control
- White balance adjustment

Note

The controllable range depends on the camera you are using.

Registering Cameras to be Controlled

By registering a camera supporting the VISCA protocol with this unit you can control it from the unit.

You can connect up to seven cameras supporting VISCA protocol to this unit in a daisy-chain, and control the cameras from this unit at addresses VISCA 1 to VISCA 7 in sequence. In this unit, you control a camera by specifying one of these addresses.

Caution

The maximum number of simultaneous video signal inputs to this unit is six.

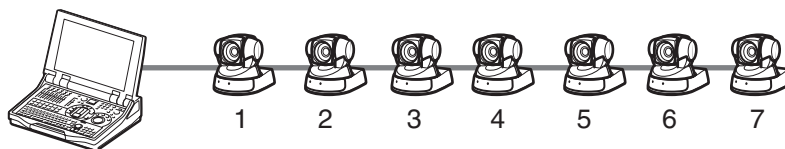

- 1** Connect the camera(s) supporting VISCA protocol to this unit.
For camera connection, see “Connecting a Camera with VISCA Support” (page 50).
- 2** Assign the input signal from the camera to a selection button.
For assigning the input signal, see “Assigning video input signals to the selection buttons” (page 57).
- 3** ① Select the number of a selection button assigned to a camera supporting the VISCA protocol, and confirm; ② select [Control], and confirm; ③ select the camera address, and confirm.

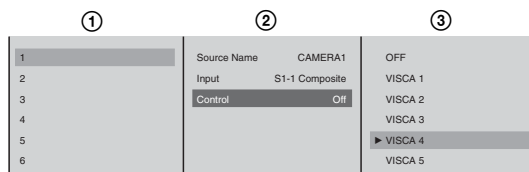

4 Press the MENU button to close the menu.

Controlling Camera Manually

Control a camera manually supporting the VISCA protocol from this unit. With the default settings of this unit, focus and iris settings are set to auto, and white balance setting is set to “no operation”. To control these manually, you need to set them in the menu.

Carrying out manual control

- 1 Press the NEXT selection button to which the camera video is assigned. The camera guide menu appears in the menu display.

Note

If the camera guide menu does not appear, follow the procedure in “Registering Cameras to be Controlled” (page 132).

A guide to operations appears in the camera control guide.

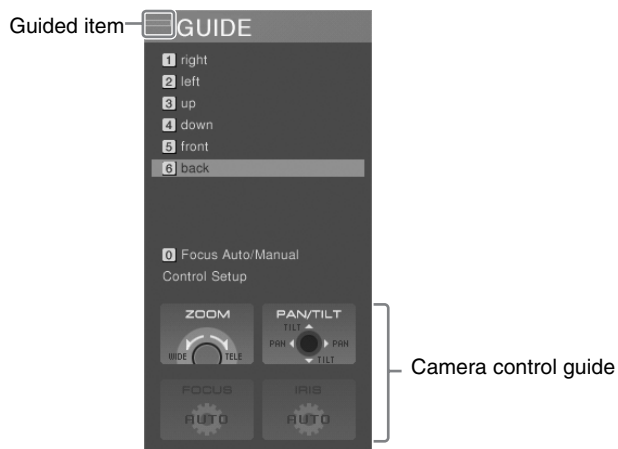

If the focusing and iris control are set to auto, then “AUTO” appears. To change the settings manually, see “Setting the Camera Control” (page 137).

- Following the guide, control the camera, using the front panel buttons and dials.

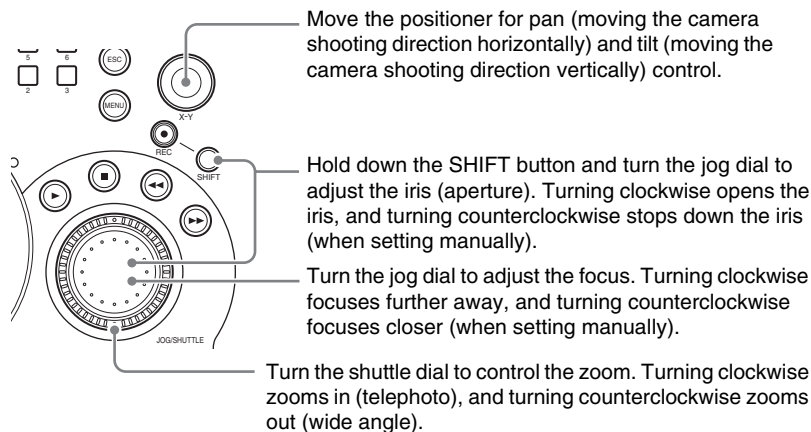

Storing a Camera Preset

The camera preset function allows you to save the state of the camera supporting VISCA protocol to one of the numeric buttons on the front panel. Then by pressing the numeric button, you can automatically set the camera to the saved state.

For example, during a lecture relay, you can store settings for standard shots, such as a speaker close-up, speaker full-body shot, guest panel, or audience view, simplifying the work of switching among these views.

In the camera preset, you can save the pan, tilt, zoom, and focus settings, the aperture (iris) status, the white balance adjustment, the control mode (auto/manual, etc.).

Caution

If the camera you are using is an EVI-D100/EVI-D100P, set the camera BACK UP switch to the ON position before storing.

Storing a camera preset

- Press the NEXT selection button to which the camera video is assigned. The camera guide menu appears in the menu display. Camera presets appear at the top of the camera guide menu.

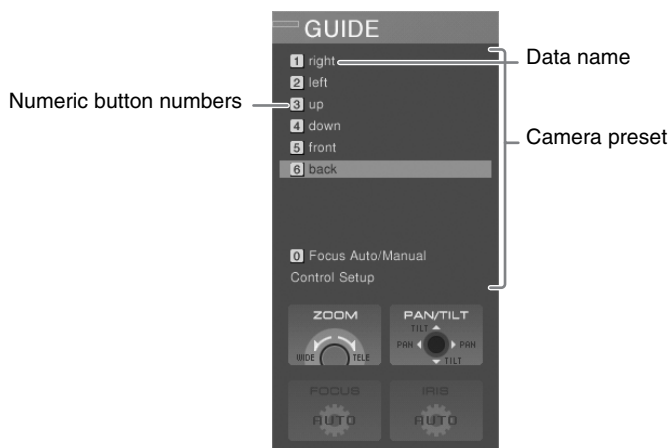

- 2 Control the camera to determine the shot.
- 3 With the jog roller, select the camera preset number (from 1 to 6), and confirm.

The camera preset settings menu appears.

- 4 Set the following items as required.

Applying a name to the preset

- ① Select [Data Name], and confirm; ② enter the name in the input box, and confirm.

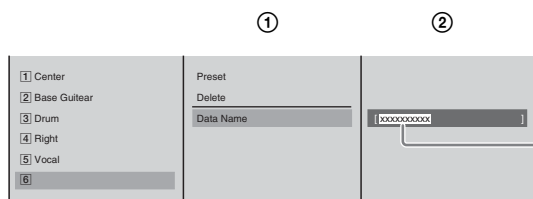

Enter up to 20 alphanumeric characters.
* The camera guide menu can only display a limited number of characters.

- 5 Select [Preset], and confirm.

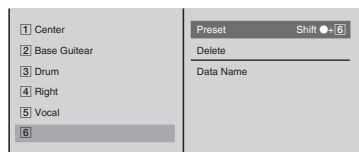

This saves the preset in the numeric button.
The saved preset appears in the camera guide menu.

Note

Even if the camera guide menu is not displayed, you can register a camera preset by holding down the Shift button and pressing any numeric button (between 1 and 6).

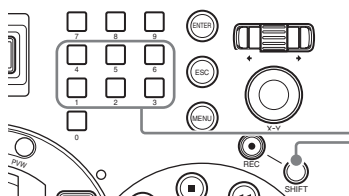

Hold down the Shift button, and press one of numeric buttons 1 to 6.

Recalling a preset

- 1 Press the NEXT selection button to which the camera video is assigned.
The camera guide menu appears in the menu display.
- 2 Using the numeric buttons on the front panel, press the number in which the preset is saved.
The numeric button lights amber, and the camera is set to the preset state.



The selected number appears in amber.

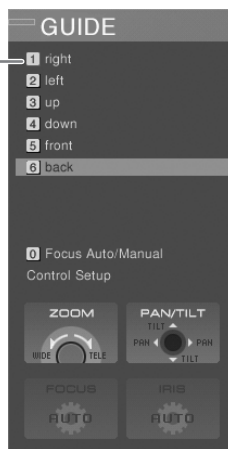

Deleting a saved preset

- 1 Press the NEXT selection button to which the camera video is assigned. A camera guide menu appears in the menu display.
- 2 Select the number of the preset you want to delete with the jog roller, and confirm. The camera preset settings menu appears.
- 3 Select [Delete], and confirm.

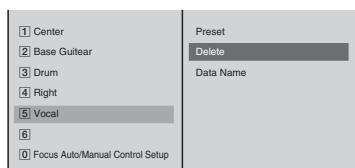

The following confirmation message appears, as follows.

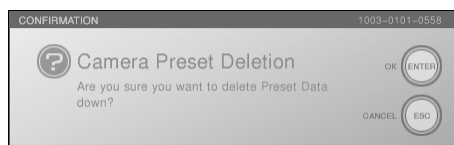

- 4 Press the ENTER button. This deletes the preset, and the number changes to gray.

Setting the Camera Control

To change the default settings of this unit, or to enable pan, tilt and zoom for a ceiling-mounted camera, use the following procedure.

- 1 Press the NEXT selection button to which the camera video is assigned. A camera guide menu appears in the menu display.
- 2 With the jog roller, select [Control Setup], and confirm. The submenu appears.



- 3 Set the following items in the submenu.

Disabling remote control of pan and tilt, or zoom

- ① Select [Pan/Tilt] or [Zoom], and confirm; ② in the submenu select [Disable], and confirm.

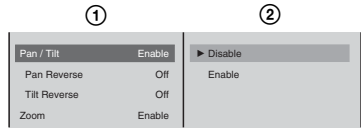

Reversing directions for ceiling-mounted cameras

When a camera is ceiling-mounted, you can reverse the pan and tilt directions.

- ① Select [Pan Reverse] or [Tilt Reverse], and confirm; ② select [On], and confirm.

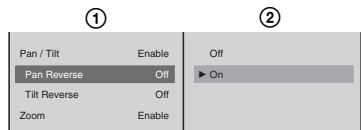

Enabling manual focus and iris control

- ① Select [Focus] or [Iris], and confirm; ② select [Manual], and confirm.

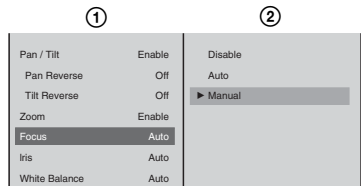

Note

You can switch the auto focus and manual focus by pressing “0” of the numeric keys.

Manually controlling white balance

① Select [White Balance], and confirm; ② set [Manual], and confirm.

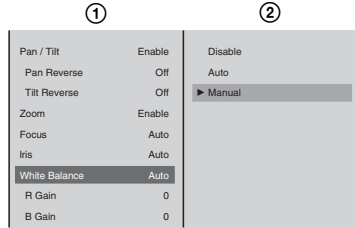

③ Select [R Gain] or [B Gain], and confirm; ④ move the slider to adjust the values.

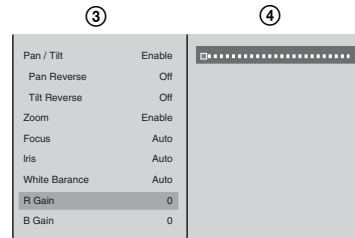

Note

When not using control from this unit, select [Disable].

4 Press the ESC button to close the sub menu.

Resetting the Camera

After starting up this unit, carry out this procedure after powering the camera supporting the VISCA protocol off and on again, or disconnecting and reconnecting the VISCA cable.

Perform this operation even if “No Response” appears as the camera status.

- 1** Press the NEXT selection button to which the camera video is assigned. A camera guide menu appears in the menu display.
- 2** With the jog roller, select [Control Setup], and confirm.
- 3** In the submenu, select [Reset Camera], and confirm.

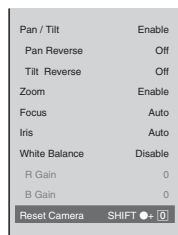

Note

You can also reset the camera by holding down the Shift button and pressing the numeric 0 button.

About Camera Tallies

When the camera supports the camera tally function (BRC series, etc.) The camera tally lamp lights when the input from the camera is being used as program output.

Caution

Multiple settings are possible for the [Video Input Assign] [Control] setting. In this case, the camera tally lights when the video from any of the source viewers for which the [Control] setting is made is being used for program output.

When using CCU, etc.

If the FACTORY USE connector of the unit is connected to the tally connector of a CCU (camera control unit), the tally lamp lights for any camera that is assigned to a PGM selection button or NEXT selection button on the front panel, as long as video from that camera is being used as program output (the button lights red).

Specifications of the FACTORY USE Connector

The specification of each pin is as shown below.

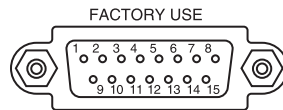

Pin Number	I/O	Signal Name	Description
1	I	-	Unused
2	I	-	Unused
3	I	-	Unused
4	I	-	Unused
5	I	-	Unused
6	I	-	Unused
7	-	GND	GROUND
8	-	GND	GROUND
9	O	GPO0	GIP OUT1: Controls the tally of the camera assigned to source number 1. On: GND; Off: Open
10	O	GPO1	GIP OUT2: Controls the tally of the camera assigned to source number 2. On: GND; Off: Open
11	O	GPO2	GIP OUT3: Controls the tally of the camera assigned to source number 3. On: GND; Off: Open

Pin Number	I/O	Signal Name	Description
12	O	GPO3	GIP OUT4: Controls the tally of the camera assigned to source number 4. On: GND; Off: Open
13	O	GPO4	GIP OUT5: Controls the tally of the camera assigned to source number 5. On: GND; Off: Open
14	-	GND	GROUND
15	-	GND	GROUND

Caution

Because the GPO of the FACTORY USE connector on the unit has a built-in protection circuit, it may not operate properly depending on the input circuit configuration of the device to be connected.

See the diagram below, make the cables.

Connected device	CCU-D50	HFU-X310
Vcc	+9 V	+3.3 V
R	510 k ohm	None (Short circuited)

Sample circuit diagram

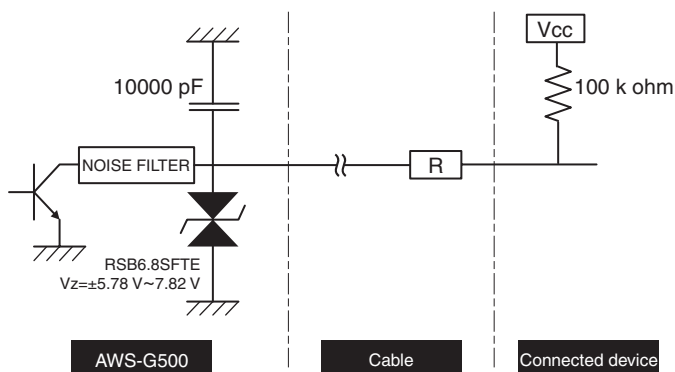

Caution

When using the CCU, the camera tally control is possible for the camera assigned to source number 1 to 5. When the camera is assigned to source number 6, the camera tally cannot be lit.

Notes

- When the video from a camera with the tally lit is being used for program output, then if you press the FTB button, the tally goes off.
- If you open a file on the hard disk in the source viewer assigned to the video from a camera with the tally lit, the tally goes off.

Audio Mixing

This section describes how to perform mixing on the audio signals input to the unit, and output the final audio (output program) from the PGM output connectors.

First assign the audio signals to channel faders, as described in “Audio Signal Related Settings” (page 59).

- 1 Press the CH ON button on the front panel to select the channels that you want to mix.

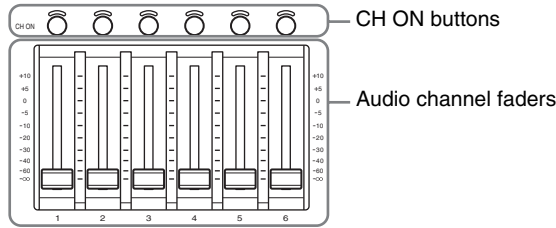

- 2 Adjust the levels with the audio channel faders, and carry out mixing.

For audio input/output signal fine adjustment settings, see “Video/Audio Signal Adjustments and Settings” (page 160).

Adjusting the PGM output audio level

Use the PGM fader on the front panel to adjust the level of audio from the PGM output connectors.

Adjusting the monitored audio levels

Adjust the levels of the built-in speakers, headphones, and devices connected to the monitor output connectors with the monitor level adjustment knob on the front panel.

For the selection of audio to be monitored, see “Monitoring Output Audio” (page 158).

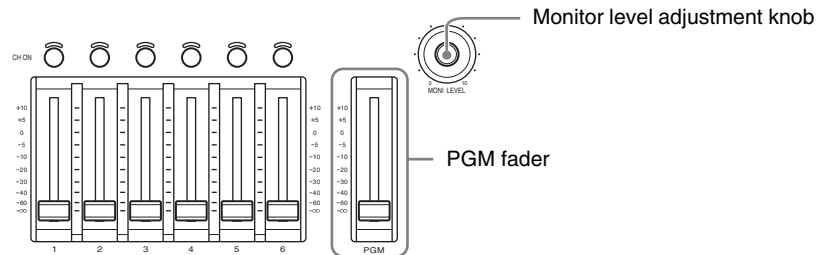

Recording Video and Audio on an External Device

If you use the DV connector and i.LINK connector of the SD interface module (BKAW-570) or the PGM SDI output connector and i.LINK connector of the serial digital interface module (BKAW-580), the program output from the unit and sources input to the unit can be recorded on a VTR or external hard disk.

Note

The DV connector, i.LINK connector, and PGM SDI output connector support different devices and recording data.

DV connector (DV IN/OUT DV PGM): connect a VCR, to record the program output video and audio.

i.LINK connector (HDD): connect an external hard disk, to record the video and audio input (page 144).

PGM SDI output connector (SDI OUT): connect an SDI input compatible VTR to record program output video and audio.

Caution

If a signal subjected to special processing is input to the synchronization signal, normal recording may not be possible.

Recording Program Output on a VCR

When using the DV connector

By connecting a VCR to the DV connector (DV IN/OUT) of the SD interface module (BKAW-570) on the rear panel, you can record the program output video in DV format.

Procedure for recording on a VCR

To begin recording to a VCR, select the DV connector to be used for recording.

Caution

If a DV connector is set to be used for recording, the recording of material input from the composite video input connector and S-video input connector of the same module is no longer possible.

- 1 Connect the VCR to the DV connector.

Note

Depending on the model of VCR, signal input/output settings may be required. Refer to the Operating Instructions for the device to be connected.

- 2 Press the MENU button.
- 3 In the top menu, select [DV Output].

- 4 ① Select [PGM Output] and confirm; ② Select the DV connector to which the VCR is connected from the list and confirm.

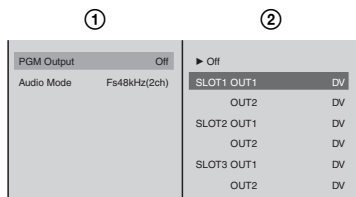

This sets the selected DV connector for program output, and program video is output.

Note

- At this point, the selected DV connector is grayed out and unavailable in the [Video Input Assign] menu and [Audio Input Assign] menu.
- When an external hard disk is connected to an i.LINK connector of the same interface module as the selected DV connector, the hard disk status of the source viewer assigning images from each of the input connectors on that module disappears.

- 5 ① Select [Audio Mode] and confirm; ② select the audio sampling rate for the program output and confirm.

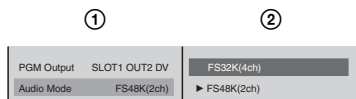

The meanings of these items are as follows.

FS32K(4ch): 12 bit, 32 kHz sampling, 4-channel output (select this item if you want to later record to channels 3 and 4 on a device with an audio dubbing function).

FS48K(2ch): 16 bit, 48 kHz sampling, 2-channel output

The audio output is as follows.

- 1 ch:** L
- 2 ch:** R
- 3 ch:** L (the same 1 ch)
- 4 ch:** R (the same 2 ch)

- 6 Press the MENU button, to close the menu.

- 7 Operate the VCR to start recording.

Notes

- It is not possible to carry out recording operations on the VCR from this unit.
- When connecting to DV devices, if the video or audio output is lost, or there is noise, disconnecting and reconnecting the cable, or powering the DV device or this unit off and on again may solve the problem.

When using the PGM SDI connector

By connecting a VCR that supports SDI input to the PGM SDI output connector (SDI OUT) of the serial digital interface module, you can record program output.

Procedure for recording on a VCR

Program video and audio are always output as SDI signals from the PGM SDI output connector.

Connect the VCR to the PGM SDI output connector and then start recording on the VCR.

Note

If the video output signal format (NTSC/PAL) of this unit is changed, the format in which signals are output from the PGM SDI output connector also changes.

Recording Inputs on an External Hard Disk

You record the input source on an external hard disk connected to the i.Link connector (HDD) of the interface module.

With video input to an interface module to which an external hard disk drive is connected, and audio with the same source number as the video combined together, two inputs can be recorded simultaneously.

For details of formatting an external hard disk, see the section “Formatting an External Hard Disk” (page 179).

Caution

- It is not possible to record with an external recorder connected to the i.LINK connector (HDD).
- When recording on the hard disk, be sure to read the section “External Hard disk” (page 10).

Recorded settings and file details

Recorded settings

Video	ACCESS menu settings (Adjustment is not possible for DV video)
Audio	ACCESS menu [Input Trim] setting (analog audio only)
	Top menu [Audio MIC/LINE Level] setting

File details

File name	YYMMDD-(source number)-(3-digit suffix) (.avi)
File format	DV format (.avi)
Timecode	Not included

Connecting an external hard disk

- 1 Connect the external hard disk to the i.LINK (HDD) connector of the interface module (6-pin).

Connect the disk to the same interface module as the input you want to record.

i.LINK connector (6-pin)

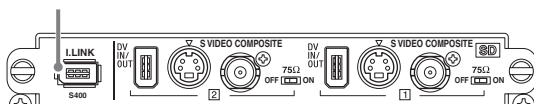

- 2 Power on the hard disk.

Caution

Always connect the hard disk and power it on before starting up this unit.

- 3 Press the  (power) button on the side panel, to start up this unit.

The operation screen appears, and the device status for the source viewer for the interface module to which the hard disk is connected shows the hard disk number, remaining capacity, and available recording time.

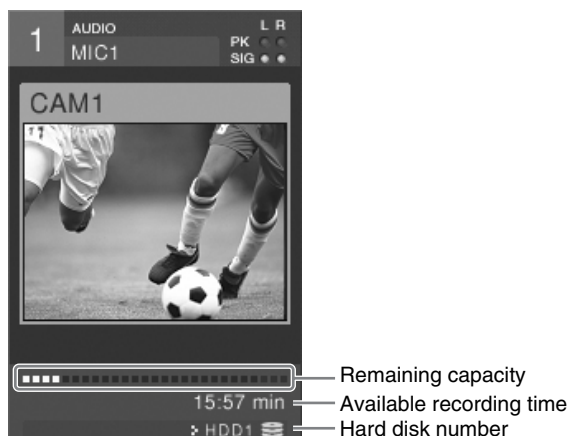

Caution

When recording two sources simultaneously, the indicated remaining capacity diminishes at twice the normal rate, and therefore the actual remaining recording time is approximately half of that shown.

Starting recording for each input

- 1 Select the source to be recorded in the NEXT selection buttons.

Caution

The inputs that can be recorded are only those to the external interface module to which the hard disk is connected (inputs for which the source viewer shows the hard disk number and recording status).

- 2 Hold down the REC button and press the PLAY button.

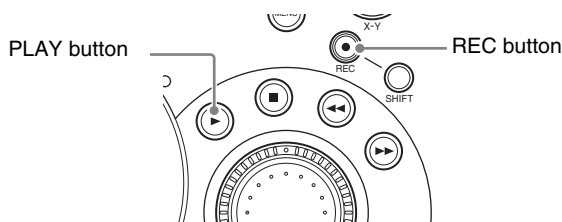

The source viewer device status shows “REC PAUSE”.

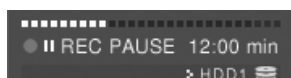

The following confirmation message also appears at the same time.

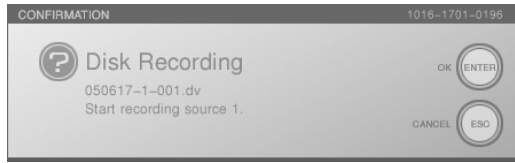

- Press the ENTER button or PLAY button.
The device status indication changes to “REC”, and recording starts.



Note

You can repeat steps 1 to 3 for a different source, for simultaneous recording of multiple inputs.



Material recorded

Audio:

- The audio is recorded together with the video assigned to the same source number. It is not possible to record audio only.
- It is not possible to record DV video and analog audio together. If you start recording of DV video and analog audio, a confirmation message appears and DV audio is recorded combined with DV video.

Timecode:

A timecode is not included.

Caution

Recording is paused (file is not closed) if signals stop being input. Recording resumes when signals begin to be input again.

Stopping recording

- Select the source to be stopped recording in the NEXT selection buttons.
- Hold down the REC button and press the STOP button.
In the device status of the source viewer, the “REC” indication disappears, and recording stops.

Operations on Files on the External Hard Disk

You can carry out operations on files stored on an external hard disk connected to the interface module.

Note

Operations can also be carried out on .dv files recorded with an older version.

For the method of connection, see the section, "Connecting an external hard disk" (page 144)

File indications

The file name and timecode for a saved file are shown as follows.

File name: YYMMDD-(source number)-(3-digit suffix)

The 3-digit suffix is automatically added, in sequence from 001.

Timecode: always starts from 00:00:00:00.

Playing files

- 1 Press the NEXT selection button for the source viewer showing the hard disk number.

The HDD file guide menu appears in the menu display.

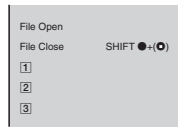

Note

When a DV connector of the SD video interface module with an external hard disk drive connected is set to be used for recording, the HDD file guide menu is not displayed.

- 2 Select [File Open] and confirm.

The file list appears.

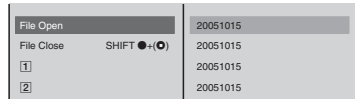

Caution

- Only files recorded on this unit appear.
- It is not possible to open a file while it is being recorded.

Note

File information

Information on the selected file is displayed as shown below if you press and hold down the jog roller → button or the → key on the keyboard.

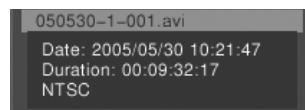

3 Select a file and confirm.

The frame of the file appears in the source viewer and PVW viewer, stationary.

Caution

There may be a delay until the file opens.



4 Press the PLAY button.

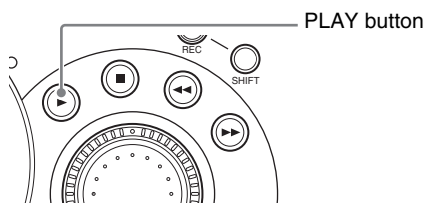

Playback starts in the source viewer and PVW viewer.



Rapid recall of the last file played

You can recall the last file played without needing to select it from the file list. In this case, press the NEXT selection button for the source viewer on which you played the file, then press the PLAY button to continue playback (without displaying a file list).

Other playback operations

- 1 Press the NEXT selection button with the same number as the source viewer for the file on which you want to operate.
- 2 Press any of the following buttons to carry out the operation.

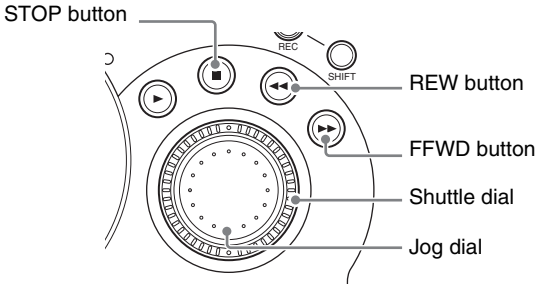

STOP button

Press this during file playback to stop playback of the file.

REW button

Press this while a file is open to play back in the reverse direction.

Notes

- Each time you press, the reverse speed increases (x2, x4, x8, x16, x32, x64).
- If you press the REW button while holding down the SHIFT button, the play position skips to the beginning of the file.

FFWD button

Press this while a file is open to play back fast in the forward direction.

Note

- Each time you press, the fast forward speed increases (x2, x4, x8, x16, x32, x64).
- If you press the FFWD button while holding down the SHIFT button, the play position skips to the end of the file.

Shuttle dial

Turning this dial clockwise plays a file in the forward direction at one of seven speeds corresponding to the amount the dial is turned (x1/8, x1/2, x1, x2, x4, x8, or x16). Turning this dial counterclockwise plays the file in the reverse direction at one of seven speeds corresponding to the amount the dial is turned (x1/8, x1/2, x1, x2, x4, x8, or x16).

Jog dial

Turning this dial while a file is open plays the file at a slow speed that corresponds to the speed at which the dial is turned.

Note

The speed by each operation appears in the device status of the source viewer and PVW viewer.

Auto Repeat Playback

You can set playback of a file to start again automatically from the beginning each time playback ends.

- 1 Press the NEXT selection button of the source viewer displaying the hard disk number.
The HDD file guide menu appears in the menu display.
- 2 Open a file.
For details on opening files, see “Playing files” (page 147).
- 3 Select [Auto Repeat].
Selecting this item toggles auto repeat On and Off.

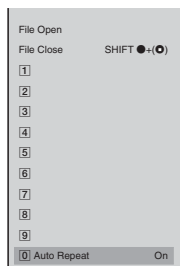

An icon appears in the device status of the source viewer and PVW viewer.



Note

You can switch auto repeat on/off by pressing the [0] numeric button.

Closing a file

You can close a file in any of the following ways. Closing a file returns to the video and audio of the assigned input.

- Select [File Close] from the HDD file guide menu.
- Press the STOP button while holding down the SHIFT button.

About Deleting Files

For details on deleting files, see “Deleting Files” (page 177).

Disconnecting the External Hard Disk

When disconnecting the external hard disk, use the following procedure to disconnect safely.

- 1 Press the MENU button.
- 2 In the top menu, select [File Manager].

- 3** ① Select [Disconnect] and confirm; ② Select the hard disk to disconnect, and confirm.

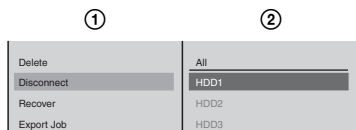

Note

To disconnect all of the hard disks together, select [All]. However, the hard disk can not be disconnected during recording.

The following message appears.

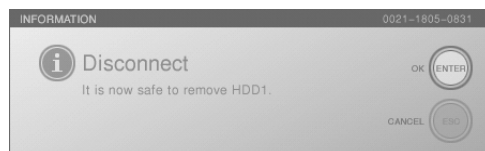

- 4** Press the ENTER button, to close the message.
5 Power off the hard disk, and disconnect.

Recovering an External Hard Disk

If as the result of one of the following operations the external hard disk has become inaccessible from another computer or from this unit, then carry out disk recovery.

- If the hard disk is disconnected without carrying out the proper procedure for disconnection on this unit
- If the hard disk is disconnected from a computer without the proper procedure for disconnection

- 1** Press the MENU button.
2 In the top menu, select [File Manager].
3 ① Select [Recover] and confirm; ② Select [HDD1] and confirm.

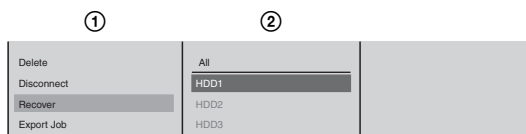

The following confirmation message appears.

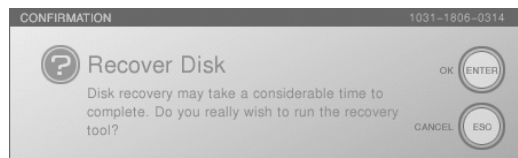

4 Press the ENTER button.

Recovery starts.

When recovery is completed, the following message appears.

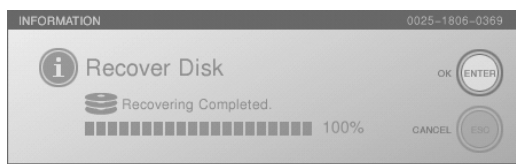

5 Press the ENTER button to close the message.

6 Press the MENU button, to close the menu.

Caution

If the hard disk was disconnected without carrying out the proper procedure, follow the messages that appear to carry out recovery. It may be possible to access files on the hard disk without carrying out the recovery procedure, but the content of such files is not guaranteed.



Using a Computer to Play Files Recorded on an External Hard Disk

You can play files recorded with this unit, using a computer.

Caution

The proper procedure must be carried out before disconnecting the external hard disk. For details see the section “Disconnecting the External Hard Disk” (page 150).

- 1 Install an ext3 driver in the computer.

Note

The following site provides links to the portal site and information about the driver and the file format (.avi).

<https://www.ecspert.sony.biz/ecsite/>

<https://servicesplus.us.sony.biz/SoftwarePlusSearch.aspx> (for the customers in the U.S.A.)

<https://www.sonybiz.net/anycast> (for the customers in Europe)

- 2 With an IEEE1394 cable, connect the hard disk to the computer.
The disk is mounted as two drives, with volume labels “system” and “data.”
- 3 Select files from the folder anycast/data in the drive with volume label “data,” and play them back.

Disk partitioning

When the external hard disk is formatted on this unit, two partitions are created: a meta partition and a data partition.

Meta partition: administrative information; volume label: “system”

Data partition: storage for created files; volume label: “data”

Caution

On the computer, if you alter the administrative information, or change file names, this will render the files unplayable on this unit.

Using the Intercom Function

Connecting an external intercom system requires a connection operation by the customer.

An intercom system allows the operator to confer with camera operators and others in remote locations. You can use the built-in speakers of this unit and the front panel microphone.

Connecting the Intercom System

Connect the intercom system to the INTERCOM connector on the rear panel. The following shows a connection example of an intercom system.

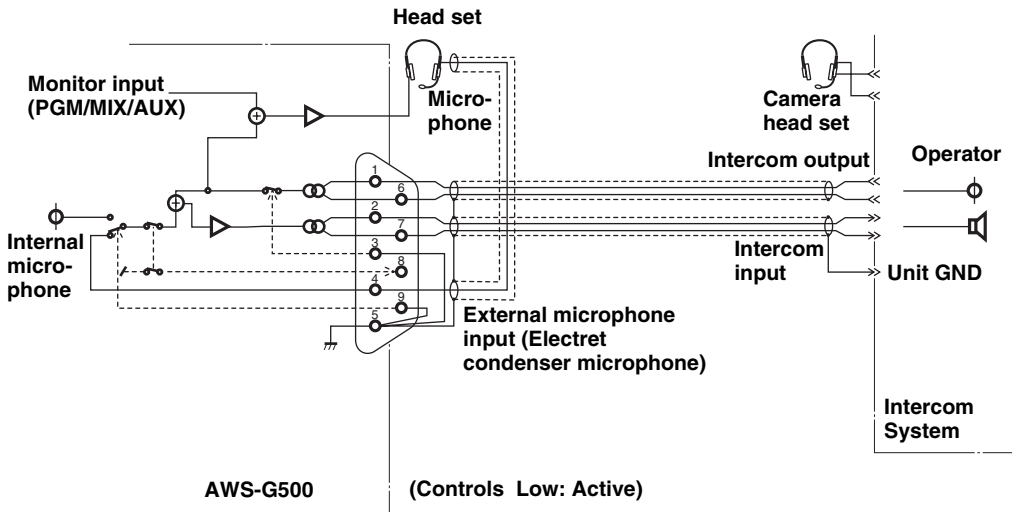

When using a headset, connect the microphone connector to the INTERCOM connector, and connect the headphone connector to the HEADPHONES connector.

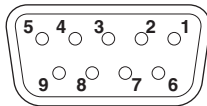

Pin No.	I/O	Signal name	Description
1	I	AUDIO IN (H)	INTERCOM AUDIO SIGNAL INPUT (H)
2	O	AUDIO OUT (H)	INTERCOM AUDIO SIGNAL OUTPUT(H)
3	I	CONTROL IN	INTERCOM RECEIVE CONTROL (LOW ACTIVE)
4	I	MIC IN (+)	ELECTRET CONDENSER MICROPHONE INPUT
5	-	GND	GROUND
6	I	AUDIO IN (C)	INTERCOM AUDIO SIGNAL INPUT (L)
7	O	AUDIO OUT (C)	INTERCOM AUDIO SIGNAL OUTPUT (L)
8	O	CONTROL OUT	TB CONTROL (LOW ACTIVE)
9	I	CONTROL IN	EXT MIC ACTIVE CMD (LOW ACTIVE)

Speaking on the Intercom System

- 1 Connect the external intercom system.
- 2 Press the TB (Talk Back) button, and speak into the front panel microphone (or headset microphone).

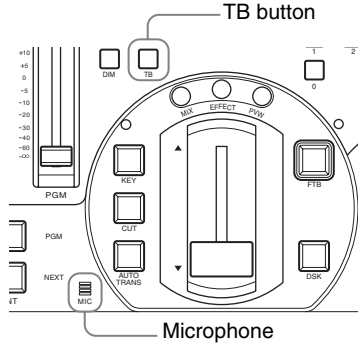

This transmits on the external intercom system. You can listen on the external intercom system using the built-in speakers of this unit or headphones.

- 3 Press the TB button to finish conversation.

Note

While the TB button is lit, the DIM button lights. The relationship between the state of the TB button and the built-in speakers, headphones, and monitor output is as follows.

Monitoring state when using the intercom

Monitor output connector connection	TB button state	Internal speakers		Headphone output		Monitor output
		Output to be monitored *	Sound from the intercom system	Output to be monitored *	Sound from the intercom system	
Yes	On (lit)	Mute	Attenuated output **	Attenuated output **	Output	Output to be monitored * only is output continuously.
	Off	Mute	Output	Output	Output	
No	On (lit)	Attenuated output **	Attenuated output **	Attenuated output **	Output	
	Off	Output	Output	Output	Output	

* This indicates whichever of PGM, AUX1, AUX2, and MIX is selected for [Audio Monitor] in the [Audio Utility] top menu.

** The audio attenuation (“DIM”) function reduces the output level by 20 dB from the normal value.

Monitoring Audio

Use the internal speakers or the connected headphones to monitor the audio input to the unit or the audio output from the unit.

Determining the Audio Signal Output Destinations

Select which output destinations to which the audio assigned for each channel fader should be routed. For the output destination, you can select the PGM output connectors, AUX output connectors, or MIX output connectors.

Output from the PGM output connectors

- 1 Press the ACCESS button in the same column of the channel fader to which the audio you want to be the program output is assigned.
- 2 ① In the top menu, select [PGM OUT]; ② select [On], and confirm.

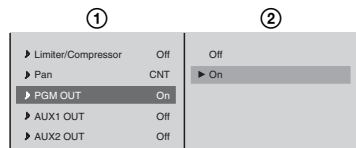

- 3 Press the ESC button to close the ACCESS menu.

Note

You can also close the menu by pressing the same ACCESS button again.

Output from the AUX output connectors

This unit has two sets of AUX output connectors (AUX1, AUX2), and you can create a mix balance with levels different from those of the PGM/MIX output.

- 1 Press the ACCESS button in the same column of the channel fader to which the audio you want to be the AUX output is assigned.
- 2 ① In the top menu, select [AUX1 OUT] or [AUX2 OUT]; ② in the submenu, select [Pre-Fader] or [Post-Fader], and confirm.

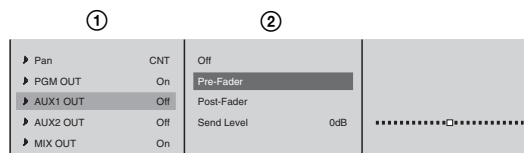

The significance of the items is as follows.

[Pre-Fader]: Output the audio before adjustment by the channel faders. In this case, the audio is output even when the CH ON button is Off.

[Post-Fader]: Output the audio after adjustment by the channel faders.

Note

In either case, when adjusting with the ACCESS menu, the output includes these adjustments (excluding pan).

- 3 After selecting [Pre-Fader] or [Post-Fader] and confirming, ① select [Send Level], and confirm; ② adjust the output level with the slider.

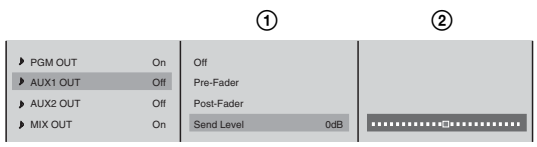

Press the ESC button, to close the ACCESS menu.

Caution

The AUX output connectors output the audio of mixing the left and right audio channels.

Output from the MIX output connectors

- 1 Press the ACCESS button in the same column as the channel fader to which the audio you want to be the MIX output is assigned.
- 2 ① In the top menu, select [MIX OUT]; ② select [On], and confirm.



- 3 Press the ESC button to close the ACCESS menu.

Displaying the Audio Signal Output Destinations

Check where the output destinations are set.

- 1 Press the MENU button.
- 2 In the top menu, select [Audio Output].
- 3 Check the output destination display.
The display lights green when set to [ON] in the audio signal output destination settings (page 156).

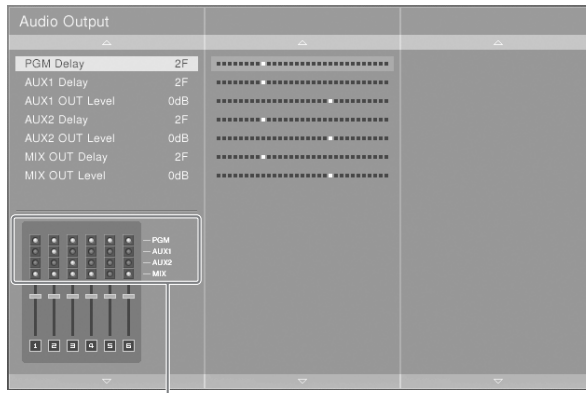

Output destination indication

Monitoring Output Audio

You can select one audio output from this unit (program (PGM) output, AUX output, or MIX output), and listen to it on the internal speakers, speakers connected to the monitor output connectors, or headphones connected to the HEADPHONES connector.

Output sound level can be monitored using the audio level meters on the operation screen.

- 1 Press the MENU button.
- 2 In the top menu, select [Audio Utility].
- 3 ① Select [Audio Monitor], and confirm; ② select the output to be monitored.

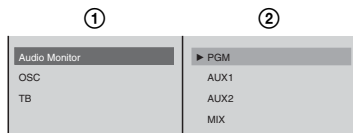

Notes

- Use the monitor level adjustment knob to adjust the level.
- Each time you press the AUDIO MONITOR button, the monitoring cycles through the following sequence. The output destination indication below the audio level meters also changes.

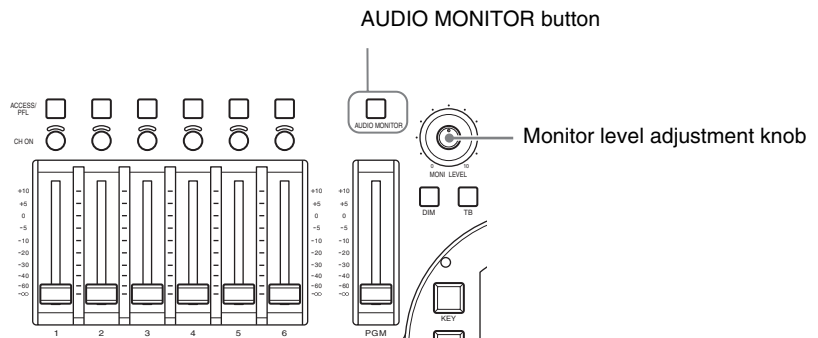

PGM → AUX1 → AUX2 → MIX → PGM ...

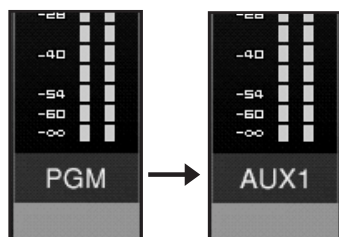

Monitoring the Audio of a Particular Channel Only

Use the Pre-Fader Listening (PFL) function to check the audio on a channel without the channel fader adjustments. You can do this, for example, on the internal speakers.

Hold down the ACCESS button for the channel you want to monitor for at least 0.5 seconds. While the button is held down, the audio for that channel is monitored.

When you release the ACCESS button, the monitoring is ended.

Notes

- If you press another ACCESS button for at least 0.5 second during PFL, the sound of the subsequently specified channel is added.
- This does not affect the program output, AUX output, or MIX output.

Video/Audio Signal Adjustments and Settings

This section describes adjustments to the video and audio signals.

The image quality and sound quality of the inputs to this unit vary depending on factors such as the shooting conditions. This unit therefore has functions to adjust the video and audio of each input to this unit separately.

When using the ACCESS menu to adjust the video input, we recommend outputting the program video to an external monitor and confirming the results as you make adjustments.

Adjusting Analog Video Input Signals

The image quality of an analog video signal input from a composite input or S-video input connector may be adjusted.

- 1 Press the ACCESS button in the same column as the selection button for the video you want to adjust.
- 2 ① In the top menu, select the desired item; ② adjust with the sliders.

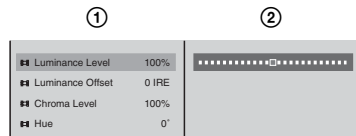

The items you can adjust are as follows.

[Luminance Level]: Adjusts the luminance.

[Luminance Offset]: When inputting video with a 7.5 IRE setting to this unit, select [7.5 IRE].

[Chroma Level]: Adjusts the saturation.

[Hue]: Adjusts the hue.

Note

When applying an offset to the program output video, see “Applying an Offset to the Program Output Video” (page 162).

Caution

- The adjustment values given here are for reference only. Actual values may not match these theoretical values during operation.
- When the input signal is in PAL format, moving the jog roller changes the numeric indications and moves the sliders, but the actual value for [Luminance Offset] is fixed at [0 IRE], and the value for [Hue] is fixed at [0°].
- When the input signal is SDI, [Luminance Offset] and [Hue] cannot be adjusted.

- 3 Press the ESC button to close the ACCESS menu.

Note

You can also close the menu by pressing the same ACCESS button again.

Making the Gradation of SDI Input Signals Appear Smooth (When Using the Serial Digital Interface Module)

Apply dynamic rounding to video signals input from an SDI connector to make the gradation appear smooth.

Dynamic rounding is applied by default. If you do not want to apply dynamic rounding, set this setting to [OFF].

- 1 Press the ACCESS button in the same column as the selection button for the video signal you want to adjust.
- 2 ① In the top menu, select [Dynamic Rounding] and confirm; ② select [OFF] and confirm.

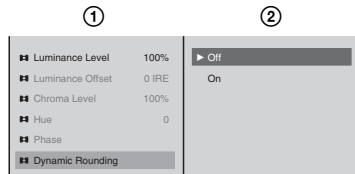

- 3 Press the ESC button to close the ACCESS menu.

Note

If dynamic rounding is not performed, the video gradation will have visible contouring artifacts because this unit drops the lower 2 bits of 10 bit SDI input signals.

Adjusting the Clock Phase of RGB Signals

Of the video signals assigned to the selection buttons, adjust the RGB signals input to the RGB input connectors.

Perform this adjustment to display small characters clearly.

- 1 Press the ACCESS button in the same column as the selection button for the RGB signal you want to adjust.
- 2 ① In the top menu, select [Phase], and confirm; ② adjust with the slider.

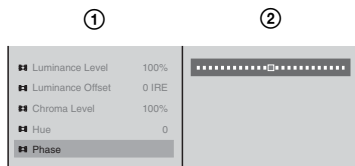

Adjusting Color Matte

Adjust the colors used for color matte, used as single-color backgrounds and so on.

- 1 Press INT in the NEXT selection buttons.
The INT source selection menu appears.

- 2 ① Select the item (displayed under [Color Matte]) to be adjusted, and confirm; ② adjust with the sliders.

As you move the sliders, the sample colors shown in the menu change, so you can check while making the adjustment.

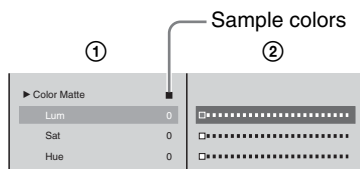

The items you can adjust are as follows.

[Lum]: Adjusts the luminance.

[Sat]: Adjusts the saturation.

[Hue]: Adjusts the hue.

Applying an Offset to the Program Output Video

You can apply a 7.5 IRE offset to the program output video.

- 1 Press the MENU button.
- 2 In the top menu, select [Video Output].
- 3 ① Select [PGM OUT Level], and confirm; ② select [Luminance Offset] from the submenu, and confirm; ③ select [7.5 IRE], and confirm.

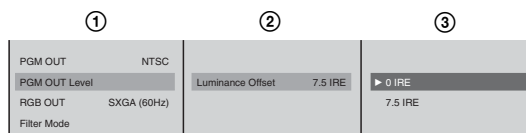

Note

Because there is no offset function for PAL, this setting is only enabled when [PGM OUT] is set to [NTSC].

Setting the RGB Output Signal Format

Set the format of the signal output from the RGB output connectors on the rear panel.

- 1 Press the MENU button.
- 2 In the top menu, select [Video Output].
- 3 ① Select [RGB OUT], and confirm; ② select the combination of image size and frequency or [Video RGB], and confirm.

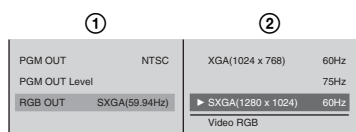

[XGA], [SXGA]: Output format for a computer monitor (computer RGB signals).

[Video RGB]: Output format for a video monitor (video RGB signals).

4 Press the MENU button to close the menu.

Caution

- Changing this setting may cause temporary breakup of the output video.
- If the video output signal format is PAL, then when the [XGA] or [SXGA] setting is used, the edge of the image will be missing in the output from the composite video and S video output connectors. This can be remedied by setting [Video RGB], but in this case the computer monitor output will not be available.

Notes

- We recommend that you set this to 60 Hz when the video output signal is NTSC format, and 75 Hz when the signal is PAL format.
- When [Video RGB] is selected, the number of valid scan lines is automatically set to 480 and the frequency to 60 Hz if the output signal format is NTSC, or to 576 lines and 50 Hz when the format is PAL.
- For details of the output signal format, see under video outputs in the Specification (page 216).
- The video image quality for each signal is as follows. Select the best setting for a particular requirement.

Signal name (connector name)	RGB video including fine text and similar	Video including motion
Computer RGB signal (RGB output connector)	Very clear	Depending on the combination, the motion may be slightly jerky*
Video RGB signal (RGB output connector)	Standard video quality (very slightly blurred)	Smooth
Composite/S-Video signal (composite video output connector/S-video output connector)	Standard video quality (somewhat more blurred than the Video RGB signal)	Smooth

* This occurs if the original frame frequency of the shot video and the RGB output frame frequency or signal processing frequency of a plasma display or projector are not in a whole number ratio.

Applying Filters to the Program Output Video

Adjust this setting when the program output video appears blurry or the picture flickers.

- 1** Press the MENU button.
- 2** In the top menu, select [Video Output].



- 3** ① Select [Filter Mode], and confirm; ② select [SD Video] or [RGB] from the submenu, and confirm; ③ select [Soft] or [Sharp], and confirm.

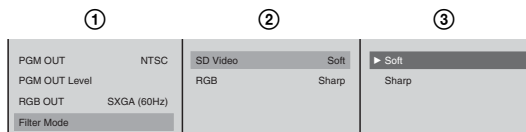

Notes

- Select [Sharp] when the picture is blurry and [Soft] when the picture flickers.
- When [SXGA] is selected for the RGB output signal format setting, since the internal processing size is also SXGA, no filter is required.
- When [Video RGB] is selected for the RGB output signal format setting, the [SD Video] filter settings is applied.

Adjusting the Audio Input Signal Levels

You can adjust individual channels of the audio signals input to this unit.

- 1** Press the ACCESS button for the channel fader to which the audio you want to adjust is assigned.
- 2** ① In the top menu, select [Input Trim]; ② adjust with the sliders.

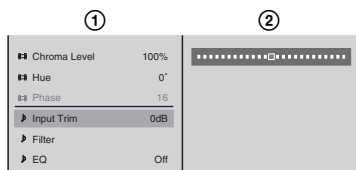

- 3** Press the ESC button to close the ACCESS menu.

Note

You can also close the menu by pressing the same ACCESS button again.

Caution

When a file on an external hard disk is open, the adjustment value of [Input Trim] is used for file playback.

Cutting High Frequency or Low Frequency

This cuts high frequencies or low frequencies. Use these settings to suppress noise.

Notes

- To cut high frequencies select [High Cut], and to cut low frequencies select [Low Cut].
- You can set both [High Cut] and [Low Cut].

- 1 Press the ACCESS button in the same column as the channel fader to which the audio you want to adjust is assigned.
- 2 ① In the top menu, select [Filter]; ② select [High Cut (8kHz)] or [Low Cut (100Hz)].

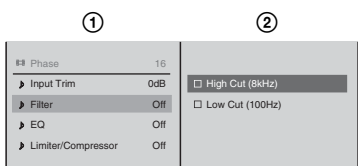

- 3 Press the ESC button to close the ACCESS menu.

Adjusting the Equalizer

You can adjust the audio quality by using the equalizer to set frequencies in the high, middle, and low audio ranges.

- 1 Press the ACCESS button in the same column as the channel fader to which the audio you want to adjust is assigned.
- 2 ① In the top menu, select [EQ]; ② select [On], and confirm.

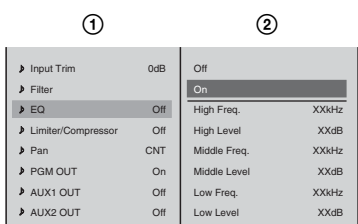

- 3 ① Select an adjustment item from the list, select [On], and confirm; ② adjust with the slider.

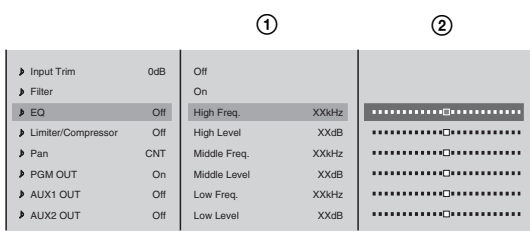

The items you can adjust are as follows.

- [High Freq.]:** Adjusts the center frequency of the high-frequency band.
- [High Level]:** Adjusts the level of the high-frequency band.
- [Middle Freq.]:** Adjusts the center frequency of the middle-frequency band.
- [Middle Level]:** Adjusts the level of the middle-frequency band.
- [Low Freq.]:** Adjusts the center frequency of the low-frequency band.
- [Low Level]:** Adjusts the level of the low-frequency band.

- 4 Press the ESC button to close the ACCESS menu.

Using the Limiter or Compressor

Use the limiter or compressor when inputting audio with large level differences. The limiter restricts the peak components of an audio signal with large level differences. It also compresses the sound exceeding a certain threshold volume so that the threshold level is not exceeded, thus preventing excess outputs. The compressor gently compresses the level of audio at and above the threshold level, thus smoothing out an audio signal with large level differences.

- 1 Press the ACCESS button in the same column as the channel fader to which the audio you want to adjust is assigned.
- 2 ① In the top menu, select [Limiter/Compressor]; ② select [Limiter] or [Compressor], and confirm; ③ with the threshold slider set the level at which the limiter or compressor takes effect.

Note

A gain reduction meter appears to the right of the menu, and shows the current compression.

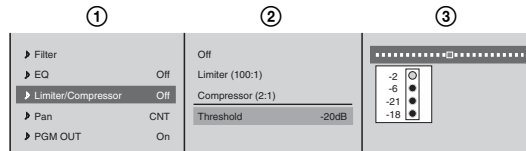

- 3 Press the ESC button to close the ACCESS menu.

Adjusting the Audio Left and Right Channel Balance

- 1 Press the ACCESS button in the same column as the channel fader to which the audio you want to adjust is assigned.
- 2 ① In the top menu, select [Pan]; ② adjust the left and right channel balance with the slider.

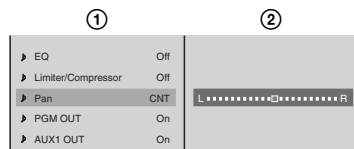

- 3 Press the ESC button to close the ACCESS menu.

Adjusting the Output Levels for Each Destination

Adjust the output audio level for each destination.

- 1 Press the MENU button.
- 2 In the top menu, select [Audio Output].
The [Audio Output] menu appears.

Note

This menu graphically displays the output destination for each channel set in “Determining the Audio Signal Output Destinations” (page 156).

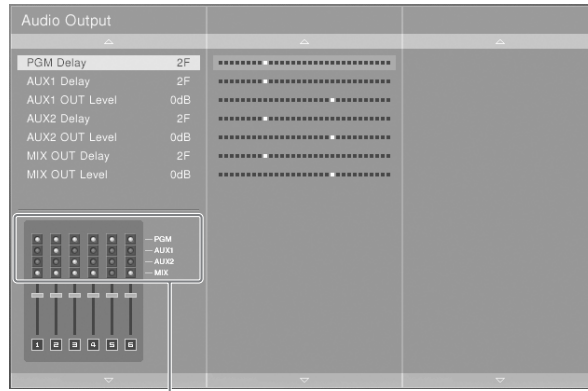

Output destination indication

- 3 ① Select the item you wish to adjust the level, and confirm; ② adjust with the slider.

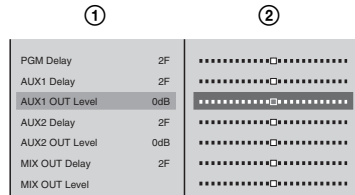

The items for which you can adjust the level are as follows.

[AUX1 OUT Level]: Sets the output level for the audio output from the AUX1 connector.

[AUX2 OUT Level]: Sets the output level for the audio output from the AUX2 connector.

[MIX OUT Level]: Sets the output level for the audio from the MIX output.

Note

Adjust the audio level output from the PGM audio output connectors using the PGM fader on the front panel (page 141).

- 4 Press the MENU button to close the menu.

If the Output Video Is Delayed with Respect to the Audio

If the output video is delayed with respect to the audio, by delaying the audio you can resynchronize it with the video.

- 1 Connect monitor devices to the PGM video output connectors.
- 2 Connect devices to the PGM/AUX/MIX audio output connectors.
- 3 Press the MENU button.

- 4 In the top menu select [Audio Output].
The [Audio Output] menu appears.
- 5
 - ① Select the item connected to the connector in step 2, and confirm;
 - ② while watching the video connected in step 1, adjust it with the slider.

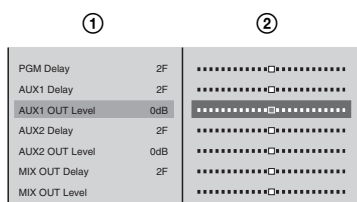

The items for which you can adjust the delay time are as follows.

[PGM Delay]: Sets the delay time for the program output audio in frame units.

[AUX1 Delay]: Sets the delay time for the audio output from the AUX1 connector in frame units.

[AUX2 Delay]: Sets the delay time for the audio output from the AUX2 connector in frame units.

[MIX OUT Delay]: Sets the delay time for the audio from the MIX output in frame units.

Cautions

- Adjusting the delay time may cause noise to occur.
- Video displayed on the PGM viewer lags several frames behind the video output from the PGM video output connectors.

- 6 Press the MENU button, to close the menu.

Adjusting the Output Using the Oscillator Signal

This is for setting the output oscillator signal for use during adjustment.

- 1 Press the MENU button.
- 2 In the top menu, select [Audio Utility].
- 3 Select [OSC], and confirm, and set the oscillator signal output.

Setting the oscillator signal frequency

- ① Select [OSC Freq.], and confirm; ② select the frequency from the submenu, and confirm.

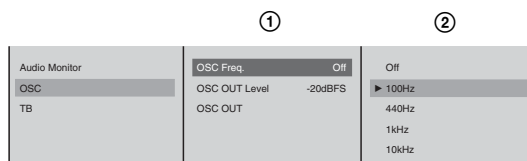



Note

When the output destination is set with [OSC OUT], and a selection other than [Off] is made, the DIM button lights, and the levels of the internal speakers, the headphones, and monitor outputs are automatically reduced.

Setting the oscillator signal output level

① Select [OUT Level], and confirm; ② adjust the output level with the slider.

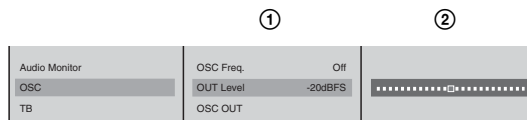

Setting the oscillator signal output destination

① Select [OSC OUT], and confirm; ② select the output destination to output the oscillator signal, and confirm.

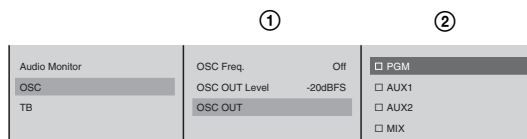

Note

You can select multiple output destination.

4 Press the MENU button to close the menu.

Saving and Loading Various Settings

You can simultaneously save various settings of the unit and information of camera presets, and then load them when necessary. Saving the optimal settings beforehand eliminates the need to reconfigure settings each time you, for example, work on site or use multiple configurations for events.

Storable Data

You can save the following settings and adjustment data.

Storable settings and adjustments		Details of settings
Setup data of the unit	Audio input/output settings and adjustments	[Audio Input Assign] settings [Audio MIC/LINE Level] settings [Audio Output] settings
	Video input/output settings and adjustments	[Video Input Assign] settings [Video Output] settings
	Camera control settings	Settings of the camera guide menu
	File control settings of external hard disks	[Auto Repeat] settings of the HDD file guide menu
	Network settings	[Network] settings
	DV output settings	[DV Output] settings
Camera preset data		Settings of the camera presets registered to the numeric buttons 1 to 6
Various adjustments	Audio adjustments	ACCESS menu settings for the inputs 1 to 6
	Video adjustments	ACCESS menu settings for the inputs 1 to 6
Streaming	Streaming configuration file	[Streaming] settings However, the [Output] setting is not applicable (it is set to [Off] for loading data).
Audio utility		[Audio Utility] settings
Effects	Video effect settings	[Video Effect] settings
	Downstream key settings	[DSK] settings
	Fade to black settings	[Fade To Black] settings
	Streaming file settings	[LOGO] settings
Other	Language settings	[Language] settings
	Display settings	[Display] settings
	Selection status of audio channels	On/Off status of the CH ON button

Saving Various Settings Data

You can simultaneously save the current settings of the unit.

- 1 Press the MENU button.
- 2 Select [Job] in the top menu.
- 3 ① Select [Save] and confirm; ② enter the name of the data in the input box and confirm.



Enter up to 20 alphanumeric characters.

The following confirmation message appears.

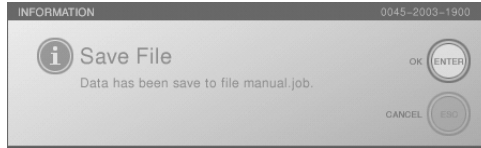

- 4 Press the ENTER button.
The message closes and saving completes.
- 5 Press the MENU button to close the menu.

Loading Various Saved Settings Data

You can load saved job data.

- 1 Press the MENU button.
- 2 Select [Job] in the top menu.
- 3 ① Select [Load] and confirm; ② select the name of the data to load and confirm.



Notes

- The data names are sorted in alphabetical order from top to bottom.
- You can restore the default settings by selecting [Default].

The following confirmation message appears.

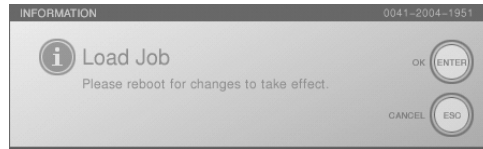

- 4 Press the ENTER button.
The end message appears.
The operating software ends and the power turns off.
- 5 Press the  power button on the side panel.
The unit starts and the settings you loaded are applied.

Deleting Various Saved Settings Data

You can delete the job data you no longer require.

- 1 Press the MENU button.
- 2 Select [Job] in the top menu.
- 3
 - ① Select [Delete] and confirm;
 - ② select the name of the data to delete and confirm.

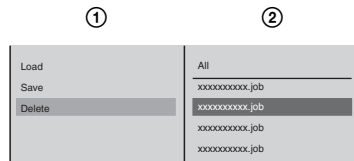

Notes

- The data names are sorted in alphabetical order from top to bottom.
- You can delete all of the job data by selecting [All].

The following confirmation message appears.

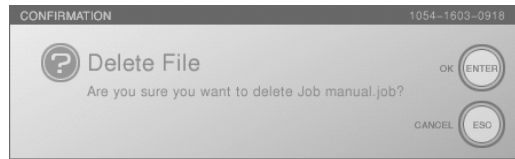

- 4 Press the ENTER button.
The job data is deleted.
- 5 Press the MENU button to close the menu.

Exporting Various Settings Data

You can export the job data saved on the unit to a memory stick or USB flash memory.

- 1 Insert the memory stick or USB flash memory in the memory stick slot or USB connector on the side panel.
The upper USB connector is number 1 and the lower connector is number 2.

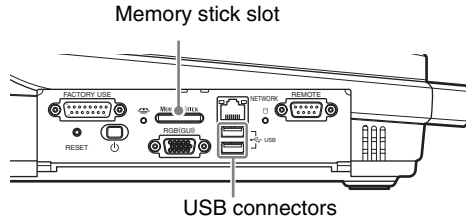

- 2 Press the MENU button.
- 3 Select [File Manager] in the top menu.
- 4 ① Select [Export Job] and confirm; ② select [Memory Stick], [USB Flash Memory 1], or [USB Flash Memory 2] and confirm; ③ select the job data to export and confirm.

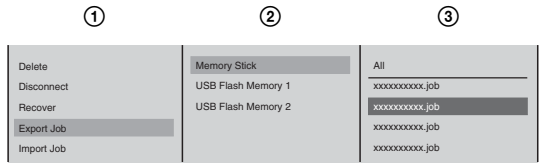

Notes

- The data names are sorted in alphabetical order from top to bottom.
- If you select [All] in ③, all files are exported.

The job data is exported to the memory stick or USB flash memory. When the export is complete, a completion message appears.

- 5 Press the ENTER button.
- 6 Press the MENU button to close the menu.

Importing Various Settings Data

You can import the job data saved on a memory stick or USB flash memory. Insert the memory stick or USB flash memory containing the job data in the memory stick slot or USB connector on the side panel. The upper USB connector is number 1 and the lower connector is number 2.

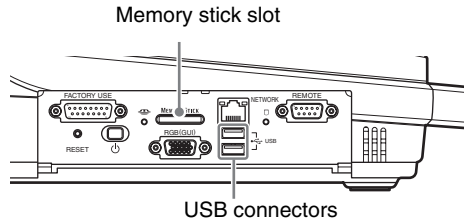

- 1 Press the MENU button.
- 2 Select [File Manager] in the top menu.
- 3 ① Select [Import Job] and confirm; ② select [Memory Stick], [USB Flash Memory 1], or [USB Flash Memory 2] and confirm; ③ select the job data to import and confirm.

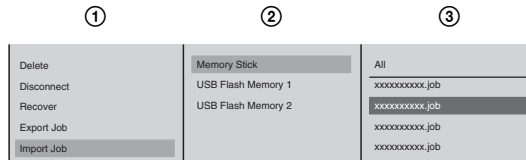

Notes

- The data names are sorted in alphabetical order from top to bottom.
- If you select [All] in ③, all of the job data is imported.

The job data is imported.
When the import is complete, a completion message appears.

- 4 Press the ENTER button.
- 5 Press the MENU button to close the menu.

Importing and Deleting Files

Using the [File Manager] menu, you can carry out the following file operations.

- Importing graphics files and logo files from a “Memory Stick” or USB flash memory
- Deleting graphics files or logo files imported to this unit
- Deleting files recorded on an external hard disk
- Checking the remaining capacity of the internal hard disk
- Formatting a “Memory Stick,” USB flash memory, or external hard disk

Importable Files

You can import graphics files in the sizes listed below. Depending on the size of a graphics file, it may be resized on import.

Import results by file size for CG and LOGO files

Sizes allowed	Import results
720 × 540 (CG)	Resized to 1,280 × 960, and centered vertically
960 × 720 (CG)	Resized to 1,280 × 960, and centered vertically
1,024 × 768 (CG)	Resized to 1,280 × 960, and centered vertically
1,280 × 1,024 (960) (CG)	Not resized (used as is)
160 × 120 (LOGO)	Not resized (used as is)

Importable file types and extensions

File type	File extension
Targa	.tga .vda .icb .vst
Tiff	.tif .tiff
BMP	.bmp
JPEG	.jpeg .jpg .jpe

Caution

If you create a graphics file with Microsoft PowerPoint for use in downstream keying or luminance keying, save it in BMP format.

Importing Graphics Files

By importing a graphics file to the internal hard disk, you can use it for downstream keying or luminance keying.

- 1 Insert the “Memory Stick” or USB flash memory holding the graphics file in the “Memory Stick” slot or USB connector in the side panel.

Cautions

- Use a “Memory Stick” or USB flash memory that has been formatted using this unit.
- The graphics file must have been placed in the designated folder MSSONY/PRO/LPS/ANYCAST/CG for graphics files.

For details of formatting a “Memory Stick,” see the section, “Formatting a “Memory Stick”” (page 181), and for details of formatting a USB flash memory, see the section, “Formatting a USB Flash Memory” (page 183).

- 2 Press the MENU button.
- 3 In the top menu, select [File Manager].
- 4 ① Select [Import CG File] and confirm; ② Select [Memory Stick], [USB Flash Memory 1], or [USB Flash Memory 2] and confirm; ③ Select the graphics file to be imported and confirm.

The upper USB connector is number 1, and the lower connector is number 2.

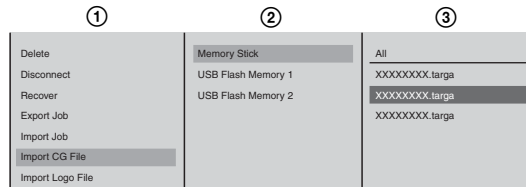

Note

If you select [All] in step ③, all of the files are imported.

Caution

Characters other than alphanumeric characters cannot be displayed correctly.

This imports the graphics file.

When the import is completed, a completion message appears.

- 5 Press the ENTER button.
- 6 Press the MENU button to close the menu.

Note

The imported graphics file can be used in “Using the Downstream Key (DSK) Function to Add Text or an Image” (page 78) or “Using Luminance Keying” (page 84).

Importing Logo Files

By importing a logo file to the internal hard disk, you can display an image (logo) for the purpose of copyright protection.

- 1 Insert the “Memory Stick” or USB flash memory holding the logo file in the “Memory Stick” slot or USB connector in the side panel.

Cautions

- Use a “Memory Stick” or USB flash memory that has been formatted using this unit.
- The logo file must have been placed in the designated folder MSSONY/PRO/LPS/ANYCAST/LOGO for logo files.

For details of formatting a “Memory Stick,” see the section, “Formatting a “Memory Stick”” (page 181), and for details of formatting a USB flash memory, see the section, “Formatting a USB Flash Memory” (page 183).

- 2 Press the MENU button.
- 3 In the top menu, select [File Manager].
- 4 ① Select [Import Logo File] and confirm; ② Select [Memory Stick], [USB Flash Memory 1], or [USB Flash Memory 2] and confirm; ③ Select the logo file to be imported and confirm.

The upper USB connector is number 1, and the lower connector is number 2.

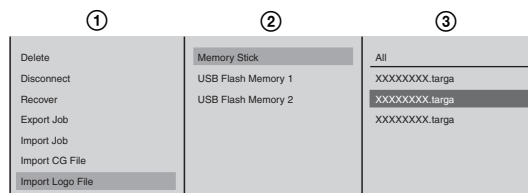

Note

If you select [All] in step ③, all of the files are imported.

Caution

Characters other than alphanumeric characters cannot be displayed correctly.

This imports the logo file.
When the import is completed, a completion message appears.

- 5 Press the ENTER button.
- 6 Press the MENU button to close the menu.

Note

The imported logo file can be used in “Showing a Logo on the Screen” (page 82).

Deleting Files

- 1 Press the MENU button.
- 2 In the top menu, select [File Manager].
- 3 ① Select [Delete], and confirm; ② select [CG File], [Logo File] or the hard disk No., and confirm; ③ select the file to be deleted, and confirm.

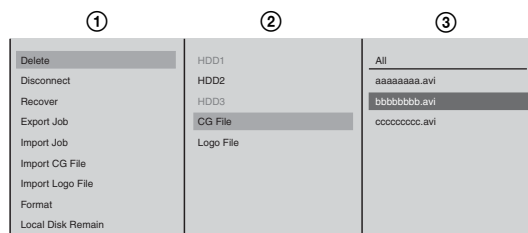

Notes

- It is not possible to delete files on the hard disk that are being used for recording. End the recording before deleting them.
- The file names are arranged in alphabetical order.
- If you select [All] at step ③, all files are deleted.

The following confirmation message appears.

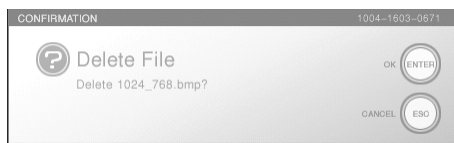

- 4 Press the ENTER button.

The deletion message appears and the file is deleted.

Caution

While files are being deleted, if you close down the system or start the text typing tool, it will be necessary to recover the hard disk.

- 5 Press the MENU button to close the menu.

Checking the Internal Hard Disk Remaining Capacity

- 1 Press the MENU button.
- 2 In the top menu, select [File Manager].
In the [File Manager] menu, the remaining capacity is shown as [Local Disk Remain].



Formatting an External Hard Disk

Format an external hard disk in order to use it with this unit.
This unit uses the ext3 file system format.

Note

We recommend that you reformat the external hard disk at regular intervals in order to avoid a drop in performance due to file fragmentation.

- 1 Connect the external hard disk to the i.LINK connector (6-pin) of the interface module.

Caution

Be sure to connect the hard disk before powering on this unit.

i.LINK connector (6-pin)

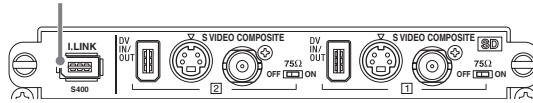

- 2 Power on the hard disk.
- 3 Press the  (power) button on the side panel, to start up this unit.
The operation screen appears.
- 4 Press the MENU button.
- 5 In the top menu, select [File Manager].
- 6
 - ① Select [Format] and confirm; ② Select the hard disk number and confirm.

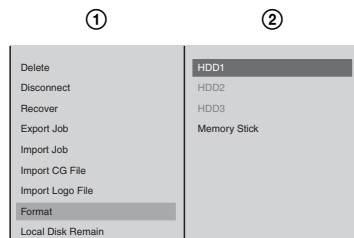

The following message appears.



7 Press the ENTER button.

Formatting starts.

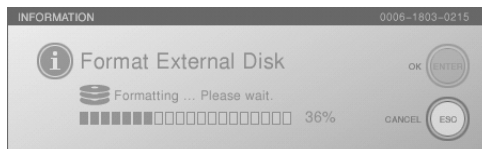

When formatting is completed, the following message appears.

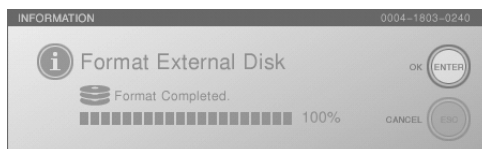

8 Press the ENTER button, to close the message.

9 Press the MENU button, to close the menu.

Formatting a “Memory Stick”

Format a “Memory Stick” so that it can be used with this unit.

In this unit, use the following “Memory Stick” types.

“Memory Stick” type	Use for reading/ writing on this unit
“Memory Stick” “Memory Stick” (with memory select function) “Memory Stick Duo”	Yes
“Memory Stick” (Magicgate/high-speed data transfer support) “Memory Stick Duo” (Magicgate/high-speed data transfer support)	Yes *
Magicgate “Memory Stick” Magicgate “Memory Stick Duo”	Yes *
“Memory Stick PRO”	Yes *, **
“Memory Stick PRO Duo”	Yes *, **

* It is not possible to read or write data that requires the Magicgate function.

** This unit does not support parallel data transfer (high-speed data transfer).

Cautions

Operation with all types of Memory Stick media is not guaranteed.

- 1 Insert the “Memory Stick” in the “Memory Stick” slot on the side panel.
- 2 Press the MENU button.
- 3 In the top menu, select [File Manager].
- 4 ① Select [Format], and confirm; ② [Memory Stick], and confirm.

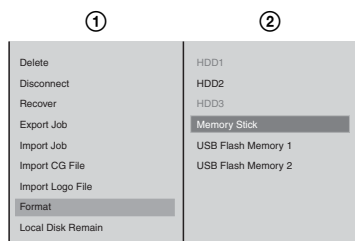

The following message appears.

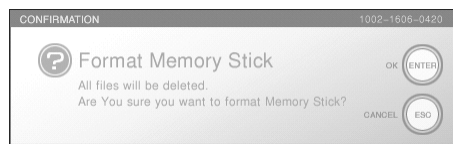

- 5** Press the ENTER button.
The formatting begins.
When the formatting ends, the following message appears.

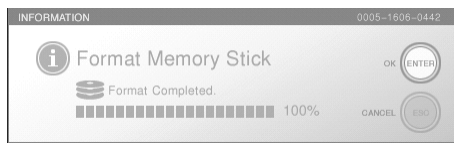

- 6** Press the ENTER button, to close the message.

Note

Formatting a “Memory Stick” on this unit automatically creates the following directory structure on the “Memory Stick”.

MSSONY/PRO/LPS/ANYCAST/INSTALL
/JOB
/LICENCE
/CG
/LOGO
/REAL
/EDL
/FONT

- 7** Press the MENU button to close the menu.

Formatting a USB Flash Memory

Format a USB flash memory in order to use it with this unit.

- 1 Insert the USB flash memory into the USB connector on the side panel.
The upper USB connector is number 1, and the lower connector is number 2.

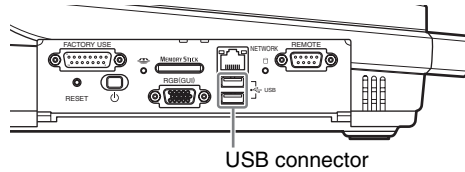

- 2 Press the MENU button.
- 3 In the top menu, select [File Manager].
- 4 ① Select [Format] and confirm; ② Select [USB Flash Memory 1] or [USB Flash Memory 2] and confirm.

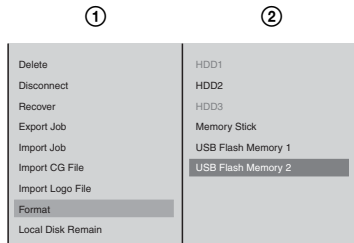

The following confirmation message appears.

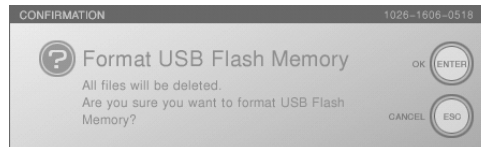

- 5 Press the ENTER button.
Formatting starts.
When formatting is completed, the following message appears.

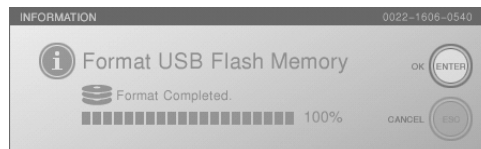

- 6 Press the ENTER button, to close the message.

Note

Formatting USB flash memory on this unit automatically creates the following folder structure in the USB flash memory.

MSSONY/PRO/LPS/ANYCAST/INSTALL
/JOB
/LICENCE
/CG
/LOGO
/REAL
/EDL
/FONT

- 7** Press the MENU button, to close the menu.

Streaming

You can encode the program output into Real Media streaming file format (.rm) within this unit, and broadcast it on the network.

What Is Streaming?

Streaming is one of the transmit multimedia data. Video and audio data is sent across a network, and may be played in real time. To carry out live streaming with this unit, the program video and audio is encoded in the format used by Real Player, and transmitted. Encoding takes place on the unit. There are the following two transmission methods.

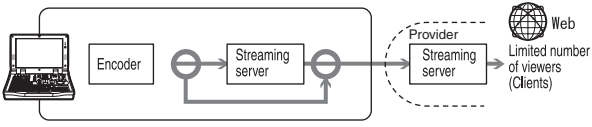
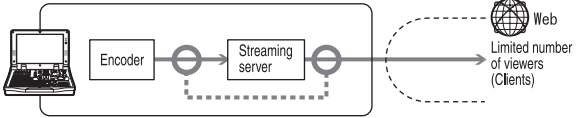
Transmission method	Features
Using the streaming server provided by the provider	<ul style="list-style-type: none"> The results of encoding are sent from the unit to the streaming server provided by the provider, and the viewers access the streaming server to view the live content.  <ul style="list-style-type: none"> To some extent you can select such things as the number of clients that can view the content and delivery transfer rate because it is possible to obtain high network bandwidth, depending on your subscription with the provider. There is a cost for use of a streaming server. Obtain a subscription with a provider that provides a server that supports the RealMedia streaming file format (.rm).
Using this unit as the server	<ul style="list-style-type: none"> The results of encoding are sent to the streaming server in the unit, and the viewers access this unit to view the live contents.  <ul style="list-style-type: none"> Since viewers directly access this unit, the number of viewing clients and the data transfer rates are limited by the network linking this unit to the viewers. There is no cost for a streaming server.

Caution

You cannot encode the program output into a format other than Real Media streaming file format (.rm). If you want to encode into another format, you need to input the program output of this unit into another encoder and encode it.

Configuring the Network Settings

With the network environment set up, make the network settings for this unit. Ask your network administrator for further information about your network.

- 1 Connect a network cable to the NETWORK connector of this unit.

Caution

In order to meet EMC standards, use an STP (shielded twisted pair) type Ethernet cable.

- 2 Press the MENU button.
- 3 In the top menu, select [Network].
- 4 Set the following items in the submenu.

Entering the host name

- ① Select [Host Name], and confirm; ② enter the host name in the input box, and confirm.

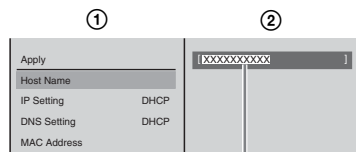

Not more than 15 characters
The first character must be a letter.

Setting the IP address

- ① Select [IP Setting], and confirm; ② make a selection, and confirm.

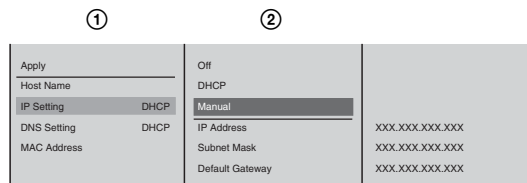

[Off]: if IP address not set

[DHCP]: if address automatically obtained from DHCP server

[Manual]: to input address manually

When [Manual] is selected, enter the following items, and confirm.

Input the default gateway if required.

[IP Address]: Enter the IP address.

[Subnet Mask]: Enter the subnet mask.

[Default Gateway]: Enter the default gateway address.

Caution

Because the unit uses “172.27.72.0 netmask 255.255.255.0” internally, the unit will not operate correctly if settings are configured to include “172.27.72.0 netmask 255.255.255.0”.

Making DNS settings

① Select [DNS Setting], and confirm; ② make a selection, and confirm.

The screenshot shows a menu with two tabs: 'Apply' and 'Off'. Under 'Apply', there are options for Host Name, IP Setting (DHCP), DNS Setting (DHCP), and MAC Address. Under 'Off', there are options for DHCP (Manual), Domain Name, Primary DNS, and Secondary DNS. Step 1 is indicated by a circled '1' above the 'DNS Setting' option. Step 2 is indicated by a circled '2' above the 'Manual' option.

[Off]: if DNS not set

[DHCP]: if address automatically obtained from DHCP server

[Manual]: to input address manually

When [Manual] is selected, enter the following items, and confirm.

[Domain Name]: Enter the domain name. Enter from 3 to 63 alphanumeric characters. The first character must be a letter.

[Primary DNS]: Enter the address of the primary DNS server.

[Secondary DNS]: Enter the address of the secondary DNS server (Enter as required).

5 Select [Apply], and confirm.

A network setting update message appears.

Note

If the network settings are not changed, [Apply] is grayed out, and cannot be selected.

Displaying the MAC address

Select [MAC Address] to display the MAC address of the internal network card.

The screenshot shows a menu with two tabs: 'Apply' and 'Off'. Under 'Apply', there are options for Host Name, IP Setting (DHCP), DNS Setting (DHCP), and MAC Address. Under 'Off', there is a field for the MAC address, which is currently displaying 'XXXXXXXXXXXX'. Step 1 is indicated by a circled '1' above the 'MAC Address' option. Step 2 is indicated by a circled '2' above the MAC address field.

6 Press the MENU button to close the menu.

Setting Live Streaming Transmission

Setting the menu

These settings make it possible for the program output from this unit to be encoded in Real Media streaming file format (.rm), and transmitted by live streaming.

- 1 Press the MENU button.
- 2 In the top menu, select [Streaming].
- 3 Set the following items in the submenu.

Selecting live transmission

- ① Select [Output], and confirm; ② select [Live], and confirm.

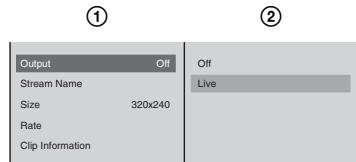

Caution

- When the above operation is done, the PGM viewer on the operation screen becomes smaller.
- Even if left set to [Live], when this unit is powered on again, the setting returns to [Off].



Entering the file name

- ① Select [Stream Name] and confirm; ② select [File Name], and confirm;
- ③ enter the file name in the input box, and confirm.

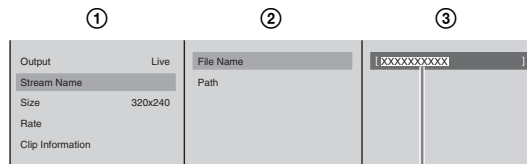

Not more than 20 characters

Setting the Streaming Output Path

If multiple encoders connect to the streaming server, enter the path for identification. Set the path as necessary.

① Select [Stream Name] and confirm; ② select [Path] and confirm; ③ enter the path following the default mount point (/broadcast/) in the input box and confirm.

The screenshot shows a configuration window with three main sections. Section 1 (left) has 'Stream Name' selected. Section 2 (middle) has 'Path' selected. Section 3 (right) shows an input field with 'XXXXXXXXXX' and a vertical line indicating the cursor position.

Enter up to 50 alphanumeric characters.

Example:

If “anycast/test” was entered, access and view material by entering `rtsp://xxx.xxx.xxx.xxx/broadcast/anycast/test/xxx.rm` on a client.

Setting the video size

① Select [Size], and confirm; ② select the size of video to be output, and confirm.

The screenshot shows a configuration window. Section 1 (left) has 'Size' selected. Section 2 (right) shows a list of video sizes: '320 x 240', '240 x 180', and '160 x 120'. '320 x 240' is selected.

Setting the transfer rate

① Select [Rate], and confirm; ② select [Bit Rate], and confirm; ③ select the transfer rate, and confirm.

The screenshot shows a configuration window. Section 1 (left) has 'Rate' selected. Section 2 (middle) has 'Bit Rate' selected. Section 3 (right) shows a list of transfer rates: '768k DSL', '512k DSL', '384k DSL', '256k DSL', '150k LAN', '64k ISDN', and '56k Dial-up'. '384k DSL' is selected.

Notes

- The actual transfer rates are as follows.
 - 768k DSL→700 kbps(Video:603.5 kbps Audio:96.5 kbps)
 - 512k DSL→450 kbps(Video:353.5 kbps Audio:96.5 kbps)
 - 384k DSL→350 kbps(Video:285.9 kbps Audio:64.1 kbps)
 - 256k DSL→225 kbps(Video:180.9 kbps Audio:44.1 kbps)
 - 150k LAN→150 kbps(Video:118.0 kbps Audio:32.0 kbps)
 - 64k ISDN→50 kbps(Video:39.0 kbps Audio:11.0 kbps)
 - 56k Dial-up→34 kbps(Video:26.0 kbps Audio:8.0 kbps)

- The following are recommended for combinations of video size and transfer rate:

320 × 240 → 384k DSL

240 × 180 → 256k DSL

160 × 120 → 150k DSL

Entering content information

- ① Select [Clip Information], and confirm;
- ② select the item to set, and confirm;
- ③ enter the information in the input box, and confirm.



The items you can set are as follows.

[Title]: Enter a title of not more than 50 characters.

[Author]: Enter an author name of not more than 100 characters.

[Copyright]: Enter an owner name of not more than 100 characters.

- 4 Press the MENU button to close the menu.

Configuring the settings for connecting to a server

When using the internal server

Use the internal server of the unit for streaming transmission.

- 1 Press the MENU button.
- 2 Select [Streaming] in the top menu.
- 3 ① Select [Server Setting] and confirm; ② select [Own] and confirm.

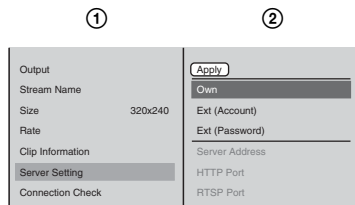

- 4 Select [Apply] and confirm.

When using an external server

Configure the settings to enable a connection to be established to the external server (Helix server of RealNetworks, inc.) to be used for streaming transmission. There are two methods: Account-based login and password-only login.

For the following procedure, select [Ext (Account)] for account-based login or select [Ext (Password)] for password-only login. Then, contact the server administrator for details on the information to set (IP address, port, listen address, port range, protocol, user name, and password).

Note

“Helix Administrator” mentioned in the following procedure refers to the configuration and administration screen for Helix Server.

- 1 Press the MENU button.
- 2 Select [Streaming] in the top menu.
- 3 ① Select [Server Setting] and confirm; ② select [Ext (Account)] or [Ext (Password)] and confirm;
The subsequent setting items differ for [Ext (Account)] and [Ext (Password)].

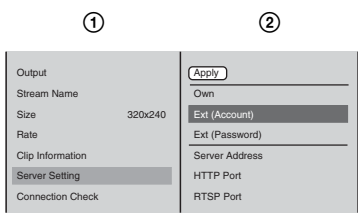

It is now possible to configure [Server Address] and the items below.

- 4 ① Select [Server Address] and confirm; ② enter the IP address of the external server in the input box and confirm.

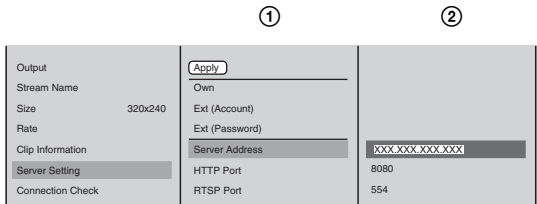

Note

For [Ext (Password)], enter the IP address of the unit (which is seen from the external server when network address translation [NAT] is used) in [Transmitter Address] of [Receiver] in the [Broadcast-Distribution] settings of Helix Administrator.

- 5 ① Select [HTTP Port] and confirm; ② enter the HTTP port set on the external server in the input box and confirm.

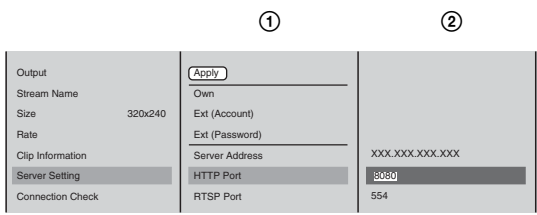

Note

Enter the HTTP port in [Ports] in the [Server Setup] settings of Helix Administrator.

- 6 ① Select [RTSP Port] and confirm; ② enter the RTSP port set on the external server in the input box and confirm.

	①	②
Output	Apply	
Stream Name	Own	
Size	320x240	Ext (Account)
Rate		Ext (Password)
Clip Information	Server Address	XXX.XXX.XXX.XXX
Server Setting	HTTP Port	8080
Connection Check	RTSP Port	554

Note

Enter the RTSP port in [Ports] in the [Server Setup] settings of Helix Administrator.

- 7 For [Ext (Account)], ① select [Listen Address] and confirm; ② enter the IP address of the unit which is seen from the external server when network address translation [NAT] is used and confirm.

Note

There is no need to enter an IP address if network address translation will not be used.

	①	②
Output	Apply	
Stream Name	Own	
Size	320x240	Ext (Account)
Rate		Ext (Password)
Clip Information	Server Address	XXX.XXX.XXX.XXX
Server Setting	HTTP Port	5050
Connection Check	RTSP Port	554
	Listen Address	XXXXXXXXXX.XXX

- 8 For [Ext (Password)], ① select [Port Range] and confirm; ② enter the port range set on the external server in the input box and confirm.

	①	②
Output	Apply	
Stream Name	Own	
Size	320x240	Ext (Account)
Rate		Ext (Password)
Clip Information	Server Address	XXX.XXX.XXX.XXX
Server Setting	HTTP Port	8080
Connection Check	RTSP Port	554
	Listen Address	...
	Port Range	8000 to 30020

Note

- Enter the same port range as that in [Receiver] of the [Broadcast-Distribution] settings of Helix Administrator. Also, make sure the firewall and other settings are configured so that communication between the unit and Helix Administrator is not rejected.
- For [Ext (Account)], there is no need to configure the port range setting on the unit, but match the firewall and other settings to the port range of [RealNetworks Encoding] in the [Broadcasting] settings of the Helix Administrator with which the unit will communicate.

- 9 ① Select [Transport] and confirm; ② select the protocol to use for communication with the external server and confirm.

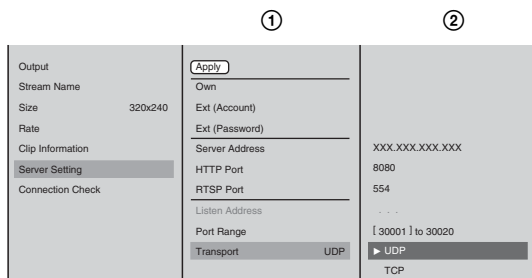

Note

For [Ext (Password)], set the same protocol as that set in [Receiver] in the [Broadcast-Distribution] settings of Helix Administrator. UDP communicates with “udp/unicast.” Also check other settings such as the firewall settings.

- 10 For [Ext (Account)], ① select [Username] and confirm; ② enter the user name to use for connecting to the external server in the input box and confirm.

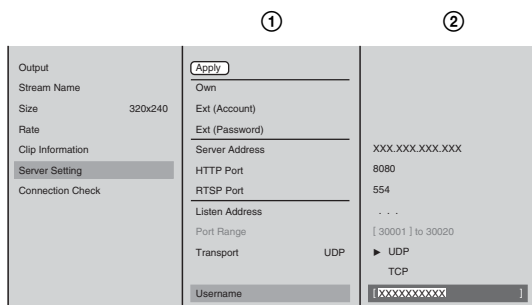

- 11 ① Select [Password] and confirm; ② enter the password to use for connecting to the external server in the input box and confirm.

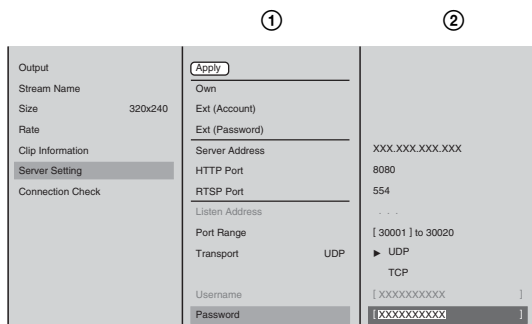

Note

Set the same password as that set in [Receiver] in the [Broadcast-Distribution] settings of Helix Administrator.

- 12 Select [Apply] and confirm if you modified any settings in Steps 3, 4, 5, and 6.
This operation is not required if you only modified settings in Steps 7, 8, 9, 10, and 11.
- 13 Press the MENU button to close the menu.

Checking Connections to Other Devices

You can check whether it is possible to connect to the default gateway set for [IP Setting] of [Network] in the top menu, the external server set for [Server Setting] of [Streaming] in the top menu, or another computer.

- 1 Press the MENU button.
- 2 Select [Streaming] in the top menu.
- 3 Check the connection to each computer in the submenu.

For the default gateway or external server

① Select [Connection Check] and confirm; ② select the device for which to check the connection from the list and confirm.

① ②

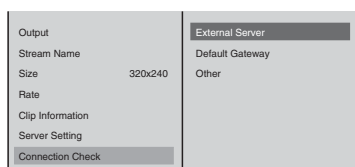

For a device other than the above

① Select [Connection Check] and confirm; ② select [Other] and confirm; ③ enter the IP address of the device for which to check the connection in the input box and confirm.

① ② ③

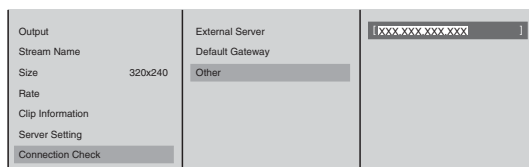

The following message appears and the communication check begins.

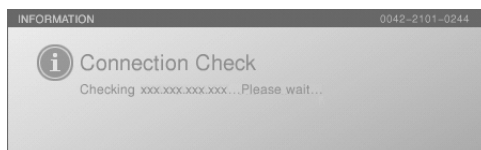

A message notifies you whether the connection succeeded or failed.

- 4 Press the ENTER button.
- 5 Press the MENU button to close the menu.

Starting and Stopping Streaming

Starting streaming

- 1 Make the settings described in “Configuring the Network Settings” (page 186) and “Setting Live Streaming Transmission” (page 188).
- 2 Press the ON LINE button.
The ON LINE button lights red, and a transmission starts.

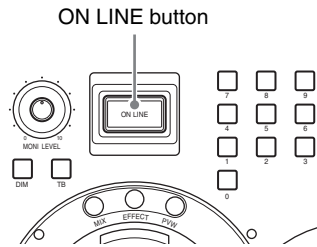

Caution

Be sure to have a client computer available to check that a signal is being transmitted, using Real Player.

Stopping streaming

- Hold down the ESC button, and press the ON LINE button.
The ON LINE button goes off, and transmission ends.
It is not possible to stop while the status is shown as “Starting.” Once it shows “Running” you can stop.

Settings Required for Viewing Streaming

This section describes how to configure settings on the computer for viewing material streamed from this unit. Perform these settings on network-ready computers.

Downloading Real Player

Download Real Player from the Web site of RealNetworks, Inc.

Viewing streamed material from the unit

- 1 Start Real Player.
- 2 Click [Open] on the [File] menu.
- 3 Follow the procedure below to enter an URL.

When using the rtsp protocol for access

rtsp://Server Address[:Port]/broadcast/[Stream Path]/File Name.rm

* If port number 554 is to be used, you can omit [:Port] after the server address.

When using the http protocol for access

http://Server Address[:Port]/ramgen/broadcast/[Stream Path]/File Name.rm

* If port number 80 is to be used, you can omit [:Port] after the server address.

Note

For “Server Address,” “Stream Path,” and “File Name,” enter the character strings set on the unit.

4 Press the Enter key.

Note

Select [Preferences] on the [Tools] menu in Real Player, and configure your connection settings in accordance with your network environment.

Guidelines for number of Real Player connections depending on transfer rate (for Own)

The following table shows the number of Real Player connections possible for each transfer rate.

The figures are guidelines only, and depend on the operating conditions of the network.

Transfer rate	768k/512k	384k/256k	150k/64k/56k
Number of Real Player connections	5	10	20

When video/audio deteriorates or stops during streaming

Streaming video/audio deteriorates or stops primarily due to network traffic, the player software or settings, or insufficient processing power in the computer running the player software.

If such problems occur, check the above.

When the message “Please wait for a while and reconnect” appears (for Own)

If Real Player connects to the unit when the ON LINE button of [Live] of [Output] in the internal server settings (Own) is not pressed, the following “Please wait for a while and reconnect” standby clip is played. The standby clip is not played when the external server (Ext) settings are configured.



Placing Streaming Links in a Web Site

This section describes how to offer streaming material to viewers using a Web page.

Perform these settings on network-ready computers.

- 1** Open a text editor such as Notepad, and enter the URL for the streaming content in Real Media format as shown below.
rtsp://IP address of the unit or the external server (Helix Server)/broadcast (path)/specified filename.rm
Example: rtsp://xxx.xxx.xxx.xxx/broadcast/live.rm

- 2** Save the file with the extension “.ram”.

Note

This file becomes the metafile of the Real Media format.

- 3** Upload to the Web server the metafile saved in step 2.
- 4** Insert a link to the metafile in the Web page on which you want to publish the stream.





Maintenance

This section describes how to check the operating software version, and upgrade.

Checking the Operating Software Version

You can check the version number of the operating software and hardware constituting this unit and the interfaces modules installed in this unit, as well as the unit's serial number.

- 1 Press the MENU button.
- 2 In the top menu, select [Version], and then check the displayed version information.

The items you can check are as follows.

Main Application: you can check the version number of the operating software.

Text Typing Tool: You can check the version number of the text typing tool software.

Effect Board: You can check the firmware and hardware version of the effects board.

Audio Board: You can check the firmware and hardware version of the audio board.

Interface Modules 1 to 3: You can check the firmware and hardware version of the rear panel interface modules.

Panel: You can check the firmware version of the front panel.

Serial No. XXXXX

Caution

The interface module version only appears when the module is installed.

- 3 Press the MENU button to close the menu.

Upgrading the Operating Software

This section describes how to upgrade when there are improvements to the operating software and hardware firmware.

Caution

When the external hard disk is connected to the unit, always disconnect it before upgrading the operating software.

Information on upgrades

Information on software upgrades is available from the Anycast Station portal site operated by Sony.

The following site also provides links to the portal site and information on upgrades.

<https://www.ecspert.sony.biz/ecsite/>

<https://servicesplus.us.sony.biz/SoftwarePlusSearch.aspx> (for the customers in the U.S.A.)

<https://www.sonybiz.net/anycast> (for the customers in Europe)

Download to a “Memory Stick” or USB flash memory.

Upgrade procedure

- 1 Insert a “Memory Stick” or USB flash memory holding the installation program in the “Memory Stick” slot or USB connector on the side panel.

Cautions

Before carrying out the following operation, plug the device into the “Memory Stick” slot or USB connector used for installation only, and remove other devices.

- 2 Press the  (power) button on the side panel.
This powers on the unit.

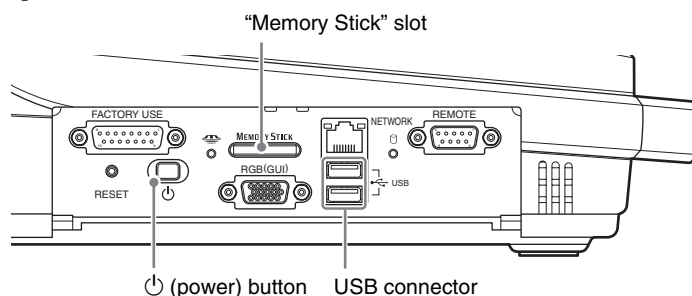

- 3 After the startup screen, press the F10 (Fn+0) key on the keyboard while the message is displayed indicating that function key input is possible.



The following screen appears.

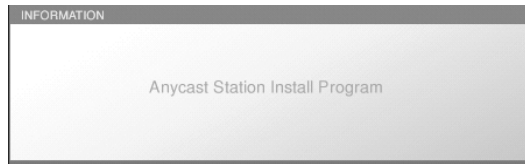

Next the “INSTALL” screen appears, and a message “C: Copying Program files...”

Notes

- If the same version is already installed, this object is grayed out, and excluded from the upgrade.
- The “C:” in “C: Copying Program files...” refers to the “Memory Stick,” and “D:” and “E:” refer respectively to the upper and lower ports to which the USB flash memory is connected.

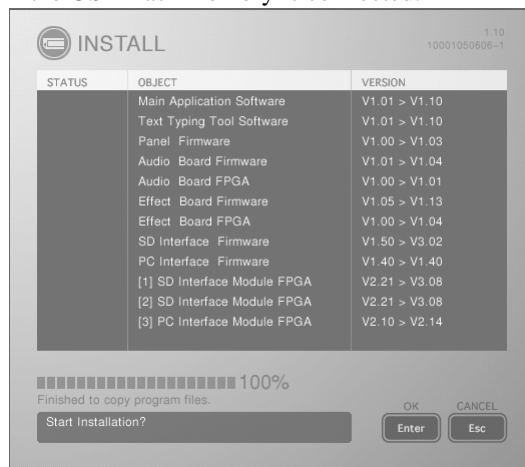

- 4** Check that the progress indication has reached 100%, and press the keyboard ENTER key.

The installation starts.

Installation does not begin if you click the Enter button on the front panel.

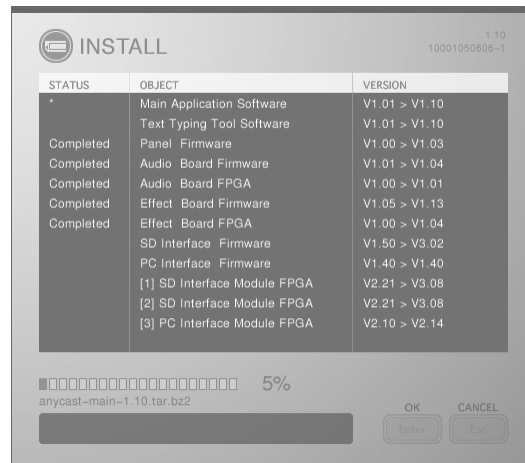

Note

In the “STATUS” column, an asterisk (*) blinks while the operating software is being installed. When installation ends successfully, “Completed” is displayed, and if installation has failed, “Error” is displayed instead.

Caution

Do not turn the unit off or remove a “Memory Stick” or USB flash memory from the unit while data is being read or written; otherwise the file may be destroyed.

When the installation completes, the following message appears.

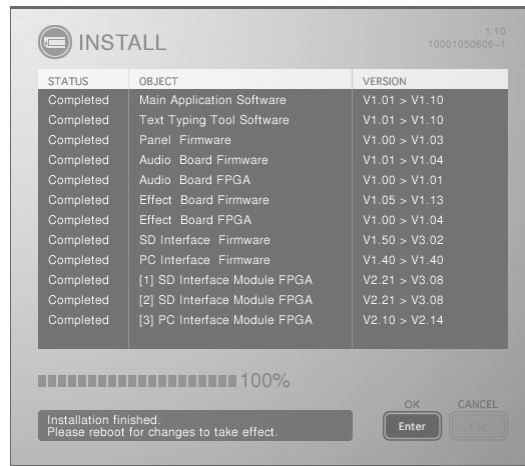

- 5 Check the installation completed message, then press the keyboard ENTER key.

This powers off the unit.

When you next power on the unit, the operating software starts.

Caution

- During the installation, if the “STATUS” indication shows “Error”, repeat the installation process from the beginning. If this does not clear the problem, consult your dealer or your Sony service representative.
- Users who purchased the optional BKAW-550/BKAW-570/BKAW-580 should install the optional equipment and then perform the same version upgrade.

Messages

If any problem occurs during operation of this unit, a message appears. Before asking your dealer for help, use the information in this section to try to solve the problem. If this is not successful, make a note of the displayed message number, and consult your dealer or your Sony service representative.

Message Structure

The messages that appear during operation of this unit consist of the following parts.

Anycast Station main software messages

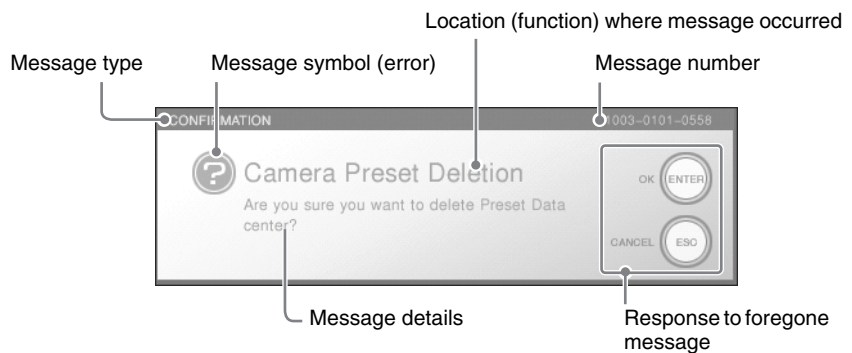

To select [OK], press the ENTER button or Enter key on the keyboard.
To select [Cancel], press the ESC button or Esc key on the keyboard.

Text typing tool software messages

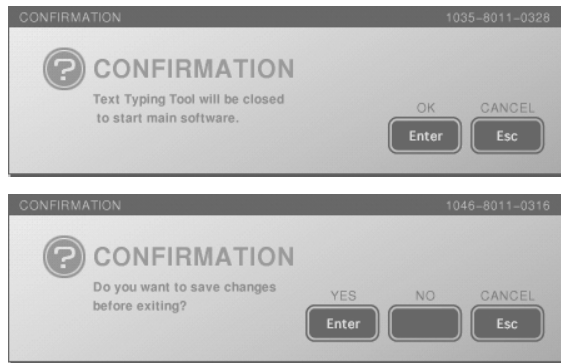

To select [OK] or [YES], click the [Enter], or press the keyboard Enter key.
To select [CANCEL], click the [Esc], or press the keyboard Esc key (Fn+~/ key).
To select [NO], click the [Space].

Message types

The significance of the message type is as follows.

Error message

Message type: ERROR

Message number: 4XXX-YYYY-ZZZZ (begins with 4)

As a result of an operation, an error occurred.

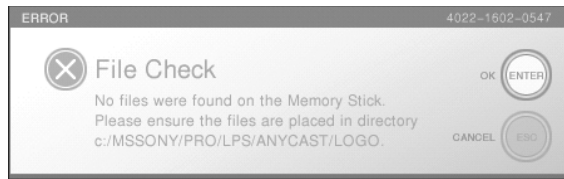

Warning message

message type: WARNING

message number: 2XXX-YYYY-ZZZZ (begins with 2)

This appears when a preliminary check before carrying out an operation discovered a problem.

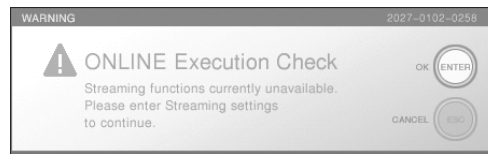

Confirmation message

Message type: CONFIRMATION

Message number: 1XXX-YYYY-ZZZZ (begins with 1)

This type of message requests user confirmation, and can be cancelled.

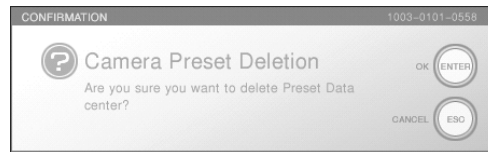

Informational message

Message type: INFORMATION

Message number: 0XXX-YYYY-ZZZZ (begins with 0)

This provides information to the user.



List of Messages

If a message on this list is displayed and still appears after trying the operation again, consult your dealer or your Sony service representative

Number	Message text
0001	Data has been exported to directory XX.
0002	Deleting ... Please wait.
0003	Exporting... Please wait.
0004	Format completed.
0005	
0006	Formatting ... Please wait.
0007	
0008	Import completed.
0009	Importing... Please wait.
0010	Shutting Down. Saving System Settings.
0011	Updating Network Settings.
0012	Installation finished. Please reboot for changes to take effect.
0013	Anycast Station Install Program
0014	Checking Memory Device.
0015	“Memory Stick” device was found.
0016	USB Flash Memory device was found.
0017	Installation canceled. Shutting down.
0018	Shutting Down.
0020	The changes will take effect after the next reboot.
0021	It is now safe to remove HDDX.
0022	Format Completed.
0023	Formatting ... Please wait.
0024	To re-mount the HDD, Please ensure it is properly connected and re-start the unit.
0025	Recovery completed.
0026	Recovering ... Please wait.
0027	Shutting Down. Cannot save the file during editing.
0028	One font file was copied.
0029	xx font files were copied.
0030	Please wait.
0031	Please wait. Importing... xx/xx fonts.
0032	Please wait.
0033	
0034	Please wait. Exporting... xx/xx sheets.
0035	Please wait.
0036	Please wait. Saving... xx/xx sheets.
0038	One or more frames were dropped during recording. Please check that the recording quality is sufficient.
0039	Deleting ... Please wait.
0040	Loading has been canceled.
0041	Please reboot for changes to take effect.
0042	Checking xxx.xxx.xxx.xxx ...Please wait.
0043	No answer from xxx.xxx.xxx.xxx.
0044	xxx.xxx.xxx.xxx is alive.
0045	Data has been save to file xx.
0046	File xx has not been recorded because video input signal was not detected.
1002	All files will be deleted. Are you sure you want to format “Memory Stick”?
1003	Are you sure you want to delete Preset Data xx?
1004	Delete xx?
1005	File xx already exists. Overwrite?

Number	Message text
1006	File xx is currently being used as the LOGO or INT source. Do you really wish to delete this file?
1007	File xx is currently being used as the LOGO or INT source. Do you really wish to overwrite this file?
1009	Start Installation?
1010	Audio Source also will be set to Analog. L:xx R:xx
1011	When selecting DV Audio,DV Video will be selected automatically.
1012	When selecting DV Video,DV Audio will be selected automatically.
1013	Delete xx? All files on HDDX will be closed.
1014	All files will be deleted. Are you sure you want to format disk? Disk Size xxGB, File System ext3
1015	A file on External HDDX is currently being used. Do you really wish to format the HDD?
1016	Start recording source X.xxxx.avi
1017	Slot xx-xx DV interface has already been assigned as an input. Would you like to cancel the assignment and re-assign to the PGM output.
1018	When the audio input assignment is changed, opened files will be closed automatically.
1020	When the PGM Output assignment is changed, any opened files will be closed automatically.
1021	When the video input assignment is changed, opened files will be closed automatically.
1024	Main software will be closed to start Text Typing Tool. Recording and Streaming will be stopped.
1025	A file in External HDDxx is currently being used. Do you really wish to disconnect the HDD?
1026	All files will be deleted. Are you sure you want to format USB Flash Memory?
1027	Are you sure you want to set the Power Off Timer? The system will be shutdown in 2 hours.
1029	Recording of the audio assigned to Source xx is not currently supported.The DV embedded audio will be recorded.
1030	This source has already been assigned to Source No. xx. Would you like to assign it to Source No. xx instead?
1031	Disk recovery may take a considerable time to complete. Do you really wish to run the recovery tool?
1032	Disk recovery may take a considerable time to complete. Do you really wish to run the recovery tool? All files will be closed.
1033	Do you really wish to delete xx?
1034	File Name, Saved Day
1035	Text Typing Tool will be closed to start main software.
1036	<input type="radio"/> Memory Stick <input type="radio"/> USB Flash Memory 1 <input type="radio"/> USB Flash Memory 2
1037	File Name, Saved Day
1038	
1039	<input type="radio"/> all sheets <input type="radio"/> current sheet
1040	<input type="radio"/> Memory Stick <input type="radio"/> USB Flash Memory 1 <input type="radio"/> USB Flash Memory 2
1041	<input type="radio"/> Duplicate current sheet <input type="radio"/> Create a blank sheet
1042	Do you want to save changes before creating a new file?
1043	Do you want to save changes before opening a new file?
1044	A file with this name already exists. Overwrite?
1045	File Name, Saved Day
1046	Do you want to save changes before exiting?
1047	File Name, Saved Day
1051	When selecting SDI Audio, Embedded SDI Video will be selected automatically.
1052	When selecting SDI Video, Embedded SDI Audio will be selected automatically.

Number	Message text
1053	CH1/2 and CH3/4 of the same source may not be assigned simultaneously. X/X is already assigned. Would you like to assign Y/Y instead?
1054	Are you sure you want to delete Job XX?
1055	Job XX already exists. Overwrite?
1057	Do you want to delete xx?
1059	xx were not found. Do you want to select an alternative font?
1060	One or more interface modules require a firmware upgrade. [slot x]
2001	Could not find file xx.
2002	Please insert "Memory Stick" or USB flash memory containing Installation Software and select OK to retry installation.
2006	This USB Flash Memory needs formatting by the Anycast Station.
2007	This Memory Stick needs formatting by the Anycast Station.
2009	This type of compressed image file is not supported.
2010	Starting server. Please restart the streaming after a while.
2011	Insufficient Space on Memory Stick. XX
2013	Internal Disk Full.
2014	Invalid Date and Time. YYYY/MM/DD HH:MM
2015	Less than 500MB of free space remaining on Internal Hard Disk.
2016	"Memory Stick" is Write Protected. Please remove Write Protection and re-insert.
2018	Only images of size 160×120 are supported.
2019	Only the following sizes of CG file are supported : 720×540 960×720 1,024×768 1,280×1,024(960).
2020	Please complete the current transiting before pressing the KEY button.
2021	Please complete the Network Settings before starting streaming.
2022	Please complete the Streaming Settings before starting streaming.
2023	Please complete the Video Output Settings before performing operation.
2024	Please enter Network Settings starting Streaming.
2025	Please insert a USB Flash Memory and select OK to retry.
2026	Source Name contains illegal characters. The characters /,:;*?"<> []= cannot be used.
2027	Streaming functions currently unavailable. Please enter Streaming settings to continue.
2031	To use the DSK, a CG file must be selected as the INT source. Please select a CG file.
2032	Server busy. Please wait and try again.
2033	Please complete the Date/Time Settings before performing operation.
2035	HDDX has been removed. To avoid file corruption before removing the HDD, please execute "Disconnect" from the File Manager menu.
2036	External Disk HDDX is full.
2037	Cannot record to this disk. The disk is not formatted, or has been formatted with an unrecognized file system.
2038	External Disk HDDX is not recognized.
2039	This file has already been opened. It is not possible to open a file twice.
2041	The number of files on HDDX has exceeded the system limit.
2042	Cannot change the audio input assignment while recording to HDD.
2043	Cannot change the video input assignment while recording to HDD.
2044	Cannot change the PGM Output assignment while recording to HDD.
2046	Insufficient Space on USB Flash Memory. XX
2047	This USB Flash Memory needs formatting by the Anycast Station.
2049	Please insert a Memory Stick and select OK to retry.
2051	USB Flash Memory is Write Protected. Please remove Write Protection and re-insert.
2052	Problems have been found on HDDX. To avoid erros during HDD recording and playback, please run the recover tool from the File Manager menu.
2053	More than one device is connected to the HDD port (HDDX). Only one HDD can be connected.
2054	Capture function is not ready. Please start main application first.
2055	Internal Disk Full...
2056	Could not create directry xx.

Number	Message text
2057	USB Flash Memory full.
2058	Memory Stick full.
2059	This USB Flash Memory is write protected. Please remove Write Protection and re-insert.
2060	This Memory Stick is write protected. Please remove Write Protection and re-insert.
2061	Important System Files Missing.
2062	This USB Flash Memory needs formatting by the Anycast Station.
2063	This Memory Stick needs formatting by the Anycast Station.
2065	Please insert a USB Flash Memory and select OK to retry.
2066	Please insert a Memory Stick and select OK to retry.
2067	There was a invalid Font file, "xx.ttf."
2068	No Font files were found on the USB Flash Memory. Please ensure the Font files are placed in directory. xx:/MSSONY/PRO/LPS/ANYCAST/FONT/
2069	No Font files were found on the Memory Stick. Please ensure the Font files are placed in directory. c:/MSSONY/PRO/LPS/ANYCAST/FONT/
2070	File Name contains illegal characters. The characters % / : ; * ? " < > [] = % cannot be used.
2071	There were invalid Font files, "xx.ttf, xx.ttc, ...".
2072	Recording of this type of source to HDD is not possible.
2073	No files were found on the Memory Stick. Please ensure t he files are placed in directory. x:xx
2074	No files were found on the USB Flash Memory. Please ensure t he files are placed in directory.x:xx
2075	Recording of this source to HDD is not possible while DV(SlotX-X) is being used for DV output.
2076	Could not find file xx.
2077	HDDX has been formatted by a later version of Anycast Station, and is incompatible with this version.
2078	More than two strage devices were found. Please ensure only one device is inserted.
2079	Internal Disk Full. Please delete unwanted files.
2080	Please enter the Job file name.
2081	Could not find Job XX
2082	Please enter xx Settings, then select "Apply".
2083	Please enter Default Gateway Settings, then execute "Connection Check".
2084	Please enter Other Settings, then execute "Connection Check".
2085	Please enter Server Address Settings, then execute "Connection Check".
2086	Connection to external server failed. Please check the Anycast Station Setup, and the status of the External Server and Network.
2087	Please enter xx Settings, then select "Live".
4001	An error occurred during formatting.
4002	An error occurred when loading file.
4003	An error occurred when reading file.
4004	An error occurred when writing file.
4005	An error occurred while deleting the file.
4006	An error occurred while exporting.
4007	An error occurred while importing.
4008	An error occurred while opening CG file.
4009	Cannot execute encode process. Please restart the system.
4010	An error occurred while applying Network Settings.

Number	Message text
4012	
4013	
4014	
4016	Unable to start due to Hardware Fault.
4017	
4020	
4021	
4022	No files were found on the Memory Stick. Please ensure the files are placed in directory. c:/MSSONY/PRO/LPS/ANYCAST/CG
4023	
4025	
4026	
4027	
4028	
4029	
4030	
4031	
4032	
4033	
4034	Unable to start due to Hardware Fault.
4035	
4036	
4037	
4038	
4039	
4040	
4041	
4042	
4043	
4047	
4048	
4049	Failed to acquire Network Settings from DHCP server.
4050	An error occurred during installation. Retry installation?
4051	Unable to start due to Hardware Fault. Installation Canceled.
4054	Please enter IP Address Settings, then select "Apply".
4055	Please enter Primary DNS Settings, then select "Apply".
4056	Please enter Subnet Mask Settings, then select "Apply".
4057	The Subnet Mask contains an invalid bit pattern. Please re-enter then select "Apply".
4058	Invalid Default Gateway address. Please re-enter then select "Apply".
4059	When using DHCP to assign DNS Server settings, IP address settings must also be assigned by DHCP. Please re-enter then select "Apply".
4065	Domain Name cannot end with a hyphen or a period. Please re-enter then select "Apply".
4066	Domain Names must be 3 characters or longer. Please re-enter then select "Apply".
4067	Domain Names must start with an alphabetic character. Please re-enter then select "Apply".
4068	Host Names cannot end with a hyphen or a period. Please re-enter then select "Apply".
4069	Unable to start due to Hardware Fault.
4070	External Disk HDDX is full. Recording stopped.
4071	External Disk HDDX is not recognized. Recording stopped.
4074	No files were found on the USB Flash Memory. Please ensure the files are placed in directory. xx:/MSSONY/PRO/LPS/ANYCAST/CG
4075	An error occurred during disconnecting. (HDDX)
4076	An error occurred again. The problem persists. Please contact the service center.
4077	External Disk HDDX is not recognized.
4078	An error occurred during recovering.

Number	Message text
4079	More than one device is connected to the HDD port (HDDX). Only one HDD can be connected. Recording Stopped.
4080	An error occurred while deleting xx.
4081	A fault has developed with the internal fan. To avoid damage please shutdown the system as soon as possible.
4082	An error occurred when opening xx.
4083	An error occurred when reading xx.
4084	An error occurred when writing xx.
4085	Memory allocation error.
4086	An error occurred while opening TTF font file xx .
4087	An error occurred while reading file xx. Read permission denied or file does not exist.
4088	An error occurred while Warninging version compatibility of xx.
4089	Opening file failed.
4090	An error occurred while recovering.
4091	Signal format of input source x has been changed. Recording stopped.
4092	Connection timeout between encoder and server.
4097	An error occurred while saving Job.
4098	The system had failed in last shutdown. Please restart the unit.
4099	Please set Streaming Output to "Off" before performing this operation.

If the following message appears, immediately turn off the power to the unit and consult your dealer or your Sony service representative.

Number	Message text
4045	A fault has developed with the internal fan.
4046	To avoid damage please shutdown the system as soon as possible.

Troubleshooting

Check this section before consulting your dealer or your Sony service representative. If the unit still does not function properly, consult your dealer or your Sony service representative.

Problem	Possible causes	Possible solutions	See page
Video-related			
Video does not appear in the source viewer.	The connected device is not turned on.	Turn the connected device on.	—
	The cables are not connected properly.	Check that the cables are connected properly.	49
	The input signal is not assigned correctly.	Check that the input signal is assigned correctly.	56
Video does not appear in the PGM viewer.	The FTB button is lit.	Turn off the FTB button.	77
The PGM does not switch.	The [KEY ON] indicator on the operation screen is lit red.	While the KEY button on the front panel is lit green, press the CUT button.	84
Audio-related			
No sound is emitted from the speakers or headphones (the audio level meter does not move).	The connected device is not turned on.	Turn the connected device on.	—
	The cables are not connected properly.	Check that the cables are connected properly.	49
	The input signal is not assigned correctly.	Check that the input signal is assigned correctly.	56
	The CH ON button is not lit.	Turn on the CH ON button.	141
	The audio channel fader has been left turned down.	Turn up the audio channel fader.	141
	The PGM fader has been left turned down.	Turn up the PGM fader.	141
	The monitor destination is set to AUX.	Set the monitor destination displayed below the audio level meter to PGM.	158
No sound is emitted from the speakers or headphones (the audio level meter moves).	The monitor output level is turned down.	Turn up the monitor output level with the monitor level adjustment knob.	141
	The TB button or the DIM button is lit.	Turn off the TB button or the DIM button.	155
No sound is emitted from the internal speakers.	A device is connected to the monitor output connector.		
The peak indication does not disappear.	The control of the peak indication is not possible if the input audio is DV or SDI.	Check the input signal.	—
DV input			
Noise occurs in the video or audio. No video or audio is output.	The signal is not being received clearly.	Disconnect and then reconnect the cables. After reconnecting the cables, restart the connected DV device and the unit.	—

Problem	Possible causes	Possible solutions	See page
Picture-in-picture			
The NEXT selection button flashes and the picture-in-picture effect is not applied.	An attempt was made to use the same image for picture-in-picture as the one being used for keying.	Select a different image.	75
	An attempt was made to use the image assigned to INT for picture-in-picture.	Select a different image.	75
	An attempt was made to use the same image for picture-in-picture as the one being used for program output.	Select a different image.	75
Luminance keying and downstream keying			
Keying does not work.	Keying is hidden because of the Crop setting.	Change the Crop setting.	87
	Keying is hidden because of the Clip, Gain, or Density settings.	Change the values set for Clip, Gain, or Density.	81, 86
Keying adjustments do not take effect.	A keying source created with PowerPoint was saved in Tiff format.	Save keying sources created with PowerPoint in BMP format.	175
Luminance keying does not disappear when the KEY button is pressed.	The KEY button is not an On/Off button for luminance keying.	Make the KEY button light green, and perform a transition, such as with the CUT button.	84
Keying does not disappear when the DSK button is pressed.	Luminance keying is being performed.	Make the KEY button light green, and perform a transition, such as with the CUT button.	84
Keying does not disappear when a transition is performed with the KEY button lit.	Downstream keying is being performed.	Turn off the DSK button.	80
Logos			
Keying does not work.	Keying is hidden because of the Clip, Gain, or Density settings.	Change the values set for Clip, Gain, or Density.	83
Camera controls			
The camera cannot be controlled.	The VISCA cables are not connected properly.	Check that the VISCA cables are connected properly (to the VISCA connector on the unit and the VISCA IN connector on the camera).	49
	The camera has not been registered for control.	Register the camera for control.	132
	The NEXT selection button assigned to the video feed from the camera you want to control is not selected.	Select the NEXT selection button assigned to the video feed from the camera you want to control.	134
	The camera status is No Response.	Reset the camera.	138
The camera preset disappears.	The backup switch on the camera (EVI-D100/EVI-D100P) is not set to ON.	Set the backup switch on the camera (EVI-D100/EVI-D100P) to ON before saving the preset.	134

Problem	Possible causes	Possible solutions	See page
Streaming media			
The video message “Please wait for a while and reconnect” appears in Real Player.	The ON LINE button has not been pressed.	Press the ON LINE button.	195
	The file name is wrong.	Check that the file name set on this unit and the file name set in Real Player are the same.	188, 195, 197
The ON LINE button does not turn off.	Only the ON LINE button is pressed.	Hold down the ESC button and press the ON LINE button.	195
The message “Streaming functions currently unavailable. Please enter Streaming settings to continue.” appears, the ON LINE button does not be pressed.	The streaming server is not started.	Set for [Live] in [Output] on the top menu under [Streaming].	188
The message “Starting Server. Please restart the streaming after a while.” appears, the ON LINE button does not be pressed.	It is a waiting time of the processing that the streaming “status” changes “Initializing” for “Ready”. A waiting time depends on the parameters.	Wait several times, or once set for [Off] in [Output] on the top menu under [Streaming], and then set for [Live] again.	188
“The live contents can not be view using Real Player.”	The necessary settings for viewing the live contents are not set.	Set the necessary settings for viewing the live contents.	195
	Real Player is stopped.	Start Real Player playback.	–
	The streaming server does not transmit the live contents on the network.	Once set for [Off] in [Output] on the top menu under [Streaming], and then set for [Live] again.	188
[Reconnecting] keeps appearing for the status.	A connection cannot be established because of the settings of the unit, network environment, status of the external server, etc.	Check the settings of the unit, network environment, and status of the external server.	–
USB device connection			
Cannot enter characters from a USB keyboard, even after disconnecting and reconnecting it.	The USB keyboard was not recognized because it was connected when the computer was busy performing processing for the software.	Try connecting to the other USB connector, or once set for [Off] in [Output] on the top menu under [Streaming]. Or, connect the USB keyboard beforehand when turning on the power.	23, 188
Text typing tool			
Even with [Paint] selected and a transparency set in the [BG] tab, the background is not transparent.	[BG] is selected in the view operation section.	Select [Checker] or [Live] in the view operation section.	116, 126
Even with [Transparent Black] or [Transparent White] selected in the [BG] tab, the background is not black or white.	[Checker] or [Live] is selected in the view operation section.	Select [BG] in the view operation section.	116, 126
External hard disk			
The hard disk number does not appear in the source viewer.	The source viewer is set to “No Assign.”	Set the input with [Video Input Assign] on the top menu.	57
	The source viewer shows “No Interface Module.”	Connect the interface module correctly.	55
	The hard disk is not recognized.	Disconnect the cable, then reconnect, and restart this unit.	144, 151

Problem	Possible causes	Possible solutions	See page
External hard disk (continued)			
Attempts at recovery yield repeated messages, "An error occurred while recovering."	The hard disk data is unrecoverable.	Use [File Manager] on the top menu → [Format]. * This erases the data.	179
Keyboard			
The keyboard does not work.	The keyboard is out of range of the infrared sensor.	Use the keyboard within range of the infrared sensor.	44
	The keyboard batteries are depleted (when the keyboard is detached for use).	Replace the batteries.	43



“Memory Stick” Media

Notes on using “Memory Stick” media

- When you set the “Memory Stick” erasure prevention switch to “LOCK”, data cannot be recorded, edited, or deleted.

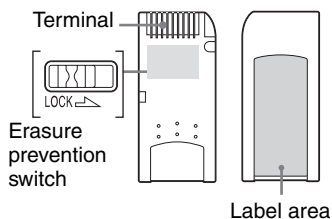

The position and shape of the write-protect switch may differ between the various types of “Memory Stick”.

- Do not remove the “Memory Stick” while it is reading or writing data.
- Data may be damaged if:
 - The “Memory Stick” is removed or the AWS-G500 is turned off while reading or writing.
 - You use the “Memory Stick” in a location subject to the effects of static electricity or electric noise.
- We recommend that you back up important data recorded on the “Memory Stick”.
- Do not affix anything other than the supplied label to the “Memory Stick” label area.
- Affix the label so that it does not stick out beyond the label area.
- When storing or carrying a “Memory Stick”, keep it in its original case.
- Do not touch the terminal of the “Memory Stick” with anything, including your fingers or metallic objects.
- Do not strike, bend, or drop the “Memory Stick”.
- Do not disassemble or modify the “Memory Stick”.
- Do not allow the “Memory Stick” to get wet.
- Do not use or store the “Memory Stick” in locations subject to:
 - Extreme heat, such as in a closed car parked in the sun.
 - Direct sunlight.
 - Humidity or corrosive substances.

About data

- When you set the “Memory Stick” erasure prevention switch to “LOCK”, data such as images and mails cannot be recorded, edited, or deleted. Be sure to unlock the switch before transferring or copying data on the AWS-G500 to the “Memory Stick”, or erasing data on the “Memory Stick”.
- We recommend that you make a backup copy of important data on another “Memory Stick” or on a hard disk using a computer.

Notes on using “Memory Stick Duo”

- Use a pointed object, such as a ballpoint pen, to move the “Memory Stick Duo” write-protect switch.
- Do not write forcefully on the “Memory Stick Duo” memo area.

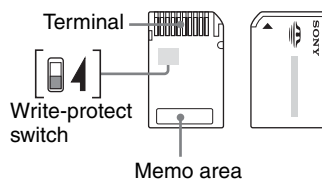

Notes on using the Memory Select function

- You cannot use multiple memory blocks simultaneously or continuously.
- Never operate the Memory Select switch when the “Memory Stick” is inserted in the slot of the AWS-G500, as it may cause damage. Sony Corporation assumes no liability for failure resulting from such operation.
- Make sure that the Memory Select switch is properly positioned to the side. When the switch is not positioned properly, the AWS-G500 may be damaged or malfunction.
- Before inserting the “Memory Stick” in the slot of the AWS-G500, make sure that the memory you want to use is already selected.
- A “Memory Stick” with the Memory Select function allows the user to select the internal memory of the “Memory Stick” with the selector switch. Care must be taken in the following cases as the supported devices only detect the selected memory:
 - Formatting is only processed for the selected memory.

- The remaining memory is only indicated for the selected memory.
- Errors are only displayed for the selected memory and are detected separately from the unselected memory.

Specifications

General

Power Requirements
AC 100 V to 240 V, 50/60 Hz

Power Consumption
1.6 A-0.8 A

Operating Temperature
5°C to 40°C (41 to 104°F)

Dimensions (w × h × d)
424 × 114 × 339 mm

Mass
Approximately 17 lb 10 oz
(8.0 kg)

Video Signals

VIDEO INPUTS (standard configuration)

Composite BNC type × 4
Video: 1.0 Vp-p, 75 Ω
Sync negative

S-video DIN type × 4
Y: 1.0 Vp-p, 75 Ω
Sync negative
C: 0.286 Vp-p at burst, 75 Ω
(NTSC)
C: 0.3 Vp-p at burst, 75 Ω
(PAL)

DV IN* i.Link IEEE 1394 6-pin Type × 4
IEC 61883-2 equiv.

RGB D-Sub Shrink 15-pin
Type × 2 (Female)
XGA (1,024 × 768, 60 Hz,
75 Hz),
SXGA (1,280 × 1,024, 75 HZ
60 Hz)
VESA (DMT) compliant

Format		fH	fV	Dot clock	Sync polarity		Standard
		(kHz)	(Hz)	(MHz)	Horizontal	Vertical	
1,024×768	XGA VESA 60 Hz	48.363	60.004	65	Negative	Negative	VESA (DMT)
	XGA VESA 75 Hz	60.023	75.029	78.75	Positive	Positive	VESA (DMT)
1,280×1,024	SXGA* VESA 60 Hz	63.981	60.02	108	Positive	Positive	VESA (DMT)
	SXGA* VESA 75 Hz	79.976	75.025	135	Positive	Positive	VESA (DMT)

VIDEO OUTPUTS

Composite BNC type × 1
Video: 1.0 Vp-p, 75 Ω
Sync negative

S-video DIN type × 1

Y: 1.0 Vp-p, 75 Ω
 Sync negative
 C: 0.286 Vp-p at burst, 75 Ω
 (NTSC)
 C: 0.3 Vp-p at burst, 75 Ω,
 (PAL)

DV OUT* i.Link IEEE 1394 6-pin Type ×
 4
 IEC 61883-2 equiv.

RGB (VIDEO OUT) 15 k RGB (50 Hz/59.94 Hz)
 R: 0.7 Vp-p (750)
 G: 0.7 Vp-p (750)
 B: 0.7 Vp-p (750)
 SYNC: Composite sync TTL
 output - audio output

RGB D-Sub Shrink 15-pin
 Type × 2 (Female)
 XGA (1,024 × 768 60 Hz,
 75Hz)
 SXGA (1,280 × 1,024 60Hz)

Menu setting		Signal format	FH (kHz)	FV (Hz)	Sync
RGB OUT *	PGM OUT **				
XGA 60 Hz	-	XGA VESA (DMT) 60 Hz	48.363	60.004	H-negative V-negative
XGA 75 Hz	-	XGA VESA (DMT) 75 Hz	60.023	75.029	H-positive V-positive
SXGA 60 Hz	-	SXGA VESA (DMT) 60 Hz	67.500	75.000	H-positive V-positive
Video RGB	NTSC	15k RGB 60 Hz	15.734	59.940	Composite sync
	PAL	15k RGB 50 Hz	15.625	50.000	Composite sync

* For details of RGB OUT settings, see “Setting the RGB Output Signal Format” (page 162).

** For details of RGB OUT settings, see “Selecting the Video Output Signal Format” (page 48).

REF OUT BNC Type × 2
 Sync: 0.286 Vp-p, 75 Ω
 (NTSC)
 Sync: 0.3 Vp-p, 75 Ω
 (PAL)
 C: 0.286 Vp-p at burst, 75 Ω
 (NTSC)
 C: 0.3 Vp-p at burst, 75 Ω,
 (PAL)

Recorder Port

HDD (in exfactory configuration)
 i.LINK: IEEE 1394 6-pin
 Type × 2
 HDD IF: SBP2

Audio Signals

AUDIO INPUTS

Analog Inputs 1-2

XLR/TRS Combo Type × 2
 Ref. Level:
 +4 dBu, -20 dBu, -44 dBu
 Mic. Power:
 +48 V

Analog Inputs 3-6

TRS Type × 4 / Ref. Level:
 +4 dBu, -20 dBu, -44 dBu

Analog Inputs 7-8

Pin × 2 / Ref. Level: -10 dBu

DV IN* i.LINK: IEEE 1394 (6 pins) × 4
 IEC 61883-2 compliant

Audio standard level: -20 dBFS

Sampling rate:

12 bit 32 kHz 4ch (uses only
 ch 1 and 2)

16 bit 48 kHz 2ch

AUDIO OUTPUTS

PGM OUT TRS Type × 2 / Ref.: +4 dBu /
 Impedance: 150 Ω

MIX OUT Pin Type × 2 / Ref.: -10 dBu /
 Impedance: 470 Ω

AUX OUT TRS Type × 2 / Ref.: +4 dBu /
 Impedance: 150 Ω

MONITOR OUT

TRS Type × 2 / Ref.: +4 dBu /
 Impedance: 150 Ω

DV OUT* i.LINK: IEEE 1394 (6 pins) × 4
 IEC 61883-2 compliant

Audio standard level: -20 dBFS

Sampling rate: 12 bit 32 kHz

4ch, 16 bit 48 kHz 2ch

HEADPHONES

1/4" Stereo Phone Jack Type ×
 1

70 mW × 2 / Impedance: 47 Ω

INTERCOM

D-Sub 9-pin Type (Female) /
 Original Parallel I/O

* DV IN/OUT connectors

Other Interfaces

NETWORK RJ-45 Type × 1, 10 Base-T/
 100 Base-TX

USB USB A type × 2, USB equiv.

RGB(GUI) D-Sub Shrink 15-pin × 1
 (Female),

WXGA 1,280 × 800 60 Hz

REMOTE

(Provided for future functional expansion.)

D-Sub 9-pin (Male) × 1,
RS-232C

FACTORY USE
(Provided for future functional expansion.)
D-Sub 15-pin × 1 (Male),
Original Parallel I/O

MEMORY STICK
“Memory Stick” Slot
“Memory Stick Pro” and
“Memory Stick Pro Duo” are
not supported.

VISCA DIN 8-pin type × 1, RS-232C
Sony VISCA camera
commands are supported.

LCD 15.4” High Brightness LCD,
WXGA (1,280 × 800 60 Hz)

Speaker Built-In Speaker × 2,
Size: 20 × 40 mm

SUPPLIED ACCESSORIES

CD-ROM (× 1)
Notes on using the CD-ROM (× 1)
Pin to BNC connector (× 4)
Battery: CR2032
Operating instruction (× 1)
Keyboard (× 1) 85 keys + Pointer /
Infrared communication
Powered from
AWS-G500: +5 V
Battery operation: CR2032 or
2032 H × 2

OPTIONAL ACCESSORIES

BKAW-550 PC Video Interface Module
(mounted in slot 3 of this unit)

RGB D-Sub Shrink 15-pin
Type × 2 (Female),
XGA (60 Hz, 75 Hz),
SXGA (60 Hz, 75 Hz)

BKAW-570 SD Video Interface Module
(mounted in slots 1 and 2 of this unit)

Composite BNC type × 2
Video: 1.0 Vp-p, 75 Ω,
Sync negative

S-video DIN type × 2
Y: 1.0 Vp-p, 75 Ω,
Sync negative
C: 0.286 Vp-p at burst, 75 Ω,
(NTSC)
C: 0.3 Vp-p at burst, 75 Ω,
(PAL)

DV IN/OUT i.LINK: IEEE 1394 6-pin Type
× 2
IEC 61883-2 equiv.

HDD i.LINK: IEEE 1394 6-pin
Type × 1
HDD IF: SBP2

BKAW-580 serial digital interface module

SDI IN BNC × 2
VIDEO: 800 m Vp-p (75 Ω)
SMPTE259M-C ITU-R656
compliant
AUDIO:
Audio sampling rate:
20 bit 48 kHz 2 channels
(channels 1 and 2 or 3 and 4)
SMPTE272M-A compliant

SDI OUT* BNC × 1
VIDEO: 800m Vp-p (75 Ω)
SMPTE259M-C ITU-R656
compliant
AUDIO:
Audio sampling rate:
20 bit 48 kHz 2 channels
(channels 1 and 2)
SMPTE272M-A compliant

HDD HDD i.LINK: IEEE 1394 S400
(6 pins) × 1
HDD IF: SBP2

* The output may be limited when this module is
used in combination with other interface
modules provided in the future.

Caution

Due to the internal video processing of
AWSG500, the output SDI signal is not
guaranteed to be identical to the input SDI signal.

Recommended power cord

NA Part No. 1-551-812-11
Europe Part No. 1-782-929-22

Design and specifications are subject to change
without notice.

Dimensions

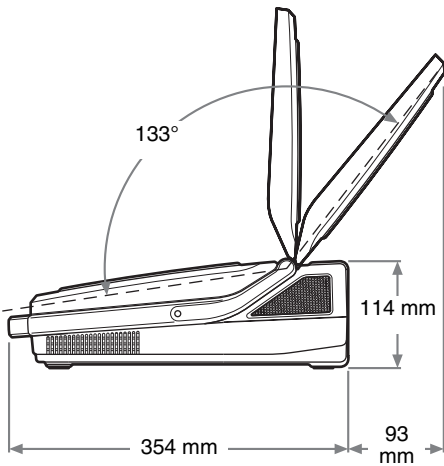
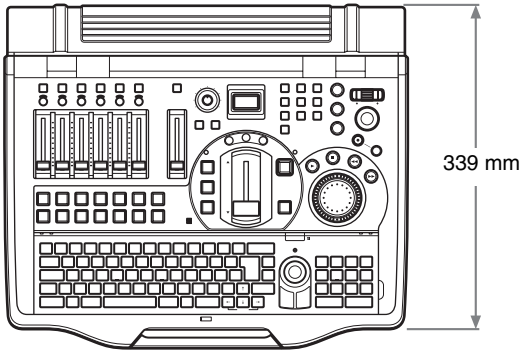
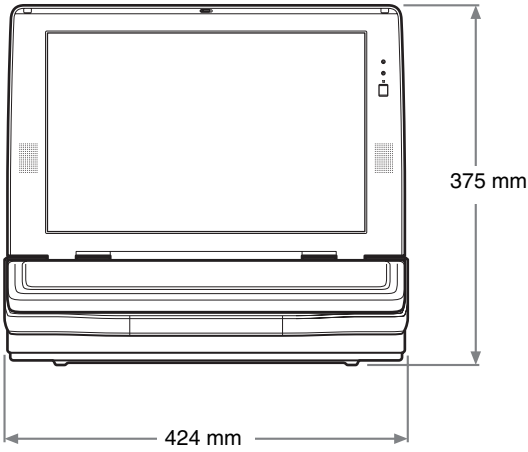

Glossary

Black burst signal

A reference signal used to achieve external synchronization (GenLock).

Color bars

A test signal which displays vertical colored stripes on a monitor. Used to adjust the hue and saturation of colors on video cameras and monitors.

Color matte

A color signal generated by this unit. The hue, saturation, and luminance of color mattes can be adjusted.

Compressor

A function which smoothly limits audio signals exceeding a certain threshold. Used to even out audio signals which contain large differences in amplitude.

Default gateway

A router or computer on a network which serves as an entrance to an outside network. Other computers in the network access the outside network via the default gateway.

Delay

A function which delays audio to bring it into synchronization with video, used when video is input later than the corresponding audio.

DHCP (Dynamic Host Configuration Protocol)

A protocol for automatically assigning IP addresses to clients when they connect to a network, and recovering the addresses when they disconnect.

Dimmer

A function which slightly dims a picture or slightly lowers audio levels.

DNS (Domain Name System)

A system which allows Internet domain names to be translated into IP addresses.

Domain name

An identifier assigned to a group of computers and networks on the Internet. Domain names are delimited by periods (.), and arranged from the left in the order top level domain, second level domain, third level domain, and so forth.

Downstream key (DSK)

A function which allows pictures to be composed by taking video to which an effect has already been applied and adding further images and text. It is called downstream key because this processing is done at the very end of the processing stream.

Embedded audio

Audio that is embedded into a video signal.

EMC (Electro-Magnetic Compatibility)

The properties of an electrical device of electromagnetic non-interference and electromagnetic immunity. Electromagnetic non-interference means that when the device operates it does not impair the operation of other devices, and does not act as a source of interference over a certain level that would be harmful to human health. Electromagnetic immunity is the property of electromagnetic susceptibility such that the device can operate without interference from electromagnetic radiation and so forth emitted by other devices.

Encode

To use compression technology to create streaming files with appropriate bitrates for different bandwidths.

Equalizer (EQ)

A function which controls specific audio frequencies in the high, mid, and low regions. Used to strengthen or delete specific frequencies in order to improve the audio.

ext3

A file system widely used with Linux, which adds a journaling function (allowing data changes to be handled as transactions) to the ext2 file system. It requires a shorter time to recover from hardware problems.

Fade to black (FTB)

An effect in which video fades out to a black screen.

Filter

A function which removes high or low frequencies. Used to remove cable noise and other kinds of noise.

Flip

Screen explanatory diagrams, including text, illustrations, graphics, and maps. A flip is displayed in the video and is used to explain the video content.

IEEE1394 (Institute of Electrical and Electronics Engineers 1394)

A standard for a high-speed serial bus for connection not only of computer peripherals, but also of digital devices to each other. Known as FireWire by Apple Computer, and as i.LINK by Sony Corporation.

FTB (Fade to Black)

See Fade to black

GUI (Graphical User Interface)

A user interface which, unlike traditional text-based interfaces, is designed around graphical elements such as buttons and menus.

Intercom

A network that allows staff members to talk to each other during program production.

Host name

A name assigned to a computer on a network to make it easier to identify. Usually consisting of alphanumeric characters, although conventions differ according to the system. The most commonly used types are the terminal identifiers to the left of Internet domain names.

i.LINK

The high-speed serial bus standard IEEE 1394.

Also called FireWire. Allows connections between computers and peripherals, and also direct connections between digital devices such as digital cameras.

IPv6

The next-generation Internet Protocol, the successor to the current IPv4 protocol.

IRE (International Radio Engineers)

A measure of the brightness level of video on the grayscale, ranging from 0 to 100. The brightness level of black is sometimes set at 0 IRE and sometimes set at 7.5 IRE.

Limiter

A function which prevents audio levels from exceeding a specified threshold. Used to suppress peaks in audio with large differences in amplitude.

Logo

A permanently visible mark shown in video for the purpose of copyright protection.

Luminance key

A method of composing a picture by deleting video which contains components of a specified luminance (brightness). Typically used to extract bright characters from a dark background, so that only the characters can be added to the composed picture.

Mix

A type of transition effect. A new picture is mixed into an old picture, eventually replacing the old picture.

Monitor

To listen to audio and view video. Or a device for viewing and listening.

Motion JPEG2000

An extension to the JPEG2000 image compression format that enables video recording. It provides picture quality comparable to the DV format, with file sizes that are smaller than DV. It is noted for high compression ratios in scenes with rapid movement, which are problematic for the MPEG format.

Oscillator

A transmitter that oscillates at a fixed frequency, such as a sine wave. This unit is equipped with an internal audio oscillator.

Pan

In audio, to adjust the right/left balance.

In video, to move the camera to the left and right.

PFL (Pre-Fader Listen)

Monitoring audio before level adjustments with the audio channel faders. Used to check the input audio. On this system, pan and level control are not applied to PFL audio, even if trim, filter, EQ, pan, and level control settings have been made.

Picture-in-Picture (PinP)

An effect achieved by embedding a video within another video.

Post-Fader

Audio signals after the application of all adjustments except pan.

Pre-Fader

Audio signals before the application of any adjustments with audio channel faders. All other adjustments are the same as those for Post-fader. Pre-fader audio can be output from the AUX output connector.

Preset

A function which allows a set of electrical settings to be saved and reproduced as a single set of data. This system has a camera preset function.

Program (PGM) signal output

The final video and audio signals output from this system, after the application of effects. The video seen by viewers.

RCA pin

A connector used on consumer audio equipment. Connectors come in color-coded pairs (often white for left and red for right). Also used for video signals (color yellow).

RGB

An output signal format which displays pictures by using the three primary colors: Red, Green, and Blue.

Serial digital interface (SDI)

A standard for transmitting uncompressed digital video signals and embedded audio over a single coaxial cable.

STP (Shielded Twisted Pair cable)

A type of cable for communications. Copper wires are twisted in pairs, and then shielded.

Streaming

Real-time playback of audio and data received over a network. Compared to “download” playback, which starts after all the data has been received, streaming allows playback of data received up to now. Formats which enable streaming include RealMedia, Windows Media, and Quick Time. This system supports the RealMedia streaming file format (.rm).

Subnet mask

An IP address, which indicates the address of a device in a network, has two components: a network address (the address of the network) and a host address (the address of an individual computer). A subnet mask is a value used to specify how many bits in the IP address are reserved for the network address. A subnet is a smaller network created by dividing a large network into two or more parts.

Superimpose

A type of special effect in video editing, used to display text and pictures over other pictures.

Talk back (TB)

To pass along instructions, for example from a director. In this system, when you talk into the microphone on the front panel, your voice is output to the connected intercom system, allowing you to converse with other people on the intercom system.

TB (Talk Back)

See Talk back.

Telop (Television Opaque Projector)

Superimposed text and image resources, such as television subtitles. This also refers to text and images that have been combined with video.

Threshold

The level at which a limiter or compressor is activated.

Thumbnail

An image which has been reduced in size for the purpose of displaying a list of many images.

Tilt

To move a camera up and down.

Transition

To switch from one video to a different video over a certain time interval. Transitions can be used together with text and image keys to compose and erase pictures.

Transition effect

Gradually switching from one video to another through the application of one of various effects. This systems supports two type of transition effects: mix and wipe.

Trim

To adjust the input level of audio signals. These adjustments are performed at the input stage, before level adjustments with the audio channel faders.

TRS

A jack used in headphones and other devices.

VISCA

A protocol developed by Sony which allows video equipment to be connected to computers.

Wipe

A type of transition effect. A new picture moves in to replace an old picture, as if wiping the old picture away.

XLR

A 3-pin connector, often called a Cannon connector. A locking mechanism keeps the connector securely connected even when the cable is pulled. Very stable despite its simple structure, and often used on microphones to suppress handling noise.

Index

Symbols

- +48V switch 20
- “Memory Stick” slot 23

Numerics

- 75-W termination switch 21

A

- ACCESS buttons 15
- ACCESS menu 30
 - AUX1 OUT 156
 - AUX2 OUT 156
 - Chroma Level 160
 - EQ 165
 - Filter 165
 - Hue 160
 - Input Trim 164
 - Limiter/Compressor ... 166
 - Luminance Level 160
 - Luminance Offset 160
 - MIX OUT 157
 - Pan 166
 - PGM OUT 156
 - Phase 161
- Adjusting Analog Video Input Signals 160
- Adjusting Color Matte 161
- Adjusting the Audio Left and Right Channel Balance .. 166
- Adjusting the equalizer 165
- Adjusting the Output Levels for Each Destination 166
- Adjusting the Program Output Video Image Quality 162
- Analog video input connectors 21
- Audio channel faders 16
- Audio level meter 25
- AUDIO MONITOR button . 16
- Audio Signal Related Settings 59
- AUTO TRANS button . 18, 68
- AUX output connector (AUX) 1/2 (TRS, balanced) 20

C

- Cable clip 19
- Camera Preset 134
 - camera supporting VISCA protocol 132
- CH ON buttons 16
- channel faders 59
- Closing down 44
- Color Bars 78
- Color Mattes 78
- Compressor 166
- Connecting a Camera With VISCA Support 50
- Connecting a Computer 51
- Connecting a Microphone .. 50
- Connecting a Plasma Display/ Projector 53
- Connecting a VCR 52
- Connecting an amplifier 54
- Connections 49
- Controlling Cameras 132
- Cropping 87
- Cut 66
- CUT button 17, 67
- Cut switching 65
- Cutting High Frequency or Low Frequency 164

D

- Deleting Files 177
- Determining the Audio Signal Output Destinations 156
- DIM button 16
- Dimensions 219
- DSK button 17
- DV connectors (DV IN/OUT) 21, 142

E

- Edge 87
- EFFECT button 17, 71, 85
- Effect display 29
- Effect preview 88

- ENTER button 15
- ESC button 15
- Example Applications 13
- External Hard Disk 52, 142

F

- FACTORY USE connector 23
- fade in 77
- fades out 77
- Fade-to-Black 77
- Front Panel 15
- FTB 77
- FTB button 17

G

- Ground terminal 19

H

- Headphone connector (HEADPHONES) (standard phone jack) 20

I

- i.LINK connector (HDD) 21, 142
- Importing Graphics Files .. 175
- Importing Logo Files 176
- Indicators 18
- Input/Output Signals 56
- Installing the Unit 41
- Intercom 154
- Intercom interface connector 19

J

- Jog dial 19
- Jog roller 16

K



- KEY button 17
- Keyboard 42

L		P		T
Limiter	166	PC video interface module ..	22	TB button
Line input connectors (LINE)		PGM audio output connectors		Time
7/8 (RCA)	20	(PGM) L/R (TRS,		Top menu
Luminance Keying	84	balanced)	20	Audio Input Assign
M		PGM fader	16	Audio MIC/
“Memory Stick”	215	PGM selection button	66	LINE Level
“Memory Stick Duo”	215	PGM selection buttons	17	Audio Output
MENU button	16	PGM video output connectors	157, 166, 168
Menu operations	31	(PGM)	21	Audio Utility
Microphone	16	PGM viewer	26	Date/Time
Microphone/line input connec-		Picture-in-Picture	75	Display
tors (MIC/LINE) 1/2	20	Positioner	18	DSK
Microphone/line input connec-		power button	23	DV Output
tors (MIC/LINE) 3/4/5/6 ..	20	Power supply connector		Fade To Black
MIX button	17, 69	(~AC IN)	19	File Manager151, 176,
MIX output connector (MIX)		PVW button	17 177, 178, 179,
L/R (RCA)	20	PVW viewer ...26, 67, 88, 90	 181, 183
Mixing	141	R		Job
Monitor level adjustment		Real Player	195	Language
knob	16	Recording	142	LCD Backlight
Monitor output connectors		Reference output connectors		Logo
(MONI) (RCA)	20	(REF OUT)	21	Network
N		RESET button	23	Streaming
Names and Functions of		RGB input connectors		Version
Parts	15	(RGB)	22	Video Effect
NETWORK connector	23	RGB Output	162	Video Input Assign
Network Settings	186	RGB output connectors		Video Output
NEXT selection buttons	17	(RGB)	21	Transition
Numeric buttons	18	S		transition effect
O		SD video interface module ..	21	Transition lever
ON LINE button	15	Serial digital interface		transition time
Operating monitor connector		module	22	U
(RGB (GUI))	23	Setting the Date and Time ..	46	Upgrading the Operating
OPTIONAL		Setting the microphone/		Software
ACCESSORIES	218	line level	61	USB connector (USB)
Oscillator Signal	168	Settings	170	V
Output from the AUX output		SHIFT button	18	Video Signal Related
connectors	156	Showing a Logo on the		Settings
Output from the MIX output		Screen	82	Video Switching
connectors	157	Shuttle dial	18	
Output from the PGM output		Software Version	199	
connectors	156	Source viewer	28	
output program	65	Specifications	216	
		Starting	44	

Viewing Streamed
Material 195
VISCA connector 19



Trademarks

- Anycast Station and **ANYCAST STATION** are registered trademarks of Sony Corporation.
- “Memory Stick”,  , “MagicGate Memory Stick” and **MAGICGATE** are registered trademarks of Sony Corporation.
- “Memory Stick Duo” and **MEMORY STICK DUO** are trademarks of Sony Corporation.
- “MagicGate Memory Stick Duo” is a trademark of Sony Corporation.
- “Memory Stick PRO” and **MEMORY STICK PRO** are trademarks of Sony Corporation.
- “Memory Stick PRO Duo” and **MEMORY STICK PRO DUO** are trademarks of Sony Corporation.
- i.LINK and the iLINK logo “  ” are trademarks of Sony Corporation.
- All other company names and product names mentioned here may be the trademarks or registered trademarks of their respective companies.
- The symbols for TM and ® are omitted in these instructions.

