

**SONY**<sup>®</sup>

Digital HD Video Camera Recorder

# HVR-A1U



**HDV**<sup>™</sup>

# Expanding New HD Shooting Opportunities with an Unprecedented Level of Compactness and Mobility – the HVR-A1U HDV 1080i Camcorder

In response to the ever-increasing demands for HD program production, Sony launched the new high-definition recording system adopting the HDV 1080i specification of the HDV™ format – the HVR-Z1U camcorder and HVR-M10U VTR – in 2004. Upon that introduction, these products have rapidly acquired a huge reputation from a wide range of customers due to their outstanding picture quality, stunning performance, and cost-effectiveness. Sony has now expanded the HDV line-up by introducing the HVR-A1U camcorder to meet further evolving needs for HD acquisition.

The HVR-A1U is an extremely compact and lightweight handy-type camcorder, ideal for applications where space is at a premium or extreme mobility is required. This camcorder is equipped with a newly developed 1/3-inch type, 2.97-megapixel (total) CMOS sensor and an all-new Enhanced Imaging Processor™ that optimizes the performance of the CMOS sensor, providing outstanding high-definition picture quality.

In addition to HDV 1080i recording and playback, this camcorder offers the DVCAM™/DV recording and playback capabilities that are provided on current Sony DVCAM models.

A down-conversion capability of its 1080i recordings is also provided for a flexible choice of production systems in HDV, DVCAM, or DV format.

Furthermore, the HVR-A1U incorporates a variety of convenient and professional features such as XLR audio input, time code capability, various automatic shooting modes, and still picture recording.

Available at an extremely affordable price, the HVR-A1U will be another powerful option for HD field acquisition by all video professionals, bringing further broadened shooting opportunities.

## HDV 1080i Specification<sup>1</sup>

The HDV 1080i specification of the HDV format features 1,080 effective scanning lines (interlace scanning system) and 1,440 horizontal pixels. It adopts the MPEG-2 compression format (MP@H-14 for video), which uses 8-bit digital component recording with a sampling rate of 4:2:0. MPEG-1 Audio Layer II is used as the audio compression format, allowing for two-channel recording with a sampling frequency of 48 kHz/16-bit. The HDV 1080i specification provides high picture quality that can be used for HDTV program production.

<sup>1</sup> The HDV format also defines the HDV 720p specification, which features 720 effective scanning lines (progressive scanning system) and 1,280 horizontal pixels.

### Track Pattern of the HDV 1080i Specification

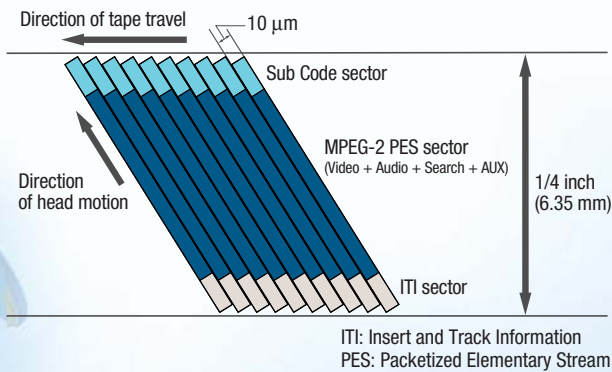

## Compatible with Existing and New DV Videocassette Tape

As a member of the proven DV family of formats, the HDV format has, from the outset, been developed for compatibility with all grades of DV videocassette tape. This allows operators to use high-grade DV videocassette tapes for applications where high robustness is critical, or consumer-grade videocassette tapes for more economical operations. For heavy-duty applications, a new high-grade mini cassette tape has been developed; the DigitalMaster™ PHDVM-63DM. This tape is compatible with the HDV, DVCAM, and DV formats.

## Long Recording Time

The HDV format adopts the same track pitch and tape speed as the DV format, thus offering the same recording time – a maximum of 63 minutes when recording on a DigitalMaster mini cassette tape.



## 1/3-inch Type, 2.97-megapixel CMOS Sensor

The HVR-A1U incorporates one 1/3-inch type primary color CMOS (Complementary Metal Oxide Semiconductor) sensor with a total pixel number of 2.97 million and a 4:3 aspect ratio, which has been developed based on Sony's many years of experience in developing imaging devices.

This CMOS sensor can produce high-quality images with high sensitivity and low noise levels, which is superior to most of traditional CMOS sensors due to advantages such as its unique pixel design, which optimizes the photo-sensor area in each pixel, and advanced noise reduction technique. Another key advantage of this CMOS sensor is its high-speed processing capability. Since data captured using a single CMOS sensor for high-definition format recording is extremely large, it would take considerable time to transfer and process by traditional methods. With the Sony CMOS sensor, such large data can be processed at an incredibly high speed thanks to its flexible multi-channel readout structure. Use of the CMOS sensor also allows even large amounts of HD-resolution data to be processed with amazingly low power requirements, thus making the camcorder's overall size extremely compact. Lastly, CMOS sensors can eliminate vertical smear, even though the pixel size is small.

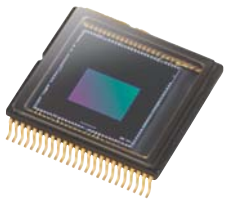

**CMOS**

## Enhanced Imaging Processor (EIP)

The EIP is Sony's newly developed image processing IC intended for high-speed processing of large amounts of data captured by the CMOS sensor. In addition, the EIP employs the unique algorithm that first separates image data into texture patterns and brightness components and then processes these two elements independently. This makes it possible to have high details in the blacks as well as in brightly illuminated areas of the picture, delivering a clear image with a wide dynamic range even under backlight conditions<sup>2</sup>.

Combined use of the EIP and CMOS sensor allows the camcorder to provide extremely high image quality with a high level of gradation and detailed image reproduction.

<sup>2</sup> Available when the new Backlight Compensation function is activated.



**Enhanced  
Imaging  
Processor**

## Optical 10x Carl Zeiss Vario-Sonnar T\* Zoom Lens

The HVR-A1U is equipped with the new Carl Zeiss Vario-Sonnar T<sup>®</sup>\* high-definition lens with 10x zoom function. Its fully coated glass is the same as used on Carl Zeiss prime lenses, producing sharp, high-contrast images, with virtually no chromatic aberration.

## Electronic Super SteadyShot System

The Super SteadyShot™ system used in the HVR-A1U detects horizontal and vertical movements and electronically compensates for unsteady camera handling. The active image area (the number of pixels used) in the CMOS sensor is automatically adjusted for the Super SteadyShot system to achieve the best performance at each zoom position.

## Full Scan Mode

The HVR-A1U camcorder offers a Full Scan mode, which allows the camcorder to capture images with the resolution of approximately two million pixels at every zoom position when the Super SteadyShot system is off. With this mode, images of higher picture quality can be obtained.

# RECORDER FEATURES

## Switchable Recording and Playback – HDV 1080i/DVCAM/DV<sup>3</sup>

The HVR-A1U can switch between HDV 1080i, DVCAM, and DV recording, providing full flexibility to record in either standard or high-definition format depending on production needs.

<sup>3</sup> The HVR-A1U supports DV SP mode only; no support for DV LP mode.

## Down-conversion Playback Capabilities

The HVR-A1U can convert material from 1080i down to 480i, and output these video signals through its i.LINK<sup>®4</sup> interface. In addition, these signals can also be output via either analog component, composite, or S-Video connectors. This allows editing of recorded material with a nonlinear editing system using current DV editing software as well as recording SD signals to an external VTR, while simultaneously recording HDV signals with the HVR-A1U. The HVR-A1U can also down-convert to 480P and output these signals through its analog component video connectors.

When down-converting these signals, the aspect ratio displayed can be converted from 16:9 to 4:3. Display modes can be selected from Squeeze, Letterbox, or Edge crop.

<sup>4</sup> i.LINK is a trademark of Sony used only to designate that a product contains an IEEE 1394 connector. Not all products with an i.LINK connector will necessarily communicate with each other. For information on compatibility, operating conditions, and proper connection, please refer to the documentation supplied with any device with an i.LINK connector. For information on devices that include an i.LINK connection, please contact your nearest Sony office.

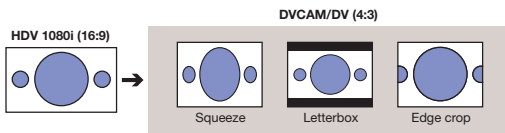

## Recording, Playback, and Down-conversion Formats

Recording Format	Playback/Down Conversion Format	i.LINK	Output		
			Analog Component	Analog Composite	S-Video
1080/60i	1080/60i	○	○	—	—
	480/60i (16:9/4:3)	—	○	—	—
	480/60i (16:9/4:3)	○	Δ1	—	Δ2
480/60i (16:9)	480/60i (16:9/4:3)	○	Δ1	—	Δ2
480/60i (4:3)	480/60i (4:3)	○	Δ1	—	Δ2

○: Available  
 Δ: Either Δ1 or Δ2 connection is available. When both are connected to cables, the Δ1 connection has a priority.

## HD Codec Engine

The HVR-A1U employs the highly advanced HD Codec Engine™ feature, which efficiently compresses base band HD signal data at approx. 25 Mb/s with MPEG-2 compression, while maintaining optimal HD quality. Designed for reduced energy consumption, this powerful digital signal processor fits perfectly inside the compact and streamlined body of the HVR-A1U.



## Still Picture Recording to Memory Stick Duo Media

The HVR-A1U incorporates a high-resolution digital camera function. Thanks to the 2.97-megapixel CMOS sensor, still pictures with 1,920 x 1,440 pixels can be recorded to Memory Stick Duo™ media. Still pictures can be captured by pressing the dedicated 'Photo' button, and this can be done even when recording video to tape, without any interruptions. In addition, any desired video frame recorded on tape can be captured as a still image with 1,440 x 810 pixels<sup>5</sup> and recorded onto Memory Stick Duo media after video shooting.

<sup>5</sup> When captured from a tape recorded in the HDV format.

## Resolution of Still Pictures

Resolution of Still Pictures	Still Picture Mode	Video Recording Mode	Video Playback Mode
1920 x 1440 (4:3)	○	—	—
1440 x 1080 (4:3)	○	—	—
1080 x 810 (4:3)	—	○	—
640 x 480 (4:3)	○	—	○
1920 x 1080 (16:9)	○	—	—
1440 x 810 (16:9)	—	○	○
640 x 360 (16:9)	—	—	○

## 16:9 Widescreen Acquisition in DVCAM and DV Formats

The HVR-A1U is capable of native 16:9 widescreen image capturing, with a high resolution of 720 x 480 pixels in DVCAM and DV formats, and providing true 16:9 images in Standard Definition.

## i.LINK Interface

The HVR-A1U is equipped with a 4-pin i.LINK interface. This allows for on-cable digital transfer<sup>6</sup> of audio, video, and command signals to a connected, compatible VTR or nonlinear editing system in the HDV, DVCAM, and DV formats.

<sup>6</sup> Insert and assemble editing using HDV material is not recommended with the HVR-A1U.

## 2-channel XLR Audio Input

The HVR-A1U provides two XLR audio input connectors for connecting professional microphones or for feeding an external-line audio source. Phantom power of approx. 48 V can be supplied for the external condenser microphone. INPUT 1 audio can be recorded on CH1 only, or on both CH1 and CH2 audio tracks, with easy selection via a switch. The HVR-A1U also comes equipped with two types of microphones; an external directional microphone and a built-in stereo microphone.

## 2-channel Independent Audio Record Level Control with Audio Level Meter

Each input level for CH1 and CH2 can be independently adjusted and viewed with an audio level meter and viewed with an audio level meter on the LCD monitor.



# OPERATIONAL & CREATIVE VERSATILITY

## Compact and Lightweight Design

The HVR-A1U features an extremely compact and lightweight body, providing an unprecedented level of mobility in HD field acquisition. The camcorder itself weighs only 1 lb 7 oz (670 g) and just 2 lb 14 oz (1.3 kg) including the lens hood, XLR audio adaptor, directional microphone, NP-QM91D InfoLITHIUM™ Rechargeable Battery Pack, and PHDVM-63DM DigitalMaster Mini Cassette Tape.

## 16:9, Color/Black-and-white Switchable LCD Viewfinder

The 0.44-inch type color LCD viewfinder displays high-resolution color pictures of approx. 252,000 pixels in a widescreen aspect ratio of 16:9. Operators can select to display pictures in either color or black and white to match the user's preference.

## 2.7-inch<sup>7</sup> Type, 16:9 Widescreen, Hybrid, Color LCD Monitor

The HVR-A1U includes a 2.7-inch type color LCD monitor with a high resolution of approx. 123,200 pixels, which allows the input source to be viewed during recording or the playback picture to be checked on location in a widescreen aspect ratio of 16:9. This large screen is also helpful in setting menus or audio recording levels, as well as monitoring the camera and audio status. The hybrid LCD monitor used in the camcorder combines the characteristics of both transmissive and reflective LCD panels, providing clear viewing even in bright daylight conditions as well as in dark conditions.

This LCD monitor also provides touch-panel control for easy operations.

<sup>7</sup> Viewable area, measured diagonally

## Variety of Zoom Operation

The HVR-A1U provides four types of zoom control functions to offer diverse shooting styles:

- “Zoom lever” located on the camera body
- “Zoom/focus ring” located on the lens body – allows fine adjustments in zoom position
- “Zoom buttons” located on the LCD monitor – convenient for low-angle shooting
- Supplied wireless Remote Commander® unit

## Exposure Lever

The HVR-A1U enables exposure control both manually and automatically. The Exposure Lever provides two types of exposure control:

- Manual exposure control to manually change exposure settings using the Exposure Lever.
- AE (Auto Exposure) Shift function to adjust AE level by 15 steps using the Exposure Lever, while the AE mode is activated, for more accurate automatic exposure settings.



## Tele Macro

The Tele Macro function allows operators to capture a macro image from a distance, which is especially useful for shooting small moving objects. With this function, close-up images can be shot without the camcorder casting a shadow on the subject. In addition, the image of the subject is shot in proper focus, while the background is unfocused, allowing the subject to stand out.

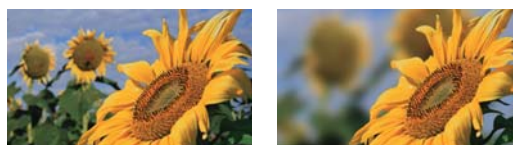

Conventional Macro

Tele Macro

Images Simulated

## New Backlight Compensation

The new Backlight Compensation function allows the HVR-A1U to produce natural and rich tones for both light and dark areas of an image under backlight conditions. Conventional systems of backlight compensation tend to make the details in light areas sacrificed, but the new Backlight Compensation function of the HVR-A1U can deliver superior images with a very wide dynamic range by increasing only the brightness of dark areas while properly retaining the brightness of light areas.



## Marker

Four types of markers can be displayed on the LCD monitor and viewfinder, and can be displayed simultaneously:

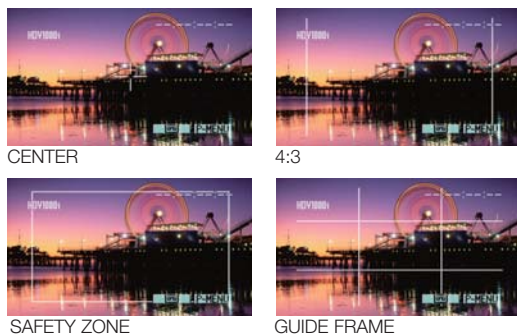

Images Simulated

## Assign Button

A function frequently used in the field can be assigned to the Assign Button (push button), located on the right side of the camera body, allowing operators to make rapid changes under field conditions. The assignable functions include Status Check, Super SteadyShot, One Push Auto White Balance, Histogram Indicator, and Color Bars (two types).

## Time Code Preset

The time code can be preset using any number in H/M/S/F (hours/minutes/seconds/frames) to record desired tape-position information. The time-code mode can be selected between "REC RUN" and "FREE RUN". In addition to the time code, user bits can also be set.

## Histogram Indicator

The Histogram Indicator for brightness can be displayed on the LCD monitor and viewfinder, allowing operators to easily evaluate the brightness of currently captured images for proper exposure.

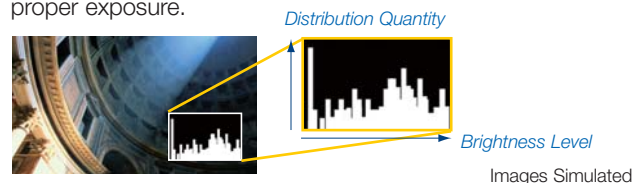

## Shot Transition

The Shot Transition™ function allows for smooth automatic scene transitions. The operator can program start and end settings for zoom, focus, and white balance into the A/B buttons and, by pressing the start button, a smooth transition will take place according to the set time, because the camera automatically calculates the intermediate values during the scene transition. The start of this function can be synchronized with the camera's REC start function. The transition progress can be checked using an indicator displayed on the LCD monitor. In addition, a start timer function is also available for the Shot Transition function, helping to prevent operators from missing a shot. This function is very useful when complex camera settings are required during the scene transition – for example, when shooting subjects moving from the background to the foreground of a scene.

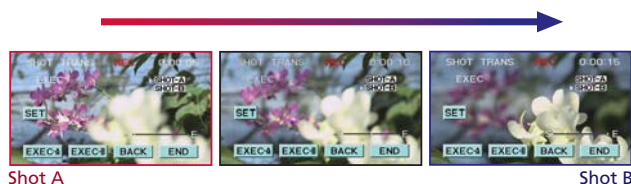

## Cinema-like Image Shooting

Two powerful features to produce cinematic and film-like pictures are provided on the HVR-A1U. The Cinematone Gamma™ feature allows operators to quickly set up and load a gamma curve with similar contrast characteristic to a film gamma curve. The Cineframe™ feature allows picture movement to be reproduced like a film of 24 and 30 frames/s.

## Long Operating Time

With the optional NP-QM91D InfolITHIUM Rechargeable Battery Pack attached, the HVR-A1U can continuously record in HDV mode for up to 300 minutes, or up to 340 minutes in DVCAM/DV mode.

### Battery Life

Continuous Recording Time*	With LCD Viewfinder On		With LCD Monitor On**		With LCD Viewfinder and Monitor On**	
	HDV	DVCAM/DV	HDV	DVCAM/DV	HDV	DVCAM/DV
NP-FM50 (supplied)	80 min	90 min	75 min	90 min	70 min	80 min
NP-QM71D (optional)	200 min	225 min	195 min	220 min	180 min	200 min
NP-QM91D (optional)	300 min	340 min	295 min	330 min	275 min	300 min

\* Continuous recording time, indoors at 25C°

\*\*With LCD backlight on

## OTHER CONVENIENT FUNCTIONS

### ■ Simultaneous Operation of LCD Monitor and Viewfinder

■ **Expanded Focus** - magnifies the center of the screen on the LCD monitor and viewfinder to about twice the size, helping manual focusing.

■ **Peaking** - enhances the outline of the image where the camera focuses on most, and displays the enhanced outline with color in the LCD monitor and viewfinder, helping manual focusing.

■ **Zebra** - displays a striped pattern in the LCD monitor and viewfinder across highlight areas, helping manual exposure settings (100% or 70 to 100% (adjustable by 5% steps)).

■ **Quick REC** - shortens the time until the recording starts from stop mode.

■ **Status Check** - displays camera setting menus for audio, output signal, assign button and exposure lever functions and hours meter on the LCD monitor with the touch of a button for easy check.

■ **Personal Menu** - allows operators to customize the setting menu to display frequently used menu items.

■ **Battery Info** - displays the attached battery's current charge level and its current remaining recording time on the LCD monitor with the touch of a button, when the power is turned off.

■ **Super Night Shot™** - allows operators to capture images in black and white using a built-in infrared light, even in no light conditions.

■ **Skin Tone Detail** - reduces detailed signal for skin color, smoothing the reproduction of human skin.

■ **Black Stretch** - allows more contrast to be seen in dark parts of the picture without affecting mid-tones while maintaining the absolute black level.

■ **Color Bar** - Two types

■ **White Balance** - Auto, One Push Auto, Indoor (3200 K), and Outdoor (5800 K)

## OPTIONAL ACCESSORIES



NP-QM71D/QM91D\*  
InfoLITHIUM Rechargeable  
Battery Pack



2NP-QM91D/B\*  
InfoLITHIUM Rechargeable  
Battery Pack (NP-QM91D x 2)



VCL-HG2037Y  
2.0x Tele Conversion Lens



VCL-HG0737Y  
0.7x Wide Conversion Lens



LC-A1TH  
Hard Carrying Case



LC-A1BP  
Soft Carrying Case



VMC-30VC  
3m Component Video Cable



VMC-30FS  
3m Multi AV Cable (with S Video)



UWP-C1  
UHF Synthesized Wireless  
Microphone Package



PHDVM-63DM  
DigitalMaster Mini Cassette Tape

RM-1BP  
LANC Remote Controller

\*When the NP-QM91D battery pack is attached to the HVR-A1U, the battery pack protrudes past the viewfinder.



# SPECIFICATIONS

Camera section	
Lens	Carl Zeiss Vario-Sonnar T* zoom lens, 10x (optical), f = 5.1 to 51 mm f = 40 to 400 mm in 16:9 mode and 49.3 to 493 mm in 4:3 mode (full scan mode on)* f = 41 to 480 mm in 16:9 mode and 50 to 590 mm in 4:3 mode (full scan mode off)* f = 40 to 400 mm in 16:9 mode and 37 to 370 mm in 4:3 mode (still picture mode)* f = 1.8 to 2.1, filter diameter: 37 mm
Focus	Auto, manual, spot focus (touch panel control)
Imaging device	1-chip, 1/3-inch type primary color CMOS sensor
Picture elements	Approx. 2,969,000 pixels (total)
Shutter speed	1/4, 1/8, 1/15, 1/30, 1/60, 1/90, 1/100, 1/125, 1/180, 1/250, 1/350, 1/500, 1/725, 1/1000, 1/1500, 1/2000, 1/3000, 1/4000, 1/6000, 1/10000 s
Minimum illumination	7 lx with F1.8
VTR section	
Recording format	1080/60i, 480/60i
Play out/Down conversion format	1080/60i, 480/60i, 480/60P
Tape speed	HDV/DV SP Max. 18.812 mm/s with PHDVM-63DM cassette DVCAM Max. 28.218 mm/s with PHDVM-63DM cassette
Playback/Recording time	HDV/DV SP Max. 63 min with PHDVM-63DM cassette DVCAM Max. 41 min with PHDVM-63DM cassette
Fast forward/Rewind time	Approx. 2 min 40 s with PHDVM-63DM cassette (using a fully charged battery) Approx. 1 min 45 s with PHDVM-63DM cassette (using an AC adaptor)
Input/Output connectors	
Audio/Video input/output	A/V OUT jack, 10-pin connector Composite video: 1 Vp-p, 75 unbalanced, sync negative Y: 1 Vp-p, 75 unbalanced, sync negative C: 0.286 Vp-p, 75 unbalanced Audio: 327 mV, input impedance more than 47 k , output impedance less than 2.2 k
Component video output	COMPONENT OUT jack Y: 1 Vp-p (0.3 V, sync negative), 75 unbalanced Pr/Pb (Cr/Cb): 700 mVp-p (75% color bar)
HDV/DV input/output	i.LINK interface (IEEE 1394, 4-pin connector S100)
XLR audio input	XLR 3-pin female x 2, 327 mV, -60 dBu: 3 k , +40 dBu: 10.8 k $\Omega$ , power supply: approx. 48 V
Headphone	Stereo minijack ( $\phi$ 3.5 mm) x 1
MIC	Minijack x 1, 0.388 mV, low impedance with DC 2.5 to 3.0 V, output impedance 6.8 k $\Omega$ ( $\phi$ 3.5 mm), stereo type
LANC	Stereo mini-minijack ( $\phi$ 2.5 mm) x 1
USB	Mini-B x 1
Built-in input/output devices	
LCD viewfinder	0.44-inch type, approx. 252,000 (1120 x 225) pixels , hybrid type, 16:9 aspect ratio
LCD monitor	2.7-inch type, approx. 123,200 (560 x 220) pixels, hybrid type, 16:9 aspect ratio
Microphone	Stereo type, noise reduction on/off
Speaker	$\phi$ 16 mm
General	
Weight	Approx. 1 lb 7 oz (670 g) (camcorder only)
Power requirements	DC 7.2 V (battery pack), DC 8.4 V (AC adaptor)
Power consumption	HDV Approx. 5.6 W (recording mode with LCD viewfinder on) DVCAM/DV Approx. 5.1 W (recording mode with LCD viewfinder on)
Operating temperature	32 to 104 °F (0 to 40 °C)
Storage temperature	-4 to 140 °F (-20 to +60 °C)
Supplied accessories	AC-L15 AC adaptor, power code, NP-FM50 InfoLITHIUM rechargeable battery pack, lens hood with lens cover, RMT-831 wireless Remote Commander unit, A/V connecting cable with S video, component video cable, USB cable, Memory Stick Duo (16 MB), Memory Stick Duo adaptor, ECM-NV1 monaural electret condenser microphone, XLR audio adaptor, shoulder strap, operating instructions

\* These values are calculated to be equivalent to the 35 mm film.

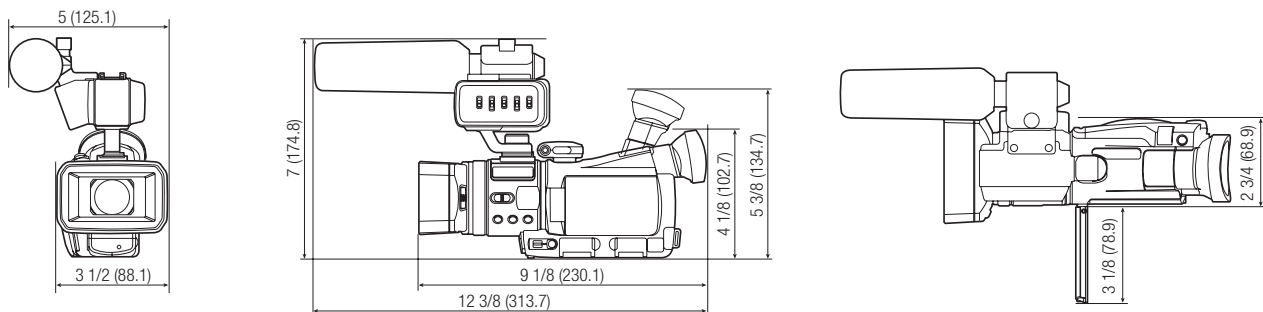

unit: inches (mm)

---

**SONY**<sup>®</sup>

Sony Electronics Inc.  
1 Sony Drive  
Park Ridge, NJ 07656  
[www.sony.com/HDV](http://www.sony.com/HDV)

© 2005 Sony Corporation. All rights reserved.  
Reproduction in whole or in part without permission is prohibited.

Features and specifications are subject to change without notice.

All non-metric weights and measurements are approximate.

Sony, DVCAM, Memory Stick Duo, DigitalMaster, Enhanced Imaging Processor, SteadyShot, HD  
Codec Engine, i.LINK, InfoLITHIUM, Remote Commander, Shot Transition, Cinematone Gamma,  
Cineframe, and Night Shot are trademarks of Sony.

HDV and the HDV logo are trademarks of Sony Corporation and Victor Company of Japan, Limited.

Vario-Sonnar T\* is a trademark of Carl Zeiss AG.