

SONY[®]

LCD Data Projector

VPL-FE100U/FE100M



With optional VPLL-Z2019 lens

The VPL-FE100 LCD Data **Native SXGA Resolution** **Brightness of 3200 ANS**

The technology of LCD-based projectors continues to grow rapidly in today's market. Sony has recognized the market demand for increased resolution and higher brightness projectors and has not only responded to these trends, but has anticipated them as well. The VPL-FE100 is the perfect example.*

With our new, native SXGA LCD panels and support of signals up to UXGA, you can project high-resolution images that will retain their clarity and detail, even on a large screen. Sony's unique four-lamp light source produces an impressive 3200 ANSI lumens, and provides extra insurance by continuing to function even if one of the lamps fails – the show will always go on!

*The VPL-FE100 is available in two models:
the VPL-FE100U for countries operating at AC 100-120 V and
the VPL-FE100M for AC 220-240 V.



...a Projector from Sony—

... Lumens



PICTURE QUALITY

OUTSTANDING BRIGHTNESS OF 3200 ANSI LUMENS

Using three 1.8-inch Sony SXGA LCD panels, the VPL-FE100 delivers an outstanding brightness of 3200 ANSI lumens. No matter what the room lighting conditions, your presentation will always be clear and vibrant.

EXCELLENT PICTURE PERFORMANCE

The advanced technologies of the VPL-FE100 provide excellent picture performance. This projector utilizes 3D Digital Gamma correction for outstanding picture uniformity, as well as exclusive Sony DRC (Digital Reality Creation) technology. DRC generates video pictures with effectively four times the resolution of that from a conventional video signal. Unlike conventional linear interpolation, which uses filtering techniques, DRC generates a high-resolution signal by referring to memorized waveform patterns. As a result, you can project high-density pictures in which the details of the objects are enhanced.

MULTISCAN CAPABILITY

With its high performance built-in scan converter, the VPL-FE100 is compatible with a variety of input sources: composite, Y/C, component (Y/R-Y/B-Y) and RGB video, as well as computer signals (up to UXGA, 1600 x 1200, fv: 75 Hz) with a horizontal frequency of 15 to 100 kHz and a vertical frequency of 40 to 120 Hz. The multiscan technology employed by the VPL-FE100 performs advanced interpolation and finite impulse response (FIR) filtering independently in both horizontal and vertical directions, depending on the line structure of the input signal.

HDTV AND DTV SUPPORT

With the progression toward HDTV and DTV, the VPL-FE100 is designed to support a wide variety of HDTV and DTV signals. For more details, please refer to the HDTV and DTV Signal Chart.

SYSTEM VERSATILITY

The VPL-FE100, like other Sony large venue projectors, is designed with versatility in mind. The option slots in the rear panel accept a range of Sony IFB Interface Boards that allow multiple sources to be connected to the projection system at the same time. The use of a PC-3000 Signal Interface Switcher will further enhance the ability of the projector to handle multiple signals simultaneously. The VPL-FE100 also supports RS-232C/422A control interfacing.

FAIL-SAFE

The light source of the VPL-FE100 incorporates four lamps so that even if one lamp fails, the projector will still continue to function. If a second fails, the projector automatically switches to standby mode.

ADJUSTABLE FEET

The VPL-FE100 has easy-to-adjust feet. Simply by turning the pop-out cranks on each side, you can set the projector to the desired height.

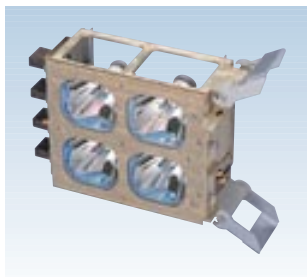

Quad lamp

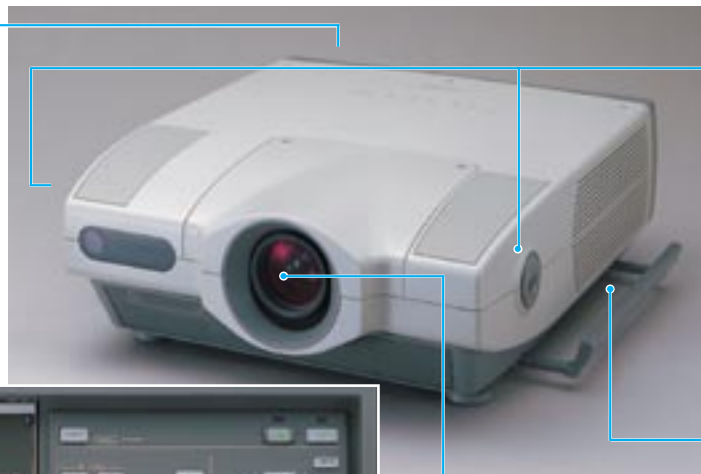

Pop-out cranks and adjustable feet
(both sides)

Carrying handles
(both sides)

Optional lens
(Photo: VPLL-Z2019)



Control panel and
connector section

INSTALLATION FLEXIBILITY

The VPL-FE100 is designed for use in a variety of installation situations - ceiling, floor, and even rear projection. To add even more flexibility, a range of eight lenses is available to provide the perfect match for your installation.

POWER FOCUS, POWER ZOOM, AND PICTURE SHIFT FUNCTIONS*

Power Focus and Power Zoom are easily controlled from the control panel or the supplied remote control unit. The projected image can be shifted up and down using the Picture Shift feature.

*Some optional lenses do not support the zoom function.

5:4 AND 4:3 ASPECT RATIO SUPPORT

Rather than limit your installation options, the VPL-FE100 expands them by making it easy to reproduce a wide variety of signals in their original aspects. With available resizing modes, the VPL-FE100 is able to project an entire 5:4 aspect ratio image within the screen, even if your screen is installed for use with 4:3 aspect ratio sources.

STACKING CAPABILITY*

The VPL-FE100 can be twin or triple stacked using optional SU-PJ2000 projector stands. When stacked, the brightness is significantly increased.

*The fixed focus lenses (VPLL-3050/2075/2014/2009) cannot be used when the VPL-FE100 is stacked.



EASY OPERATION

APA (Auto Pixel Alignment)

Pixel alignment is automated. Just press the APA key and innovative Sony technology detects the signal and adjusts for optimum image quality.

OSD (On-Screen Display)

The On-Screen Display for the VPL-FE100 is available in English, French, Spanish, Italian, German, Japanese, and Chinese languages. With this projector's new graphical interface, it is very easy to use.



REMOTE CONTROL

The RM-PJ1001 wired/wireless remote control unit is supplied with the VPL-FE100 and controls all projector functions. The optional RM-PJ3000S wired/wireless remote control unit provides simple remote control. The optional RM-PJ10 Remote Control Receiver is available to extend the range of these remotes in wireless mode.



Remote control units

ADDITIONAL FEATURES

POWER SAVING

When the Power Saving mode is activated, the VPL-FE100 automatically enters the power saving mode if no signals have been received for 10 minutes. The projector returns to normal operation as soon as a signal is input.

TRIG TERMINAL

The VPL-FE100 has a TRIG terminal to provide control of an integrated projection room, including screens, curtains, and lighting.

unit: mm (inches)

Lens: VPLL-Z3020 4:3										
Screen Size (inches)		40	80	100	120	150	200	300	400	500
Floor Installation										
a	min	1590 (62 5/8)	3310 (130 3/8)	4170 (164 1/4)	5030 (198 1/16)	6310 (248 1/2)	8460 (333 1/8)	12750 (502 1/8)	17040 (671)	21330 (839 7/8)
	max	2030 (79 15/16)	4190 (165)	5260 (207 1/8)	6340 (249 3/4)	7950 (313 1/8)	10640 (419)	16020 (630 13/16)	21400 (842 5/8)	26780 (1054 1/2)
b	min	x-295 (x-11 5/8)	x-590 (x-23 1/4)	x-737 (x-29 1/8)	x-884 (x-34 7/8)	x-1106 (x-43 5/8)	x-1474 (x-58 1/8)	x-2211 (x-87 1/8)	x-2948 (x-116 1/8)	x-3685 (x-145 1/8)
	max	x								
c	min	x-450 (x-17 3/4)	x-745 (x-29 3/8)	x-892 (x-35 1/8)	x-1039 (x-41)	x-1261 (x-49 3/4)	x-1629 (x-64 1/4)	x-2366 (x-93 1/4)	x-3103 (x-122 1/4)	x-3840 (x-151 1/4)
	max	x-142 (x-5 5/8)								
Ceiling Installation										
a	min	1590 (62 5/8)	3310 (130 3/8)	4170 (164 1/4)	5030 (198 1/16)	6310 (248 1/2)	8460 (333 1/8)	12750 (502 1/8)	17040 (671)	21330 (839 7/8)
	max	2030 (79 15/16)	4190 (165)	5260 (207 1/8)	6340 (249 3/4)	7950 (313 1/8)	10640 (419)	16020 (630 13/16)	21400 (842 5/8)	26780 (1054 1/2)
b	min	c+131 (c+5 1/4)								
	max	c+144 (c+5 3/4)								
e	min	305 (12 1/8)	610 (24 1/8)	762 (30)	914 (36)	1143 (45)	1524 (60)	2286 (90 1/8)	3048 (120 1/16)	3810 (150 1/8)
	max	c+131 (c+5 1/4)								
x	min	c+438 (c+17 1/4)								
	max	c+438 (c+17 1/4)	c+733 (c+28 7/8)	c+881 (c+34 3/4)	c+1028 (c+40 1/2)	c+1249 (c+49 1/4)	c+1618 (c+63 3/4)	c+2355 (c+92 3/4)	c+3092 (c+121 3/4)	c+3829 (c+150 7/8)
Twin Stack (Floor Installation)										
a		—	3860 (152)	4840 (190 5/8)	5820 (229 1/4)	7300 (287 1/2)	9750 (384)	14670 (577 3/4)	19580 (771)	24500 (964 3/4)

Lens: VPLL-Z3020 5:4 (Screen: 4:3)										
Screen Size (inches)		42	80	100	120	150	200	300	400	500
Floor Installation										
a	min	1570 (61 7/8)	3090 (121 3/4)	3900 (153 5/8)	4700 (185 1/8)	5910 (232 3/4)	7920 (311 7/8)	11940 (470 1/4)	15960 (628 1/2)	19980 (786 3/4)
	max	2000 (78 3/4)	3920 (154 3/8)	4920 (193 3/4)	5930 (233 1/2)	7440 (293)	9960 (392 1/4)	15000 (590 5/8)	20040 (789 1/8)	25080 (987 5/8)
b	min	x-286 (x-11 1/4)	x-544 (x-21 1/2)	x-680 (x-26 7/8)	x-816 (x-32 1/4)	x-1020 (x-40 1/4)	x-1360 (x-53 5/8)	x-2040 (x-80 3/8)	x-2720 (x-107 1/8)	x-3400 (x-134)
	max	x								
c	min	x-440 (x-17 3/8)	x-699 (x-27 5/8)	x-835 (x-32 7/8)	x-971 (x-38 1/4)	x-1175 (x-46 3/8)	x-1515 (x-59 3/4)	x-2195 (x-86 1/2)	x-2875 (x-113 1/4)	x-3555 (x-140)
	max	x-142 (x-5 5/8)								
Ceiling Installation										
a	min	1570 (61 7/8)	3090 (121 3/4)	3900 (153 5/8)	4700 (185 1/8)	5910 (232 3/4)	7920 (311 7/8)	11940 (470 1/4)	15960 (628 1/2)	19980 (786 3/4)
	max	2000 (78 3/4)	3920 (154 3/8)	4920 (193 3/4)	5930 (233 1/2)	7440 (293)	9960 (392 1/4)	15000 (590 5/8)	20040 (789 1/8)	25080 (987 5/8)
b	min	c+131 (c+5 1/4)								
	max	c+143 (c+5 3/4)								
e	min	317 (12 1/2)	605 (23 7/8)	756 (29 7/8)	907 (35 3/4)	1134 (44 3/4)	1512 (59 5/8)	2268 (89 3/8)	3024 (119 3/32)	3780 (148 7/8)
	max	c+131 (c+5 1/4)								
x	min	c+429 (c+17)								
	max	c+429 (c+17)	c+687 (c+27 1/8)	c+823 (c+32 1/2)	c+959 (c+37 7/8)	c+1163 (c+45 7/8)	c+1503 (c+59 1/4)	c+2184 (c+86)	c+2864 (c+112 7/8)	c+3544 (c+139 5/8)
Twin Stack (Floor Installation)										
a		—	3700 (145 3/4)	4640 (182 3/4)	5590 (220 1/8)	7000 (275 5/8)	9360 (368 5/8)	14080 (554 1/2)	18800 (740 1/4)	23520 (926 1/8)

Lens: VPLL-Z2019 4:3										
Screen Size (inches)		40	80	100	120	150	200	300	400	
Floor Installation										
a	min	1530 (60 1/4)	3170 (124 7/8)	3990 (157 1/8)	4800 (189)	6030 (237 7/16)	8080 (318 1/4)	12170 (479 1/4)	16260 (640 1/4)	
	max	1950 (76 7/8)	4000 (157 1/2)	5020 (197 11/16)	6040 (237 7/8)	7580 (298 1/2)	10140 (399 3/8)	15260 (600 7/8)	20380 (802 1/2)	
b	min	x-295 (x-11 5/8)	x-590 (x-23 1/4)	x-737 (x-29 1/8)	x-884 (x-34 7/8)	x-1106 (x-43 5/8)	x-1474 (x-58 1/8)	x-2211 (x-87 1/8)	x-2948 (x-116 1/8)	
	max	x								
c	min	x-450 (x-17 3/4)	x-745 (x-29 3/8)	x-892 (x-35 1/8)	x-1039 (x-41)	x-1261 (x-49 3/4)	x-1629 (x-64 1/4)	x-2366 (x-93 1/4)	x-3103 (x-122 1/4)	
	max	x-142 (x-5 5/8)								
Ceiling Installation										
a	min	1530 (60 1/4)	3170 (124 7/8)	3990 (157 1/8)	4800 (189)	6030 (237 7/16)	8080 (318 1/4)	12170 (479 1/4)	16260 (640 1/4)	
	max	1950 (76 7/8)	4000 (157 1/2)	5020 (197 11/16)	6040 (237 7/8)	7580 (298 1/2)	10140 (399 3/8)	15260 (600 7/8)	20380 (802 1/2)	
b	min	c+131 (c+5 1/4)								
	max	c+144 (c+5 3/4)								
e	min	305 (12 1/8)	610 (24 1/8)	762 (30)	914 (36)	1143 (45)	1524 (60)	2286 (90 1/8)	3048 (120 1/16)	
	max	c+131 (c+5 1/4)								
x	min	c+438 (c+17 1/4)								
	max	c+438 (c+17 1/4)	c+733 (c+28 7/8)	c+881 (c+34 3/4)	c+1028 (c+40 1/2)	c+1249 (c+49 1/4)	c+1618 (c+63 3/4)	c+2355 (c+92 3/4)	c+3092 (c+121 3/4)	
Twin Stack (Floor Installation)										
a		—	3710 (146 1/8)	4650 (183 1/8)	5600 (220 1/2)	7020 (276 7/16)	9380 (369 3/8)	14110 (555 5/8)	18840 (741 7/8)	

Lens: VPLL-Z2019 5:4 (Screen: 4:3)										
Screen Size (inches)		42	80	100	120	150	200	300	400	
Floor Installation										
a	min	1500 (59 1/8)	2960 (116 5/8)	3730 (146 7/8)	4490 (176 7/8)	5640 (222 1/8)	7560 (297 3/4)	11390 (448 1/2)	15230 (599 3/4)	
	max	1910 (75 1/4)	3740 (147 3/8)	4700 (185 1/8)	5660 (222 7/8)	7100 (279 5/8)	9500 (374 1/8)	14300 (563 1/8)	19090 (751 3/4)	
b	min	x-286 (x-11 1/4)	x-544 (x-21 1/2)	x-680 (x-26 7/8)	x-816 (x-32 1/4)	x-1020 (x-40 1/4)	x-1360 (x-53 5/8)	x-2040 (x-80 3/8)	x-2720 (x-107 1/8)	
	max	x								
c	min	x-440 (x-17 3/8)	x-699 (x-27 5/8)	x-835 (x-32 7/8)	x-971 (x-38 1/4)	x-1175 (x-46 3/8)	x-1515 (x-59 3/4)	x-2195 (x-86 1/2)	x-2875 (x-113 1/4)	
	max	x-142 (x-5 5/8)								
Ceiling Installation										
a	min	1500 (59 1/8)	2960 (116 5/8)	3730 (146 7/8)	4490 (176 7/8)	5640 (222 1/8)	7560 (297 3/4)	11390 (448 1/2)	15230 (599 3/4)	
	max	1910 (75 1/4)	3740 (147 3/8)	4700 (185 1/8)	5660 (222 7/8)	7100 (279 5/8)	9500 (374 1/8)	14300 (563 1/8)	19090 (751 3/4)	
b	min	c+131 (c+5 1/4)								
	max	c+143 (c+5 3/4)								
e	min	317 (12 1/2)	605 (23 7/8)	756 (29 7/8)	907 (35 3/4)	1134 (44 3/4)	1512 (59 5/8)	2268 (89 3/8)	3024 (119 3/32)	
	max	c+131 (c+5 1/4)								
x	min	c+429 (c+17)								
	max	c+429 (c+17)	c+687 (c+27 1/8)	c+823 (c+32 1/2)	c+959 (c+37 7/8)	c+1163 (c+45 7/8)	c+1503 (c+59 1/4)	c+2184 (c+86)	c+2864 (c+112 7/8)	
Twin Stack (Floor Installation)										
a		—	3560 (140 1/4)	4460 (175 5/8)	5370 (211 1/2)	6730 (265)	9000 (354 3/8)	13540 (533 1/4)	18080 (712)	

INSTALLATION EXAMPLES

Lens: VPLL-Z2025 4:3									
Screen Size (inches)		80	100	120	150	200	300	400	500
Floor Installation									
a	min	4100 (161 1/2)	5170 (203 5/8)	6240 (245 3/4)	7850 (309 1/8)	10520 (414 1/4)	15870 (625)	21220 (835 5/8)	26580 (1046 5/8)
	max	6340 (249 3/4)	7970 (313 7/8)	9600 (378)	12040 (474 1/8)	16120 (634 3/4)	24260 (955 1/4)	32400 (1275 3/4)	40550 (1596 3/4)
b	min	x-590 (x-23 1/4)	x-737 (x-29 1/8)	x-884 (x-34 7/8)	x-1106 (x-43 5/8)	x-1474 (x-58 1/4)	x-2211 (x-87 1/8)	x-2948 (x-116 1/8)	x-3685 (x-145 1/8)
	max	x							
c	min	x-745 (x-29 3/8)	x-892 (x-35 1/8)	x-1039 (x-41)	x-1261 (x-49 3/4)	x-1629 (x-64 1/4)	x-2366 (x-93 1/4)	x-3103 (x-122 1/4)	x-3840 (x-151 1/4)
	max	x-142 (x-5 5/8)							
Ceiling Installation									
a	min	4100 (161 1/2)	5170 (203 5/8)	6240 (245 3/4)	7850 (309 1/8)	10520 (414 1/4)	15870 (625)	21220 (835 5/8)	26580 (1046 5/8)
	max	6340 (249 3/4)	7970 (313 7/8)	9600 (378)	12040 (474 1/8)	16120 (634 3/4)	24260 (955 1/4)	32400 (1275 3/4)	40550 (1596 3/4)
b	min	c+131 (c+5 1/4)							
	max	c+144 (c+5 3/4)							
e	min	610 (24 1/8)	762 (30)	914 (36)	1143 (45)	1524 (60)	2286 (90 1/8)	3048 (120 1/16)	3810 (150 1/8)
	max	c+131 (c+5 1/4)							
x	min	c+733 (c+28 7/8)							
	max	c+881 (c+34 3/4)	c+1028 (c+40 1/2)	c+1249 (c+49 1/4)	c+1618 (c+63 3/4)	c+2355 (c+92 3/4)	c+3092 (c+121 3/4)	c+3829 (c+150 7/8)	
Twin Stack (Floor Installation)									
a	min	4460 (175 5/8)	5650 (222 1/2)	6830 (269)	8610 (339 1/8)	11580 (456)	17510 (689 1/2)	23450 (923 3/8)	29380 (1156 7/8)

Lens: VPLL-Z2025 5:4 (Screen: 4:3)									
Screen Size (inches)		84	100	120	150	200	300	400	500
Floor Installation									
a	min	4030 (158 11/16)	4830 (190 1/4)	5840 (230)	7340 (289 1/8)	9850 (387 7/8)	14860 (585 1/8)	19880 (782 7/8)	24890 (980 1/8)
	max	6240 (245 3/4)	7460 (293 3/4)	8990 (354)	11280 (444 1/4)	15090 (594 1/4)	22720 (894 5/8)	30350 (1195 1/8)	37990 (1495 7/8)
b	min	x-571 (x-22 1/2)	x-680 (x-26 7/8)	x-816 (x-32 1/4)	x-1020 (x-40 1/4)	x-1360 (x-53 5/8)	x-2040 (x-80 3/8)	x-2720 (x-107 1/8)	x-3400 (x-134)
	max	x							
c	min	x-726 (x-28 5/8)	x-835 (x-32 7/8)	x-971 (x-38 1/4)	x-1175 (x-46 3/8)	x-1515 (x-59 3/4)	x-2195 (x-86 1/2)	x-2875 (x-113 1/4)	x-3555 (x-140)
	max	x-142 (x-5 5/8)							
Ceiling Installation									
a	min	4030 (158 11/16)	4830 (190 1/4)	5840 (230)	7340 (289 1/8)	9850 (387 7/8)	14860 (585 1/8)	19880 (782 7/8)	24890 (980 1/8)
	max	6240 (245 3/4)	7460 (293 3/4)	8990 (354)	11280 (444 1/4)	15090 (594 1/4)	22720 (894 5/8)	30350 (1195 1/8)	37990 (1495 7/8)
b	min	c+131 (c+5 1/4)							
	max	c+143 (c+5 3/4)							
e	min	635 (25)	756 (29 7/8)	907 (35 3/4)	1134 (44 3/4)	1512 (59 5/8)	2268 (89 3/8)	3024 (119 3/32)	3780 (148 7/8)
	max	c+131 (c+5 1/4)							
x	min	c+715 (c+28 1/4)							
	max	c+823 (c+32 1/2)	c+959 (c+37 7/8)	c+1163 (c+45 7/8)	c+1503 (c+59 1/4)	c+2184 (c+86)	c+2864 (c+112 7/8)	c+3544 (c+139 5/8)	
Twin Stack (Floor Installation)									
a	min	4500 (177 1/4)	5410 (213 1/8)	6550 (258)	8260 (325 1/4)	11100 (437 1/8)	16800 (661 1/2)	22500 (886)	28190 (1110)

Lens: VPLL-Z2039 4:3									
Screen Size (inches)		80	100	120	150	200	300	400	500
Floor Installation									
a	min	6540 (257 5/8)	8220 (323 3/4)	9900 (389 7/8)	12420 (489 1/8)	16610 (654 1/8)	25000 (984 3/8)	33390 (1314 3/4)	41780 (1645 1/8)
	max	9420 (371)	11810 (465 1/8)	14210 (559 5/8)	17800 (700 7/8)	23780 (936 3/8)	35750 (1407 3/4)	47720 (1879)	59690 (2350 3/8)
b	min	x-590 (x-23 1/4)	x-737 (x-29 1/8)	x-884 (x-34 7/8)	x-1106 (x-43 5/8)	x-1474 (x-58 1/4)	x-2211 (x-87 1/8)	x-2948 (x-116 1/8)	x-3685 (x-145 1/8)
	max	x							
c	min	x-745 (x-29 3/8)	x-892 (x-35 1/8)	x-1039 (x-41)	x-1261 (x-49 3/4)	x-1629 (x-64 1/4)	x-2366 (x-93 1/4)	x-3103 (x-122 1/4)	x-3840 (x-151 1/4)
	max	x-142 (x-5 5/8)							
Ceiling Installation									
a	min	6540 (257 5/8)	8220 (323 3/4)	9900 (389 7/8)	12420 (489 1/8)	16610 (654 1/8)	25000 (984 3/8)	33390 (1314 3/4)	41780 (1645 1/8)
	max	9420 (371)	11810 (465 1/8)	14210 (559 5/8)	17800 (700 7/8)	23780 (936 3/8)	35750 (1407 3/4)	47720 (1879)	59690 (2350 3/8)
b	min	c+131 (c+5 1/4)							
	max	c+144 (c+5 3/4)							
e	min	610 (24 1/8)	762 (30)	914 (36)	1143 (45)	1524 (60)	2286 (90 1/8)	3048 (120 1/16)	3810 (150 1/8)
	max	c+131 (c+5 1/4)							
x	min	c+733 (c+28 7/8)							
	max	c+881 (c+34 3/4)	c+1028 (c+40 1/2)	c+1249 (c+49 1/4)	c+1618 (c+63 3/4)	c+2355 (c+92 3/4)	c+3092 (c+121 3/4)	c+3829 (c+150 7/8)	
Twin Stack (Floor Installation)									
a	min	6840 (269 3/8)	8590 (338 1/4)	10340 (407 1/4)	12970 (510 3/4)	17340 (682 7/8)	26100 (1027 3/4)	34850 (1372 1/4)	43610 (1717 1/4)

Lens: VPLL-Z2039 5:4 (Screen: 4:3)									
Screen Size (inches)		84	100	120	150	200	300	400	500
Floor Installation									
a	min	6440 (253 5/8)	7690 (302 7/8)	9270 (365 1/8)	11630 (458)	15560 (612 3/4)	23420 (922 1/4)	31280 (1231 3/4)	39140 (1541 1/4)
	max	9260 (364 5/8)	11060 (435 1/2)	13300 (523 3/4)	16670 (656 1/2)	22280 (877 3/8)	33490 (1318 3/4)	44710 (1760 1/2)	55930 (2202 1/4)
b	min	x-571 (x-22 1/2)	x-680 (x-26 7/8)	x-816 (x-32 1/4)	x-1020 (x-40 1/4)	x-1360 (x-53 5/8)	x-2040 (x-80 3/8)	x-2720 (x-107 1/8)	x-3400 (x-134)
	max	x							
c	min	x-726 (x-28 5/8)	x-835 (x-32 7/8)	x-971 (x-38 1/4)	x-1175 (x-46 3/8)	x-1515 (x-59 3/4)	x-2195 (x-86 1/2)	x-2875 (x-113 1/4)	x-3555 (x-140)
	max	x-142 (x-5 5/8)							
Ceiling Installation									
a	min	6440 (253 5/8)	7690 (302 7/8)	9270 (365 1/8)	11630 (458)	15560 (612 3/4)	23420 (922 1/4)	31280 (1231 3/4)	39140 (1541 1/4)
	max	9260 (364 5/8)	11060 (435 1/2)	13300 (523 3/4)	16670 (656 1/2)	22280 (877 3/8)	33490 (1318 3/4)	44710 (1760 1/2)	55930 (2202 1/4)
b	min	c+131 (c+5 1/4)							
	max	c+143 (c+5 3/4)							
e	min	635 (25)	756 (29 7/8)	907 (35 3/4)	1134 (44 3/4)	1512 (59 5/8)	2268 (89 3/8)	3024 (119 3/32)	3780 (148 7/8)
	max	c+131 (c+5 1/4)							
x	min	c+715 (c+28 1/4)							
	max	c+823 (c+32 1/2)	c+959 (c+37 7/8)	c+1163 (c+45 7/8)	c+1503 (c+59 1/4)	c+2184 (c+86)	c+2864 (c+112 7/8)	c+3544 (c+139 5/8)	
Twin Stack (Floor Installation)									
a	min	6900 (271 3/4)	8240 (324 1/2)	9920 (390 5/8)	12440 (489 7/8)	16640 (655 1/4)	25050 (986 3/8)	33450 (1317 1/8)	41850 (1647 7/8)

4:3 screen installed for use with 4:3 aspect ratio sources

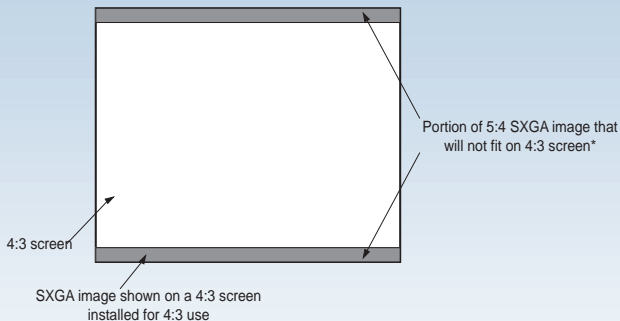

*Mode available to show entire 5:4 image on a 4:3 screen

4:3 screen installed for use with 5:4 aspect ratio SXGA source

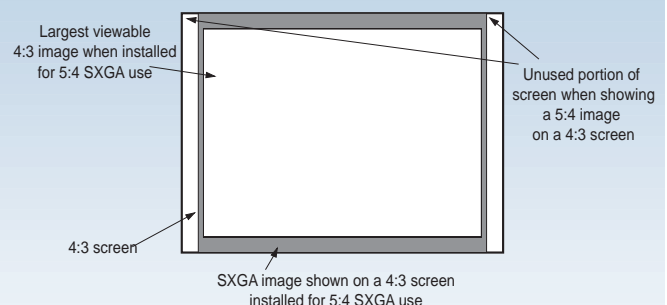

Lens: VPLL-3050 4:3								
Screen Size (Inches)	80	100	120	150	200	300	400	500
Floor Installation								
a	8200 (322 7/8)	10250 (403 5/8)	12290 (484)	15350 (604 1/2)	20460 (805 5/8)	30680 (1208 1/8)	40900 (1610 1/2)	51110 (2012 1/2)
b	min	x-590 (x-23 1/4)	x-737 (x-29 1/8)	x-884 (x-34 7/8)	x-1106 (x-43 5/8)	x-1474 (x-58 1/8)	x-2211 (x-87 1/8)	x-2948 (x-116 1/8)
	max	x						
c	min	x-745 (x-29 3/8)	x-892 (x-35 1/8)	x-1039 (x-41)	x-1261 (x-49 3/4)	x-1629 (x-64 1/4)	x-2366 (x-93 1/4)	x-3103 (x-122 1/4)
	max	x-142 (x-5 5/8)						
Ceiling Installation								
a	8200 (322 7/8)	10250 (403 5/8)	12290 (484)	15350 (604 1/2)	20460 (805 5/8)	30680 (1208 1/8)	40900 (1610 1/2)	51110 (2012 1/2)
b	min	c+131 (c+5 1/4)						
	max	c+144 (c+5 3/4)						
e	610 (24 1/8)	762 (30)	914 (36)	1143 (45)	1524 (60)	2286 (90 1/8)	3048 (120 1/16)	3810 (150 1/8)
x	min	c+131 (c+5 1/4)						
	max	c+733 (c+28 7/8)	c+881 (c+34 3/4)	c+1028 (c+40 1/2)	c+1249 (c+49 1/4)	c+1618 (c+63 3/4)	c+2355 (c+92 3/4)	c+3092 (c+121 3/4)

Lens: VPLL-3050 5:4 (Screen: 4:3)								
Screen Size (Inches)	84	100	120	150	200	300	400	500
Floor Installation								
a	8070 (317 7/8)	9600 (378)	11520 (453 5/8)	14390 (566 5/8)	19180 (755 1/4)	28750 (1132 1/8)	38320 (1508 7/8)	47900 (1886 1/8)
b	min	x-571 (x-22 1/2)	x-680 (x-26 7/8)	x-816 (x-32 1/4)	x-1020 (x-40 1/4)	x-1360 (x-53 5/8)	x-2040 (x-80 3/8)	x-2720 (x-107 1/8)
	max	x						
c	min	x-726 (x-28 5/8)	x-835 (x-32 7/8)	x-971 (x-38 1/4)	x-1175 (x-46 3/8)	x-1515 (x-59 3/4)	x-2195 (x-86 1/2)	x-2875 (x-113 1/4)
	max	x-142 (x-5 5/8)						
Ceiling Installation								
a	8070 (317 7/8)	9600 (378)	11520 (453 5/8)	14390 (566 5/8)	19180 (755 1/4)	28750 (1132 1/8)	38320 (1508 7/8)	47900 (1886 1/8)
b	min	c+131 (c+5 1/4)						
	max	c+143 (c+5 3/4)						
e	635 (25)	756 (29 7/8)	907 (35 3/4)	1134 (44 3/4)	1512 (59 5/8)	2268 (89 3/8)	3024 (119 3/32)	3780 (148 7/8)
x	min	c+131 (c+5 1/4)						
	max	c+715 (c+28 1/4)	c+823 (c+32 1/2)	c+959 (c+37 7/8)	c+1163 (c+45 7/8)	c+1503 (c+59 1/4)	c+2184 (c+86)	c+2864 (c+112 7/8)

Lens: VPLL-2075 4:3								
Screen Size (Inches)	80	100	120	150	200	300	400	500
Floor Installation								
a	12370 (487 1/8)	15420 (607 1/4)	18470 (727 3/8)	23050 (907 5/8)	30680 (1208 1/8)	45930 (1808 1/2)	61190 (2409 3/8)	76450 (3010 1/4)
b	min	x-590 (x-23 1/4)	x-737 (x-29 1/8)	x-884 (x-34 7/8)	x-1106 (x-43 5/8)	x-1474 (x-58 1/8)	x-2211 (x-87 1/8)	x-2948 (x-116 1/8)
	max	x						
c	min	x-745 (x-29 3/8)	x-892 (x-35 1/8)	x-1039 (x-41)	x-1261 (x-49 3/4)	x-1629 (x-64 1/4)	x-2366 (x-93 1/4)	x-3103 (x-122 1/4)
	max	x-142 (x-5 5/8)						
Ceiling Installation								
a	12370 (487 1/8)	15420 (607 1/4)	18470 (727 3/8)	23050 (907 5/8)	30680 (1208 1/8)	45930 (1808 1/2)	61190 (2409 3/8)	76450 (3010 1/4)
b	min	c+131 (c+5 1/4)						
	max	c+144 (c+5 3/4)						
e	610 (24 1/8)	762 (30)	914 (36)	1143 (45)	1524 (60)	2286 (90 1/8)	3048 (120 1/16)	3810 (150 1/8)
x	min	c+131 (c+5 1/4)						
	max	c+733 (c+28 7/8)	c+881 (c+34 3/4)	c+1028 (c+40 1/2)	c+1249 (c+49 1/4)	c+1618 (c+63 3/4)	c+2355 (c+92 3/4)	c+3092 (c+121 3/4)

Lens: VPLL-2075 5:4 (Screen: 4:3)								
Screen Size (Inches)	84	100	120	150	200	300	400	500
Floor Installation								
a	12170 (479 1/4)	14460 (569 3/8)	17320 (682)	21610 (851)	28760 (1132 1/2)	43050 (1695 1/8)	57350 (2258 1/4)	71650 (2821 1/4)
b	min	x-571 (x-22 1/2)	x-680 (x-26 7/8)	x-816 (x-32 1/4)	x-1020 (x-40 1/4)	x-1360 (x-53 5/8)	x-2040 (x-80 3/8)	x-2720 (x-107 1/8)
	max	x						
c	min	x-726 (x-28 5/8)	x-835 (x-32 7/8)	x-971 (x-38 1/4)	x-1175 (x-46 3/8)	x-1515 (x-59 3/4)	x-2195 (x-86 1/2)	x-2875 (x-113 1/4)
	max	x-142 (x-5 5/8)						
Ceiling Installation								
a	12170 (479 1/4)	14460 (569 3/8)	17320 (682)	21610 (851)	28760 (1132 1/2)	43050 (1695 1/8)	57350 (2258 1/4)	71650 (2821 1/4)
b	min	c+131 (c+5 1/4)						
	max	c+143 (c+5 3/4)						
e	635 (25)	756 (29 7/8)	907 (35 3/4)	1134 (44 3/4)	1512 (59 5/8)	2268 (89 3/8)	3024 (119 3/32)	3780 (148 7/8)
x	min	c+131 (c+5 1/4)						
	max	c+715 (c+28 1/4)	c+823 (c+32 1/2)	c+959 (c+37 7/8)	c+1163 (c+45 7/8)	c+1503 (c+59 1/4)	c+2184 (c+86)	c+2864 (c+112 7/8)

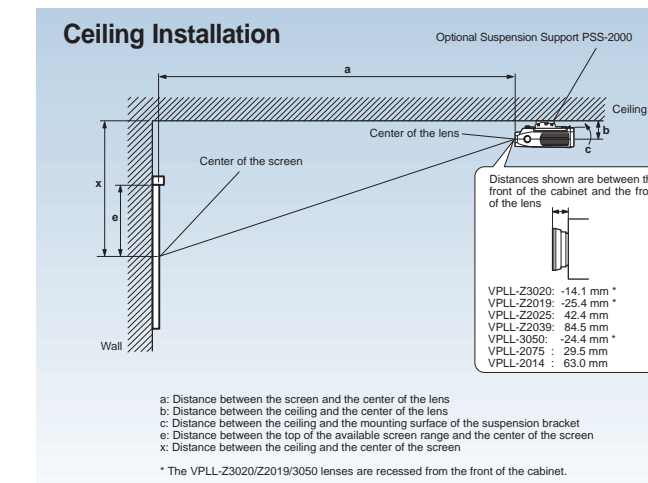
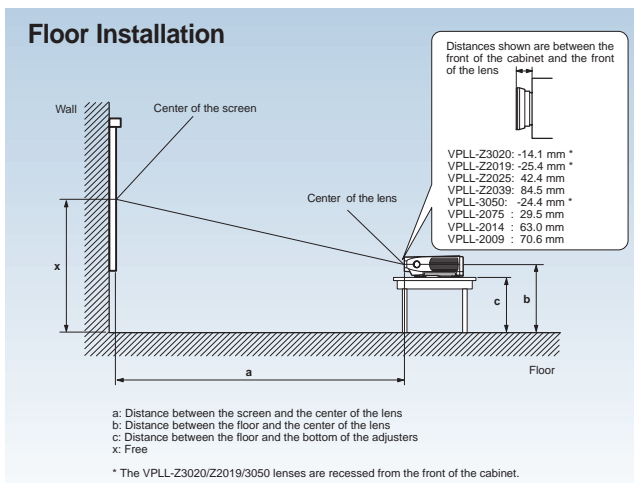

L-2014 4:3									
40	80	100	120	150	200	300	400	500	
ion									
1060 (41 3/4)	2250 (88 5/8)	2840 (111 7/8)	3430 (135 1/8)	4320 (170 1/8)	5800 (228 3/8)	8760 (345)	11720 (461 1/2)	14690 (578 1/2)	
x-222 (x-8 3/4)	x-445 (x-17 1/2)	x-556 (x-21 7/8)	x-667 (x-26 1/4)	x-833 (x-32 7/8)	x-1111 (x-43 3/4)	x-1667 (x-65 3/4)	x-2223 (x-87 5/8)	x-2778 (x-109 1/2)	
x									
x-374 (x-14 3/4)	x-596 (x-23 1/2)	x-707 (x-27 7/8)	x-819 (x-32 1/4)	x-985 (x-38 7/8)	x-1263 (x-49 3/4)	x-1819 (x-71 5/8)	x-2374 (x-93 1/2)	x-2930 (x-115 3/8)	
x-142 (x-5 5/8)									
ation									
1060 (41 3/4)	2250 (88 5/8)	2840 (111 7/8)	3430 (135 1/8)	4320 (170 1/8)	5800 (228 3/8)	8760 (345)	11720 (461 1/2)	14690 (578 1/2)	
c+131 (c+5 1/4)									
c+140 (c+5 1/2)									
305 (12 1/8)	610 (24 1/8)	762 (30)	914 (36)	1143 (45)	1524 (60)	2286 (90 1/8)	3048 (120 1/16)	3810 (150 1/8)	
c+131 (c+5 1/4)									
c+363 (c+14 3/8)	c+585 (c+23 1/8)	c+696 (c+27 1/2)	c+807 (c+31 7/8)	c+974 (c+38 3/8)	c+1252 (c+49 3/8)	c+1807 (c+71 1/4)	c+2363 (c+93 1/8)	c+2919 (c+115)	

L-2014 5:4 (Screen: 4:3)									
42	80	100	120	150	200	300	400	500	
ion									
1040 (41)	2210 (87 1/8)	2650 (104 3/8)	3210 (126 1/2)	4040 (159 1/8)	5430 (213 7/8)	8200 (322 7/8)	10980 (432 3/8)	13750 (541 1/2)	
x-199 (x-7 7/8)	x-397 (x-15 3/4)	x-473 (x-18 5/8)	x-567 (x-22 3/8)	x-709 (x-28)	x-946 (x-37 1/4)	x-1419 (x-55 7/8)	x-1891 (x-74 1/2)	x-2364 (x-93 1/8)	
x									
x-349 (x-13 7/8)	x-548 (x-21 5/8)	x-624 (x-24 5/8)	x-718 (x-28 3/8)	x-860 (x-33 7/8)	x-1097 (x-43 1/4)	x-1569 (x-61 7/8)	x-2042 (x-80 7/16)	x-2515 (x-99 1/8)	
x-142 (x-5 5/8)									
ation									
1040 (41)	2210 (87 1/8)	2650 (104 3/8)	3210 (126 1/2)	4040 (159 1/8)	5430 (213 7/8)	8200 (322 7/8)	10980 (432 3/8)	13750 (541 1/2)	
c+131 (c+5 1/4)									
c+140 (c+5 1/2)									
317 (12 1/2)	605 (23 7/8)	756 (29 7/8)	907 (35 3/4)	1134 (44 3/4)	1512 (59 5/8)	2268 (89 3/8)	3024 (119 3/32)	3780 (148 7/8)	
c+131 (c+5 1/4)									
c+338 (c+13 3/8)	c+537 (c+21 1/4)	c+612 (c+24 1/8)	c+707 (c+27 7/8)	c+849 (c+33 1/2)	c+1085 (c+42 3/4)	c+1558 (c+61 3/8)	c+2031 (c+80)	c+2504 (c+98 5/8)	

Lens: VPLL-2009 4:3										
Screen Size (inches)	40	80	100	120	150	200	300	400	500	
Floor Installation										
a	660 (26)	1460 (57 1/2)	1860 (73 1/4)	2250 (88 5/8)	2850 (112 1/4)	3840 (151 1/4)	5830 (229 5/8)	7820 (308)	9810 (386 3/8)	
b	min	x-34 (x-1 3/8)	x-68 (x-2 3/4)	x-85 (x-3 3/8)	x-102 (x-4 1/8)	x-128 (x-5 1/8)	x-170 (x-6 3/4)	x-255 (x-10 1/8)	x-340 (x-13 1/2)	x-425 (x-16 3/4)
	center	x								
	max	x+11 (x+15/32)	x+23 (x+29/32)	x+28 (x+1 1/8)	x+34 (x+1 3/8)	x+43 (x+1 11/16)	x+57 (x+2 1/4)	x+85 (x+3 3/8)	x+113 (x+4 1/2)	x+142 (x+5 5/8)
c	min	x-178 (x-7)	x-212 (x-8 3/8)	x-229 (x-9)	x-246 (x-9 3/4)	x-271 (x-10 3/4)	x-314 (x-12 3/8)	x-399 (x-15 3/4)	x-484 (x-19 1/8)	x-569 (x-22 1/2)
	center	x-142 (x-5 5/8)								
	max	x-76 (x-3)	x-64 (x-2 5/8)	x-59 (x-2 3/8)	-x+53 (x+0)	-x+44 (x+0)	-x+30 (x+0)	-x+2 (x+0)	x+26 (x+1 1/16)	x+55 (x+2 1/4)

Lens: VPLL-2009 5:4 (Screen: 4:3)										
Screen Size (inches)	42	80	100	120	150	200	300	400	500	
Floor Installation										
a	650 (25 5/8)	1430 (56 3/8)	1730 (68 1/8)	2100 (82 3/4)	2660 (104 3/4)	3590 (141 3/8)	5460 (215)	7320 (288 1/4)	9180 (361 1/2)	
b	min	x-13 (x-17/32)	x-27 (x-1 1/16)	x-32 (x-1 5/16)	x-38 (x-1 9/16)	x-48 (x-1 15/16)	x-64 (x-2 5/8)	x-96 (x-3 7/8)	x-128 (x-5 1/8)	x-159 (x-6 3/8)
	center	x								
	max	x+11 (x+7/16)	x+22 (x+29/32)	x+27 (x+1 1/16)	x+32 (x+1 5/16)	x+40 (x+1 5/8)	x+53 (x+2 1/8)	x+80 (x+3 1/4)	x+106 (x+4 1/4)	x+133 (x+5 1/4)
c	min	x-156 (x-6 1/4)	x-169 (x-6 3/4)	x-174 (x-6 7/8)	x-181 (x-7 1/8)	x-190 (x-7 1/2)	x-206 (x-8 1/8)	x-238 (x-9 1/2)	x-270 (x-10 3/4)	x-302 (x-12)
	center	x-142 (x-5 5/8)								
	max	x-76 (x-3)	x-65 (x-2 5/8)	x-60 (x-2 1/2)	x-55 (x-2 1/4)	x-47 (x-1 7/8)	x-34 (x-1 3/8)	-x+7 (x+0)	x+19 (x+25/32)	x+46 (x+1 13/16)

ACCESSORIES FOR OPTIONAL CONVENIENCE AND SYSTEM FLEXIBILITY

◆ OPTIONAL LENSES

Note: Throw ratio is the distance between the center of the projector lens and the screen, divided by the screen width.



VPLL-Z3020

- 2.09-2.63:1 Throw ratio
- 1.3 times zoom standard focus lens



VPLL-Z2019

- 1.9-2.4:1 Throw ratio
- 1.3 times zoom standard focus lens



VPLL-Z2025

- 2.47-3.81:1 Throw ratio
- 1.6 times zoom long focus lens



VPLL-Z2039

- 3.93-5.65:1 Throw ratio
- 1.5 times zoom long focus lens



VPLL-3050

- 5.13:1 Throw ratio
- Fixed long focus lens



VPLL-2075

- 7.38:1 Throw ratio
- Fixed long focus lens

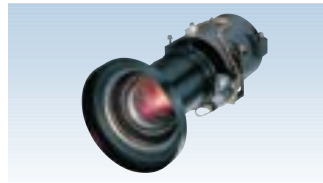

VPLL-2014

- 1.36:1 Throw ratio
- Fixed short focus lens



VPLL-2009

- 0.89:1 Throw ratio
- Fixed short focus lens

◆ SIGNAL INTERFACE SWITCHER

PC-3000

- Provides eight slots for optional interface boards and one fixed output with 150 MHz cable compensation.
- Up to eight PC-3000 units can be connected, enabling up to 57 different signals to be connected in a system.
- In addition to its RS-232C/422A communication port, the PC-3000 is also equipped with a PJ COM port, in accordance with RS-485. This enables mutual communication between projectors and the PC-3000, expanding the versatility of system set-up.
- Incorporates an LCD display in the front panel for easier setting and adjustment.



- Input selection of a connected projector, as well as the input selection of the PC-3000 itself, can be controlled via the front panel.

◆ INTERFACE BOARDS

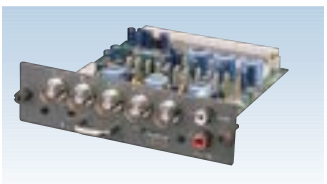

IFB-12A

- 5 BNC input/output
- Accepts analog RGB, component (Y/R-Y/B-Y), HDTV (Y/Pb/Pr, GBR), composite video and Y/C signals
- RGB bandwidth of 300 MHz
- Cable compensation function for output signals (150 MHz)

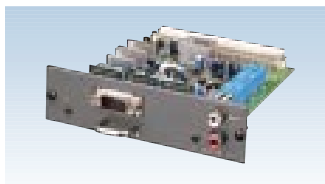

IFB-20

- Analog RGB input/output
- RGB bandwidth of 120 MHz

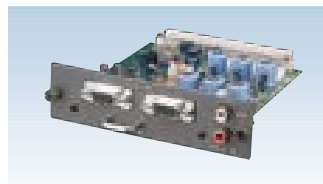

IFB-21

- Analog RGB input, with loop-through output (HD D-sub 15-pin)
- RGB bandwidth of 150 MHz

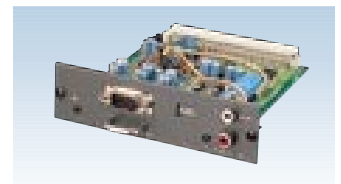

IFB-30

- Digital RGB input (D-sub 9-pin)
- Monochrome/ 8 color/ 16 color/ 64 color mode switchable
- RGB bandwidth of 30 MHz



IFB-50

- Component SDI BNC input/output
- Serial Digital Interface board for SMPTE 259 M-C/ ITU-R BT656-3 4:2:2 video signals



IFB-1000

- Composite/Y/C video input (Loop-through BNC/Loop-through Mini DIN 4-pin)

HDTV and DTV Signal Chart

System	Scanning Rate (kHz)	Frame Rate (Hz)*	Scanning Format	Aspect	Standard
1035/60i	33.75	30	2:1 interlace	16:9	BTA S-001B
1080/60i	33.75	30	2:1 interlace	16:9	SMPTE 274M/BTA S-001B
480/60p	31.5	60	Progressive	16:9/4:3	SMPTE 293M
1080/48i	27	24	2:1 interlace	16:9	—
1080/50i	28.13	25	2:1 interlace	16:9	SMPTE 274M
720/60p	45	60	Progressive	16:9	SMPTE 296M
720/50p	37.5	60	Progressive	16:9	—

*Each of the above frame rates is also compatible with 1/1.001.

◆ INTERFACE CABLES



SIC-20A/20B/20C

- Analog RGB
- D-sub 9-pin (female) to D-sub 9-pin (female)/D-sub 9-pin (male)
- Length: overall 2 m (6.6 ft) branch 0.2 m (0.7 ft)

SIC-21

- Analog RGB
- D-sub 9-pin (female) to D-sub 9-pin (female)/D-sub 9-pin (male)
- Length: overall 2 m (6.6 ft) branch 0.2 m (0.7 ft)

SIC-22

- Analog RGB with digital sync
- D-sub 9-pin (female) to D-sub 15-pin High Density (female)/D-sub 15-pin High Density (male)
- Length: overall 2 m (6.6 ft) branch 0.2 m (0.7 ft)



SMF-401

- HD D-sub 15-pin to HD D-sub 15-pin
- Length: overall 2 m (6.6 ft)

SMF-400

- HD D-sub 15-pin to BNC x5
- Length: overall 2 m (6.6 ft)

RCC-5G/10G/30G

- D-sub 9-pin to D-sub 9-pin
- Remote cable for RS-422A
- Length: 5, 10, and 30 m

◆ OTHER ACCESSORIES

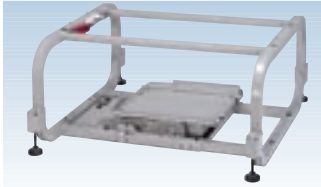

SU-PJ2000

Projector stand
(for twin and triple stacking)

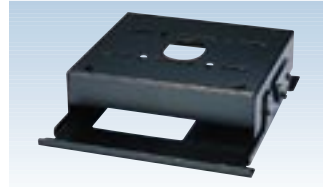

PSS-2000

Suspension support



PSS-10

Suspension support



VPS-100FH

100-inch flat screen*

VPS-120FH

120-inch flat screen*

*viewable area, measured diagonally

◆ VPL-FE100 INPUT SIGNAL PRESET DATA

Memory No.		Preset Signal	fH (kHz)	fV (kHz)	H/V Polarity	Size
1	VIDEO	60 Hz	15.734	59.940	N/N	-
2		50 Hz	15.625	50.000	N/N	-
3	15 kHz RGB	480/60i	15.734	59.940	S on G	-
4		575/50i	15.625	50.000	S on G	-
5	HDTV/DTV	1035/60i, 1080/60i	33.750	60.000	S on G	1543
6	640x350	VGA-1 (VGA350)	31.469	70.086	P/N	800
7		VESA 85 (VGA350)	37.861	85.080	P/N	832
8	640x400	NEC PC98	24.823	56.416	N/N	848
9		VGA-2 (TEXT)/VESA70	31.469	70.086	N/P	800
10		VESA 85 (VGA400)	37.861	85.080	N/P	832
11	640x480	VESA 60	31.469	59.940	N/N	800
12		Mac 13	35.000	66.667	S on G	864
13		VESA 72	37.861	72.809	N/N	832
14		VESA 75 (IBM M3)	37.500	75.000	N/N	840
15		VESA 85 (IBM M4)	43.269	85.008	N/N	832
16	800x600	VESA 56	35.156	56.250	P/P	1024
17		VESA 60	37.879	60.317	P/P	1056
18		VESA 72	48.077	72.188	P/P	1040
19		VESA 75 (IBM M5)	46.875	75.000	P/P	1056
20		VESA 85	53.674	85.061	P/P	1048
21	832x624	Mac 16	49.724	74.550	N/N	1152
22	1024x768	VESA 43 (8514)	35.524	43.479	P/P	1264
23		VESA 60	48.363	60.004	N/N	1344
24		VESA 70	56.476	69.955	N/N	1328
25		VESA 75	60.023	75.029	P/P	1312
26		VESA 85	68.677	84.997	P/P	1376

Memory No.		Preset Signal	fH (kHz)	fV (kHz)	H/V Polarity	Size
27	1152x864	VESA 70	63.995	70.019	P/P	1472
28		VESA 75	67.500	75.000	P/P	1600
29		VESA 85	77.487	85.057	P/P	1568
30	1152x900	SUN LO	61.795	65.960	N/N	1504
31		SUN HI	71.713	76.047	C Neg	1472
32	1280x960	VESA 60	60.000	60.000	P/P	1800
33		VESA 75	75.000	75.000	P/P	1728
34	1280x1024	VESA 43	46.433	43.436	P/P	1696
35		SGI-5	53.316	50.062	S on G	1680
36		VESA 60	63.974	60.013	P/P	1696
37		SXGA VESA 75	79.976	75.025	P/P	1688
38		SXGA VESA 85	91.146	85.024	P/P	1728
39	1600x1200	UXGA VESA 60	75.000	60.000	P/P	1689
40		UXGA VESA 65	81.913	65.530	P/P	1689
41		UXGA VESA 75	93.750	75.000	P/P	1689
43	P. Component	480/60p (Progressive)	31.470	60.000	S on G	1605
44		575/50p (Progressive)	31.250	50.000	S on G	1616
45	HDTV/DTV	1080/50i	28.130	50.000		1852
47		720/60p	45.000	60.000		1736
48		720/50p	37.500	50.000		2084
49		1080/48i	27.000	48.000		1929

VPL-FE100U/FE100M

SPECIFICATIONS

OPTICAL	
Projection system:	3 LCD panels, 1 lens projection
LCD panel:	1.8-inch TFT LCD panel, 3,932,160 pixels (1,310,720 pixels x3), with Micro Lens Array
Lamp:	120 W UHP lamp (x4)
Light output:	3200 ANSI lumens** (typical)
Projection picture size:	40 to 500 inches (viewable area, measured diagonally)
GENERAL	
Color system:	NTSC/PAL/SECAM/NTSC4.43/PAL-M (automatically selected)
Resolution:	Video: 600 TV lines RGB: 1280 x 1024 pixels
Scanning frequency:	FH: 15 kHz - 100 kHz FV: 40 Hz - 120 Hz Display area: >6.4 μsec.
Speaker:	5 W stereo
Power requirements:	VPL-FE100U: AC 100 to 240 V, 50/60 Hz (UL listed for AC 120 V operation only) VPL-FE100M: AC 220 to 240 V, 50/60 Hz
Power consumption:	VPL-FE100U: 770 W (Max.), 15 W (Standby) VPL-FE100M: 770 W (Max.), 20 W (Standby)
Heat dissipation:	2628 BTU
Dimensions:	562 (W) x 237 (H) x 649 (D) mm (22 1/4 x 9 3/8 x 25 5/8 inches)
Mass:	Approx. 34.5 kg (75 lb 14 oz)
Operating temperature:	0 to 40°C (32 to 104°F)
Operating humidity:	35 to 85% (no condensation)
Storage temperature:	-20 to 60°C (-4 to 140°F)
Storage humidity:	10 to 90%
INPUTS/OUTPUTS	
VIDEO IN Composite video:	Loop-through BNC 1.0 Vp-p ± 2 dB sync negative, 75 Ω
S VIDEO IN Y IN: C IN:	BNC 1.0 Vp-p ± 2 dB sync negative, 75 Ω BNC Burst 0.286 Vp-p ± 2 dB (NTSC), 75 Ω or 0.3 Vp-p ± 2 dB (PAL), 75 Ω
Y/C IN: Y (luminance): C (chrominance):	Loop-through Mini DIN 4-pin 1.0 Vp-p ± 2 dB sync negative, 75 Ω Burst 0.286 Vp-p ± 2 dB (NTSC), 75 Ω or 0.3 Vp-p ± 2 dB (PAL), 75 Ω
AUDIO IN:	Phono, stereo, 500 mV rms, impedance more than 47 kΩ
INPUT A	
Analog RGB/Component:	BNC x 5
R/R-Y:	0.7 Vp-p ± 2 dB positive, 75 Ω
G:	0.7 Vp-p ± 2 dB positive, 75 Ω
G with sync/Y:	1.0 Vp-p ± 2 dB sync negative, 75 Ω
B/B-Y:	0.7 Vp-p ± 2 dB positive, 75 Ω
SYNC/HD	
Composite sync:	0.6 - 8.0 Vp-p high impedance, sync positive/negative
Horizontal sync:	0.6 - 8.0 Vp-p high impedance, sync positive/negative
VD	
Vertical sync:	0.6 - 8.0 Vp-p high impedance, sync positive/negative
HDTV (Y/Pa/Ps): Y:	BNC 1.0 Vp-p ± 2 dB positive, 75 Ω, Tri-level sync: ±0.3 Vp-p Bi-level sync: 0.3 Vp-p
Pa/Ps:	±0.35 Vp-p ± 2 dB positive, 75 Ω
HDTV (GBR): G with sync:	BNC 1.0 Vp-p ± 2 dB, 75 Ω, Tri-level sync: ±0.3 Vp-p Bi-level sync: 0.3 Vp-p
B/R:	0.7 Vp-p ± 2 dB positive, 75 Ω
AUDIO IN:	Phono, stereo, 500 mV rms, impedance more than 47 kΩ

AUDIO OUT:	Phono, Max. 1 V rms when input is 500 mV rms, impedance more than 1 kΩ
INPUT B/C:	Open for optional IFB board
CONTROL S IN/ PLUG IN POWER:	Stereo mini jack 5 Vp-p, Plug in power DC 5 V maximum output 60 mA
CONTROL S OUT:	Stereo mini jack 5 Vp-p
REMOTE RS-232C/ RS-422A**: PJ COM**:	D-sub 9-pin (female) D-sub 9-pin x2 (female)
TRIG:	Mini jack Power ON: 12 V, output impedance 4.7 kΩ Power OFF: 0 V

SAFETY REGULATIONS

VPL-FE100U: UL 1950, cUL 950, FCC Class A, IC Class A
VPL-FE100M: EN 60 950 (TUV), CE, C-tick

ACCESSORIES

SUPPLIED ACCESSORIES:	Remote commander RM-PJ1001 Remote commander cable (15 m) Size AA (R6) battery (x3) AC power cord PJ COM termination Lens ring Operation manual
OPTIONAL ACCESSORIES:	Projector quadruple lamp (for replacement) LMP-Q120 Projector individual lamp LMP-S120 1.3 times zoom standard focus lens VPLL-Z3020 1.3 times zoom standard focus lens VPLL-Z2019 1.6 times zoom long focus lens VPLL-Z2025 1.5 times zoom long focus lens VPLL-Z2039 Fixed long focus lens VPLL-3050 Fixed long focus lens VPLL-2075 Fixed short focus lens VPLL-2014 Fixed short focus lens VPLL-2009 Stack stand (for twin and triple stacking) SU-PJ2000 Suspension support PSS-2000 Suspension support PSS-10 Signal adaptor HD D-sub 15-pin→D-sub 9-pin (for SIC Cable) ADP-10 Signal adaptor Macintosh→VGA ADP-20 D-sub HD 15-pin→5 BNC cable SMF-400 D-sub HD 15-pin→D-sub HD 15-pin SMF-401 Interface board IFB-12A/20/21/30/50/1000 Signal interface cable SIC-20A/20B/20C/21/22 Signal interface switcher PC-3000 9-pin remote cable RCC-5G/10G/30G (for RS-422A) Remote commander RM-PJ3000S** Remote control receiver RM-PJ10 100-inch flat screen VPS-100FH** 120-inch flat screen VPS-120FH**

DIMENSIONS

unit: mm (inches)

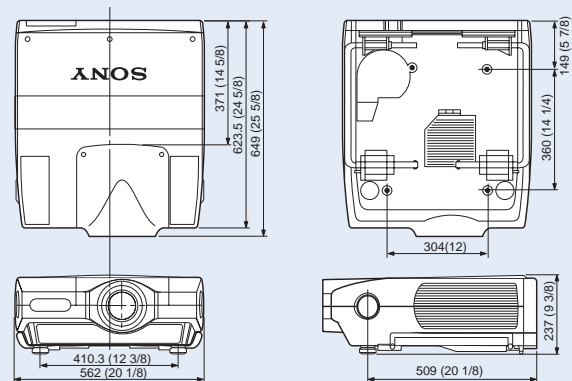

** ANSI lumens is a measuring method of the American National Standards Institute ANSI I17.228.

** RS-232C/RS-422A selectable.

** PJ COM complies with RS-485.

** Laser Type: Class II

Wavelength: 645 nm

Output: 1 mW

** Not available in some areas. For details, please contact your nearest Sony office.

©1999 Sony Corporation. All rights reserved.

Reproduction in whole or in part without written permission is prohibited.

Features and specifications are subject to change without notice.

All non-metric weights and measures are approximate.

Sony is a registered trademark of Sony Corporation.

Macintosh is a registered trademark of Apple Computer, Inc.

All other trademarks are the property of their respective owners.

Distributed by