

SONY[®]

Professional Flat Panel Monitors

PFM Series

PFM-500A2W/PFM-510A1W





Professional
Monitors That Will
Capture Your
Imagination



The professional viewing world of tomorrow will be flat - and today, the Sony PFM Series takes flat panel image display to the next level of innovation.

This exceptional range incorporates newly developed 42-inch*, 16:9 aspect flat panels to display crisp direct-viewing images. Each lightweight and thin flat panel extends the flexibility of monitor applications beyond those previously imaginable.

The PFM Series also delivers the special features that professionals count on from Sony. A built-in scan converter handles various signal inputs with superb versatility, while Four-Line Vertical Interpolation reproduces every nuance of the original source. In addition, the option slot provides greater system versatility with optional adaptors. The Sony PFM Series includes two models: PFM-500A2W, with brilliant flat panels of 852 x 480 pixels, and PFM-510A1W, with high-resolution panels of 1024 x 1024 pixels. Whether they're used as multi-source information monitors, presentation monitors or wall-mounted video displays, the Sony PFM Series gives you an exciting visual tool that will expand your application horizons.**

*** Viewable area, measured diagonally**

**** PFM-500A2WU and PFM-510A1WU models are available and may only be purchased in countries operating at AC 100-120 V; PFM-500A2WE and PFM-510A1WE models are available and may only be purchased in countries operating at AC 220-240 V.**

PFM-500A2W

Versatile and Flat Information Solution



New Brighter Flat Panel

The PFM-500A2W incorporates a newly developed brighter flat panel. Now you can view clearer, brighter images than ever before. The front filter glass of the panel has a non-glare finish that reduces diffused light reflection.

Advanced Scan Converter

The PFM-500A2W is equipped with an advanced scan converter, which includes variable and offset phase sampling and Four-Line Vertical Interpolation technologies. As such, it performs image conversion more accurately than is possible with conventional scanning methods.

This scan converter can intelligently reproduce a wide range of existing video signals (NTSC, PAL, HDTV) and computer signals with horizontal frequencies ranging from 15.6 to 100.0 kHz.

Four-Line Vertical Interpolation reproduces optimum images from various computer signals by utilizing the data of four lines from the original signal to generate each interpolated line.



Four-Line Vertical Interpolation

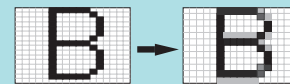

Output signal on a single horizontal line is recreated from neighbor four line informations

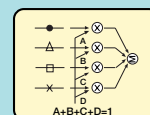

PFM Series Features for Superior Performance

Option Slot

The option slot gives the PFM Series tremendous flexibility in combination with the optional adaptor.

Since optional plug and play adaptors can be added, the range of PFM Series applications will continue to grow.



Easy Handling

Each PFM Series monitor is equipped with four carrying handles on the rear side. With unique retractable feet, the monitor can be moved and installed with a minimum of effort and with no additional devices.



Flat Panel Advantages

These monitors adopt a new-generation display device: the Plasma Display Panel - innovative flat panel technology that's sure to transcend your expectations.



- **Lightweight & compact design**

The thin and lightweight flat panel gives PFM Series monitors a compact body. Thus, superb images can be enjoyed with a minimal space requirement.

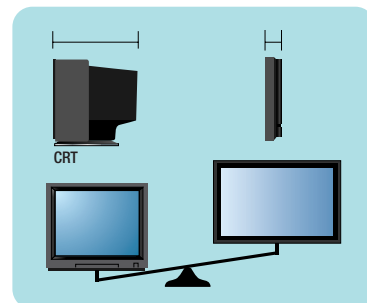

- **Clear and even pictures**

Because of the linear alignment of the light-emitting pixels, accurate pictures are reproduced without distortion.

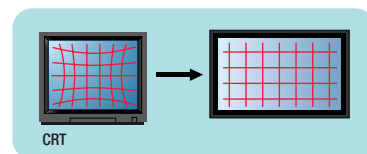

- **Wide viewing angle**

There is a wide viewing angle of 160 degrees in all directions. The clear pixel-by-pixel images appeal to large audiences in many different applications.

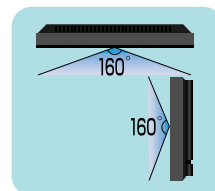

- **Resistance to magnetic influence**

Flat panel monitors can be installed in areas where the effects of magnetic field are prevalent, without experiencing interference such as color uniformity drift. These effects are caused by equipment employing magnets such as motors or speakers, or high-tension electrical wires. Unlike conventional CRTs, flat panels are free from such disturbances.

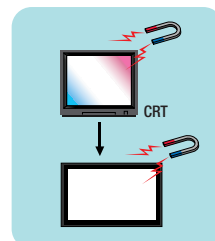

PFM-510A1W



Bright and Precise Visual Experience

Incorporating the superior features of the Sony PFM Series, the PFM-510A1W provides an impressive visual experience with its newly developed high-resolution, bright flat panel. Together with Four-Line Vertical Interpolation image enhancing technology, the PFM-510A1W performs as an effective visual presentation tool with its superior picture performance.



High Resolution Flat Panel

The PFM-510A1W incorporates a high resolution flat panel with 1024 x 1024 pixels, providing an impressive visual experience with bright, sharp clarity and dramatic fine detail. The high-resolution panel used in the PFM-510A1W also achieves even higher brightness. Consequently, this high performance monitor clearly displays any high definition source.

High Performance Scan Conversion

The PFM-510A1W incorporates advanced Sony picture enhancing technology. A high performance scan converter handles signals with horizontal frequencies ranging from 15.6 to 80.0 kHz. Scan conversion, performed with the Four-Line Vertical Interpolation algorithm, results in optimum signal reproduction for this high-resolution flat panel.



Additional Features

In addition to the above features, the PFM Series offers a range of features that are of key importance to professional applications.

- Five-Language On-Screen Display
English, French, German, Italian and Spanish.
- Picture control
- Size control
Picture size is adjustable, both horizontally and vertically.
- Selectable aspect ratio
The aspect ratio is selectable between widescreen 16:9 and standard 4:3 aspect ratios.
- Picture ZOOM/STILL function*
- Easy maintenance access
 - Self diagnosis function
STATUS Menu / Service code indicator / RS-232C port
 - Detachable power supply block
 - Easily accessible cooling fan; enables quick and easy maintenance.
- Memory save/load
Primary set-up data is saved in the internal memory and loaded when necessary.
- Various remote control capabilities
The PFM Series can be controlled by the Sony RM-921 Remote Commander (supplied) or via CONTROL S or RS-232C.
- Wide range of power supplies
Switchable automatically between AC 100 to 120 V and AC 220 to 240 V (UL listed for 100 to 120 V operation).
- 7 W + 7 W built-in amplifier
- Audio Monitor Out
For connection to external audio equipment.

*Available only for the PFM-500A2W



On-Screen Display



RM-921 Remote Commander



Control panel

Optional Accessories



BKM-501D

SDI 4:2:2 Input Adaptor

- Enables SDI video and audio decoding in compliance with SMPTE 259M/ITU-R BT.656
- Analog input capability: VIDEO (composite, Y/C, YUV, RGB), HDTV (Y/P_B/P_R) and PC (RGB, HD/VD (5 BNC))
- Self-diagnosis function



MB-514

Mounting Bracket

- For wall-mounting installation
- Monitors can be tilted 0° to 20° degrees downward from the wall in 7 locking steps for added safety
- Separate parts for easy installation
- Shock-absorbing gas damper for safety operation

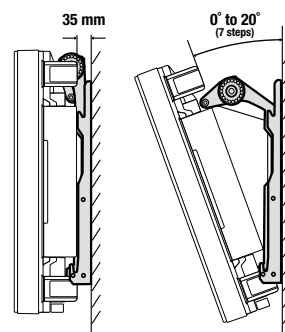

SS-X500A

Speaker System (PAIR)

- Can be attached to the monitor or mounted separately in a variety of position.
- Effective frequency range: 70 Hz to 20000 Hz
- Characteristic sensitivity level: 88 dB (1 W, 1 m)
- Input capability: 120 W

Dimensions: 159 (W) x 634 (H) x 90.3 (D) mm
(2 1/4 x 25 x 3 5/8 inches)

Mass: Approx. 3.5 kg per speaker
(Approx. 7 lb 11 oz)

Specifications

		PFM-500A2W	PFM-510A1W
Picture performance			
Panel	Resolution	852 x 480 pixels	1024 x 1024 pixels
	Pixel pitch	1.08 x 1.08 mm	0.90 x 0.51 mm
	Active area (W/H)	920 x 518 mm	
	Viewable picture area	42 inch/1,056 mm (measured diagonally)	
	Driver	8-bit RGB	10-bit RGB
	Colors	16.8 million colors simultaneously	
	Type	AC-type Plasma Display Panel with anti-glare screen	AC-type Plasma Display Panel with anti-reflection screen
Color system		NTSC/PAL (Composite, Y/C, YUV, RGB), HDTV (Y/PB/PR, RGB)	
Capture range	fH	15.6 kHz to 100 kHz	15.6 kHz to 80 kHz
	fV	48 Hz to 120 Hz	
Sampling rate		12.5 to 50 MHz offset phase max.	
Preset signals		12 formats	
Input/Output			
RGB 1	BNC connectors		
	RGB	0.714 Vp-p/non-composite, 1 Vp-p/composite, 75 Ω automatic termination, loop-through	
	YUV	0.7 Vp-p/non-composite (U/V), 1 Vp-p/composite (Y), 75 Ω automatic termination, loop-through	
	HD/COMP, VD	H (or composite) sync, V sync, 1 - 5 Vp-p, 75 Ω high impedance, loop-through	
	Audio (L/R)	Phono, 500 mV rms, high impedance, loop-through	
RGB 2	D-sub 15-pin connector		
	RGB	0.714 Vp-p/non-composite, 75 Ω, 1 Vp-p/composite,	
	External sync	H (or composite) sync, V sync, 1 - 5 Vp-p, 75 Ω high impedance	
	Audio (L/R)	Phono, 500 mV rms, high impedance,	
LINE	Composite	BNC connector, 1 Vp-p, sync negative, 75 Ω automatic termination, loop-through	
	Y/C	Mini DIN 4-pin connector, Y: 1 Vp-p, sync negative, C: 0.286 Vp-p (NTSC)/0.3 Vp-p (PAL), 75 Ω automatic termination, loop-through	
	Audio (L/R)	Phono, 500 mV rms, high impedance, loop-through	
	Sync signal		
			External H/V separate sync or composite sync, Sync-on-Green, automatic or manual selectable
			* Tri-level sync is available for HDTV
Audio output	Speakers terminal	6 to 16 Ω, 7 W + 7 W (at 8 Ω)	
	Monitor out (L/R)	Phono, 500 mV rms at Volume max., attenuation 0 dB to ∞ (variable), total harmonic distortion less than 1 %	
Remote	RS-232C	Mini DIN 8-pin	
	Control S IN/OUT	Stereo Mini jack, 5 Vp-p	
General			
Power requirements /consumption		AC 100 to 120 V/220 to 240 V ±10 %, 50/60 Hz U model: 100 to 120 V, 3.9 A, 380 W E model: 220 to 240 V, 2.0 A, 360 W	
Operating temperature		0° to 35°C (32° to 95°F)	
Storage temperature		-10° to 40°C (14° to 104°F)	
Humidity		0 % to 90 %, no condensation	
Dimensions (W/H/D)		1036 x 636 x 152 mm (40 3/4 x 25 x 6 3/4 inches)	
Mass		Approx. 45 kg (Approx. 99 lb 3 oz)	
Supplied accessories			
AC power cord (1)/AC plug holder (1)/Remote commander RM-921 with two AA (R6) batteries (1)/Connector cover (2)/Foot support bracket (2)/Ferrite core (2)/Operation manual (1)			
Regulation compliance			
UL 1950 listed, CSA 22.2 No.950, TÜV EN 60 950 (CE LVD), C-Tick, FCC Class A, DOC Class A, CE EN 55 022 Class-A/EN 50 082-2/EN 60 555-2, VCCI-A			

Preset signals				
	INPUT	fH(kHz)	fV(Hz)	Resolution
1	NTSC (Composite)	15.734	59.940	525 lines
	NTSC (Y/C)			
	Component (60) RGB (60)			
2	PAL (Composite)	15.625	50.000	625 lines
	PAL (Y/C)			
	Component (50) RGB (50)			
3	VGA (Graphic)	31.469	59.940	640 x 480 dots
4	VGA (Text)	31.469	70.087	720 x 400 dots
5	HDTV	33.750	60.000, 59.940	1125 lines
6	Mac 13"	35.000	66.670	640 x 480 dots
7	VESA 800 x 600	37.880	60.320	800 x 600 dots
8	VESA 1024 x 768	48.360	60.000	1024 x 768 dots
9	Mac 16"	49.727	74.553	832 x 624 dots
10	ATI 1280 x 1024	63.950	59.940	1280 x 1024 dots
11	Mac 21"	68.680	75.060	1152 x 870 dots
12	VESA 1280 x 1024	79.976	75.025	1280 x 1024 dots

Dimensions

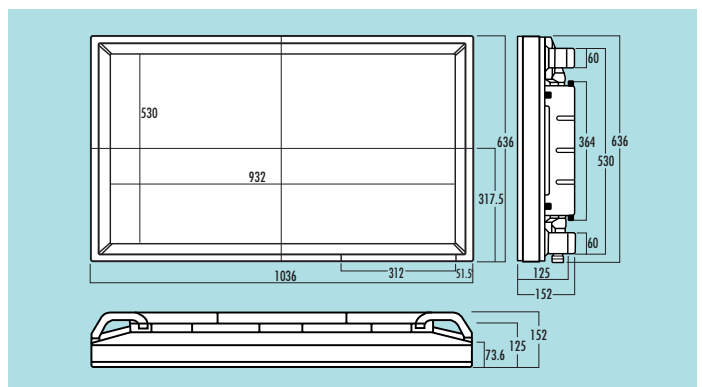

Distributed by

© 1999 Sony Corporation. All rights reserved.
 Reproduction in whole or in part without permission is prohibited.
 Features and specifications are subject to change without notice.
 All non-metric weights and measures are approximate.
 Sony is a registered trademark of Sony Corporation.
 Macintosh and Mac are registered trademarks of Apple Computer, Inc.

Printed in Japan