

# SONY®

SONY 3CCD Color Video Camera

# DXC-990/990P DXC-390/390P



# Sales Manual

Internal Use Only



# CONTENTS

---

1. PRODUCT CONCEPT	P. 2
2. APPLICATIONS	P. 3
3. KEY FEATURES	P. 4
4. MENU FUNCTION	P. 14
5. CAMERA CONNECTORS	P. 19
6. CONNECTOR PIN ASSIGNMENTS	P. 21
7. SPECIFICATIONS	P. 23
8. OPTIONAL ACCESSORIES	P. 25
9. SYSTEM EXAMPLES	P. 30
10. DIMENSIONS	P. 33
11. COMPARISON CHART	P. 36
12. TECHNICAL APPENDIX	P. 38
13. Q & A	P. 42



DXC-390/390P

DXC-990/990P

# 1. PRODUCT CONCEPT

## High performance/Low cost Multipurpose Video Camera

### DXC-990/990P

---

- Bayonet mount 3CCD
- High picture quality
- 1/2 type Exwave HAD® CCD
- Digital Signal Processor



### DXC-390/390P

---

- C mount 3CCD
- Compact Body
- 1/3 type Exwave HAD CCD
- Digital Signal Processor



## 2. APPLICATIONS

### Microscopy

Biotechnology  
Industrial Research



### Industrial Inspection

Printing  
Semiconductor

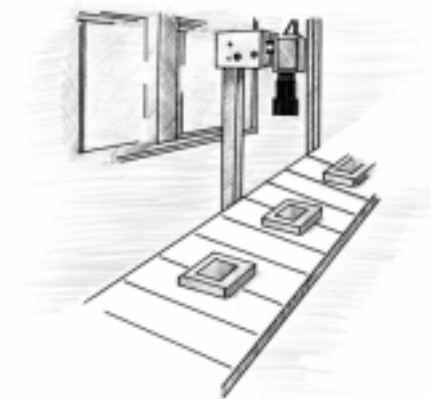

### Remote Camera

Distance Learning  
Surveillance  
Video Production

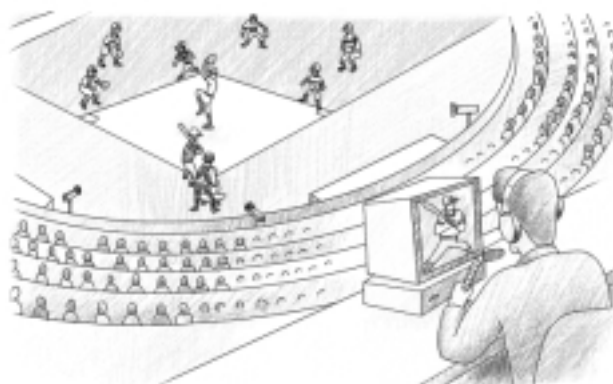

# 3. KEY FEATURES

## BASIC SPECIFICATIONS

	DXC-990/990P	DXC-390/390P
Horizontal Resolution	850 TV Lines	800 TV Lines
Signal to Noise Ratio	63 (NTSC) 62 (PAL) dB	62 (NTSC) 61 (PAL) dB
Sensitivity	F11@2000 lx (3200 K)	F8@2000 lx (3200 K)
Minimum Illumination	1 lx (F1.4, GAIN:HYPER)	4 lx (F2, GAIN:HYPER)
Output Signal	VBS, RGB/SYNC, Y/C, Y/R-Y/B-Y	RGB, Y/C, VBS
Dimensions	70 (W) x 72 (H) x 123.5 (D) mm	56 (W) x 50 (H) x 128 (D) mm
Power Consumption	Approx. 8.0 W	Approx. 7.6 W
Mass	630 g	Approx. 370 g

## FEATURES

### ■ DynaLatitude™ Function

- The DynaLatitude function processing enables you to adjust the contrast of each pixel according to the luminance signal level of each picture element.
- The DynaLatitude function minimizes video level distortion based on video signal histograms in order to utilize the limited dynamic range of the standard video signal.
- If there is a dark section and bright section in one image (i.e. shade and sunshine), then both parts will often look vague. The DynaLatitude function allows you to adjust the sharpness of both sections.
- Even when lighting is favorable, more luminance levels will be allocated to the subject, creating a clearer, more detailed image.

### ■ DynaLatitude Function

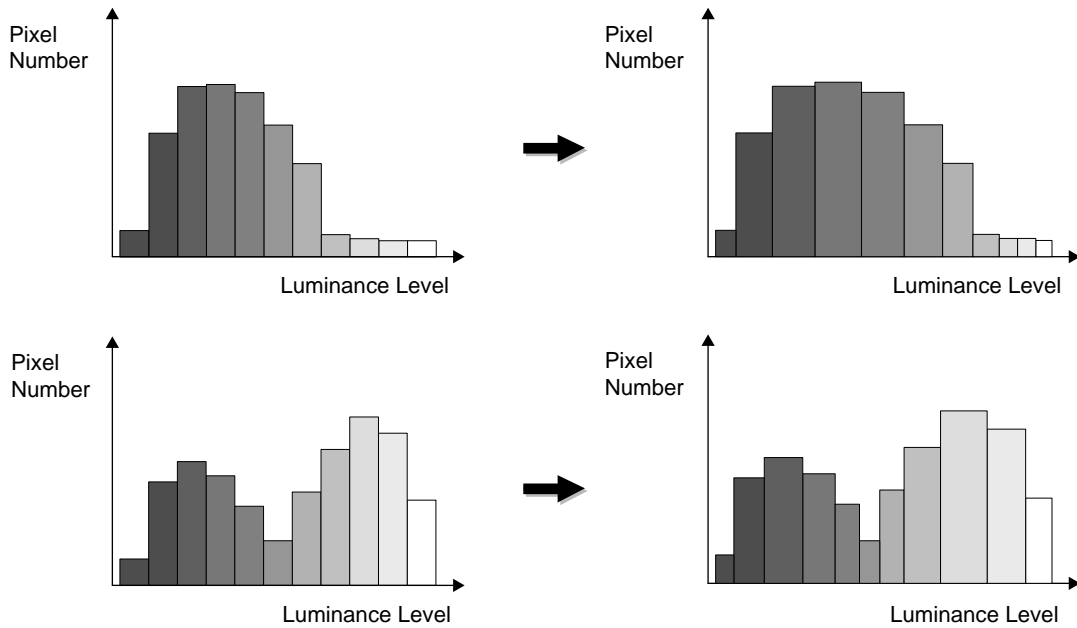

The diagrams above are based on estimations, not on actual operation.

### ■ DCC+ Process

- The DCC+ (Dynamic Contrast Control Plus) manages video signal data at three levels - brightness, hue and saturation. The result is an image with suitable knee correction and without hue distortion.

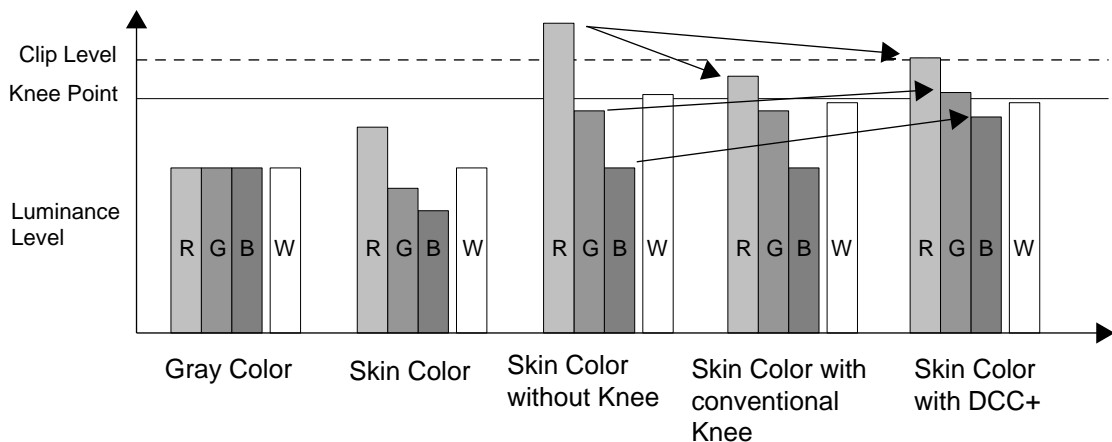

### 3. Key Features

---

#### ■ Knee and Black Stretch

- By adjusting the knee, a knee point and knee slope are set so that the highlighted areas of the picture can be clearly reproduced.
- Contrast in the dark area of the image can be variably adjusted using the Black Stretch function for a clear view of specific details.

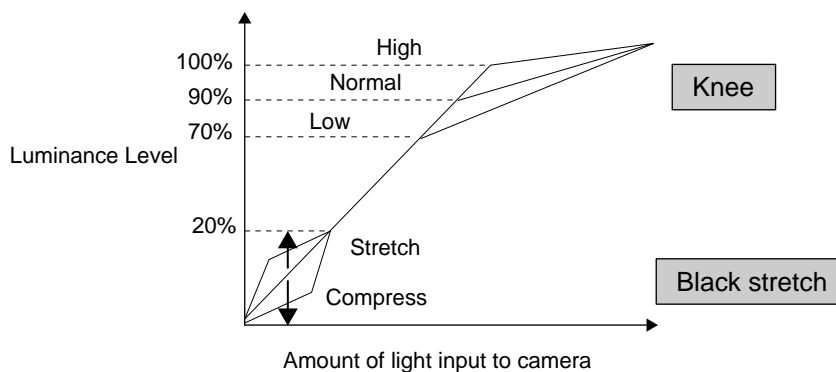

---

#### ■ Pedestal

- Black or dark parts of the picture can be clearly seen by adjusting the black level. Also the R and B pedestal level can be finely adjusted for each color.



## ■ Electronic Shutter Function

- The variable electronic shutter built into the CCD imager enables the DXC-990/990P and DXC-390/390P to capture clear images of moving objects. The shutter speed can be manually selected from a wide range of speeds (up to 1/100000).
- The Flickerless mode allows you to obtain flickerless images even in fluorescent lighting conditions.
- The Clearscan™ mode reduces the horizontal bands that appear in computer displays when shooting the display with a conventional video camera.

<Shutter speed calculation of Clearscan mode>

Example: When the value is set to 250 H

(NTSC)	$250 * 63.56 \text{ us (1 H)} + 34.78 \text{ us (constant)}$ $= 15924.78 \text{ us}$ $= 1/62.8 \text{ s}$
(PAL)	$250 * 64 \text{ us (1 H)} + 35.6 \text{ us (constant)}$ $= 16035.6 \text{ us}$ $= 1/62.4 \text{ s}$

## ■ Long Term Exposure Function

- When shooting very dark objects or objects in dark lighting conditions, you can manually set the shutter speed to 1/60 of a second or more to allow more light to accumulate on the CCD sensors, resulting in enhanced sensitivity.
- By synchronizing the WEN pulse of the camera signal output with an external memory unit such as a frame grabber unit/board, it is possible to obtain a still picture video.

<Shutter speed calculation of LTE mode>

Example: When the value is set to 5 FRM

(NTSC)	$5 * 1/30 = 0.167 \text{ s}$
(PAL)	$5 * 1/25 = 0.2 \text{ s}$

### 3. Key Features

---

#### ■ Digital Detail

- The detail function adjusts the sharpness of object outlines with minimal noise using digital signal processor technology
- The unique feature of the function is that the horizontal detail frequency can be changed.

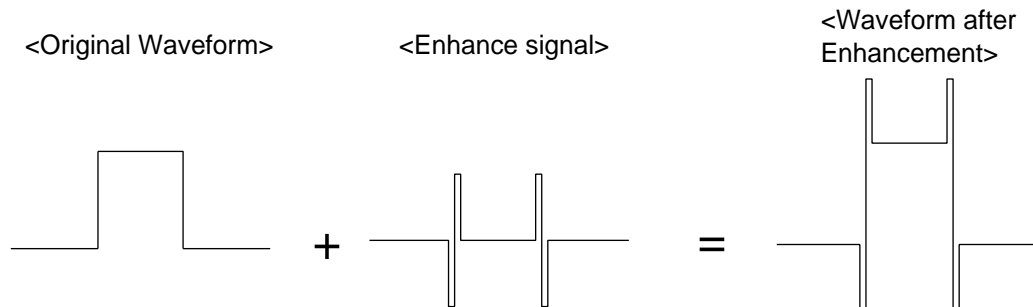

---

#### ■ Linear Matrix

- The Linear Matrix function provides sophisticated electronic adjustment for accurate color reproduction by adjusting color saturation and hue.
- Besides four preset settings, the R,G,B levels can be independently adjusted.

---

#### ■ Partial Enhance Function

- This function allows a particular color to be selected, and its hue, saturation and detail altered.
- In addition, the detail produced by the high resolution of the camera can be softened or emphasized in certain parts of the image by Partial Enhance function.
- The designated active area can be set by simply adjusting the area detect cursor.

### ■ Color Shading Compensation

- The color shading compensation feature provides a uniformed brightness for images displayed on the screen.
- 

### ■ Versatile White Balance

- The ATW (Auto Tracing White balance) adjusts the white balance automatically in response to varying lighting conditions, and the AWB (Auto White Balance) automatically memorizes the adjusted white balance values.
  - This camera has two ATW modes. One is normal mode which is the same as other current DXC models. The other is wide mode which covers a wider range of color temperatures than normal mode.
  - The ATW areas can be set manually like AE areas.
  - When using AWB or ATW modes, red and blue levels can be adjusted by R/B paint.
  - In Manual mode, white balance can be adjusted in accordance with user requirements.
  - Settings of 3200K and 5600K are available.
- 

### ■ Hyper Gain (+30 dB)

- The Hyper Gain function increases the gain up to 32 times (+30 dB).

### 3. Key Features

---

#### ■ Flicker Cancellor

- The camera negates the flicker of fluorescent lights by automatically adjusting gain, freeing the electronic shutter for other use.
- Shutter speed range is approximately 1/60 - 1/250 s.
- Since adjustment is made within the gain circuit, this function may not work well in a strong-flicker environment such as under multiple fluorescent lights.

---

#### ■ Auto Exposure functions

- The DXC-990/990P and DXC390/390P have an AGC function which automatically boosts video gain and CCD IRIS function, automatically reducing the camera exposure time by changing the electronic shutter speed.
- The range of AGC is equivalent to an increase of four stops in a lens and the range of CCD IRIS is equivalent to a decrease of ten F stops.
- When the AGC and CCD IRIS functions are used together with an auto iris lens, the DXC-990/990P and DXC-390/390P can adjust themselves to a wide range of incoming light levels automatically.

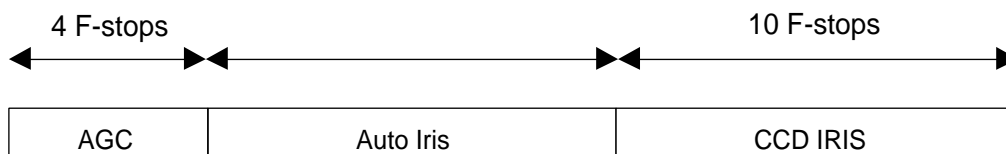

---

#### ■ Video Servo Auto Iris Lens (DXC-390/390P Only)

- There are two new motorized remote control lenses for the DXC-390/390P. This camera also accepts two general video servo lenses which is standard in the surveillance field.

## ■ User Defined Light Metering Area

- With the DXC-990/990P and DXC-390/390P, six patterns (light metering areas) -Multi, Large, Mid, Spot, Slit, and Manual area detect the brightness. These areas can be chosen according to the lighting conditions of the object.
- The Multi mode measures the luminance level on the 9 divided windows and the center window is weighted compared to the other windows.
- In Manual mode, the user can freely define the light metering area.

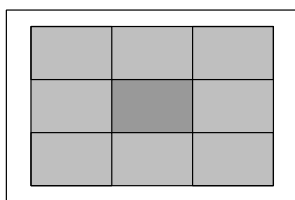

&lt;MULTI&gt;

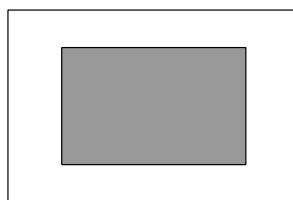

&lt;MID&gt;

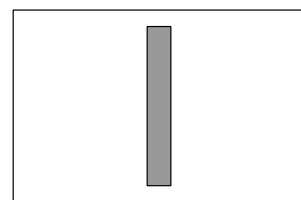

&lt;SLIT&gt;



&lt;LARGE&gt;

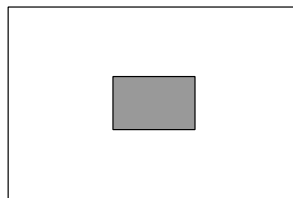

&lt;SPOT&gt;

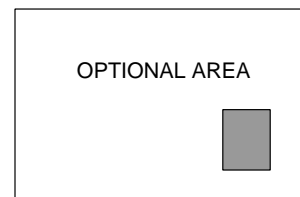

&lt;MANUAL&gt;

## ■ Selectable AE

- The AE speed of this camera is manually adjusted.
- The exposure level can be adjusted to either the average measurable range or to the peak (brightest) level.

### 3. Key Features

---

#### ■ CCD Integration Mode Selection

- The DXC-990/990P and DXC-390/390P have two methods to read out the accumulated CCD information: Frame or Field Integration.
  - The ability to switch between Frame or Field Integration can be an advantage in dealing with different subject material. For still image capture, Frame Integration offers advantages whereas Field Integration offers advantages for shooting moving objects.
- 

#### ■ Nega

- You can automatically shoot negative scenes as positive, or vice versa.
- 

#### ■ RGB sync

- In RGB sync mode, the sync signal is added not only for green but also for each RGB output.
- 

#### ■ User File

- The user file function can be used to store two sets of parameters (A or B) in the menu for instant recall. This feature is very useful for the operator who consistently uses the camera under the same conditions.
  - When pushing the FILE SELECT button, the user file switches between A and B.
- 

#### ■ Scene File

- The preset scene files are set to accommodate four different situations (STANDARD, MICROSCOPE, FULL AUTO, STROBE).
  - Copying the settings between two files is also possible.
-

### ■ RS-232C Interface

- The DXC-990/990P and DXC-390/390P are equipped with an 8-pin RS-232C interface, allowing the camera to be remotely controlled from external equipment such as a personal computer.
  - For the details of the RS-232C protocol, please refer to the Control Protocol or contact your nearest Sony office.
- 

### ■ Genlock Capability (VBS and HD/VD)

- The DXC camera can be synchronized with an external VBS signal from other equipment and includes a SC/H phase adjustment control. HD/VD sync signals also can be accepted. This is very useful in multiple camera operation and in connection with frame grabber boards.
- 

### ■ Strobe Function

- This feature is effective for image recognition of fast moving objects. The DXC-990/990P and DXC-390/390P synchronize the timing of the trigger with a strobe light and outputs a full frame image.
  - When connecting a frame grabber unit/board, the WEN pulse makes it easy to capture the image.
- 

### ■ Flange Back Adjustment (DXC-390/390P Only)

- It is possible to adjust the flange focal length of a lens by turning the ring. Allows for synchronization of eye piece focus to camera image.

# 4. MENU FUNCTION

## CONFIGURATION

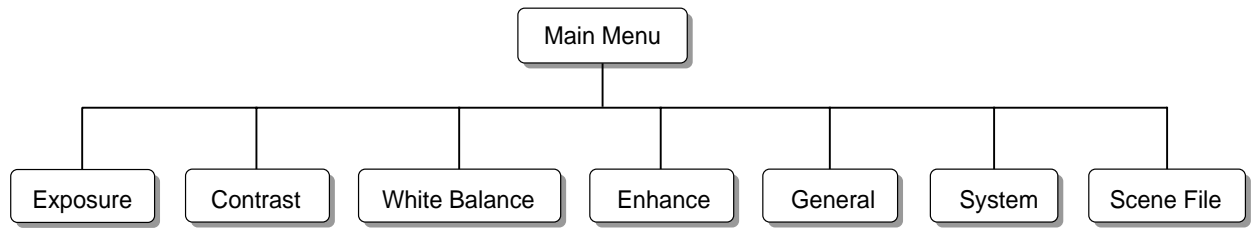

## MAIN MENU

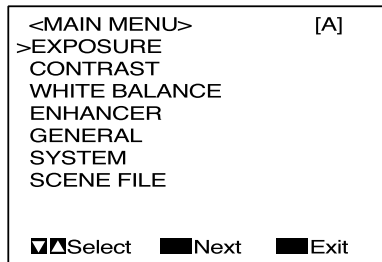

## SUB MENU

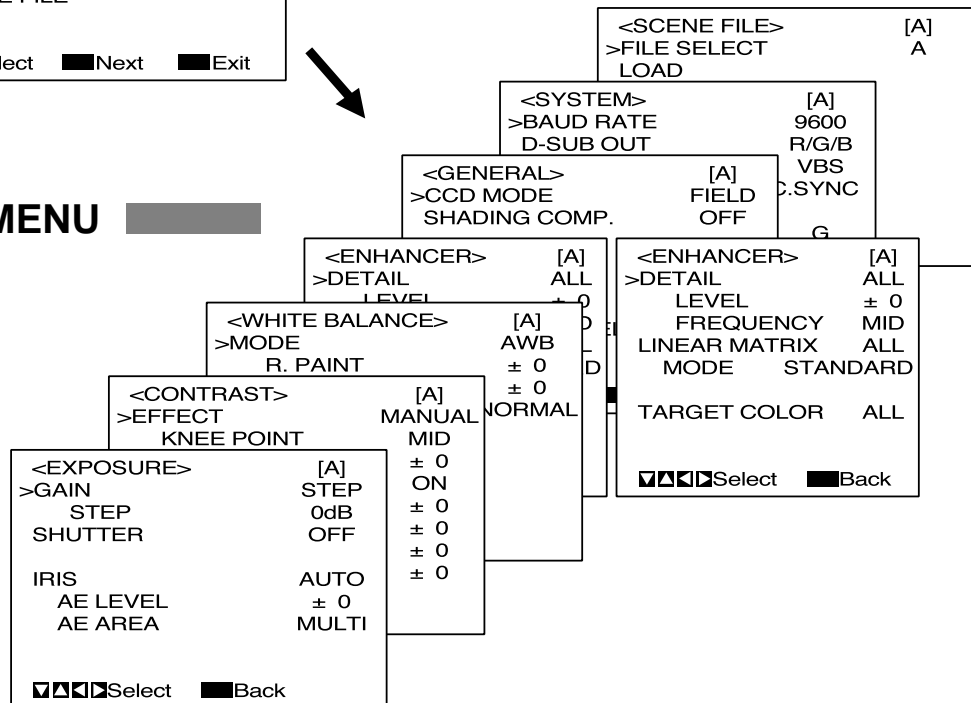





## SETTING ITEMS IN MENU

<EXPOSURE>	[A]
>GAIN	STEP
STEP	0dB
SHUTTER	OFF
IRIS	AUTO
AE LEVEL	± 0
AE AREA	MULTI
	

- GAIN Adjusts video gain
- STEP Sets the gain level
- SHUTTER Sets the modes for the electronic shutter
- SPEED Sets the shutter speed
- LENS Sets the iris mode
- IRIS Adjusts the iris automatically or manually
- AE LEVEL Finely adjusts the focusing point of AE adjustment
- AE AREA Sets the AE window in AGC, CCD IRIS or auto iris adjustment mode
- AE SPEED Sets AE focusing speed in AGC, CCD IRIS or auto iris control mode
- AE DETECT Sets the detection method of the luminance level of the selected AE window

<CONTRAST>	[A]
>EFFECT	MANUAL
KNEE POINT	MID
BLACK STRETCH	± 0
GAMMA	ON
LEVEL	± 0
MASTER PEDESTAL	± 0
R. PEDESTAL	± 0
B. PEDESTAL	± 0
	

- EFFECT Adjusts the picture contrast in accordance with the incident luminance level
- KNEE POINT Sets the knee point
- BLACK STRETCH Adjusts the luminance of dark portions on the screen
- GAMMA Activates gamma compensation
- LEVEL Adjusts the gamma level
- MASTER PEDESTAL Sets the pedestal level of the output signal
- R./B. PEDESTAL Finely adjusts the pedestal level

<WHITE BALANCE>	[A]
>MODE	AWB
R. PAINT	± 0
B. PAINT	± 0
AREA	NORMAL
	

- MODE Selects white balance modes
- R./B. PAINT or R./B. GAIN Finely adjusts white balance (AWB, ATW) or manual white balance (MANU)

## 4. Menu Function

### DXC-990/990P

<ENHANCER>	[A]
>DETAIL	ALL
LEVEL	± 0
FREQUENCY	MID
LINEAR MATRIX	ALL
MODE	STANDARD

### DXC-390/390P

<ENHANCER>	[A]
>DETAIL	ALL
LEVEL	± 0
FREQUENCY	MID
LINEAR MATRIX	ALL
MODE	STANDARD
TARGET COLOR	ALL

- DETAIL Enables or disables adjustment of sharpness of the image outline
- LEVEL Adjusts the sharpness of the image outline
- FREQUENCY Adjusts the sharpness of the detailed image outline
- LINEAR MATRIX Enables or disables processing of a color matrix
- MODE Finely adjusts the color tone
- TARGET COLOR Specifies the color for DETAIL or LINEAR MATRIX adjustments (DXC-990/990P Only)

<GENERAL>	[A]
>CCD MODE	FIELD
SHADING COMP.	OFF
TRIGGER	OFF
NEGA	OFF
FLICKER CANCELLER	OFF

- CCD MODE Selects the CCD read-out mode
- SHADING COMP Eliminates color at the top and bottom of the screen
- LEVEL Adjusts the SHADING level
- TRIGGER Sets the polarity when connecting a slave unit to synchronize with a stroboscope
- NEGA Reverses the output image to negative
- FLICKER CANCELLER Reduces flicker when SHUTTER is set to CCD IRIS or OFF

<SYSTEM>	[A]
>BAUD RATE	9600
D-SUB OUT	R/G/B
D-SUB VIDEO	VBS
D-SUB SYNC	C.SYNC
RGB SYNC	G
12P CONNECTOR	IN

- BAUD RATE Selects the baud rate
- D-SUB VIDEO Switches the video signal output from the D-sub 9-pin
- D-SUB SYNC Switches the sync signal from the D-sub 9-pin
- RGB SYNC Adds a sync signal to the RGB output
- 12P CONNECTOR Switches the input and output of the 12-pin connector and selects the output signal
- H.PHASE Adjusts the horizontal phase when using the camera with the external sync signal
- SC.PHASE ROUGH Roughly adjusts the subcarrier phase when using the camera with the external sync signal
- SC.PHASE FINE Finely adjusts the subcarrier phase

<SCENE FILE>	[A]
>FILE SELECT	A
LOAD	

- FILE SELECT Selects the file into which you store the setting
- LOAD Selects the type of setting to be stored, and loads it

## CONTENTS OF SCENE FILE

### DXC-990/990P

Scene File	Standard	Microscope	Full Auto	Strobe
<EXPOSURE> GAIN STEP/LIMIT SHUTTER SPEED/LIMIT IRIS AE LEVEL AE AREA AE SPEED AE DETECT	STEP 0dB OFF  AUTO +-0 MULTI	STEP 0dB CCD IRIS  MANUAL +-0 MID MID AVERAGE	AGC 24dB CCD IRIS 1/10000 AUTO +-0 MULTI	STEP 0dB OFF  MANUAL +-0 MID MID AVERAGE
<CONTRAST> EFFECT KNEE POINT BLACK STRETCH GAMMA  MASTER PEDESTAL R.PAINT B.PAINT	MANUAL MID +-0 ON +-0 +-0 +-0 +-0	DCC+  ON +-0 +-0 +-0 +-0	DYNALATITUDE  +-0 ON +-0 +-0 +-0	MANUAL MID +-0 ON +-0 +-0 +-0
<WHITE BAL> MODE R.PAINT/R.GAIN B.PAINT/B.GAIN AREA SPEED	AWB +-0 +-0 NORMAL	AWB +-0 +-0 NORMAL	ATW NORMAL +-0 +-0 NORMAL MID	MANUAL +-0 +-0
<ENHANCER> DETAIL LEVEL FREQUENCY L.MATRIX MODE TARGET COLOR	ALL +-0 MID ALL STANDARD ALL	ALL +-0 MID ALL STANDARD ALL	ALL +-0 MID ALL STANDARD ALL	ALL +-0 MID ALL STANDARD ALL
<GENERAL> CCD MODE SHADING COMP LEVEL TRIGGER POLARITY NEGA FLICKER CANCELLER	FIELD OFF  OFF  OFF OFF	FRAME ON +-0 OFF  OFF OFF	FIELD OFF  OFF  OFF ON	FRAME OFF  ON FALLING EDGE OFF OFF
<SYSTEM> BAUD RATE D-SUB OUT D-SUB VIDEO D-SUB SYNC POLARITY RGB SYNC 12P CONNECTER	9600 R/G/B VBS C.SYNC  G IN	9600 R/G/B Y/C C.SYNC  G IN	9600 R/G/B Y/C C.SYNC  G IN	9600 R/G/B Y/C WEN1 FALLING EDGE G IN

## 4. Menu Function

### DXC-390/390P

Scene File	Standard	Microscope	Full Auto	Strobe
<EXPOSURE> GAIN STEP/LIMIT SHUTTER SPEED/LIMIT LENS IRIS AE LEVEL AE AREA AE SPEED AE DETECT	STEP 0dB OFF  REMOTE AUTO +-0 MULTI	STEP 0dB CCD IRIS  REMOTE MANUAL +-0 MID MID AVERAGE	AGC 24dB CCD IRIS 1/10000 REMOTE AUTO +-0 MULTI	STEP 0dB OFF  REMOTE MANUAL +-0 MID MID AVERAGE
<CONTRAST> EFFECT KNEE POINT BLACK STRETCH GAMMA  MASTER PEDESTAL R.PAINT B.PAINT	MANUAL MID +-0 ON +-0 +-0 +-0 +-0 +-0	DCC+  ON +-0 +-0 +-0 +-0	DYNALATITUDE  +-0 ON +-0 +-0 +-0 +-0	MANUAL MID +-0 ON +-0 +-0 +-0 +-0
<WHITE BAL> MODE R.PAINT/R.GAIN B.PAINT/B.GAIN AREA SPEED	AWB +-0 +-0	AWB +-0 +-0	ATW NORMAL +-0 +-0 NORMAL MID	MANUAL +-0 +-0
<ENHANCER> DETAIL LEVEL FREQUENCY L.MATRIX MODE TARGET COLOR	ON +-0 MID ON STANDARD ALL	ON +-0 MID ON STANDARD ALL	ON +-0 MID ON STANDARD ALL	ON +-0 MID ON STANDARD ALL
<GENERAL> CCD MODE SHADING COMP LEVEL TRIGGER POLARITY NEGA FLICKER CANCELLER	FIELD OFF  OFF  OFF OFF	FRAME OFF  OFF  OFF OFF	FIELD OFF  OFF  OFF ON	FRAME OFF  ON FALLING EDGE OFF OFF
<SYSTEM> BAUD RATE D-SUB VIDEO D-SUB SYNC POLARITY RGB SYNC 12P CONNECTER	9600 VBS C.SYNC  G IN	* Y/C *  G *	* Y/C *  G *	* Y/C WEN FALLING EDGE G *

# 5. CAMERA CONNECTORS

## DXC-990/990P REAR PANEL

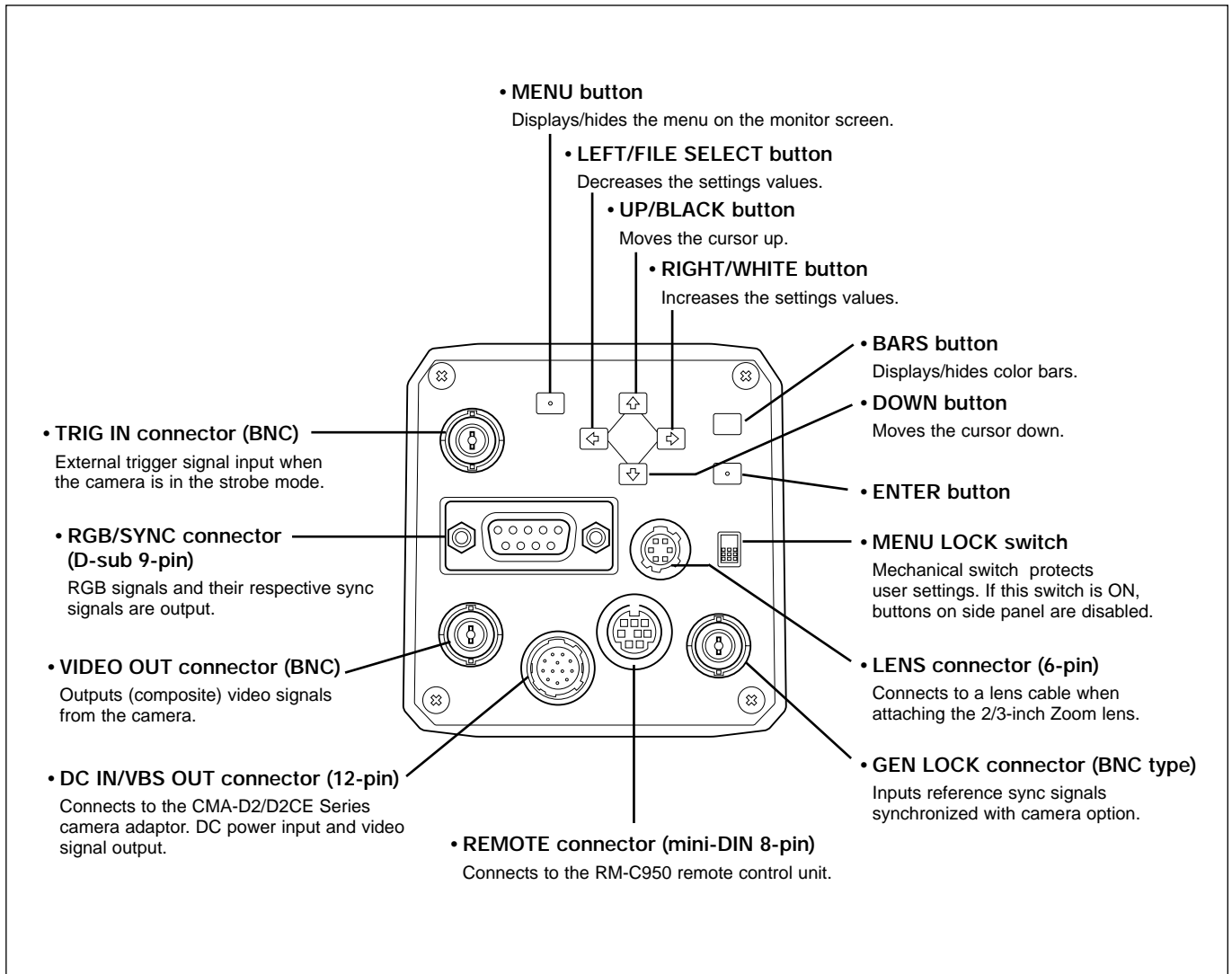

## DXC-390/390P REAR PANEL

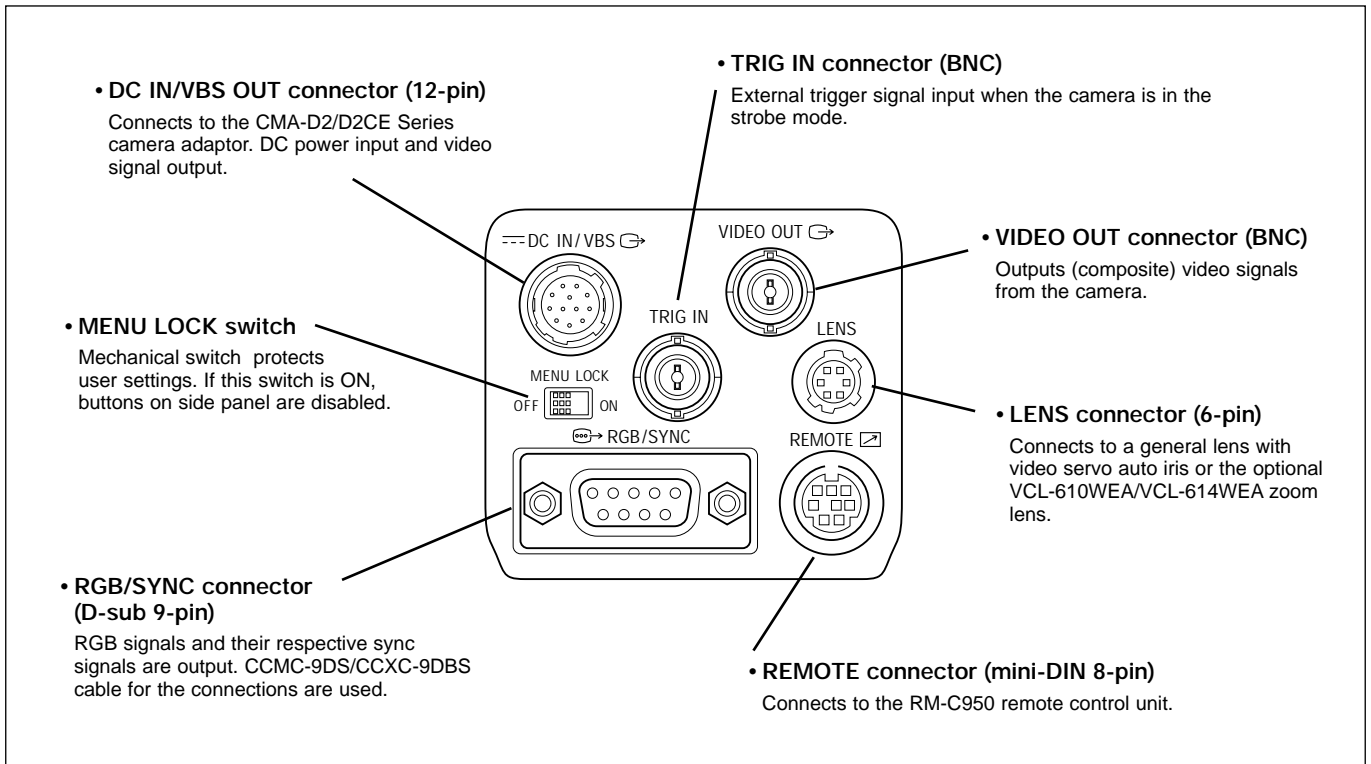

## DXC-390/390P SIDE PANEL

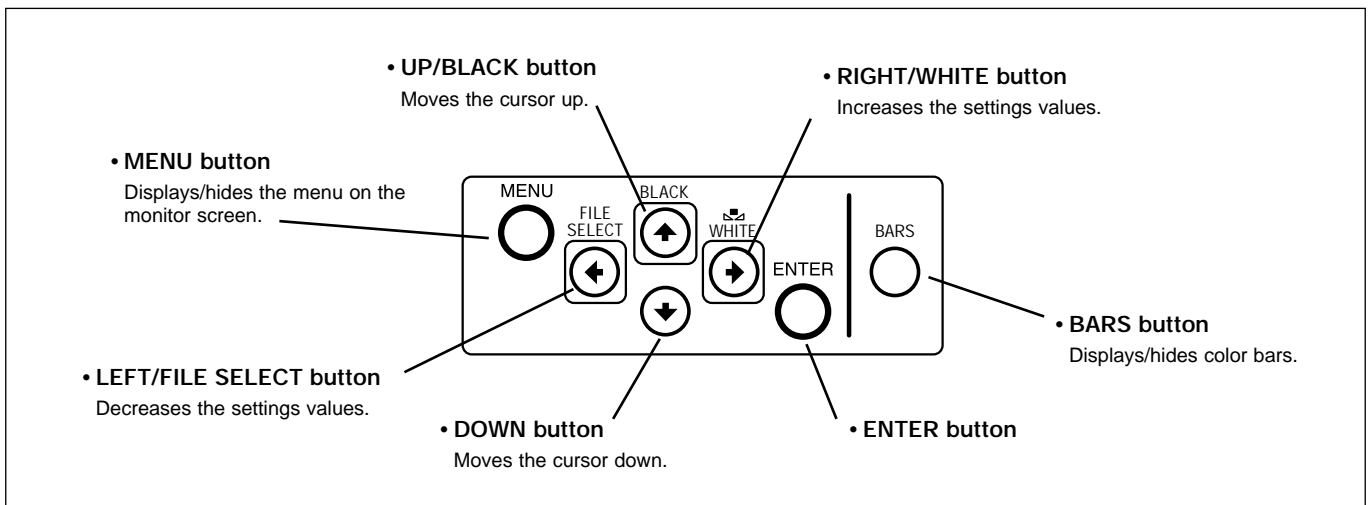

# 6. CONNECTOR PIN ASSIGNMENTS

## 12 PIN CONNECTOR

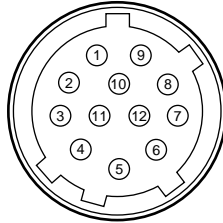

### DXC-990/990P and DXC-390/390P

MENU	D-sub VIDEO : VBS 12 pin connector : IN	D-sub VIDEO : VBS 12 pin connector : C. SYNC	D-sub VIDEO : VBS 12 pin connector : HD/VD	D-sub VIDEO : Y/C 12 pin connector : IN	D-sub VIDEO : Y/C 12 pin connector : C. SYNC	D-sub VIDEO : Y/C 12 pin connector : HD/VD
1	DC IN (G)	DC IN (G)	DC IN (G)	DC IN (G)	DC IN (G)	DC IN (G)
2	DC IN (+)	DC IN (+)	DC IN (+)	DC IN (+)	DC IN (+)	DC IN (+)
3	VBS OUT (G)	VBS OUT (G)	VBS OUT (G)	Y OUT (G)	Y OUT (G)	Y OUT (G)
4	VBS OUT (X)	VBS OUT (X)	VBS OUT (X)	Y OUT (X)	Y OUT (X)	Y OUT (X)
5	-HD IN (G)	- (G)	HD OUT (G)	-HD IN (G)	- (G)	HD OUT (G)
6	-HD IN (X)	- (X)	HD OUT (X)	-HD IN (X)	- (X)	HD OUT (X)
7	VBS/VD IN (X)	C. SYNC OUT (X)	VD OUT (X)	VBS/VD IN (X)	C. SYNC OUT (X)	VD OUT (X)
8	- (G)	- (G)	- (G)	C OUT (G)	C OUT (G)	C OUT (G)
9	- (X)	- (X)	- (X)	C OUT (X)	C OUT (X)	C OUT (X)
10	DC IN (G)	DC IN (G)	DC IN (G)	DC IN (G)	DC IN (G)	DC IN (G)
11	DC IN (+)	DC IN (+)	DC IN (+)	DC IN (+)	DC IN (+)	DC IN (+)
12	VBS/VD IN (G)	C.SYNC OUT (G)	VD OUT (G)	VBS/VD IN (G)	C.SYNC OUT (G)	VD OUT (G)

## 6 PIN CONNECTOR

### DXC-990/990P

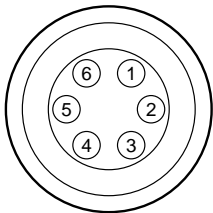

MENU	LENS : REMOTE
1	NC
2	NC
3	DC OUT (G)
4	INTERNAL CONNECT
5	IRIS CONTROL
6	DC OUT (+)

### DXC-390/390P

MENU	LENS : REMOTE	LENS : VIDEO
1	FOCUS CONTROL	NC
2	ZOOM CONTROL	NC
3	DC OUT (G)	DC OUT (G)
4	IRIS CLOSE	NC
5	IRIS CONTROL	VIDEO OUT
6	DC OUT (+)	DC OUT (+)

## 9 PIN D-SUB CONNECTOR

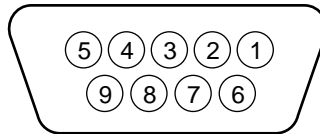

### DXC-990/990P

MENU	D-sub OUT :RGB D-sub VIDEO :VBS D-sub SYNC :C. SYNC	D-sub OUT :RGB D-sub VIDEO :VBS D-sub SYNC :WEN	D-sub OUT :Y/C D-sub VIDEO :VBS D-sub SYNC :C. SYNC	D-sub OUT :RGB D-sub VIDEO :Y/C D-sub SYNC :WEN	D-sub OUT :Y/CR/RGB D-sub OUT :Y/C D-sub SYNC :WEN	When using the CMA-D3/D3CE
1	VBS OUT (G)	VBS OUT (G)	Y/C OUT (G)	VBS OUT (G)	Y/C OUT (G)	- (G)
2	RGB OUT (G)	RGB OUT (G)	RGB OUT (G)	RGB OUT (G)	RGB OUT (G)	VBS/Y/C OUT (G)
3	R OUT (X)	R OUT (X)	R OUT (X)	R OUT (X)	CR OUT (X)	VBS OUT (X)
4	G OUT (X)	G OUT (X)	G OUT (X)	G OUT (X)	Y OUT (X)	Y OUT (X)
5	B OUT (X)	B OUT (X)	B OUT (X)	B OUT (X)	CB OUT (X)	C OUT (X)
6	VBS OUT (X)	VBS OUT (X)	Y OUT (X)	Y OUT (X)	Y OUT (X)	- (X)
7	C.SYNC OUT (X)	WEN OUT (X)	C.SYNC OUT (X)	WEN OUT (X)	WEN OUT (X)	WEN OUT (X)
8	C.SYNC OUT (G)	WEN OUT (G)	C.SYNC OUT (G)	WEN OUT (G)	WEN OUT (G)	WEN OUT (G)
9	- (X)	- (X)	- (X)	C OUT (X)	C OUT (X)	- (X)

### DXC-390/390P

MENU	D-sub VIDEO :VBS D-sub SYNC :C. SYNC	D-sub VIDEO :VBS D-sub SYNC :WEN	D-sub VIDEO :Y/C D-sub SYNC :C. SYNC	D-sub VIDEO :Y/C D-sub SYNC :WEN	When using the CMA-D3/D3CE
1	VBS OUT (G)	VBS OUT (G)	Y/C OUT (G)	Y/C OUT (G)	- (G)
2	RGB OUT (G)	RGB OUT (G)	RGB OUT (G)	RGB OUT (G)	VBS/Y/C OUT (G)
3	R OUT (X)	R OUT (X)	R OUT (X)	R OUT (X)	VBS OUT (X)
4	G OUT (X)	G OUT (X)	G OUT (X)	G OUT (X)	Y OUT (X)
5	B OUT (X)	B OUT (X)	B OUT (X)	B OUT (X)	C OUT (X)
6	VBS OUT (X)	VBS OUT (X)	Y OUT (X)	Y OUT (X)	- (X)
7	C.SYNC OUT (X)	WEN OUT (X)	C.SYNC OUT (X)	WEN OUT (X)	WEN OUT (X)
8	C.SYNC OUT (G)	WEN OUT (G)	C.SYNC OUT (G)	WEN OUT (G)	WEN OUT (G)
9	- (X)	- (X)	C OUT (X)	C OUT (X)	- (X)

## 8 PIN CONNECTOR

### DXC-990/990P and DXC-390/390P

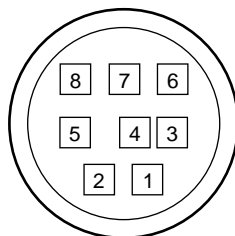

1	INTER CONNECT
2	INTER CONNECT
3	DATA OUT
4	DC OUT (G)
5	DATA IN
6	NC
7	DC OUT (+)
8	CMA DATA



# 7. SPECIFICATIONS

## IMAGE SYSTEM/OPTICAL SYSTEM

	DXC-990/990P	DXC-390/390P
Image device	1/2 type CCD, interline transfer type	1/3 type CCD, interline transfer type
Effective picture elements	DXC-990: 768 (H) x 494 (V) DXC-990P: 752 (H) x 582 (V)	DXC-390: 768 (H) x 494 (V) DXC-390P: 752 (H) x 582 (V)
Chip size	7.95 (H) x 4.94 (V) mm	6.00 (H) x 4.96 (V) mm
Unit cell	DXC-990: 8.4 (H) x 9.8 (V) DXC-990P: 8.6 (H) x 8.3 (V)	DXC-390: 6.35 (H) x 7.40 (V) $\mu$ m DXC-390P: 6.50 (H) x 6.25 (V) $\mu$ m
Lens mount	Bayonet mount	C mount

## VIDEO SYSTEM

	DXC-990/990P	DXC-390/390P
Synchronization system	Internal/External synchronization (VBS or HD/VD), switched automatically	
Signal format	DXC-990/390: NTSC standard format (EIA standard) DXC-990P/390P: PAL standard format (CCIR standard)	
Scanning system	DXC-990/390: 2:1 interlaced, 525 lines DXC-990P/390P: 2:1 interlaced, 625 lines	
Scanning frequency	DXC-990/390: 15.734 kHz (H), 59.94 Hz (V) DXC-990P/390P: 15.625 kHz (H), 50 Hz (V)	

## FUNCTIONS / PERFORMANCE

	DXC-990/990P	DXC-390/390P
Horizontal resolution	850 TV lines	800 TV lines
Sensitivity	2000 lx (F11, 3200K)	2000 lx (F8, 3200 K)
Minimum illumination	1 lx (F1.4, GAIN:HYPER)	4 lx (F2, GAIN:HYPER)
S/N ratio	DXC-990: 63 dB (Typical) DXC-990P: 62 dB (Typical)	DXC-390 : 62 dB (Typical) DXC-390P : 61 dB (Typical)
Gain control	STEP/AGC/HYPER selectable	
Electronic shutter	OFF/STEP/VARIABLE/CCD IRIS selectable	
Lens	Remote (Auto or Manual)/Video selectable	
AE area	Multi/Large/Medium/Spot/Slit/Manual selectable	
AE level	Variable	
AE speed	Fast/Mid/Slow selectable	
AE detect	Average/Peak selectable	
Contrast Effect	Manual/DynaLatitude/DCC+ selectable	
Gamma	ON/OFF (Variable at ON)	

## 7. Specifications

	DXC-990/990P	DXC-390/390P
Pedestal	Master and R/B Manual adjustable	
Black balance	ABB	
White balance	AWB/ATW NORMAL/ATW WIDE/MANUAL/3200 K/5600 K selectable	
Detail level	ON/OFF (Variable at ON)	
Detail Frequency	HIGH/MID/LOW selectable	
Linear matrix	ON/OFF	
CCD integration mode	FIELD/FRAME selectable	
Shading Compensation	OFF/ON (Manual control)	
Baud rate	19200/9600/4800/2400/1200 selectable	
User File	A/B switchable (Two pattern memories)	
Scene File	STANDARD/MICROSCOPE/FULL AUTO/STROBE/FILE A or B	

## INPUTS / OUTPUTS

	DXC-990/990P	DXC-390/390P
Video output signals	VBS: 1.0 Vp-p, 75 Ω RGB: 1.0 Vp-p, 75 Ω, sync switchable Y: 1.0 Vp-p, 75 Ω Y/C: 1.0 Vp-p, 75 Ω, same level as VBS chroma SYNC: 2.0 Vp-p, 75 Ω	
External sync input	VBS/VS: VBS 1.0 Vp-p or Burst 0.3 Vp-p, SYNC 0.3 Vp-p, 75 Ω HD/VD: 4.0 Vp-p, 75 Ω	
Input/Output connectors	Lens (6 pin) RGB/SYNC (9 pin D-sub) DC IN/VBS (12 pin) VIDEO OUT (BNC) TRIGGER IN (BNC) REMOTE (8 pin mini DIN)	

## GENERAL

	DXC-990/990P	DXC-390/390P
Power requirements	DC 10.5 V to 15.0 V	
Operating temperature	-5 °C to 45 °C	
Storage temperature	-20 °C to 60 °C	
Operating humidity	20% to 80% (free of condensation)	
Storage humidity	20% to 90% (free of condensation)	
Power consumption	Approx. 8.0 W	Approx. 7.6 W
Dimensions	70 (W) x 72 (H) x 123.5 (D) mm (Excluding projecting parts) (2 7/8 x 2 7/8 x 4 7/8 inches)	56 (W) x 50 (H) x 128 (D) mm (Excluding projecting parts) (2 1/4 x 2 x 5 1/8 inches)
Weight	630 g (1lb 6 oz)	Approx. 370 g (13 oz)
Supplied accessories	Lens mount cap Mount stopper Operation instruction manual Panel sheet for RM-C950	Lens mount cap Tripod adaptor Operation instruction manual Panel sheet for RM-C950

\* Design and specification are subject to change without notice.

## 8. OPTIONAL ACCESSORIES

### Camera Adaptor

### CMA-D2/D2CE/D2MD/D2MDCE



#### FEATURES

- Supplies DC power with a CCDC cable to the DXC-990/990P, DXC-390/390P and DXC-9000/9100P.
- Transmits DC power and video/sync signals between the camera and the adaptor with a CCMC 12-pin cable.
- Dimensions: 210 (W) x 50 (H) x 200 (D) mm
- Weight: Approx. 1.1kg
- Power consumption: CMA-D2: 23W  
CMA-D2CE: 24.5W

### Camera Cable Extension Adaptor

### CMA-D3/D3CE

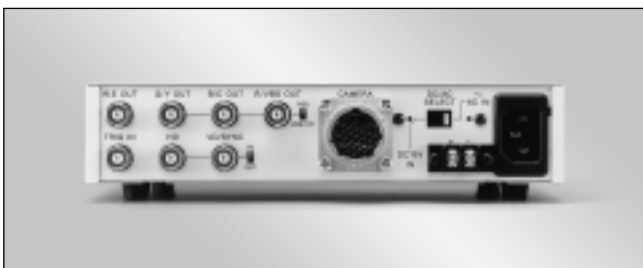

#### FEATURES

- Supplies DC power and transmits video/sync signal between the adaptor and the DXC-990/990P/390/390P with CCMC-3MZ cable and CCZ-A cable.
- Maximum 100m cable extension with cable compensation circuit.
- Camera function control capability with RM-C950
- Multiple signal outputs, RGB or Y/C and VBS
- Multiple sync signal outputs, HD/VD or C. SYNC
- Direct AC input or external DC input capability
- Dimensions: 210 (W) x 50 (H) x 210 (D) mm
- Weight: 1.4 kg
- Power requirements AC 100-240 V or DC (10.5 to 15.0 V)
- Power consumption: Approx. 20 W (CMA-D3),  
22 W (CMA-D3CE) with AC operation  
Approx. 15 W with DC operation  
(Including DXC-990/990P/390/390P and 100 m cable)

Note: When cable distances exceed 50 m in the external DC input mode, more than 12 V DC is required.

## 8. Optional Accessories

---

### Lenses

### VCL-707BXM



#### FEATURES

- Specially designed manual lens for 1/2 type bayonet mount 3CCD camera (DXC-990/990P)
- Focal length 7.5 to 54.5 mm
- Approx 560 g

### Lenses

### VCL-714BXEA/717BXEA



#### FEATURES

- Specially designed motorized remote control lens for DXC-990/990P
- Connected to a camera by an original 6-pin cable
- Focal length VCL-714BXEA: 7.5 to 105 mm  
VCL-717BXEA: 7.5 to 119 mm
- Macro (VCL-717BXEA only)
- Iris/Zoom/Focus
- Automatically adjusts the video level to the amount of incident light
- Weight: VCL-714BXEA: 1.13 kg  
VCL-717BXEA: 1.7 kg

### Lenses

### YH12x4.8 KTS, YH18x6.7 KTS (by Canon)



#### FEATURES

- Specially designed motorized remote control lens for 1/2 bayonet mount type 3CCD camera
- Focal length YH12x4.8 KTS: 4.8-58 mm  
YH18x6.7 KTS: 6.7-121 mm
- Macro
- Iris/Zoom/Focus
- Weight YH12x4.8 KTS: 1.73 kg (3 lb 13 oz)  
YH18x6.7 KTS: 1.4 kg (3 lb 1 oz)

**Lenses****VCL-610WEA/614WEA****FEATURES**

- Specially designed motorized remote control lens for DXC-390/390P
- Connected to a camera by an original 6-pin cable
- Focal length VCL-610WEA: 6.5 to 65 mm (10 times)  
VCL-614WEA: 5.5 to 77 mm (14 times)
- Macro (VCL-614WEA only)
- Iris/Zoom/Focus
- Remote/Manual switchable (VCL-614WEA only)
- Automatically adjusts the video level to the amount of incident light
- Weight: VCL-610WEA: Approx. 500 g  
VCL-614WEA: Approx. 900 g

**Lenses****VCL-08WM/16WM/25WM****FEATURES**

- Specially designed monofocal lens for 1/3 type C mount 3CCD camera (DXC-390/390P)
- Focal length VCL-08WM: 8 mm  
VCL-16WM: 16 mm  
VCL-25WM: 25 mm
- Approx. 60 g

**Remote Control Unit****RM-C950****FEATURES**

- Full remote control of the camera functions and zoom/focus/iris functions of the VCL-610WEA/614WEA lenses.
- Easy control of functions such as Gain, Detail, Master Pedestal, Red and Blue Gain by turning knobs on the unit
- The shutter speed used in the high-speed mode and the long-term exposure mode can be adjusted with the UP and DOWN buttons
- Power is supplied through the DXC-990/990P/390/390P connected to the camera adaptor.
- Dimensions: 212 (W) x 41 (H) x 132 (D) mm
- Weight: Approx. 400 g
- Power requirements: DC 12 V

**Microscope Adaptor and Coupler**

**MVA-15, MVA-41A, MVAC-33-N/33-SM/33-O**



**FEATURES**

- MVA-15  
Microscope adaptor for C mount, 1/3 type CCD
- MVA-41A  
Microscope adaptor for DXC-990/990P
- MVAC-33-N  
Coupler for NIKON microscopes except the SMZ-10 series microscope
- MVAC-33-SM  
Coupler for NIKON SMZ-10 series microscope
- MVAC-33-O  
Coupler for OLYMPUS microscope microscope

**Lens Mount Adaptor**

**LO-32BMT**



**FEATURES**

- 2/3-inch lens mount adaptor for DXC-990/990P

**Camera Cable**

**CCDC-5/10/25/50A/100A**



**FEATURES**

- 5, 10, 25, 50, 100 m, 12-pin <--> 4-pin

**Camera Cable****CCMC-12P02/12P05/12P10/12P25****FEATURES**

- 2, 5, 10, 25 m, 12-pin <--> 12-pin

**Camera Cable****CCXC-9DD/9DBS, CCMC-9DS****FEATURES**

- CCXC-9DD: 5 m, 9-pin D-sub <--> 9-pin D-sub
- CCXC-9DBS: 5 m, 9-pin D-sub <--> BNCs (R/G/B/SYNC/VBS)
- CCMC-9DS: 5 m, 9-pin D-sub <--> BNCs (R/G/B/SYNC) and DIN 4-pin (Y/C)

**Camera Cable****CCMC-3MZ****FEATURES**

- 3 m, for CMA-D3/CE connection
- Capable of connecting to the CCZ-A2/A5/A10/A25/A50/A100 cables
- Supplied with interconnection adaptor, CCZZ-1E

# 9. SYSTEM EXAMPLES

## BASIC

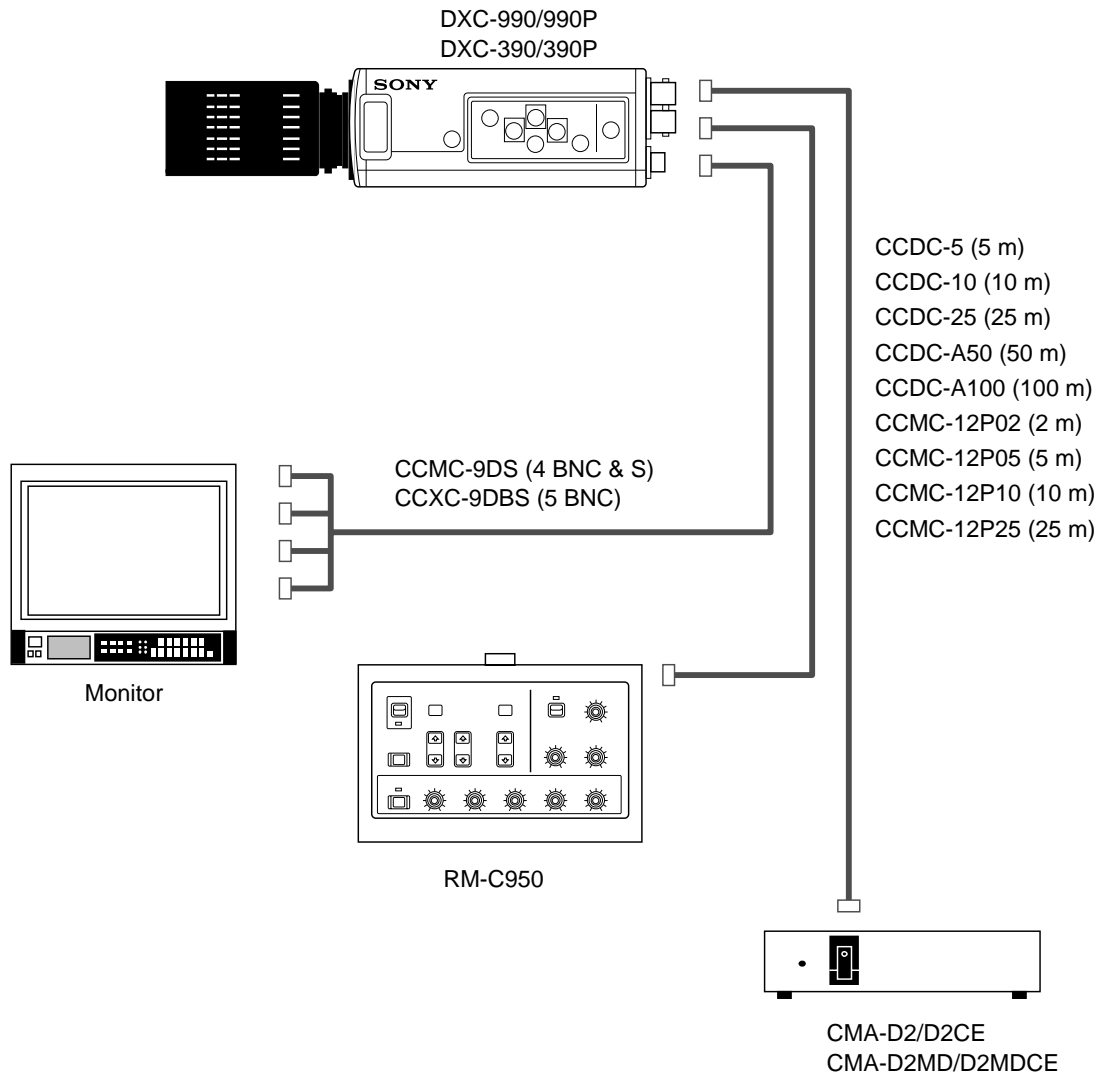

**Note 1)**

When using the CCDC cable between the DXC-990/990P/390/390P and the CMA-D2 Series, it is not possible to output a video signal or input Genlock from the CMA-D2 Series.

**Note 2)**

When connecting the DXC-990/990P/390/390P over a 12-pin multi-core cable, it is not necessary to set the MODE switch from 1 to 2.

**Note 3)**

Y/C signal can be output from the CMA-D2 Series. However, in this case, both Y/C and VBS signals can not be output simultaneously. Each one should be selected according to the users requirement. When cables are connected with both connectors (Y/C and VBS), the output signal from the VBS connector becomes B/W because only the Y signal is output.



## MICROSCOPY

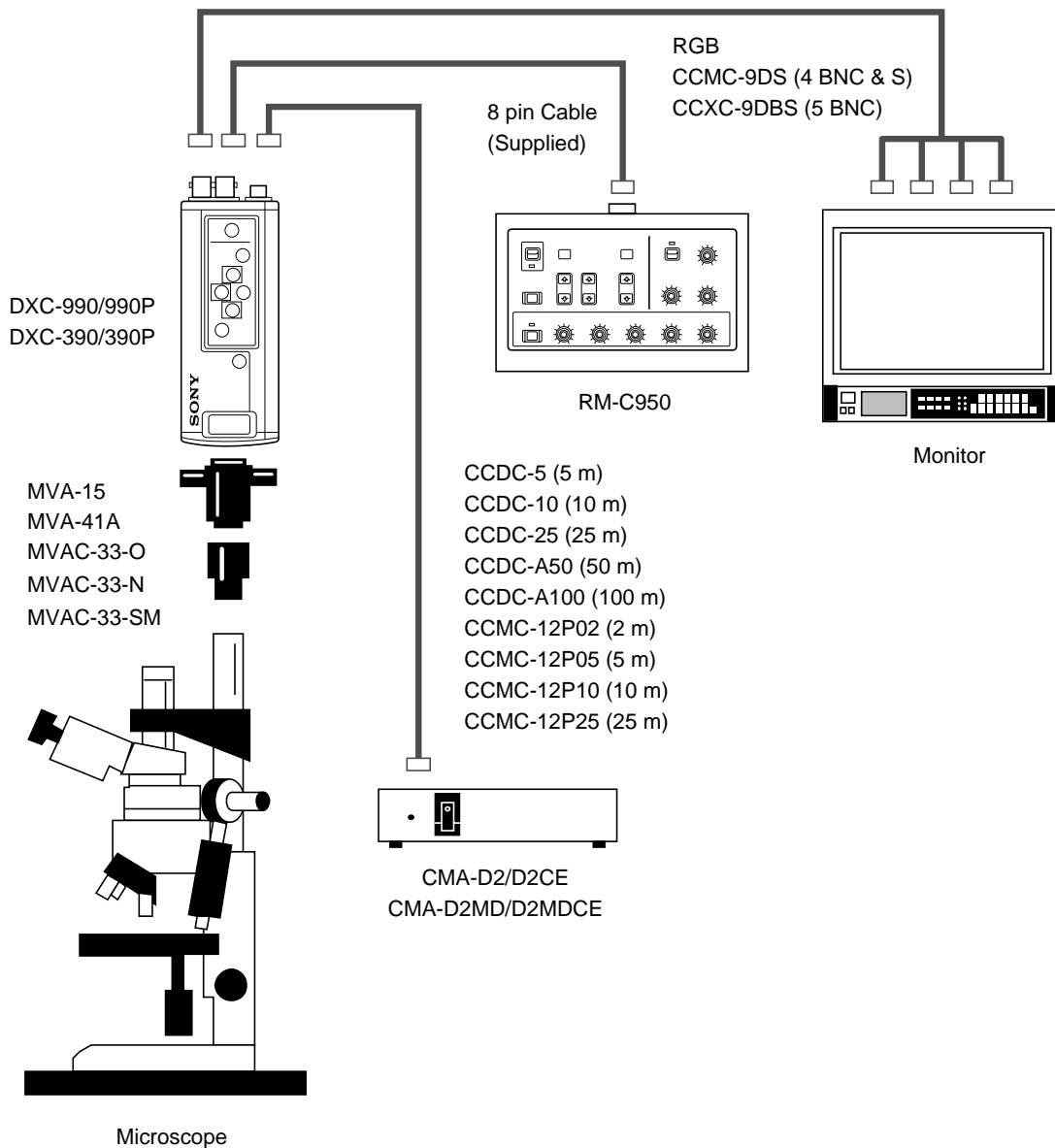

## Note 1)

'Sync on Green' function should be equipped with peripherals. Please set 'SYNC' on 'SYSTEM' sub menu to 'G' or 'RGB' when using the long term exposure function because it is necessary to output the WEN pulse from the connector for sync.

## Note 2)

The WEN pulse has no capability to connect with the SONY video printers.

REMOTE

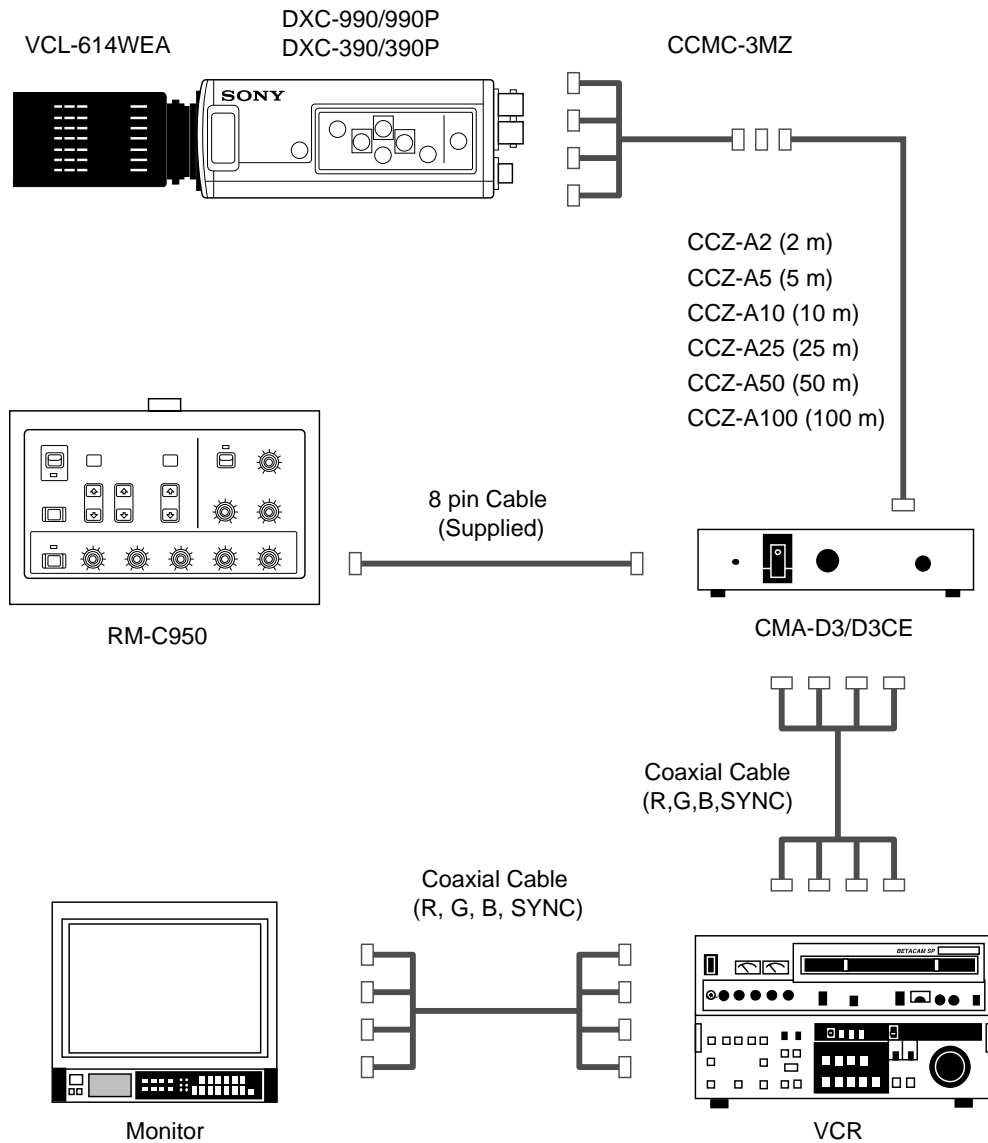

Note 1)

The CMA-D3/D3CE cannot output both RGB and Y/C, VBS simultaneously. Please select the output signal, RGB or Y/C, VBS at the switch on the rear panel of the CMA-D3/D3CE.

Note 2)

Lens function(zoom, focus, iris) can only be controlled by the RM-C950 or PC when using recommendable lenses such as VCL-610WEA/614WEA.

# 10. DIMENSIONS

## DXC-990/990P

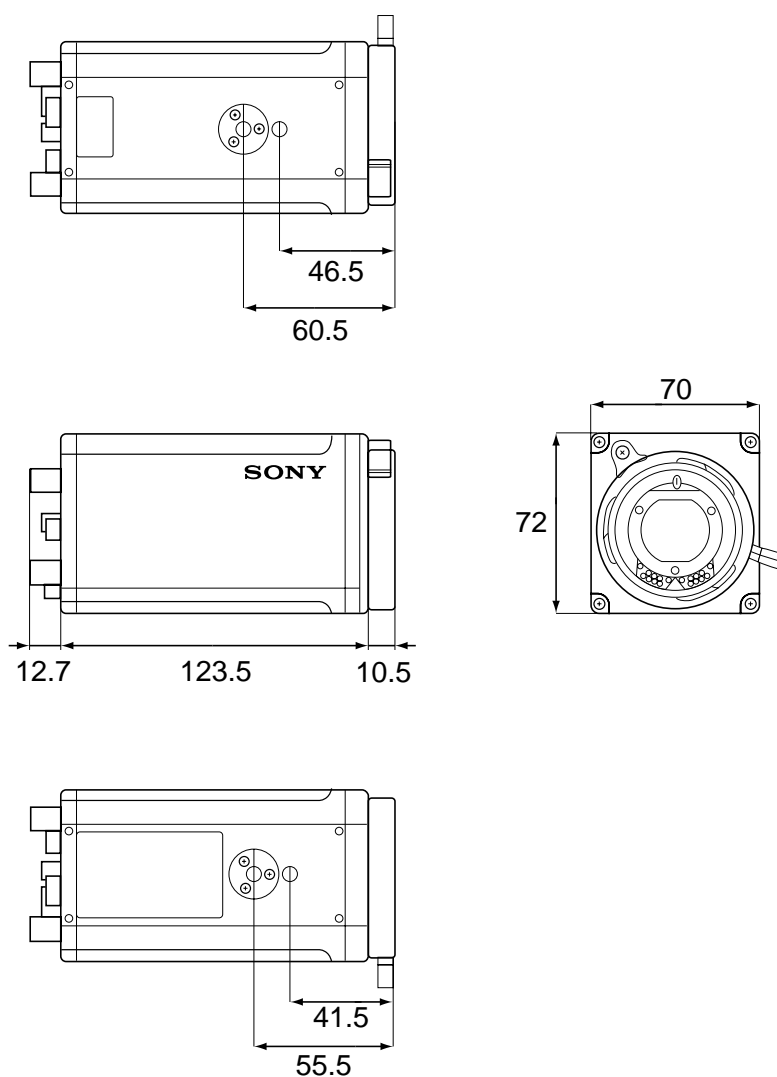

mm (inches)

## DXC-390/390P

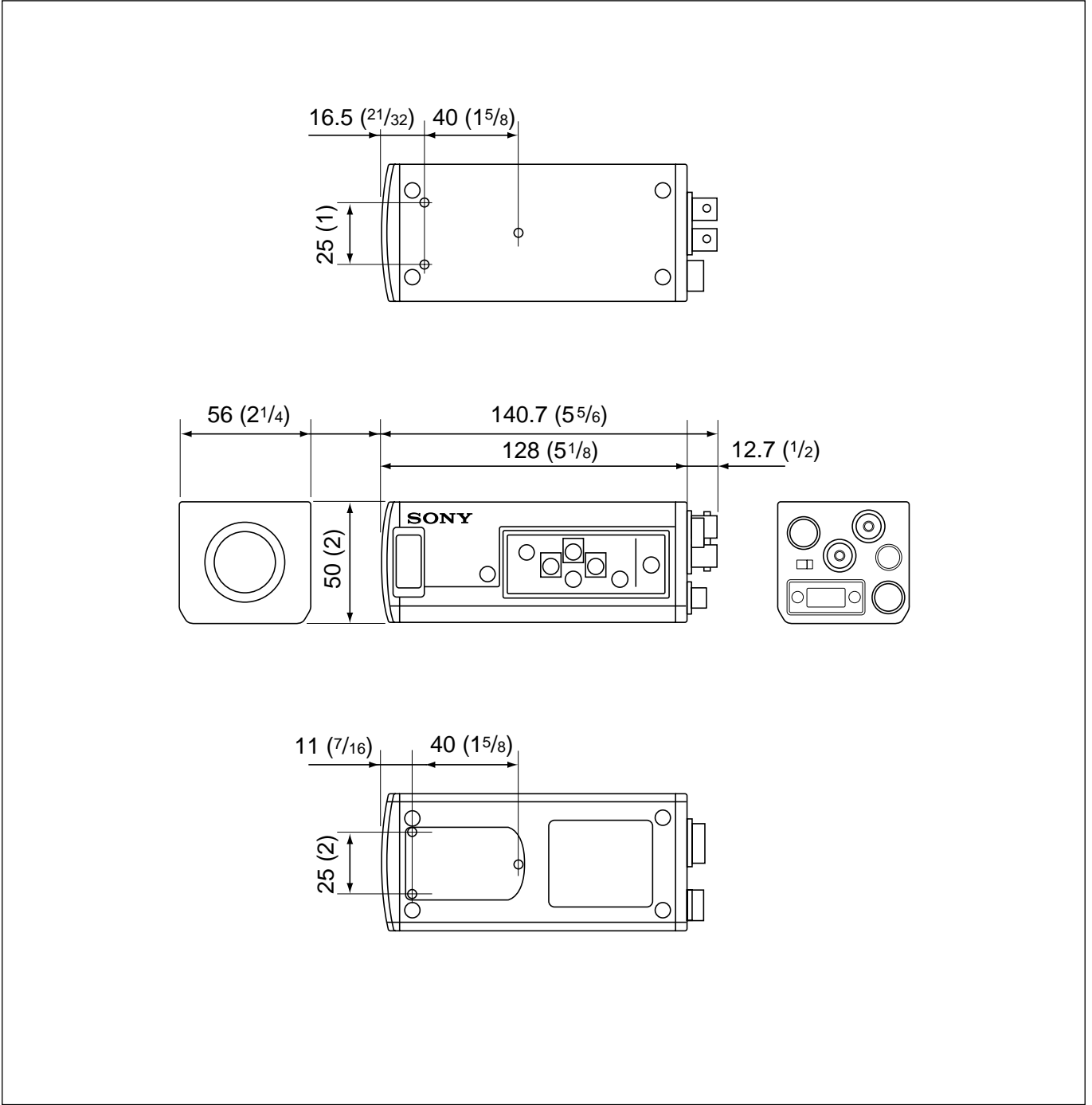

mm (inches)

### CMA-D3/D3CE

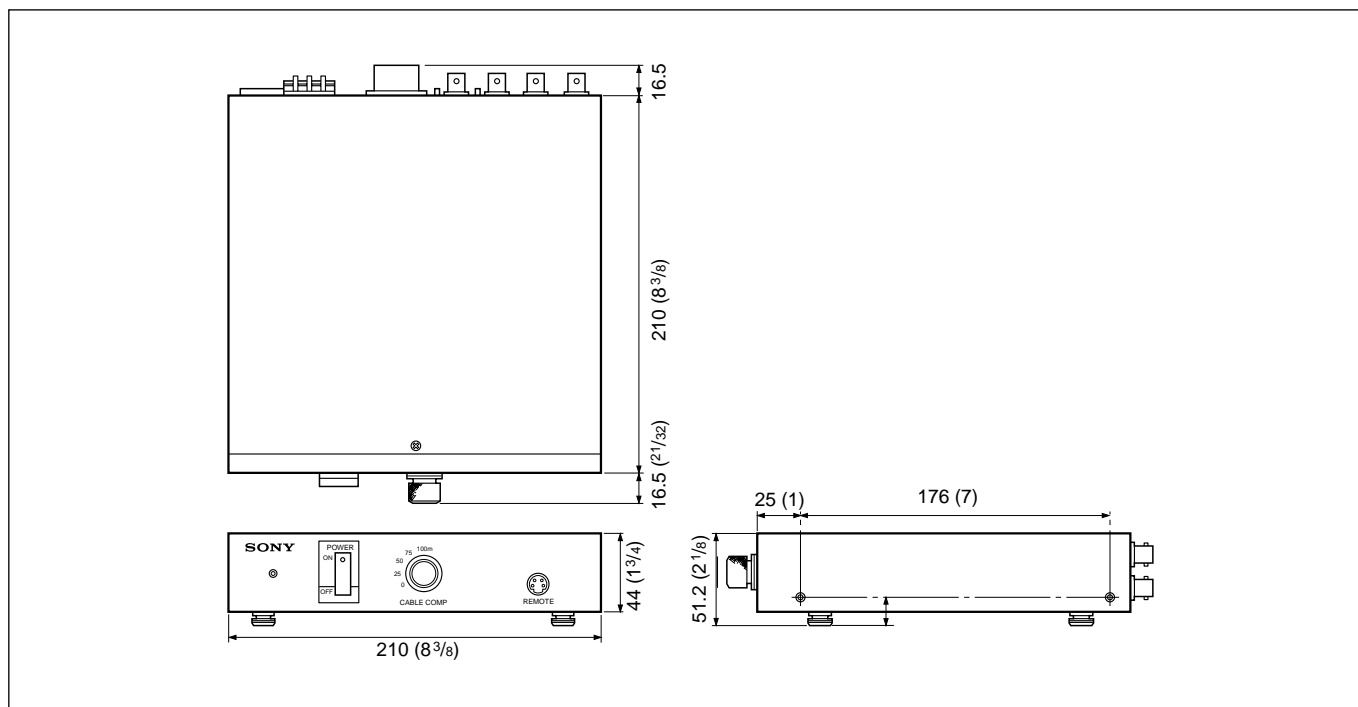

### VCL-714BXEA (for DXC-990/990P)

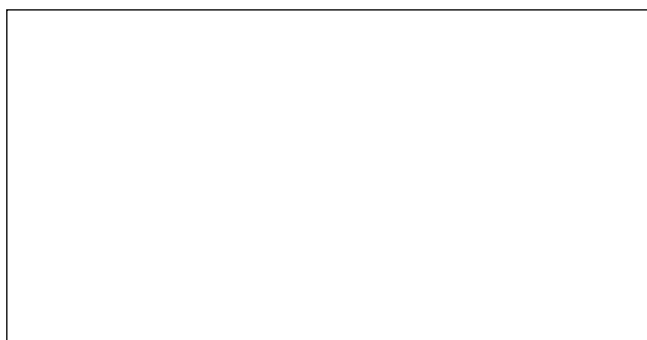

### VCL-717BXEA (for DXC-990/990P)

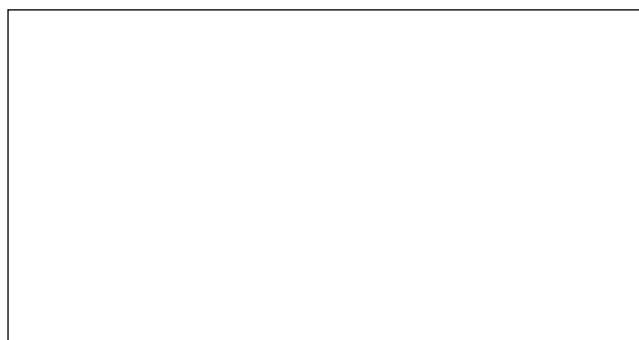

### VCL-610WEA (for DXC-390/390P)

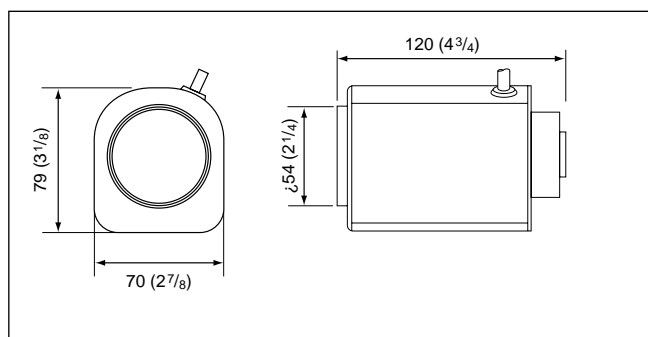

### VCL-614WEA (for DXC-390/390P)

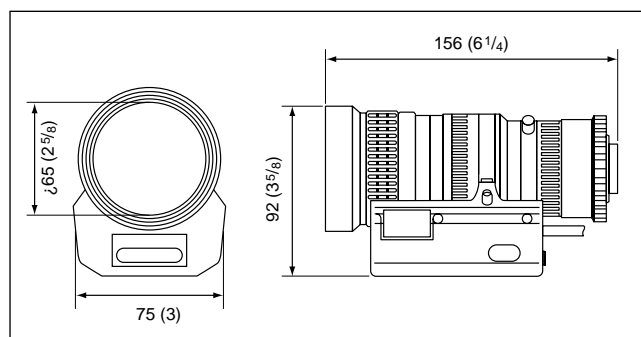

mm (inches)

# 11. COMPARISON CHART

## COMPARISON OF DXC-990/990P VS. COMPETITOR'S PRODUCTS

Manufacturer	SONY	Panasonic	HITACHI	JVC
Model Name	DXC-990/990P	AW-E600	HV-D15	KY-F32
Pick-up Device	1/2 type IT CCD	1/2 type IT CCD	1/2 type IT CCD	1/2 type IT CCD
Mount	Bayonet	Bayonet	Bayonet	Bayonet
Sync system	INT/EXT	INT/EXT	INT/EXT	INT/EXT
External Sync	VBS, HD/VD	VBS, BB	VBS	VBS, BS
Sensitivity	F11, 2000 lx	F11, 2000 lx	F8, 2000 lx	F5.6, 2000 lx
Minimum illumination	1 lx, F1.4	1.5 lx, F1.4	1.0 lx	?
Horizontal resolution	850V Lines	850 TV Lines DTL:ON	800TV Lines	750TV Lines
Signal to Noise Ratio	63 dB (NTSC) 62 dB (PAL)	63 dB (NTSC) DNR:ON 60 dB (PAL) DNR:ON	63 dB DNR:ON	60 dB (NTSC) 58 dB (PAL)
Output Signal	VBS, Y/C, RGB, Y/R-Y/B-Y	VBS, Y/C, Option	VBS, Y/C, RGB	VBS, Y/C, RGB
Power Requirement	DC 12 V	DC 12 V	DC 12 V	DC 12 V
Power Consumption	8.0 W	9.6 W	8.0 W	8.5 W
Weight	630 g	860 g	950 g	850 g
Dimensions	70 x 72 x 123.5 mm	84 x 77 x 156 mm	80 x 85 x 134 mm	70 x 80 x 164 mm
Gain	Up to 30 dB	Up to 30 dB	Up to 20 dB	Up to 18 dB
Shutter	Up to 1/100,000	Up to 1/10,000	Up to 1/10,000	Up to 1/2,000
Trigger or Strobe	Yes	Option	No	Yes
RS-232C	Yes		Yes	Option

## 11. Comparison Chart

### COMPARISON OF DXC-390/390P VS. COMPETITOR'S PRODUCTS

Manufacturer	SONY	Panasonic	HITACHI	JVC
Model Name	DXC-390/390P	AW-E300	HV-D25	KY-F55B/E
Pick-up Device	1/3 type IT CCD	1/3 type IT CCD	1/2 type IT CCD	1/3 type IT CCD
Mount	C mount	C mount	C mount	C mount
Sync system	INT/EXT	INT/EXT	INT/EXT	INT/EXT
External Sync	VBS, HD/VD	VBS, BB	VBS	VBS, BS
Sensitivity	F8, 2000 lx	F8, 2000 lx	F8, 2000 lx	F5.6, 2000 lx
Minimum illumination	4 lx, F2	1.5 lx, F1.4	1.5 lx	?
Horizontal resolution	800 TV Lines	800 TV Lines	800 TV Lines	750 TV Lines
Signal to Noise Ratio	62 dB (NTSC) 61 dB (PAL)	63 dB (NTSC) DNR: ON 60 dB (PAL) DNR: ON	63 dB DNR: ON	60 dB (NTSC) 58 dB (PAL)
Output Signal	VBS, Y/C, RGB	VBS, Y/C, Option	VBS, Y/C, RGB	VBS, Y/C, RGB
Power Requirement	DC 12 V	DC 12 V	DC 12 V	DC 12 V
Power Consumption	7.6 W	9.6 W	8.0 W	7.5 W
Mass	370 g	700 g	950 g	490 g
Dimensions	56 x 50 x 128 mm	84 x 77 x 146 mm	80 x 85 x 134 mm	66 x 64 x 120 mm
Gain	Up to 30 dB	Up to 30 dB	Up to 20 dB	Up to 18 dB
Shutter	Up to 1/100000	Up to 1/10000	Up to 1/10000	Up to 1/2000
Trigger or Strobe	Yes	Option	No	Yes
RS-232C	Yes	Yes	Yes	Option

# 12. TECHNICAL APPENDIX

## WEN pulse –output signal to external frame memory–

The DXC-990/990P and DXC-390/390P feed the WEN pulse output to the external frame memory so that the external frame memory can precisely store the video signal output from the DXC-990/990P and DXC-390/390P. The purpose of this output pulse is to externally lock the frame memory timing to the HD/VD signal or the sync signal of the DXC-990/990P and DXC-390/390P so that the right start time of the external frame memory can be precisely controlled by this signal. In short, this output pulse indicates that the video signal following the edge of this pulse is the valid video signal.

The DXC-990/990P and DXC-390/390P have three functions using the WEN pulse such as Normal operation, Strobe mode and Long term exposure mode.

### ■ Normal operation

During normal operation of a camera, the WEN pulse continuously outputs a high signal for even fields, low signal for odd field or vice versa (See diagram). This means that the output pulse is a field index pulse.

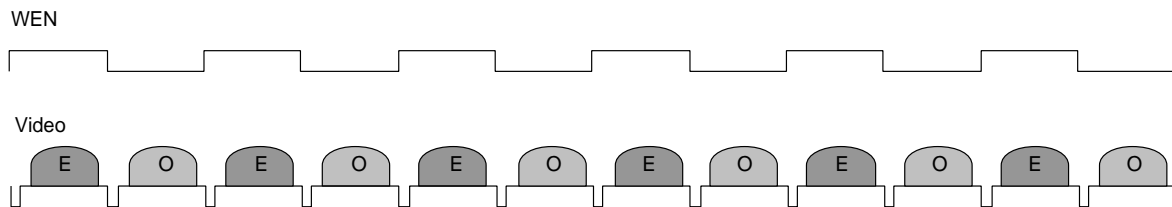

### ■ Strobe mode

When the DXC-990/990P or DXC-390/390P is operating in the Strobe mode, the WEN pulse outputs during the odd field only (See diagram of Strobe function). An external frame memory can store a complete still picture the moment the WEN pulse is used with an external frame memory. WEN mode is selectable from WEN 1-3 for DXC-990/990P. Only WEN1 mode is available for DXC-390/390P.

### ■ Long term exposure mode

During the long term exposure mode, the video signal is output as shown in the diagram below, and the WEN pulse is output during the field before the valid video field (See diagram of Strobe function). The shutter speed must be set beforehand by using the menu.

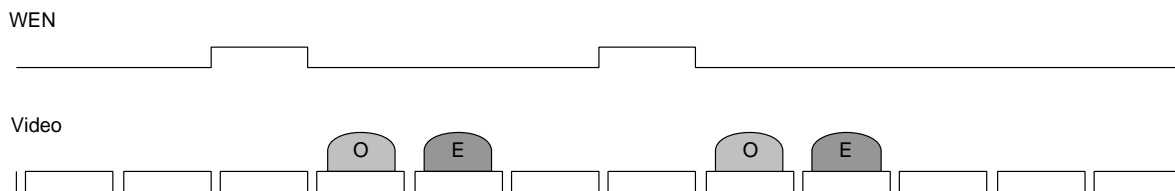

In case of 2 FRM, shutter speed

Note: It is impossible to use both the Strobe mode and Long term exposure at the same time.



## Strobe function

- The video signal outputs an odd field image first then an even field image, making for easy operation when connecting the camera with a Frame Grabber Board.
- The timing of the WEN pulse and video signal acts as a connection with a Frame Grabber Board.
- The strobe function is designed for dark lighting conditions with a flash. The strobe function does not work under bright conditions such as outdoors.
- It is possible to monitor the image just before a flash is emitted.
- The output signal is an image exposed for a few frames.
- Keep 'CCD MODE' setting to 'FRAME'.
- Do not use automatic function, such as AGC, CCD IRIS, AWB, ATW, Flicker canceller, etc.
- It is not possible to change the electronic shutter speed.

### ■ Timing chart.

#### WEN 1

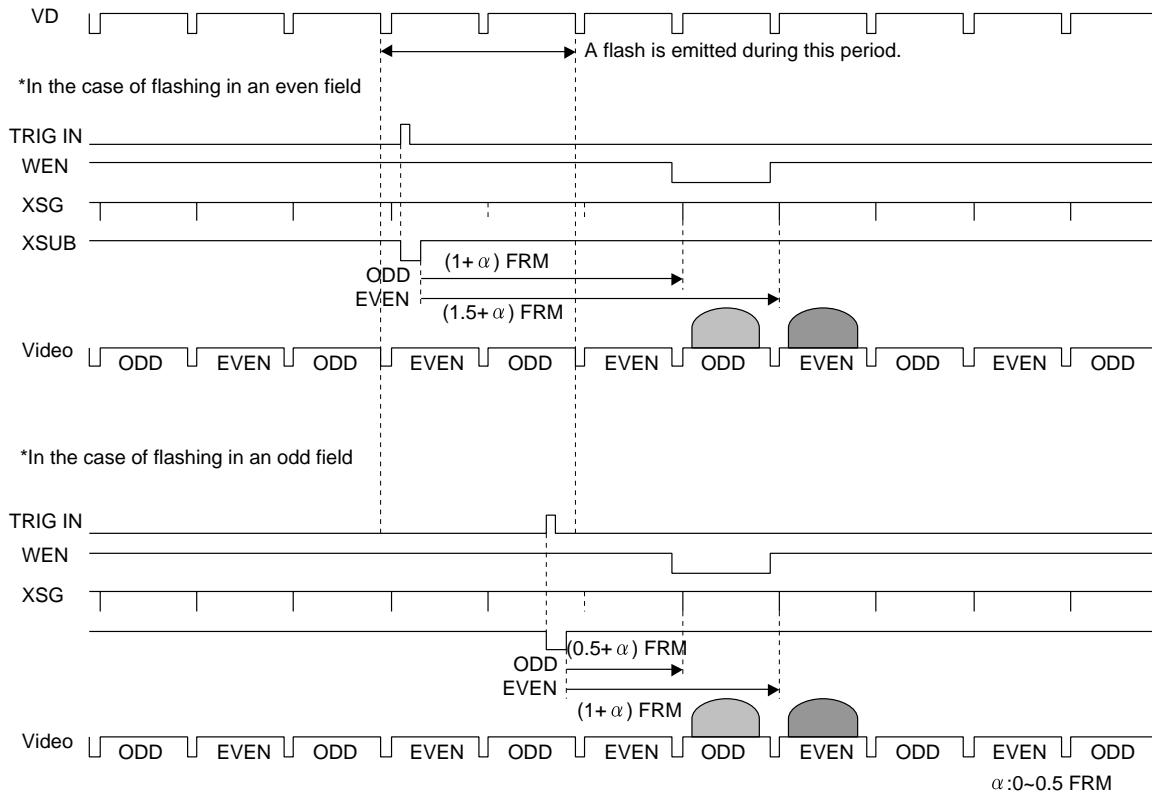

**WEN 2 (DXC-990/990P Only)**

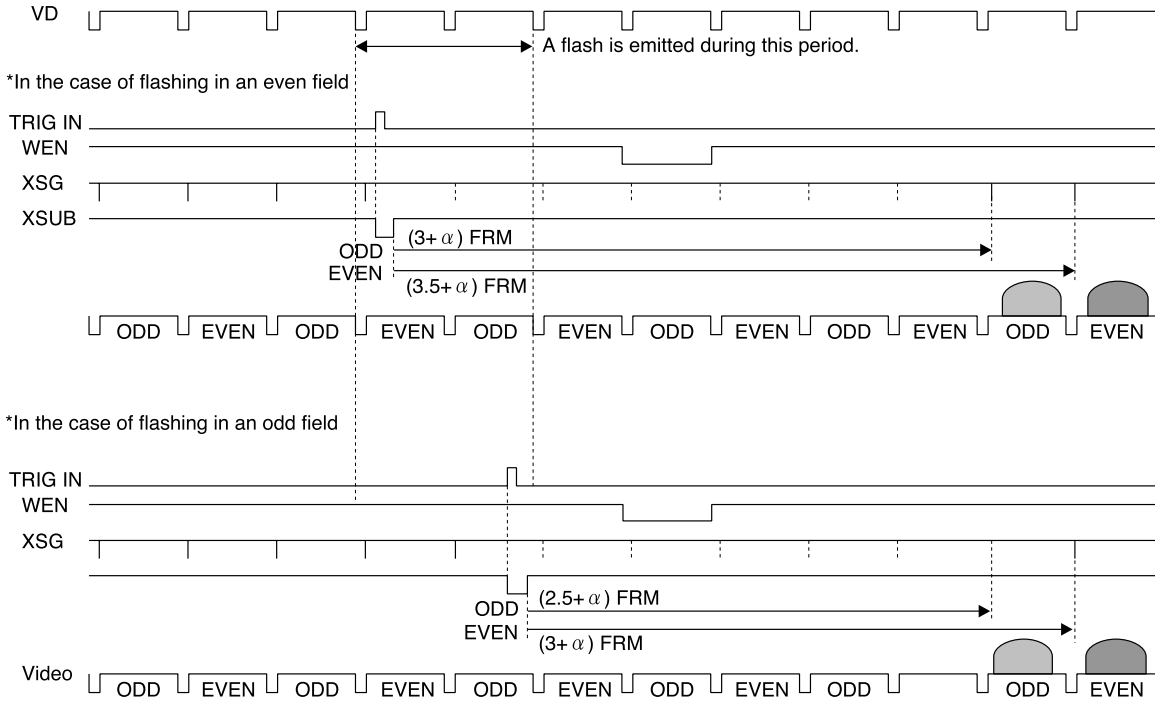

**WEN 3 (DXC-990/990P Only)**

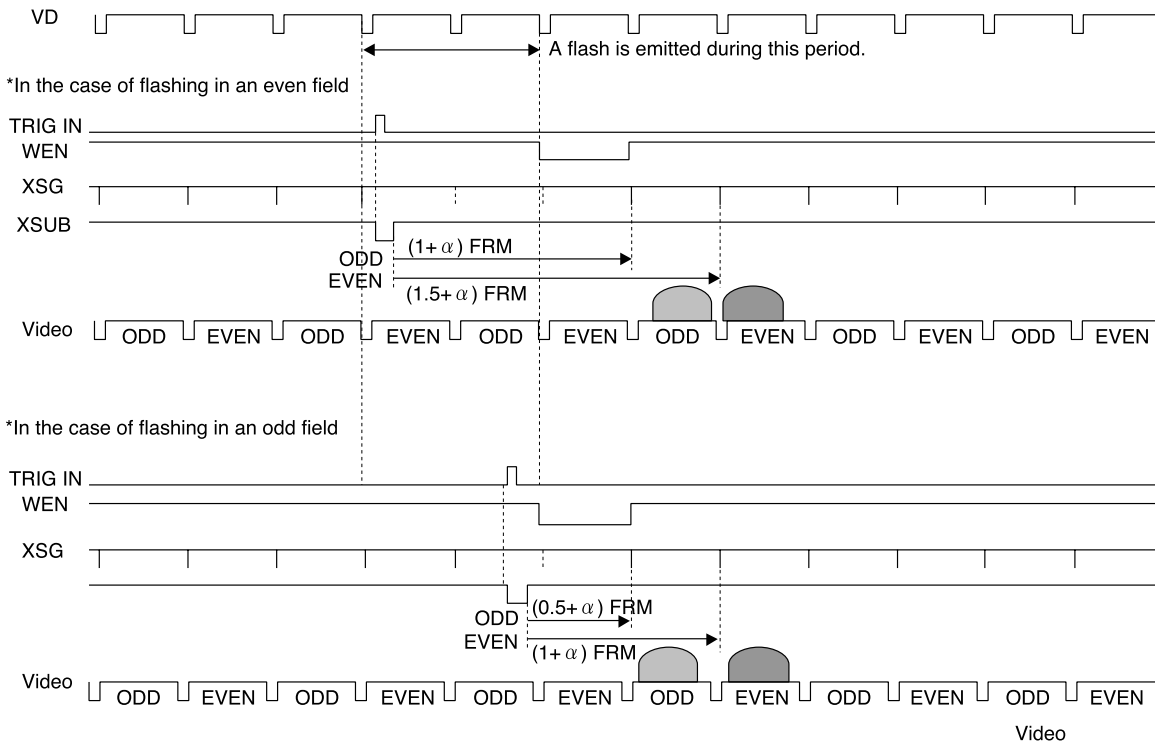

## External trigger pulse

The Strobe function is available by inputting the external trigger pulse to the TRIGGER IN (BNC) connector on the rear panel.

There are two kinds of polarities for external trigger pulse. One is the rising edge and the other is the falling edge. Both select the same polarity as the input signal for controlling the strobe function.

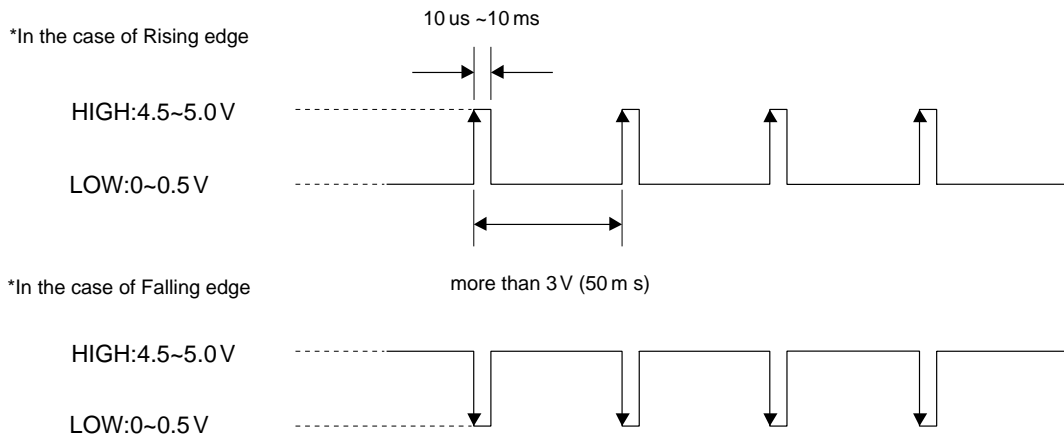

# 13. Q & A

## Q.1: What are the differences between the DXC-990/990P and the DXC-390/390P?

A: The following is a comparison table of the DXC-990/990P and the DXC-390/390P.

### ■ Specification

	DXC-990/990P	DXC-390/390P
Pick-up Device	1/2 type Exwave HAD	1/3 type Exwave HAD
Mount	38 Bayonet Mount	C mount
Unit cell	8.4 (H) x 9.8 (V) $\mu\text{m}$ (N) 8.60 (H) x 8.30 (V) $\mu\text{m}$ (P)	6.35 (H) x 7.40 (V) $\mu\text{m}$ (N) 6.50 (H) x 6.25 (V) $\mu\text{m}$ (P)
Sensitivity	F11, 2000 lx	F8, 2000 lx
Minimum illumination	1 lx (F1.4 GAIN:HYPER)	4 lx (F2, GAIN:HYPER)
Horizontal resolution	850 TV lines	800 TV lines
Signal to Noise Ratio	63 (N), 62 (P) dB	62 (N), 61 (P) dB
Y/R-Y/B-Y Output	Yes	No
HD/VD Output or Input	Yes	Yes
Power Consumption	Approx. 8.0 W	Approx. 7.6 W

### ■ Feature

	DXC-990/990P	DXC-390/390P
Gain	Up to 30 dB (GAIN:HYPER)	Up to 30 dB (GAIN:HYPER)
Shutter	Up to 1/10000 s	Up to 1/100000 s
Flash or Strobe Mode	Slave	Slave
CCD IRIS	Ten F steps	Ten F steps
AE area	6 mode	6 mode
DynaLatitude	Yes	Yes
Linear Matrix	On (5 mode)/OFF	On (5 mode)/OFF
Partial Enhance	Yes	Yes
Vertical Detail	2H	2H
Black Balance	Yes	Yes
Baud Rate	19200, 9600, 4800, 2400, 1200	19200, 9600, 4800, 2400, 1200
Scene File and User File	4 Scene Files, 2 User Files	4 Scene Files, 2 User Files

### ■ Mechanical design

	DXC-990/990P	DXC-390/390P
Dimensions	70 (W) x 72 (H) x 123.5 (D) mm (2 7/8 x 2 7/8 x 5 inches)	56 (W) x 50 (H) x 128 (D) mm (2 1/4 x 2 x 5 1/8 inches)
Weight	Approx. 630 g (1 lb 6 oz)	Approx. 370 g (13 oz)

**Q.2: Is it possible to output component signals from the DXC-990/990P and DXC-390/390P?**

A: As for DXC-990/990P, Yes.

As for DXC-390/390P, No.

**Q.3: What is the dynamic range of the DXC-990/990P and DXC-390/390P?**

A: The dynamic range is about 300%. The DynaLatitude function is very useful when shooting an image with both dark and bright areas in a single picture.

**Q.4: How many mm can the flange back of the DXC-390/390P be adjusted?**

A: The adjustable range of flange back is 17.526 (in air)  $\pm$  0.25 mm.

**Q.5: What is the spectral response of the camera?**

A: The characteristics of spectral sensitivity are as follows. This includes CCD, prism and optical filter data.

DXC-990/990P Characteristics of Spectral Sensitivity

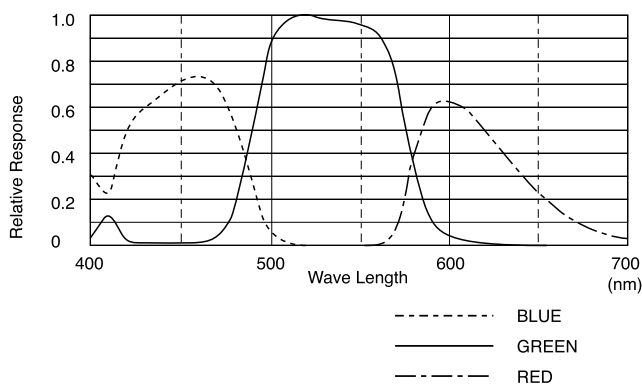

DXC-390/390P Characteristics of Spectral Sensitivity

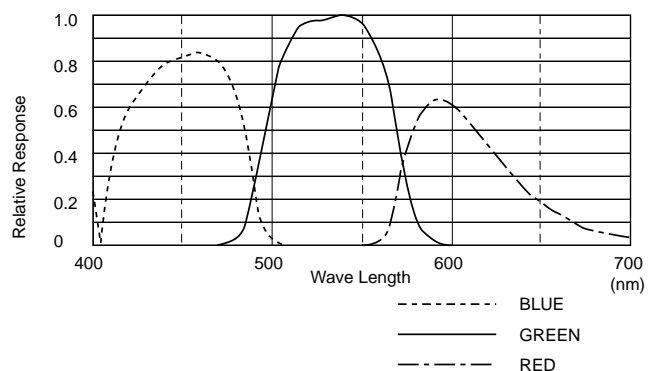

**Q.6: How can the DXC-990/990P and DXC-390/390P be mounted on a tripod?**

A: As for the DXC-990/990P, the camera can be directly mounted on a tripod.  
As for the DXC-390/390P, a supplied tripod adaptor can be screwed into holes on the top and bottom of the camera (M3, depth: 4 mm (3/16 inches)), allowing the camera to be mounted on a tripod.

---

**Q.7: Is the RS-232C protocol of the RS-232C open to the public?**

A: Yes.  
Contact the nearest Sony sales office for more details.

---

**Q.8: Is there a possibility of mistakenly pushing buttons on the rear panel of the DXC-990/990P or the side panel of the DXC-390/390P?**

A: When "Menu Lock SW" is set to on, buttons on the rear panel of the DXC-990/990P or the side panel of the DXC-390/390P are deactivated, protecting the contents of menu.

---

**Q.9: Is the CCU-M5/M5A available for the DXC-990/990P or the DXC-390/390P?**

**Is the CMA-D3/D3CE available for the DXC-990/990P?**

A: The CCU-M5/M5A is not available for either of the two models.  
The CMA-D3/D3CE is available for the DXC-990/990P.

**Q.10: When using the CMA-D3/D3CE camera adaptor with a CCZ-A cable, does the user have to purchase a separate CCZZ-1E connection adaptor?**

A: No.

The CCZZ-1E connector adaptor is supplied with the CCMC-3MZ cable.  
The user does not have to purchase another CCZZ-1E.

**Q.11: Does the cable length effect the DC power supply when using the CMA-D3/D3CE?**

A: For DC operation, the usable cable length is limited by the supplied voltage. If you use a camera cable of 50 m or longer, you need to connect a 11.5 to 15 V DC power supply.

**Q.12: What are the differences among power supply units?**

A: The following is a comparison table between CMA-D3/D3CE and CMA-D2 Series

	CMA-D2 Series with CCMC-12P**	CMA-D2 Series with CCDC-**	CMA-D3/D3CE
Cable Distance	Up to 25 m	Up to 100 m	Up to 100 m
VBS output	Yes	No	Yes
RGB output	No	No	Yes
Y/C output	Yes	No	Yes
VBS Genlock	Yes	No	Yes
HD, VD input or output	No	No	Yes
Trig in/WEN output	No	No	Yes
Control by RM-C950	No	No	Yes
AC IN	Yes	Yes	Yes
DC IN	No	No	Yes

Note) The output signals from CMA-D3/D3CE are selectable from the RGB output or Y/C output.

### Q.13: What are the differences between the VCL-610WEA and VCL-614WEA (for DXC-390/390P)?

A: The following is a comparison table between VCL-610WEA and VCL-614WEA.

	VCL-610WEA	VCL-614WEA
Zoom ratio	10x	14x
Focal length	6.5 to 65 mm	5.5 to 77 mm
Zoom control	Remote	Remote/Manual Swithable
Focus control	Remote	Remote/Manual Swithable
Iris control	Remote	Remote/Manual Swithable
M.O.D	1200 mm	1000 mm
Macro	Not applicable	Applicable
Filter Thread	M52, P=0.75 mm	M62, P=0.75 mm
Mass	Approx. 500 g	Approx. 900 g
Remarks	By Canon	By Fujinon

### Q.14: What are the differences between the VCL-714BXEA and VCL-717BXEA (for DXC-990/990P)?

	VCL-714BXEA	VCL-717BXEA
Zoom ratio	14 x	17 x
Focal length	7.5-105 mm	7-119 mm
Zoom control	Remote	Remote
Focus control	Remote	Remote
Iris control	Remote	Remote
M.O.D	1100 mm	950 mm
Macro	Applicable	Not Applicable
Filter Thread	M72, P=0.75 mm	M86, P=1.0 mm
Mass	1.13 kg	1.7 kg
Remarks	By Sony	By Sony



---

**Q.15: Can lenses other than the optional lenses be used for DXC-390/390P?**

A: There are limitations to the type of C mount lenses used with the DXC-390/390P. The lens must not project more than 4.3 mm (3/16 inches) from the lens mount surface. Even if lenses meet this requirement, color aberration may appear because most C mount lenses on the market are designed for one CCD, not for 3 CCD, cameras. In addition, lenses other than the optional Sony VCL-610WEA or VCL-614WEA cannot control zoom, focus and iris functions by the RM-C950 remote control unit.

Distance from lens mount surface must not be more than 4.3 mm

