

**SONY**<sup>®</sup>

**LUMA**  
Sony Professional LCD Monitor

Professional LCD Monitors  
**LUMA Family Catalog**

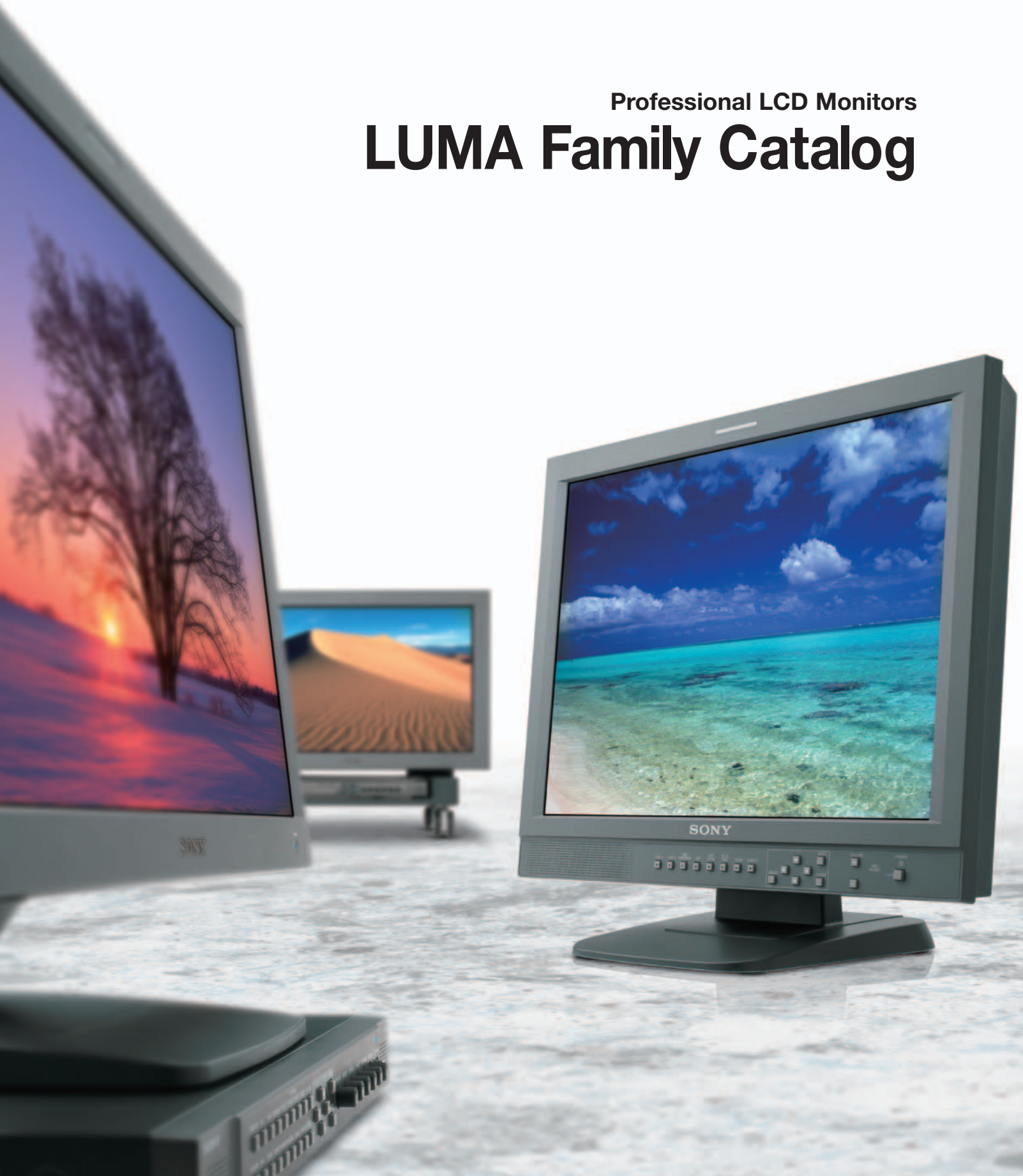

# *A Comprehensive Line of True – the Sony LUMA Series*

Combining decades of expertise in professional A/V technology with today's stunning advancements in LCD panel technology, Sony now offers a comprehensive range of LUMA™ Series LCD monitors – each model developed to meet the quality-critical needs of professional picture monitoring.

Unlike typical LCD monitors, the LUMA Series places maximum emphasis on monitoring video images. The superb-quality LCD panel chosen for each monitor provides an extremely high level of brightness, contrast, and color depth – as well as a wide viewing angle. At the same time, they also offer the slim and lightweight LCD advantages for easy installation and flexibility.

Four product ranges are available to suit the many different professional monitoring needs.

The separate type models offer the highest-quality LCD video monitoring, consisting of high-grade LCD panels and a dedicated MEU interface unit. These models are SD and HD compatible and accommodate almost any signal input. The one-piece type studio models are the choice for pursuing the best quality per cost for SD-exclusive monitoring applications. And finally, the handheld type and multi-display monitors are DC operable and provide utmost convenience and flexibility in space-limited and mobile applications.

With such a wide variety of choices, and with the features and functionality that only Sony monitors provide, the LUMA Series of LCD monitors presents a new realm of quality and convenience for professional video monitoring.



# Professional LCD Monitors

■ One-piece Type P.8



■ Separate Type (Studio Type) P.4



■ Multi-display Type P.12

■ Handheld Type P.10

# Separate Type LUMA Monitors (Studio Type)

The separate type LUMA monitors represent the pinnacle of the LUMA Series. Consisting of high-grade LCD panels used together with a dedicated MEU-WX2 Multifformat Engine unit\* – which provides a rich set of interfaces – they offer SD and HD multi-format capability as well as PC input capability. These monitors are furnished with the features and quality to replace CRT monitors at the Sony PVM-L5 range.



LMD-322WS



LMD-232WS



LMD-212S



LMD-172WS



LMD-152S

## Flexible Choice of LCD Display Panels

Five LCD display sizes are available. Each LCD display uses one MEU-WX2 signal-processing unit for display parameter control and signal interface.

### Panel Types

	Panel Aspect Ratio	Panel Size*	Desk-top Stand	Mounting	
				19-inch Rack	Mounting Holes (MM)
LMD-322WS	Wide	31.6-inch	SPMTR1/C or SU-558	Not applicable	330 x 330 hooks
LMD-232WS	Wide	23-inch	SU-558	Not applicable	VESA™ 75 x 75
LMD-212S	4:3	21.2-inch	SU-558	Optional MB-523	VESA 75 x 75
LMD-172WS	Wide	16.7-inch	SU-558	Optional MB-522A	VESA 75 x 75
LMD-152S	4:3	15.1-inch	SU-558	Optional MB-524	VESA 75 x 75

\* Viewable area measured diagonally.

## Flat LCD Panel with Separate Signal-processing Unit

The separate type LUMA monitors consist of extremely thin and lightweight LCD displays, and a highly advanced signal-processing unit (MEU-WX2 Multifformat Engine Unit). This 'separate unit' design offers two significant benefits – it allows the LCD display to be made as thin and as lightweight as possible, and enables flexible placement of display controls and interface connectors. The LCD display and Multifformat Engine Unit are connected via a single multi-pin cable\*, up to 10 meters long (optional), which avoids having multiple cables hanging from the LCD displays themselves. The optional SU-558 monitor stand has a biaxial joint in its neck assembly, allowing the LCD displays to be positioned at various heights and tilt angles.

\* The LMD-232WS, LMD-212S, LMD-172WS, and LMD-152S are supplied with one 1.8-meter cable, and the LMD-322WS with one 3.0-meter cable.

\* One MEU-WX2 Multifformat Engine Unit is included with each LMD-322WS/232WS/212S/172WS/152S

## Input Versatility

### Multi-format Signal Support

The MEU-WX2 Multifomat Engine Unit of the separate type LUMA monitors can accept almost any SD or HD video format, both analog and digital. These include composite NTSC and PAL, component 480/60i and 575/50i, progressive 480/60P and 576/50P, and high-definition 1080/60i, 1080/50i, and 720/60P. It can also accept 1080/24PsF and 1080/25PsF.

Standard interfaces include analog composite (NTSC/PAL), 525i/625i component, RGB, and Y/C\*1. Digital interfaces are offered as optional boards to meet budgetary and user needs. To keep the unit compact (1RU high), the analog inputs share the same four BNC connectors, each with loop-through capability. The MEU-WX2 also accepts various types of analog computer signals. With its high-performance scan converter, it can display PC signals from VGA to SXGA\*2.

\*1 Y/C signals must be input via the BNC connectors of the MEU-WX2 using an S-Video-to-BNC conversion connector.

\*2 SXGA images are down-converted for display.

System	Input Signal			Interface				
	Total Line	Active Line	Aspect Ratio	Composite/ Y/C	RGB/ Component	SD-SDI	SD-SDI/ H-SDI	DV
				Standard	Optional BKM-220D	Optional BKM-243HS	Optional BKM-255DV	
575/50i	625	575	16:9/4:3	○	○	○	○	○
480/60i*	525	483	16:9/4:3	○	○	○	○	○
576/50P	625	576	16:9/4:3	—	○	—	—	—
480/60P	525	483	16:9/4:3	—	○	—	—	—
1080/24PsF	1125	1080	16:9	—	○	—	○	—
1080/50i	1125	1080	16:9	—	○	—	○	—
1035/60i*	1125	1035	16:9	—	○	—	○	—
1080/60i*	1125	1080	16:9	—	○	—	○	—
720/60P	750	720	16:9	—	○	—	○	—

\* Also accepts 59.94 Hz field rate.

### Signal-interface Options

The MEU-WX2 can accept HD-SDI, SD-SDI, or DV signals via the following optional input adaptors.

#### BKM-220D, SD-SDI 4:2:2 Input Adaptor\*1

- SD-SDI signal input (x2)
- SD-SDI monitor output (x1)
- Power consumption: 1.5 W

#### BKM-243HS, HD-SDI/SD-SDI Input Adaptor\*1

- HD-SDI/SD-SDI signal input (x2)
- HD-SDI/SD-SDI monitor output (x1)
- Power consumption: 2 W
- HD-SDI and SD-SDI signals are automatically detected.

#### BKM-255DV\*, DV Input Adaptor\*1,\*2

- DV signal port (x 2)
- Power consumption: 4 W

\*1 The Embedded audio is supported.

\*2 The BKM-255DV accepts DV signals. However, the full command set of the AV/C (Audio/Video and Control) protocol is not supported.

### Preset Computer Input Frequencies

The MEU-WX2 is factory preset to accept 18 typical computer input signal frequencies.

#### Preset Input Frequencies

No.	Preset Signal	fH [kHz]	fV [Hz]	Dot Clock [MHz]	Sync. polarity	Horizontal	Vertical
P01	VGA mode 3	31.469	59.940	25.175	Negative	Negative	
P02	VGA VESA 75 Hz	37.500	75.000	31.500	Negative	Negative	
P03	VGA VESA 85 Hz	43.269	85.008	36.000	Negative	Negative	
P04	VGA (non-CRT)	29.531	59.780	23.625	Positive	Negative	
P05	SVGA VESA 60 Hz	37.879	60.317	40.000	Positive	Positive	
P06	SVGA VESA 75 Hz	46.875	75.000	49.500	Positive	Positive	
P07	SVGA VESA 85 Hz	53.674	85.061	56.250	Positive	Positive	
P08	SVGA (non-CRT)	36.979	59.837	35.500	Positive	Negative	
P09	XGA VESA 60 Hz	48.363	60.004	65.000	Negative	Negative	
P10	XGA VESA 75 Hz	60.023	75.029	78.750	Positive	Positive	
P11	XGA VESA 85 Hz	68.677	84.997	94.500	Positive	Positive	
P12	WXGA* (CRT 60 Hz)	47.693	59.992	80.125	Negative	Positive	
P13	WXGA* (non-CRT)	47.396	59.995	68.250	Positive	Negative	
P14	SXGA* VESA 60 Hz	63.981	60.020	108.000	Positive	Positive	
P15	SXGA* (non-CRT)	63.194	59.957	91.000	Positive	Negative	
P16	VGA TEXT	31.469	70.087	28.322	Negative	Positive	
P17	1024 x 768 VGA (non-CRT)	47.297	59.870	56.000	Positive	Negative	
P18	1280 x 768 WXGA* (CRT 75 Hz)	60.091	74.926	102.875	Negative	Positive	

\* SXGA and WXGA images are down-converted for display.

#### BKM-220D Connector Panel

SD-SDI Input (BNC x 2)      SD-SDI monitor Output (BNC x 1)

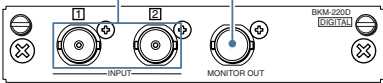

#### BKM-243HS Connector Panel

HD-SDI/SD-SDI Input (BNC x 2)      HD-SDI/SD-SDI monitor Output (BNC x 1)

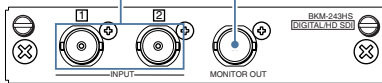

#### BKM-255DV Connector Panel

DV Input/Output (6-pin IEEE1394 x 2)

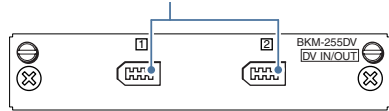

## MEU-WX2

Front Panel



Rear Panel



# Separate Type LUMA Monitors (Studio Type)

## ■ Superb Picture Performance

### Sophisticated I/P Conversion using X-Algorithm\*

All LCD monitors require two processes to map an interlace signal to the progressive LCD pixel array – I/P conversion and line scaling. The former converts the interlace signal to a progressive signal and the latter converts the input signal's line count to match the LCD pixel array. HD/SD-compatible monitors use LCD panels with resolutions higher than the SD signal. This means that the I/P process must be handled with great accuracy to keep its effect to a minimum after the line scaling.

Conventional LCD monitors conduct the I/P conversion simply by combining two adjacent picture fields into one picture frame. This method is effective for static areas of the image, but can often result in jagged shape noise along the oblique direction of fast-moving objects.

To avoid this, the separate type LUMA models incorporate Sony's original X-Algorithm technology, which uses a picture-adaptive Still Mode and Motion Mode for the I/P conversion. By examining the pixels in preceding fields, the I/P conversion will operate in either Still or Motion Mode. For pixels where motion is not detected, the I/P conversion will simply copy pixels from the preceding field to create the absent scanning line.

In contrast, when motion is detected, picture frames are created from the interlace signal on a field basis by interpolating the missing pixels in every other line.

X-Algorithm intelligently examines a significant area surrounding the missing pixel and uses the most logical pixels above, below, or in the diagonal direction of the moving picture part to insert a natural scanning line.

The direct result of X-Algorithm – much smoother image reproduction for both still and moving areas of interlace SD signals.

\* X-Algorithm is not used for HD signal input.

### High Purity Color Filters

The separate type LUMA monitors use precisely manufactured RGB color filters, allowing the reproduction of colors with stunning depth and saturation – creating highly natural images.

### ChromaTRU™ Color Processing Technology

Sony's innovative ChromaTRU technology brings CRT color reproduction and precise panel-to-panel color matching into the world of professional LCD monitoring – making LUMA Professional LCD Monitors ideal for both production and broadcast applications.

### Accurate Gamma and Stable White Balance

For an extra level of color reproduction accuracy, every LCD panel used in the separate type LUMA monitors is precisely color calibrated at the factory, providing consistent characteristics extremely close to CRT displays.

The colorimetry of an LCD display, by nature, can exhibit inaccurate R, G, B color coordinates and unbalanced R, G, B gamma curves, which can make precise color matching between multiple monitors a challenge. These are also the primary reasons why LCD color tone can slightly differ from CRTs.

The separate type LUMA monitors solve this problem by precisely calibrating each LCD panel's light output so that the R, G, B color coordinates are extremely close to those of a CRT monitor.

A second calibration is further applied so that white balance is maintained at a consistent color temperature throughout all grayscale levels.

The result of these precise calibrations is color reproduction reminiscent of CRT displays.

### Excellent Brightness and Contrast

While conventional LCD monitors can tend to be dark, the separate type LUMA monitors provide high-brightness and high-contrast images by use of super-wide aperture LCD panels.

### Extremely Wide Viewing Angle

The separate type LUMA monitors offer the most stable images within the LUMA Series when viewed from various angles. They offer a wide viewing angle of 170 degrees, horizontally and vertically, with virtually no reduction in picture contrast, color saturation, and hue shift. This allows precise images to be clearly viewed from various positions and angles – a critical requirement in professional video monitoring.

### AR (Anti-Reflection) Coated Protection Panel

The LCD panels of the separate type LUMA models use a robust AR-coated protection layer, which minimizes the chance of the panel being scratched during transportation. The AR coating additionally has two unique characteristics: it provides a high transmission rate of the internal light source to keep the picture as bright as possible, and it keeps reflection from ambient light to a minimum. As a result, when used in bright lighting conditions, high contrast is still maintained even in dark areas of the picture – a clear benefit over CRT monitors.

## Operational Convenience

### Advanced Marker Settings

The separate type LUMA Series can display various area markers, including a center marker, aspect markers, and a safety zone marker. The brightness of these markers can be selected from three different levels, white, gray, and dark gray. What's more, users can select either a black or gray matte to fill the outer area of the aspect markers.

These flexible marker controls, together with the choice of many different aspect markers, make the separate type LUMA Series an extremely convenient display device for a variety of shooting scenarios – from standard video acquisition to digital cinematography.

### Marker Variation

	16:9 Mode	4:3 Mode
Aspect Marker	4:3, 15:9, 14:9, 13:9, 1.85:1, 2.35:1, 1.85:1 & 4:3	16:9
Center Marker	○	
Safety Area	80%, 85%, 88%, 90%, 93%	

### Color Temperature/Gamma Selection

High/low color temperatures or user preset can be selected.

### Selectable Scan Size for Video Input and Aspect Ratio

The screen size can be selected between 5% over-scan and 0% scan modes. The aspect ratio can be switched between 16:9 and 4:3 according to the input signal.

### Three-color Tally

All separate type LUMA panels, excluding the LMD-322WS, come equipped with a tally lamp that can be lit up via a parallel remote connector. The status of the signal displayed on the monitor can be identified by the tally color – red, green, or amber.

### Smart APA (Auto Pixel Alignment) for Computer Input

The image size can be automatically adjusted to its optimal setting with the one-touch APA key.

### Parallel Remote Control

The MEU-WX2 can be controlled remotely via its parallel remote connector. There are 31 functions in the remote menu (such as the ability to switch input signals), of which seven can be allocated to the connector.

### Stereo Audio Monitoring

The MEU-WX2 is equipped with stereo speakers (0.5 W + 0.5 W), which enable the user to monitor audio.

### Protected Controls

The key-inhibit function helps prevent inadvertent operations from the control panel.

## Convenient Installation

By nature, the use of LCD technology in the LUMA Series eliminates many concerns inherent in CRT monitors. These include convergence alignments, geometric distortion, flicker, and image burn-in. The LUMA Series is also completely resistant to magnetic fields, making them easier to install than CRT monitors.

### Mounting Flexibility

#### Mountable in a 19-inch EIA Standard Rack (LMD-212S/LMD-172WS/LMD152S)

The LMD-172WS (7U high) and LMD-152S (7U) can be mounted in a 19-inch EIA standard rack with the optional MB-522A and MB-524 Mounting Bracket, respectively. The MEU-WX2 (1U high) can be mounted in a 19-inch EIA standard rack with the supplied mounting bracket. Although wider than the 19-inch rack, the LMD-212S (10U high) can also be rack-mounted using the optional MB-523 Mounting Bracket.

#### Mounting the LMD-322WS

The large screen LMD-322WS can also be mounted on the optional SU-559 Rolling Floor Stand, SPMTRI/C Table Stand or on a wall using the mounting hooks (330 x 330 mm pitch) on the rear of the display.

### VESA Mounting

Complying with VESA standards, the LMD-232WS, LMD-212S, LMD-172WS, and LMD-152WS can easily be mounted (75 x 75 mm pitch) on a wall or a ceiling. Although large in screen size, these monitors are thin and lightweight because the signal-processing circuitry is contained in the separate MEU-WX2. In addition, the arm of the displays can be adjusted with more flexibility because only one cable is required to connect the display to the MEU-WX2.

## Other Features

- H/V Delay Function
- ACC Off
- DC Operation (LMD-172WS, LMD-152S via the MEU-WX2)\*
- Setup Level for Analog Component and NTSC signal
- Sub Control on Contrast, Chroma, Phase, and Brightness
- Blue-Only Mode
- Monochrome Mode
- Auto Chroma/Phase Setup
- Power-saving Function (computer input only)
- DCC-2B Plug and Play (computer input only)

\* SMF-600 Extension Cable cannot be used for DC operation.

# One-piece Type LUMA monitors

The one-piece type LUMA monitors offer the best quality-per-cost balance for SD signal monitoring. They are designed exclusively for SD video input and offer the most natural picture reproduction of such (525/60i and 625/50i) signals. With all signal processing and interfaces built into their slim panels, these monitors offer a variety of analog interfaces ranging from analog composite and Y/C to component video. In addition, SD-SDI input is offered on the higher-grade LMD-2020 and LMD-1420 models. These LUMA monitors are optimized to replace CRT monitors at the Sony PVM-L2 and PVM-L1 range.



LMD-2020



LMD-1420



LMD-2010



LMD-1410

## Two Panel Sizes and Two Series

The one-piece type LUMA monitors are offered in two grades – the LMD-2010 and LMD-1410, which provide the basic features for professional picture monitoring, and the LMD-2020 and LMD-1420 for more advanced monitoring.

### Model Types

	Panel Aspect Ratio	Panel Size*	Desktop Stand	Mounting Holes (mm)	
				19-inch Rack	VESA Mounting
LMD-2020	4:3	20.1-inch	Supplied	Optional MB-527	100 x 100 mm
LMD-1420	4:3	14-inch	Supplied	Optional MB-526	100 x 100 mm
LMD-2010	4:3	20.1-inch	Supplied	Optional MB-527	100 x 100 mm
LMD-1410	4:3	14-inch	Supplied	Optional MB-526	100 x 100 mm

\* Viewable area measured diagonally.

## Input Versatility

As standard, all one-piece type LUMA monitors come equipped with a full range of analog SD inputs including analog composite NTSC and PAL, Y/C (S-Video), and 525i/625i component and RGB.

The LMD-2020 and LMD-1420 add the further capability of SD-SDI input through the use of the optional BKM-320D SD-SDI input adaptor.

### Signal Interfaces

	Input Signal			Interface			
	System	Total Line	Active Line	Composite	S-Video	Component/RGB	SD-SDI The Optional BKM-320D
LMD-2020	480/60i*	525	483	○	○	○	○
LMD-1420	575/50i	625	575	○	○	○	○
LMD-2010	480/60i*	525	483	○	○	○	○
LMD-1410	575/50i	625	575	○	○	○	—

\* Also accepts 59.94 Hz field rate.

### Connector Panel for LMD-2020/LMD-1420

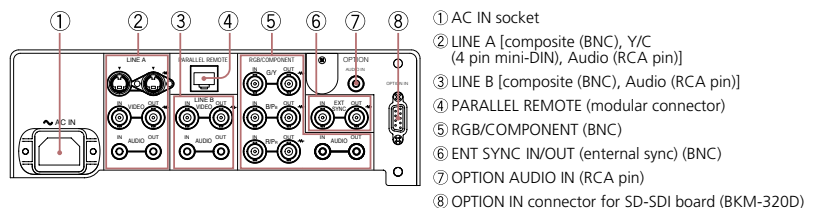

### Connector Panel for LMD-2010/LMD-1410

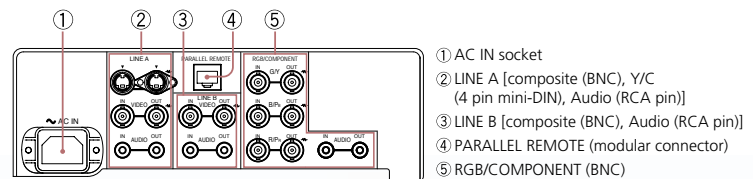



## High Picture Quality

### Precise reproduction of interlace SD images

The one-piece type LUMA monitors incorporate VGA-type LCD panels with 640 x 480 pixel resolution for precise reproduction of interlace SD video images. To display an interlace signal on a progressive LCD monitor, it must first be converted to a progressive signal (I/P conversion). In this process, the absent lines of the interlace field are interpolated using data from the previous field, or data from adjacent lines within the same field. A second process, called 'line scaling' is then executed to match the input signal's line count to the vertical resolution of the LCD display. However, since scaling involves duplication or removal of scanning lines, it can have a large effect on picture quality in image areas where I/P conversion is difficult to achieve. This effect can only be suppressed to a negligible level using highly sophisticated but costly I/P conversion technology. To minimize this effect while maintaining best quality-per-cost value, the LMD-2020, LMD-1420, LMD-2010, and LMD-1410 use specially selected VGA (640 x 480 pixels) LCDs that allow moderate scaling to be used for the reproduction of 525 and 625 interlace signals. The result is extremely precise image reproduction of interlace SD signals, for any type of picture content – and without the use of expensive I/P conversion technology.

### Excellent Brightness and Contrast

The one-piece type LUMA monitors provide high-brightness and high-contrast images by use of wide aperture LCD panels. In addition, the use of precisely manufactured RGB color filters allows these monitors to reproduce colors with stunning depth and saturation – creating highly natural images.

### Wide Viewing Angle

The LCD panels used in the one-piece type LUMA monitors have a wide viewing angle of 170 degrees, both horizontally and vertically, with minimal reduction in picture contrast. This allows images to be viewed from various positions and angles.

### AR (anti-reflection) Coated Protection Panel (LMD-2020/LMD-1420 only)

The LCD panels of the one-piece type LUMA models use a robust AR-coated protection layer, which minimizes the chance of the panel being scratched during transportation. The AR coating additionally has two unique characteristics: it provides a high transmission rate of the internal light source to keep the picture as bright as possible, and it keeps reflection from ambient light to a minimum. As a result, when used in bright lighting conditions, high contrast is still maintained even in dark areas of the picture – a clear benefit over CRT monitors.

## Operational Convenience

### 4:3/16:9 Switchable Display

The scan aspect ratio can be switched between 4:3 and 16:9.

### Selectable Scan Size

The scan size can be selected between 5% over-scan and -3% underscan modes.

### Advanced Marker Settings (LMD-2020/LMD-1420 only)

The LMD-2020 and LMD-1420 can display various area markers, including a center marker, aspect markers, and a safety zone marker. The brightness of these markers can be selected from three different levels, white, gray, and dark gray. What's more, users can select either a black or gray matte to fill the outer area of the aspect markers. These flexible marker controls, together with the choice of many different aspect markers, make these monitors an extremely convenient display device for a variety of shooting scenarios.

	16:9 Mode	4:3 Mode
Aspect Marker	4:3, 15:9, 14:9, 13:9	16:9
Center Marker	○	
Safety Area	80%, 85%, 88%, 90%, 93%	

### Color Temperature/Gamma Selection

High/low color temperatures or user preset can be selected.

### Three-color Tally (LMD-2020/LMD-1420 only)

The LMD-2020 and LMD-1420 come equipped with a tally lamp that can be lit up via a parallel remote connector. The status of the signal displayed on the monitor can be identified by the tally color – red, green, or amber.

### Parallel Remote Control

The one-piece type LUMA monitors can be controlled remotely via a parallel remote connector. There are 25 functions in the remote menu (such as the ability to switch input signals), of which seven can be allocated to the connector.

### Monaural Audio Monitoring

All one-piece type LUMA monitors are equipped with a speaker (0.5 W), which enables the user to monitor audio.

### Protected Controls

The key-inhibit function helps prevent inadvertent operations from the control panel.

## Convenient Installation

The one-piece type LUMA models, when compared to their PVM monitor equivalents, are 40% slimmer, 30-50 % lighter, and consume much less power. And, like all other LUMA monitors, they eliminate the many concerns inherent in CRT monitors, including convergence misalignments, geometric distortion, flicker, image burn-in, and the effect of magnetic fields.

### Mounting Flexibility Mountable in a 19-Inch EIA Standard Rack

All one-piece type LUMA monitors can be mounted in a 19-inch EIA standard rack using optional mounting brackets. The 9U-high LMD-2020 and LMD-2010 use the MB-527 Mounting Brackets and the 7U-high LMD-1420 and LMD-1410 use the MB-526 Mounting Brackets.

### VESA Mounting

Complying with VESA standards, the one-piece type LUMA monitors can easily be mounted (100 x 100 mm pitch) on a wall or a ceiling.

## Other Features

- Setup Level for Analog Component and NTSC signal
- Blue-Only Mode (LMD-2020/LMD-1420 only)
- 4:3 Zoom
- External Sync In (LMD-2020/LMD-1420 only)

# Handheld Type LUMA Monitors

The handheld type LUMA monitor brings a new level of monitoring convenience into the field and the studio. The LMD-9050, designed for HD/SD multi-format capability, can be AC or DC so that it can be hand-held, situated on a desk, or mounted in standard racks. With a high-grade LCD panel, the LMD-9050 offers a range of interfaces on its rear panel, from analog composite, analog component to digital HD-SDI.



LMD-9050



LMD-9050 with supplied AC adaptor

## Panel Type

	Panel Aspect Ratio	Panel Size*	Acceptable Format
LMD-9050	4:3	8.4-inch	HD/SD

\* Viewable area measured diagonally.

## Input Versatility

The LMD-9050 provides all inputs as standard, keeping the unit simple and clean. For typical SD video monitoring, the LMD-9050 offers interfaces for analog composite (NTSC/PAL), analog component, RGB (525/60i and 625/50i), Y/C (S-Video), and SD-SDI.

The multi-format LMD-9050 also accepts a variety of progressive SD and HD formats through its HD-SDI interface\*, including 480/60P and 576/50P, and high-definition 1080/60i, 1080/50i, and 720/60P. It can also accept 1080/24PsF and 1080/25PsF.

\* SD-SDI and HD-SDI input share the same interface, which offers automatic signal-type detection.

## Input Signals

	System	Input Signal			Standard Interface			
		Total Lines	Active Line	Aspect Ratio	Composite Y/C (x 1)	RGB Component (x 1)	SDI	
LMD-9050	575/50i	625	575	16:9/4:3	○	○	—	—
	480/60i*	525	483	16:9/4:3	○	○	○	○
	480/60P	525	483	16:9/4:3	—	○	—	—
	576/50P	625	576	16:9/4:3	—	○	—	—
	1080/24PsF	1125	1080	16:9	—	○	—	○
	1080/50i	1125	1080	16:9	—	○	—	○
	1035/60i*	1125	1035	16:9	—	○	—	○
	1080/60i*	1125	1080	16:9	—	○	—	○
	720/60P	750	720	16:9	—	○	—	○

\* Also accepts 59.94Hz field rate.

## Connector Panel for LMD-9050

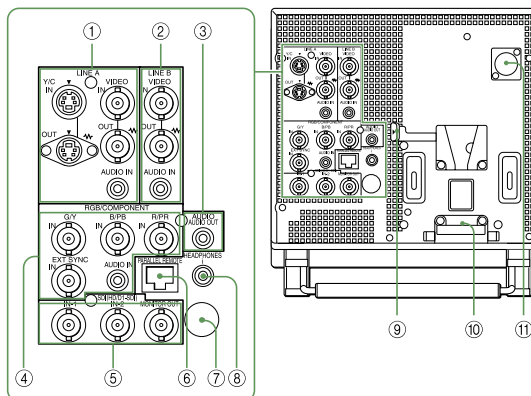

- ① Line A
  - Y/C In/Out (4-pin mini-DIN x 2)
  - Composite In/Out (BNC x 2)
  - Audio In (mini jack)2
- ② Line B
  - Composite In/Out (BNC x 2)
  - Audio In (mini jack)
- ③ Audio Out (mini jack)
- ④ RGB/Component
  - G/Y, B/Pb, R/PR IN (BNC x 3)
  - EXT Sync (BNC x 1)
  - Audio In (mini jack)
- ⑤ HD-SDI/SD-SDI In/Out
  - SDI In (BNC x 2)
  - Monitor Out (BNC x 1)
- ⑥ Parallel Remote (modular 8-pin)
- ⑦ Service Terminal
- ⑧ Headphones Jack
- ⑨ AC Adaptor Eject button
- ⑩ AC adaptor Attachment place
- ⑪ DC 12V In (XLR-type 4-pin)

## High Picture Quality

### Excellent Brightness and Contrast

The LMD-9050 provides high-brightness and high-contrast images by use of the wide aperture LCD panel. In addition, the use of precisely manufactured RGB color filters allows this monitor to reproduce colors with stunning depth and saturation – creating highly natural images.

### Wide Viewing Angle

The LCD panel used in the handheld type LUMA monitor has a wide viewing angle of 170 degrees, both horizontally and vertically, with minimal reduction in picture contrast.

### AR (anti-reflection) Coated Protection Panel

The LMD-9050 uses a robust AR-coated protection layer, which minimizes the chance of the panel being scratched during transportation – an extremely important criteria for use in the field or in any mobile application. The AR coating additionally has two unique characteristics: it provides a high transmission rate of the internal light source to keep the picture as bright as possible, and it keeps reflection from ambient light to a minimum.

As a result, when used in bright lighting conditions, high contrast is still maintained even in dark areas of the picture.

## Operational Convenience

### ENG Kit VF-509

The LMD-9050 is a strategic choice for use in ENG and EFP field operations. When compared to CRT displays, the picture contrast of these monitors is much less affected by ambient light, allowing clear images to be viewed even under strong sunlight. For further protection, the optional VF-509 ENG kit provides a Viewing Hood, Carrying Handle, and Connector Protector.

### 4:3/16:9 Switchable Display

The scan aspect ratio can be switched between 4:3 and 16:9.

### Selectable Scan Size

The scan size can be selected between 5% over-scan, 0%, and -3% underscan modes.



LMD-9050 with ENG KIT VF-509

### Advanced Marker Settings

The LMD-9050 can display various area markers, including a center marker and aspect markers.

The brightness of these markers can be selected from three different levels, white, gray, and dark gray, and their width can be selected from FINE, STANDARD, and BOLD. What's more, users can select either a black or gray matte to fill the outer area of the aspect markers. These flexible marker controls, together with the choice of many different aspect markers, make this handheld type LUMA monitor extremely convenient for a variety of shooting scenarios.

	16:9 Mode	4:3 Mode
Aspect Marker	4:3, 15:9, 14:9, 13:9, 1.85:1, 2.35:1, 1.85:1 & 4:3	16:9
Center Marker		○

### Color Temperature/Gamma Selection

High/low color temperatures or user preset can be selected.

### Three-color Tally

The LMD-9050 comes equipped with a tally lamp that can be lit up via a parallel remote connector.

The status of the signal displayed on the monitor can be identified by the tally color – red, green, or amber.

### Parallel Remote Control

The handheld type monitor can be controlled remotely via their parallel remote connector. There are 27 functions in the remote menu (such as the ability to switch input signals), of which seven can be allocated to the connector.

### Monaural Audio Monitoring

The handheld type monitor is equipped with a speaker (0.5 W), which enables the user to monitor audio.

### Protected Controls

The key-inhibit function helps prevent inadvertent operations from the control panel.

## Convenient Installation

As with all other LUMA monitors, the LMD-9050 eliminates the many concerns inherent to CRT monitors, including convergence misalignments, geometric distortion, flicker, image burn-in, and the effect of magnetic fields.

### Mounting Flexibility

The LMD-9050 is 5U high and half-rack wide. Using the optional MB-525 Mounting Bracket with a nine-step tilt capability, two units can be installed side-by-side in a 19-inch EIA standard rack.

## Other Features

- Setup Level for Analog Component and NTSC signal
- Sub Control on Contrast, Chroma, Phase, and Brightness
- Blue-only mode • Monochrome mode
- Power-saving Function • 4:3 Zoom

# Multi-display Type LUMA monitors

The multi-display type LUMA monitors integrate high-quality LCD panels into an extremely thin and lightweight, 19-inch rack-mountable chassis. They can be AC or DC powered. These monitors are particularly handy for viewing multiple SD signal sources in space-confined environments such as in OB vehicles, machine rooms, and desktops – or any general application where multiple pictures must be viewed.



LMD-7220W



LMD-5320



LMD-4420

## LMD-7220W Connector Panel

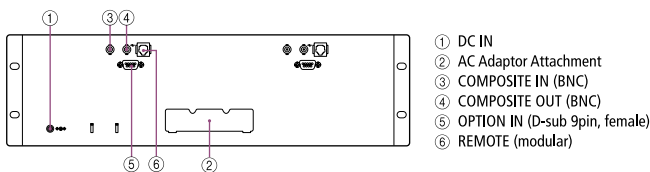

## LMD-5320 Connector Panel

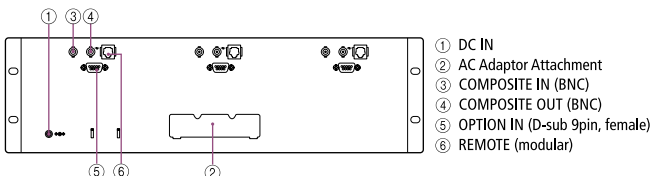

## LMD-4420 Connector Panel

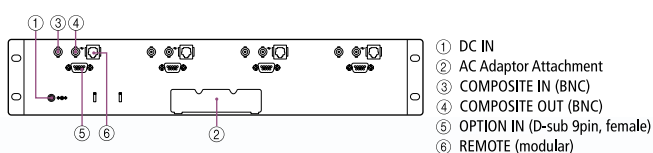

## Panel Types

	Panel Aspect Ratio	Number of Displays	Display Size* <sup>1</sup>
LMD-4420	4:3	4	4-inch
LMD-5320	4:3	3	5.6-inch
LMD-7220W	16:9* <sup>2</sup>	2	7-inch

\*<sup>1</sup> Viewable area measured diagonally.

\*<sup>2</sup> HD signals must be externally down-converted for display.

## Input Capability

All multi-display type LUMA monitors accept either composite or SDI signals. Each LCD panel is equipped with a composite connector as standard, while SDI input can be added simply by installing the optional BKM-320D\*.

\* One BKM-320D is required per screen.

## High Picture Quality

Although small in size, the multi-display type LUMA monitors incorporate high-grade LCD panels with high brightness and high contrast. These LCD panels also offer a wide viewing angle, both vertically and horizontally.

## Operational Convenience

### Selectable Aspect Ratio (LMD-7220W only)

The scan aspect ratio of the displays on the LMD-7220W can be switched between 16:9 and 4:3 by pressing a button on the front panel.

### Three-color Tally

The LMD-7220W, LMD-5320, and LMD-4420 come equipped with a tally lamp that can be lit up via a parallel remote connector. The status of the signal displayed on the monitor can be identified by the tally color – red, green, or amber.

### Parallel Remote Control

The multi-display type LUMA monitors can be controlled remotely via their parallel remote connector. There are 5 functions (LMD-7220W)/4 functions (LMD-5320/LMD-4420) in the remote menu (such as the ability to switch input signals), which can be allocated to the connector.

## Low Power Consumption

Compared to conventional CRT multiple monitors, multi-display type LUMA monitors offer drastic reductions in power consumption and room-cooling requirements. This is a huge bonus in applications where power consumption is critical, such as OB van installations.

## Slim and Light

Thanks to their thin and lightweight designs, the multi-display type LUMA monitors are ideal for installations where space is limited.

## Convenient Installation

All multi-display type LUMA monitors are mountable on a 19-inch EIA standard rack. For viewing convenience, the LMD-7220W and LMD-5320 offer a 5-step tilt mechanism, and the LMD-4420 offers a 3-step tilt mechanism. And like all other LUMA monitors, they eliminate the many concerns inherent to CRT monitors, including convergence misalignments, geometric distortion, flicker, image burn-in, and the effect of magnetic fields.

# Feature Comparison

Monitor System	Studio Type					One-piece Type				Handheld Type	Multi-display Type		
	LMD-322WS MEU-WX2	LMD-232WS MEU-WX2	LMD-212S MEU-WX2	LMD-172WS MEU-WX2	LMD-152S MEU-WX2	LMD-2020	LMD-1420	LMD-2010	LMD-1410	LMD-9050	LMD-7220W	LMD-5320	LMD-4420
Picture Resolution	1280 x 768 dots		1024 x 768dots	1280 x 768 dots	1024 x 768 dots	640 x 480 dots				1024 x 768 dots	480 x 234 dots	320 x 234 dots	480 x 234 dots
Picture Size	31.6-inch	23-inch	21.2-inch	16.7-inch	15-inch	20.1-inch	14-inch	20.1-inch	14-inch	8.4-inch	2x7-inch	3x5.6-inch	4x4-inch
LCD Panel	a-Si TFT Active Matrix					a-Si TFT Active Matrix				a-Si TFT Active Matrix	a-Si TFT Active Matrix		
Acceptable computer system	VGA to WXGA					No				No	No		
Panel aspect Ratio	15:9		4:3	15:9	4:3	4:3				4:3	16:9	4:3	
Protection Panel/AR Coating	Yes					Yes	No			Yes	No		
16:9 Capability	Yes					Yes				Yes	Yes	No	
HD or SD	HD/SD					SD only				HD/SD	SD only		
Composite Video Input/Output	1x					2x				2x	1x		
Y/C Input/Output	1x					1x				1x	No		
Component (Y,R-Y,B-Y)/RGB Input	1x					1x				1x	No		
SD-SDI video input	2x (with BKM-220D or BKM-243HS)					1x (with BKM-320D)		No		2x HD or SD	1x (with BKM-320D)		
HD-SDI video input	2x (with BKM-243HS)					No				Auto detective	No		
SDI with Audio decoding	Yes					No				Yes	No		
Computer Input	Yes					No				No	No		
iLINK video input	2x (with BKM-255DV)					No				No	No		
Audio Input/Output						Yes				Yes	No		
External Sync Input/Output	Yes					Yes		No		Yes	No		
EIA 19-inch Rack Mounting	No		MB-523	MB-522A	MB-524	MB-527	MB-526	MB-527	MB-526	MB-525	Supplied		
VESA Mounting	Not Applicable		75 x 75 holes			100 x 100 holes				Not Applicable	Not Applicable		
Stand(s)	SPMTR/C Floor		SU-558			Stand supplied				Stand supplied	Not Applicable		
	SU-559 Rolling Floor												
Overscan	Yes					Yes				Yes	No		
Color Temperature	Selectable					Selectable				Selectable	Selectable		
Blue Only	Yes					Yes		No		Yes	No		
H/V delay	Yes					No				No	No		
Tally	No		3-Color			3-Color		No		3-Color	3-Color		
Area Marker	Yes					Yes		No		Yes	No		
Li-Ion battery Operation	No					No				No	No		
DC Operation	LMD-322W: No MEU+ LMD-322W: No	LMD-232W: Yes MEU+ LMD-232W: No	LMD-212: Yes MEU+ LMD-212: No	LMD-172W: Yes MEU+ LMD-172W: Yes	LMD-152: Yes MEU+ LMD-152: Yes	No				Yes	Yes		

\* Viewable area measured diagonally.

# Specifications

## Multiformat Engine Unit



**MEU-WX2**

Input/Output	
Input	Connector/Slot
	G/Y/Composite      B/PB/S-Y      R/PR/S-C
	BNC, Loop through, automatic 75 Ω termination (x1)
Composite	1.0 Vp-p ±3 dB, sync negative
Y/C	1.0 Vp-p ±3 dB, sync negative      0.286 Vp-p ±3 dB (NTSC) 0.3 Vp-p ±3 dB (PAL)
Component	0.7 Vp-p ±3 dB
RGB	0.7 Vp-p ±3 dB      0.7 Vp-p ±3 dB
Audio in (for Video signals)	Stereo mini jack (x1) -5 dBu, more than 47 kΩ
OPTION A-1	Option Slot (x1)
OPTION A-2	
OPTION B-1	Option Slot (x1)
OPTION B-2	
Ext. sync	BNC, Loop-through, automatic 75 Ω termination 0.3 ~ 4 Vp-p ±3 dB, sync negative, usable tri-level sync signal 0.6 Vp-p ±3 dB
Computer	HD D-sub 15-pin (female) (x1), 0.7 Vp-p, 75 Ω, positive (R,G,B)
Audio in (for computer signals)	Stereo mini jack (x1) -5 dBu, more than 47 kΩ
DC IN*	XLR 4-pin (male) (x1), 12 V, output impedance 0.05 Ω or less
Output	
Audio monitor out	Stereo mini jack (x1)
Speaker Out	Stereo (0.5 W + 0.5 W)
PARALLEL Remote	Modular 8-pin (Assignable)
Display Signal Out	Exclusive connector (x1)
Display DC Out**	XLR 4-pin (female) (x1), DC 16.5 V (when AC power is supplied) DC 12 V (when DC power is supplied)
<b>Video</b>	
Horizontal Scanning Frequency	15 to 45 kHz
Frame Scanning Frequency	48 to 60 Hz
<b>Computer</b>	
Dot clock	110 MHz
Horizontal Scanning Frequency	28 to 69 kHz
Vertical Scanning Frequency (frame)	60 to 85 Hz
Plug & Play	DDC-2B
<b>General</b>	
Power consumption	Maximum: Approx. 92 W (with 2 x BKM-243HS and LMD-230W) Standard: Approx. 26 W (without optional input adaptor)
Power requirement	AC 100 to 240 V±10%, 50/60 Hz, DC 12 V (LMD-170W only)
Operating Temperature	32 to 95°F (0 to 35°C)
Operating Humidity	30 to 85% (no condensation)
Storage and Trans. Temperature	14 to 104°F (-10 to 40°C)
Storage & Transport Humidity	0 to 90%
Operating/Storage/Trans. Pressure	700 to 1060 hPa
Dimensions (W x H x D) (excluding protrusions)	17 1/8 x 1 3/4 x 12 1/8 inches (434 x 44 x 305 mm)
Weight	Approx. 9 lb 15 oz (4.5 Kg)***
Supplied Accessories	AC cord, AC plug holder, Mounting bracket, Operating instructions, CD-ROM, Warranty card

### Dimensions

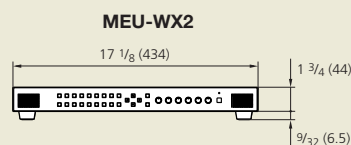

Unit: inches (mm)

## Separate Type (Studio Type)



Picture Performance											
Type	a-Si TFT Active Matrix LCD with a multi-layer AR-coated protection panel										
Resolution	1280 x 768 dots			1024 x 768 dots		1280 x 768 dots		1024 x 768 dots			
Pixel efficiency	99.99%										
Dot pitch	0.537 x 0.537 mm		0.3915 x 0.3915 mm		0.420 x 0.420 mm		0.284 x 0.284 mm		0.297 x 0.297 mm		
Picture Size (H x W) (Diagonal)	Approx. 27 1/8 x 16 1/5 inches (687 x 412 mm) 31 5/8 inches (802 mm)		Approx. 19 3/4 x 11 7/8 inches (501 x 301 mm) 23 inches (584 mm)		Approx. 17 x 12 3/4 inches (430 x 323 mm) 21 1/4 inches (538 mm)		Approx. 14 3/8 x 8 5/8 inches (364 x 218 mm) 16 3/4 inches (424 mm)		Approx. 12 x 9 inches (304 x 228 mm) 15 inches (380 mm)		
Aspect	15:9				4:3		15:9		4:3		
Colors	16,770,000 colors										
Viewing Angle	85°/85°/85°/85° (typical) (up/down/left/right contrast>10:1)										
Input											
Display Input connector	DVI-D										
Digital input											
Dot clock	25.175 MHz	68.250 MHz	25.175 MHz	68.250 MHz	25.175 MHz	65.000 MHz	25.175 MHz	68.250 MHz	25.175 MHz	65.000 MHz	
Scanning Frequency	Horizontal	31.469 kHz	47.396 kHz	31.469 kHz	47.396 kHz	31.469 kHz	48.363 kHz	31.469 kHz	47.396 kHz	31.469 kHz	48.363 kHz
	Vertical	59.940 Hz	59.995 Hz	59.940 Hz	59.995 Hz	59.940 Hz	60.004 Hz	59.941 Hz	59.995 Hz	59.941 Hz	60.004 Hz
General											
Power Consumption	Approx. 120 W		Approx. 65 W		Approx. 84 W		Approx. 53 W		Approx. 29 W		
Power requirement	AC 100 to 240 V ±10%, 50/60 Hz		DC 16.5 V		DC 16.5 V		DC 16.5 V/12V		DC 16.5 V/12V		
Operating Temperature	32 to 95 °F (0 to 35 °C)										
Operating Humidity	30 to 80% (no condensation)										
Storage & Transport Temperature	-14 to 104 °F (10 to 40 °C)										
Storage & Transport Humidity	0 to 80%										
Operating/Storage/Trans. Pressure	700 to 1060 hPa										
Dimensions (W x H x D)	31 1/8 x 20 1/4 x 3 3/4 inches * (790 x 512 x 94 mm) *		22 1/4 x 14 3/4 x 3 1/8 inches * (563 x 372 x 78 mm) *		20 3/8 x 16 1/8 x 3 1/4 inches * (515 x 409 x 81 mm) *		17 3/8 x 11 5/8 x 3 inches * (441 x 294 x 76 mm) *		15 x 11 5/8 x 2 7/8 inches * (379 x 297 x 70 mm) *		
Weight	Approx. 38 lb 13 oz (Approx. 17.6 Kg)** Approx. 108 lb 22 oz (Approx. 49.6 Kg)***		Approx. 14 lb 2 oz (Approx. 6.4 Kg)** Approx. 25 lb 9 oz (Approx. 11.6 Kg)***		Approx. 15 lb 7 oz (Approx. 6.7 Kg)** Approx. 26 lb 4 oz (Approx. 11.9 Kg)***		Approx. 10 lb 9 oz (Approx. 4.8 Kg)** Approx. 21 lb 1 oz (Approx. 10.0 Kg)***		Approx. 8 lb 13oz (Approx. 4.0 Kg)** Approx. 20 lb 5 oz (Approx. 9.2 Kg)***		
	AC cord, AC plug holder, Display interface cable, Warranty card, Operating instructions		Display interface cable, Warranty card, Operating instructions								

\* without the optional monitor stand and not including the projection parts \*\* without the optional SU-558 monitor stand, SU-559 for LMD-322WS \*\*\* with the optional SU-558 monitor stand, SU-559 for LMD-322WS

Dimensions										
<b>LMD-322WS</b>		<b>LMD-232WS</b>		<b>LMD-212S</b>		<b>LMD-172WS</b>		<b>LMD-152S</b>		
31 1/8 (790)		22 1/4 (563)		20 3/8 (515)		17 3/8 (441.4)		15 (378.9)		
20 1/4 (512)		14 3/4 (372)		16 1/8 (409)		11 5/8 (294)		11 5/8 (297)		
3 3/4 (94)		3 1/8 (78)		3 1/4 (81)		3 (76)		2 3/4 (67)		

Unit: inches (mm)

# Specifications

## One-piece Type



Picture Performance				
Type	A-Si TFT Active Matrix LCD with a multi-layer AR-coated protection panel		A-Si TFT Active Matrix LCD	
Resolution	640 x 480 dots			
Pixel efficiency	99.99%			
Dot pitch	0.213 x 0.638 mm	0.443 x 0.443 mm	0.213 x 0.638 mm	0.443 x 0.443 mm
Picture Size (H x W) (Viewable area) (Diagonal)	Approx. 16 1/8 x 12 1/8 inches (Approx. 408 x 306mm) 20.1-inch (510 mm)	Approx. 11 1/4 x 8 3/8 inches (Approx. 283 x 212 mm) 14-inch (354 mm)	Approx. 16 1/8 x 12 1/8 inches (Approx. 408 x 306mm) 20.1-inch (510 mm)	Approx. 11 1/4 x 8 3/8 inches (Approx. 283 x 212 mm) 14-inch (354 mm)
Aspect	4:3			
Colors	Approx. 16,700,000 colors	Approx. 16,200,000 colors	Approx. 16,700,000 colors	Approx. 16,200,000 colors
Viewing Angle	85°/85°/85°/85° (typical) (up/down/left/right contrast>10:1)			
Input				
Line A	Composite	BNC x 1, 1.0 Vp-p ±3dB 75 Ω termination, sync 0.3 Vp-p negative		
	Y/C	DIN 4 pin x 1 Y: 1.0Vp-p ±3 dB, 75 Ω termination C: 0.286 Vp-p ±3 dB (NTSC), 0.3 Vp-p ±3 dB (PAL), 75 Ω termination, sync 0.3 Vp-p negative		
	Audio in	RCA pin x 1, -5 dBu 47 Ω or higher		
Line B	Composite	BNC x 1, 1.0 Vp-p ±3dB 75 Ω termination, sync 0.3 Vp-p negative		
	Audio in	RCA pin x 1, -5 dBu 47 Ω or higher		
RGB/Component				
	RGB/Component	BNC x 3, 0.7 Vp-p ±3 dB 75 Ω termination, Sync on Green 0.3Vp-p, negative		
	Audio in	RCA pin x 1, -5 dBu 47 Ω or higher		
Option	D1-SDI	D-sub 9-pin x 1		-
	Audio in	RCA pin x 1 -5 dBu 47 Ω or higher		-
External Sync		BNC x 1		-
Remote	Parallel remote		Moduler 8-pin (Assignable)	
Output				
Line A	Composite	BNC x 1, Loop-through, with 75 Ω automatic termination		
	Y/C	DIN 4 pin x 1, Loop-through, with 75 Ω automatic termination		
	Audio out	RCA pin x 1		
Line B	Composite	BNC x 1, Loop-through, with 75 Ω automatic termination		
	Audio out	RCA pin x 1, Loop-through		
RGB/Component				
	RGB/Component	BNC x 3, Loop-through, with 75 Ω automatic termination		
	Audio out	RCA pin x 1, Loop-through		
External Sync		BNC x 1 Loop-through with 75 Ω automatic termination		-
General				
Power Consumption	Approx. 87 W	Approx. 51 W	Approx. 84 W	Approx. 48 W
Power requirement	AC 100 to 240 V, 50/60 Hz			
Operating Temperature	0 to 35°C			
Operating Humidity	30 to 85% (No condensation)			
Storage & Transport Temperature	-10 to 40°C			
Storage & Transport Humidity	0 to 90 %			
Operating/Storage/Trans. Pressure	700 to 1060 hPa			
Dimensions (W x H x D)				
	Dimension	Approx. 18 5/8 x 17 3/8 x 10 1/2 inch (470 x 441 x 264 mm)	Approx. 13 5/8 x 14 x 10 1/2 inch (343 x 354 x 264 mm)	Approx. 18 5/8 x 17 3/8 x 10 1/2 inch (470 x 441 x 264 mm)
	Dimension without stand	Approx. 18 5/8 x 15 5/8 x 3 1/2 inch (470 x 394 x 87mm)	Approx. 13 5/8 x 12 x 3 1/2 inch (343 x 304 x 87mm)	Approx. 18 5/8 x 15 5/8 x 3 1/2 inch (470 x 394 x 87mm)
Weight	Panel & Stand	Approx. 20 lb 5 oz (9.2 kg)	Approx. 14 lb 16 oz (6.8 kg)	Approx. 19 lb 3 oz (8.7 Kg)
	Panel only	Approx. 16 lb 9 oz (7.5 kg)	Approx. 11 lb 4 oz (5.1 kg)	Approx. 15 lb 7 oz (7.0 kg)
Supplied Accessories	AC power code, AC plug holder, Operating Instructions, CD-ROM, Using the CD-ROM Manual, Warranty card			

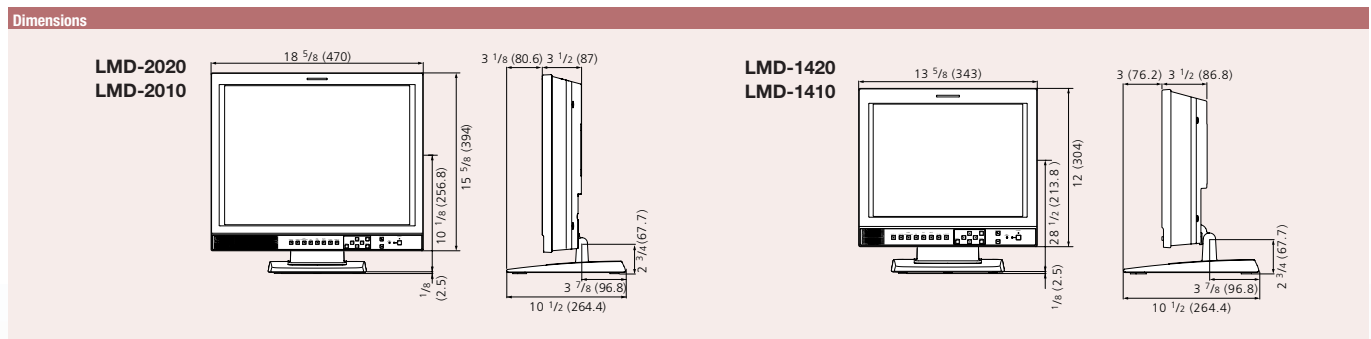

Unit: inches (mm)



# Handheld Type



**LMD-9050**

Picture Performance		
Type		a-Si TFT Active Matrix LCD with a multi-layer AR-coated protection panel
Resolution		1024 x 768 dots
Pixel efficiency		99.99%
Picture Size (H x W), (Viewable area) (Diagonal)		Approx. 6 3/4 x 5 1/8 inches, (Approx. 170.5 x 127.9 mms) 8.4-inch (213 mm)
Aspect		4:3
Colors		16,770,000 colors
Viewing Angle		85°/85°/85°/85° (typical) (up/down/left/right contrast>10:1)
Input		
Line A	Composite	BNC x 1, 1.0 Vp-p +3dB, -6 dB sync negative
	Y/C	4-pin mini-DIN x 1 Y : 1.0 Vp-p + 3dB, -6 dB sync negative C : 0.286 Vp-p ±3 dB (NTSC), 0.3 Vp-p ±3 dB (PAL)
	Audio	Mini jack x 1, -5 dBu 47 kΩ or higher
Line B	Composite	BNC x 1, 1.0 Vp-p +3 dB, -6 dB sync negative
	Audio	Mini jack x 1, -5 dBu 47 kΩ or higher
RGB/Component	RGB/Component	BNC x 3, RGB input : 0.7 Vp-p +3 dB, -6 dB (Sync On Green, 0.3 Vp-p sync negative) Component input : 0.7 Vp-p +3 dB, -6 dB (75% chrominance standard color bar signal)
	Audio	Mini jack x 1, -5 dBu 47 kΩ or higher
Ext.sync		BNC x 1, 0.3 to 4 Vp-p negative polarity binary
HD-SDI/D1-SDI		BNC x 2 (HD and D1 are automatically detected) Sampling frequency D1-SDI:Y/R-Y/B-Y 13.5 MHz, HD-SDI:Y/PB/PR 74.25 MHz Quantization 10 bits/sample
Remote	Parallel remote	Modular connector 8-pin x 1(Assignable)
Output		
Line A	Composite	BNC x 1, Loop-through, with 75 Ω automatic termination
	Y/C	4-pin mini-DIN x 1, Loop-through, with 75 Ω automatic termination
Line B	Composite	BNC x 1, Loop-through, with 75 Ω automatic termination
HD-SDI/D1-SDI Monitor output		BNC x 1, Output signal : amplitude 800 mVp-p ±10%, Output impedance : 75 Ω unbalanced
Audio output		Mini jack x 1, Loop-through
Headphones output		Mini jack x 1(Monaural), Loop-through
Speaker output		0.5 W (Monaural)
General		
Power Consumption		Monitor : Approx. 24 W, With AC Adaptor : Approx. 28 W
Power requirement		AC 100 to 240 V, 50/60 Hz, 0.82 A, DC 12 V 2.2 A
Operating Temperature		0 to 40°C
Operating Humidity		30 to 85 % (No condensation)
Operating/Storage/Trans. Pressure		700 to 1060 hPa
Storage & Transport Temperature		-10 to 40°C
Storage & Transport Humidity		0 to 90 %
Dimensions (W x H x D)		Approx. 8 5/8 x 8 1/8 x 5 3/8 inches (216 x 206 x 136.1 mm)
	Dimension with the supplied stand	Approx. 8 5/8 x 9 1/8 x 6 3/8 inches (216 x 230 x 159.5 mm)
	Dimension with the supplied stand and AC adaptor	Approx. 8 5/8 x 9 1/8 x 8 3/8 inches (216 x 230 x 210 mm)
Weight		Approx. 6 lb 10 oz (3.0 Kg)
	With the supplied stand	Approx. 7 lb 1 oz ( 3.2 Kg)
	With the supplied stand and AC adaptor	Approx. 8 lb 10 oz (3.9 Kg)
Supplied Accessories		AC adaptor (1), AC Cord (1), AC plug holder (1), Operating instructions (1), CD-ROM (1), Warranty card (1), Using the CD-ROM Manual (1)

## Handheld Type

**LMD-9050**

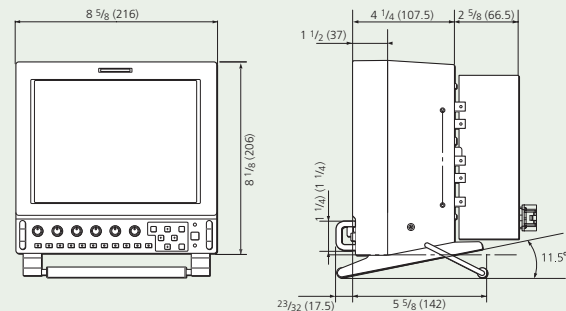

Unit: inches (mm)

# Specifications

## Multi-display Type



Picture Performance			
Type	a-Si TFT Active Matrix		
Resolution	480 x 234 dots	320 x 234 dots	480 x 234 dots
Pixel efficiency	99.99%		
Picture Size (H x W) (Viewable area) (Diagonal)	Approx. 6 1/8 x 3 1/2 inches (Approx. 154.1 x 86.6 mm) 7 inches (176.7 mm)	Approx. 4 1/2 x 3 3/8 inches (Approx. 113.3 x 84.7 mm) 5 5/8 inches (141.5 mm)	Approx. 3 1/4 x 2 1/2 inches (Approx. 82.1 x 61.8 mm) 4 1/8 inches (102.8mm)
Aspect	16:9		4:3
Colors	Full color		
Viewing Angle	40°/65°/65°/65° (typical) (up/down/left/right contrast>10:1)		50°/30°/50°/50° (typical) (up/down/left/right contrast>10:1)
Input/Output			
Composite			
Input	BNC (x 2), 1.0 Vp-p ±2 dB, sync negative	BNC (x 3), 1.0 Vp-p ±2 dB, sync negative	BNC (x 4), 1.0 Vp-p ±2 dB, sync negative
Output	BNC (x2), Loop through, Automatic 75 Ω termination	BNC (x 3), Loop through, Automatic 75 Ω termination	BNC (x 4), Loop through, Automatic 75 Ω termination
OPTION IN	D-sub 9pin (x2)	D-sub 9pin (x3)	D-sub 9pin (x4)
Remote			
Parallel	Modular 8 pin (x2)	Modular 8 pin (x3)	Modular 8 pin (x4)
General			
Power Consumption	Maximum: Approx. 26 W (with 2 x BKM-320D) Standard: Approx. 23 W (without optional input adaptor)	Maximum: Approx. 28 W (with 3 x BKM-320D) Standard: Approx. 22 W (without optional input adaptor)	Maximum: Approx. 26 W (with 4 x BKM-320D) Standard: Approx. 18 W (without optional input adaptor)
Power requirement	12V DC (with the supplied AC power adaptor), AC power adaptor:AC 100 to 240 V, 50/60 Hz		
Peak inrush current	(1) Power on, current probe method:57A (230V)	(1) Power on, current probe method:55A (230V)	(1) Power on, current probe method:53A (230V)
	(2) Hot switching inrush current, measured in accordance with European standard EN55103-1:8A (230V)		
Operating Temperature	32 to 95°F (0 to 35°C)		
Operating Humidity	30 to 85% (no condensation)		
Storage & Transport Temperature	14 to 104°F (-10 to 40°C)		
Storage & Transport Humidity	0 to 90%		
Operating / Storage / Trans. Pressure	700 hPa to 1060 hPa		
Dimensions (W x H x D)	19 x 5 1/4 x 1 7/8 inches (482 x 133 x 47 mm)*	19 x 5 1/4 x 1 7/8 inches (482 x 133 x 47 mm)*	19 x 3 1/2 x 1 7/8 inches (482 x 88.1 x 47 mm)*
Dimension including AC adaptor and BKM-320D	19 x 5 1/4 x 4 5/8 inches (482 x 133 x 116 mm)	19 x 5 1/4 x 4 5/8 inches (482 x 133 x 116 mm)	19 x 3 1/2 x 4 5/8 inches (482 x 88.1 x 116 mm)
Weight	Approx. 5 lb 1 oz (Approx. 2.3Kg)**	Approx. 5 lb 1 oz (Approx. 2.3Kg)**	Approx. 4 lb 3 oz (Approx. 1.9Kg)**
Supplied Accessories	AC power adaptor (1), AC Power Cord (1), AC plug holder (1), Screws for AC adaptor holder (2), Operating Instructions (1), Warranty Card (1)		

\* without the projection parts \*\* Excluding supplied accessories.

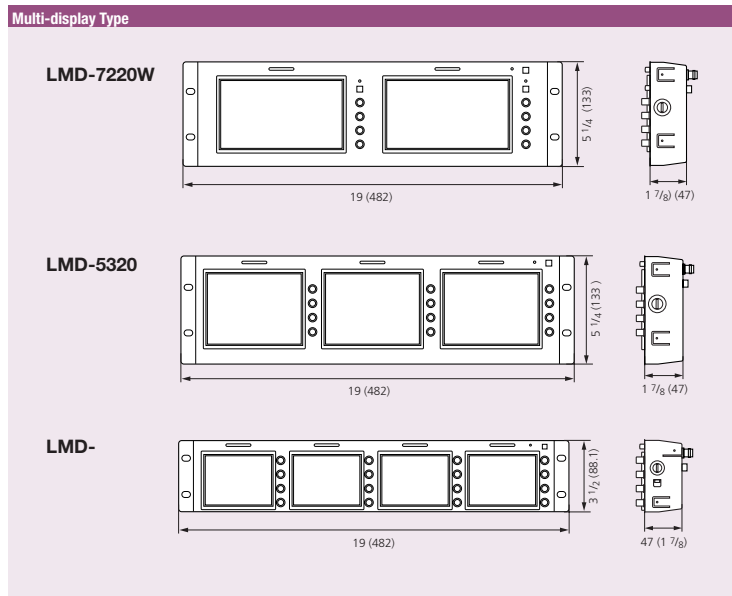

Unit: inches (mm)

# Optional Accessories



• **BKM-220D**  
SD-SDI 4:2:2 Input Adaptor  
(for MEU-WX2)



• **BKM-243HS**  
HD-SDI/SD-SDI Input Adaptor  
(for MEU-WX2)



• **BKM-255DV**  
DV Input Adaptor  
(for MEU-WX2)



• **BKM-320D**  
SD-SDI Input Adaptor  
(for LMD-2020, LMD-1420,  
LMD-7220W, LMD-5320,  
and LMD-4420)



• **SMF-600**  
Display IF Cable (10 m)  
(for MEU-WX2)



• **SU-558**  
Monitor Stand  
(for LMD-232WS, LMD-212S,  
LMD-172WS and LMD-152S)



• **SU-559**  
Rolling Floor Stand  
(for LMD-322WS)



• **SPMTRI/C**  
Monitor Stand  
(for LMD-322WS)

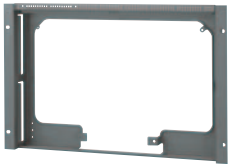

• **MB-522A**  
Mounting Bracket  
(for LMD-172W)



• **MB-523**  
Mounting Bracket  
(for LMD-212S)

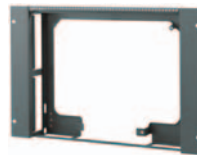

• **MB-524**  
Mounting Bracket  
(for LMD-152S)



• **MB-526**  
Mounting Bracket  
(for LMD-1420, LMD-1410)



• **MB-527**  
Mounting Bracket  
(for LMD-2020, LMD-2010)



• **MB-525**  
Mounting Bracket  
(for LMD-9050)



• **MB-528**  
Mounting Panel  
(for LMD-9050)



• **VF-509**  
ENG Kit (Viewing Hood,  
Carrying Handle and  
Connector Protector)  
(for LMD-9050)

---

**SONY®**

Sony Electronics Inc.  
1 Sony Drive  
Park Ridge, NJ 07656  
[www.sony.com/LUMA](http://www.sony.com/LUMA)

DI-0078  
MK10231V1

©2005 Sony Electronics Inc. All rights reserved.  
Reproduction in whole or in part without permission is prohibited.  
Features and specifications are subject to change without notice.  
All non-metric weights and measurements are approximate.  
Images on monitors are simulated.  
Sony, ChromaTRU, and LUMA are trademarks of Sony.  
VESA is a trademark of the Video Electronics Standards Association.  
VGA, SVGA, XGA, and SXGA are registered trademarks of International Business  
Machines Corporation, U.S.A.  
All other trademarks are the property of their respective owners.

Printed in USA (11/05)