

# Intelligent Sequential Switcher

---

# YS-S100

## Operating Instructions page 2

Before operating the unit, please read this manual thoroughly and retain it for future reference.

## Mode d'emploi page 28

Avant la mise en service de cet appareil, lire attentivement ce mode d'emploi et le conserver pour toute référence ultérieure.

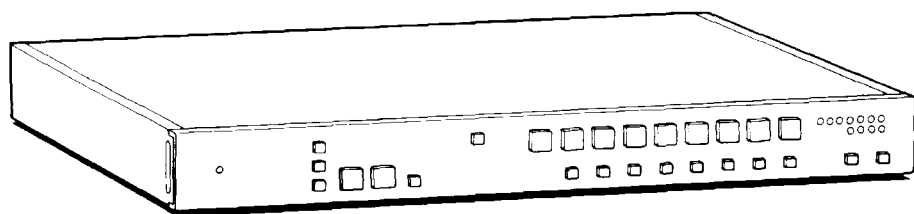

# Owner's Record

The model and serial numbers are located on the bottom. Record the serial number in the space provided below. Refer to these numbers whenever you call upon your Sony dealer regarding this product.

Model No. YS-S100    Serial No. \_\_\_\_\_

# WARNING

**To prevent fire or shock hazard, do not expose the unit to rain or moisture.**

**To avoid electrical shock, do not open the cabinet. Refer servicing to qualified personnel only.**

Warning—This equipment generates, uses, and can radiate radio frequency energy and if not installed and used in accordance with the instructions manual, may cause interference to radio communications. It has been tested and found to comply with the limits for a Class A computing device pursuant to Subpart J of Part 15 of FCC Rules, which are designed to provide reasonable protection against such interference when operated in a commercial environment. Operation of this equipment in a residential area is likely to cause interference in which case the user at his own expense will be required to take whatever measures may be required to correct the interference.

Important-To insure that the complete system (including this peripheral) is capable of complying with the FCC requirements, it is recommended that the user make sure that the individual equipment of the complete system has a label with one of the following statements.

"This equipment has been tested with a Class A Computing Device and has been found to comply with Part 15 of FCC Rules."

-or-

"This equipment complies with the requirements in Part 15 of FCC Rules for a Class A Computing Device."

-or equivalent.

The shielded interface cable recommended in this manual must be used with this equipment in order to comply with the limits for a computing device pursuant to Subpart J of Part 15 of FCC rules.

# Table of Contents

Precautions .....	4
Features .....	4
Location of controls .....	5

## Preparations

To set the clock .....	6
To select a setting display .....	8
To set the dwell time of each camera .....	10
To set alarm duration .....	12
To set a camera I.D. ....	14
To change the display location and the date and time indications .....	16

## Operation

How to use .....	18
Alarm input record .....	22

## Connections

Location and function of connectors .....	24
Basic connections .....	25

## General

Specifications .....	26
Troubleshooting .....	27

# Features

The YS-S100 enables you to switch the monitor pictures shot by up to 8 surveillance cameras through automatic sequential display or manually. Simultaneous surveillance of up to 8 places is possible with one YS-S100.

- On a monitor connected to the SEQ MON OUTPUT connector at the rear, the unit allows pictures shot by up to 8 cameras to be displayed from camera to camera automatically. (Sequential monitor function)  
It can skip the cameras whose output you do not wish to monitor.  
The dwell time of each camera can be set individually.
- On a monitor connected to the SPOT MON OUTPUT connector at the rear, a picture from a particular camera can be monitored manually. (Spot monitor function)
- High quality picture without switching disturbance is obtained if all cameras connected are synchronized.
- The unit is equipped with ALARM INPUT terminals which correspond to the CAMERA INPUT connectors. An alarm will be raised if an alarm is input to the terminals.
- A camera number, date and current time can be displayed on the monitor while the unit is in operation.
- The camera number, date and time that a disturbance occurs are automatically recorded in a memory. You can later display them on a monitor. A total of 108 alarms can be recorded.
- You can put a desired camera I.D. (identification) in place of the camera number for display on the monitor screen.
- An interface unit is equipped, which allows the YS-S100 to be controlled by the central computer through RS-232C or RS-485.

# Precautions

## Safety

- Operate the unit only on 120 V AC.
- One blade of the plug is wider than the other for the purpose of safety and will fit into the power outlet only one way. If you are unable to insert the plug fully into the outlet, contact your dealer.
- Should any liquid or solid object fall into the cabinet, unplug the unit and have it checked by qualified personnel before operating it any further.
- Unplug the unit from the wall outlet if it is not going to be used for several days or more. To disconnect the cord, pull it out by the plug. Never pull the cord itself.

## Installation

- Place the unit on a flat, even surface.
- Do not install the unit in a hot or humid place or in a place subject to excessive dust or mechanical vibration.

## Cleaning

Clean the unit with a slightly damp soft cloth. Use a mild household detergent. Never use strong solvents such as thinner or benzine as they might damage the finish of the cabinet.

## Repacking

Retain the original carton and packing materials for safe transport of this unit in the future.

# Location of Controls

For detailed instructions, see the pages indicated in ●.  
For the location of the connectors at the rear panel, see page 24.

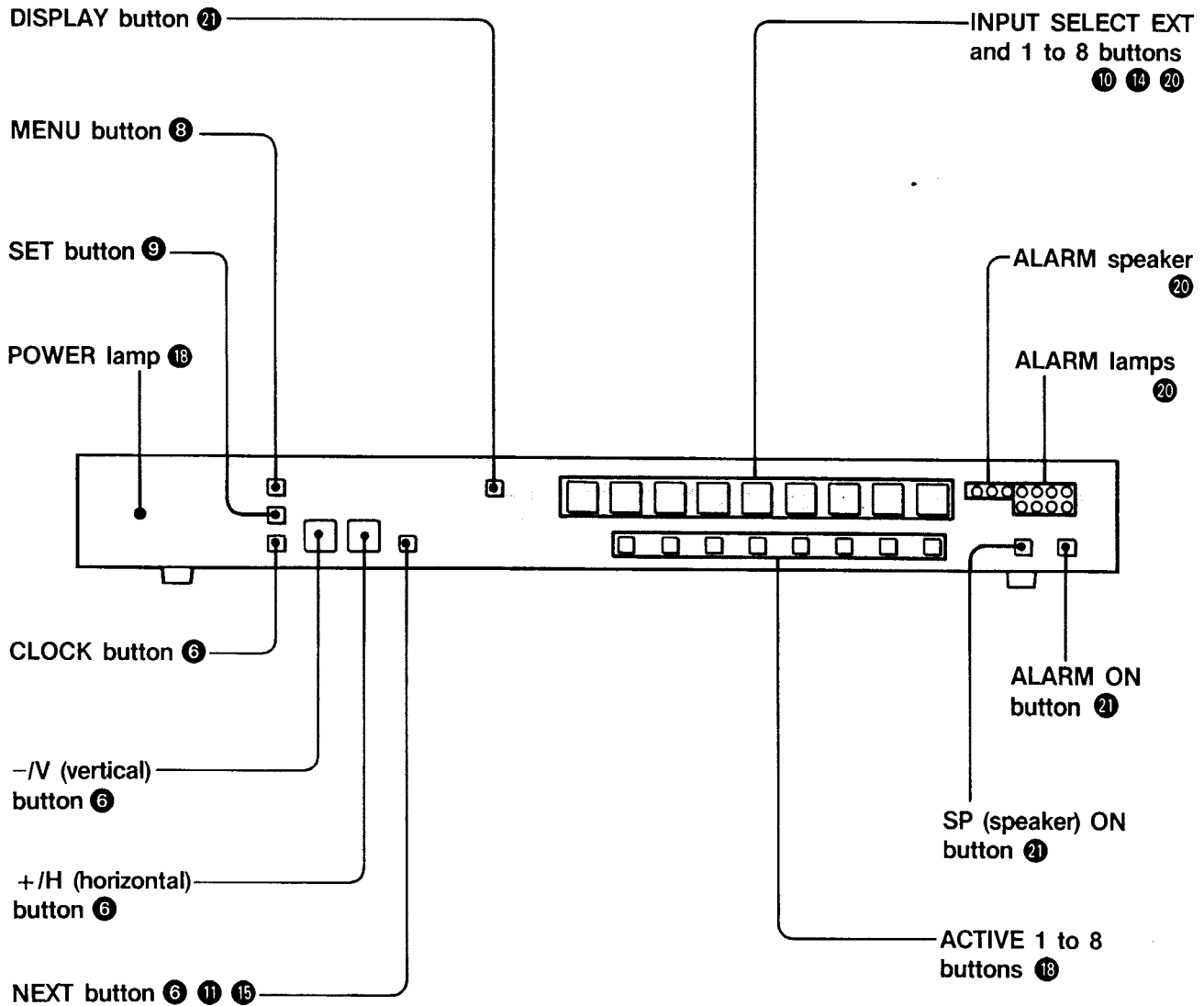

Make sure you have completed the connections (page 25) and turned on the power of the unit and the connected monitor before you make preparations.  
If all the preparations have been completed, begin with "How to Use" on page 18.

# To Set the Clock

The internal clock displays the date and current time on the monitor screen.

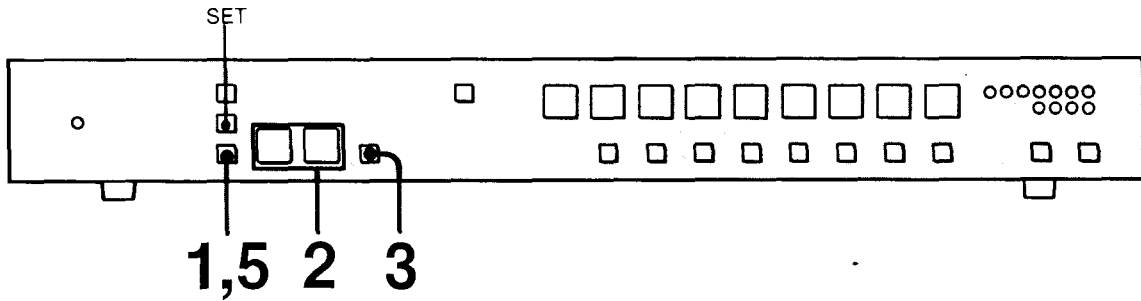

When the power is turned on, the internal clock is activated, and the following display will appear on the monitor screen.

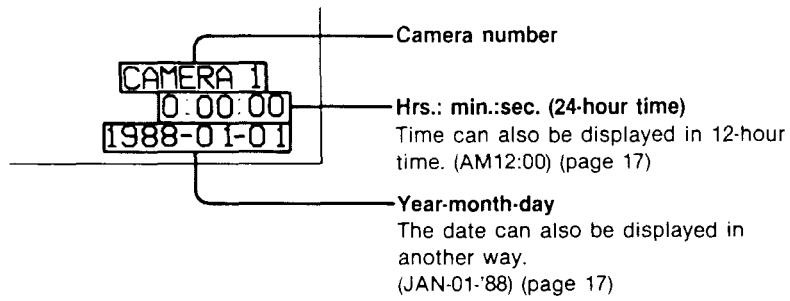

**Example: To set the date/time to 3:35 p.m., October 15, 1988**

## 1 Press CLOCK.

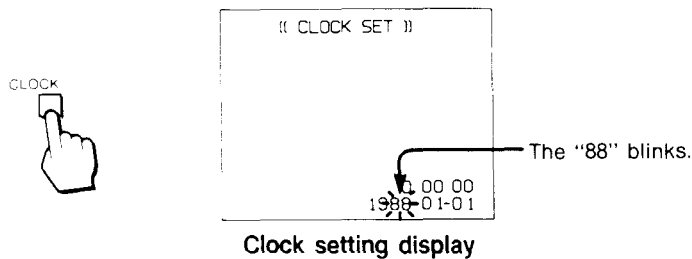

## 2 Set the year.

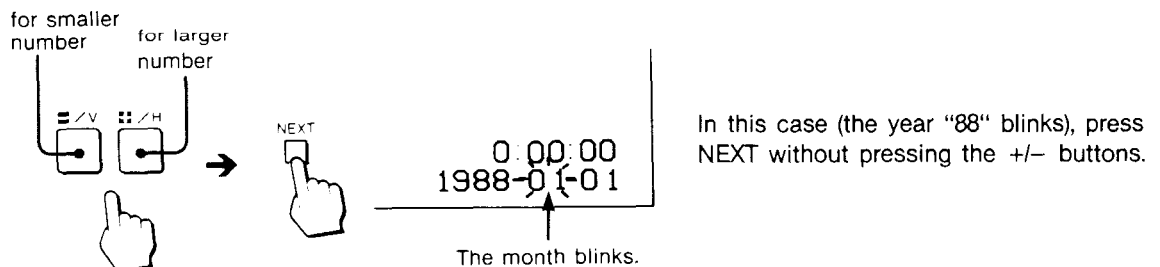

### 3 Set the month to "October" (10).

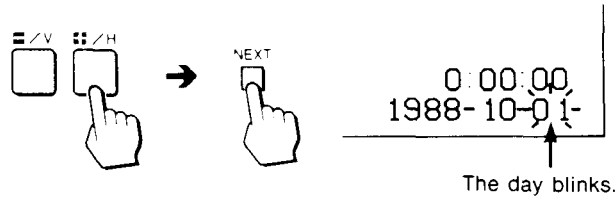

### 4 Set the day, hour and minute in sequence.

Set the item which is blinking with the + or - button, and then press NEXT.

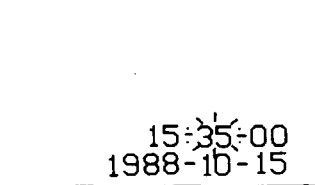

### 5 Press SET with a telephone or radio time signal.

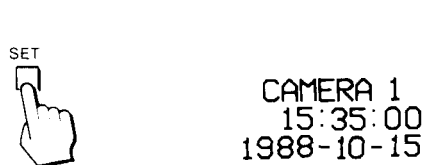

The clock will now start from "00" second.

#### +/- buttons

Pressing a button once increases or decreases the number by one.

Keeping a button pressed increases or decreases the number continuously.

#### When you made a mistake or want to correct the setting

press NEXT as many times as necessary until the item to be corrected blinks. Reset the item with the +/- buttons and then press SET.

#### Time incidation

0:00 = AM12:00 = midnight

12:00 = PM12:00 = noon

#### To cancel the setting in process

Press CLOCK. The new setting will be canceled and the unit will start to operate.

# To Select a Setting Display

To make the necessary preparations (page 10 to 17), turn on the MENU display on the screen and select the desired setting item.

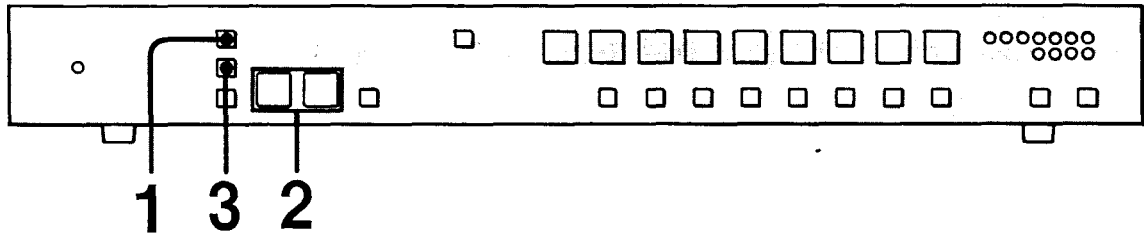

## 1 Press MENU.

The following display will appear on the connected monitor screen. (MENU display)

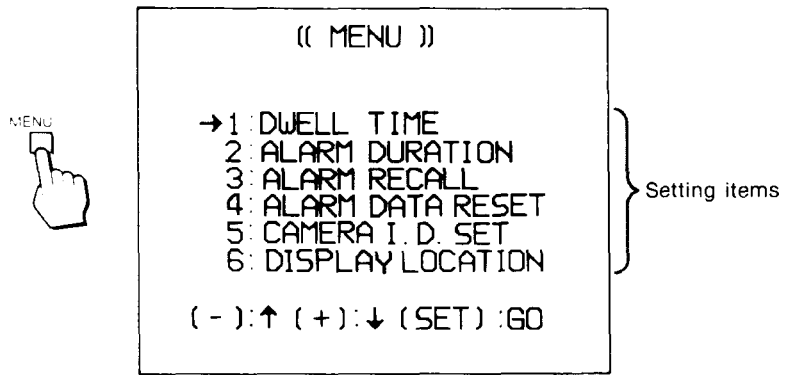

## 2 Select the desired item.

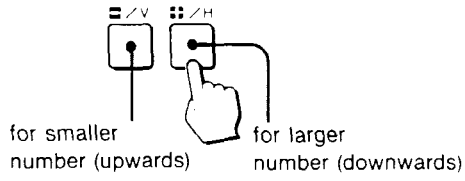

Each press moves the cursor on the display.

### Setting items

- 1: DWELL TIME (To set an interval at which each camera is switched)
- 2: ALARM DURATION (To set the period of time for which an alarm is activated)
- 3: ALARM RECALL (To recall alarm inputs recorded) (page 22)
- 4: ALARM DATA RESET (To erase alarm data) (page 23)
- 5: CAMERA I.D. SET (To set a camera identification)
- 6: DISPLAY LOCATION (To change the display location and the date and time indications)

Move the cursor to any one of items 1 to 6.



### 3 Press SET.



The MENU display will disappear and the selected setting display will appear.

**To cancel the setting display shown on the screen**  
Press MENU. The MENU display will reappear.

**Pressing the SET or MENU button switches the monitor display as follows:**

**To turn off the MENU display and to return the unit to operation mode**  
Press MENU. The MENU display will disappear and the unit begins to operate.

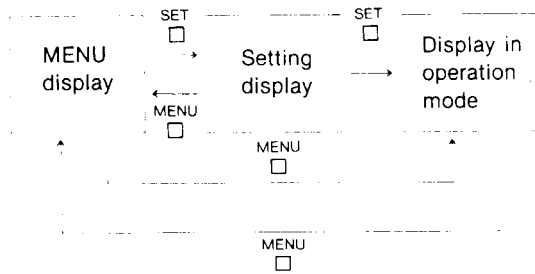

# To Set the Dwell Time of Each Camera

By setting the dwell time of each camera, the output from cameras will be sequentially switched at the interval of each selected dwell time on the monitor connected to the SEQ MON OUTPUT connector at the rear.

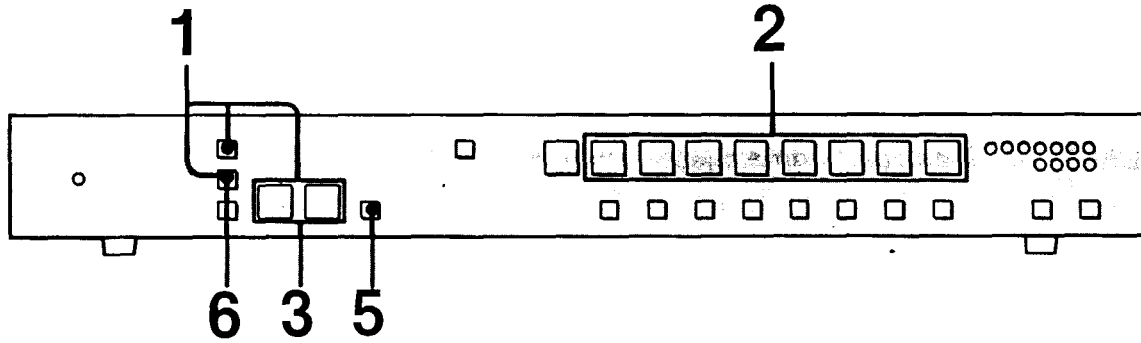

**1** Turn on the MENU display on the screen and select DWELL TIME. (See page 8.)

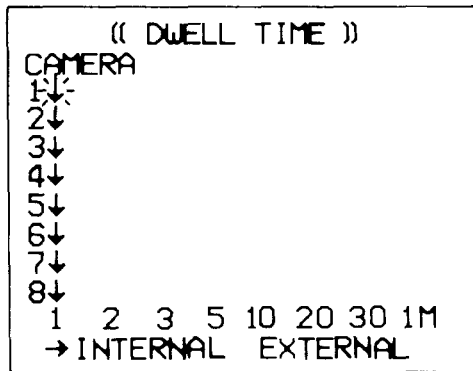

The scene from the camera of the number whose cursor is blinking is superimposed on the display.

Dwell time setting display

**2** Select the camera to be set.

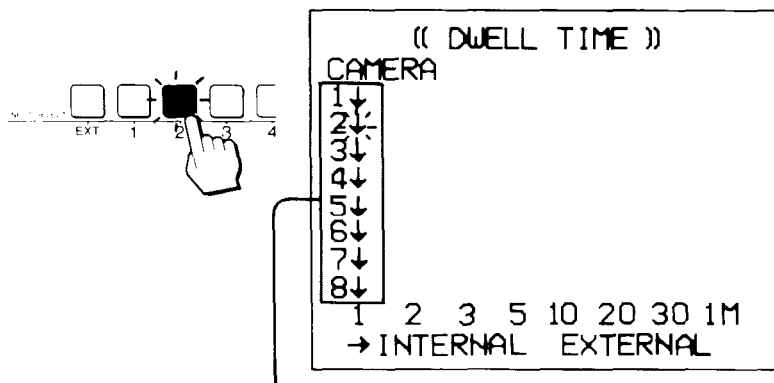

The monitor input is switched to the scene from the selected camera.

Skip this step if the cursor indicating the camera to be set is blinking.

Camera number

You can set the dwell time of the camera whose cursor is blinking.

### 3 Select the desired dwell time.

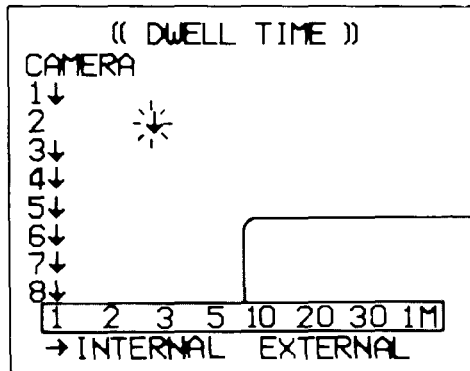
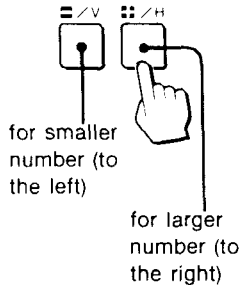

#### Dwell time

Move the cursor to the desired time — 1, 2, 3, 5, 10, 20 or 30 seconds or a minute.

Each press moves the cursor on the display.

(i.e., Setting to 3 seconds for camera 2)

### 4 Repeat steps 2 and 3 for other cameras to be monitored.

### 5 Select INTERNAL or EXTERNAL.



Each press moves the cursor alternately.

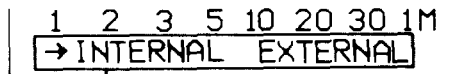

**INTERNAL:** To sequentially switch monitor input from camera to camera at the intervals set in steps 1 to 4.  
**EXTERNAL:** To control the intervals at which a camera is switched via external equipment connected to the EXT TIMING IN connector at the rear.

**Move the cursor to either.**

### 6 Press SET.



The dwell time setting display will disappear and the unit will start to operate.

#### Notes

- When "EXTERNAL" is selected with no equipment connected to the EXT TIMING IN connector, the monitor input is not switched.
- The upper and lower parts of the setting display may be cut in some monitors connected.
- Dwell time can be set whether "INTERNAL" or "EXTERNAL" is selected.
- Pressing the INPUT SELECT button corresponding to the camera not connected switches the scene from that camera with no picture.
- The INPUT SELECT EXT button does not function in dwell time setting mode.

# To Set Alarm Duration

You can select the period of time for which an alarm is activated. (i.e., alarm sounds, etc.)

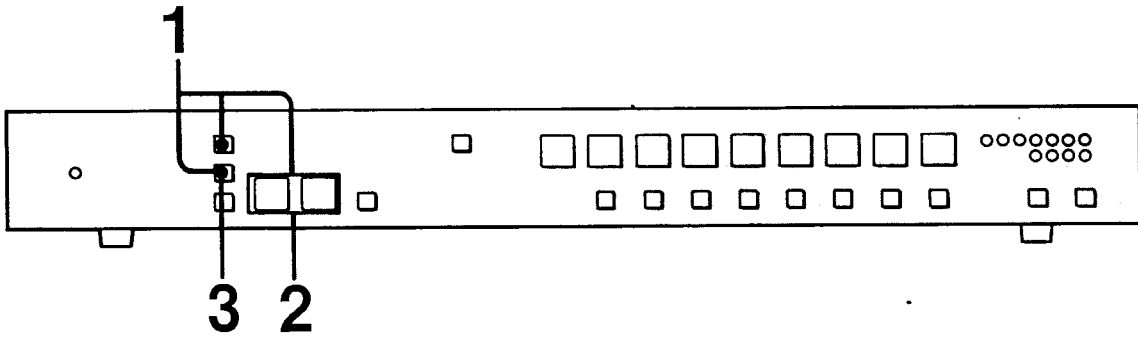

- 1 Turn on the MENU display on the screen and select ALARM DURATION. (See page 8.)

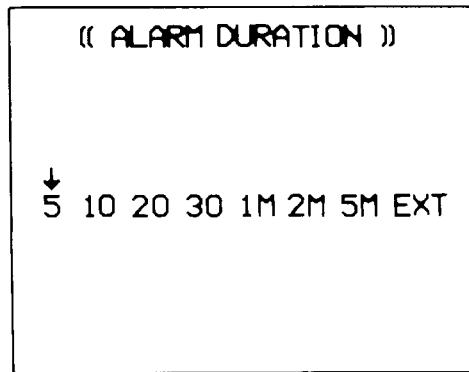

Alarm duration setting display

- 2 Select the desired duration.

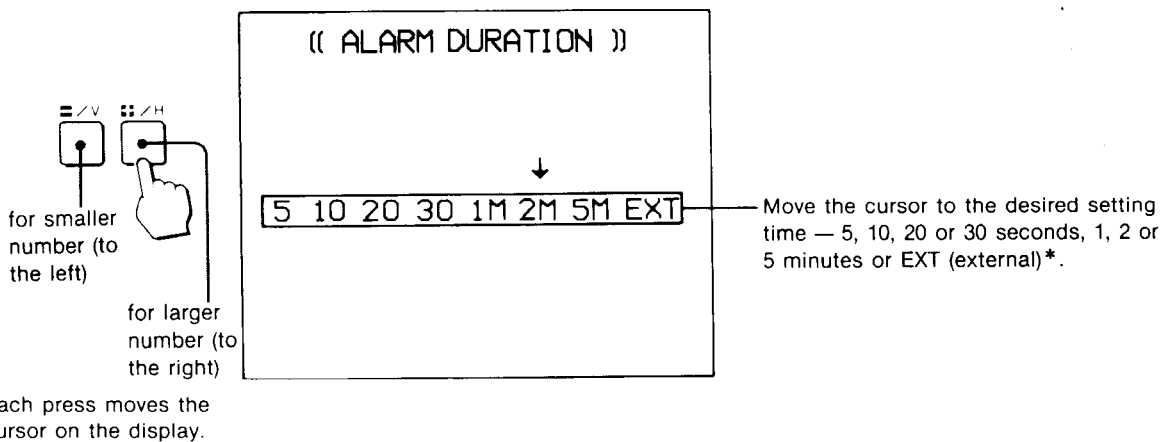

### 3 Press SET.



The alarm duration setting display will disappear and the unit will start to operate.

\*To control the alarm duration via external equipment connected to the REV IN terminals at the rear, select "EXT".

#### **Note**

When the alarm duration is set to "EXT" with no equipment connected to the REV IN terminals, an alarm remains active once it is input.

# To Set a Camera I.D. (Identification)

You can give a camera I.D. to a camera in place of the camera number for display on the monitor screen to identify the place for surveillance, for example, using up to 8 characters.

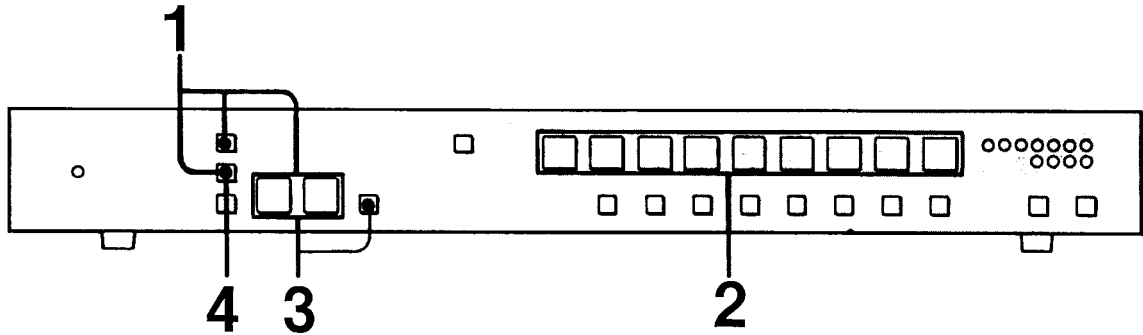

**Example: To identify Camera 2 as "ENTRANCE"**

**1** Turn on the MENU display on the monitor screen and select CAMERA I.D. SET. (See page 8.)

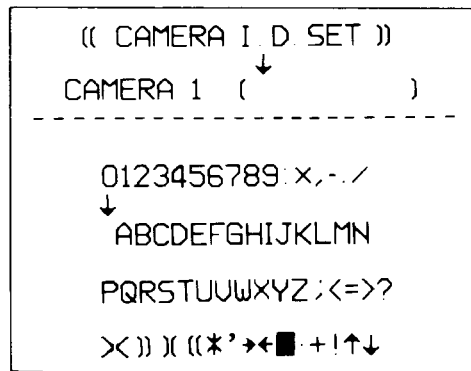

The scene from the camera of the number shown on the display is superimposed.

Camera I.D. setting display

**2** Select the camera to be set.

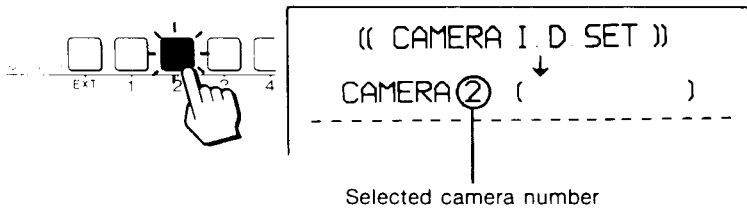

The monitor input is switched to the scene from the selected camera.

Skip this step if the desired camera number is shown on the setting display.

### 3 Create the camera I.D.

1 Select the first character, "E".

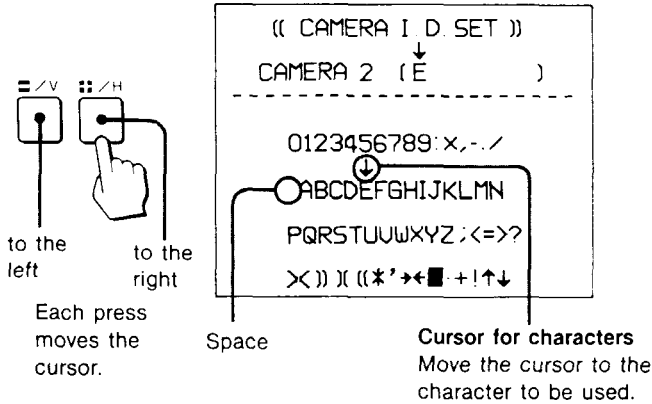

2 Move the cursor to the second character position.

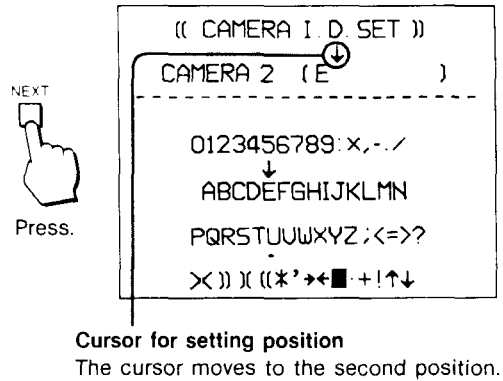

3 Repeat 1 and 2 to set "ENTRANCE".

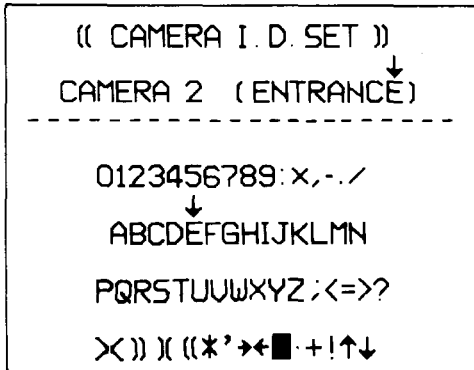

4 Repeat steps 2 and 3 for other cameras to be identified.

5 Press SET.



The camera I.D. setting display will disappear and the unit will start to operate.

```

ENTRANCE
15 : 38 : 47
1988 - 10 - 15
    
```

**When you make a mistake or want to change the camera I.D. setting**

Press NEXT as many times as necessary until the cursor indicates the character to be changed. Change the setting with the  $\pm$  buttons.

If you want to erase a character, move the cursor (for characters) to a space position.

**Note**

Even with one character set, the camera number is replaced with the camera I.D. To display the camera number again, erase the characters by putting spaces on all characters.

# To Change the Display Location and the Date and Time Indications

Camera number, date and time display can be located as you desire on the monitor screen. Also, the date and time indications can be displayed in four ways.

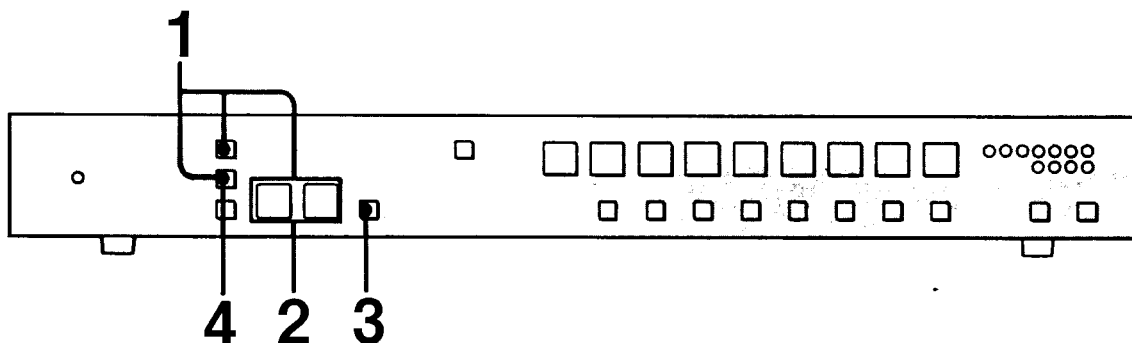

- 1 Turn on the MENU display on the screen and select DISPLAY LOCATION. (See page 8.)

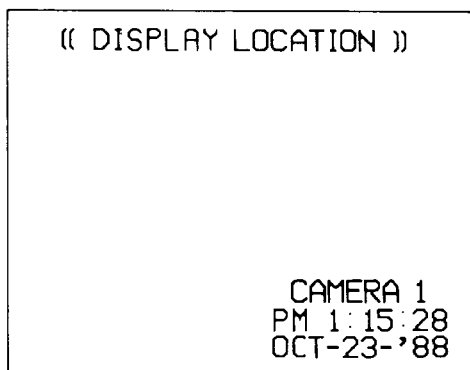

Display location setting display

- 2 Define the location.

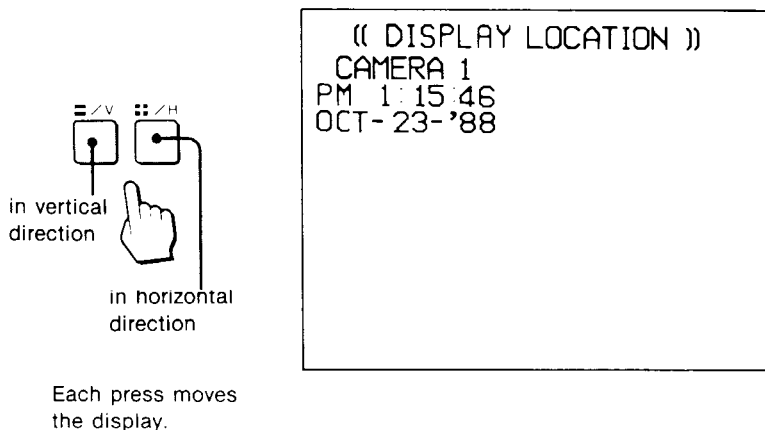



### 3 Select the date and time indications.

Every time the NEXT button is pressed, the indications change as follows.

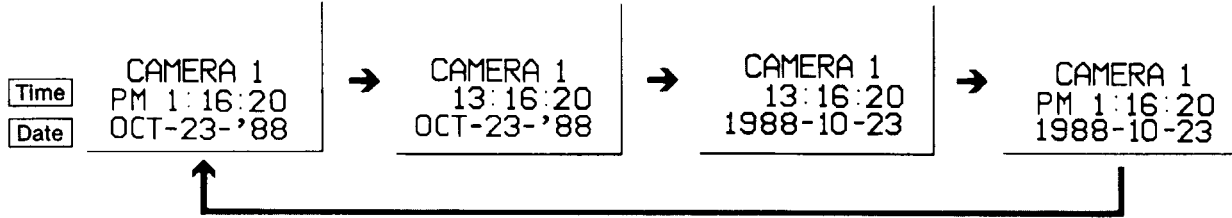

Press NEXT as many times as necessary to display the desired indications on the screen.

### 4 Press SET.



The unit will start to operate with the selected display on the selected locations.

# How to Use

Before operation, complete all the connections (page 25) and preparations (pages 6 to 17) and turn on the power of a monitor.

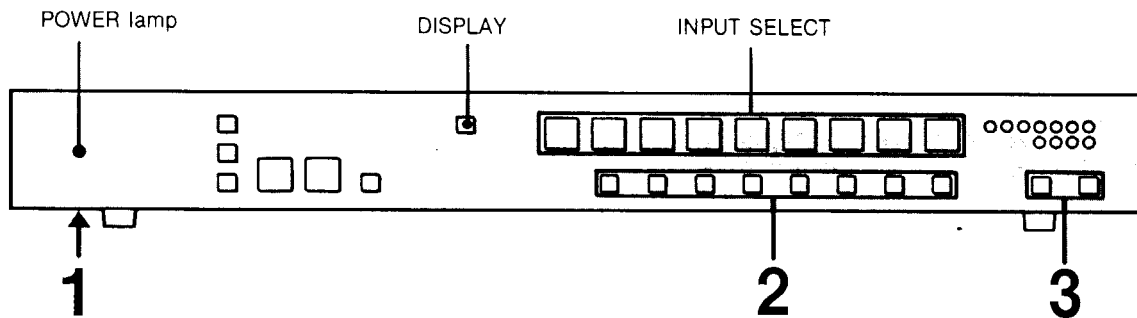

## 1 Set the POWER switch to ON.

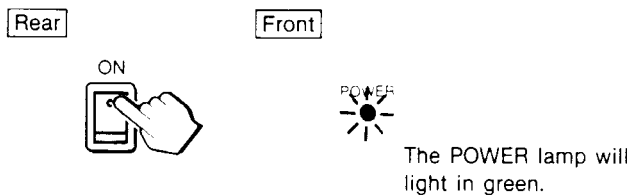

## 2 Check that the ACTIVE buttons corresponding to the cameras whose output you wish to monitor are lit in yellow.

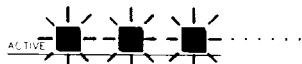

If the button(s) are not lit, press to light them.

## 3 Check that the SP ON and ALARM ON buttons are lit in red.



If the button(s) are not lit, press to light them.

## To Sequentially Monitor Output from All Cameras (Sequential Monitor)

Connect a monitor to the SEQ MON OUTPUT connector at the rear. (page 25)

Monitor input will be switched in the order, camera number 1, 2, 3 ...8, 1 ... at each selected interval. The INPUT SELECT button corresponding to the camera whose output is being monitored sequentially lights in green.

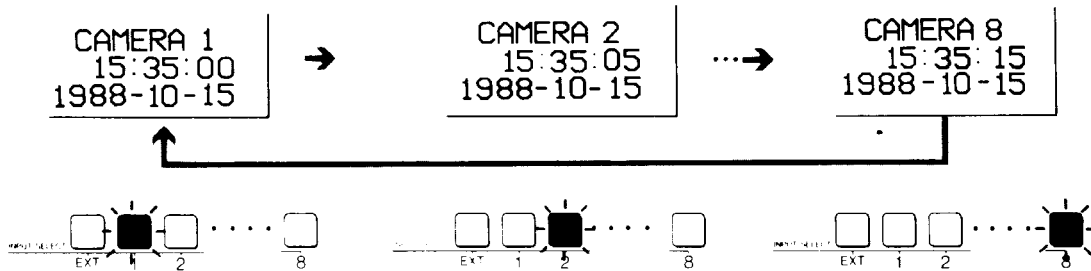

### To skip over certain cameras

Press the ACTIVE button(s) corresponding to the cameras you do not want to monitor. The button illuminations will go out.

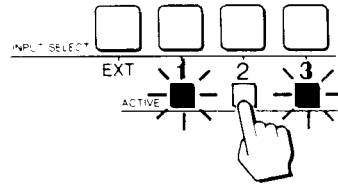

### Notes

- The INPUT SELECT button numbers correspond to the CAMERA INPUT connector numbers at the rear. Camera numbers with no camera connected will also be sequentially monitored (no picture appears). To skip them, press the ACTIVE buttons of these numbers so that the button illuminations go out.
- Alarm is not input for the cameras corresponding to the ACTIVE buttons which are not lit.

## To Monitor Output from a Particular Camera (Spot Monitor)

Connect a monitor to the SPOT MON OUTPUT at the rear. (page 25)

Press the INPUT SELECT camera number button whose output you want to monitor. The button lights in green.

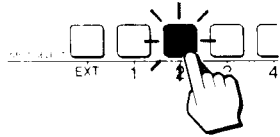

CAMERA 2+  
PM 1:17:48  
1988-10-23

Spot monitor indication

In this example, the output from camera 2 will be continuously shown on the monitor.

If the button is pressed again to turn off the button illumination and to erase the spot monitor indication (+ mark) on the monitor screen, the monitor input will be switched from camera to camera as in the sequential monitor function.

If the INPUT SELECT EXT button is pressed

The following display will appear on the screen.

A picture from external equipment connected to the EXT IN connector at the rear will be continuously monitored.

EXT  
PM 1:18:05  
1988-10-23

## When Alarm Is Input (When Disturbance Has Occurred)

**Example:** Two monitors are connected to the YS-S100, one for sequential monitor and another for spot monitor. The INPUT SELECT 1 button is pressed so that the button lights and the output from camera 1 will be continuously shown on a spot monitor.

An alarm has been input to camera 3.

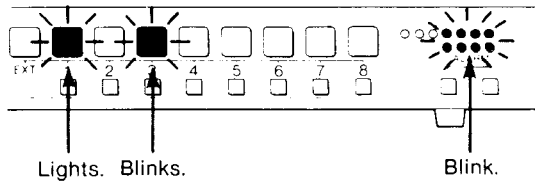

Lights. Blinks.

Blink.

⊛ CAMERA 3

CAMERA 1+

Alarm indication

Sequential monitor

Spot monitor

A scene from camera 3 will be automatically displayed on the sequential monitor. The ALARM lamps and the INPUT SELECT 3 button will blink and an alarm will sound. These actions occur simultaneously and continue for the period of preset alarm duration.

If the INPUT SELECT 1 button is pressed to turn off the button illumination (to cancel the spot monitor function), the output from camera 3 will be shown on the spot monitor.

**Example:** During the duration of alarm, another alarm has been input to camera 1.

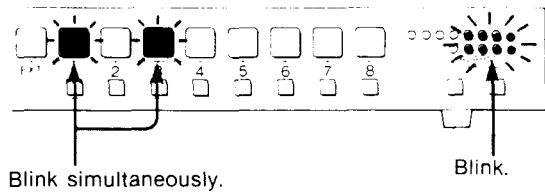





The output from camera 1 will be displayed on the sequential monitor. The INPUT SELECT 1 and 3 buttons blink simultaneously and an alarm continues to sound. The alarm continues for another preset alarm duration.

\* CAMERA 1

Sequential monitor

\* CAMERA 1+

Spot monitor

<p><b>To stop alarm sooner</b></p>	<p>ALARM ON</p>  <p>Illumination goes out.</p>
<p><b>To stop alarm sound sooner</b></p>	<p>SP ON</p>  <p>Illumination goes out.</p>
<p><b>To prevent alarm from activating even if an alarm is input</b></p>	<p>ALARM ON</p>  <p>Illumination goes out.</p>
<p><b>To prevent alarm from sounding even if an alarm is input</b></p>	<p>SP ON</p>  <p>Illumination goes out.</p>
<p><b>To restore each function, press to light the corresponding button(s) again.</b></p>	

**To turn off the camera number/time/date on-screen display**  
 Press the DISPLAY button. To make it appear on the screen, press DISPLAY again.

# Alarm Input Record

When an alarm is input (a disturbance occurs), the unit will automatically record the camera number, date and time of the incident. A total of 108 alarm inputs can be recorded and you can recall them later on the monitor screen.

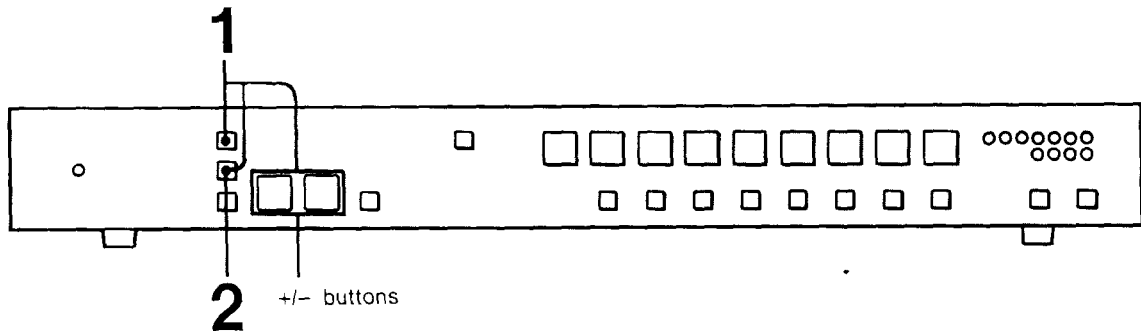

## To Display Alarm Input Data

1 Turn on the MENU display on the monitor screen and select ALARM RECALL. (See page 8.)

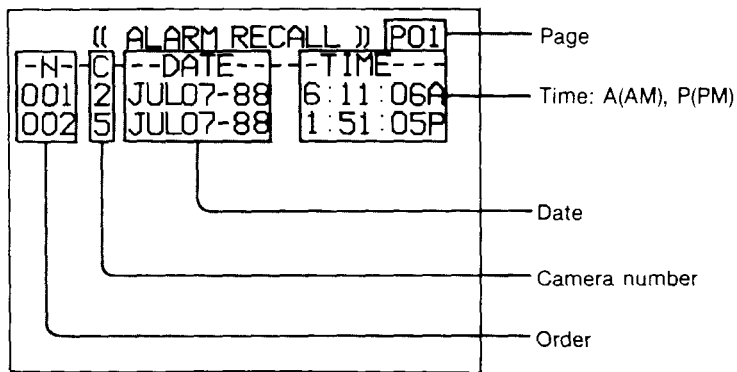

Alarm data display

Up to 10 alarm inputs will be displayed on a page.

**To make another page display on the screen (when more than 10 alarm inputs were recorded)**

Press the +/- buttons; + to advance pages and - to reverse pages.

- The +/- buttons do not function when less than 10 alarm inputs have been recorded.

**To return the unit to operation mode**  
Press SET.

## To Erase All Alarm Data

- 1 Turn on the MENU display on the screen and select ALARM DATA RESET. (See page 8.)



Y: Yes  
N: No

Alarm data reset display

- 2 Press SET.



All alarm data recorded in a memory will be erased and the unit will start to operate.

**To stop erasing after showing the alarm data reset display on the screen**

Press MENU. The MENU display will appear on the screen.

To restore the unit to the operation mode, press MENU again.

### Note

After 108 alarm inputs have been recorded, no more input will be recorded. If you want to record more, perform alarm data reset.

# Location and Function of Connectors

## Rear

### EXT IN (external input) connector (BNC connector)

Connect to the video output connector of external equipment.

### CAMERA INPUT 1 to 8 connectors (BNC connector)

Connect to the video output connectors of cameras.

### ALARM INPUT 1 to 8 terminals (M3 screw type)

Connect to the ALARM OUT terminals of the Sony YS-D100 motion detectors or external alarm devices to activate alarm of the YS-S100 by short-circuiting the COM terminals.

### REV IN (recovery input) terminal (M3 screw type)

In the case that alarm duration is set to "EXT", the unit's alarm duration is controlled by external equipment\* connected to this terminal.

### RESET OUT terminal (M3 screw type)

Pressing the ALARM ON button of the unit (button illumination goes out) while alarm is active can terminate alarm of external equipment\* connected to this terminal.

### SPOT MONITOR OUTPUT connector (BNC connector)

Connect to the video input connector of a monitor for spot monitor function.

### EXT TIMING IN (external timing input) connector (BNC connector)

Use to control switching intervals of monitor input via external equipment\*.

AC power cord

POWER switch

Interface unit

See page 26.

### EXT TIMING OUT connector (BNC connector)

When two or more YS-S100 switchers are used, connect to the EXT TIMING IN connector of the other YS-S100. The monitor inputs of these units are switched with the same timing.

### SEQ MON OUTPUT connector (BNC connector)

Connect to the video input connector of a monitor for sequential monitor function.

### ALARM OUT terminal (M3 screw type)

Connect to the alarm input terminal of external equipment\*. The YS-S100 can activate alarm of connected equipment in synchronization. This terminal can also be connected to an external alarm device to control it.

\* For details, contact a Sony dealer.



# Basic Connections

Up to 8 cameras can be connected in combination with the Sony YS-D100 motion detectors.

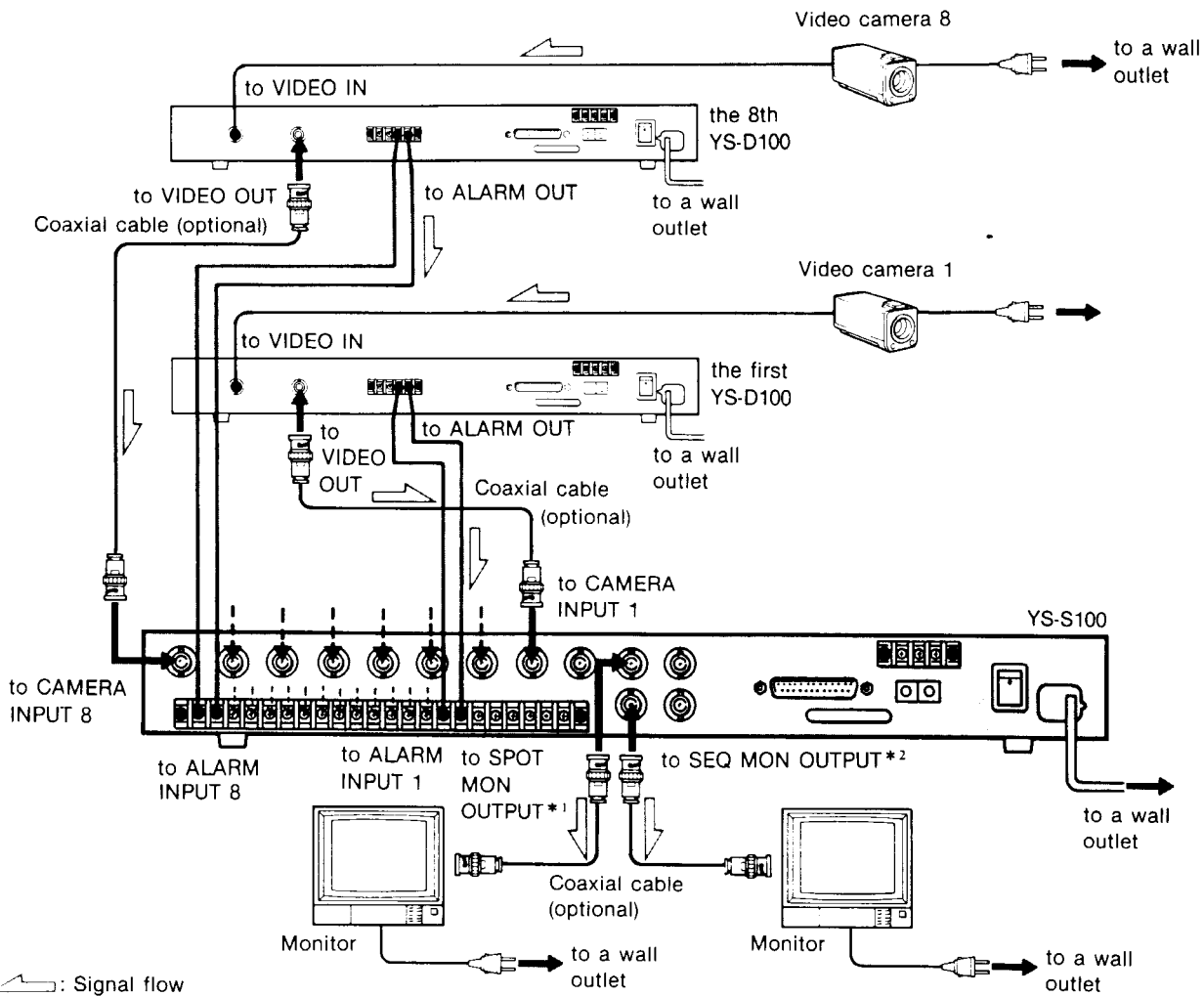

\*1 Output from the camera selected with the INPUT SELECT button is displayed on the monitor connected to the SPOT MON OUTPUT connector.

\*2 Output from camera 1 to 8 is sequentially displayed on the monitor connected to the SEQ MON OUTPUT connector.

## Notes on connections

- Before connections, turn off all equipment.
- Securely insert all plugs.
- Be sure to make correct  $\oplus \ominus$  connection for the M3 terminals.
- When disconnecting the plugs, grasp the plugs. Never pull by the cord.
- To avoid interference, turn off the power of equipment not in use.
- Connecting methods may vary for individual equipment. Refer to all relevant instruction manuals to ensure correct connection.

# Specifications

Inputs	CAMERA INPUT 1 to 8: BNC type NTSC color 1 Vp-p, 75 ohms, unbalanced, sync negative	Power requirements	120 V AC, 60 Hz
	EXT IN: BNC type NTSC color 1 Vp-p, 75 ohms, unbalanced, sync negative	Power consumption	160 mA
	ALARM INPUT 1 to 8: M3 screw type Short circuited with COM (Short circuited resistance less than 600 ohms) Dielectric withstand voltage 5V DC	Operating temperature	0°C – 40°C (32°F – 104°F)
	REV IN: M3 screw type 5V DC, Impedance 5.6 kilohms	Storage temperature	–20°C – +60°C (–4°F – +140°F)
	EXT TIMING IN: BNC type Open circuit voltage 5V DC Impedance 5.6 kilohms	Dimensions	424 × 44 × 355 mm (w/h/d) (16 <sup>3</sup> / <sub>4</sub> × 1 <sup>3</sup> / <sub>4</sub> × 4 inches) (including projecting parts and controls) Not including rubber feet and rack mounting brackets
	SPOT MON OUTPUT: BNC type Impedance 75 ohms	Weight	Approx. 4.1 kg (9 lb 1 oz)
	SEQ MON OUTPUT: BNC type Impedance 75 ohms	Supplied accessory	Rack mounting bracket (for EIA standard racks) (1 set)
	ALARM OUT: M3 screw type Open collector output, Contact rating 5V DC/100 mA Resistive load	Design and specifications subject to change without notice.	
	RES OUT: M3 screw type 4V DC, Impedance 1 kilohms		
	EXT TIMING OUT: BNC connector Open collector output, Contact rating 5V DC/100 mA, Resistive load		
	Interface unit The RS-232C and the RS-485 connectors are designed to widen the YS-S100's application range for use with a computer system. For details, contact a Sony dealer.		

# Troubleshooting

If you think you have a problem, double-check before calling the serviceman.  
You may have overlooked something relatively simple!

First check:

- Are all connections correct?
- Is the power cord plugged in?
- Is the power turned on?

Symptom	Solution
<b>The alarm is not raised.</b>	<ul style="list-style-type: none"><li>• Press ALARM ON so that the button illumination lights in red.</li><li>• Check the alarm duration setting display. If it is set to "EXT" with no equipment connected to REV IN at the rear of the unit, select other setting. (Page 13)</li></ul>
<b>The alarm does not sound.</b>	Press SP ON so that the button illumination lights in red.
<b>Monitor input is not switched. (in sequential monitor function mode)</b>	Check the dwell time setting display. If it is set to "EXTERNAL" with no equipment connected to EXT TIMING IN at the rear, select "INTERNAL". (Page 11)
<b>Output from a camera which is connected to the unit is not monitored.</b>	Press the ACTIVE button corresponding to that camera so that the button illumination lights in yellow.