

**SONY**<sup>®</sup>

EIA/NTSC

CCD Color Video Camera

**DXC-LS1**

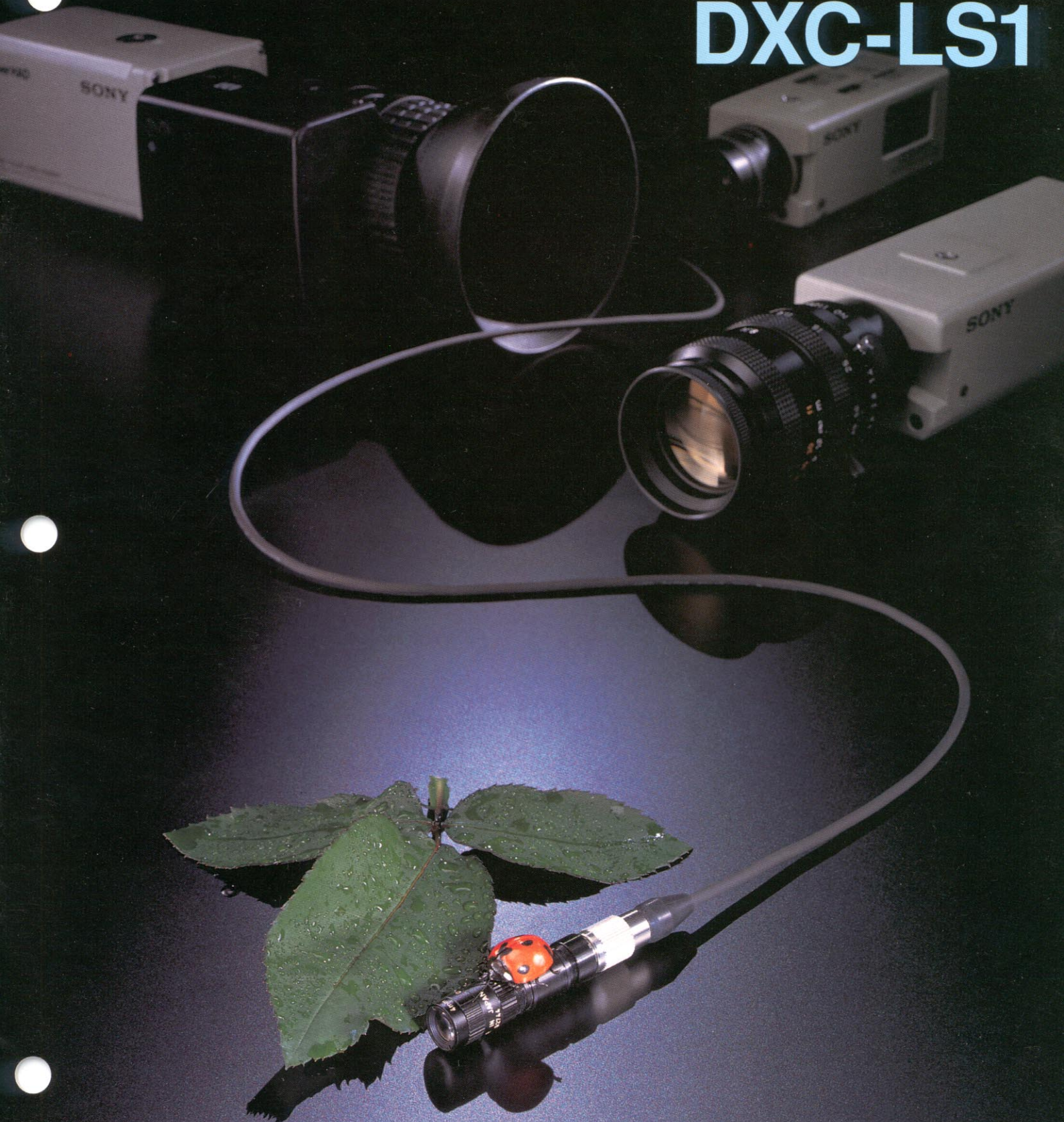

Lens shown is an option.



# Small is Beautiful



## DXC-LS1

◀ Actual Size

### Good Things in a Small Package

The Sony DXC-LS1 proves that good things come in small packages. Despite its remarkably small size – the camera head is only 35mm long and 12mm in diameter – it comes with a host of advanced features that you won't find in many larger cameras, plus convenient controls that make shooting virtually automatic.

### High Performance Components

The DXC-LS1 consists of a camera head and a camera control unit, each a marvel of technology. The camera head features a Sony Interline Transfer Hyper HAD™ (Hole Accumulated Diode) CCD image sensor that packs 380,000 picture elements into only a quarter of an inch. The camera control unit incorporates a powerful DSP (Digital Signal Processor) which provides enhanced picture quality, plus the automatic adjustment features that make the camera so easy to use.

### Excellent Picture Quality

Horizontal resolution is 470TV lines, sensitivity is F5.6 at 2,000 lx and the signal-to-noise ratio is 46 dB, for outstanding brightness and excellent all-round performance. Advanced color matrix technology allows you to adjust colors individually without changing the overall white balance, for vivid, lifelike reproduction of whatever you are shooting.

### Versatility

In industrial, broadcasting applications and in security installations – across the entire range of video imaging – the DXC-LS1 opens up a new realm of possibilities. Take it where you thought a camera could never go.

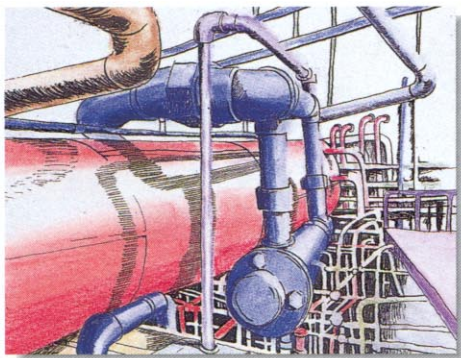

#### Industrial

Outstanding portability and an assortment of optional accessories make the DXC-LS1 an invaluable tool in hazardous and hard-to-reach environments.

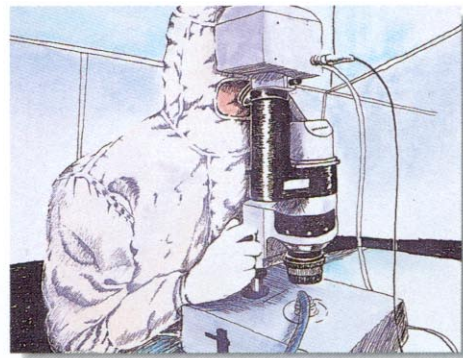

#### Microscopy

With a computer interface and a variety of image enhancement features, the DXC-LS1 has the precision you require in critical microscopy applications.

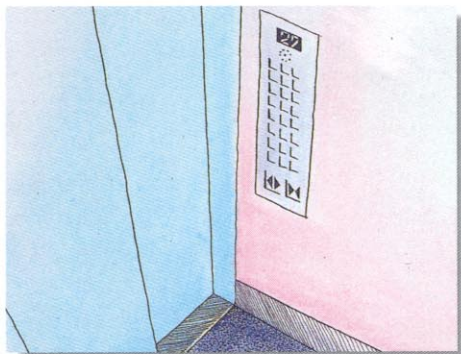

#### Security

The DXC-LS1 can be installed in elevators, hotel lobbies, shop windows – anywhere that unobtrusive, high-quality surveillance is required.

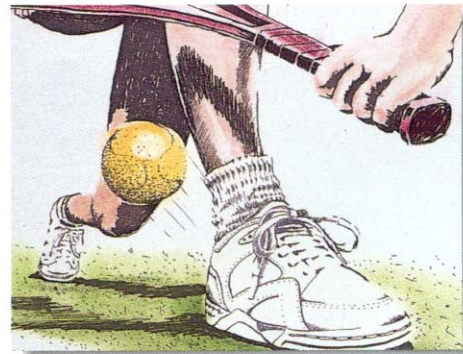

#### Sports shooting

Energize your coverage of sports and other live events with shots from striking new angles. Take your viewers into the center of the action.



# Capture Colors the Way They Really Are

To adjust only the redness of the picture...

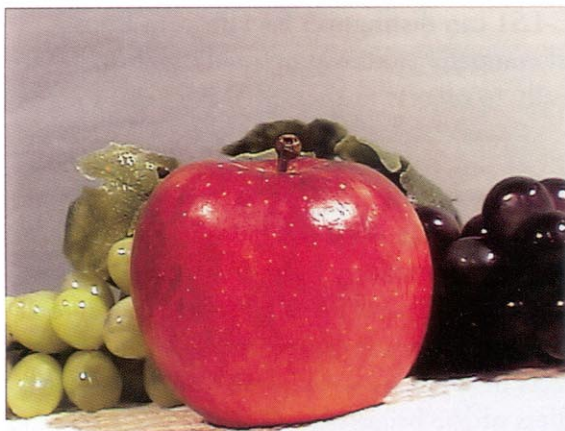

Before adjustment

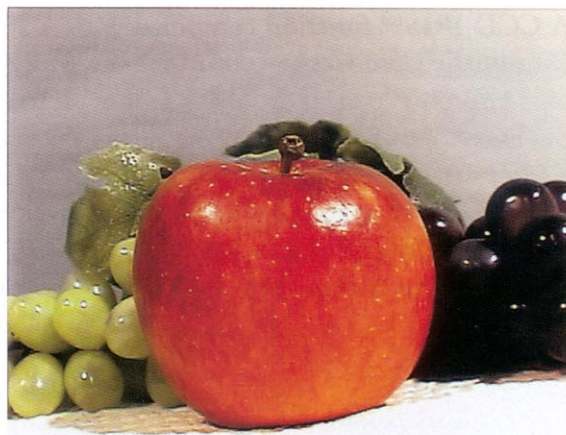
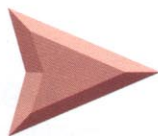

Adjusted to R: +40, G: 0, B: 0

## Excellent Color Reproduction

White balance adjustments are completely automatic. Just point at a white object and let the camera do the rest. But where most cameras stop, the DXC-LS1 has only begun. Color matrix technology adds another dimension of authenticity by allowing you to adjust the R, G

and B colors independently, while viewing the monitor, and without changing the overall white balance.

You can easily adjust the picture until the object on the screen looks exactly like the object in front of the camera.

## Convenient Controls

An on-screen menu system gives you easy access to all of the camera's built-in features. Often times you won't even need to open a menu. Just press the DISPLAY button to call up your favorite settings and begin shooting. For special situations, you can save up to



two sets of menu selections and call them up at any time. By displaying menus one line at a time, you can also make adjustments while viewing the actual picture on the screen.

## Exchangeable Camera Head

In case the camera head accidentally drops on the floor and gets damaged, Sony's sophisticated built-in electronics enable you to exchange only the camera head without needing to buy an entire new unit.

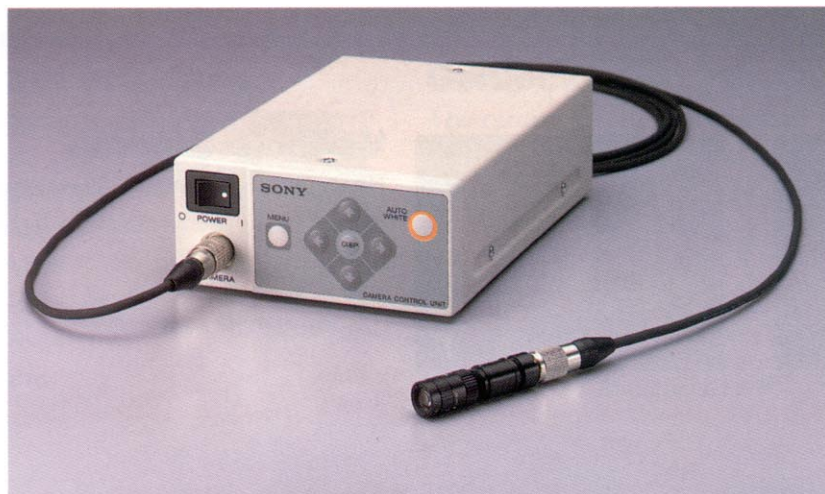

Lens shown is an option.



# Advanced DSP Functions

## Automatic Exposure Control

A CCD IRIS™ function combined with AGC (Automatic Gain Control) provides automatic control over incoming light. If the object in front of the lens is too bright, the camera switches automatically to a higher shutter speed. If the object is too dark, it automatically increases the gain. And the AE (Automatic Exposure) level can be finely adjusted from -60 to +60. The result is pictures that are always perfectly exposed.

## Automatic Backlight Adjustments

The DXC-LS1 can distinguish backlit from frontlit scenes and compensate accordingly, adjusting exposure automatically to objects in the scene you want to shoot.

## Light Metering Areas

The DXC-LS1 can measure light and make exposure adjustments in 5 different areas (whole picture, small area at center, large area at center, small slit and large slit). Objects in these areas are always appropriately lit, regardless of the brightness of surrounding objects.



Small area at center (C1)



Large area at center (C2)



Small slit (S1)

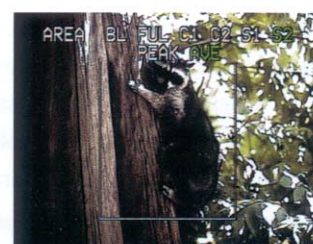

Large slit (S2)

## Electronic Zoom

The electronic zoom provides enlargements from 1.00× to 3.00×. This is especially effective because large zoom lenses cannot be used with cameras as small as the DXC-LS1.

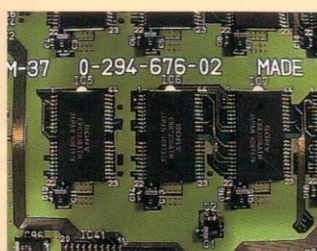

Original

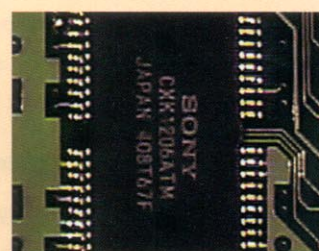

×3.00

## Long Term Exposure

When shooting very dark objects, you can set the shutter speed manually to 1/60 of a second or more and specify from 2 to 512 fields. Longer shutter speeds allow more light to accumulate on the CCD sensors, for a remarkable sensitivity.

Note: To use this function, an external memory unit/board is required.



Original

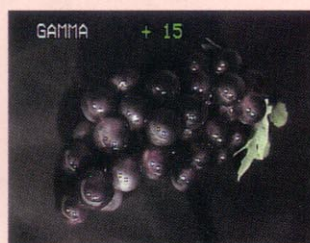

Gamma:+15

## Variable Gamma

By manually varying the gamma parameters, you can increase the contrast in lighter or darker parts of the picture, for a clear view of specific details.



## Outline Enhancers

While viewing the monitor, you can emphasize outlines in the vertical and horizontal directions, for excellent results in image analysis applications.



Low mode



Hi mode

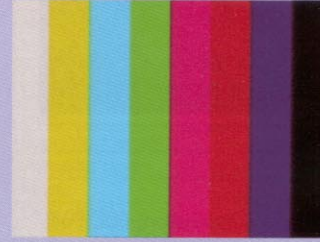

Full mode

## Color Bars

The DXC-LS1 can display color bars in 3 different sizes. The low and hi-screen modes allow you to make color adjustments while comparing objects on the screen against color bars – a feature available only from Sony.

## Innovative Flicker Cancellor

The DXC-LS1 cancels the flicker of fluorescent lights by automatically adjusting gain, freeing the electronic shutter for other uses.

## Negative and Positive Modes

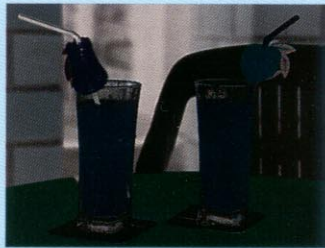

Negative



Positive

You can automatically shoot negative scenes as positive, or vice versa.

## B&W Mode

B&W mode provides sharp images free from color noise.

# Flexible System Configuration

## Computer Control Interface

The DXC-LS1 is equipped with an RS-232C serial interface, making it possible to control all of its functions from a computer. The date and time are automatically superimposed on the picture for added convenience in recording.



## Genlock

The camera can be synchronized with external VBS signals, for the precision required in broadcast and production environments.

## Video Outputs

The DXC-LS1 fits into any system, with BNC and 12-pin multi-connectors available for VBS (composite) video output, and S-video and 12-pin multi connectors for Y/C.



# Function Menu

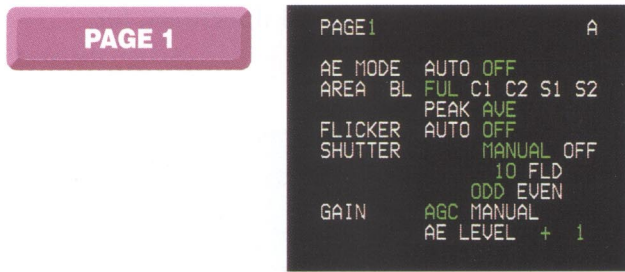

Control items	Selection
<b>PAGE 1</b>	
AE MODE	AUTO/OFF
AE LEVEL	-60 to 0 to +60
AREA	BL(Backlight compensation)/FUL(Full)/C(Center)1/C2/S(Slit)1/S2
FLICKER (canceller)	PEAK/AVE (average) switchable
SHUTTER	AUTO/OFF
AE LEVEL	AUTO/MANUAL/OFF
MANUAL	-60 to 0 to +60
	2 to 512 FLD (fields)
	ODD/EVEN switchable
GAIN	AGC/MANUAL
AE LEVEL	-60 to 0 to +60
MANUAL	0 to 12dB

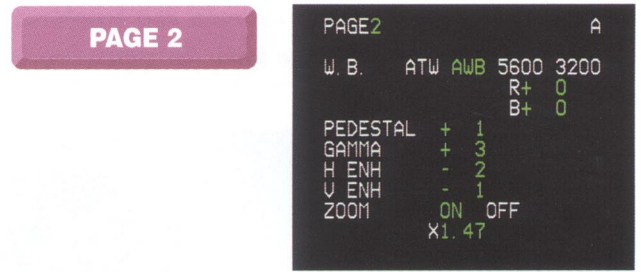

Control items	Selection
<b>PAGE 2</b>	
W.B. (White Balance)	ATW/AWB/5600(K)/3200(K)
R (Paint)*	-128 to 0 to +127
B (Paint)*	-128 to 0 to +127
PEDESTAL	-10 to 0 to +40
GAMMA	-16 to 0 to +15
H ENH (enhancer)	-16 to 0 to +15
V ENH (enhancer)	-16 to 0 to +15
ZOOM	ON/OFF
	×1.00 to ×3.00

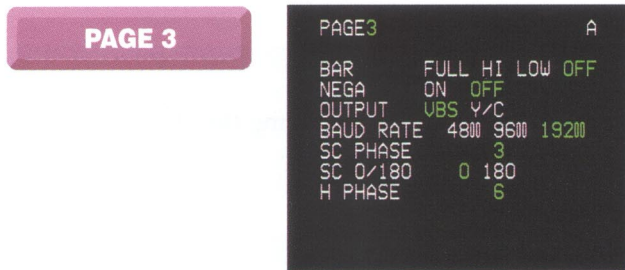

Control items	Selection
<b>PAGE 3</b>	
BAR	FULL/HI/LOW/OFF
NEGA	ON/OFF
OUTPUT	VBS/YC
BAUD RATE	4800/9600/19200
SC PHASE	0 to +255
SC 0/180	0/180
H PHASE	0 to +255

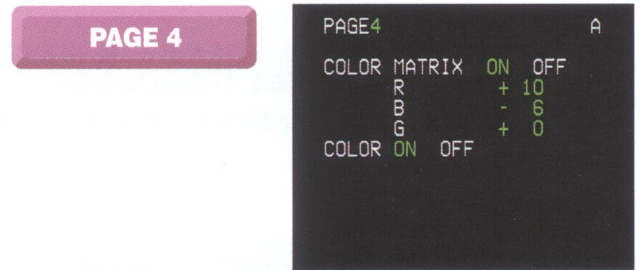

Control items	Selection
<b>PAGE 4</b>	
COLOR MATRIX	ON/OFF
R	-60 to 0 to +60
B	-60 to 0 to +60
G	-60 to 0 to +60
COLOR	ON/OFF

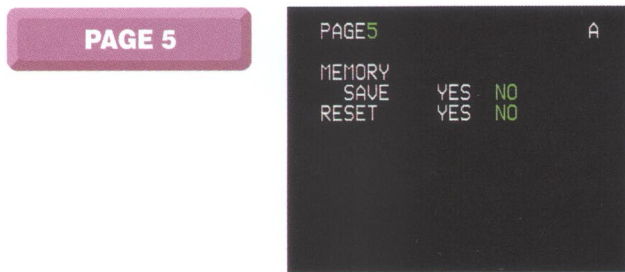

Control items	Selection
<b>PAGE 5</b>	
MEMORY SAVE	YES/NO
MEMORY RESET	YES/NO

\*AWB, 5600(K) and 3200(K) can be finely adjusted with this function.

## Camera Control Unit

### Front Panel



### Rear Panel



# Optional Accessories

## Camera Adaptor CMA-C2

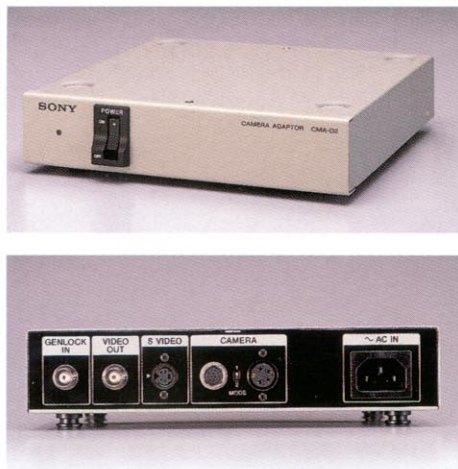

The CMA-D2 supplies DC 12V to the DXC-LS1. Connecting the CMA-D2 directly to the DXC-LS1 allows cables to be extended up to 100m.

### Specifications:

Connectors: CAMERA (12-pin MULTI)  
CAMERA (4-pin DIN)  
VIDEO OUT (BNC)  
S VIDEO OUT (Mini DIN 4-pin)  
GENLOCK IN (BNC)

DC out: 13V, 1.3A

Operating temperature: -5°C to 45°C (23°F to 113°F)

Power requirements: AC 100 to 240V, 50/60Hz

Power consumption: 24.5W

Dimensions (w/h/d): 210 × 44 × 200mm (8 3/8 × 1 3/4 × 7 7/8 inches)  
(excluding projecting parts)

Mass: 1.1kg (2 lb 7 oz)

Supplied accessories: AC power cord, Operation manual

## Camera Adaptor AC-E90HG



The AC-E90HG supplies DC 9V to the DXC-LS1.

### Specifications:

DC out: 9V, 800mA

Power requirements: AC 120V, 50/60Hz

Power consumption: 14W

Cable length: 2m (2.2 yards)

Mass: 500g (1 lb 2 oz)

Dimensions (w/h/d): 58 × 86 × 50.5mm (2 3/8 × 3 1/2 × 2 inches)

## Lenses



Models	VCL-04UVM	VCL-12UVM
Mount:	Ultra mount	Ultra mount
Focal length:	4mm	12mm
Maximum aperture ratio:	1:1.4	1:2.0
Filter size:	M10.5 × 0.5mm	M10.5 × 0.5mm
Back focal length:	5.00mm (IN AIR)	10.82mm (IN AIR)
Focusing range:	55mm ~ ∞	200mm ~ ∞
Mass:	4g (0.14 oz)	5g (0.17 oz)
Dimensions:		

Unit: mm (inch)

## C-mount Adaptor LO-UCMT



### Specifications

Mount: C-mount - Ultra mount

Mass: 8g (0.3 oz)

Dimensions: Ø29 × 12.9mm (1 3/16 × 17/32 inches)

## Camera Cable CCMC-16P03 / 10 (3/10m) 16-pin↔20-pin



## DC Cable CCDC-5 / 10 / 25 / 50A / 100A (5/10/25/50/100m) 12-pin↔4-pin



## 12-pin Multi Cable CCMC-12P02 / 05 / 10 / 25 (2/5/10/25m) 12-pin↔12-pin



## Typical System

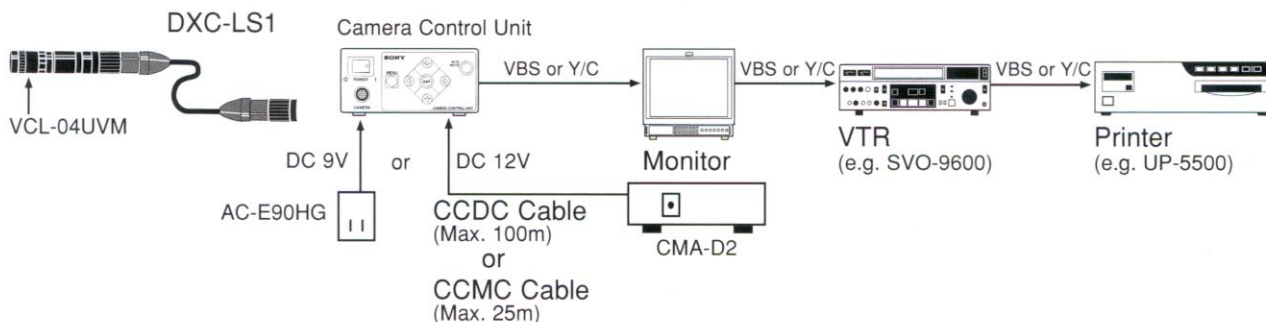



## Specifications

### Video

Image device:	1/4-inch Interline Transfer Hyper HAD CCD
Picture elements:	768 (H) × 494 (V)
Sensing area:	3.2 × 2.4mm (1/4-inch)
Signal system:	NTSC/EIA standard
Scanning system:	2:1 interlaced, 525 lines
Horizontal frequency:	15.734kHz
Vertical frequency:	59.94Hz
Sync system:	Internal or external with VBS
Phase control:	H (0 to +255)/SC (0/180, 0 to +255)
Horizontal resolution:	470TV lines
Sensitivity:	F5.6 at 2,000 lx
Minimum illumination:	10 lx (F1.2)
Signal-to-noise ratio:	46dB

### Adjustments

AE mode:	ON/OFF switchable
AE level:	-60 to 0 to +60
Gain control:	AGC/0 to +12dB (1dB steps)
Electronic shutter:	OFF/MANUAL/AUTO MANUAL: 1/60, 1/100, 1/125, 1/250, 1/500, 1/1000, 1/2000, 1/4000, 1/8000, 1/10000, 1/20000, 1/40000 (seconds) 2 to 512 fields, ODD/EVEN switchable
Light metering system:	Backlight compensation/Full/Center (Large)/Center (Small)/Slit (Large)/Slit (Small)
Detection method:	Peak/average switchable
White balance:	ATW (Auto Tracing White Balance)/AWB (Auto White Balance)/5600K/3200K (R/B paint: -128 to 0 to +127)
Master pedestal:	-10 to 0 to +40
H Enhancer:	-16 to 0 to +15
V Enhancer:	-16 to 0 to +15
Zoom:	ON (× 1.00 to × 3.00)/OFF switchable
Color Matrix:	ON/OFF switchable R: -60 to 0 to +60 G: -60 to 0 to +60 B: -60 to 0 to +60
Gamma:	-16 to 0 to +15
Color mode:	ON/OFF switchable
Color bars:	FULL/HI/LOW/OFF switchable
Negative/Positive reverse:	ON/OFF switchable
Menu memory:	2 pages
Flicker canceller:	AUTO/OFF switchable
Baud rate:	19200, 9600, 4800
Video out:	VBS: 1.0Vp-p, 75Ω, sync negative Y/C: Y: 1.0Vp-p, 75Ω, sync negative C: 0.286Vp-p, 75Ω, without sync

### General

Power requirements:	DC 12V (Supplied from CMA-D2) DC 9V (Supplied from AC-E90HG)
Power consumption:	5.0W
Operating temperature:	0°C to 40°C (32°F to 104°F)
Storage temperature:	-20°C to 60°C (-4°F to 140°F)
Maximum cable length:	10m using 10m optional cable (CCMC-16P10)
Mass:	Camera head: 8g (0.3 oz) (excluding supplied cable) Camera control unit: Approx. 665g (1 lb 7 oz)

### Connectors

Lens mount:	Ultra mount
Camera head:	CAMERA (16-pin)
Camera control unit:	CAMERA (20-pin), VIDEO OUT (BNC), DC IN/VBS (12-pin, DC jack), Y/C (DIN 4-pin), GENLOCK (BNC), RS-232C (8-pin), WE OUT (PIN)

### Supplied Accessories

Camera cable (3m), Tripod adaptor, Lens mount cap, Operation manual

### Dimensions:

Unit: mm (inch)

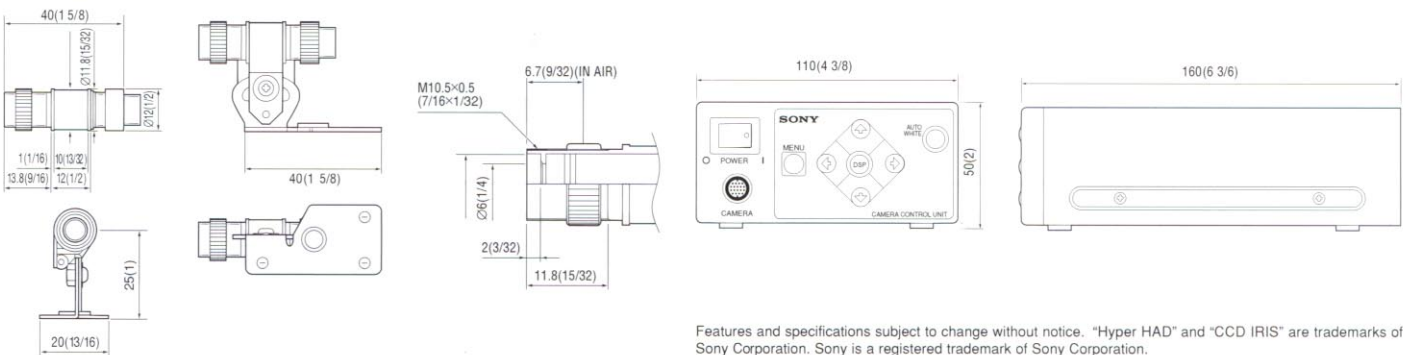

Features and specifications subject to change without notice. "Hyper HAD" and "CCD IRIS" are trademarks of Sony Corporation. Sony is a registered trademark of Sony Corporation.



## DXC-LS1 Connector Pin Assignments

### Camera control unit DIN 4-PIN (Y/C)

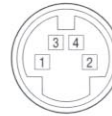

1	Y (G)
2	C (G)
3	Y (X)
4	C (X)

### 8-PIN (RS-232C)

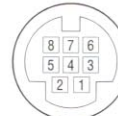

1	RTS
2	CTS
3	TXD
4	GND
5	RXD
6	NC
7	NC
8	NC

### 12-PIN (DC IN/VBS)



1	GND
2	+12V IN
3	GND
4	Y.OUT/VBS OUT
5	GND
6	NC
7	GENLOCK IN
8	GND
9	C OUT
10	GND
11	+12V IN
12	GND

### Camera head 16-PIN



1	V4
2	V3
3	H2
4	NC
5	-7.5V
6	CCD OUT
7	GND
8	SUB
9	V1
10	NC
11	NC
12	V2
13	PG
14	H1
15	+15V
16	+5V

### 20-PIN (CAMERA)



1	+15V
2	CCD OUT
3	-7.5V
4	H2
5	V3
6	GND
7	DET(-)
8	NC
9	NC
10	V4
11	SUB
12	DET(+)
13	NC
14	NC
15	H1
16	V1
17	NC
18	PG
19	V2
20	+5V