

Digital Powered Mixer

Operating Instructions

Before operating the unit, please read this manual thoroughly and retain it for future reference.

Note

The supplied CD-ROM includes operating instructions for the SRP-X700P Digital Powered Mixer (English, Japanese, French, German, Spanish, Italian and Chinese versions).

SRP-X700P

Ver. 1.3

WARNING

For customers in the U.S.A.

To prevent fire or shock hazard, do not expose the unit to rain or moisture.

To avoid electrical shock, do not open the cabinet. Refer servicing to qualified personnel only.

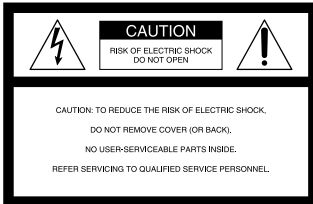

This symbol is intended to alert the user to the presence of uninsulated “dangerous voltage” within the product’s enclosure that may be of sufficient magnitude to constitute a risk of electric shock to persons.



This symbol is intended to alert the user to the presence of important operating and maintenance (servicing) instructions in the literature accompanying the appliance.

Français

AVERTISSEMENT

Afin d’éviter tout risque d’incendie ou d’électrocution, ne pas exposer l’appareil à la pluie ou à l’humidité.

Afin d’écarter tout risque d’électrocution, garder le coffret fermé. Ne confier l’entretien de l’appareil qu’à un personnel qualifié.

- Faites uniquement fonctionner cet appareil sur une tension de 120 V CA, 50/60 Hz.

CAUTION

You are cautioned that any changes or modification not expressly approved in this manual could void your authority to operate this equipment.

INFORMATION

This equipment has been tested and found to comply with the limits for a Class B digital device, pursuant to Part 15 of the FCC Rules. These limits are designed to provide reasonable protection against harmful interference in a residential installation. This equipment generates, uses, and can radiate radio frequency energy and, if not installed and used in accordance with the instructions, may cause harmful interference to radio communications.

However, there is no guarantee that interference will not occur in a particular installation. If this equipment does cause harmful interference to radio or television reception, which can be determined by turning the equipment off and on, the user is encouraged to try to correct the interference by one or more of the following measures:

- Reorient or relocate the receiving antenna.
- Increase the separation between the equipment and receiver.
- Connect the equipment into an outlet on a circuit different from that to which the receiver is connected.
- Consult the dealer or an experienced radio/TV technician for help.

If you have any questions about this product, you may call:

Sony’s Business Information Center (BIC) at 1-800-686-SONY (7669)

or Write to:

Sony Customer Information Services Center 6900-29 Daniels Parkway, PMB 330 Fort Myers, Florida 33912

Declaration of Conformity

Trade Name : SONY
Model No. : SRP-X700P
Responsible Party : Sony Electronics Inc.
Address : 680 Kinderkamack Road, Oradell, NJ. 07649 U.S.A.
Telephone No. : 201-930-6972

This device complies with Part 15 of the FCC Rules.

Operation is subject to the following two conditions;

- (1) This device may not cause harmful interference, and
- (2) this device must accept any interference received, including interference that may cause undesired operation.

For customers in Canada

This ClassB digital apparatus complies With Canadian ICES-003.

Owner’s Record

The model and serial numbers are located on the rear of the unit. Record the serial number in the space provided below. Refer to them whenever you call upon your Sony dealer regarding this product.

Model No. SRP-X700P

Serial No. _____

IN NO EVENT SHALL SELLER BE LIABLE FOR ANY DIRECT, INCIDENTAL OR CONSEQUENTIAL DAMAGES OF ANY NATURE, OR LOSSES OR EXPENSES RESULTING FROM ANY DEFECTIVE PRODUCT OR THE USE OF ANY PRODUCT.

Table of Contents

Features	3
Location and function of parts	4
Front panel	4
Rear panel	6
Tuner Unit	8
How to install the tuner unit	8
How to remove the tuner unit	8
How to Control the Display from the SRP-X700P	9
PROJECTOR CONTROL RS-232C Terminal	9
PROJECTOR CONTROL CONTROL S IN/OUT Terminal	9
How to Control the SRP-X700P from External Equipment	9
REMOTE RS-232C Terminal	9
REMOTE PARALLEL Terminal	10
How to Control AV Equipment from the SRP-X700P	11
Connecting the Speaker	11
System Configuration	12
System example when operating the SRP-X700P with the default setting when shipped from the factory	12
System example when external operation panel and environment equipment are connected	13
System example when operating the SRP-X700P from the REMOTE PARALLEL terminal	14
Default settings	15
Block Diagram	17
Specifications	18
Dimensions	19
Troubleshooting	20

This unit can be used even without setting the parameters by using the supplied SRP-X700P Manager software. See page 15 for the default parameters when shipped from the factory.

ABOUT SUPPLIED CD-ROM

The supplied CD-ROM contains the two applications SRP-X700P Manager and User Control Panel. In addition to the two applications, the supplied CD-ROM contains the dedicated USB driver software, the Control Software Manual and the SRP-X700P Operating Instructions.

The Control Software Manual and the SRP-X700P Operating Instructions are supplied as PDF files.

To open these files, Adobe Acrobat® Reader must be installed into your PC.

To get Adobe Acrobat Reader, download from www.adobe.com

Microsoft and Windows are registered trademarks of Microsoft Corporation (U.S.A. and other countries).

Adobe and Adobe Acrobat Reader are trademarks of the Adobe Systems Incorporated.

Features

The SRP-X700P is a versatile digital powered mixer that incorporates an audio mixer, RGB/video switcher, processor and power amplifier in the 3U rack size.

Built-in digital mixer

The digital mixer incorporates A/D and D/A converters operating at 24 bit/48 kHz sampling and a high-performance DSP. In addition to the usual functions of conventional ordinary audio mixers, the SRP-X700P offers functions such as a feedback reducer in the independent channel and automatic mixing by using digital technology.

Many audio input/output terminals

Six microphone input systems and two stereo line input systems can be freely assigned to ten output systems.

Support for RGB/Component signals

The SRP-X700P is equipped with three composite/S video input systems and three RGB/component input systems. This broad input system eliminates need for a separate RGB switcher and video switcher and enables simple system configuration. The SRP-X700P supports high-resolution component signals such as 480 p and 1080 i, and also supports SXGA¹⁾ (1280 × 1024 pixels) of RGB signals.

Built-in power-saving digital amplifier

A power amplifier of 150 W + 150 W (8 Ω) or 200 W + 200W (4 Ω) is incorporated. The rated power consumption is almost half that of the conventional amplifier. The SRP-X700P also supports high impedance speakers 150 W (70 V LINE, 32 Ω).

Support for 5.1-channel audio input

4D and 4E INPUT terminals of LINE4 INPUT terminal support 5.1-channel audio input.

Useful external remote terminal

- **RS-232C terminal**
This terminal enables outside personal computer and system controller to control various operations of the SRP-X700P. This terminal can also be used to turn on the power of a Sony projector and plasma display, or put it in STANDBY. It also can be used to select the input signals.
- **Equipped with Control S output terminal**
Basic operations (playback, stop, fast forward, rewind, etc.) of the Sony AV products are possible.
- **Equipped with parallel input and output terminals**
Input selection, volume control and scene control of the SRP-X700P can be performed in the input terminal. Operation of environment equipment such as screen and lighting, and the status display of the SRP-X700P can be performed via the output terminal.

Installation of two systems of 800 MHz band wireless tuner units WRU-806B (option)

Mountable in the EIA standard 19-inch rack (occupying 3U size)

Setting up and operating the SRP-X700P using the supplied software

The CD-ROM supplied with the SRP-X700P contains two software applications. One is the User Control Panel that enables an external personal computer to perform basic operations (sound volume adjustment, input selection and scene control) of the SRP-X700P and also the basic operations (playback, stop, fast forward, rewind, etc.) of a Sony DVD, VCR, CD, MD and the like. The other is SRP-X700P Manager, which enables you to perform internal settings of the SRP-X700P.

¹⁾ SXGA are registered trade marks of the International Business Machines Corporation, U.S.A.

Location and function of parts

Front panel

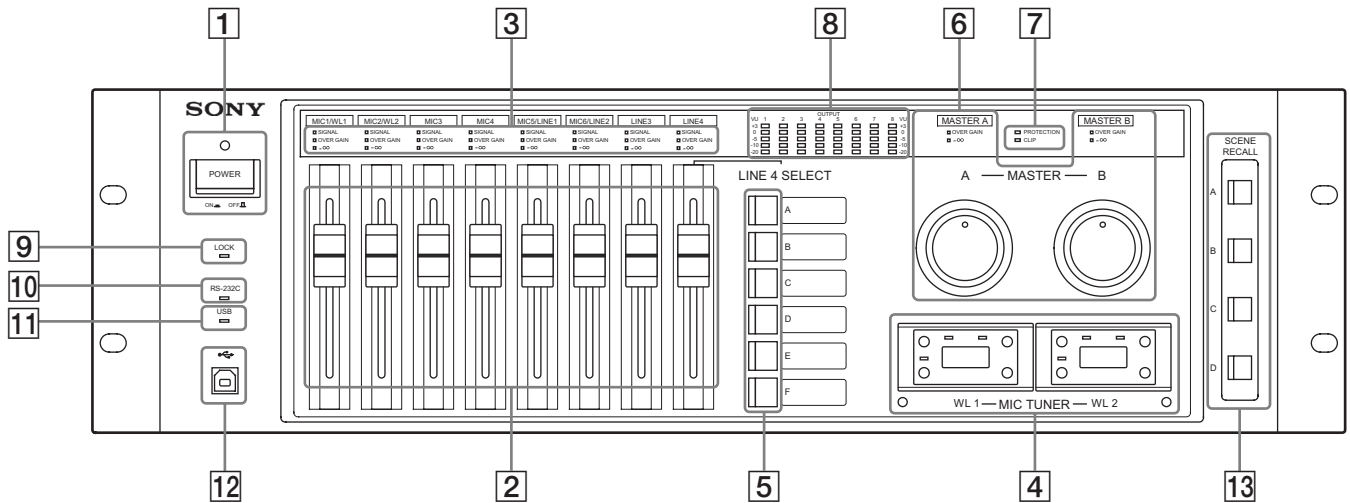

1 POWER button and POWER indicator

Pressing the POWER button turns on the power. The POWER indicator lights in green when the power turns on.

You can switch the projectors and displays connected to the SRP-X700P, to power-on state or to power standby state from the SRP-X700P as they are interlocked by the SRP-X700P Manager setup.

By default when shipped from the factory, the projectors and displays powers are interlocked with the POWER button of the SRP-X700P.

Turning on the POWER button of the SRP-X700P, sets the AV equipment connected to the CONTROL S OUT terminals 1 through 4, to power-on state. Note that the AV equipment does not enter the power standby state when the POWER button of the SRP-X700P is turned off.

2 Input faders

• MIC1/WL1 and MIC2/WL2 faders

Adjusts the level of the signals supplied from the MIC1/WL1 and MIC2/WL2 input terminals.

Either a wireless microphone or wired microphone can be connected. When the wireless tuner receives the signal, the wireless microphone is selected automatically.

• MIC3 and MIC4 faders

Adjusts the level of the signals supplied from the MIC3 and MIC4 input connectors.

• MIC5/LINE1 and MIC6/LINE2 faders

Adjusts the level of the signals supplied from the MIC5/LINE1 and MIC6/LINE2 input terminals. The MIC/LINE selector button on the rear panel can be used to switch the reference input level.

By default, LINE is selected.

• LINE3 and LINE4 faders

Adjusts the level of the signals supplied from the LINE3 and LINE4 input terminals.

These input faders are not the “moving” type.

3 Input indicators

• SIGNAL indicator

The SIGNAL indicator lights in green when a signal is input to each input terminal.

• OVER GAIN indicator

The OVER GAIN indicator lights in red when the input level exceeds the GAIN LIMIT value that is set up by the SRP-X700P Manager.

By default, the GAIN LIMIT is set to 10 dB.

• -∞ indicator

The -∞ indicator lights in yellow when no audio is output in such cases as muting or when the INPUT fader is located at the -∞ level position.

4 Tuner slots (WL 1/2)

This slot accepts the 800 MHz band wireless tuner unit WRU-806B (option). It accepts up to two units. (For installation, refer to page 8.) The WRU-806B Operating Instructions provide full details on operating the tuner unit.

For operation of the tuner unit, read the WRU-806B Operating Instructions thoroughly.

5 LINE 4 SELECT button

You can select a device to be connected to the input connectors from 4A to 4F of LINE 4.

6 Master volume

With the master volume, you can control multiple faders that are set as a single group. The faders to be controlled by the master volume are set by the SRP-X700P Manager.

By default, the MASTER A is set to MIC1 to MIC4 input faders, and the MASTER B is set to LINE1 to LINE4 input faders.

The master volume is not the “moving” type.

• OVER GAIN indicator

The OVER GAIN indicator lights in red when the input level exceeds the GAIN LIMIT value that is set by the SRP-X700P Manager.

By default, the GAIN LIMIT is set to 10 dB.

• -∞ indicator

The -∞ indicator lights in yellow when no audio is output in such cases as muting or when the INPUT fader is located at the -∞ level position.

7 Power amplifier indicators

• PROTECTION indicator

The PROTECTION indicator lights in red when the protection circuit of the internal power amplifier works.

• CLIP indicator

The CLIP indicator lights in red when the output level of the internal power amplifier is excessive such that the output signal is distorted.

Notes

When the PROTECTION indicator lights

The protection circuit operates (PROTECTION indicator lights) and the speaker and amplifier are protected from damage by decreasing or cutting the output signal in case of the following:

- If the temperature of the heat sink inside the amplifier exceeds the specified value.
The connected speaker impedance is too low.
Air intake and exhaust holes (on the right and left sides of the SRP-X700P) are choked by dust.
- The SPEAKERS terminal is short-circuited.
In such a case, turn the POWER button to the OFF position and remove the cause of the fault before using the unit again.
- If DC voltage appears in the SPEAKERS terminal due to failure.
Turn off the POWER button and contact your local Sony Sales office or Dealer.

8 Level meters

Displays the output signal levels of the LINE OUTPUT 1 to LINE OUTPUT 8 terminals, with the 5-point LED.

9 LOCK indicator

The LOCK indicator lights in red when the SRP-X700P Manager locks the front panel of the SRP-X700P to prevent illegal operation. While lit, you cannot control any operations from the front panel of the SRP-X700P.

10 RS-232C indicator

The RS-232C indicator lights in green when a command is sent or received through the REMOTE RS-232C terminal.

11 USB indicator

The USB indicator lights in green when a command is sent or received through the USB terminal or the REMOTE USB terminal.

12 USB terminal

Connect the SRP-X700P to a computer in which the supplied software (SRP-X700P Manager and User Control Panel) is installed using the USB terminal.

13 SCENE RECALL button

You can recall the scene memories A to D.

Use the SRP-X700P Manager to assign the scenes to the scene memories A to D.

By default, the scene memory A is assigned to scene No. 1, the scene memory B is assigned to scene No. 2, the scene memory C is assigned to scene No. 3 and the scene memory D is assigned to scene No. 4.

Location and function of parts

Rear panel

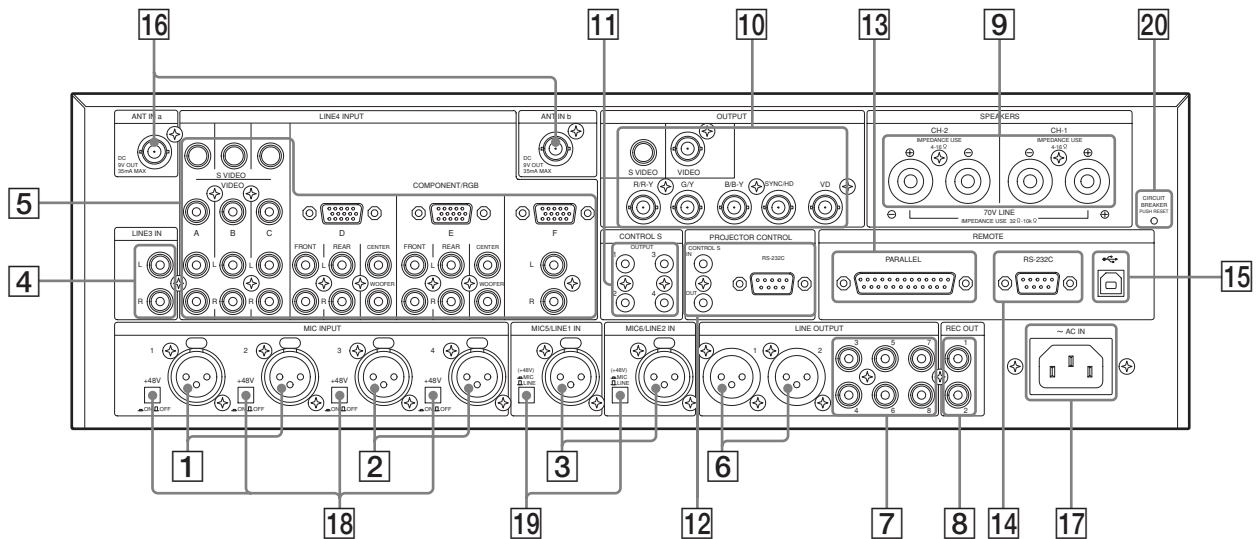

1 MIC INPUT 1 and MIC INPUT 2 terminals

The microphone input terminals.
The wireless microphone has the first priority when the tuner unit is installed but you can use the wired microphone up until you turn ON the POWER of the wireless microphone.

2 MIC INPUT 3 and MIC INPUT 4 terminals

The microphone input terminals.

3 MIC 5/LINE 1 IN and MIC 6/LINE 2 IN terminals

The microphone and line input terminals.
You can select the input level of these input terminals with the 19 MIC/LINE selector button. When you select the microphone level, the DC +48 V power is output to the condenser microphone automatically.
By default, they are set to the LINE (□).

4 LINE 3 IN terminals

The input terminals for audio products.

5 LINE 4 INPUT terminals

The input terminals for AV equipment.
As to the video input signals, the combination of composite signal and S video signal or the combination of component signal and RGB signal is selected by the SRP-X700P Manager for each channel.

• 4A, 4B and 4C input terminals

The video input terminals for accepting the composite and S video signals, and the stereo audio input terminal.
By default, they are set to -10 dBu with the composite signal.

• 4D and 4E input terminals

The video input terminals for accepting the component and RGB signals, and the audio input terminal accepting the 5.1-channel surround audio signal.
By default, 4D is set to -10 dBu with the component signal and 4E is set to -10 dBu with the RGB signal.

• 4F input terminal

The video input terminals for accepting the component and RGB signals, and the stereo audio input terminal.
By default, it is set to -10 dBu with the RGB signal.

<LINE4 INPUT COMPONENT/RGB terminal>

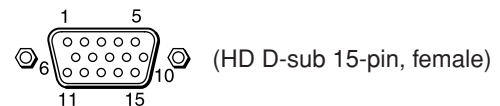

Pin No.	Function	Pin No.	Function
1	Video input R/R-Y	9	N.C
2	Video input G/Y	10	GND
3	Video input B/B-Y	11	N.C
4	GND	12	N.C
5	N.C	13	Composite sync signal/ horizontal sync signal, SYNC/HD
6	GND	14	Vertical sync signal VD
7	GND	15	N.C
8	GND		

6 LINE OUTPUT 1 and LINE OUTPUT 2 terminals

The audio output terminals.

7 LINE OUTPUT 3 to LINE OUTPUT 8 terminals

The audio output terminals.

8 REC OUT terminal

The audio output terminal.
Usually, connect this terminal to an MD unit for recording.

9 SPEAKERS terminal

The output terminal of the internal power amplifier.
You can connect a high impedance speaker (70 V LINE). (In the case of high impedance speaker 70 V LINE, the output signal becomes monaural.) You can select the output signal and operating mode with the SRP-X700P Manager.
By default, the operating mode is set to Lo impedance and the output signal is set to LINE OUT1 and LINE OUT2.
For the speaker connection, see "Connecting the Speaker" on page 11.

10 Video output terminals

The video signal that is selected by the LINE 4 SELECT button on the front panel is output from this terminal. (The video signal format is not converted from each other.)

- **5BNC output terminals**
The RGB and component signal output terminals.
- **VIDEO terminal**
The composite signal output terminal.
- **S VIDEO terminal**
The S VIDEO signal output terminal.

11 CONTROL S OUTPUT 1 to CONTROL S OUTPUT 4 terminals

You can control AV equipments connected to the LINE 3 IN terminal and LINE 4 INPUT terminal by remote control through these terminals.

Note

The AV equipment connected to the LINE3 IN terminal cannot be controlled from supplied software User Control Panel.

You can perform the basic operations of Sony DVD, VCR, CD, MD and CD-R audio, such as playback, stop, fast forward and rewind. You can select either the wired connection or the wireless connection for each terminal from the SRP-X700P Manager.

12 PROJECTOR CONTROL terminals

The SRP-X700P can controls a applicable projector and plasma display connected to the video output terminals from this terminal.

By default, connection to use the VPL-FX50 is set through RS-232C.

- **RS-232C terminal**
This terminal is for a projector or plasma display having the RS-232C terminal.
- **CONTROL S IN/OUT terminal**
The SRP-X700P can control a projector without the RS-232C terminal through the CONTROL S.
When controlling a projector using the CONTROL S OUT terminal, mixed use of the component signal and the RGB signal is not possible.

13 REMOTE PARALLEL terminal

The parallel remote terminal contains 12 INPUTs and 10 OUTPUTs.

You can control the SRP-X700P from external remote equipment using the INPUT parallel remote pins. You can control the external remote equipment from the SRP-X700P using the OUTPUT parallel remote pins. You can select the functions of the respective terminals using the supplied SRP-X700P Manager software.

14 REMOTE RS-232C terminal

The RS-232C remote terminal.

You can control the SRP-X700P with external equipment connected to the RS-232C terminal from a remote location.

15 REMOTE USB terminal

You can connect a personal computer in which the supplied software (SRP-X700P Manager and User Control Panel) is installed, to the SRP-X700P through the USB terminal. Note that the USB terminal on the front panel has priority if the USB terminal on the front panel is being used.

16 ANT IN terminal

The antenna input terminal for the wireless tuner. Connect a UHF antenna of the AN-820A (option).

9V power is supplied from this terminal as the power for the antenna booster. Do not connect any antenna other than the AN-820A, otherwise the system may not work or may cause failure.

Note

For details of installation and connection of an antenna, thoroughly read the operating instructions supplied with the antenna.

If the antenna is not installed correctly, it may cause defective reception resulting in intermittent sound. Especially, if the location cannot be changed easily after installing the antenna, check the operations thoroughly prior to installation. Connect the antenna using coaxial cable having the impedance of 50 Ω. The maximum length of the cable is approximately 50 m with 5D-FB. Do not use the cable of a 75 Ω system such as 5C-2V, as its maximum length is half that of the 5D-FB and it may cause a trouble.

If noise occurs:

There can be a case that a specific channel cannot be used due to external noise or the noise caused by interference radio wave depending on the installation location. In such a case, find a channel that does not illuminate the RF indicator when the wireless microphone power and the transmitter power are turned off (i.e., the channel that is not adversely affected by noise and interference radio wave). Use the unaffected channel. Select the same unaffected channel for the wireless microphone and the transmitter.

17 AC IN terminal

Connect the power cord supplied to this terminal.

18 + 48 V button

Press this button to supply the DC +48V condenser microphone power to the MIC INPUT 1 to MIC INPUT 4 terminals. When this button is pressed ON (⏻), DC +48 V is output.

By default, this button is set to OFF (⏻).

19 MIC/LINE selector button

You can select the input level of the MIC 5/LINE 1 IN and MIC 6/LINE 2 IN terminals with this button. (Refer to page 18.)

Also, when this button is set to the (+48 V) MIC (⏻) position, the DC +48 V condenser microphone power is output automatically.

By default, this button is set to LINE (⏻).

Notes

- The depressed position, which is the ON position, of both the 18 +48 V button and the 19 MIC/LINE selector button is lower than the face of the rear panel. The depressed ON position is designed intentionally to prevent mis-operation.
- Before you make any attempt to disconnect and connect cables or to press any of the +48 V button, MIC/LINE selector button or other buttons, be sure to decrease the input fader completely or to turn off the power.

20 CIRCUIT BREAKER

The circuit breaker works to turn off the main power of this unit if an excessive current flows in the power supply of this unit. If the circuit breaker trips, please contact your local Sony Sales office or Dealer.

Location and function of parts

Tuner Unit

How to install the tuner unit

- 1 Turn off the power of this unit.
- 2 Remove the tuner cover.
- 3 Check the up and down sides of the tuner unit, and insert it into the slot. (Fig. 1)

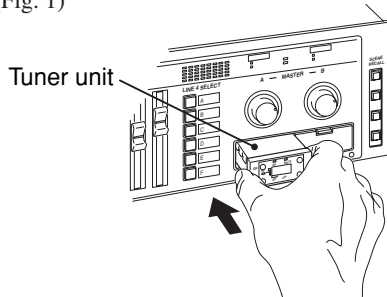

Fig. 1

- 4 After installation of the tuner unit, turn on the power of the unit and turn on the power of the wireless microphone to check it is receiving. While receiving, the RF/SIGNAL indicator lights up. The RF/SIGNAL indicator will not light up when the setting channel of the microphone is different from the setting of the tuner unit, or when the microphone power is consumed.

Notes

- Take the following precautions to prevent interference and noise.
- If there is a TV broadcasting station nearby, to avoid possible interference from its broadcasting, do not use that station's channel.
 - When simultaneously using two tuners, always set the tuners to different channels within the same group (other than group 00).
 - Please make a choice of model in accordance with your area to use picking up an unused TV channel.
 - Make sure that the channel selected on the microphone is the same as that selected on the tuner being used in the same system.

How to remove the tuner unit

- 1 Turn off the power of this unit.
- 2 Insert a screwdriver having the shaft diameter of 2 to 4 mm or less with shaft length of 30 mm or longer, into the hole under the lower part of the tuner slot as shown. Remove the tuner unit. (Fig. 2)

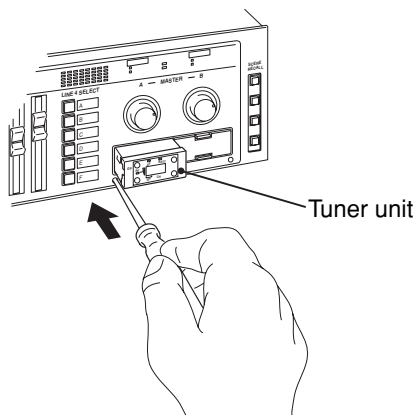

Fig. 2

Note

Insert it deeply into the slot.
Do not insert or remove the tuner unit while the power is on. This may cause noise.

CAUTION

To prevent breakdown or injury, do not put your hand inside of the slot.

Please refer to the table Sony 800 MHz-band system models frequency range in the Operating Manual of Wireless Microphone or Transmitter.

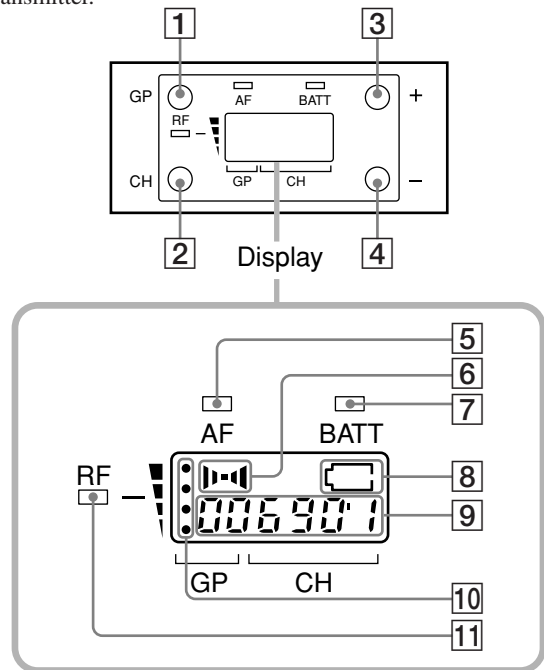

- 1 GP (group) button**
To change the group, press the + or – button while holding this button down.
- 2 CH (channel) button**
To change the channel in a group, press the + or – button while holding this button down.
- 3 + button**
To go to a higher group or channel, press this button while holding the GP or CH button.
Press this button changes the indication from GP/CH to frequency.
- 4 – button**
To go to a lower group or channel, press this button while holding the GP or CH button.
- 5 AF (audio frequency) indicator**
- 6 AF (audio frequency) level indications**
The indicator lights and the indications appear when the audio output level is higher than the reference level.
- 7 BATT (battery) indicator**
- 8 BATT (battery) indication**
Indicate the condition of the wireless microphone transmitter batteries. The indicator and indication appear and start flashing about one hour before the transmitter batteries go flat. The time at which flashing begins will depend on the type of battery used in the transmitter, and its condition.
- 9 GP/CH (group/channel) indication**
Shows the reception channel group and respective channel number.
Pressing the + button changes this indication to the frequency indication.
- 10 RF (ratio frequency) level indications**
- 11 RF (ratio frequency) indicator**
The indicator lights and the indications (dots) appear when the antenna reception is optimal. Depending on the RF input level, the number of dots changes.

How to Control the Display from the SRP-X700P

For the projectors that the SRP-X700P supports by default, refer to the “List of supported projectors” on a separate document.

PROJECTOR CONTROL RS-232C Terminal

To connect the RS-232C terminal of applicable projectors and that of plasma display to this terminal;
This model can switch the input signals and power ON/STANDBY of the projector and plasma display in interlocked condition.

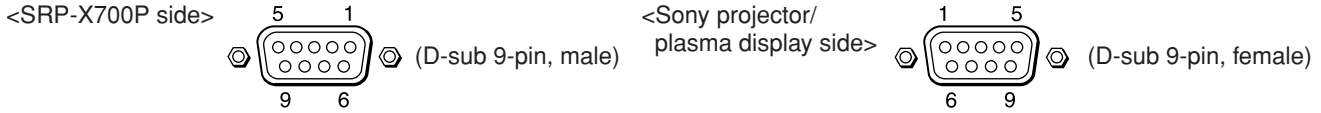

Pin No.	Signal	Function
1	FG	Frame ground
2	RD	Receive data
3	TD	Send data
4	ER	Not connected
5	SG	Signal line ground
6	DR	Not connected
7	RS	Not connected
8	CS	Not connected
9	N. C	Not connected

Pin No.	Signal	Function
1	FG	Frame ground
2	RX DA	Receive data
3	TX DA	Send data
4	DTR	Data terminal ready
5	GND	Ground
6	DSR	Data set ready
7	RTS	Request to send
8	CTS	Clear to send
9	RI	Called display

PROJECTOR CONTROL CONTROL S IN/OUT Terminal

The SRP-X700P can switch the input signals and power ON/STANDBY of the projector automatically when CONTROL S cable is connected to Sony’s projector as interlocked operation. The RGB signal and the component signal cannot be connected at the same time for the interlocked operation. Connect the wired remote commander supplied with a projector to the CONTROL S IN terminal. Then you can establish various setups of a projector from the SRP-X700P. If you want to use the wired remote commander on battery, locally fabricate a connecting cord with STEREO mini plug connected at one end, for supplying the power.

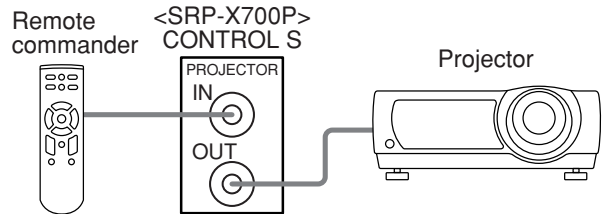

How to Control the SRP-X700P from External Equipment

Note

The USB terminal and the REMOTE USB terminal are the dedicated terminal to control this unit from the SRP-X700P Manager and User Control Panel.

REMOTE RS-232C Terminal

Use of this terminal enables you to control the SRP-X700P from an external controller.

- Terminal shape : D-sub 9-pin, male (with inch-type screws)
- Electrical specifications : Conforms to RS-232C standard
- Recommended cable : Multi-core shielded cable for data communication
- Cable length : 15 m or less
- Communication format
- Baud rate : 9600 bps
- Bit length : 8 bits
- Stop bit : 1 bit
- Parity : ODD (odd number)

Pin No.	Signal	Function
1	FG	Frame ground
2	RD	Receive data
3	TD	Send data
4	ER	Not connected
5	SG	Signal line ground
6	DR	Not connected
7	RS	Not connected
8	CS	Not connected
9	N. C	Not connected

Note

Use the null modem cable when connecting the SRP-X700P with computer.

How to Control the SRP-X700P from External Equipment

REMOTE PARALLEL Terminal

The REMOTE PARALLEL terminal enables the SRP-X700P to be remotely controlled with a simple circuit connected externally to this terminal.

Terminal shape	: D-sub 25-pin, female
Recommended cable	: Multi-core shielded cable for data communication
Cable length	: 50 m or less

INPUT terminal

You can set the functions of the respective terminals from the PARALLEL INPUT FUNCTION setup box in the REMOTE screen of the supplied SRP-X700P Manager software.

All faders and sound volume controls can be controlled from a remote location by connecting a variable resistor as shown, in the range of 0 to $-\infty$ dB.

You can perform the following operations by adding a make contact.

- Input selection of LINE 4 system
- Muting
- Scene recall
- Sound volume adjustment (Up/Down)
- Controlling the AV equipment connected to the CONTROL S terminal
- Power-ON/STANDBY selection of a projector

OUTPUT terminal

The turning ON conditions of the respective pins of the OUTPUT terminal can be set from the following.

- Input selector state of LINE 4 system
- Turning ON the OVER and $-\infty$ indicators
- Turning ON the scene recall button
- Generation of the Power-ON/STANDBY command of a projector

You can select the ON conditions from the PARALLEL OUTPUT FUNCTION setup box on the REMOTE screen of the supplied SRP-X700P Manager software.

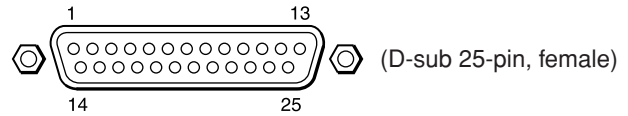

<Example of input circuit>

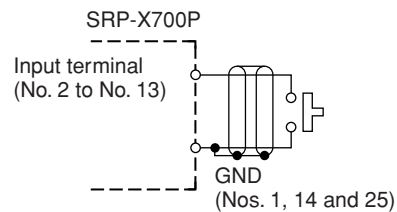
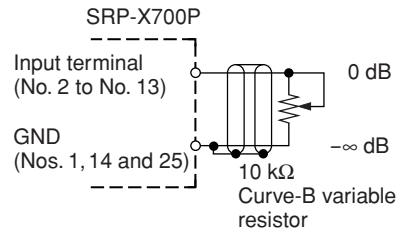

<Example of output circuit>

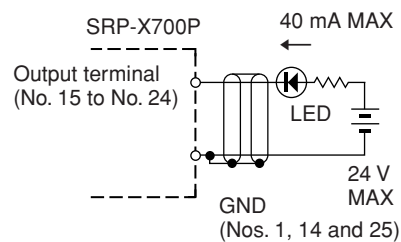

Pin No.	Function
1	GND
2	INPUT1
3	INPUT2
4	INPUT3
5	INPUT4
6	INPUT5
7	INPUT6
8	INPUT7
9	INPUT8
10	INPUT9
11	INPUT10
12	INPUT11
13	INPUT12
14	GND
15	OUTPUT1
16	OUTPUT2
17	OUTPUT3
18	OUTPUT4
19	OUTPUT5
20	OUTPUT6
21	OUTPUT7
22	OUTPUT8
23	OUTPUT9
24	OUTPUT10
25	GND

Notes

- Do not apply any reverse voltage across the output terminal.
- Do not connect the shield cable of the REMOTE wire and the GND wire to the terminal table or the like. It can cause malfunction and noise.
- Install the REMOTE cable away from the dimmer, motor and others.
- When the PARALLEL input terminal is used to set the projector power to either the power-ON state or to the power-STANDBY state, the projector power enters the power-ON state when the PARALLEL input is set to ON. The projector power enters the power-STANDBY state when the PARALLEL input is set to OFF. Therefore, use an alternate type switch for power control.

How to Control AV Equipment from the SRP-X700P

The SRP-X700P can control the Sony equipment connected to the CONTROL S OUTPUT1 through 4 terminals. The procedure to set up the MACHINE CONTROL on the SRP-X700P Manager, and the functions, which can be operated, from the SRP-X700P are shown in the table below. Note that the functions of REC, POWER ON, and POWER STANDBY cannot be operated from the supplied software SRP-X700P Manager and User Control Panel, to prevent the system from malfunctioning.

MACHINE TYPE	Supported equipment	Operations								
		PREV.	NEXT	STOP	REW.	PLAY	F.F.	PAUSE	REC	POWER ON/STANDBY
DVD ^{*1}	DVD player DVD recorder ^{*2}	○	○	○	○	○	○	○	—	○
VTR1 (Beta)	Betamax VCR	—	—	○	○	○	○	○	○	○
VTR2 (8mm)	8 mm video VCR	—	—	○	○	○	○	○	○	○
VTR3 (VHS)	VHS VCR	—	—	○	○	○	○	○	○	○
VTR4 (DV)	Digital video VCR	—	—	○	○	○	○	○	○	○
CD	CD player	○	○	○	○	○	○	○	—	○
MD	MD recorder	○	○	○	○	○	○	○	○	○
CD-R	CD-R for audio	○	○	○	○	○	○	○	○	○
Blu-ray Disc ^{*3}	Blu-ray disc recorder ^{*2}	○	○	○	○	○	○	○	—	○
Inst. VTR	Professional use VCR (DVCAM and others) ^{*4} Network player ^{*5}	○	○	○	○	○	○	○	○	○
Cassette Deck	Audio cassette deck ^{*6}	—	—	○	○	○	○	○	○	○

*1 Set the remote control mode of the deck in use, to the DVD1 mode before use.

*2 The "Recording" function of the DVD recorder and that of the Blu-ray disc recorder are not supported so that they cannot be controlled.

*3 Set the remote control mode of the deck in use, to the BD1 mode before use.

*4 If you want to use the control S terminal of the DSR series to control the VCR, select "Inst. VCR". If you want to use the AV mouse VM-50 (option) to control the VCR, select the VCR4 (DV) mode.

*5 For the network player (NSP-100), only the Play, Pause and Stop functions on the play list that is set for the Play button one-touch playback are enabled.

*6 If you use the double cassette audio deck, only the deck B can be controlled.

Use the supplied IR transmitter VM-50 to control the Sony equipment that is not equipped with the CONTROL S terminal.

- Confirm location of the remote control signal receptor part of the Sony equipment that you want to control, and fix the supplied IR transmitter VM-50 with a both-sided adhesive tape as shown below.

Setting Requirements

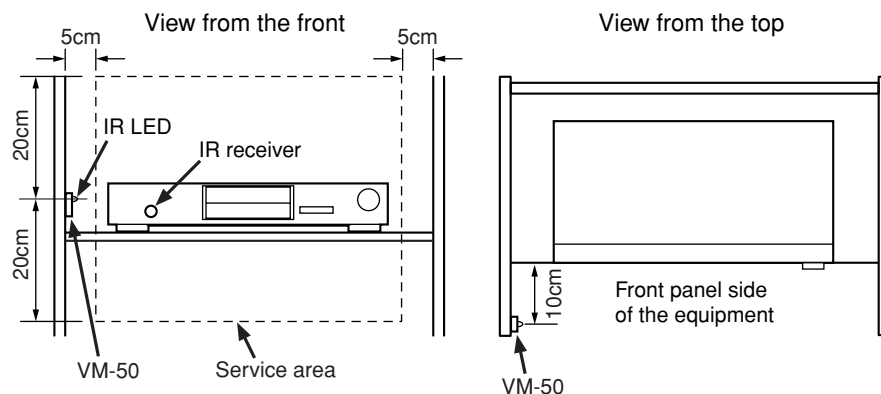

Install the VM-50 inside a rack. Recess the IR receiver behind the IR LED by more than 10 cm. Install the IR receiver in the location that is within the range of 20 cm higher and 20 cm lower than the IR LED (as shown by the dotted line of the illustration). The IR receiver of the equipment should be located more than 5 cm far from the IR LED in the right and left.

Note

If any screening object is placed in between the IR LED and the IR receiver, the infrared ray is blocked to disable control of the external equipment.

- Operate the SRP-X700P Manager or the User Control Panel to confirm that it can control the Sony equipment. If they cannot control the equipment, change position of the supplied IR transmitter VM-50 until they can control the equipment.

Connecting the Speaker

Speaker connection method changes depending on the operating mode.

When the "70 V LINE" mode is selected, the output signal becomes monaural. Connect the (+) terminal of a speaker to the (+) terminal (red) of SPEAKERS CH-1 and the (-) terminal of a speaker to the (+) terminal (red) of SPEAKERS CH-2.

- Connecting speakers with low impedance [Lo imp.]

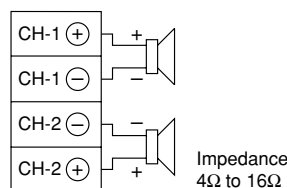

- Connecting speakers with high impedance [70 V LINE]

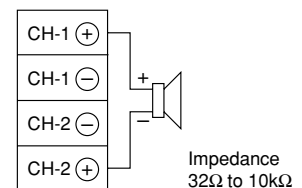

The table below shows the number of speakers that can be connected in the high impedance [70 V LINE] mode.

Impedance	Power applied to each speaker	Number of speakers you can connect
1 kΩ	5 W	30
3.3 kΩ	1.5 W	100
10 kΩ	0.5 W	300

* The notation in [] is displayed in the SRP-X700P Manager.

System Configuration

System example when operating the SRP-X700P with the default setting when shipped from the factory

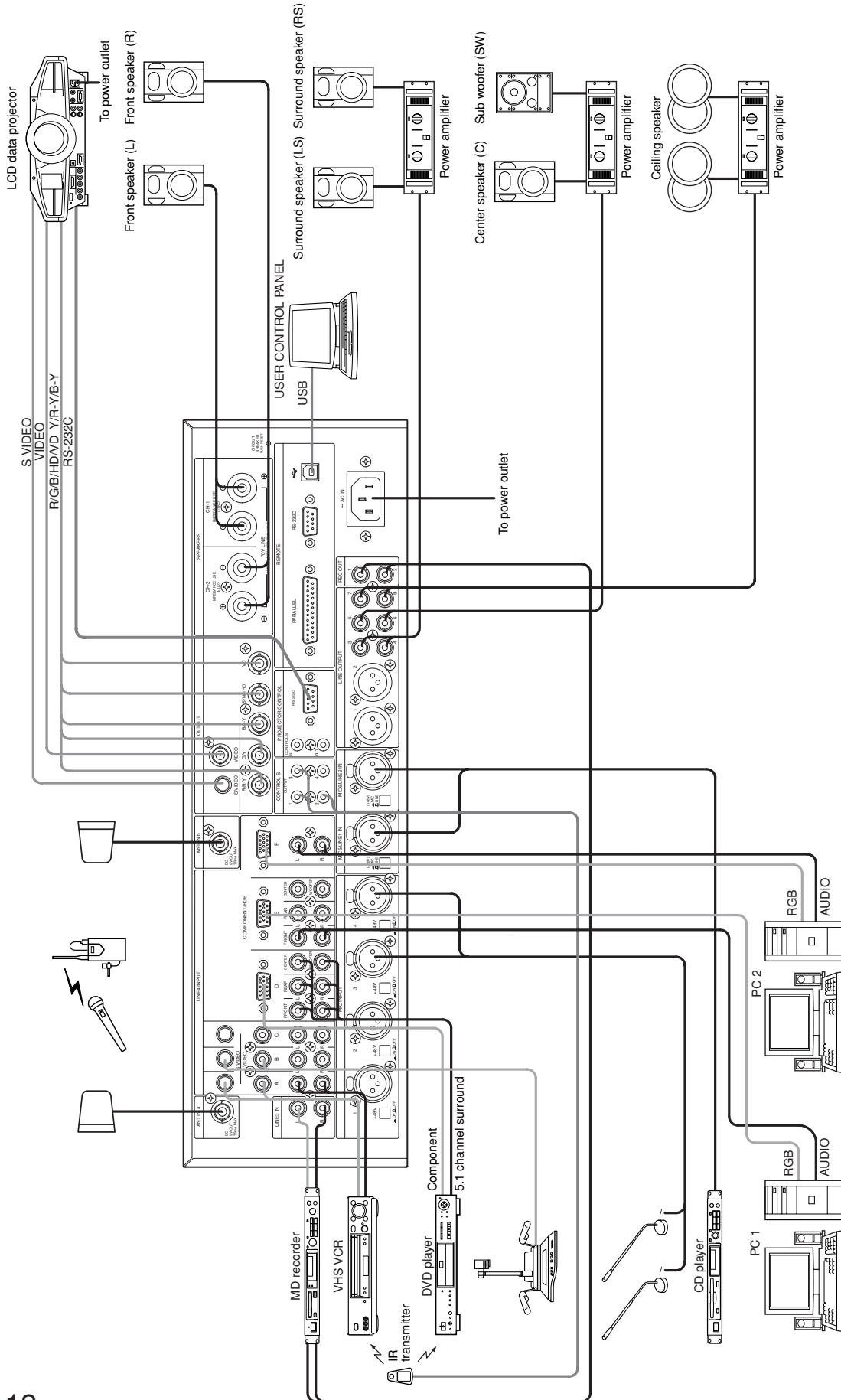

- You can realize the above system configuration with the default setting of the SRP-X700P. You can use the system without changing any setups from the supplied software SRP-X700P Manager.
- You can control the VHS, DV and DVD, can select channel of the LINE4 INPUT terminal, and can control the sound volume of microphone and AV equipment from the supplied software User Control Panel. (CD and MD cannot be controlled.)
- VHS, DV and DVD cannot be controlled from the front panel of the SRP-X700P.
- The system configuration shown above uses the two unit of the UHF synthesizer tuner unit WRU-806B (option).
- If you want to use an electret condenser microphone for MIC3 and MIC4, set the +48 V button of the corresponding channel to ON.
- Connect the VPL-FX51 as a projector through RS-232C.
- Install the IR transmitter VM-50 in the SRP-X700P or in the location inside a rack that allows its receptor block to receive the remote control signal. For the installation of the VM-50, see "How to Control AV Equipment from the SRP-X700P" on page 11.
- If you use VHS and DV that can select their remote control mode, set the remote control mode of VHS to "VTR3" and set the remote control mode of DV to "VTR4".

System example when external operation panel and environment equipment are connected

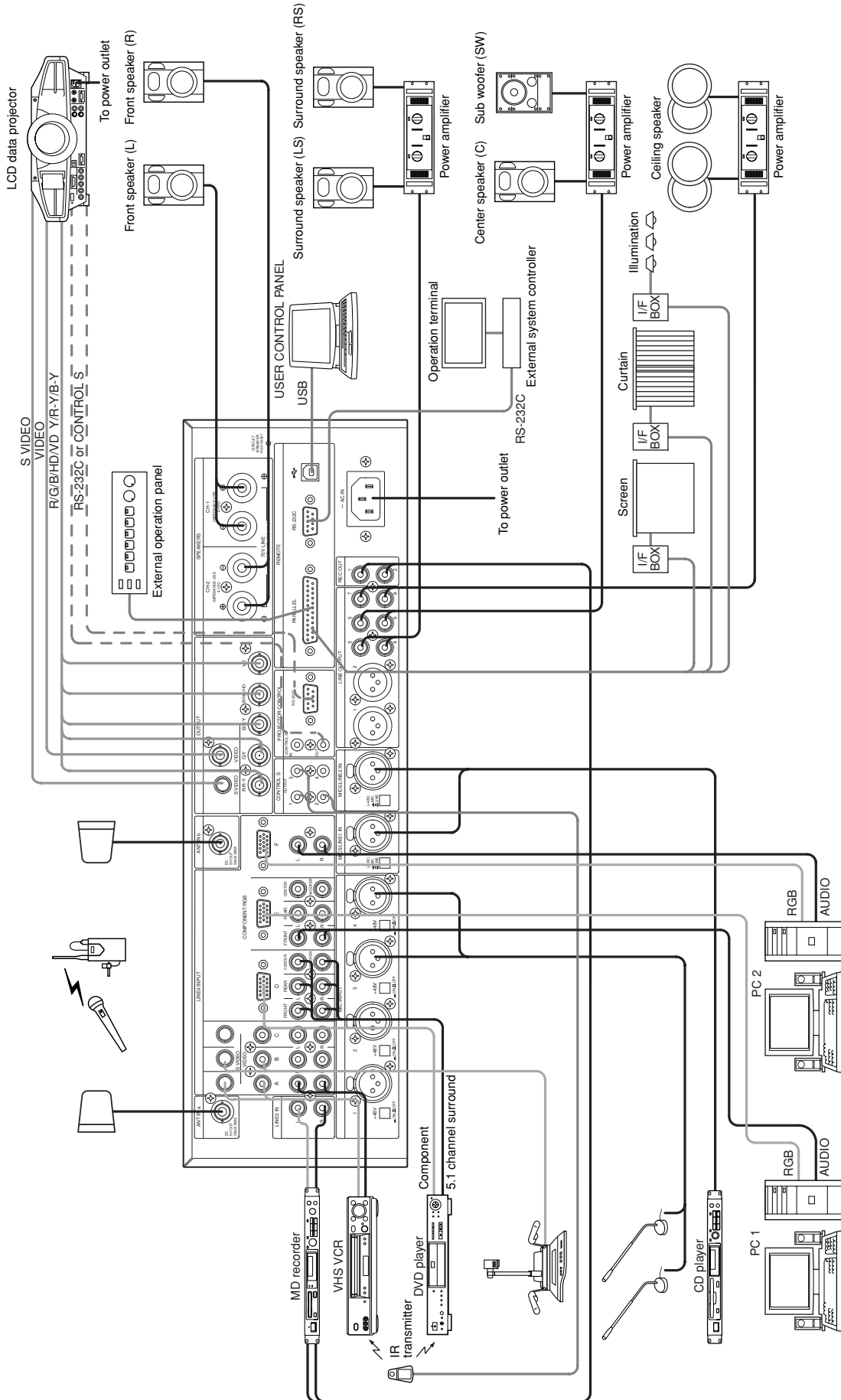

- You can control the SRP-X700P from a remote location by one of the three methods (either from the User Control Panel or from the external operation panel or from external system controller.)
- You can control the SRP-X700P and the equipment connected to the SRP-X700P by sending command from external system controller to the SRP-X700P. (The system controller software is separately necessary.)
- If you use a projector that is controlled through the CONTROL S terminal, the RGB signal equipment and the component signal equipment cannot be mixed in the system connection. The component signal output equipment such as DVD should use the 4A to 4C LINE 4 INPUT terminals connecting the video or S video signal.
- The system configuration shown above uses the two unit of the UHF synthesizer tuner unit WRU-806B (option).
- If you want to use an electret condenser microphone for MIC3 and MIC4, set the +48 V button of the corresponding channel to ON.
- Install the IR transmitter VM-50 in the SRP-X700P or in the location inside a rack that allows its receptor block to receive the remote control signal. For the installation of the VM-50, see "How to Control AV Equipment from the SRP-X700P" on page 11.
- If you want to control the environment equipment such as screen, curtain and illuminations from the REMOTE PARALLEL output terminal, use the optional interface box (I/F box).
- For the external operation panel and interface box (I/F Box), see "System example when operating the SRP-X700P from the REMOTE PARALLEL terminal" on page 14.

System Configuration

System example when operating the SRP-X700P from the REMOTE PARALLEL terminal

The REMOTE PARALLEL terminal of the SRP-X700P is shipped from the factory with the default setting on the premise of the external operation panel as described below.

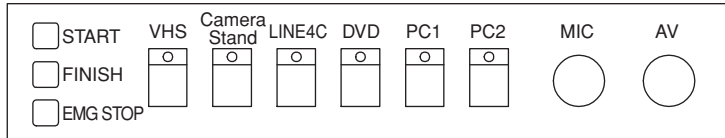

START button (SCENE No. 1 recall): Sets OUTPUT7 and OUTPUT9 to ON to lower the screen, to close the curtain, to darken the illumination and to start presentation.
FINISH button (SCENE No. 2 recall): Sets OUTPUT8 and OUTPUT10 to ON to raise the screen, to open the curtain, to turn on the illumination and to end the presentation.
EMG STOP button (SCENE No. 3 recall): Sets OUTPUT7 through OUTPUT10 to OFF to stop moving the screen and the curtain, and to turn on the illumination.
Selector block: Switches the LINE4 INPUT terminals A through F.
MIC volume control: Controls the microphone sound volume.
AV volume control: Controls sound volume of the AV equipment.

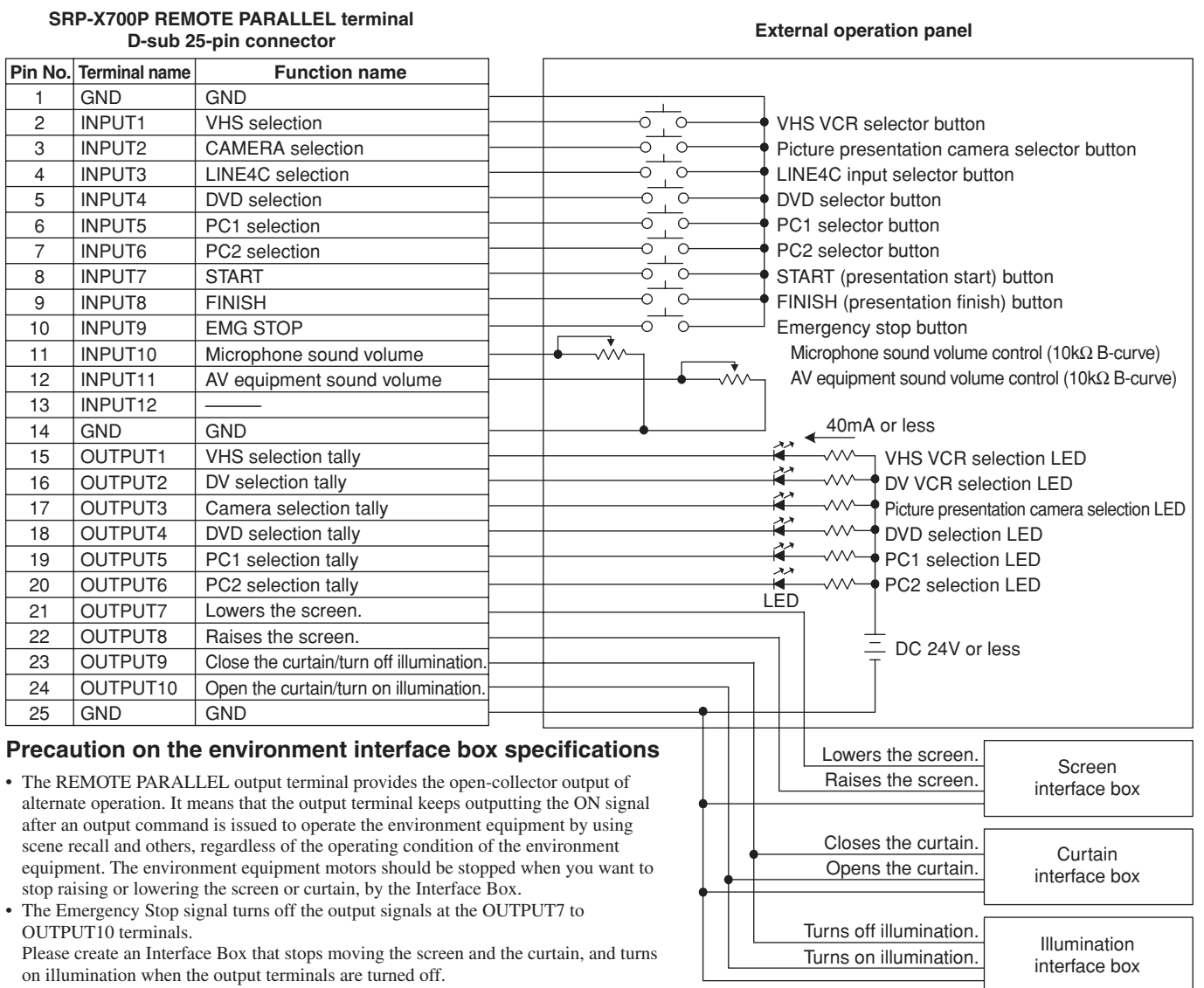

Precaution on the environment interface box specifications

- The REMOTE PARALLEL output terminal provides the open-collector output of alternate operation. It means that the output terminal keeps outputting the ON signal after an output command is issued to operate the environment equipment by using scene recall and others, regardless of the operating condition of the environment equipment. The environment equipment motors should be stopped when you want to stop raising or lowering the screen or curtain, by the Interface Box.
- The Emergency Stop signal turns off the output signals at the OUTPUT7 to OUTPUT10 terminals. Please create an Interface Box that stops moving the screen and the curtain, and turns on illumination when the output terminals are turned off.

Example of controlling the environment equipment by scene recall operation

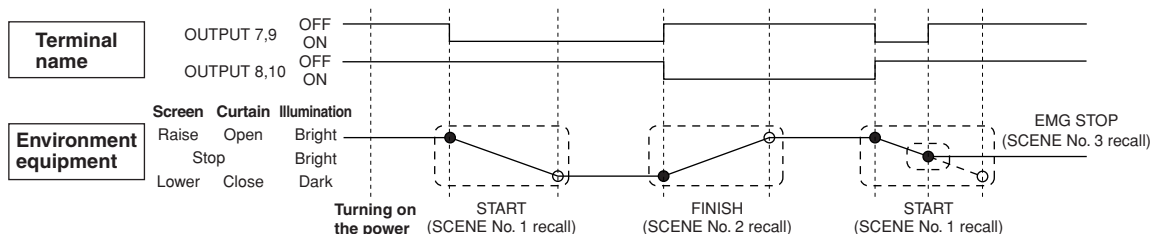

Default settings

INPUT

Item		Initial setting		
TRIM	MIC1 - MIC4	-50 dBu		
	MIC5/LINE1, MIC6/LINE2	+4 dBu		
	LINE3, LINE4A - 4F	0 dBu		
LCF	MIC1 - MIC4	ON		
	MIC5/LINE1, MIC6/LINE2	OFF		
PEQ		OFF		
FR		OFF		
COMP		SOFT		
MUTING		OFF		
GAIN LIMIT		+10 dB		
INPUT FADER		0 dB		
MIC1 - MIC4 MIC5/LINE1, MIC6/LINE2 PEQ	FREQ	Band 1	63 Hz	
		Band 2	2.5 kHz	
		Band 3	20 kHz	
	Q	Band 1	1.0	
		Band 2	1.5	
		Band 3	0.47	
	GAIN	Band 1 - 3	0 dB	
	LINE3, LINE4 PEQ	FREQ	Band 1	63 Hz
			Band 2	20 kHz
Q		Band 1	1.0	
		Band 2	0.47	
GAIN		Band 1,2	0dB	

AUTOMATIC MIXER SETUP

Item		Initial setting		
AUTOMATIC MIXER	ON/OFF	ON		
	DEFAULT/EDIT	DEFAULT		
	INPUT	COMPRESSOR	THRESHOLD	-3 dB
			RATIO	3 : 1
			ATTACK	22 ms
		GATE	RELEASE	100 ms
			THRESHOLD	-30 dB
			HOLD	1000 ms
		RELEASE	470 ms	
		NOM	OFF	
		ONLY ONE	OFF	
	LAST ON	OFF		
	SELECT	MIC1-MIC6/LINE2	ON	
	OUTPUT	LIMITER	THRESHOLD	+10 dB
			ATTACK	0.47 ms
RELEASE			100 ms	
SELECT		OUTPUT1-REC OUT2	ON	

ROUTING

Routing		Mix level		
MIC1/WL1	LINE OUT1, LINE OUT2	-20 dB		
	LINE OUT7, LINE OUT8, REC OUT1, REC OUT2	0dB		
MIC2/WL2	LINE OUT1, LINE OUT2	-20 dB		
	LINE OUT7, LINE OUT8, REC OUT1, REC OUT2	0 dB		
MIC3	LINE OUT1, LINE OUT2	-20 dB		
	LINE OUT7, LINE OUT8, REC OUT1, REC OUT2	0 dB		
MIC4	LINE OUT1, LINE OUT2	-20 dB		
	LINE OUT7, LINE OUT8, REC OUT1, REC OUT2	0 dB		
MIC5/LINE1	LINE OUT1, REC OUT1	0 dB		
MIC6/LINE2	LINE OUT2, REC OUT2	0 dB		
LINE3	L	LINE OUT1	0 dB	
	R	LINE OUT2	0 dB	
LINE4	A·B·C·F	L	LINE OUT1, REC OUT1	0 dB
		R	LINE OUT2, REC OUT2	0 dB
	D·E	L	LINE OUT1, REC OUT1	0 dB
		C	LINE OUT5	0 dB
		R	LINE OUT2, REC OUT2	0 dB
		SW	LINE OUT6	0 dB
		LS	LINE OUT3	0 dB
		RS	LINE OUT4	0 dB
ROUTING		ATT LEVEL		
SP OUT	CH1	LINE OUT1	-10 dB	
	CH2	LINE OUT2	-10 dB	

Default settings

OUTPUT

Item		Initial setting	
REF LEVEL	OUTPUT1, OUTPUT2	+4 dBu	
	OUTPUT3 - OUTPUT8	-5 dBu	
	REC OUT1, REC OUT2	-5 dBu	
HCF		OFF	
EQ		OFF	
DELAY		0 ms	
MUTING		OFF	
GAIN LIMIT		+10 dB	
OUTPUT FADER		0 dB	
OUTPUT1, OUTPUT2 EQ	FREQ	Band 1	25 Hz
		Band 2	40 Hz
		Band 3	80 Hz
		Band 4	160 Hz
		Band 5	315 Hz
		Band 6	630 Hz
		Band 7	1.25 kHz
		Band 8	2.5 kHz
		Band 9	5 kHz
		Band 10	10 kHz
		Band 11	20 kHz
	Q	Band 1 - 11	1.5
	GAIN	Band 1 - 11	0 dB
HCF		OFF	
OUTPUT3 - OUTPUT8 EQ	FREQ	Band 1	63 Hz
		Band 2	250 Hz
		Band 3	2.5 kHz
		Band 4	20 kHz
	Q	Band 1	1.0
		Band 2, 3	1.5
		Band 4	0.47
	GAIN	Band 1 - 4	0 dB
HCF		OFF	
SPEAKER OUTPUT	MODE		Lo Imp.
	SELECT	CH1	OUTPUT 1
		CH2	OUTPUT 2
	ATT	CH1	15 dB
		CH2	15 dB

REMOTE

Item		Initial setting	
PARALLEL I/O	INPUT	INPUT1	AV SEL A
		INPUT2	AV SEL B
		INPUT3	AV SEL C
		INPUT4	AV SEL D
		INPUT5	AV SEL E
		INPUT6	AV SEL F
		INPUT7	RECALL 1
		INPUT8	RECALL 2
		INPUT9	RECALL 3
		INPUT10	LVL Master A
		INPUT11	LVL Master B
		INPUT12	NONE
PARALLEL I/O	OUTPUT	OUTPUT1	AV SEL A
		OUTPUT2	AV SEL B
		OUTPUT3	AV SEL C
		OUTPUT4	AV SEL D
		OUTPUT5	AV SEL E
		OUTPUT6	AV SEL F
		OUTPUT7	RECALL 1
		OUTPUT8	RECALL 2
		OUTPUT9	RECALL 1
		OUTPUT10	RECALL 2
MACHINE CONTROL	LINE3	MACHINE TYPE	MD
		CTRL S OUTPUT CH	1
	LINE4A	MACHINE TYPE	VTR3 (VHS)
		CTRL S OUTPUT CH	2
	LINE4B	MACHINE TYPE	NONE
		CTRL S OUTPUT CH	1
	LINE4C	MACHINE TYPE	NONE
		CTRL S OUTPUT CH	1
	LINE4D	MACHINE TYPE	DVD
		CTRL S OUTPUT CH	2
	LINE4E, LINE4F	MACHINE TYPE	NONE
		CTRL S OUTPUT CH	1
CONNECTION TYPE	CH1	WIRED	
	CH2	IR	
	CH3	WIRED	
	CH4	WIRED	
PROJECTOR CONTROL	I/F TYPE		RS-232C
	PROJECTOR PROTOCOL		VPL-FX51/50
	REMOTE POWER ENABLE		ON
	INPUT VIDEO TYPE	LINE4A - LINE4C	VIDEO
		LINE4D	COMPONENT
		LINE4E, LINE4F	RGB

GROUP FADER

Item	Initial setting
MASTER A	MIC1/WL1, MIC2/WL2, MIC3, MIC4
MASTER B	MIC5/LINE1, MIC6/LINE2, LINE3, LINE4
REMOTE1 - REMOTE6	Not assigned

Block Diagram

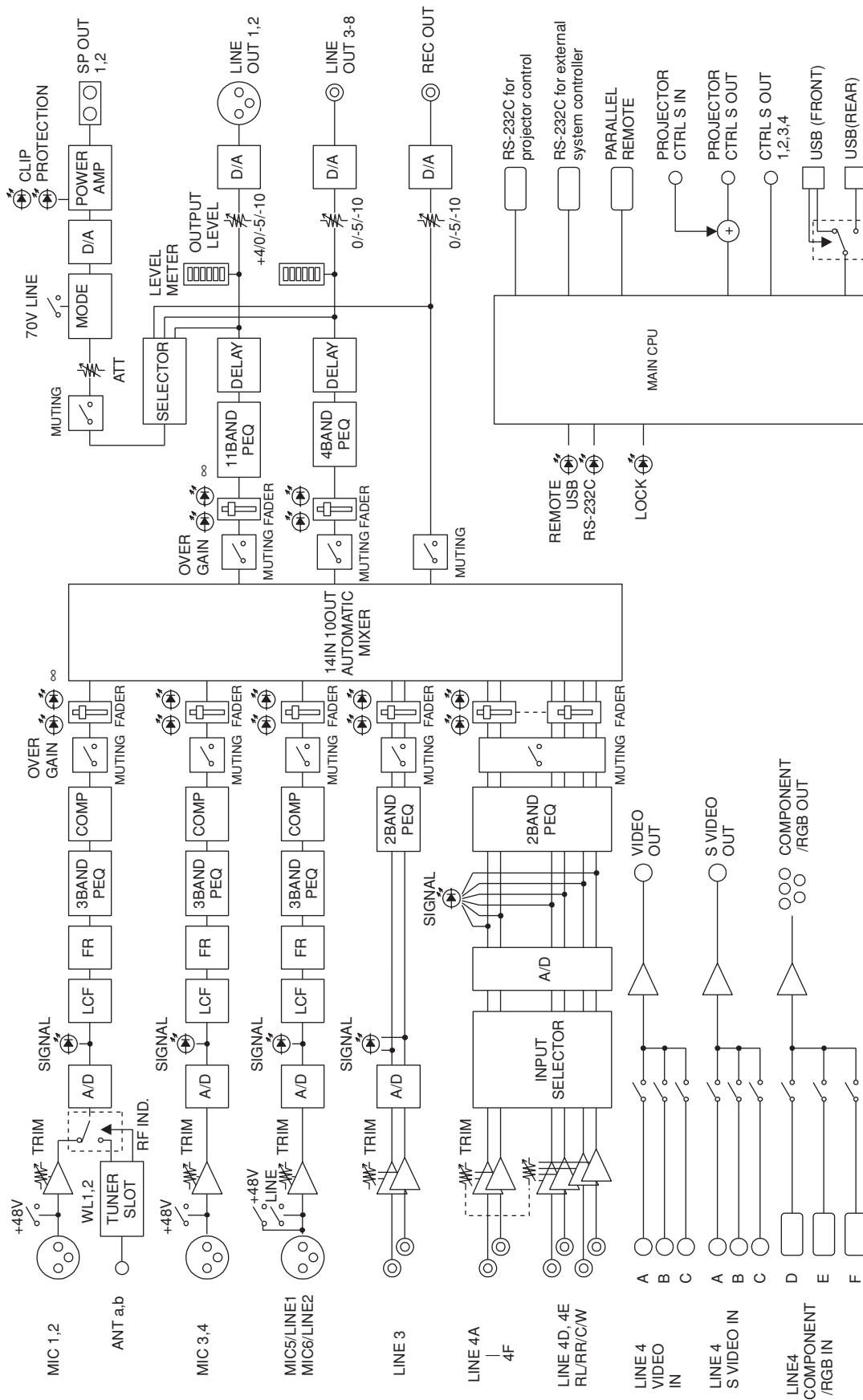

Specifications

AUDIO INPUT/OUTPUT

Input	Terminal shape	Circuit	Channel	Reference input level	Maximum input level	Impedance
MIC 1/WL 1, MIC 2/WL 2, MIC 3, MIC 4	XLR 3-31type*	Balanced	Monaural	-60 to -45 dBu	-37 to -22 dBu	2.2 kΩ or more
MIC 5/LINE 1 MIC 6/LINE 2	XLR 3-31type*	Balanced	Monaural	-60 to -45 dBu -10 to +4 dBu	-37 to -22 dBu +10 to +24 dBu	2.2 kΩ or more (in MIC mode) 10 kΩ (in LINE mode)
LINE 3	Pin	Unbalanced	Stereo	-10 to 0 dBu	+10 dBu	10 kΩ or more
LINE 4 (A B C F)	Pin	Unbalanced	Stereo	-10 to 0 dBu	+10 dBu	10 kΩ or more
LINE 4 (D E)	Pin	Unbalanced	Stereo/ 5.1 surround	-10 to 0 dBu	+10 dBu	10 kΩ or more
Output	Terminal shape	Circuit	Channel	Reference output level	Maximum output level	Load impedance
LINE OUT 1-2	XLR 3-32type*	Balanced	Monaural	-10/-5/0/+4 dBu	+24 dBu	600 Ω or more
LINE OUT 3-8	Pin	Unbalanced	Monaural	-10/-5/0 dBu	+15 dBu	10 kΩ or more
REC OUT 1-2	Pin	Unbalanced	Monaural	-10/-5/0 dBu	+15 dBu	10 kΩ or more

* Pin-1: GND Pin-2: HOT Pin-3: COLD

SPEAKERS OUTPUT

Output	Terminal shape	Impedance	Maximum output
CH 1	Screw-type terminal	4 Ω to 16 Ω	150 W + 150 W (8 Ω 1 kHz, T.H.D 10%)
CH 2		4 Ω to 16 Ω	200 W + 200 W (4 Ω 1 kHz, T.H.D 10%)
70 V LINE		32 Ω to 10 kΩ	150 W (32 Ω 1 kHz, T.H.D 10%)

When ATT is set to 0 dB, 150 W + 150 W (across 8 Ω) power is output at the 0 VU setting of the output signal level.

VIDEO/RGB INPUT/OUTPUT

Input	Terminal shape	Signal format	Level	Impedance
LINE 4 (A B C)	Pin	Composite	1 Vp-p (75Ω)	75 Ω
	MINI Din	Y/C	1 Vp-p (Y)/0.286 Vp-p (C)	75 Ω
LINE 4 (D E F)	HD D-sub 15-pin	Component/RGB	0.7 Vp-p (video signal) 1 to 5 V (sync signal)	75 Ω (video signal) 47 kΩ (sync signal input)
Output	Terminal shape	Signal format	Level	Impedance
R/R-Y, G/Y, B/B-Y, SYNC/HD, VD	BNC	Component/RGB	0.7 Vp-p (video signal) 1 to 5 V (sync signal)	75 Ω (video signal) 47 kΩ (sync signal input)
S VIDEO	MINI Din	Y/C	1 Vp-p (Y)/0.286 Vp-p (C)	75 Ω
VIDEO	BNC	Composite	1 Vp-p	75 Ω

AUDIO

Frequency response 20 Hz to 20 kHz ± 0.5 dB
(with LINE OUT, 1 kHz reference)
T.H.D 0.01 % or less (LINE OUT, 1 kHz)
S/N ratio 94 dB or more (LINE 3, LINE 4, IHF-A)
Crosstalk -85 dB or less (between LINE channels,
1 kHz with input cutoff)
Equivalent input noise level
-124 dBu or less (-60 dBu, with input
terminated in 150 Ω, IHF-A)
0 dBu = 0.775 V

VIDEO/S VIDEO

Frequency response 50 Hz to 10 MHz

COMPONENT/RGB

Frequency response 50 Hz to 150 MHz
480 p, 1080 i,
1280 × 1024 60 Hz (SXGA) supported

REMOTE

PROJECTOR CONTROL

RS-232C D-sub 9-pin (male)
CONTROL S IN/OUT Mini jack

REMOTE

PARALLEL I/O D-sub 25-pin (female)
IN Make contact input
Logic: C-MOS LEVEL active L
Input pulse width: 100 msec or more
OUT Open collector output
Withstand voltage: +24 V or less
Maximum sink current: 40 mA
D-sub 9-pin (male)
TYPE-B

OTHERS

ANT IN terminal
+48 V power supply

BNC DC +9 V is supplied.
Supplied to MIC 1 to MIC 6 XLR
terminals. (For MIC 1 to MIC 4,
supplied when the +48 V button is
ON.)
(For MIC 5 and MIC 6, supplied at
MIC level setting only.)

General

Power requirement	AC 120 V, 50/60 Hz
Power consumption	150 W
Dimensions	482 × 132 × 350 mm (w/h/d) (19 × 5 1/4 × 13 7/8 inches) (excluding protrusions)
Mass	Approx. 13 kg (28 lb 11 oz)
Operating temperature	0°C to 40°C
Storage temperature	-20°C to 60°C
Supplied accessories	Power cord (1), Foot (4), CD-ROM (1), IR transmitter VM-50 (1), Operating instructions (1)
Optional accessories	UHF antenna AN-820A, UHF synthesizer tuner unit WRU-806B

To prevent electromagnetic wave interference due to portable communication devices:

If communication devices such as cellular phones are used near this unit, incorrect operation may be caused or the image, sound, etc. may be affected. Turn off the power of all portable communication devices near this unit if possible.

Design and specifications are subject to change without notice.

Dimensions

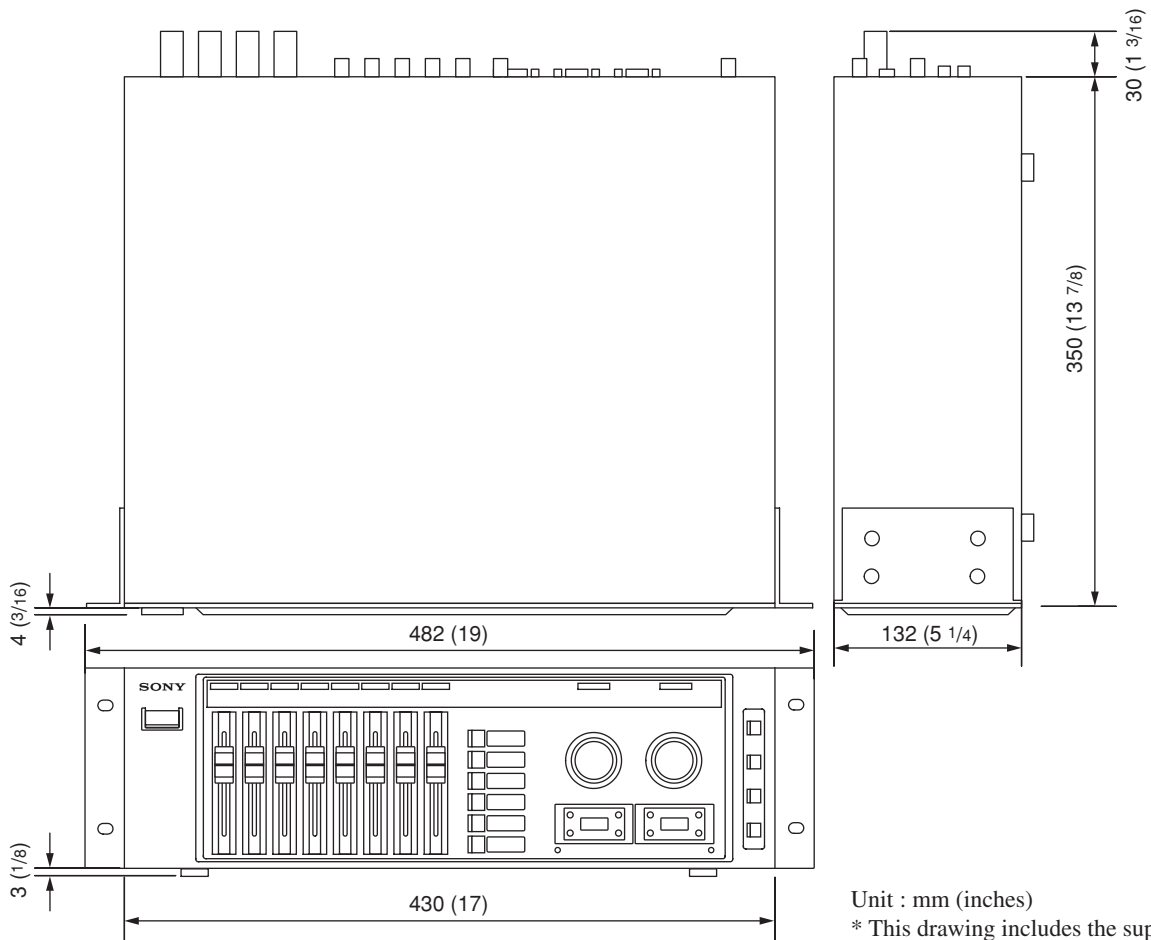

Troubleshooting

Before contacting us, please check the following again. If the trouble persists, please contact your local Sony Sales office or Dealer.

Start the supplied software SRP-X700P Manager and check the settings of the SRP-X700P. Check the following if the problem still cannot be solved.

Symptom	Cause/Remedy
Power is not turned on.	<ul style="list-style-type: none">• Power cord is disconnected. → Firmly insert the power cord fully into the AC IN terminal and wall outlet.
No sound is output.	<ul style="list-style-type: none">• Input fader is decreased. → Increase the input fader.• Master volume is decreased. → Increase the master volume.• ROUTING setup is incorrect. → Set the ROUTING correctly using the SRP-X700P Manager.
No microphone sound is output.	<ul style="list-style-type: none">• MIC/LINE selector button is set to LINE. → Set the MIC/LINE selector button to MIC.
Sound is distorted.	<ul style="list-style-type: none">• The LINE equipment is connected to MIC5/LINE 1 IN and MIC6/LINE 2 IN terminals while the MIC/LINE selector button is set to the MIC position. → Set the MIC/LINE selector button to LINE.
No video comes out.	<ul style="list-style-type: none">• Video input signal setup is incorrect. → Set the video input signal correctly again.
The SRP-X700P cannot be controlled by RS-232C.	<ul style="list-style-type: none">• The cable routing method does not satisfy the specifications of this unit.• The RS-232C parameter settings do not satisfy the specifications of this unit. → Connect cables following the instructions for "REMOTE RS-232C Terminal" described on page 9.
PROTECTION indicator remains lit.	<ul style="list-style-type: none">• When DC voltage appears in the SPEAKER terminal due to failure. → Set the POWER button switch to OFF.• If the heat sink temperature inside the amplifier exceeds the specified value. The connected speaker impedance is too low. → Set the POWER button to OFF and connect the SRP-X700P to a speaker having the correct impedance. Air intake and exhaust holes (on the right and left sides of the SRP-X700P) are choked by dust. → Clean the air intake and exhaust holes by removing dust with a vacuum cleaner.• Speaker terminal is short-circuited. → Set the POWER button switch to OFF and remove the cause of the short-circuit.