

# SONY

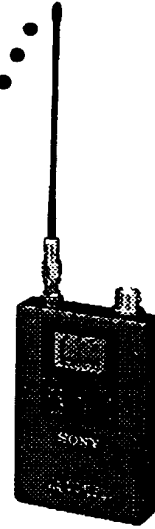

## Guide to Sony 800MHz Wireless Microphones

*Systems Configurations For Professional Camcorders*

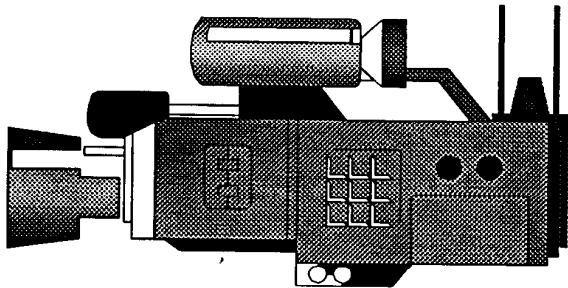

by Sony Professional Audio  
and Video Acquisition Group

# SONY

## - Broadcast Camera Wireless System Packages -

A comprehensive guide for setting up the right Sony wireless system with the right camcorder

### Configuration # 1: WRR-855A UHF Diversity Tuner

Works with: All Betacam SX camcorders  
(drop-in configuration)

**Models:**

- DNW-7
- DNW-9WS
- DNW-90
- DNW-90WS
- DNV-5 (dockable VTR)

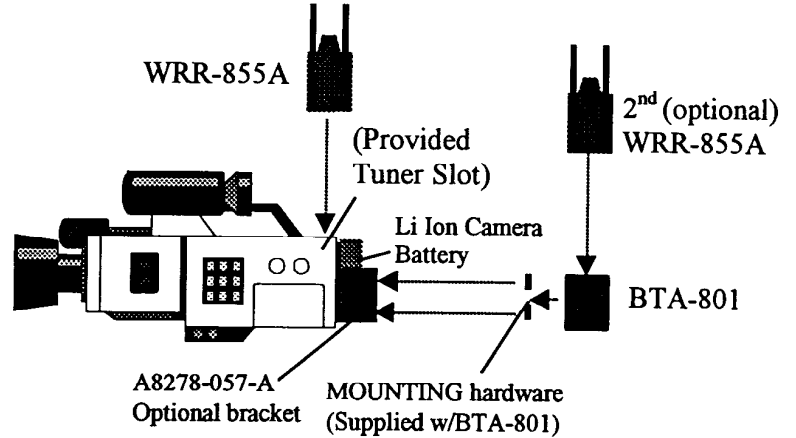

**Typical Package**

Required Component	Qty
WRR-855A (tuner)	1
Transmitter *(see transmitter options)	1
<b>Option ( for 2<sup>nd</sup> tuner)</b>	
A8278-057-A bracket <sup>1</sup>	1
WRR-855A	1
BTA-801 (ADAPTER BOX)	1
Transmitter	1

### Configuration #2: WRR-855A UHF Diversity Tuner

Works with: Camcorders equipped with a NP-1 box, BP-90 box  
BKW-L601 bracket -or- Anton Bauer battery bracket

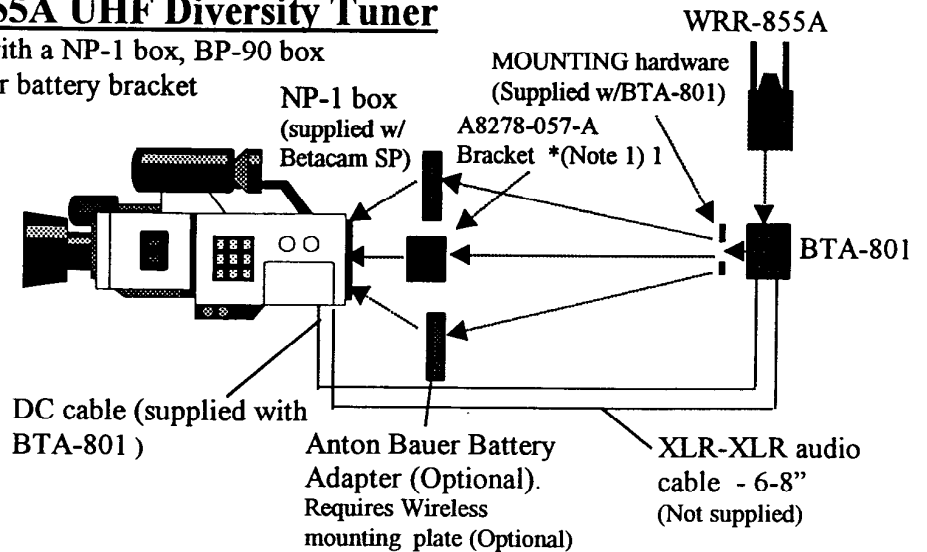

<sup>1</sup> The A8278-057-A bracket is supplied with all Digital Betacam and HDW-700A camcorders, as well as with the Optional BKW-L601

### **WRR-855A UHF Diversity Portable Tuner**

- Diversity UHF synthesized tuner (94 channels)
- LCD display of status (AF, RF, CH, GROP, battery)
- Fits directly into Betacam SX camcorders
  - Returns audio back to camcorder
  - Transmits display information to SX model viewfinder
- Fits most Sony broadcast camcorders with BTA-801 or CA-WR855 adapter
- Receives power from camera:
  - SX models directly via multi-pin connector
  - DVCAM Via CA-WRR855
  - All other models via BTA-801 adapter box
- Now available for channels 64, 66 & 68

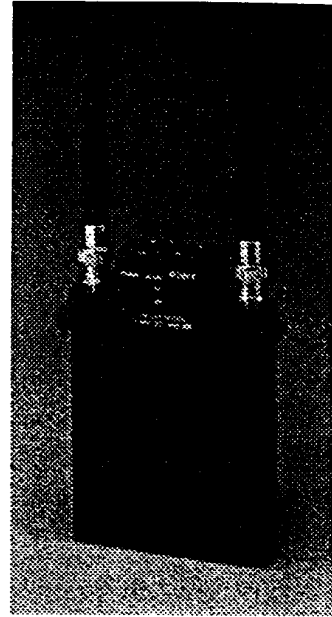

### **WRR-810A UHF Non-Diversity Portable Tuner**

- UHF synthesized tuner (94 channels)
- LCD display of status (AF, RF, CH, GROP, battery)
- Fits most Sony broadcast camcorders with:
  - NP-1
  - BBKW-L601
  - DSBK-201
  - BKW-L403, or
  - Anton Bauer QRD-700
- Receives power from camera via 4-pin DC accessory output
- Balanced XLR audio out plugs into camcorder mic input
- Available for channels 64, 66 & 68

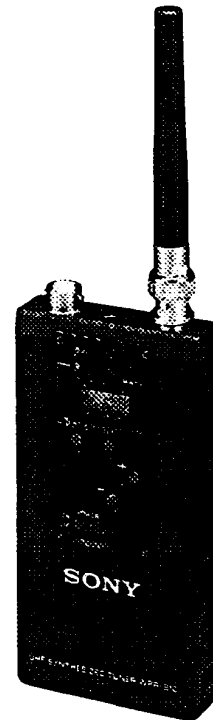

### **WRR-805A UHF Non-Diversity Portable Tuner**

- Light-weight and low-cost
- UHF synthesized tuner (94 channels)
- LCD display of status (AF, RF, CH, GROP, battery)
- Fits most Sony consumer / prosumer camcorders via easy Velcro® strap-mount (mounts to camcorder handle).
- 4 hours of continuous power (2-"AA" alkaline batteries).
- Audio output via balanced 1/8" mini-jack or via optional XLR adapter cable.
- Variable headphone monitor output
- Balanced XLR audio out plugs into camcorder mic input
- Available for channels 64, 66 & 68 (64, 66-Summer '99)

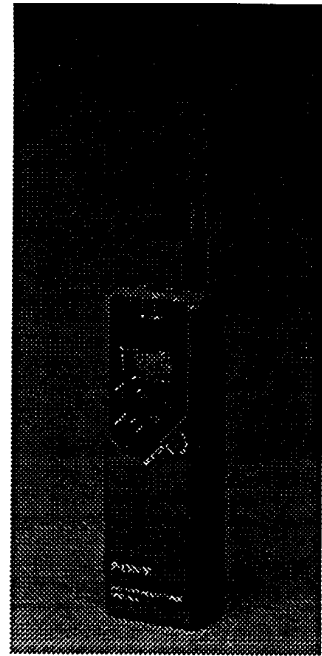

## Transmitter Options:

### Body-Packs UHF Transmitters:

#### WRT-805A (CH)

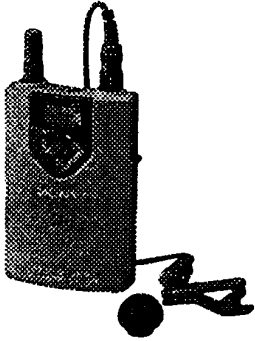

- Low-cost
- Light weight
- 10mW output
- 6 hrs w/ 1 "AA" batteries
- Channels: 68 (64, 66 Summer-'99)

- Accepts:
  - ECM-122BMP- Omni lavalier. Low-cost general purpose
  - ECM-121BMP- Same as above with short cord.
  - ECM-44BMP- Omni lav. General purpose
  - ECM-166BMP- Uni lavalier. Instrumental/vocal use
  - ECM-77BMP- Omni lavalier. High-quality vocal/instrumental
  - ECM-310BMP- Headset. Vocal/announcer

#### WRT-820A (CH)



- Heavy duty & light weight
- 10mW RF output
- 8 hrs w/2 "AA" batteries
- Channels 64, 66 & 68

- Accepts:
  - ECM-44BC Omni lav. General purpose
  - ECM-55BC Omni lav. General Purpose
  - ECM-66BC Uni lav. Instrumental/vocal use
  - ECM-166BC Uni lav. Instrumental/vocal use
  - ECM-77BC Omni lav. High-quality vocal/instrumental
  - ECM-310BC Headset. Vocal/announcer
  - ECM-350BC Headset. Vocal/announcer
  - EC-1.5CF 1.5m Microphone adapter cable

### WRT-860A (CH)

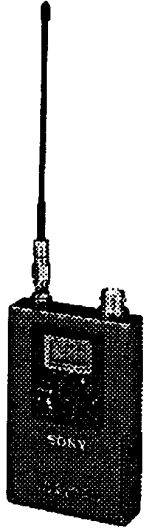

- Ultra-compact/light-weight
- 20mW RF output
- 6 hrs w/2 "AA" batteries
- Channels 64, 66, 68

- Accepts:
  - ECM-44BC Omni lav. General purpose
  - ECM-55BC Omni lav. General Purpose
  - ECM-66BC Uni lav. Instrumental/vocal use
  - ECM-166BC Uni lav. Instrumental/vocal use
  - ECM-77BC Omni lav. High-quality vocal/instrumental
  - ECM-310BC Headset. Vocal/announcer
  - ECM-350BC Headset. Vocal/announcer
  - EC-1.5CF 1.5m Microphone adapter cable

### Hand-held UHF Transmitters:

#### WRT-800A (CH)

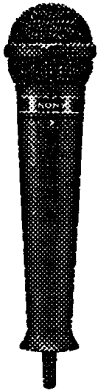

- Electret condenser element
- Low-cost UHF transmitter
- General purpose vocal
- 5mW RF output
- 12 hrs w/1 "AA" battery
- Channel 68

### WRT-810A (CH)

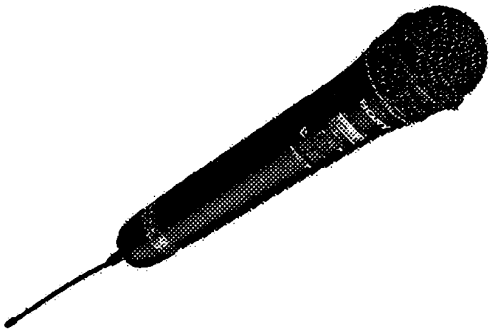

- Dynamic cardioid element
- General purpose vocal
- 2.5mW/10mW switchable RF output
- 8 hrs w/2 "AA" battery
- Available on 64, 66, 68

### WRT-830A (CH)

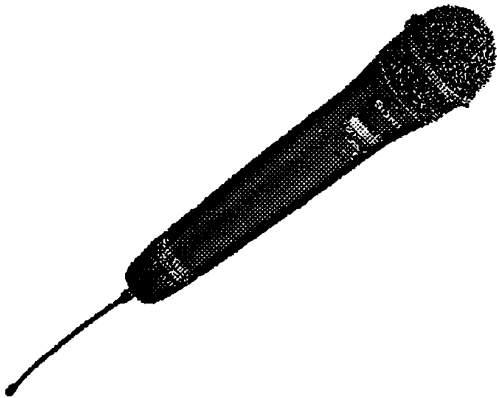

- High-quality electret-condenser element
- Vocal applications
- 2.5mW/10mW switchable RF output
- 8 hrs w/2 "AA" battery
- Channel 68

### WRT-867A(CH)/X



- High-quality dynamic hyper-cardioid element (same as F-780/X)
- For critical vocal applications
- 10mW RF output
- 4 hrs w/1 “AA” battery
- Available on Channel 64, 66, 68

### WRT-808A (CH)

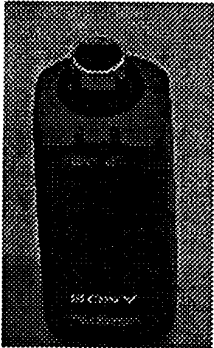

- Plug-on UHF transmitter for ENG applications
- Converts almost any mic\* to wireless operation
- Mic or line level (variable)
- 10mW/50mW RF output (switchable)
- 4 hrs continuous operation w/2 “AA” batteries
- Available on Channel 64, 66, 68 (late spring '99 availability on 64 & 66)

**\*Works with:**  
Any low-impedance  
XLR-balanced, non-  
phantom powered  
microphone or  
balanced, line-level  
source

**\*A Note about Frequency Selection** – Sony’s wireless systems operate across 6 TV channels (64-69). Each system operates across a single pair of these channels: 64 operates on 64 & 65; 66 operates on 66 & 67; and 68 operates on 68 & 69. Each of these systems is tunable to any of 47 frequencies on each TV channel. After each model number is the designation (CH). This refers to 64, 66 or 68 versions of this model. Make sure to match the order frequency number (64, 66 or 68) on *both* the transmitter and receiver, as these each have a channel designation (e.g.- WRT820A66 with WRR-855A66). Choice of order frequency is arbitrary, unless otherwise specified by a particular requirement. If you have any questions regarding order frequency selection, please consult your Regional Audio Manager.



**Camcorder / Wireless Microphone Configuration Chart**

CAMERA MODEL #	SUPPLIED MOUNTING HARDWARE	OPTIONAL MOUNTING HARDWARE	DC CONNECTOR OUTPUT TYPE	AUDIO INPUT CONNECTOR TYPE	COMPATIBLE UHF TUNER	SUPPLIED HARDWARE	OPTIONAL HARDWARE	PACKAGE #1 Hand-held	PACKAGE #2 Body-pack/lavalier	PACKAGE #3 Plug-on transmitter
<b>HDCAM</b>										
HDW-500	V-wedge for Li-Ion batteries (Includes A8278-057-A bracket)	QRD-700 Anton Bauer bracket	4-PIN 12V DC	XLR (X2)	WRR-855A (64, 66, 68) -or- WRR-810A (64, 66, 68)	1/4 WAVE ANTENNAS (x2)	BTA-801 (Include plate adapter) (REQUIRED)	WRR-855A68 (tuner)	WRR-855A68 (tuner)	WRR-855A68 (tuner)
HDW-700A								WRT-830A (transmitter)	WRT-860A68 w/ECM-77BC lavalier microphone	WRT-808A68 (plus any dynamic hand-held mic)
<b>BETACAM SP</b>										
BVW-200	NP-1	BKW-L601 -OR- BKW-L403 (INCLUDES A8278-057-A bracket) -or- QRD-700 Anton Bauer bracket	4-PIN 12V DC	XLR (X2)	WR-855A (64, 66, 68) -or- WRR-810A (64, 66, 68)	1/4 WAVE ANTENNAS (x2)	BTA-801 (REQUIRED)	WRR-855A68 (tuner)	WRR-855A68 (tuner)	WRR-855A68 (tuner)
BVW-300 BVW-300A								WRT-830A (transmitter)	WRT-860A68 w/ECM-77BC lavalier microphone	WRT-808A68 (plus any dynamic hand-held mic)
BVW-400 BVW-400A										
BVW-D600WS										
BVW-D600										
PVV-3			Low-cost transmitter: WRT-800A68 or WRT-810A68	Low-cost transmitters: WRT-805A68 w/ECM-44BMP -or- WRT-820A68 w/ECM-77BC	Suggested microphones: F-740/9X F-780 ECM-610					
BVW-6	NONE									
<b>BETACAM SX</b>										
DNW-7	V-wedge for Li-Ion battery included	A8278-057-A bracket (For 2nd WL unit only)	Power supplied directly from camera 4-PIN 12V DC (FOR 2ND WL ONLY)	XLR (X2) (For 2nd WL unit ONLY)	WRR-855A (64, 66, 68) -or- WRR-810A (64, 66, 68)	1/4 WAVE ANTENNAS (x2)	BTA-801 (REQUIRED FOR SECON WL UNIT)	WRR-855A68 (tuner)	WRR-855A68 (tuner)	WRR-855A68 (tuner)
DNW-9WS								WRT-830A or Low-cost transmitters: WRT-800A68 or WRT-810A68	Low-cost transmitters: WRT-805A68 w/ECM-44BMP -or- WRT-820A68 w/ECM-77BC	WRT-808A68 (plus any dynamic hand-held mic) Suggested microphones: F-740/9X F-780 ECM-610
DNW-90										
DNW-90WS										
DNV-6										
<b>DIGITAL BETACAM</b>										
DVW-700	V-wedge for Li-Ion battery & A8278-057-A bracket included	QRD-700 Anton Bauer bracket	4-PIN 12V DC	XLR (X2)	WRR-855A (64, 66, 68) -or- WRR-810A (64, 66, 68)	1/4 WAVE ANTENNAS (x2)	BTA-801 (REQUIRED- Includes mounting hardware)	WRR-855A68 (tuner)	WRR-855A68 (tuner)	WRR-855A68 (tuner)
DVW-700WS								WRT-830A or Low-cost transmitters: WRT-800A68 or WRT-810A68	Low-cost transmitters: WRT-805A68 w/ECM-44BMP -or- WRT-820A68 w/ECM-77BC	WRT-808A68 (plus any dynamic hand-held mic) Suggested microphones: F-740/9X F-780 ECM-610
DVW-707										
DVW-709WS										
DVW-790WS										
<b>DVCAM</b>										
DSR-130	NP-1	-	4-PIN 12V DC	XLR (X2) Not required for DSR-300 and 500WS	WRR-855A (64, 66, 68) -or- WRR-810A (64, 66, 68)	1/4 WAVE ANTENNAS (x2)	BTA-801 (Include plate adapter)	WRR-855A68 (tuner)	WRR-855A68 (tuner)	WRR-855A68 (tuner)
DSR-200(A)	-	DSBK-201	-				BTA-801 (Include plate adapter)	-	-	-
DSR-300	-	CA-WR855	Power supplied through CA-WR-855				CA-WR855	WRT-830A or Low-cost transmitters: WRT-800A68 or WRT-810A68	Low-cost transmitters: WRT-805A68 w/ECM-44BMP -or- WRT-820A68 w/ECM-77BC	WRT-808A68 (plus any dynamic hand-held mic) Suggested microphones: F-740/9X F-780 ECM-610
DSR-500WS										

WRR-855A/BTA-801 and WRR-810A use the same mounting system and may be interchangeable. These are compatible with the BKW-L601, DSBK-201, BKW-L403, NP-1 and Anton Bauer QRD700. Thw WRR-855A with the CA-WR855 adapter works ONLY with the DSR-300 & 500(WS). The WRR-855A with no bracket or adapter, works ONLY with Betacam SX models (plug-in slot).