

FM Stereo FM/AM Receiver

Operating Instructions

Owner's Record

The model and serial numbers are located on the rear of the unit. Record the serial number in the space provided below. Refer to them whenever you call upon your Sony dealer regarding this product.

Model No. _____ Serial No. _____

STR-DE897

WARNING

To prevent fire or shock hazard, do not expose the unit to rain or moisture.

To prevent fire, do not cover the ventilation of the apparatus with newspapers, table-cloths, curtains, etc. And don't place lighted candles on the apparatus.

To prevent fire or shock hazard, do not place objects filled with liquids, such as vases, on the apparatus.

Do not install the appliance in a confined space, such as a bookcase or built-in cabinet.



Don't throw away batteries with general house waste; dispose of them correctly as chemical waste.

For customers in the United States



This symbol is intended to alert the user to the presence of uninsulated "dangerous voltage" within the product's enclosure that may be of sufficient magnitude to constitute a risk of electric shock to persons.



This symbol is intended to alert the user to the presence of important operating and maintenance (servicing) instructions in the literature accompanying the appliance.

WARNING

This equipment has been tested and found to comply with the limits for a Class B digital device, pursuant to Part 15 of the FCC Rules. These limits are designed to provide reasonable protection against harmful interference in a residential installation. This equipment generates, uses, and can radiate radio frequency energy and, if not installed and used in accordance with the instructions, may cause harmful interference to radio communications. However, there is no guarantee that interference will not occur in a particular installation. If this equipment does cause harmful interference to radio or television reception, which can be determined by turning the equipment off and on, the user is encouraged to try to correct the interference by one or more of the following measures:

- Reorient or relocate the receiving antenna.
- Increase the separation between the equipment and receiver.
- Connect the equipment into an outlet on a circuit different from that to which the receiver is connected.
- Consult the dealer or an experienced radio/TV technician for help.

CAUTION

You are cautioned that any changes or modification not expressly approved in this manual could void your authority to operate this equipment.

Note to CATV system installer:

This reminder is provided to call CATV system installer's attention to Article 820-40 of the NEC that provides guidelines for proper grounding and, in particular, specifies that the cable ground shall be connected to the grounding system of the building, as close to the point of cable entry as practical.

For customers in Canada

CAUTION

TO PREVENT ELECTRIC SHOCK, MATCH WIDE BLADE OF PLUG TO WIDE SLOT, FULLY INSERT.



ENERGY STAR® is a U.S. registered mark. As an ENERGY STAR® partner, Sony Corporation has determined that this product meets the ENERGY STAR® guidelines for energy efficiency.

About This Manual

- The instructions in this manual is for model STR-DE897. Check your model number by looking at the lower right corner of the front panel.
- The instructions in this manual describe the controls on the receiver. You can use the controls on the supplied remote if they have the same or similar names as those on the receiver. For details on the use of your remote, see pages 44–53.

About area codes

The area code of the receiver you purchased is shown on the lower portion of the rear panel (see the illustration below).

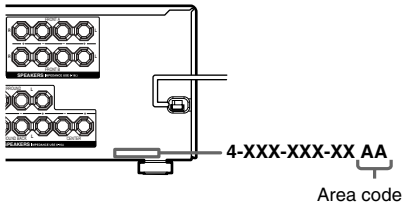

Any differences in operation, according to the area code, are clearly indicated in the text, for example, “Models of area code AA only”.

This receiver incorporates Dolby* Digital and Pro Logic Surround and the DTS** Digital Surround System.

- * Manufactured under license from Dolby Laboratories.
“Dolby”, “Pro Logic” and the double-D symbol are trademarks of Dolby Laboratories.
- ** “DTS”, “DTS-ES”, “Neo:6” and “DTS 96/24” are trademarks of Digital Theater Systems, Inc.

Note for the supplied remote

For RM-PG413

The 2ND button on the remote is not available for receiver operation.

Table of Contents

Getting Started

- 1: Check how to hookup your components 5
 - 1a: Connecting components with digital audio output jacks 7
 - 1b: Connecting components with multi channel output jacks..... 10
 - 1c: Connecting components with only analog audio jacks 12
- 2: Connecting the antennas 14
- 3: Connecting speakers 15
- 4: Connecting the AC power cord 17
- 5: Setting up the speakers 18
- 6: Adjusting the speaker levels and balance 21
 - TEST TONE

Amplifier Operation

- Selecting the component 22
- Listening to multi channel sound 23
 - MULTI CH IN
- Listening to FM/AM radio 23
- Presetting radio stations 24
- Changing the display 25
- About the indications in the display 26

Enjoying Surround Sound

- Using only the front speakers 28
- Enjoying higher fidelity sound 29
 - AUTO FORMAT DIRECT
- Selecting a sound field 30
- Selecting the surround back decoding mode 32
 - SURR BACK DECODING

Advanced Adjustments and Settings

- Assigning the audio input 34
 - DIGITAL ASSIGN
- Switching the audio input mode for digital components 35
 - INPUT MODE
- Customizing sound fields 35
- Adjusting the equalizer 37
- Advanced settings 37

Other Operations

- Naming preset stations and inputs 39
- Using the Sleep Timer 39
- Selecting the speaker system 40
- Recording 40
- Listening to the sound in another zone 41
- CONTROL A1II Control System 42

Operations Using the Remote RM-PG413

- Before you use your remote 44
- Remote button description 44
- Selecting the command mode of the remote 47
- Programming the remote 48
- Learning the commands of your components 51
- Performing several commands in sequence automatically (Macro Play) 52

Additional Information

- Precautions 54
- Troubleshooting 55
- Specifications 58
- List of button locations and reference pages 60
- Index 61

1: Check how to hookup your components

Steps 1a through 1c beginning on page 7 describe how to hook up your components to this receiver. Before you begin, refer to “Connectable components” below for the pages which describe how to connect each component.

After hooking up all your components, proceed to “2: Connecting the antennas” (page 14).

Connectable components

Component to be connected	Page
DVD player	
With digital audio output ^{a)}	7–8
With multi channel audio output ^{b)}	10–11
With analog audio output only ^{c)}	7–8
TV monitor	
With component video input ^{d)}	8 or 11
With S-video or composite video input only	13
Satellite tuner	
With digital audio output ^{a)}	7–8
With analog audio output only ^{c)}	7–8
Super Audio CD/CD player	
With digital audio output ^{a)}	9
With multi channel audio output ^{b)}	10
With analog audio output only ^{c)}	12
MD/Tape deck	
With digital audio output ^{a)}	9
With analog audio output only ^{c)}	12
Analog disc turntable	12
Multi channel decoder	10
VCR, camcorder, video game, etc.	13

a) Model with a DIGITAL OPTICAL OUTPUT or DIGITAL COAXIAL OUTPUT jack, etc.

b) Model with a MULTI CH OUTPUT jacks, etc. This connection is used to output the audio decoded by the component’s internal multi channel decoder through this receiver.

c) Model equipped only with AUDIO OUT L/R jacks, etc.

d) Model with component video (Y, P_B/C_B/B-Y, P_R/C_R/R-Y) input jacks.

Required cords

The hookup diagrams on the subsequent pages assume the use of the following optional connection cords (**A** to **H**) (not supplied).

A Audio cord

White (L)
Red (R)



B Audio/video cord

Yellow (video)
White (L/audio)
Red (R/audio)



C Video cord

Yellow



D S-video cord



E Optical digital cord



F Coaxial digital cord



G Monaural audio cord

Black



Tip

Audio cord **A** can be torn into two monaural audio cords **G**.

H Component video cord

Green
Blue
Red



Notes

- Turn off the power to all components before making any connections.
- Be sure to make connections firmly to avoid hum and noise.
- When connecting an audio/video cord, be sure to match the color-coded pins to the appropriate jacks on the components: yellow (video) to yellow; white (left, audio) to white; and red (right, audio) to red.
- When connecting optical digital cords, insert the cord plugs straight in until they click into place.
- Do not bend or tie optical digital cords.

If you have Sony components with CONTROL A1II jacks

See “CONTROL A1II Control System” on page 42.

1a: Connecting components with digital audio output jacks

Hooking up a DVD player or satellite tuner

For details on the required cords (A–H), see page 6.

1 Connect the audio jacks.

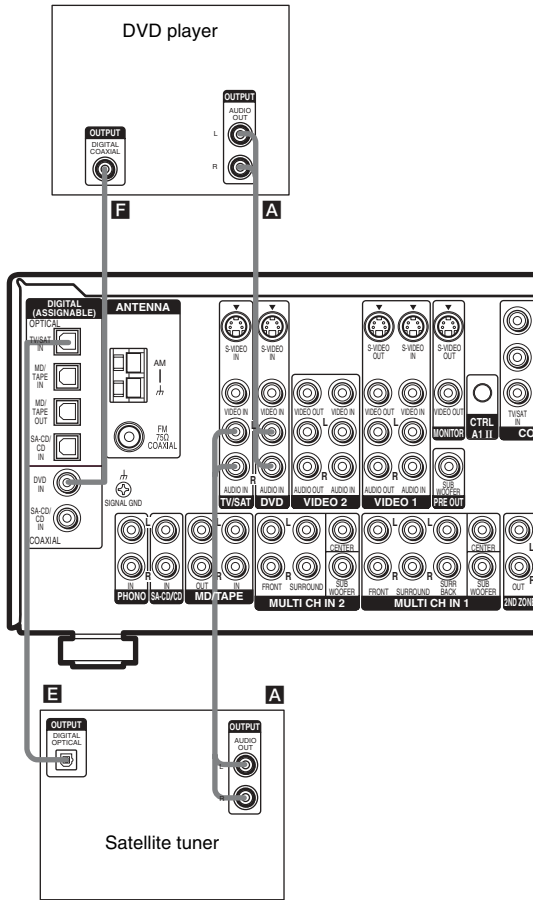

Note

You can also listen to the sound of your TV by connecting your TV's audio output jacks to the TV/SAT AUDIO IN jacks on the receiver. In this case, do not connect the TV's video output jack to the TV/SAT VIDEO IN jack on the receiver.

2 Connect the video jacks.

The following illustration shows how to connect a satellite tuner and a DVD player with COMPONENT VIDEO (Y, P_B/C_B/B-Y, P_R/C_R/R-Y) output jacks. Connecting a TV with component video input jacks allows you to enjoy higher quality video.

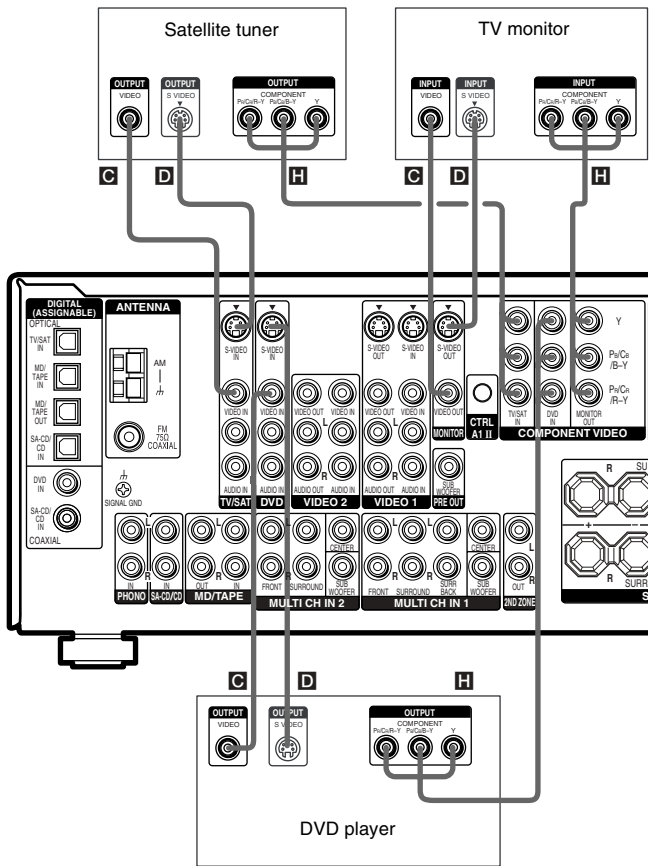

Tips

- When using the S-video jacks instead of the video jacks, your monitor must also be connected via an S-video jack. S-video signals are on a separate bus from the video signals and will not be output through the video jacks.
- When the component is equipped with S-video jacks, you can connect the component to the S-video jacks on this receiver.
- (Models of area code U, CA only) This receiver can convert standard video signals to S-video signals for output from the MONITOR S-VIDEO OUT jacks.

Hooking up an MD/Tape deck or a Super Audio CD/CD player

For details on the required cords (**A**–**H**), see page 6.

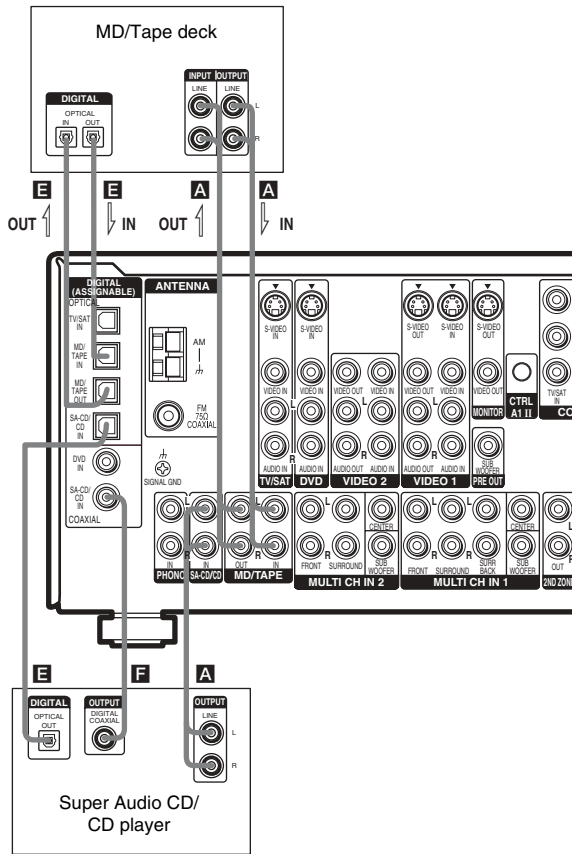

If you want to connect several digital components, but cannot find an unused input

See “Assigning the audio input” (page 34).

Tip

All the digital audio jacks are compatible with 32 kHz, 44.1 kHz, 48 kHz and 96 kHz sampling frequencies.

Notes

- You cannot make digital recordings of digital multi channel surround signals.
- It is not possible to record analog signals to components connected to the MD/TAPE OUT, VIDEO 1 OUT or VIDEO 2 OUT jacks if you make only digital connections. Likewise, you cannot record digital signals if you make only analog connections. To record analog signals, make analog connections. To record digital signals, make digital connections.
- The sound is not output when you play a Super Audio CD on the Super Audio CD player connected to the SA-CD/CD OPTICAL IN or SA-CD/CD COAXIAL IN jack on this receiver. Connect to the analog input jacks (SA-CD/CD IN jacks). Refer to the operating instructions supplied with the Super Audio CD player.

1b: Connecting components with multi channel output jacks

1 Connect the audio jacks.

If your DVD or Super Audio CD player is equipped with multi channel output jacks, you can connect it to this receiver's MULTI CH IN 1/MULTI CH IN 2 jacks to enjoy the multi channel sound. Alternatively, the multi channel input jacks can be used to connect an external multi channel decoder. For details on the required cords (**A-H**), see page 6.

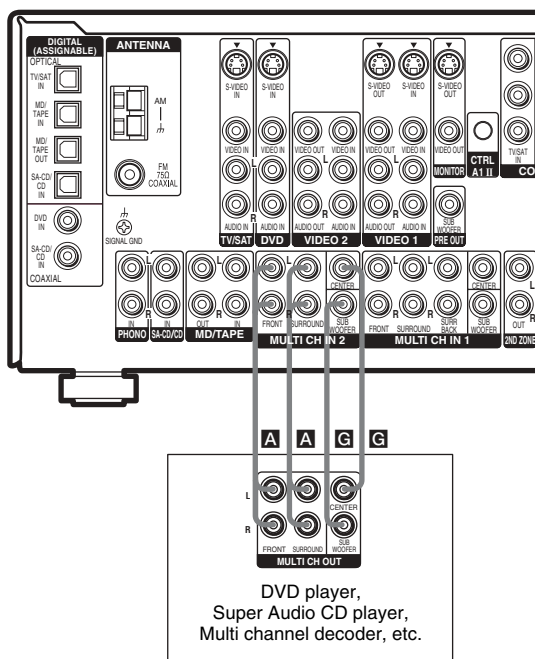

Tips

- This connection also allows you to enjoy software with multi channel audio recorded in formats other than the Dolby Digital and DTS.
- Make connections to either the MULTI CH IN 1 or MULTI CH IN 2 jacks according to the number of audio output jacks of the component.

Note

When you make connections to the MULTI CH IN 1 or MULTI CH IN 2 jacks, you will need to adjust the level of the surround speakers and sub woofer using the controls on the connected component.

2 Connect the video jacks.

The following illustration shows how to connect a DVD player with COMPONENT VIDEO (Y, P_B/C_B/B-Y, P_R/C_R/R-Y) output jacks. Connecting a TV with component video input jacks allows you to enjoy higher quality video.

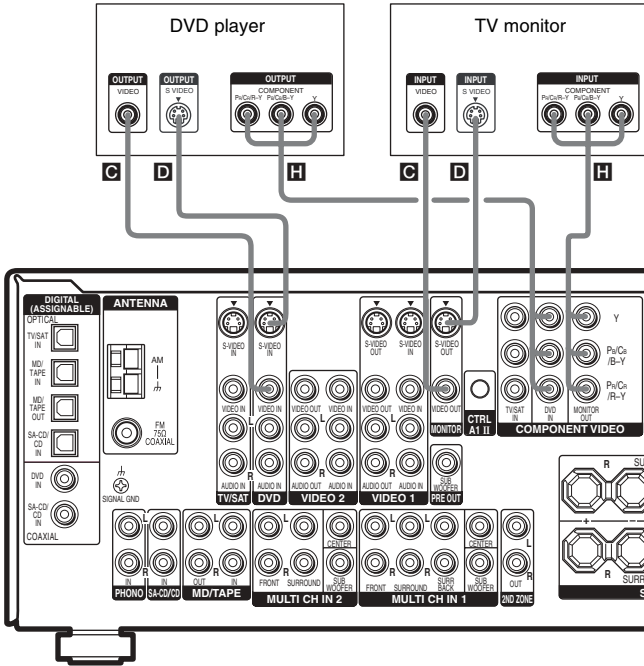

Tips

- When using the S-video jacks instead of the video jacks, your monitor must also be connected via an S-video jack. S-video signals are on a separate bus from the video signals and will not be output through the video jacks.
- When the component is equipped with S-video jacks, you can connect the component to the S-video jacks on this receiver.
- (Models of area code U, CA only) This receiver can convert standard video signals to S-video signals for output from the MONITOR S-VIDEO OUT jacks.

1c: Connecting components with only analog audio jacks

Hooking up audio components

For details on the required cords (A–H), see page 6.

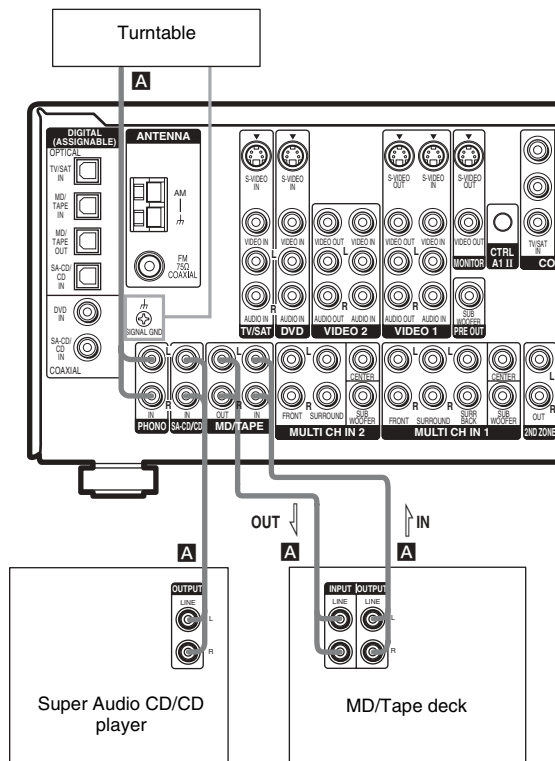

Note

If your turntable has a ground wire, connect it to the SIGNAL GND terminal.

Hooking up video components

If you connect your TV to the MONITOR jacks, you can watch the video from the selected input (page 22). For details on the required cords (A–H), see page 6.

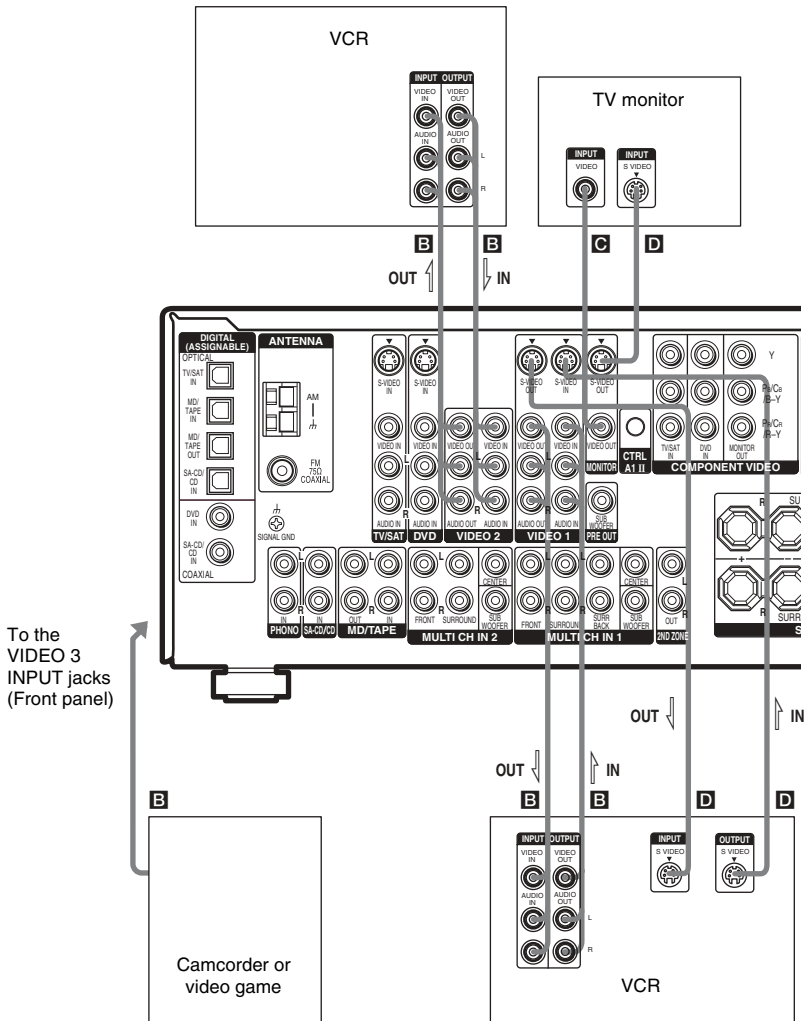

Tips

- When using the S-video jacks instead of the video jacks, your monitor must also be connected via an S-video jack. S-video signals are on a separate bus from the video signals and will not be output through the video jacks.
- When the component is equipped with S-video jacks, you can connect the component to the S-video jacks on this receiver.
- (Models of area code U, CA only) This receiver can convert standard video signals to S-video signals for output from the MONITOR S-VIDEO OUT jacks.

2: Connecting the antennas

Connect the supplied AM loop antenna and FM wire antenna.

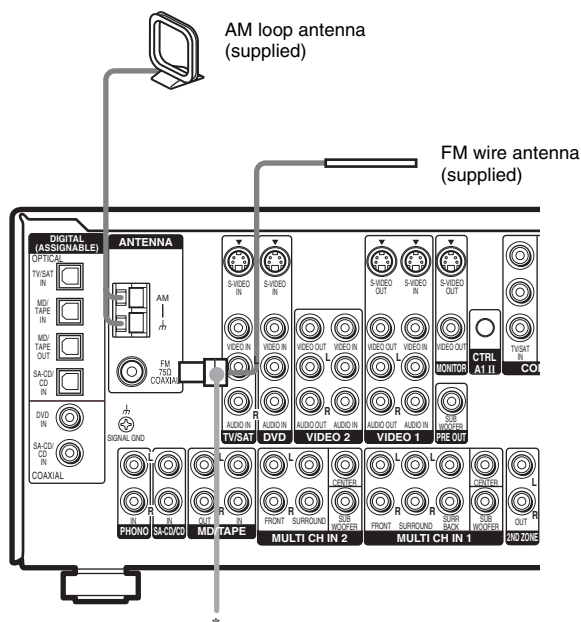

* The shape of the connector varies depending on the area code.

Notes

- To prevent noise pickup, keep the AM loop antenna away from the receiver and other components.
- Be sure to fully extend the FM wire antenna.
- After connecting the FM wire antenna, keep it as horizontal as possible.
- Do not use the ⏏ SIGNAL GND terminal for grounding the receiver.

3: Connecting speakers

Connect your speakers to the receiver. This receiver allows you to use a 7.1 channel speaker system. To fully enjoy theater-like multi channel surround sound requires five speakers (two front speakers, a center speaker, and two surround speakers) and a sub woofer (5.1 channel).

You can enjoy high fidelity reproduction of DVD software recorded in the Surround EX format if you connect one additional surround back speaker (6.1 channel) or two surround back speakers (7.1 channel) (see “Selecting the surround back decoding mode” on page 32).

Example of 7.1 channel speaker system configuration

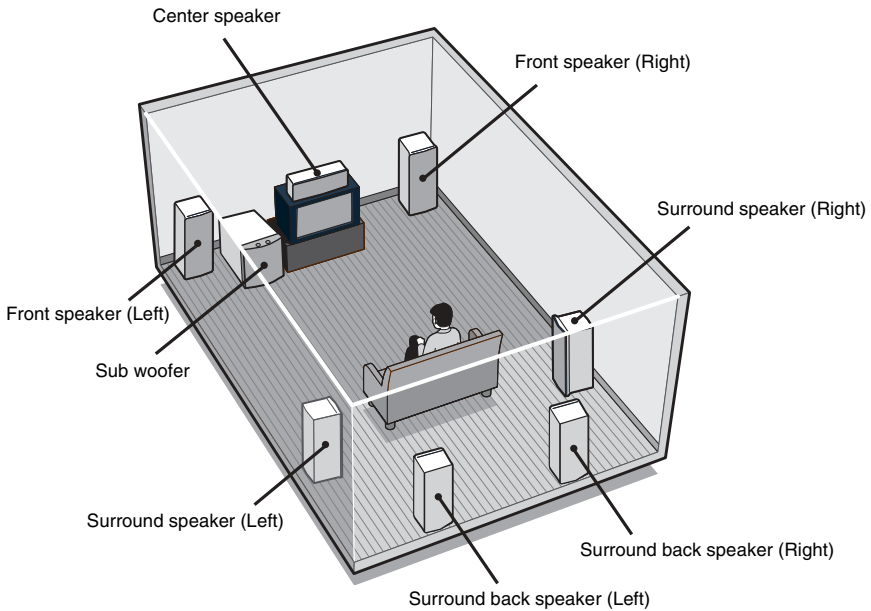

Tips

- When you connect 6.1 channel speaker system, place the surround back speaker right behind the listening position (see “When placing only one surround back speaker” illustration on page 19).
- Since the sub woofer does not emit highly directional signals, you can place it wherever you want.

Required cords

A Speaker cords (not supplied)



B Monaural audio cord (not supplied)

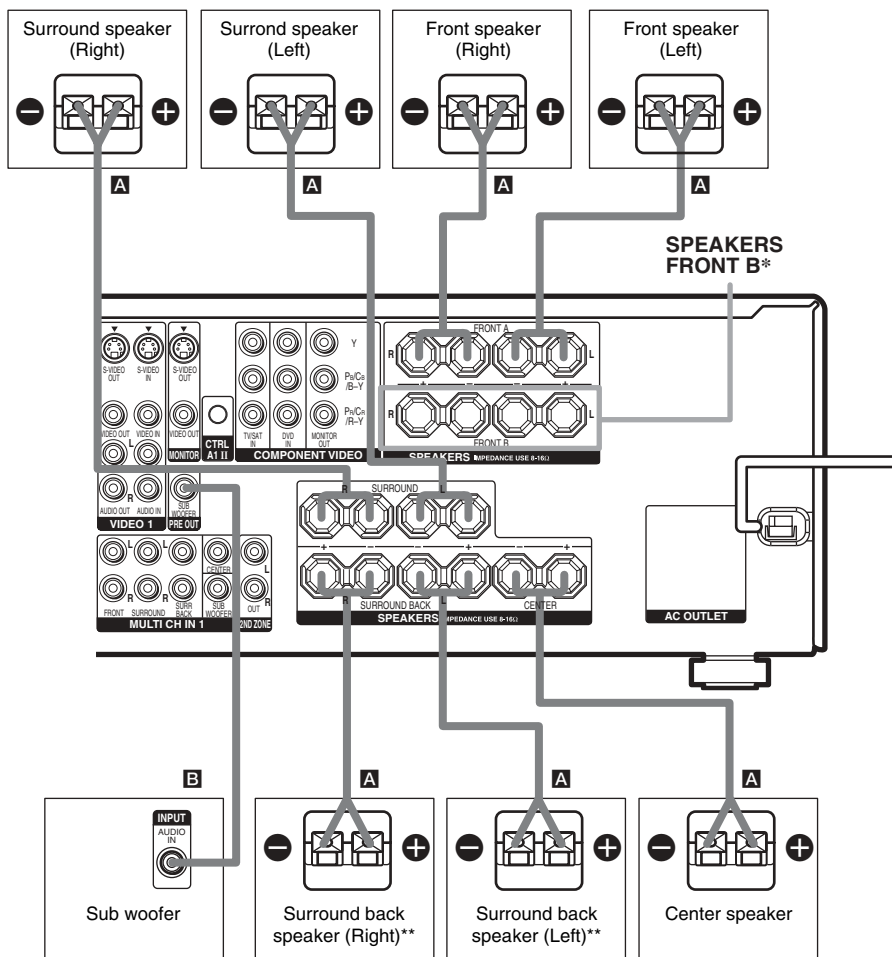

* If you have an additional front speaker system, connect them to the SPEAKERS FRONT B terminals. You can select the front speakers you want to use with SPEAKERS (OFF/A/B/A+B) button. For details, see "Selecting the speaker system" (page 40).

** If you connect only one surround back speaker, connect it to the SPEAKERS SURROUND BACK L terminals.

4: Connecting the AC power cord

Setting the voltage selector

If your receiver has a voltage selector on the rear panel, check that the voltage selector is set to the local power supply voltage. If not, use a screwdriver to set the selector to the correct position before connecting the AC power cord to a wall outlet.

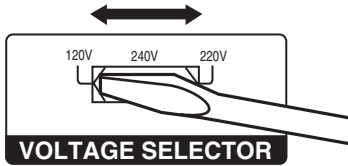

Connecting the AC power cord

Connect the AC power cord to a wall outlet.

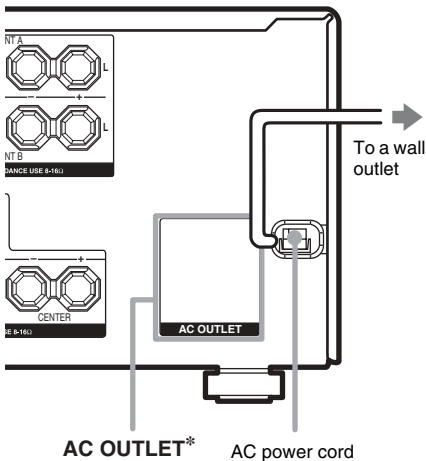

* The configuration, shape and number of AC outlets vary according to the area code.

Notes

- The AC OUTLET(s) on the rear of the receiver is a switched outlet, which supplies power to the connected component only while the receiver is turned on.
- Make sure that the total power consumption of the component(s) connected to the receiver's AC OUTLET(s) does not exceed the wattage stated on the rear panel. Do not connect high-wattage electrical home appliances such as electric irons, fans, or TVs to this outlet. This may cause a malfunction.

Performing initial setup operations

Before using the receiver for the first time, initialize the receiver by performing the following procedure.

This procedure can also be used to return settings you have made to their factory defaults. Use the buttons on the receiver for the operation.

- 1 Press I/⏻ to turn off the receiver.**
- 2 Hold down I/⏻ for 5 seconds.**
“PUSH ENTER” flashes in the display.
- 3 Press ENTER.**

“MEMORY CLEARING” appears in the display for a while, then “MEMORY CLEARED” appears.

The following are reset to their factory settings.

- All settings in the SET UP, LEVEL, EQUALIZER and CUSTOMIZE menus.
- The sound field memorized for each input and preset station.
- All sound field parameters.
- All preset stations.
- All index names for inputs and preset stations.
- MASTER VOLUME $-/+$ is set to “VOL MIN”.
- Input is set to DVD.

5: Setting up the speakers

You can use the SET UP menu to set the size, distance and location of the speakers connected to this receiver.

1 Press I/⏻ to turn on the receiver.

2 Press MAIN MENU repeatedly to select “< SET UP >”.

3 Press < or > repeatedly to select the parameter you want to adjust.

For details, see “Speaker setup parameters” below.

Note

Some speaker setup items may appear dimmed in the display. This means that they have been adjusted automatically due to other speaker settings or may not be adjustable.

4 Turn -/+ to select the setting you want.

The setting is entered automatically.

Note

Press ENTER if you select the setting for “SP. PATTERN X-X”.

5 Repeat steps 3 and 4 until you have set all of the items that follow.

Speaker setup parameters

The initial settings are underlined.

■ EASY SET UP XXX (Speaker easy setup)

- YES

If you want to set up your speakers automatically, select “YES”. You can select a pre-defined speaker pattern (see the supplied “Easy Setup Guide”).

- NO

If you want to adjust the settings of each speaker manually, select “NO”.

■ SP. PATTERN X-X (Speaker setup pattern)

When you select “EASY SET UP YES”, select the speaker setup pattern. Turn -/+ to select the speaker setup pattern and press ENTER to enter the selection. Check your speaker pattern using the supplied “Easy Setup Guide”.

■ SUB WOOFER XXX (Sub woofer selection)

- YES

If you connect a sub woofer, select “YES”.

- NO

If you did not connect a sub woofer, select “NO”. The front speakers are automatically set to “LARGE” and you cannot change this setting. This activates the bass redirection circuitry and outputs the LFE signals from other speakers.

- In order to take full advantage of the Dolby Digital bass redirection circuitry, we recommend that you set the cut off frequency on the sub woofer as high as possible.

■ FRONT SP XXXXX (Front speakers size)

- LARGE

If you connect large speakers that will effectively reproduce bass frequencies, select “LARGE”. Normally, select “LARGE”.

- SMALL

If the sound is distorted, or you feel a lack of surround effects when using multi channel surround sound, select “SMALL” to activate the bass redirection circuitry and output the front channel bass frequencies from the sub woofer. When the front speakers are set to “SMALL”, the center, surround and surround back speakers are also automatically set to “SMALL” (unless previously set to “NO”).

■ CTR SP XXXXX (Center speaker size)

- LARGE

If you connect a large speaker that will effectively reproduce bass frequencies, select “LARGE”. Normally, select “LARGE”. However, if the front speakers are set to “SMALL”, you cannot set the center speaker to “LARGE”.

- SMALL

If the sound is distorted, or you feel a lack of surround effects when using multi channel surround sound, select “SMALL” to activate the bass redirection circuitry and output the center channel bass frequencies from the front speakers (if set to “LARGE”) or sub woofer.^{a)}

- NO
If you did not connect a center speaker, select “NO”. The sound of the center channel will be output from the front speakers.^{b)}

■ SURR SP XXXXX (Surround speakers size)

- LARGE
If you connect large speakers that will effectively reproduce bass frequencies, select “LARGE”. Normally, select “LARGE”. However, if the front speakers are set to “SMALL”, you cannot set the surround speakers to “LARGE”.
- SMALL
If the sound is distorted, or you feel a lack of surround effects when using multi channel surround sound, select “SMALL” to activate the bass redirection circuitry and output the surround channel bass frequencies from the sub woofer or other “LARGE” speakers.
- NO
If you did not connect surround speakers, select “NO”.^{c)}

■ SB SP XXXXXX (Surround back speakers selection)

When the surround speakers are set to “NO”, the surround back speakers are also automatically set to “NO” and the setting cannot be changed.

- DUAL
If you connect two surround back speakers, select “DUAL”. The sound will be output to a maximum of 7.1 channels.
- SINGLE
If you connect only one surround back speaker, select “SINGLE”. The sound will be output to a maximum of 6.1 channels.
- NO
If you did not connect surround back speaker, select “NO”.

Tips

- a)–c) correspond to the following Dolby Pro Logic modes
 - NORMAL
 - PHANTOM
 - 3 STEREO
- The “LARGE” and “SMALL” settings for each speaker determine whether the internal sound processor will cut the bass signal from that channel.

When the bass is cut from a channel, the bass redirection circuitry sends the corresponding bass frequencies to the sub woofer or other “LARGE” speakers.

However, since bass sounds have a certain amount of directionality, it is best not to cut them, if possible. Therefore, even when using small speakers, you can set them to “LARGE” if you want to output the bass frequencies from that speaker. On the other hand, if you are using a large speaker, but prefer not to have bass frequencies output from that speaker, set it to “SMALL”.

If the overall sound level is lower than you prefer, set all speakers to “LARGE”. If there is not enough bass, you can use the BASS parameter in the EQUALIZER menu to boost the bass levels. To adjust the bass, see page 37.

■ FRONT DIST. X.X m (XX ft.) (Front speaker distance)

Initial setting: 3.0 m (10 ft.)

Lets you set the distance from your listening position to the front speakers (A). You can adjust from 1.0 meter to 7.0 meters (3 to 23 feet) in 0.1 meter (1 foot) steps.

If both front speakers are not placed an equal distance from your listening position, set the distance to the closest speaker.

When placing only one surround back speaker

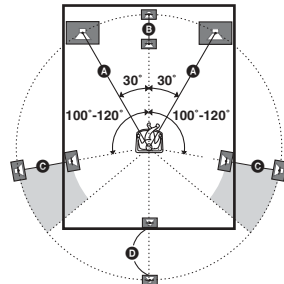

When placing two surround back speakers
(The angle E should be the same)

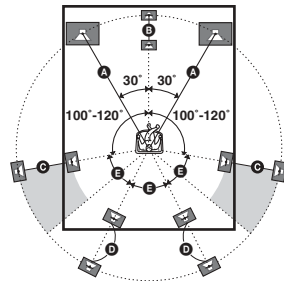

continued

■ CTR DIST. X.X m (XX ft.)
(Center speaker distance)

Initial setting: 3.0 m (10 ft.)

Lets you set the distance from your listening position to the center speaker. Center speaker distance should be set from a distance equal to the front speaker distance (A on page 19) to a distance 1.5 meters (5 feet) closer to your listening position (B on page 19).

■ SURR DIST. X.X m (XX ft.)
(Surround speaker distance)

Initial setting: 3.0 m (10 ft.)

Lets you set the distance from your listening position to the surround speakers. Surround speaker distance should be set from a distance equal to the front speaker distance (A on page 19) to a distance 4.5 meters (15 feet) closer to your listening position (C on page 19). If both surround speakers are not placed an equal distance from your listening position, set the distance to the closest speaker.

■ SB DIST. X.X m (XX ft.)
(Surround back speaker distance)

Initial setting: 3.0 m (10 ft.)

Lets you set the distance from your listening position to the surround back speaker. Surround back speaker distance should be set from a distance equal to the front speaker distance (A on page 19) to a distance 4.5 meters (15 feet) closer to your listening position (D on page 19).

If you connect two surround back speakers and both surround back speakers are not placed an equal distance from your listening position, set the distance to the closest speaker.

Tip

The receiver lets you to input the speaker position in terms of distance. However, it is not possible to set the center speaker further than the front speakers. Also, the center speaker cannot be set more than 1.5 meters (5 feet) closer than the front speakers.

Likewise, the surround speakers and the surround back speakers cannot be set further away from the listening position than the front speakers. And they can be no more than 4.5 meters (15 feet) closer.

This is because incorrect speaker placement is not conducive to the enjoyment of surround sound.

Please note that, setting the speaker distance closer than the actual location of the speakers will cause a delay in the output of the sound from that speaker. In other words, the speaker will sound like it is further away.

For example, setting the center speaker distance 1–2 meters (3–6 feet) closer than the actual speaker position will create a fairly realistic sensation of being “inside” the screen. If you cannot obtain a satisfactory surround effect because the surround speakers are too close, setting the surround speaker distance closer (shorter) than the actual distance will create a larger sound stage.

Adjusting these parameter while listening to the sound often results in much better surround sound. Give it a try!

■ PL. XXXX/XXXX
(Surround speaker position)*

Lets you specify the location of your surround speakers for proper implementation of the surround effects in the Cinema Studio EX modes (page 30).

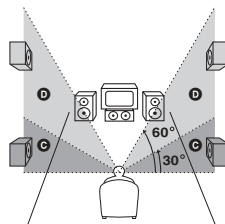
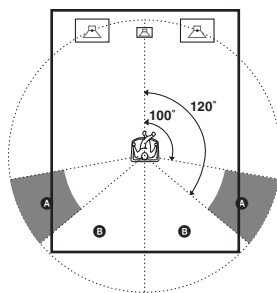

- **SIDE/LOW**
Select if the location of your surround speakers corresponds to section A and C.
- **SIDE/HIGH**
Select if the location of your surround speakers corresponds to section A and D.
- **BEHD/LOW**
Select if the location of your surround speakers corresponds to section B and C.
- **BEHD/HIGH**
Select if the location of your surround speakers corresponds to section B and D.

* This setup item is not available when the surround speakers size parameter is set to “NO”.

Tip

Surround speaker position is designed specifically for implementation of the Cinema Studio EX modes.

For other sound fields, speaker position is not so critical. Those sound fields were designed under the premise that the surround speakers would be located behind the listening position, but presentation remains fairly consistent even with the surround speakers positioned at a rather wide angle. However, if the speakers are pointing toward the listener from the immediate left and right of the listening position, the surround effects becomes unclear unless set to “SIDE/LOW” or “SIDE/HIGH”.

Nevertheless, each listening environment has many variables, such as wall reflections, and you may obtain better results using “BEHD/HIGH” if your speakers are located high above the listening position, even if they are to the immediate left and right.

Therefore, although it may result in a setting contrary to the above explanation, we recommend that you playback multi channel surround encoded software and select the setting that provides a good sense of spaciousness and that best succeeds in forming a cohesive space between the surround sound from the surround speakers and the sound of the front speakers. If you are not sure which sounds best, select “BEHD/LOW” or “BEHD/HIGH” and then use the speaker distance parameter and speaker level adjustments to obtain proper balance.

6: Adjusting the speaker levels and balance

— TEST TONE

Adjust the speaker levels and balance while listening to the test tone from your listening position. Use the remote for the operation.

Tip

The receiver employs a test tone with a frequency centered at 800 Hz.

1 Press I/⏻ to turn on the receiver.

2 Press TEST TONE.

“TEST TONE [XXX]” appears in the display and the test tone is output from each speaker in sequence.

Front (left) → Center → Front (right) → Surround (right) → Surround back (right)* → Surround back (left)* → Surround (left) → Sub woofer

- * You will only hear the test tone from the
- surround back left and right speakers when surround back speaker selection is set to “DUAL”.
 - surround back left speaker when surround back speaker selection is set to “SINGLE”.

3 Adjust the speaker levels and balance using the LEVEL menu so that the level of the test tone sounds the same from each speaker.

For details on the LEVEL menu settings, see page 35.

Tips

- To adjust the level of all speakers at the same time, press MASTER VOL +/- on the remote or turn MASTER VOLUME -/+ on the receiver.
- The adjusted value are shown in the display during adjustment.

4 Press TEST TONE again after adjustment.

The test tone turns off.

Notes

- The test tone cannot be used when MULTI CH IN 1/2 or ANALOG DIRECT function is used.
- Although these adjustments can also be made via the front panel using the LEVEL menu (when the test tone is output, the receiver switches to the LEVEL menu automatically), we recommend you follow the procedure described above and adjust the speaker levels from your listening position using the remote.

Amplifier Operation

Selecting the component

1 Turn INPUT SELECTOR to select the input.

To select the	Display/light up
VCR	VIDEO 1 or VIDEO 2
Camcorder or video game	VIDEO 3
DVD player	DVD
Satellite tuner	TV/SAT
MD or tape deck	MD/TAPE
Super Audio CD or CD player	SA-CD/CD
Built-in tuner (FM/AM)	TUNER FM/AM
Turntable	PHONO

2 Turn on the component and start playback.

Note

If you select the VCR or DVD player, set the TV's video input to match the component you selected.

3 Turn MASTER VOLUME $-/+$ to adjust the volume.

Note

To avoid damaging your speakers, make sure that you turn down the volume before you turn off the receiver.

To mute the sound

Press MUTING on the remote.

The muting function will be canceled when you do the following.

- Press MUTING on the remote again.
- Turn the power off.
- Increase the volume.

To use the headphones

Connect the headphones to the PHONES jack.

- When the headphones are connected, speaker output is automatically canceled and "SP.A" and "SP.B" do not light up in the display.
- When the headphones are connected, you can select only the following sound fields (page 31).
 - HP 2CH (HEADPHONE 2CH)
 - HP DIRECT (HEADPHONE DIRECT)
 - HP MULTI 1 (HEADPHONE MULTI 1)
 - HP MULTI 2 (HEADPHONE MULTI 2)
 - HP THEATER (HEADPHONE THEATER)

Listening to multi channel sound

— MULTI CH IN

You can select the audio directly from the components connected to the MULTI CH IN 1 or 2 jacks. This enables you to enjoy high quality analog inputs like DVD or Super Audio CD. When MULTI CH IN function is selected, the equalizer and sound field cannot be used.

Press MULTI CH IN/DIRECT repeatedly to select “MULTI 1 DIRECT” or “MULTI 2 DIRECT”.

To cancel the MULTI CH IN function, press MULTI CH IN/DIRECT repeatedly until “MULTI CH IN 1”, “MULTI CH IN 2” and “A.DIRECT” indication turns off.

When MULTI CHANNEL DECODING indicator lights up

The MULTI CHANNEL DECODING indicator lights up when the receiver is decoding multi channel sources.

However, this indicator does not light up if you select 2CH STEREO mode.

Listening to FM/AM radio

You can listen to FM and AM broadcasts through the built-in tuner. Before operation, make sure you have connected the FM and AM antennas to the receiver (see page 14).

Tip

The tuning scale differs depending on the area code as shown in the following table. For details on area codes, see page 3.

Area code	FM	AM
U, CA	100 kHz	10 kHz*
E2/E3	50 kHz	9 kHz*
AR	50 kHz	10 kHz

* The AM tuning scale can be changed (see page 59).

Automatic tuning

If you do not know the frequency of the station you want, you can let the receiver scan all available stations in your area.

1 Turn INPUT SELECTOR to select the FM or AM band.

The last received station is tuned in.

2 Press TUNING + or TUNING –.

Press TUNING + to scan from low to high; press TUNING – to scan from high to low.

The receiver stops scanning whenever a station is received.

Tip

If “STEREO” flashes in the display and the FM stereo reception is poor, press FM MODE to change to monaural (MONO). You will not be able to enjoy the stereo effect, but the sound will be less distorted. To return to stereo mode, press FM MODE again.

Direct tuning

You can enter the frequency of the station you want directly. Use the remote for the operation.

- 1 Press TUNER repeatedly to select the FM or AM band.**

The last received station is tuned in.

Tip

You can also use INPUT SELECTOR on the receiver.

- 2 Press D.TUNING.**
- 3 Press the numeric buttons to enter the frequency.**

Example 1: FM 102.50 MHz

Press 1 → 0 → 2 → 5 → 0

Example 2: AM 1,350 kHz

(You do not have to enter the last "0" when the tuning scale is set to 10 kHz.)

Press 1 → 3 → 5 → 0

If you have tuned in an AM station, adjust the direction of the AM loop antenna for optimum reception.

If you cannot tune in a station and the entered numbers flash

Make sure you have entered the right frequency. If not, repeat steps 2 and 3. If the entered numbers still flash, the frequency is not used in your area.

Presetting radio stations

You can preset up to 30 FM or AM stations. Then you can easily tune in the stations you often listen to.

Presetting radio stations

- 1 Turn INPUT SELECTOR to select the FM or AM band.**
The last received station is tuned in.
- 2 Tune in the station that you want to preset using Automatic Tuning (page 23) or Direct Tuning (page 24).**
- 3 Press MEMORY.**
"MEMORY" appears in the display for a few seconds. Do steps 4 to 5 before the display goes out.
- 4 Press PRESET TUNING + or PRESET TUNING – repeatedly to select a preset station number.**

Each time you press the button, you can select the preset station number as follows:

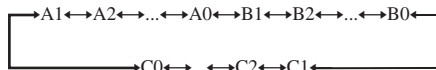

If "MEMORY" goes out before you select the preset station number, start again from step 3.

Tip

You can also use the remote to select a preset station number. Press SHIFT repeatedly to select a memory page (A, B or C) and then press the numeric button to select a preset number.

- 5 Press MEMORY again.**
The station is stored to the selected preset number.
If "MEMORY" goes out before you press MEMORY, start again from step 3.
- 6 Repeat steps 2 to 5 to preset another station.**

Tuning to preset stations

- 1 Turn INPUT SELECTOR to select the FM or AM band.

The last received station is tuned in.

- 2 Press PRESET TUNING + or PRESET TUNING – repeatedly to select the preset station you want.

Each time you press the button, you can select the preset station as follows:

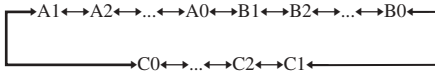

Using the remote

- 1 Press TUNER repeatedly to select the FM or AM band.
- 2 Press PRESET/CH/D.SKIP +/- repeatedly to select the preset station you want.

To select the preset station directly

Press the numeric buttons on the remote.

The preset station of the selected number in the current memory page is tuned in. Press SHIFT repeatedly on the remote to change the memory page.

Changing the display

Changing the information in the display

You can check the sound field etc. by changing the information in the display.

Press DISPLAY repeatedly.

Each time you press DISPLAY, the display will change cyclically as follows.

Index name of the input* → Selected input → Sound field currently applied

When the tuner is selected

Preset station name* → Frequency → Sound field currently applied

* Index name appears only when you have assigned one to the input or preset station (page 39). Index name does not appear when only blank spaces have been entered, or it is the same as the input name.

Adjusting the brightness of the display

Press DIMMER repeatedly.

The brightness of the display will change in 3 steps.

About the indications in the display

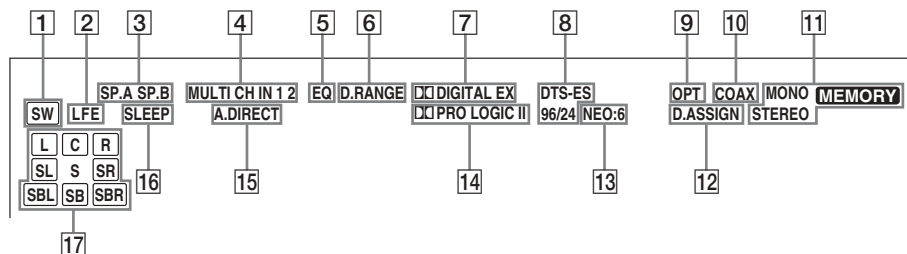

- 1 **SW:** Lights up when sub woofer selection is set to “YES” (page 18) and the audio signal is output from the SUB WOOFER jacks.
- 2 **LFE:** Lights up when the disc being played back contains the LFE (Low Frequency Effect) channel and the LFE channel signal is actually being reproduced.
- 3 **SP.A/SP.B:** Lights up in accordance with the speaker system being used (A or B). Turns off when speaker output is turned off or when headphones are connected.
- 4 **MULTI CH IN 1 or 2:** Lights up when “MULTI 1 DIRECT” or “MULTI 2 DIRECT” is selected.
- 5 **EQ:** Lights up when the equalizer functions.
- 6 **D.RANGE:** Lights up when dynamic range compression is activated (page 36).
- 7 **DIGITAL EX:** “DIGITAL” lights up when the receiver is decoding signals recorded in the Dolby Digital format. “DIGITAL EX” lights up when the receiver is decoding signals recorded in the Dolby Digital EX format.
- 8 **DTS-ES 96/24:** “DTS” lights up when DTS signals are input. “DTS-ES” lights up when DTS-ES signals are input. “DTS 96/24” lights up when the receiver is decoding DTS 96 kHz/24 bit signals.
Note
When playing a DTS format disc, be sure that you have made digital connections and that INPUT MODE is not set to “ANALOG FIXED” (page 35).
- 9 **OPT:** Lights up when the source signal is a digital signal being input through the OPTICAL terminal or when INPUT MODE is set to “OPT FIXED” (page 35).
- 10 **COAX:** Lights up when the source signal is a digital signal being input through the COAXIAL terminal or when INPUT MODE is set to “COAX FIXED” (page 35).
- 11 **Tuner indicators:** Lights up when using the receiver to tune in radio stations, etc. See pages 23–25 for tuner operations.
- 12 **D.ASSIGN:** Lights up when the digital assign function is used for the selected input.
- 13 **NEO:6:** Lights up when DTS Neo:6 Cinema/Music mode decoding is activated. However, this indicator does not light up if both the center and surround speakers are set to “NO”.
- 14 **PRO LOGIC II:** “PRO LOGIC” lights up when the receiver applies Pro Logic processing to 2 channel signals in order to output the center and surround channel signals. “PRO LOGIC II” lights up when the Pro Logic II Movie/Music decoder is activated. However, both indicators do not light up if both the center and surround speakers are set to “NO” and “A.F.D. AUTO”, “PRO LOGIC”, “PLII MOVIE” or “PLII MUSIC” is selected.
Note
Dolby Pro Logic and Dolby Pro Logic II decoding do not function for DTS format signals.
- 15 **A.DIRECT:** Lights up when you select ANALOG DIRECT.

- 16 SLEEP:** Lights up when sleep timer is activated.
- 17 Playback channel indicators:** The letters (L, C, R, etc.) indicate the channels being played back. The boxes around the letters vary to show how the receiver downmixes the source sound (based on the speakers settings).

L (Front Left), R (Front Right), C (Center (monaural)), SL (Surround Left), SR (Surround Right), S (Surround (monaural) or the surround components obtained by Pro Logic processing), SB (Surround Back (the surround back components obtained by 6.1 channel decoding)), SBL (Surround Back Left), SBR (Surround Back Right)

Example:

Recording format (Front /Surround): 3/2
Output channel: Surround speakers absent
Sound Field: A.F.D. AUTO

L	C	R
SL		SR

Enjoying Surround Sound

Using only the front speakers

In this mode, the receiver outputs the sound from the front left/right speakers only. There is no sound from the sub woofer.

Listening to 2 channel stereo sources (2CH STEREO)

Standard 2 channel stereo sources completely bypass the sound field processing and multi channel surround formats are downmixed to 2 channel.

Press 2CH.

“2CH STEREO” appears in the display and the receiver switches to the 2CH STEREO mode.

Note

No sound is output from the sub woofer in the 2CH STEREO mode. To listen to the 2 channel stereo sources using the front left/right speakers and a sub woofer, set to the A.F.D. mode.

Listening to analog audio (ANALOG DIRECT)

You can switch the audio of the selected input to the two channel analog input. This function enables you to enjoy high quality analog sources.

When using this function, only the volume and front speaker balance can be adjusted.

- 1** Turn **INPUT SELECTOR** to select the input you want to listen to in analog audio.
- 2** Press **MULTI CH IN/DIRECT** repeatedly to select “ANALOG DIRECT”.

“ANALOG DIRECT” appears in the display and the analog audio is output.

To cancel the ANALOG DIRECT function, press **MULTI CH IN/DIRECT** repeatedly until “MULTI CH IN 1”, “MULTI CH IN 2” and “A.DIRECT” indication turns off.

Note

When the ANALOG DIRECT function is selected, the equalizer and sound field cannot be used.

Enjoying higher fidelity sound

— AUTO FORMAT DIRECT

The Auto Format Direct (A.F.D.) mode allows you to select the decoding mode you want for your audio sound.

A.F.D. mode (Display)	Decoding mode
A.F.D. AUTO (A.F.D. AUTO)	As encoded
PRO LOGIC (PRO LOGIC)	Dolby Pro Logic
PRO LOGIC II MOVIE (PLII MOVIE)	Dolby Pro Logic II
PRO LOGIC II MUSIC (PLII MUSIC)	
Neo:6 Cinema (NEO6 CINEMA)	DTS Neo:6
Neo:6 Music (NEO6 MUSIC)	

Decoding the input audio signal automatically

In this mode, the receiver automatically detects the type of audio signal being input (Dolby Digital, DTS, standard 2 channel stereo, etc.) and performs the proper decoding if necessary. This mode presents the sound as it was recorded/encoded, without adding any surround effects. However, if there are no low frequency signals (Dolby Digital LFE, etc.) it will generate a low frequency signal for output to the sub woofer.

Press A.F.D. repeatedly to select “A.F.D. AUTO”.

The receiver automatically detects the type of audio signal being input and performs the proper decoding if necessary.

Enjoying stereo sound in multi channel (2 channel decoding mode)

This mode lets you specify the type of decoding for 2 channel audio sources. This receiver can reproduce 2 channel sound in 5 channels through Dolby Pro Logic II; 6 channels through DTS Neo:6 or 4 channels through Dolby Pro Logic. However, DTS 2CH sources are not decoded by DTS Neo:6; they are output in 2 channels.

Press A.F.D. repeatedly to select the 2 channel decoding mode.

The selected type of decoding appears in the display.

■ PRO LOGIC (PRO LOGIC)

Performs Dolby Pro Logic decoding. The source recorded in 2 channel is decoded into 4.1 channels.

■ PLII MOVIE (PRO LOGIC II MOVIE)

Performs Dolby Pro Logic II Movie mode decoding. This setting is ideal for movies encoded in Dolby Surround. In addition, this mode can reproduce sound in 5.1 channel when watching videos of overdubbed or old movies.

■ PLII MUSIC (PRO LOGIC II MUSIC)

Performs Dolby Pro Logic II Music mode decoding. This setting is ideal for normal stereo sources such as CDs.

Note

Dolby Pro Logic and Dolby Pro Logic II decoding do not function for DTS format signals.

■ NEO6 CINEMA

Performs DTS Neo:6 Cinema mode decoding.

■ NEO6 MUSIC

Performs DTS Neo:6 Music mode decoding. This setting is ideal for normal stereo sources such as CDs.

If you connect a sub woofer

When the audio signal is 2 channel stereo or if the source signal does not include a LFE signal, the receiver generates a low frequency signal for output to the sub woofer. However the low frequency signal is not generated when “Neo:6 Cinema” or “Neo:6 Music” is selected.

Selecting a sound field

You can take advantage of surround sound simply by selecting one of the receiver's pre-programmed sound fields. They bring the exciting and powerful sound of movie theaters and concert halls into your home.

Selecting a sound field for movies

Press **MOVIE** repeatedly to select the sound field you want.

The selected sound field appears in the display.

Sound field	Display
CINEMA STUDIO EX A DCS	CINEMA ST. EX A
CINEMA STUDIO EX B DCS	CINEMA ST. EX B
CINEMA STUDIO EX C DCS	CINEMA ST. EX C

About DCS (Digital Cinema Sound)

Sound fields with **DCS** marks use DCS technology.

DCS is the concept name of the surround technology for home theater developed by Sony. DCS uses the DSP (Digital Signal Processor) technology to reproduce the sound characteristics of an actual cinema cutting studio in Hollywood.

When played at home, DCS will create a powerful theater effect that mimics the artistic combination of sound and action as envisioned by the movie director.

■ CINEMA ST. EX A (CINEMA STUDIO EX A) **DCS**

Reproduces the sound characteristics of the Sony Pictures Entertainment "Cary Grant Theater" cinema production studio. This is a standard mode, great for watching most any type of movies.

■ CINEMA ST. EX B (CINEMA STUDIO EX B) **DCS**

Reproduces the sound characteristics of the Sony Pictures Entertainment "Kim Novak Theater" cinema production studio. This mode is ideal for watching science-fiction or action movies with lots of sound effects.

■ CINEMA ST. EX C (CINEMA STUDIO EX C) **DCS**

Reproduces the sound characteristics of the Sony Pictures Entertainment scoring stage. This mode is ideal for watching musicals or films where orchestra music is featured in the soundtrack.

About CINEMA STUDIO EX modes

CINEMA STUDIO EX modes are suitable for watching motion picture DVDs (etc.), with multi channel surround effects. You can reproduce the sound characteristics of Sony Pictures Entertainment's dubbing studio in your home.

The CINEMA STUDIO EX modes consist of the following three elements.

- Virtual Multi Dimension
Creates 5 sets of virtual speakers from a single pair of actual surround speakers.
- Screen Depth Matching
Creates the sensation that the sound is coming from inside the screen like in theaters.
- Cinema Studio Reverberation
Reproduces the type of reverberation found in theaters.

The CINEMA STUDIO EX modes integrate these three elements simultaneously.

Notes

- The effects provided by the virtual speakers may cause increased noise in the playback signal.
- When listening with sound fields that employ the virtual speakers, you will not be able to hear any sound coming directly from the surround speakers.

Selecting a sound field for music

Press **MUSIC** repeatedly to select the sound field you want.

The selected sound field appears in the display.

Sound field	Display
HALL	HALL
JAZZ CLUB	JAZZ CLUB
LIVE CONCERT	LIVE CONCERT

■ HALL

Reproduces the acoustics of a classical concert hall.

■ JAZZ CLUB

Reproduces the acoustics of a jazz club.

■ LIVE CONCERT

Reproduces the acoustics of a 300-seat live house.

When the headphones are connected

You can select only from the following sound fields.

■ HP 2CH (HEADPHONE 2CH)

Outputs the sound in 2 channel (stereo). Standard 2 channel stereo sources completely bypass the sound field processing and multi channel surround formats are downmixed to 2 channels.

■ HP DIRECT (HEADPHONE DIRECT)

Outputs the analog signals without processing by the equalizer, sound field, etc.

■ HP MULTI 1/2 (HEADPHONE MULTI 1 or 2)

Outputs the front analog signals from MULTI CH IN 1 or 2 jacks.

■ HP THEATER (HEADPHONE THEATER) **DCS**

Allows you to experience a theater-like environment while listening through a pair of headphones.



Note

If you connect a pair of headphones while a sound field is operating, the system will automatically switch to “HP 2CH” if using a sound field selected with the 2CH or A.F.D. button, or to “HP THEATER” if using a sound field selected with the MOVIE or MUSIC button.

To turn off the surround effect

Press 2CH to select “2CH STEREO” or press A.F.D. repeatedly to select “A.F.D. AUTO”.

Tips

- The receiver lets you apply the last selected sound field to an input whenever it is selected (Sound Field Link). For example, if you select HALL for the SA-CD/CD input, then change to a different input and then return to SA-CD/CD, HALL will automatically be applied again.
- You can identify the encoding format of DVD software, etc. by looking at the logo on the package.
 -  : Dolby Digital discs
 -  : Dolby Surround encoded programs
 -  : DTS Digital Surround encoded programs

Notes

- Sound fields do not function for the signals with a sampling frequency of more than 48 kHz.
- When one of the following sound fields are selected, no sound is output from the sub woofer if all the speakers are set to “LARGE” in the SET UP menu. However, the sound will be output from the sub woofer if the digital input signal contains LFE (Low Frequency Effect) signals, or if the front, center, or surround speakers are set to “SMALL”.
 - HALL
 - JAZZ CLUB
 - LIVE CONCERT

Selecting the surround back decoding mode

— *SURR BACK DECODING*

This function lets you select the decoding mode for the surround back signals of the multi channel input stream.

By decoding the surround back signal of DVD software (etc.) recorded in Dolby Digital EX, DTS-ES Matrix, DTS-ES Discrete 6.1, etc. format, you can enjoy the surround sound intended by the filmmakers.

Press SURR BACK DECODING repeatedly to select the surround back decoding mode.

“SB DEC XXXXXX” appears in the display.

For details, see “How to select the surround back decoding mode” on page 33.

Tip

You can select the surround back decoding mode using “SB DEC XXXXXX” in the CUSTOMIZE menu (page 38).

Note

You can select the surround back decoding mode only when A.F.D. mode is selected (page 29).

How to select the surround back decoding mode

You can select the surround back mode you want according to the input stream.

When you select “AUTO”

When the input stream contains the 6.1 channel decode flag^{a)}, the appropriate decoder is applied to decode the surround back signal.

Input stream	Output channel	Applied surround back decoder
Dolby Digital 5.1	5.1 ^{e)}	—
Dolby Digital EX ^{b)}	6.1 ^{e)}	Matrix decoder conforms to Dolby Digital EX
DTS 5.1	5.1 ^{e)}	—
DTS-ES Matrix 6.1 ^{c)}	6.1 ^{e)}	DTS Matrix decoder
DTS-ES Discrete 6.1 ^{d)}	6.1 ^{e)}	DTS Discrete decoder

When you select “MATRIX”

Dolby Digital EX is applied to decode the surround back signal regardless of the 6.1 channel decode flag^{a)} in the input stream. This decoder conforms to Dolby Digital EX and functions the same as the decoders^{f)} used in movie theaters.

Input stream	Output channel	Applied surround back decoder
Dolby Digital 5.1	6.1 ^{e)}	Matrix decoder conforms to Dolby Digital EX
Dolby Digital EX ^{b)}	6.1 ^{e)}	Matrix decoder conforms to Dolby Digital EX
DTS 5.1	6.1 ^{e)}	Matrix decoder conforms to Dolby Digital EX
DTS-ES Matrix 6.1 ^{c)}	6.1 ^{e)}	Matrix decoder conforms to Dolby Digital EX
DTS-ES Discrete 6.1 ^{d)}	6.1 ^{e)}	Matrix decoder conforms to Dolby Digital EX

When you select “OFF”

Surround back decoding is not performed.

- a) 6.1 channel decode flag is the information recorded in software like DVDs.
- b) Dolby Digital DVD that includes a Surround EX flag. The Dolby Corporation web page can help you distinguish Surround EX films.
- c) Software encoded with a flag to denote it has both Surround EX and 5.1 channel signals.
- d) Software encoded with both 5.1 channel signals and an extension stream designed for returning those signals to 6.1 discrete channels. Discrete 6.1 channel signals are DVD specific signals not used in movie theaters.
- e) When two surround back speakers are connected, the output channel will be 7.1 channels.
- f) This decoder can be used for all 6.1 formats (Dolby Digital EX, DTS-ES Matrix 6.1, DTS-ES Discrete 6.1).

Note

There may be no sound from the surround back speaker in Dolby Digital EX mode. Some discs have no Dolby Digital EX flag even though the packages have Dolby Digital EX logos. In this case, select “MATRIX”.

Advanced Adjustments and Settings

Assigning the audio input

— DIGITAL ASSIGN

You can assign a digital audio input for another input. This function is convenient in the following example.

When you have two DVD players and no digital audio input jack is available for the second DVD player.

Connect the first DVD player to the DVD COAXIAL IN jack on the receiver. You can connect the second DVD player to the TV/SAT OPTICAL IN jack and its analog audio/video output jacks to the VIDEO 2 AUDIO IN and VIDEO IN jacks on the receiver.

Then, assign the DVD COAXIAL's digital audio input to DVD (DVD-DVD) and the TV/SAT OPTICAL's digital audio input to VIDEO 2 (TV/SAT-VIDEO 2).

- 1** Press **MAIN MENU** repeatedly to select "**<CUSTOMIZE>**".
- 2** Press **<** or **>** repeatedly to select "**DIGITAL ASSIGN**".
- 3** Press **ENTER**.
- 4** Press **<** or **>** repeatedly to select the digital audio input you want to assign.
- 5** Turn **-/+** to select the input you want to assign the digital audio input jack selected in step 4.

The input you can assign varies for each audio input. For details, see "Selectable audio inputs for each input".

Tip

When you assign the SA-CD/CD digital audio input, only "SA-CD" appears in the display.

Selectable audio inputs for each input

VIDEO 3 OPT

VIDEO 3, VIDEO 1, VIDEO 2

DVD COAX

DVD, VIDEO 1, VIDEO 2

TV/SAT OPT

TV/SAT, VIDEO 1, VIDEO 2

SA-CD/CD COAX, SA-CD/CD OPT

SA-CD/CD, VIDEO 1, VIDEO 2

MD/TAPE OPT

MD/TAPE, VIDEO 1, VIDEO 2

Notes

- You cannot assign several audio inputs to the same input.
- You cannot use the audio input for the original input when it is assigned to another input.
- When you assign the audio input, the INPUT MODE setting may change automatically (page 35).
- You cannot assign for TUNER and PHONO.

Switching the audio input mode for digital components

— INPUT MODE

You can switch the audio input mode for components which have digital audio input jacks.

- 1** Turn **INPUT SELECTOR** to select the input.
- 2** Press **INPUT MODE** repeatedly to select the audio input mode.

The selected audio input mode appears in the display.

Audio input modes

- **AUTO 2CH**
Gives priority to digital signals when there are both digital and analog connections. If there are no digital signals, analog is selected.
- **COAX FIXED**
Specifies the digital audio signals input to the DIGITAL COAXIAL input jack.
- **OPT FIXED**
Specifies the digital audio signals input to the DIGITAL OPTICAL input jacks.
- **ANALOG FIXED**
Specifies the analog audio signals input to the AUDIO IN (L/R) jacks.

Notes

- When signals with a sampling frequency of more than 48 kHz is input, the equalizer and sound field cannot be used.
- You cannot select the digital audio input which is assigned to another function by DIGITAL ASSIGN function (page 34).

Customizing sound fields

By adjusting the LEVEL menu, you can customize the sound fields to suit your particular listening situation.

Note on the displayed items

The setup items you can adjust in each menu vary depending on the sound field. Certain setup parameters may be dimmed in the display. This means that the selected parameter is either unavailable or fixed and unchangeable.

Adjusting the LEVEL menu

You can adjust the balance and level of each speaker. These settings are applied to all sound fields except for effect level parameter. The effect level parameter settings are stored individually for each sound field.

- 1** Start playing a source encoded with multi channel surround effects (DVD, etc.).
- 2** Press **MAIN MENU** repeatedly to select “<LEVEL>”.
- 3** Press **<** or **>** repeatedly to select the parameter you want to adjust.
For details, see “LEVEL menu parameters” below.
- 4** While monitoring the sound, turn **-/+** to select the setting you want.
The setting is entered automatically.
- 5** Repeat steps 3 and 4 to adjust the other parameters.

LEVEL menu parameters

The initial setting is underlined.

■ **BALANCE L/R XX** (Front speaker balance)¹⁾

Initial setting: BALANCE (0)

Lets you adjust the balance between front left and right speakers. You can adjust in the range of BALANCE L (+1 to +8), BALANCE (0), BALANCE R (+1 to +8) in 17 steps.

■ **CENTER XXX.X dB**
(Center speaker level)¹⁾

■ **SURR L XXX.X dB**
(Surround speaker (Left) level)¹⁾

■ **SURR R XXX.X dB**
(Surround speaker (Right) level)¹⁾

■ **SB XXX.X dB**
(Surround back speaker level)¹⁾²⁾

■ **SB LEFT XXX.X dB**
(Surround back (Left) level)¹⁾³⁾

■ **SB RIGHT XXX.X dB**
(Surround back (Right) level)¹⁾³⁾

■ **SW XXX.X dB**
(Sub woofer level)¹⁾

Initial setting: 0 dB

You can adjust from -10 dB to +10 dB in 0.5 dB steps.

- ¹⁾ The parameters can be adjusted separately for MULTI CH IN 1 and 2.
- ²⁾ Only when the surround back speaker is set to "SINGLE" in the SET UP menu (page 19).
- ³⁾ Only when the surround back speaker is set to "DUAL" in the SET UP menu (page 19).

■ **COMP. XXX**
(Dynamic range compressor)

Lets you compress the dynamic range of the sound track. This may be useful when you want to watch movies at low volumes late at night.

• **OFF**

The dynamic range is not compressed.

• **STD**

The dynamic range is compressed as intended by the recording engineer.

• **MAX**

The dynamic range is compressed dramatically.

Tip

Dynamic range compressor lets you compress the dynamic range of the soundtrack based on the dynamic range information included in the Dolby Digital signal. We recommend using the "MAX" setting. This greatly compresses the dynamic range and lets you view movies late at night at low volumes. Unlike analog limiters, the levels are predetermined and provide a very natural compression.

Note

Dynamic range compression is possible with Dolby Digital sources only.

■ **EFFECT XXX (Effect level)**

Initial setting: STD

Lets you adjust the "presence" of the surround effect.

Resetting sound fields to the initial settings

Use the buttons on the receiver for the operation.

1 Press I/⏻ to turn off the power.

2 While holding down 2CH, press I/⏻.

"SF. INITIALIZE" appears in the display and all sound fields are reset to the initial setting.

Adjusting the equalizer

You can adjust the tonal quality (bass, treble level) of the front speakers using the EQUALIZER menu.

- 1 Start playing a source encoded with multi channel surround effects (DVD, etc.).**
- 2 Press MAIN MENU repeatedly to select “<EQUALIZER>”.**
- 3 Press < or > repeatedly to select the parameter you want to adjust.**
For details, see “EQUALIZER menu parameters” below.
- 4 While monitoring the sound, turn +/- to select the setting you want.**
The setting is entered automatically.
- 5 Repeat steps 3 and 4 to adjust the other items.**

Note

You cannot adjust the equalizer when the receiver is decoding signals with a sampling frequency of more than 48 kHz, or when DTS 96/24, DTS-ES Matrix or DTS Neo:6 decoding is applied.

EQUALIZER menu parameters

■ **BASS XXX.X dB**
(Front speaker bass level)

■ **TREBLE XXX.X dB**
(Front speaker treble level)

Initial setting: 0 dB

You can adjust from -10 dB to +10 dB in 0.5 dB steps.

■ **EQUALIZER XXX**

Initial setting: OFF

Select “ON” to activate the equalizer.

Note

The EQ indicator in the display lights up when the equalizer is turned on. When you adjust the equalizer using the EQUALIZER parameters, the settings are applied to all sound fields and can be reproduced whenever you turn on the equalizer.

Advanced settings

Using the CUSTOMIZE menu to adjust the receiver

You can adjust various receiver settings using the CUSTOMIZE menu.

- 1 Press MAIN MENU repeatedly to select “<CUSTOMIZE>”.**
- 2 Press < or > repeatedly to select the parameter you want to adjust.**
For details, see “CUSTOMIZE menu parameters” below.
- 3 Turn +/- to select the setting you want.**
The setting is entered automatically.
- 4 Repeat steps 2 and 3 to adjust the other items.**

CUSTOMIZE menu parameters

The initial settings are underlined.

■ **DTS 96/24 96/24 DEC XXXX**
(DTS 96/24 decoding mode)

• AUTO

When a DTS 96/24 signal is input, it is played back at 96 kHz sampling frequencies.

• OFF

Even when a DTS 96/24 signal is input, it is played back at 48 kHz sampling frequencies.

Notes

- This parameter is valid only in the A.F.D. mode (page 29). In other sound fields, this parameter is always set to “96/24 DEC OFF”.
- DTS 96/24 decoding is only valid in the A.F.D. mode (page 29). When the system is set to other sound fields, standard 48 kHz decoding is used.
- Even when a DTS 96/24 signal is input, standard 48 kHz decoding is used if any speakers are set to “SMALL” or if the sub woofer is set to “NO”.

■ SB DEC XXXXXX (Surround back decoding mode)

You can also use the SURR BACK DECODING to set the surround back decoding mode (page 32).

For details on each decoding mode, see page 33.

- OFF
- AUTO
- MATRIX

Note

This parameter is valid only in the A.F.D. mode (page 29).

■ DEC. PRI. XXXX (Digital audio input decoding priority)

Lets you specify the input mode for the digital signal input to the DIGITAL IN jacks.

The initial setting is “DEC. PRI. AUTO” for VIDEO 1, 2, 3 and TV/SAT, and “DEC. PRI. PCM” for DVD, MD/TAPE and SA-CD/CD.

- AUTO
Automatically switches the input mode between DTS, Dolby Digital, or PCM.
- PCM
PCM signals are given priority (to prevent the interruption when playback starts). Even when other signals are input, the sound is output. However, this receiver cannot decode DTS-CD when set to “DEC. PRI. PCM”.

Note

When set to “DEC. PRI. AUTO” and the sound from the digital audio jacks (for SA-CD/CD, etc.) is interrupted when playback starts, set to “DEC. PRI. PCM”.

■ POWER SAVE XXX (CONTROL A1II power save function)

- ON
Lets you save the power consumption of the receiver during standby mode when the power save function is activated.
- OFF
Lets you turn on the system automatically when the component connected via monaural mini-plug cords (page 42) is turned on.

■ DUAL MONO XXXX (Digital broadcast language selection)

Lets you select the language you want to listen to during digital broadcast. This feature only functions for Dolby Digital sources.

- M/S (Main/Sub)
Sound of the main language will be output through the front left speaker and sound of the sub language will be output through the front right speaker simultaneously.
- MAIN
Sound of the main language will be output.
- SUB
Sound of the sub language will be output.
- M+S (Main + Sub)
Mixed sound of both the main and sub languages will be output.

■ DIGITAL ASSIGN (Digital audio input assignment)

Lets you assign the digital audio input to other input. For details, see “Assigning the audio input” on page 34.

■ NAME IN (Naming preset stations and inputs)

Lets you set the name of preset stations and inputs selected with INPUT SELECTOR. For details, see “Naming preset stations and inputs” on page 39.

Naming preset stations and inputs

You can enter a name of up to 8 characters for preset stations and inputs selected with INPUT SELECTOR, and display it in the receiver's display.

1 To index a preset station

Turn INPUT SELECTOR to select the FM or AM band, then tune in the preset station you want to create an index name for (page 25).

To index an input

Turn INPUT SELECTOR to select the input you want to create an index name for.

2 Press MAIN MENU repeatedly to select "<CUSTOMIZE>".

3 Press < or > repeatedly to select "NAME IN".

4 Press ENTER.

The cursor flashes and you can select a character.

5 Use < or > and -/+ to create an index name.

Turn -/+ to select a character, then press > to move the cursor to the next position.

Tips

- You can select the character type as follows by turning -/+.
Alphabet (upper case) → Numbers → Symbols
- To enter a blank space, turn -/+ until a blank space appears in the display.
- If you made a mistake, press < or > repeatedly until the character you want to change flashes, then turn -/+ to select the correct character.

6 Press ENTER to store the index name.

Using the Sleep Timer

You can set the receiver to turn off automatically at a specified time. Use the remote for the operation.

1 Press ALT to light up the button.

2 Press SLEEP while the power is on.

Each time you press SLEEP, the display changes cyclically as follows:

2-00-00 → 1-30-00 → 1-00-00 →
0-30-00 → OFF

While using Sleep Timer, "SLEEP" lights up in the display.

Tip

To check the remaining time before the receiver turns off, press ALT to light up the button (page 45), then press SLEEP. The remaining time appears in the display. If you press SLEEP again, the sleep timer will be canceled.

Selecting the speaker system

You can select the front speaker system you want to use.

Press SPEAKERS (OFF/A/B/A+B) repeatedly to select the front speaker system you want to use.

The selected speaker system appears in the display. To turn off the speaker output, press SPEAKERS (OFF/A/B/A+B) repeatedly until “SP.A” and “SP.B” indication turn off.

The speaker system

- SP.A
The speakers connected to the SPEAKERS FRONT A terminals.
- SP.B
The speakers connected to the SPEAKERS FRONT B terminals.
- SP.A and SP.B
The speakers connected to both the SPEAKERS FRONT A and B terminals (parallel connection).

Recording

Before you begin, make sure you have connected all components properly.

Recording on an audio tape or MiniDisc

You can record on a cassette tape or MiniDisc using the receiver. See the operating instructions of your cassette deck or MD deck if you need help.

- 1 Select the component to be recorded.**
- 2 Prepare the component for playing.**
For example, insert a CD into the CD player.
- 3 Insert a blank tape or MD into the recording deck and adjust the recording level, if necessary.**
- 4 Start recording on the recording deck, then start playback on the playback component.**

Notes

- You cannot record a digital audio signal using a component connected to the analog MD/TAPE OUT jacks. To record a digital audio signal, connect a digital component to the DIGITAL OPTICAL MD/TAPE OUT jacks.
- Sound adjustments do not affect the signal output from the MD/TAPE OUT jacks.
- The analog audio signals of the current input is output from the MD/TAPE OUT jacks.
- The signals input to the MULTI CH IN 1 or 2 jacks are not output from the MD/TAPE OUT jacks even when MULTI CH IN 1 or 2 is being used. The analog audio signals of the current or previously used input are output.
- Some sources contain copy guards to prevent recording. In this case, you may not be able to record from the sources.

Recording on a video tape

You can record from a VCR, a TV or a DVD using the receiver. You can also add audio from a variety of audio sources when editing a video tape. See the operating instructions of your VCR or DVD player if you need help.

- 1** Select the program source to be recorded.
- 2** Prepare the component for playing.
For example, insert a video tape you want to record into VCR.
- 3** Insert a blank video tape into the VCR (VIDEO 1 or VIDEO 2) for recording.
- 4** Start recording on the recording VCR, then start playing the video tape or DVD you want to record.

Tip

You can record the sound from any audio source onto a video tape while copying from a video tape or DVD. Locate the point where you want to start recording from another audio source, select the program source, then start playback. The audio from that source will be recorded onto the audio track of the video tape instead of the audio from the original medium. To resume audio recording from the original medium, select the video source again.

Notes

- You cannot record a digital audio signal using a component connected to the analog VIDEO 1 AUDIO OUT or VIDEO 2 AUDIO OUT jacks.
- Make sure to make both digital and analog connections to the TV/SAT and DVD inputs. Analog recording is not possible if you make only digital connections.
- The analog audio signals of the current input are output from the VIDEO 1 AUDIO OUT or VIDEO 2 AUDIO OUT jacks.
- The signals input to the MULTI CH IN 1 or 2 jacks are not output from VIDEO 1 AUDIO OUT or VIDEO 2 AUDIO OUT jacks even when MULTI CH IN 1 or 2 is being used. The analog audio signals of the current or previously used input are output.

Listening to the sound in another zone

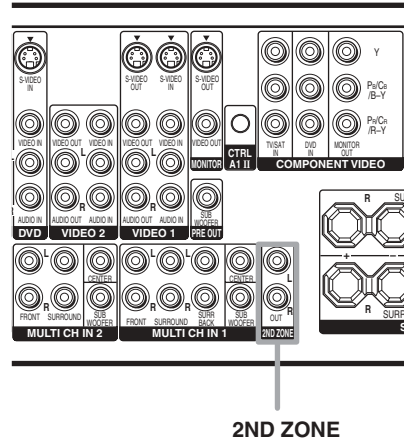

You can select analog audio signals for output to the 2nd zone.

Press 2ND ZONE repeatedly to select the analog audio signals for output to a stereo amplifier in another room.

Each time you press the button, the audio source changes cyclically as follows:

SOURCE*¹ → MD/TAPE → SA-CD/CD → TUNER*²

*¹ The audio signals of the current INPUT SELECTOR is output.

*² The audio signals of the last selected TUNER function (AM/FM) is output.

Tips

- Only signals from components connected to the analog input jacks are output through the 2ND ZONE OUT jacks. No signals are output from components connected to only the digital input jacks.
- When "SOURCE" is selected, the signals input to the MULTI CH IN 1 or 2 jacks are not output from the 2ND ZONE OUT jacks even when MULTI CH IN 1 or 2 is selected. The analog audio signals of the current function are output.

continued

2nd zone connections

Main receiver

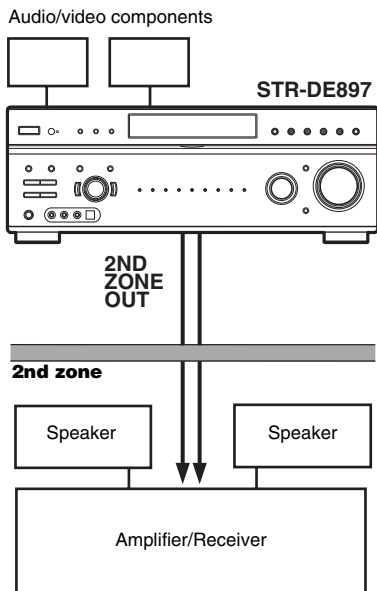

CONTROL A1II Control System

The CONTROL A1II Control System was designed to simplify the operation of audio systems composed of separate Sony components. CONTROL A1II connections provide a path for the transmission of control signals which enable automatic operation and control features usually associated with integrated systems.

Currently, CONTROL A1II connections between a Sony CD player, amplifier (receiver), MD deck and cassette deck provide automatic function selection.

Note

Do not operate a 2 way remote control unit when the CONTROL A1II jacks are connected via a PC interface kit to a personal computer running "MD Editor" or similar application. Also, do not operate the connected component in a manner contrary to the functions of the application, as this may cause the application to operate incorrectly.

CONTROL A1II and CONTROL A1 compatibility

The CONTROL A1 control system has been updated to the CONTROL A1II which is the standard system in the Sony 300 disc CD changer and other recent Sony components. Components with CONTROL A1 jacks are compatible with components with CONTROL A1II, and can be connected to each other. Basically, the majority of the functions available with the CONTROL A1 control system will be available with the CONTROL A1II control system.

However, when making connections between components with CONTROL A1 jacks and components with CONTROL A1II jacks, the number of functions that can be controlled may be limited depending on the component. For detailed information, refer to the operating instructions supplied with the component(s).

If you have a Sony CD changer with a COMMAND MODE selector

If your CD changer's COMMAND MODE selector can be set to CD 1, CD 2, or CD 3, be sure to set the command mode to "CD 1" and connect the changer to the CD jacks on the amplifier (receiver).

If, however, you have a Sony CD changer with VIDEO OUT jacks, set the command mode to “CD 2” and connect the changer to the VIDEO 2 jacks on the amplifier (receiver).

Connections

You can connect up to 10 CONTROL AIII compatible components in any order. However, you can connect only one of each type of component (i.e., 1 CD player, 1 MD deck, 1 tape deck and 1 receiver).

(You may be able to connect more than one CD player or MD deck, depending on the model. Refer to the operating instructions supplied with the respective component for details.)

Example

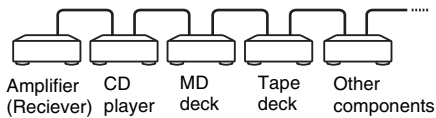

In the CONTROL AIII control system, the control signals flow both ways, so there is no distinction of IN and OUT jacks. If a component has more than one CONTROL AIII jack, you can use either one, or connect different components to each jack.

Some CONTROL A1 compatible components are supplied with a connecting cord as an accessory. In this case, use the connecting cord for your connection.

When using a commercially available cord, use a monaural mini-plug cord less than 2 meters long, with no resistance.

Basic Functions

The input selector on the receiver automatically switches to the correct input when you press the play button on one of the connected components (Auto input selection).

The CONTROL AIII functions will operate as long as the component you want to operate is turned on, even if all of the other connected components are not turned on.

Note

When recording, do not play any components other than the recording source. It will cause the automatic input selection to operate.

Operations Using the Remote RM-PG413

You can use the remote RM-PG413 to operate the components in your system.

Before you use your remote

Inserting batteries into the remote

Insert R6 (size-AA) batteries with the + and – properly oriented in the battery compartment. When using the remote, point it at the remote sensor  on the receiver.

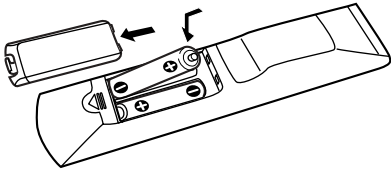

Tip

Under normal conditions, the batteries should last for about 6 months. When the remote no longer operates the receiver, replace all batteries with new ones.

Notes

- Do not leave the remote in an extremely hot or humid place.
- Do not use a new battery with an old one.
- Do not expose the remote sensor to direct sunlight or lighting apparatuses. Doing so may cause a malfunction.
- If you do not use the remote for an extended period of time, remove the batteries to avoid possible damage from battery leakage and corrosion.

Remote button description

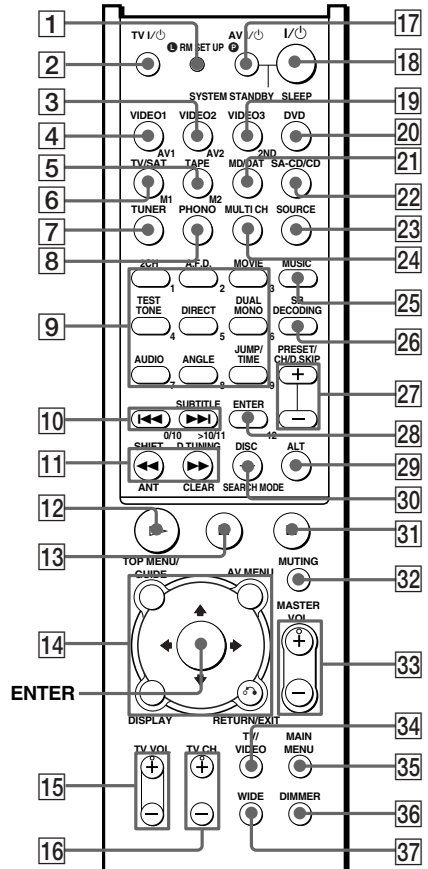

The tables below show the settings of each button.

Remote Button	Operations	Function
A.F.D. 9	Receiver	Selects the decoding mode for audio sound.



Remote Button	Operations	Function
ALT 29	Remote	When ALT button lights up, it changes remote key function to activate those buttons with orange printing.
ANGLE 9	DVD player	Selects viewing angle or changes the angles.
ANT 11	VCR	Selects output signal from the antenna terminal: TV signal or VCR program.
AUDIO 9	TV/VCR/ DVD player	Changes the sound to Multiplex, Bilingual or Multi channel TV Sound.
AV MENU 14	VCR/ Satellite tuner/ DVD player	Displays menu.
AV 1 4 and AV 2 3	Remote	Select the command mode of the remote.
AV I/⏻ 17	TV/VCR/ CD player/ VCD player/ LD player/ DVD player/ MD deck/ DAT deck	Turns the audio and video components on or off.
CLEAR 11	DVD player	Press if you make a mistake when you press the numeric button or press to return to continuous play etc.
DIMMER 36	Receiver	Adjusts the brightness of the display.
DIRECT 9	Receiver	Selects ANALOG DIRECT.
DISC 30	CD player/ VCD player	Selects a disc directly (multi-disc changer only).
DISPLAY 14	TV/VCR/ VCD player/ LD player/ DVD player	Selects information displayed on the TV screen.
D.TUNING 11	Receiver	Enters direct tuning mode.

Remote Button	Operations	Function
DUAL MONO 9	Receiver	Selects the language you want during digital broadcast.
DVD 20	Receiver	To watch DVD.
ENTER 14	Receiver/ VCR/ Satellite tuner/ DVD player	Enters the selection.
ENTER 28	TV/VCR/ Satellite tuner/ LD player/ MD deck/ DAT deck/ Tape deck	After selecting a channel, disc or track using the numeric buttons, press to enter the value.
JUMP/ TIME 9	Satellite tuner	Toggles between the previous and the current channels.
	CD player/ VCD player/ DVD player/ MD deck	Shows the time or displays the playing time of disc, etc.
MAIN MENU 35	Receiver	Selects the menu of the receiver.
MASTER VOL +/- 33	Receiver	Adjusts the master volume of the receiver.
MD/DAT 21	Receiver	To listen to Minidisc or DAT deck.
MOVIE 9	Receiver	Selects the pre-programmed sound fields for movie.
MULTI CH 24	Receiver	Selects MULTI CH IN 1/2 source.
MUSIC 25	Receiver	Selects the pre-programmed sound fields for music.
MUTING 32	Receiver	Mutes the sound from the receiver.
M1 6 and M2 5	Remote	To perform several commands in sequence automatically.
PHONO 8	Receiver	To listen to turntable.
PRESET/ CH/ D.SKIP +/- 27	Receiver TV/VCR/ Satellite tuner CD player/ VCD player/ DVD player/ MD deck	Selects preset stations. Selects preset channels. Skips discs (multi-disc changer only).

continued

Remote Button	Operations	Function
RETURN/ EXIT 14	VCD player/ LD player/ DVD player	Returns to the previous menu.
	Satellite tuner	Exits the menu.
RM SET UP 1	Remote	Set up the remote.
SA-CD/CD 22	Receiver	To listen to Super Audio CD or compact disc.
SB DECODING 26	Receiver	Selects the surround back decoding modes.
SEARCH MODE 30	DVD player	Selects searching mode. Press to select the unit for search (track, index, etc.)
SHIFT 11	Receiver	Selects a memory page for presetting radio stations or tuning to preset stations.
SLEEP 18	Receiver	Activates the sleep function and the duration which the receiver turns off automatically.
SOURCE 23	Remote	Selects 2ND ZONE output.
SUBTITLE 10	DVD player	Changes the subtitles.
SYSTEM STANDBY (Press AV I/⏻ 17 and I/⏻ 18 at the same time)	Receiver/ TV/VCR/ Satellite tuner/ CD player/ VCD player/ LD player/ DVD player/ MD deck/ DAT deck	Turns off the receiver and other Sony audio/video components.
TAPE 5	Receiver	To listen to audio tape.
TEST TONE 9	Receiver	Outputs test tone.
TOP MENU/ GUIDE 14	DVD player Satellite tuner	Displays DVD title. Displays guide menu.
TUNER 7	Receiver	To listen to radio programs.
TV CH +/- 16	TV	Selects preset TV channels.
TV/SAT 6	Receiver	To watch TV programs or satellite receiver.
TV/VIDEO 34	TV	Selects input signal: TV input or video input.

Remote Button	Operations	Function
TV VOL +/- 15	TV	Adjusts the volume of the TV.
TV I/⏻ 2	TV	Turns the TV on or off.
VIDEO1 4	Receiver	To watch VCR. (VTR mode 3)
VIDEO2 3	Receiver	To watch VCR. (VTR mode 1)
VIDEO3 19	Receiver	To watch VCR. (VTR mode 2)
WIDE 37	TV	Selects the wide picture mode.
I/⏻ 18	Receiver	Turns the receiver on or off.
2CH 9	Receiver	Selects 2CH STEREO mode.
⬆/⬇ 14	Receiver	Selects a menu item.
⬅/➡ 14	Receiver	Adjusts or changes the setting.
1-9 9 and 0/10 10	Receiver	Use with SHIFT to preset radio station or tuning to preset stations and with D.TUNING for direct tuning.
	CD player/ VCD player/ LD player/ MD deck/ DAT deck	Selects track numbers. 0/10 selects track 10.
	TV/VCR/ Satellite tuner	Selects channel numbers.
>10/11 10	CD player/ VCD player/ LD player/ MD deck	Selects track numbers over 10.
⏮/⏭ 10	VCR/ CD player/ VCD player/ DVD player/ LD player/ MD deck/ DAT deck/ Tape deck	Skips tracks.
⏮/⏭ 11	CD player/ VCD player/ DVD player/ LD player/ MD deck	Searches tracks in the forward or backward direction.
	VCR/ DAT deck/ Tape deck	Fastforwards or rewinds.

Remote Button	Operations	Function
 12	VCR/ CD player/ VCD player/ LD player/ DVD player/ MD deck/ DAT deck/ Tape deck	Starts playback.
II 13	VCR/ CD player/ VCD player/ LD player/ DVD player/ MD deck/ DAT deck/ Tape deck	Pauses playback or record. (Also start recording with components in record standby.)
■ 31	VCR/ CD player/ VCD player/ LD player/ DVD player/ MD deck/ DAT deck/ Tape deck	Stops playback.
 14	VCD player/ LD player/ DVD player	Returns to the previous entry mode, either one or two digit.
 14	VCR/ Satellite tuner/ DVD player	Selects a menu item.
-/-- 30	TV	Selects the channel entry mode, either one or two digit.
2ND 19	Remote	Selects the command mode of the remote.

Notes

- Some functions explained in this section may not work depending on the model.
- The above explanation is intended to serve as an example only. Therefore, depending on the component the above operation may not be possible or may operate differently than described.
- To activate the buttons with orange printing, press ALT first before pressing the buttons.
- When you press input buttons (VIDEO1, VIDEO2, VIDEO3 or DVD), the input mode of the TV might not switch to the corresponding input mode that you want. In this case, press TV/VIDEO button to switch the input mode of the TV.
- The 2ND button on the remote is not available for receiver operation.

Selecting the command mode of the remote

Set the remote command mode using the RM SET UP button and the remote command mode buttons.

Selecting the command mode

You can switch the command mode (AV1 and AV2) of the remote. If the command mode of the receiver and the remote is different, you cannot use the remote to operate the receiver.

Press AV1 or AV2 while holding down RM SET UP.

The indicator flashes once (twice for AV2) , then the command mode switches.

To check the command mode of the remote

Press RM SET UP. You can check the remote by the indicator.

Mode	Indicator flashes
AV1	once
AV2	twice

To reset the remote to factory settings

Press I/⏻, AV I/⏻ and MASTER VOL – at the same time.

The indicator flashes 3 times, then goes off.

Note

If the command mode of the receiver and the remote is different, you cannot use the remote to operate the receiver. To change the command mode of the receiver, see page 57.

Programming the remote

You can program the remote to control non-Sony components by changing the code. Once the control signals have been memorized, you can use those components as part of your system.

Furthermore, you can also program the remote for Sony components that the remote is unable to control. Note that the remote can only control components that accept infrared wireless control signals.

1 Press AV I/⏻ while holding down RM SET UP.

The indicator lights up.

2 Press the input button (including TV I/⏻) for the component you want to control.

For example, if you are going to control a CD player, press SA-CD/CD.

3 Press the numeric buttons to enter the numeric code (or one of the codes if more than one code exists) corresponding to the component and the maker of the component you want to control.

See the tables on pages 49–50 for information on the numeric code(s) corresponding to the component and the maker of the component (the first digit and the last two digits of the numeric code correspond to the category and the maker's code respectively.)

4 Press ENTER.

Once the numeric code has been verified, the indicator slowly flashes twice and the remote automatically exits the programming mode.

5 Repeat steps 1 to 4 to control other components.

To cancel programming

Press RM SET UP during any step. The remote automatically exits the programming mode.

To activate the input after programming

Press the programmed button to activate the input you want.

If programming is unsuccessful, check the following:

- If the indicator does not light up in step 1, the batteries are weak. Replace both batteries.
- If the indicator flashes 4 times in quick succession while entering the numeric code, an error has occurred. Start again from step 1.

Notes

- The indicator turns off while a valid button is pressed.
- In step 2, if several input buttons are pressed, only the last pressed button is valid.
- In step 2, if you press TV I/⏻, only TV VOL +/-, TV CH +/-, TV/VIDEO and WIDE buttons are reprogrammed.
- In step 3, if an input button is pressed, the new input is selected and the programming procedure returns to the beginning of step 3.
- For the numeric codes, only the first three numbers entered are valid.

To clear the memory of the remote

To clear all programmed and learned signals, do the following to reset the remote to factory settings.

Press I/⏻, AV I/⏻ and MASTER VOL – at the same time.

The indicator flashes 3 times, then goes off.

The numeric codes corresponding to the component and the maker of the component

Use the numeric codes in the tables below to control non-Sony components and also Sony components that the remote is normally unable to control. Since the remote signal that a component accepts differs depending on the model and year of the component, more than one numeric code may be assigned to a component. If you fail to program your remote using one of the codes, try using other codes.

Notes

- The numeric codes are based on the latest information available for each brand. There is a chance, however, that your component will not respond to some or all of the codes.
- All of the input buttons on this remote may not be available when used with your particular component.

To control a CD player

Maker	Code(s)
SONY	101, 102, 103
DENON	104, 123
JVC	105, 106, 107
KENWOOD	108, 109, 110
MAGNAVOX	111, 116
MARANTZ	116
ONKYO	112, 113, 114
PANASONIC	115
PHILIPS	116
PIONEER	117
TECHNICS	115, 118, 119
YAMAHA	120, 121, 122

To control a DAT deck

Maker	Code(s)
SONY	203
PIONEER	219

To control an MD deck

Maker	Code(s)
SONY	301
DENON	302
JVC	303
KENWOOD	304

To control a tape deck

Maker	Code(s)
SONY	201, 202
DENON	204, 205
KENWOOD	206, 207, 208, 209
NAKAMICHI	210
PANASONIC	216
PHILIPS	211, 212
PIONEER	213, 214
TECHNICS	215, 216
YAMAHA	217, 218

To control an LD player

Maker	Code(s)
SONY	601, 602, 603
PIONEER	606

To control a video CD player

Maker	Code(s)
SONY	605

To control a VCR

Maker	Code(s)
SONY	701, 702, 703, 704, 705, 706
AIWA*	710, 750, 757, 758
AKAI	707, 708, 709, 759
BLAUPUNKT	740
EMERSON	711, 712, 713, 714, 715, 716, 750
FISHER	717, 718, 719, 720
GENERAL ELECTRIC	721, 722, 730
GOLDSTAR	723, 753
GRUNDIG	724
HITACHI	722, 725, 729, 741
ITT/NOKIA	717
JVC	726, 727, 728, 736
MAGNAVOX	730, 731, 738
MITSUBISHI/MGA	732, 733, 734, 735
NEC	736
PANASONIC	729, 730, 737, 738, 739, 740
PHILIPS	729, 730, 731
PIONEER	729
RCA/PROSCAN	722, 729, 730, 731, 741, 747
SAMSUNG	742, 743, 744, 745
SANYO	717, 720, 746
SHARP	748, 749
TELEFUNKEN	751, 752
TOSHIBA	747, 755, 756
ZENITH	754

* If an AIWA VCR does not work even though you enter the code for AIWA, enter the code for Sony instead.

To control a DVD player

Maker	Code(s)
SONY	401, 402, 403
PANASONIC	406, 408
PHILIPS	407
PIONEER	409
TOSHIBA	404
DENON	405

To control a TV

Maker	Code(s)
SONY	501, 502
DAEWOO	504, 505, 506, 507, 515, 544
FISHER	508
GOLDSTAR	503, 511, 512, 515, 534, 544
GRUNDIG	517, 534
HITACHI	513, 514, 515, 544
ITT/NOKIA	521, 522
JVC	516
MAGNAVOX	503, 518, 544
MITSUBISHI/MGA	503, 519, 544
NEC	503, 520, 544
PANASONIC	509, 524
PHILIPS	515, 518
PIONEER	509, 525, 526, 540
RCA/PROSCAN	510, 527, 528, 529, 544
SAMSUNG	503, 515, 531, 532, 533, 534, 544
SANYO	508, 545, 546, 547
SHARP	535
TELEFUNKEN	523, 536, 537, 538
THOMSON	530, 537, 539
TOSHIBA	535, 540, 541
ZENITH	542, 543

To control a satellite tuner or cable box

Maker	Code(s)
SONY	801, 802, 803, 804
JERROLD/G.I.	806, 807, 808, 809, 810, 811, 812, 813, 814
PANASONIC	818
RCA	805, 819
S. ATLANTA	815, 816, 817

To control a tuner

Maker	Code(s)
SONY	002, 003, 004, 005

Learning the commands of your components

By using the Learning function, it is possible for this remote to perform learned commands.

Setting remote control codes that are not stored in the remote

When a remote control code is not one of the presets stored in the remote, it is possible for the remote to learn the code using the Learning function.

1 Press TV I/⏻ while holding down RM SET UP.

The indicator lights up.

2 Press the input button (including TV I/⏻) for the component you want to control.

For example, if you are going to learn an operation for a CD player, press SA-CD/CD.

3 Press the button you want to use for the Learning function.

The indicator turns off while a valid button is pressed, then flashes slowly.

4 Point the remote control code receiver section of the remote towards the receiver/transmitter on the remote control to be learned.

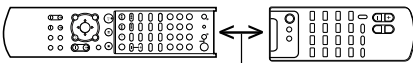

5–10 cm

5 Press the appropriate button on the remote control to be learned to send the remote button code.

Lightly pressing the button once should be sufficient.

If learning is completed successfully, the indicator slowly flashes twice and the remote automatically exits the learning mode.

When learning is not completed successfully, the indicator flashes 4 times in quick succession and the procedure returns to step 5.

If the memory of the remote is already full, the indicator flashes 8 times in quick succession and the remote automatically exits the learning mode.

Notes

- You can program more than 80 keys for the Learning function. In some cases, you may not be able to program even if you have not programmed 80 buttons. The number of buttons you can program for each input button are shown in the following table.

Input button area	Number of Buttons you can program
VIDEO 1, VIDEO 2, DVD	78 keys
VIDEO 3, TV/SAT, TAPE	78 keys
MD/DAT, SA-CD/CD, TUNER	78 keys
PHONO, MULTI CH	52 keys
TV buttons, (TV I/⏻, TV VOL +/-, TV CH +/-, WIDE, TV/VIDEO	7 keys

- In steps 2 and 3, the indicator turns off while a valid button is pressed.
- In step 3, if several buttons that can be used for learning are pressed, only the last pressed button is valid. The indicator flashes slowly, it turns on while a valid button is pressed.
- In step 5, if a button that can be used for learning is pressed, the new button is selected and the learning procedure returns to the beginning of step 5.

To activate the input after programming

Press the programmed button to activate the input you want.

To cancel learning

Press RM SET UP during any step. The remote automatically exits the learning mode.

To clear the learned codes

Start over from step 1. After step 3, press TV I/⏻ for more than 2 seconds. The indicator lights up twice slowly and the learned code is cleared. If TV I/⏻ is pressed less than 2 seconds, the learning procedure returns to the beginning of step 5.

When a learned code is cleared, if the button was previously programmed for another input selector, the programmed code for that button can be used.

To clear the memory of the remote

To clear all programmed and learned signals, do the following to reset the remote to factory settings.

Press I/⏻, AV I/⏻ and MASTER VOL – at the same time.

The indicator flashes 3 times, then goes off.

To use a command that has been learned

When selecting a learned input, press the learned button for that input.

Performing several commands in sequence automatically (Macro Play)

The Macro Play function lets you link several IR codes in a sequential order as a single command. The remote provides 2 macro lists (M1 and M2). You can specify up to 10 IR codes for each macro list.

Setting the sequence of IR codes

- 1 Press M1 (or M2) while holding down RM SET UP.**
The indicator lights up.
- 2 Press the numeric buttons to select the macro step number.**
For example, to program step 1, press 1. The indicator flashes slowly.
- 3 Point the remote control code receiver section of the remote towards the receiver/transmitter on the remote control to be learned.**
- 4 Press the appropriate button on the remote control to be learned to send the remote button code.**
Lightly pressing the button once should be sufficient.
If learning is completed successfully, the indicator slowly flashes twice and the remote automatically exits the learning mode.
When learning is not completed successfully, the indicator flashes 4 times in quick succession and the procedure returns to step 4.
- 5 Repeat steps 1 through 4 to program up to 10 IR codes.**

Tip

If programming is unsuccessful, check the following:

- If the indicator does not light up in step 1, the batteries are weak. Replace both batteries.
- If the indicator lights up 4 times in quick succession in step 3, an error has occurred. Start again from step 1.

To cancel programming

Press RM SET UP during any step. The remote automatically exits the macro setting mode.

To delay the output of an IR code

Start over from step 1. In step 3,

- Press M1 (TV/SAT) when the macro setting is M1.
- Press M2 (TAPE) when the macro setting is M2.

1 second delay is programmed at this program step. The indicator lights up twice slowly, then the remote automatically exits the macro setting mode.

To clear the programmed IR codes

Clear each macro step individually. In step 3,

- Press M1 (TV/SAT) when the macro setting is M1.
- Press M2 (TAPE) when the macro setting is M2.

The IR code is cleared. The indicator lights up twice slowly, then the remote automatically exits the macro setting mode.

To start macro play

Press M1 (TV/SAT) or M2 (TAPE) while the ALT indicator turns on.

Note

If the Macro Play function does not work properly, program a delay between each operation. See “To delay the output of an IR code”.

Additional Information

Precautions

On safety

Should any solid object or liquid fall into the cabinet, unplug the receiver and have it checked by qualified personnel before operating it any further.

On power sources

- Before operating the receiver, check that the operating voltage is identical with your local power supply. The operating voltage is indicated on the nameplate at the rear of the receiver.
- The receiver is not disconnected from the AC power source (mains) as long as it is connected to the wall outlet, even if the receiver itself has been turned off.
- If you are not going to use the receiver for a long time, be sure to disconnect the receiver from the wall outlet. To disconnect the AC power cord, grasp the plug itself; never pull the cord.
- (Models of area code U, CA only)
One blade of the plug is wider than the other for the purpose of safety and will fit into the wall outlet only one way. If you are unable to insert the plug fully into the outlet, contact your dealer.
- AC power cord must be changed only at the qualified service shop.

On heat buildup

Although the receiver heats up during operation, this is not a malfunction. If you continuously use this receiver at a large volume, the cabinet temperature of the top, side and bottom rises considerably. To avoid burning yourself, do not touch the cabinet.

On placement

- Place the receiver in a location with adequate ventilation to prevent heat buildup and prolong the life of the receiver.
- Do not place the receiver near heat sources, or in a place subject to direct sunlight, excessive dust or mechanical shock.
- Do not place anything on top of the cabinet that might block the ventilation holes and cause malfunctions.
- Use caution when placing the receiver on surfaces that have been specially treated (with wax, oil, polish, etc.) as staining or discoloration of the surface may result.

On operation

Before connecting other components, be sure to turn off and unplug the receiver.

On cleaning

Clean the cabinet, panel and controls with a soft cloth slightly moistened with a mild detergent solution. Do not use any type of abrasive pad, scouring powder or solvent such as alcohol or benzine.

If you have any question or problem concerning your receiver, please consult your nearest Sony dealer.

Troubleshooting

If you experience any of the following difficulties while using the receiver, use this troubleshooting guide to help you remedy the problem.

There is no sound or only a very low-level sound no matter which component is selected.

- Check that the speakers and components are connected securely.
- Check that both the receiver and all components are turned on.
- Check that you have selected the correct component on the receiver.
- Check that MASTER VOLUME $-/+$ is not set at “VOLUME MIN”.
- Check that the SPEAKERS (OFF/A/B/A+B) is not set to off (page 40).
- Check that the headphones are not connected.
- Press MUTING on the remote to cancel the muting function.

There is no sound from a specific component.

- Check that the component is connected correctly to the audio input jacks for that component.
- Check that the cord(s) used for the connection is (are) fully inserted into the jacks on both the receiver and the component.
- Check that you have selected the correct component on the receiver.

There is no sound from one of the front speakers.

- Connect a pair of headphones to the PHONES jack to verify that sound is output from the headphones. If only one channel is output from the headphones, the component may not be connected to the receiver correctly. Check that all the cords are fully inserted into the jacks on both the receiver and the component. If both channels are output from the headphones, the front speaker may not be connected to the receiver correctly. Check the connection of the front speaker which is not outputting any sound.

There is no sound from analog 2 channel sources.

- Check that the DIGITAL ASSIGN function is not used to assign the audio input of other input to the selected input (page 34).
- Check that the INPUT MODE is not set to “COAX FIXED” or “OPT FIXED” (page 35).
- Check that you have not selected MULTI CH IN 1 or 2.

There is no sound from digital sources (from COAXIAL or OPTICAL input jack).

- Check that the DIGITAL ASSIGN function is not used to assign the audio input of other input to the selected input (page 34).
- Check that the INPUT MODE is not set to “ANALOG FIXED” (page 35). Check that the INPUT MODE is not set to “COAX FIXED” for the sources from OPTICAL input jack, or set to “OPT FIXED” for the sources from COAXIAL input jack.
- Check that you have not selected MULTI CH IN 1 or 2.

The left and right sounds are unbalanced or reversed.

- Check that the speakers and components are connected correctly and securely.
- Adjust balance parameters in the LEVEL menu.

There is severe hum or noise.

- Check that the speakers and components are connected securely.
- Check that the connecting cords are away from a transformer or motor, and at least 3 meters (10 feet) away from a TV set or fluorescent light.
- Move your TV away from the audio components.
- Make sure you have grounded \hbar SIGNAL GND terminal (only when a turntable is connected).
- The plugs and jacks are dirty. Wipe them with a cloth slightly moistened with alcohol.

There is no sound from the surround back speakers.

- Some discs have no Dolby Digital EX flag even though the packages have Dolby Digital EX logos. In this case, select “MATRIX” (page 38).

There is no sound or only a very low-level sound is heard from the center/surround/surround back speakers.

- Make sure the sound field function is on (press A.F.D., MOVIE or MUSIC).
- Select a CINEMA STUDIO EX mode (page 30).
- Adjust the speaker level (page 21).
- Make sure the center/surround speakers size parameter are set to either “SMALL” or “LARGE” (pages 18 and 19).
- Make sure the surround back speakers selection is set to either “DUAL” or “SINGLE”.

There is no sound from the sub woofer.

- Check that the sub woofer is connected correctly and securely.
- Make sure the sub woofer selection parameter is set to “YES” (page 18).
- There is no sound output from the SUB WOOFER depending on the sound field.

The surround effect cannot be obtained.

- Make sure the sound field function is on (press A.F.D., MOVIE or MUSIC).
- Sound fields do not function for the signals with a sampling frequency of more than 48 kHz.

Dolby Digital or DTS multi channel sound is not reproduced.

- Check that the playing DVD, etc. is recorded in Dolby Digital or DTS format.
- When connecting the DVD player, etc. to the digital input jacks of this receiver, check the audio setting (settings for the audio output) of the connected component.

Recording cannot be done.

- Check that the components are connected correctly.
- Select the source component with INPUT SELECTOR.
- Make sure that INPUT MODE is set to “ANALOG FIXED” (page 35) before recording from a digital component connected to the analog MD/TAPE jacks.
- Make sure that INPUT MODE is set to “COAX FIXED” or “OPT FIXED” (page 35) before recording from a digital component connected to the DIGITAL OPTICAL MD/TAPE OUT jack.

The FM reception is poor.

- Use a 75-ohm coaxial cable (not supplied) to connect the receiver to an outdoor FM antenna as shown below. If you connect the receiver to an outdoor antenna, ground it against lightning. To prevent a gas explosion, do not connect the ground wire to a gas pipe.

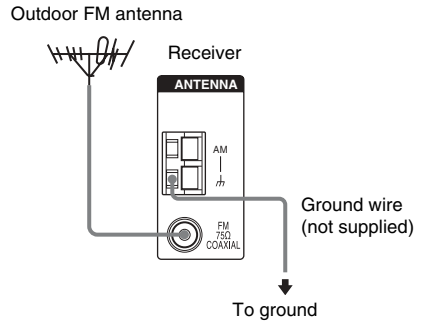

Radio stations cannot be tuned in.

- Check that the antennas are connected securely. Adjust the antennas and connect an external antenna if necessary.
- The signal strength of the stations is too weak (when tuning in with automatic tuning). Use direct tuning.
- Make sure you set the tuning interval correctly (when tuning in AM stations with direct tuning).
- No stations have been preset or the preset stations have been cleared (when tuning by scanning preset stations). Preset the stations (page 24).
- Press DISPLAY repeatedly so that the frequency appears in the display.

There is no picture or an unclear picture appears on the TV screen or monitor.



- Select the appropriate input on the receiver.
- Set your TV to the appropriate input mode.
- Move your TV away from the audio components.

The DIGITAL OPTICAL MD/TAPE OUT jack flashes red.

- When “AUTO 2CH” is selected for INPUT MODE, the jack flashes red when no digital audio signal is input. This depends on the INPUT MODE function, and is not a malfunction.

Remote control

The remote does not function.

- Point the remote at the remote sensor  on the receiver.
- Remove any obstacles in the path between the remote and the receiver.
- Replace all the batteries in the remote with new ones, if they are weak.
- Check if the command modes of the receiver and the remote is the same. If the command mode of the receiver and the remote is different, you cannot operate the receiver with the remote. To switch the command mode of the receiver, press I/⏻ to turn off the power. Then, press I/⏻ while pressing ENTER. Each time you press I/⏻, the command mode switches between “COM MODE AV2” and “COM MODE AV1”. (The initial setting is “COM MODE AV2”.)
- Make sure you select the correct input on the remote.
- To activate the buttons with orange printing, press ALT first before pressing the buttons.
- Before you use the  button for receiver operation, press MAIN MENU. To operate other components, press TOP MENU/GUIDE or AV MENU after pressing the input button.

Error messages

If there is a malfunction, the display shows a message. You can check the condition of the receiver by the message. Refer to the following table to solve the problem.

DECODE ERROR

Appears when the signal which the receiver cannot decode (ex. DTS-CD) is input when “DEC. PRI. XXXX” is set to “DEC. PRI. PCM”. Set to “DEC. PRI. AUTO”.

PROTECTOR

Irregular current is output from the speakers. The receiver will automatically turn off after a few seconds. Check the speaker connection and turn on the power again. If this problem persists, turn off the receiver and consult your nearest Sony dealer.

If you are unable to remedy the problem using the troubleshooting guide

Clearing the receiver’s memory may remedy the problem (page 17). However, note that all memorized settings will be reset to their factory settings and you will have to readjust all settings on the receiver.

If the problem persist

Consult your nearest Sony dealer.

Reference sections for clearing the receiver’s memory

To clear	See
All memorized settings	page 17
Customized sound fields	page 36

Specifications

AUDIO POWER SPECIFICATIONS

POWER OUTPUT AND TOTAL HARMONIC DISTORTION: (Models of area code U only)

With 8 ohm loads, both channels driven, from 20 – 20,000 Hz; rated 100 watts per channel minimum RMS power, with no more than 0.09% total harmonic distortion from 250 milliwatts to rated output.

Amplifier section

Power Output

Models of area code U, CA

Rated Power Output at Stereo Mode

(8 ohms 20 Hz – 20 kHz, THD 0.09%)
100 W + 100 W¹⁾

Reference Power Output¹⁾

(8 ohms 20 Hz – 20 kHz, THD 0.09%)

FRONT²⁾: 100 W/ch

CENTER²⁾: 100 W

SURR²⁾: 100 W/ch

SURR BACK²⁾: 100 W/ch

(8 ohms 1 kHz, THD 0.7%)

FRONT²⁾: 110 W/ch

CENTER²⁾: 110 W

SURR²⁾: 110 W/ch

SURR BACK²⁾: 110 W/ch

Models of area code E2/E3

Rated Power Output at Stereo Mode

(8 ohms 1 kHz, THD 0.7%)
110 W + 110 W¹⁾

Reference Power Output¹⁾

(8 ohms 1 kHz, THD 10%)

FRONT²⁾: 130 W/ch

CENTER²⁾: 130 W

SURR²⁾: 130 W/ch

SURR BACK²⁾: 130 W/ch

Models of area code AR

Rated Power Output at Stereo Mode

(8 ohms 1 kHz, THD 0.7%)
110 W + 110 W¹⁾
100 W + 100 W³⁾

Reference Power Output¹⁾

(8 ohms 1 kHz, THD 10%)

FRONT²⁾: 130 W/ch

CENTER²⁾: 130 W

SURR²⁾: 130 W/ch

SURR BACK²⁾: 130 W/ch

¹⁾ Measured under the following conditions:

Area code	Power requirements
U, CA	120 V AC, 60 Hz
E2/E3	240 V AC, 50 Hz
AR	230 V AC, 50 Hz

²⁾ Depending on the sound field settings and the source, there may be no sound output.

³⁾ Measured under the following conditions:

Area code	Power requirements
AR	220 V AC, 50 Hz

Frequency response

PHONO	RIAA equalization curve ±0.5 dB
MULTI CH IN 1, 2, SA-CD/CD, TV/SAT, MD/TAPE, DVD, VIDEO 1, 2, 3	10 Hz – 70 kHz +0.5/-2 dB (with sound field and equalizer bypassed)

Inputs (Analog)

PHONO	Sensitivity: 8 mV Impedance: 50 kilohms S/N ⁴⁾ : 86 dB (A, 8 mV ⁵⁾)
MULTI CH IN 1, 2, SA-CD/CD, TV/SAT, MD/TAPE, DVD, VIDEO 1, 2, 3	Sensitivity: 500 mV Impedance: 50 kilohms S/N ⁴⁾ : 96 dB (A, 500 mV ⁵⁾)

⁴⁾ INPUT SHORT (with sound field and equalizer bypassed).

⁵⁾ Weighted network, input level.

Inputs (Digital)

DVD, SA-CD/CD (Coaxial)	Sensitivity: – Impedance: 75 ohms S/N: 100 dB (A, 20 kHz LPF)
TV/SAT, SA-CD/CD, MD/TAPE, VIDEO 3 (Optical)	Sensitivity: – Impedance: – S/N: 100 dB (A, 20 kHz LPF)

Outputs (Analog)

MD/TAPE (OUT), VIDEO 1, 2 (AUDIO OUT)	Voltage: 500 mV Impedance: 10 kilohms
SUB WOOFER	Voltage: 2 V Impedance: 1 kilohms

Outputs (Digital)

MD/TAPE (Optical)	Sensitivity: –
Equalizer	
Gain levels	±10 dB, 0.5 dB step

FM tuner section

Tuning range	87.5 - 108.0 MHz
Antenna	FM wire antenna
Antenna terminals	75 ohms, unbalanced
Intermediate frequency	10.7 MHz
Sensitivity	
Mono:	18.3 dBf, 2.2 μV/75 ohms
Stereo:	38.3 dBf, 22.5 μV/75 ohms
Useable sensitivity	11.2 dBf, 1 μV/75 ohms
S/N	
Mono:	76 dB
Stereo:	70 dB
Harmonic distortion at 1 kHz	
Mono:	0.3%
Stereo:	0.5%
Separation	45 dB at 1 kHz
Frequency response	30 Hz – 15 kHz, +0.5/-2 dB
Selectivity	60 dB at 400 kHz

AM tuner section

Tuning range	
Models of area code U, CA	
With 10-kHz tuning scale:	530 – 1,710 kHz ⁶⁾
With 9-kHz tuning scale:	531 – 1,710 kHz ⁶⁾
Models of area code E2/E3	
With 10-kHz tuning scale:	530 – 1,610 kHz ⁶⁾
With 9-kHz tuning scale:	531 – 1,602 kHz ⁶⁾
Models of area code AR	
With 10-kHz tuning scale:	530 – 1,610 kHz
Antenna	Loop antenna
Intermediate frequency	450 kHz
Usable sensitivity	50 dB/m (at 1,000 kHz or 999 kHz)
S/N	54 dB (at 50 mV/m)
Harmonic distortion	0.5% (50 mV/m, 400 Hz)
Selectivity	
At 9 kHz:	35 dB
At 10 kHz:	40 dB

⁶⁾ You can change the AM tuning scale to 9 kHz or 10 kHz. After tuning in any AM station, turn off the receiver. While holding down PRESET TUNING + or TUNING +, press I/⏏. All preset stations will be erased when you change the tuning scale. To reset the scale to 10 kHz (or 9 kHz), repeat the procedure.

Video section

Inputs/Outputs	
Video:	1 Vp-p, 75 ohms
S-video:	Y: 1 Vp-p, 75 ohms C: 0.286 Vp-p, 75 ohms
COMPONENT VIDEO:	Y: 1 Vp-p, 75 ohms Pb/Cb/B-Y: 0.7 Vp-p, 75 ohms Pr/Cr/R-Y: 0.7 Vp-p, 75 ohms

80 MHz HD Pass Through

General

Power requirements

Area code	Power requirements
U, CA	120 V AC, 60 Hz
E2/E3	120/220/240 V AC, 50/60 Hz
AR	220–230 V AC, 50/60 Hz

Power consumption

Area code	Power consumption
U, E2/E3	300 W
CA	410 VA
AR	260 W

Power consumption (during standby mode)

0.3 W (when “POWER SAVE” in the CUSTOMIZE menu is set to “ON”) (page 38)

AC outlets

Area code	AC outlets
U, CA	2 switched, 120 W/1A MAX
E2/E3	1 switched, 100 W MAX

Dimensions (w/h/d) (Approx.)

430 × 157.5 × 371 mm
(16 7/8 × 6 2/8 × 14 5/8 inches) including projecting parts and controls

Mass (Approx.) 10.7 kg (23 lb 10 oz)

Supplied accessories

- FM wire antenna (1)
- AM loop antenna (1)
- Remote commander RM-PG413 (1)
- R6 (size-AA) batteries (2)

For details on the area code of the component you are using, see page 3.

Design and specifications are subject to change without notice.

Index

A

Adjusting

- CUSTOMIZE parameters 37
- EQUALIZER parameter 37
- LEVEL parameter 35
- SET UP parameters 18
- speaker level and balance 21

Automatic tuning 23

C

Changing

- display 25

Clearing receiver's memory 17

CUSTOMIZE menu 37

D

Digital Cinema Sound 30

Direct tuning 24

Dual Mono 38

Dubbing. *See* Recording

E

Editing. *See* Recording

EQUALIZER menu 37

I

Indexing. *See* Naming

L

Labeling. *See* Naming

LEVEL menu 35

N

Naming 39

P

Preset stations

- how to 24
- how to tune 25

R

Recording

- on a video tape 41
- on an audio tape or MD 40

S

Selecting

- component 22
- front speaker system 40
- sound field 30

SET UP menu 18

Sleep Timer 39

Sound field

- customizing 35
- pre-programmed 30
- resetting 36
- selecting 30

Speakers

- adjusting speaker level and balance 21
- connection 15
- placement 15

Supplied accessories 59

T

Test tone 21

Tuning

- automatically 23
- directly 24
- preset stations 24

