

Video Cassette Recorder

Operating Instructions

For customers in the USA

Many solutions to common problems and service information can be found at www.sony.com/vcrhelp or contact Sony VCR service at 1 (800) VHS-SONY.

To register your purchase of this product, visit:

www.sony.com/productregistration

For all other Sony product questions, please call **Sony Customer Information Services Company** at 1-800-222-SONY (7669).

For Customers in Canada

If this product is not working properly, please call 1-877-602-2008 for **Peace of Mind Warranty Replacement service**.

For other product related questions please contact our **Customer Information Service Centre** at 1-877-899-7669 or write to us at: Customer Information Service 115 Gordon Baker Road, Toronto, Ontario, M2H 3R6



SLV-N750
SLV-N650

WARNING

To prevent fire or shock hazard, do not expose the unit to rain or moisture.

To prevent fire or shock hazard, do not place objects filled with liquids, such as vases, on the apparatus.

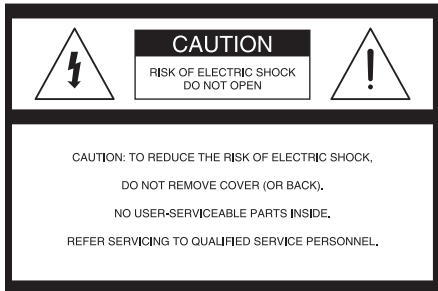

This symbol is intended to alert the user to the presence of uninsulated “dangerous voltage” within the product’s enclosure that may be of sufficient magnitude to constitute a risk of electric shock to persons.



This symbol is intended to alert the user to the presence of important operating and maintenance (servicing) instructions in the literature accompanying the appliance.

CAUTION:

TO PREVENT ELECTRIC SHOCK, MATCH WIDE BLADE OF PLUG TO WIDE SLOT, FULLY INSERT.

Precautions

Safety

- Operate the unit only on 120 V AC, 60 Hz.
- If anything falls into the cabinet, unplug the unit and have it checked by qualified personnel before operating it any further.
- This unit is not disconnected from the AC power source (mains) as long as it is connected to the wall outlet, even if the unit itself has been turned off.
- Unplug the unit from the wall outlet if you do not intend to use it for an extended period of time. To disconnect the cord, pull it out by the plug, never by the cord.
- One blade of the plug is wider than the other for the purpose of safety and will fit into the power outlet only one way. If you are unable to insert the plug fully into the outlet, contact your Sony dealer.

Installing

- Do not install the unit in a confined space such as a book or similar unit.
- Allow adequate air circulation to prevent internal heat buildup.
- Do not place the unit on surfaces (rugs, blankets, etc.) or near materials (curtains, draperies) that may block the ventilation slots.
- Do not install the unit near heat sources such as radiators or air ducts, or in a place subject to direct sunlight, excessive dust, mechanical vibration or shock.
- Do not install the unit in an inclined position. It is designed to be operated in a horizontal position only.
- Keep the unit and cassettes away from equipment with strong magnets, such as microwave ovens or large loudspeakers.
- Do not place heavy objects on the unit.
- If the unit is brought directly from a cold to a warm location, moisture may condense inside the VCR and cause damage to the video head and tape. When you first install the unit, or when you move it from a cold to a warm location, wait for about three hours before operating the unit.

Information

For customers in the USA

CAUTION

You are cautioned that any changes or modifications not expressly approved in this manual could void your authority to operate this equipment.

NOTE:

This equipment has been tested and found to comply with the limits for a Class B digital device, pursuant to Part 15 of the FCC Rules.

These limits are designed to provide reasonable protection against harmful interference in a residential installation.

This equipment generates, uses, and can radiate radio frequency energy and, if not installed and used in accordance with the instructions, may cause harmful interference to radio communications.

However, there is no guarantee that interference will not occur in a particular installation. If this equipment does cause harmful interference to radio or television reception, which can be determined by turning the equipment off and on, the user is encouraged to try to correct the interference by one or more of the following measures:

- Reorient or relocate the receiving antenna.
- Increase the separation between the equipment and receiver.
- Connect the equipment into an outlet on a circuit different from that to which the receiver is connected.
- Consult the dealer or an experienced radio/TV technician for help.

Owner's record

The model and serial numbers are located at the rear of the unit.

Record these numbers in the spaces provided below.

Refer to them whenever you call upon your Sony dealer regarding this product.

Model No. _____

Serial No. _____

Important Safeguards

For your protection, please read these safety instructions completely before operating the appliance, and keep this manual for future reference. Carefully observe all warnings, precautions and instructions on the appliance, or the one described in the operating instructions and adhere to them.

Use

Power sources

This set should be operated only from the type of power source indicated on the marking label. If you are not sure of the type of electrical power supplied to your home, consult your dealer or local power company. For those sets designed to operate from battery power, or other sources, refer to the operating instructions.



Grounding or Polarization

This set is equipped with a polarized ac power cord plug (a plug having one blade wider than the other), or with a three-wire grounding type plug (a plug having a third pin for grounding). Follow the instructions below:

For the set with a polarized ac power cord plug:

This plug will fit into the power outlet only one way. This is a safety feature. If you are unable to insert the plug fully into the outlet, try reversing the plug. If the plug should still fail to fit, contact your electrician to have a suitable outlet installed. Do not defeat the safety purpose of the polarized plug by forcing it in.



For the set with a three-wire grounding type ac plug:

This plug will only fit into a grounding-type power outlet. This is a safety feature. If you are unable to insert the plug into the outlet, contact your electrician to have a suitable outlet installed. Do not defeat the safety purpose of the grounding plug.

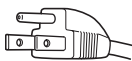

Overloading

Do not overload wall outlets, extension cords or convenience receptacles beyond their capacity, since this can result in fire or electric shock.

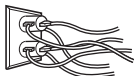

Object and Liquid Entry

Never push objects of any kind into the set through openings as they may touch dangerous voltage points or short out parts that could result in a fire or electric shock.



Never spill liquid of any kind on the set.

Attachments

Do not use attachments not recommended by the manufacturer, as they may cause hazards.



Cleaning

Unplug the set from the wall outlet before cleaning or polishing it. Do not use liquid cleaners or aerosol cleaners. Use a cloth lightly dampened with water for cleaning the exterior of the set.

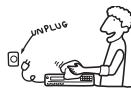

Installation

Water and Moisture

Do not use power-line operated sets near water - for example, near a bathtub, washbowl, kitchen sink, or laundry tub, in a wet basement, or near a swimming pool, etc.



Power-Cord Protection

Route the power cord so that it is not likely to be walked on or pinched by items placed upon or against them, paying particular attention to the plugs, receptacles, and the point where the cord exits from the appliance.



Accessories

Do not place the set on an unstable cart, stand, tripod, bracket, or table. The set may fall, causing serious injury to a child or an adult, and serious damage to the set. Use only a cart stand tripod, bracket, or table recommended by the manufacturer.



An appliance and cart combination should be moved with care. Quick stops, excessive force, and uneven surfaces may cause the appliance and cart combination to overturn.



S3125A

Ventilation

The slots and openings in the cabinet are provided for necessary ventilation. To ensure reliable operation of the set, and to protect it from overheating, these slots and openings must never be blocked or covered.

- Never cover the slots and openings with a cloth or other materials.

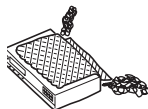

- Never block the slots and openings by placing the set on a bed, sofa, rug or other similar surface.



- Never place the set in a confined space, such as a bookcase, or built-in cabinet, unless proper ventilation is provided.
- Do not place the set near or over a radiator or heat register, or where it is exposed to direct sunlight.



Antennas

Outdoor antenna grounding

If an outdoor antenna or cable system is installed, follow the precautions below.

An outdoor antenna system should not be located in the vicinity of overhead power lines or other electric light or power circuits, or where it can come in contact with such power lines or circuits.

WHEN INSTALLING AN OUTDOOR ANTENNA SYSTEM, EXTREME CARE SHOULD BE TAKEN TO KEEP FROM CONTACTING SUCH POWER LINES OR CIRCUITS AS CONTACT WITH THEM IS ALMOST INVARIABLY FATAL.

Be sure the antenna system is grounded so as to provide some protection against voltage surges and built-up static charges. Section 810 of the National Electrical Code provides information with respect to proper grounding of the mast and supporting structure, grounding of the lead-in wire to an antenna discharge unit, size of grounding conductors, location of antenna-discharge unit, connection to grounding electrodes, and requirements for the grounding electrode.

Antenna Grounding According to the National Electrical Code

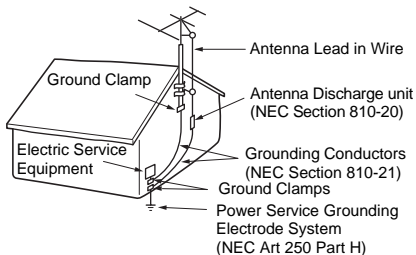

NEC-NATIONAL ELECTRICAL CODE







Lightning

For added protection for this set during a lightning storm, or when it is left unattended and unused for long periods of time, unplug it from the wall outlet and disconnect the antenna or cable system. This will prevent damage to the set due to lightning and power-line surges.

Service

Damage Requiring Service

Unplug the set from the wall outlet and refer servicing to qualified service personnel under the following conditions:

- When the power cord or plug is damaged or frayed.
 -  FRAYED OR TAUT A.C. LINE
 -  CRACKED PLUG
- If liquid has been spilled or objects have fallen into the set.
 - 
- If the set has been exposed to rain or water.
 - 
- If the set has been subject to excessive shock by being dropped, or the cabinet has been damaged.
 - 
- If the set does not operate normally when following the operating instructions. Adjust only those controls that are specified in the operating instructions. Improper adjustment of other controls may result in damage and will often require extensive work by a qualified technician to restore the set to normal operation.
 - 
- When the set exhibits a distinct change in performance - this indicates a need for service.

Servicing

Do not attempt to service the set yourself as opening or removing covers may expose you to dangerous voltage or other hazards.



Refer all servicing to qualified service personnel.

Replacement parts

When replacement parts are required, be sure the service technician has used replacement parts specified by the manufacturer that have the same characteristics as the original parts. Unauthorized substitutions may result in fire, electric shock, or other hazards.

Safety Check

Upon completion of any service or repairs to the set, ask the service technician to perform routine safety checks (as specified by the manufacturer) to determine that the set is in safe operating condition.



Table of contents

Getting Started

- 7 Step 1 : Unpacking
 - 8 Step 2 : Setting up the remote commander
 - 11 Step 3 : Hookups
 - 18 Step 4 : Selecting a language
 - 19 Step 5 : Setting the clock
 - 24 Step 6 : Presetting channels
-

Basic Operations

- 28 Playing a tape
- 31 Recording TV programs
- 34 Setting the timer
- 37 Locking the VCR (Child Lock)

Additional Operations

- 38 Playing/searching at various speeds
- 40 Quick Timer Recording
- 41 Checking/changing/canceling timer settings
- 43 Recording stereo and bilingual programs

- 44 Searching using various functions
- 46 Adjusting the picture (tracking)
- 47 Changing menu options
- 49 Editing with another VCR

Additional Information

- 51 Antenna information
- 52 Troubleshooting
- 54 Specifications
- 55 Index to parts and controls
- 60 Index

Back Cover

Quick reference to using the VCR

Caution

Television programs, films, video tapes and other materials may be copyrighted. Unauthorized recording of such material may be contrary to the provisions of the copyright laws. Also, use of this recorder with cable television transmission may require authorization from the cable television transmission and/or program owner.

Step 1 : Unpacking

Check that you have received the following items with the VCR:

- Remote commander

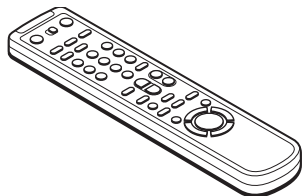

- Size AA (R6) batteries

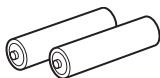

- 75-ohm coaxial cable with F-type connectors

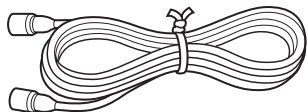

Note

- The supplied remote commander is for the exclusive use of this VCR.

Check your model name

The instructions in this manual are for the 2 models: SLV-N750 and SLV-N650. Check your model name by looking at the rear panel of your VCR. SLV-N750 is the model used for illustration purposes.

Step 2 : Setting up the remote commander

Inserting the batteries

Insert two size AA (R6) batteries by matching the + and - on the batteries to the diagram inside the battery compartment.

Insert the negative (-) end first, then push in and down until the positive (+) end clicks into position.

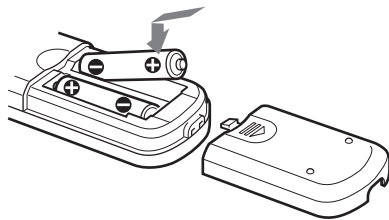

Using the remote commander

You can use this remote commander to operate this VCR and a Sony TV. Buttons on the remote commander marked with a dot (•) can be used to operate your Sony TV.

If the TV does not have the  symbol near the remote sensor, this remote commander will not operate the TV.

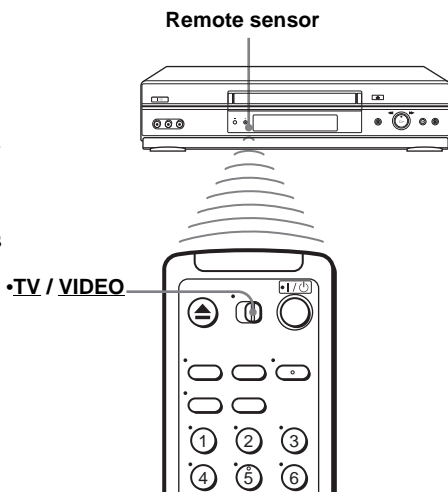

To operate	Set •TV / VIDEO to
the VCR	<u>VIDEO</u> and point at the remote sensor at the VCR
a Sony TV	•TV and point at the remote sensor at the TV

Notes

- With normal use, the batteries should last about three to six months.
- If you do not use the remote commander for an extended period of time, remove the batteries to avoid possible damage from battery leakage.
- Do not use a new battery with an old one.
- Do not use different types of batteries.
- Do not leave the remote commander in an extremely hot or humid place.
- Do not drop any foreign object into the remote casing, particularly when replacing the batteries.
- Do not expose the remote sensor to direct light from the sun or lighting apparatus. Doing so may cause a malfunction.

Controlling other TVs with the remote commander

The remote commander is preprogrammed to control non-Sony TVs. If your TV is listed in the following table, set the appropriate manufacturer's code number.

- 1** Set **•TV / VIDEO** at the top of the remote commander to **•TV**.
- 2** Hold down **I/⏻**, and enter your TV's code number using the number buttons. Then release **I/⏻**.

Now you can use the **I/⏻**, **VOL +/-**, **CH +/-**, and **TV/VIDEO** buttons to control your TV. You can also use the buttons marked with a dot (•) to control a Sony TV. To control the VCR, reset **•TV / VIDEO** to **VIDEO**.

continued

Code numbers of controllable TVs

If more than one code number is listed, try entering them one at a time until you find the one that works with your TV.

TV brand	Code number
Sony	01
Akai	04
AOC	04
Centurion	12
Coronado	03
Curtis-Mathes	12
Daytron	12
Emerson	03, 04, 14
Fisher	11
General Electric	06, 10
Hitachi	02, 03
J.C.Penney	04, 12
JVC	09
KMC	03
LG/Gold Star	03, 04, 17
Magnavox	03, 08, 12
Marantz	04, 13
MGA/Mitsubishi	04, 12, 13, 17
NEC	04, 12

TV brand	Code number
Panasonic	06, 19
Philco	03, 04
Philips	08
Pioneer	16
Portland	03
Quasar	06, 18
Radio Shack	05, 14
RCA	04, 10
Sampo	12
Sanyo	11
Scott	12
Sears	07, 10, 11
Sharp	03, 05, 18
Sylvania	08, 12
Teknika	03, 08, 14
Toshiba	07
Wards	03, 04, 12
Yorx	12
Zenith	15

Notes

- If you enter a new code number, the code number previously entered will be erased.
- If the TV uses a different remote control system from the one programmed to work with the VCR, you cannot control your TV with the remote commander.
- When you replace the batteries of the remote commander, the code number may change. Set the appropriate code number every time you replace the batteries.
- When you press the AUDIO MONITOR button, your TV's menu may appear on the TV screen. To exit the TV menu, press the MENU button on the TV remote commander or wait until the menu disappears automatically.

Step 3 : Hookups

Selecting the best hookup option

There are many ways in which your VCR can be hooked up. To hook up your VCR so that it works best for you, first scan through the table below. Then use the accompanying diagrams and procedures on the following pages to set up your VCR.

If your TV has audio/video inputs, refer to page 12 for audio/video (A/V) hookup. Then follow one of the hookups below. If your TV does not have A/V inputs, perform directly one of the hookups below.

If you have	Use	Refer to
Antenna only, no cable TV	Hookup 1 (Plug and Play)	Pages 13 and 14
No cable box or cable box with only a few scrambled channels	Hookup 2 (Plug and Play)	Pages 15 and 16
Cable box with many scrambled channels	Hookup 3	Page 17

After you have completed the connections, follow the instructions for setup.

After you have completed the setup, you are ready to use your VCR. Procedures differ depending on the hookup you used. For an overview, refer to “Quick reference to using the VCR” on the back cover.

Before you get started

- Turn off the power to all equipment.
- Do not connect the AC power cords until all of the connections are completed. If you connect the AC power cord before the connections are completed, you may not be able to use the Plug and Play function.
- Be sure you make connections firmly. Loose connections may cause picture distortion.
- If your TV does not match any of the examples provided, see your nearest Sony dealer or qualified technician.

Caution

Connections between the VCR’s VHF/UHF connector and the antenna terminals of the TV receiver should be made only as shown in the following instructions. Failure to do so may result in operation that violates the regulations of the Federal Communications Commission regarding the use and operation of RF devices. Never connect the output of the VCR to an antenna or make simultaneous (parallel) antenna and VCR connections at the antenna terminals of your receiver.

Note to CATV system installer (in USA)

This reminder is provided to call the CATV system installer’s attention to Article 820- 40 of the NEC that provides guidelines for proper grounding and, in particular, specifies that the cable ground shall be connected to the grounding system of the building, as close to the point of cable entry as practical.

Audio/video (A/V) hookup

If your TV has audio/video (A/V) input jacks, you will get a better picture and sound if you hook up your VCR using these connections. For a true “home theater” experience, you should connect the audio outputs of your VCR or TV to your stereo system. If your TV does not have A/V inputs, see the following pages for antenna or cable hookups.

If you are not planning to use your VCR to record programs, you finished setting up the VCR after you have made the connections shown on this page. If you want to record regular or cable TV programs, complete these connections first, and then go to the following pages for antenna or cable hookups.

A Use this hookup if your TV has stereo jacks

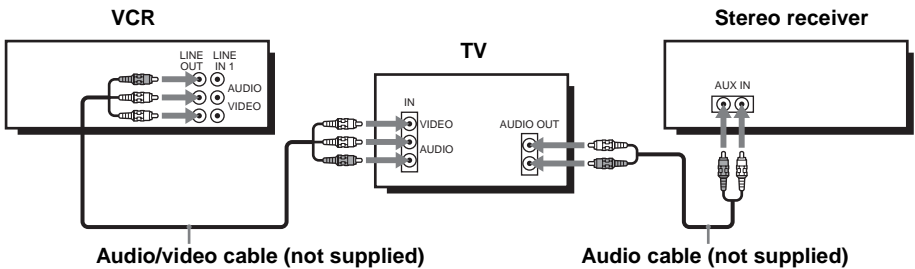

B Use this hookup if your TV does not have stereo jacks

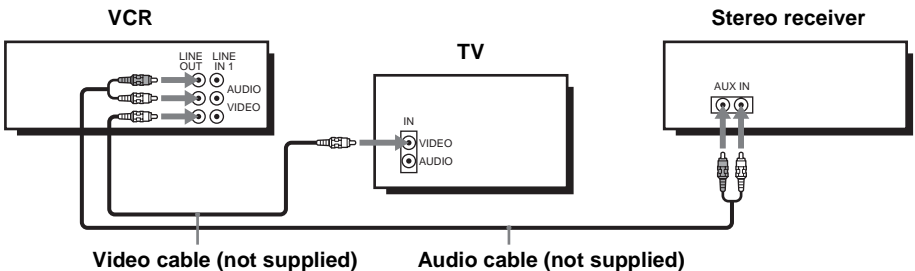

Notes

- To play a tape in stereo, you must use the A/V connection.
- If you do not have a stereo receiver, connect the white LINE OUT/AUDIO L jack to the AUDIO IN jack on your TV.

Hookup 1 (Plug and Play)

Antenna hookup

Make the following connections if you are using an antenna (if you do not have cable TV).

A Use this hookup if you are using:

- VHF/UHF antenna (you get channels 2–13 and channels 14 and higher)
- UHF-only antenna (you get channels 14 and higher)
- Separate VHF and UHF antennas

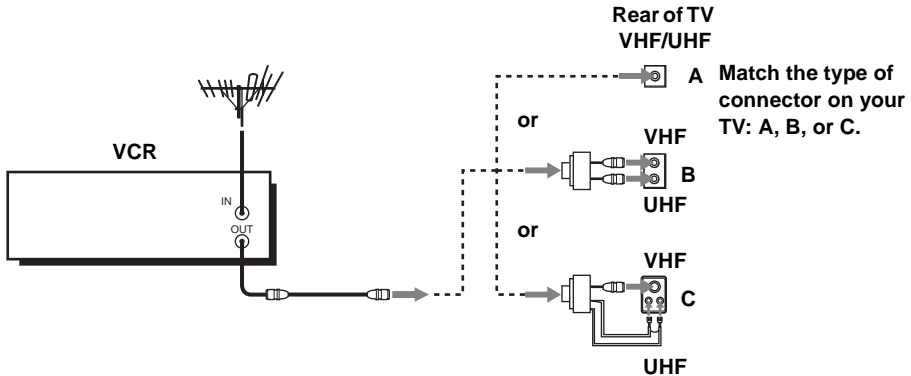

B Use this hookup if you are using a VHF-only antenna (you get channels 2–13 only)

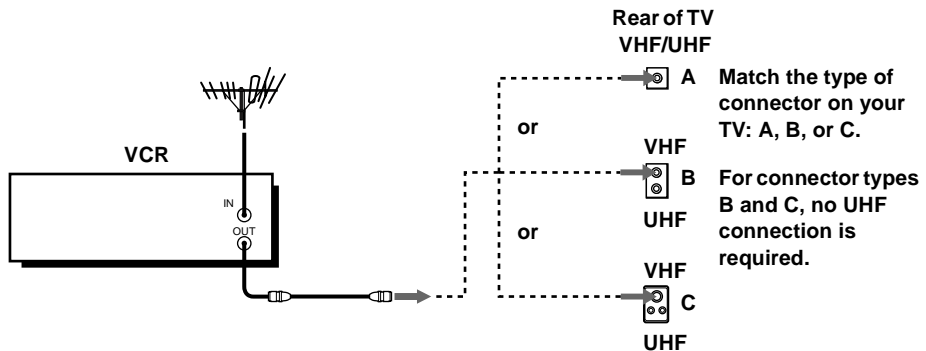

If you cannot connect your antenna cable to the VCR directly

If your antenna cable is a flat cable (300-ohm twin lead cable), attach an external antenna connector (not supplied) so you can connect the cable to the RF IN connector. If you have separate cables for VHF and UHF antennas, you should use a U/V band mixer (not supplied) (page 51).

Hookup 1 : VCR setup

Plug the VCR into the AC outlet.

The VCR automatically presets the VCR's clock and TV channels when the VCR is plugged into the AC outlet.

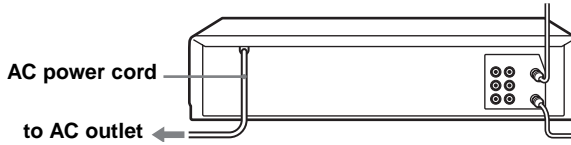

The VCR starts presetting the clock and channels.



When Auto preset is completed, the current time appears in the display window.



You have now completed VCR setup.

To change the on-screen display language to French or Spanish, see "Step 4 : Selecting a language" on page 18.

The clock is set using a time signal provided by some TV channels. If the clock is incorrect, or "--:--" appears in the display window, see "Using Manual Clock Set" on page 22.

To add or disable channels manually, see "Presetting/disabling channels manually" on page 26.

Notes

- If you connect the AC power cord before the antenna connections are completed, the channels may be incorrectly set. If this happens, see "Step 6 : Presetting channels" on page 24.
- Do not press any buttons on the VCR or remote commander during Auto preset.
- Auto preset starts automatically only when you plug in the AC power cord for the first time after you purchase the VCR.
- Auto preset can be performed by pressing **■ STOP on the VCR** continuously for 5 seconds or more with the VCR power turned off.

Hookup 2 (Plug and Play)

You have no cable box, or a cable box with only a few scrambled channels

Recommended use

Use this hookup if you do not have a cable box. Also use this hookup if your cable system scrambles only a few channels.

What you can do with this hookup

- Record any unscrambled channel by selecting the channel on the VCR

What you cannot do

- Record scrambled channels that require a cable box

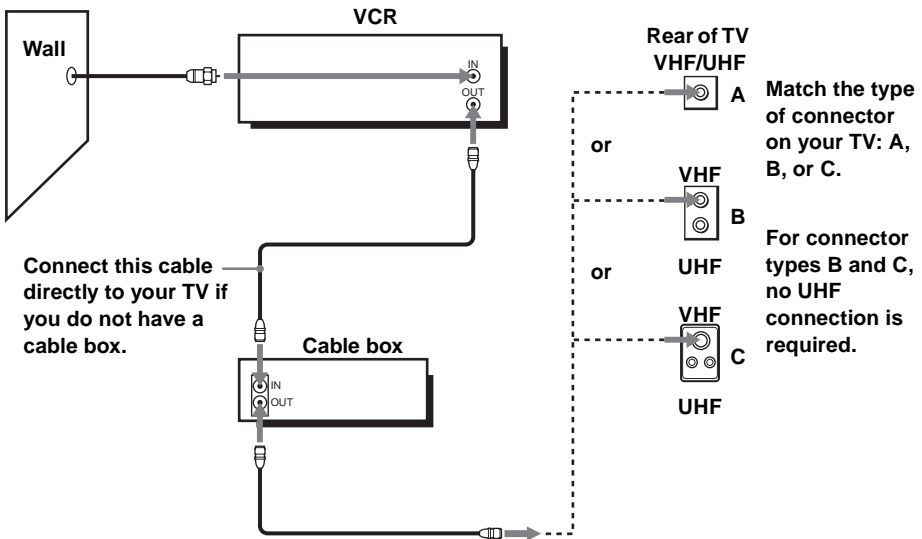

Hookup 2 : VCR setup

Plug the VCR into the AC outlet.

The VCR automatically presets the VCR's clock and TV channels when the VCR is plugged into the AC outlet.

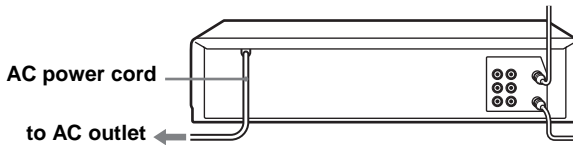

The VCR starts presetting the clock and channels.



When Auto preset is completed, the current time appears in the display window.



You have now completed VCR setup.

To change the on-screen display language to French or Spanish, see "Step 4 : Selecting a language" on page 18.

The clock is set using a time signal provided by some TV channels. If the clock is incorrect, or "--:--" appears in the display window, see "Using Manual Clock Set" on page 22.

To add or disable channels manually, see "Presetting/disabling channels manually" on page 26.

Notes

- If you connect the AC power cord before the antenna connections are completed, the channels may be incorrectly set. If this happens, see "Step 6 : Presetting channels" on page 24.
- Do not press any buttons on the VCR or remote commander during Auto preset.
- Auto preset starts automatically only when you plug in the AC power cord for the first time after you purchase the VCR.
- Auto preset can be performed by pressing **■ STOP on the VCR** continuously for 5 seconds or more with the VCR power turned off.

Hookup 3

Connecting a cable box with many scrambled channels

Recommended use

Use this hookup if your cable system scrambles all or most channels.

What you can do with this hookup

- Record any channel by selecting the channel on the cable box

What you cannot do

- Record with the cable box turned off
- Record one channel while watching another channel

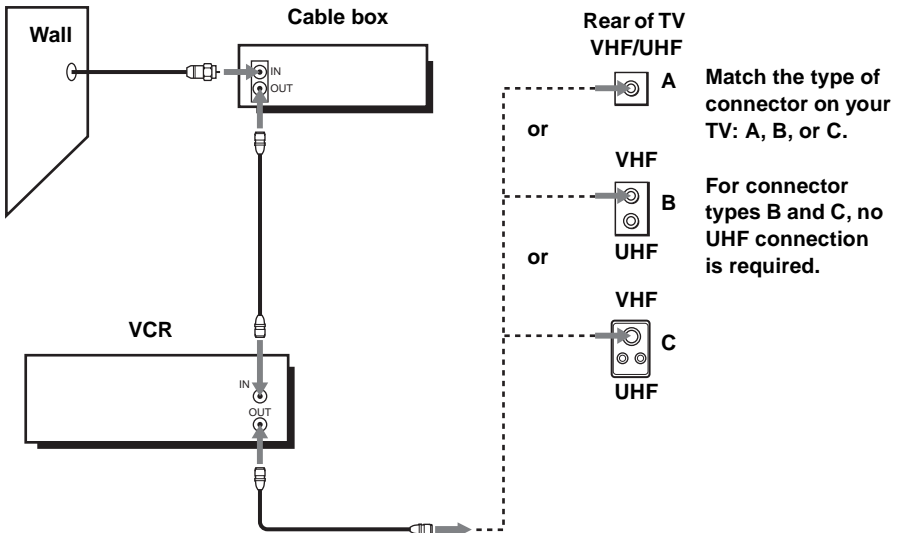

After you have completed hookup...

After you have completed hookup, plug the VCR into the AC outlet and see “Step 4 : Selecting a language” on page 18.

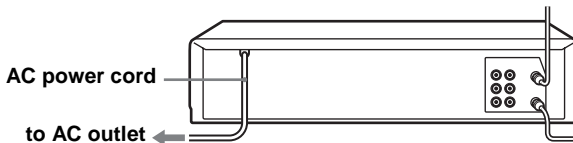

Step 4 : Selecting a language

You can change the on-screen display language.

Before you start...

- Turn on the VCR and the TV.
- Set the “VCR Output CH” to “3CH” or “4CH” in ADVANCED OPTIONS menu (page 47). If both are used, set the “VCR Output CH” to either channel. If your TV is connected to the VCR using A/V connections, set the TV to video input.
- Press TV/VIDEO to display the VCR indicator in the VCR’s display window.

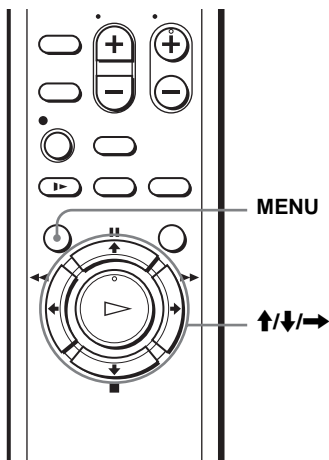

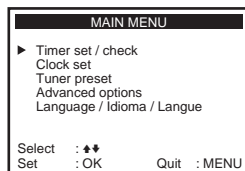

1  Press MENU.

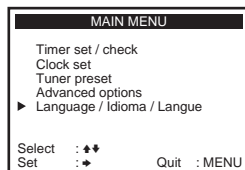

2  Press **↑/↓** to move the cursor (▶) to “Language/Idioma/Langue.”



3  Press **→** to select the desired language, French or Spanish.

4  Press MENU to exit the menu.

Step 5 : Setting the clock

Using the Auto Clock Set feature

Some TV and cable channels transmit time signals with their broadcasts. Your VCR can pick up this time signal to automatically set the clock.

The Auto Clock Set feature works only if a channel in your area is broadcasting a time signal. If broadcasters in your area are not yet sending time signals, set the time manually (page 22).

Before you start...

- Turn on the VCR and the TV. When using a cable box, turn it on.
- Set the “VCR Output CH” to “3CH” or “4CH” in ADVANCED OPTIONS menu (page 47). If both are used, set the “VCR Output CH” to either channel. If your TV is connected to the VCR using A/V connections, set the TV to video input.
- Press TV/VIDEO to display the VCR indicator in the VCR’s display window.

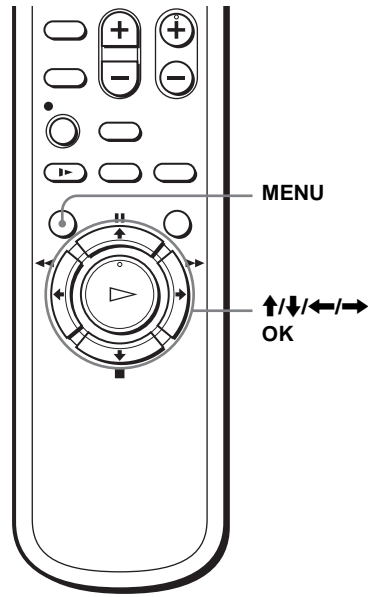

1  Press MENU.

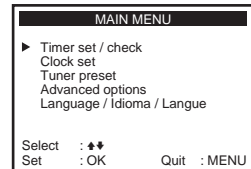

2  Press \uparrow/\downarrow to move the cursor (\blacktriangleright) to “Clock set,” then press OK.

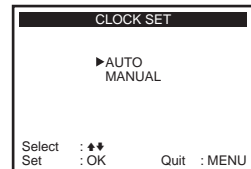

continued

3



Press **↑/↓** to select AUTO, then press OK.

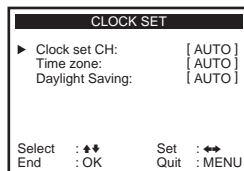

4



Press **↑/↓** to select the item you want. Then press **←/→** to make the setting and press OK.

- For “Clock set CH”
Leave the setting to AUTO to have the VCR automatically search for a channel that carries a time signal. Press **←/→** to select a channel that carries a time signal. Use this option if you know of a channel that carries a time signal. Most PBS member stations broadcast a time signal. For the fastest response, select your local PBS station.

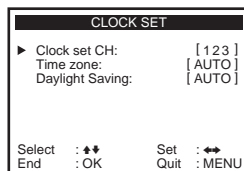

- For “Time zone”
Select the time zone of your area, or select AUTO to have the VCR automatically set your time zone.
The options are:
AUTO ↔ Atl. (Atlantic) ↔ East (Eastern)
↔ Cen. (Central) ↔ Mtn. (Mountain) ↔
Pac. (Pacific) ↔ Alas (Alaska) ↔
Haw. (Hawaii) ↔ AUTO

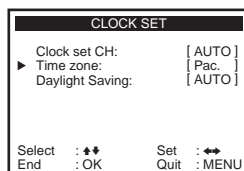

- For “Daylight Saving”
Select YES or NO (standard time), or AUTO to have the VCR automatically set the daylight saving time.

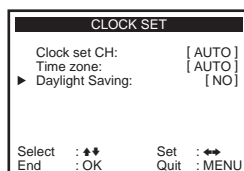

5



Press MENU to exit the menu.

6

To activate the Auto Clock Set function, turn off the VCR.

Notes

- The clock cannot be set automatically if you do not receive a channel that carries a time signal in your area. If so, set the clock manually (page 22).
- If there are only a few channels in your area that carry time signals, setting the clock automatically may take up to about 20 minutes. If nothing happens even after you wait about 20 minutes, set the clock manually (page 22).
- If you made Hookup 3, make sure you leave the cable box on.

Using Manual Clock Set

Before you start...

- Turn on the VCR and the TV.
- Set the “VCR Output CH” to “3CH” or “4CH” in ADVANCED OPTIONS menu (page 47). If both are used, set the “VCR Output CH” to either channel. If your TV is connected to the VCR using A/V connections, set the TV to video input.
- Press TV/VIDEO to display the VCR indicator in the VCR’s display window.

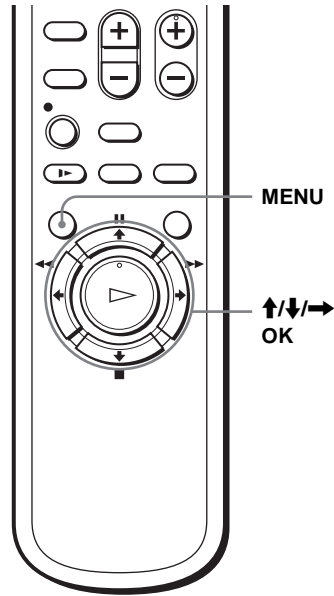

1  Press MENU.

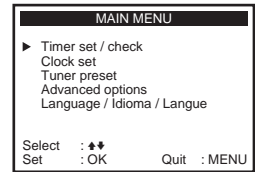

2  Press **↑/↓** to move the cursor (▶) to “Clock set,” then press OK.

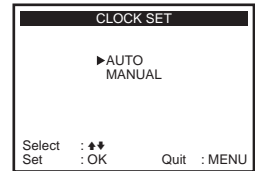

3  Press **↑/↓** to select MANUAL, then press OK.

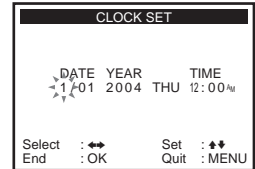

4



Press **↑/↓** to set the month.

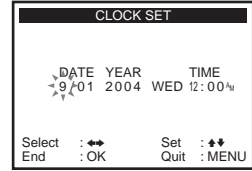

5



Press **→** to flash the day and press **↑/↓** to set the day.

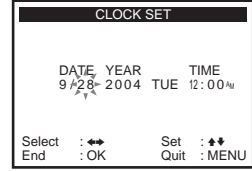

6

Set the year, hour, and minutes in the same way as the day.
The day of the week is set automatically.

7



Press **OK** or **MENU** to start the clock.

MENU



Step 6 : Presetting channels

This VCR is capable of receiving VHF channels 2 to 13, UHF channels 14 to 69 and unscrambled CATV channels 1 to 125. First, we recommend that you preset the receivable channels in your area using automatic presetting methods. Then, if there are any unwanted channels, disable them manually. If you have already decided which channels you wish to preset, set them directly using manual presetting methods (page 26).

Presetting all receivable channels automatically

Before you start...

- Turn on the VCR and the TV. When using a cable box, turn it on.
- Set the “VCR Output CH” to “3CH” or “4CH” in ADVANCED OPTIONS menu (page 47). If both are used, set the “VCR Output CH” to either channel. If your TV is connected to the VCR using A/V connections, set the TV to video input.
- Press TV/VIDEO to display the VCR indicator in the VCR’s display window.

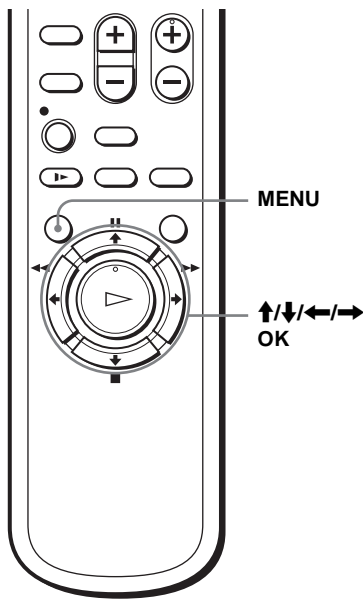

1



Press MENU.

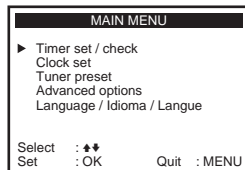

2



Press ↑/↓ to move the cursor (▶) to “Tuner preset,” then press OK.

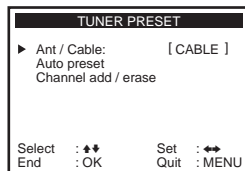

3



Press **↑/↓** to move the cursor (▶) to “Ant/Cable.”

4



• To preset cable TV channels:
Press **←/→** to select CABLE.

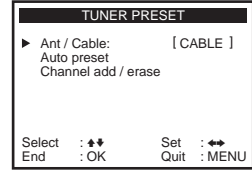

• To preset VHF and UHF channels:
Press **←/→** to select ANTENNA.

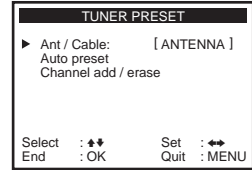

5



Press **↑/↓** to move the cursor (▶) to “Auto preset,” then press OK.

All receivable channels are preset in numerical sequence. When no more receivable channels can be found, presetting stops and the picture from the lowest numbered channel is displayed on the TV screen.

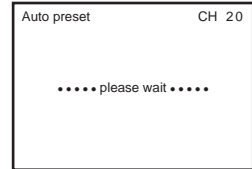

continued

Presetting/disabling channels manually

Before you start...

- Turn on the VCR and the TV. When using a cable box, turn it on.
- Set the “VCR Output CH” to “3CH” or “4CH” in ADVANCED OPTIONS menu (page 47). If both are used, set the “VCR Output CH” to either channel. If your TV is connected to the VCR using A/V connections, set the TV to video input.
- Press TV/VIDEO to display the VCR indicator in the VCR’s display window.

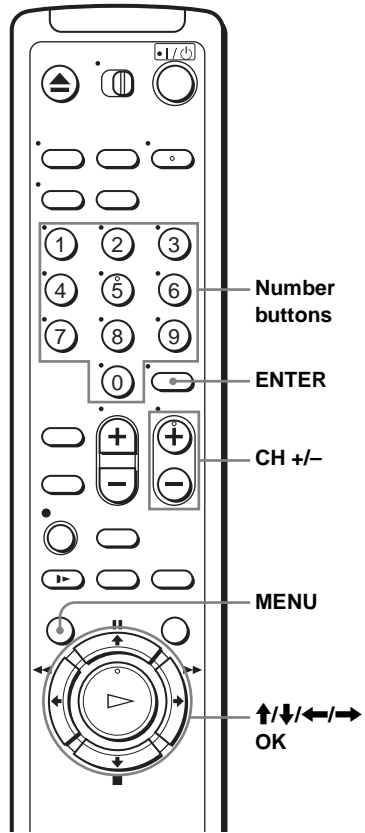

1  Press MENU.

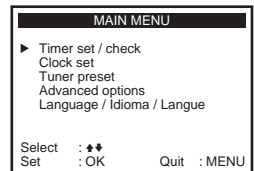

2  Press \uparrow/\downarrow to move the cursor (\blacktriangleright) to “Tuner preset,” then press OK.

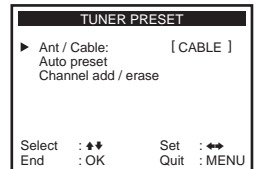

3



Press **↑/↓** to move the cursor (**▶**) to “Channel add/erase,” then press OK.

4



- To preset a channel:
- 1 Press the number buttons to enter the channel number, then press ENTER.
 - 2 Press **→**, then press OK or MENU.



MENU



• CH



- To disable a channel:
- 1 Press CH +/- to select the channel number.
 - 2 Press **←**, then press OK or MENU.



MENU



Channel to be preset

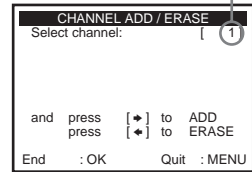

Channel to be disabled

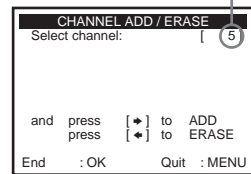

Playing a tape

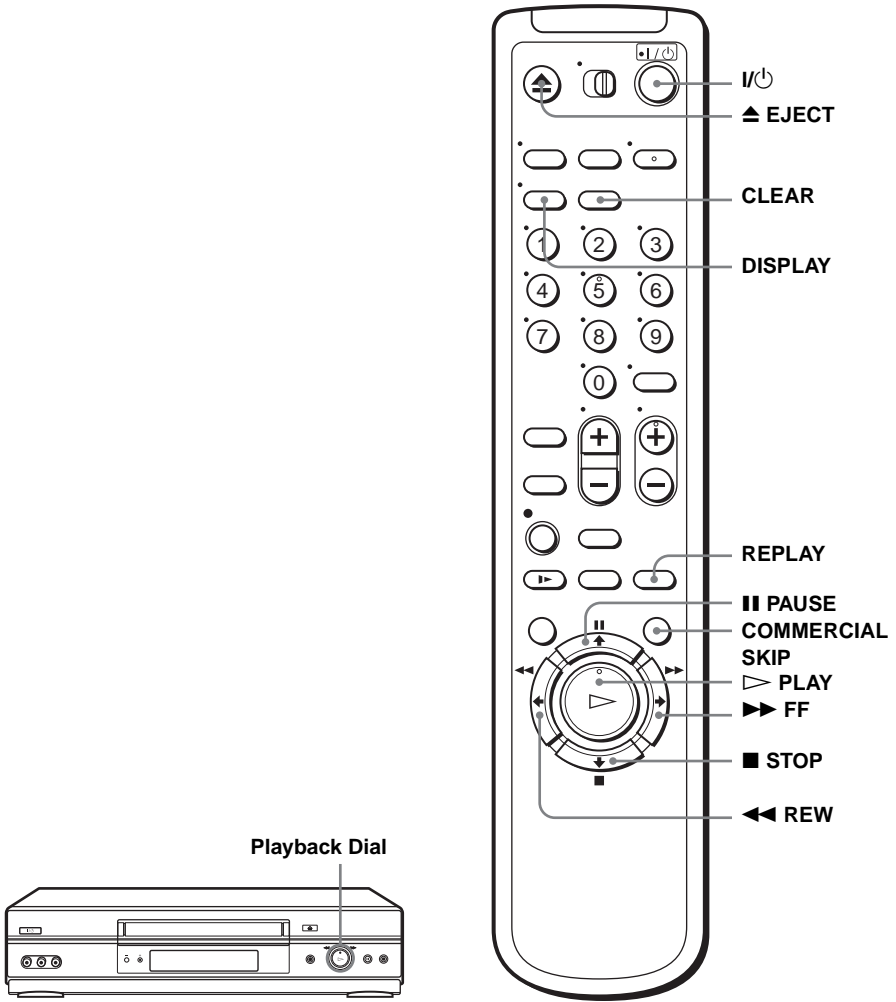

1 Turn on your TV and set it to the video channel.

2 Insert a tape.
The VCR turns on and starts playing automatically if you insert a tape with its safety tab removed.

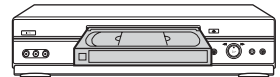

3



Press \triangleright PLAY.

The display window shows the playback time and playback direction.

When the tape reaches the end, it will rewind automatically.

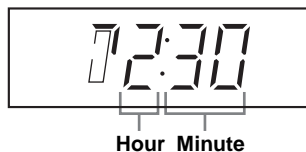

Additional tasks

To	Do this
Stop play	Press \blacksquare STOP
Pause play	Press II PAUSE
Resume play after pause	Press II PAUSE or \triangleright PLAY
Fast-forward the tape	Press FF during stop
Rewind the tape	Press REW during stop
Eject the tape	Press \blacktriangle EJECT

Using Playback Dial on the VCR

With Playback Dial, you can operate the following playback options.

To	Do this
Resume play after pause	Press \triangleright PLAY
Fast-forward the tape	Quickly turn and release Playback Dial to the right (FF) during stop
Rewind the tape	Quickly turn and release Playback Dial to the left (REW) during stop

Note

- Do not turn Playback Dial forcibly. It may damage Playback Dial.

To play a recently watched scene

You can immediately rewind and playback the scene you want to watch again.

During playback, press REPLAY. The VCR rewinds the tape about ten seconds on the counter for each press of the button, and restarts playback.

To skip playback

You can skip a portion of playback you do not want to watch (such as a commercial) and restart playback.

During playback, press COMMERCIAL SKIP up to four times. The VCR skips the tape 30 seconds on the counter for each press of the button, and restarts playback.

To turn off the power while rewinding (Rewind Shut Off)

Press I/O while the tape is rewinding. The power will turn off but the tape will keep rewinding until it reaches the end.

continued

To use the time counter

Press CLEAR at the point on the tape that you want to find later. The counter in the display window resets to “00:00” or “0:00.” To search for the counter 0:00:00 point automatically, see “To search for the counter 0:00:00 point” on page 45.



To display the counter on the TV screen, press DISPLAY.

Notes

- Tapes recorded in the LP mode on other VCRs can be played back on this VCR but the picture quality cannot be guaranteed.
- While displaying a menu on the TV screen, you cannot use ▷ PLAY, || PAUSE, ►► FF, ◀◀ REW, or ■ STOP buttons.
- The counter resets to “00:00” or “0:00” (in the display window) or “0:00:00” (on the TV screen) whenever a tape is reinserted.
- The counter stops counting when it comes to a portion with no recording.
- When 10 hours have passed, the counter in the display window returns to “0:00” and the count starts over again.
- When playback does not start even if you insert a tape with its safety tab removed, set “Auto play” in the ADVANCED OPTIONS menu correctly (page 47).
- This VCR can also play S-VHS tapes. The VCR will automatically identify the type of tape inserted in the VCR (either VHS or S-VHS). When S-VHS tapes are played in the VCR, the enhanced resolution will not be visible on screen; there may also be picture distortion while playing the S-VHS tape in slow motion or while utilizing other special playback modes. The VCR will not record in S-VHS mode on an S-VHS tape.

Recording TV programs

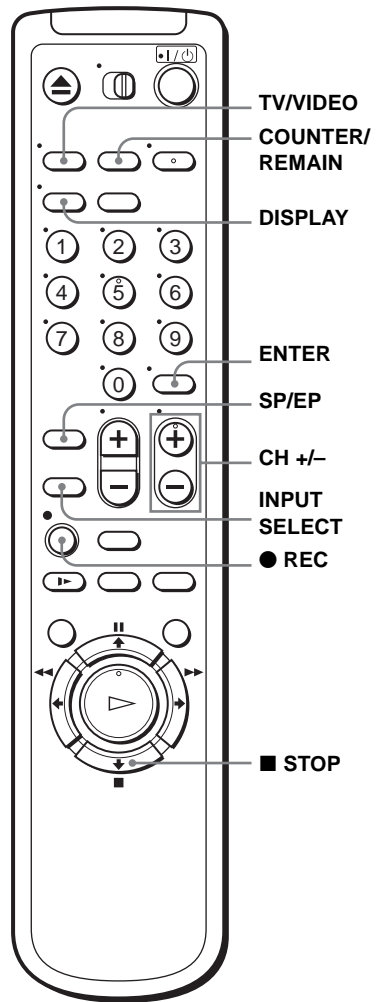

1 Turn on your TV and set it to the video channel.
To record from a cable box, turn it on.

2 Insert a tape with its safety tab in place.

continued

3



Press CH +/- to select the channel or line input video source you want to record.

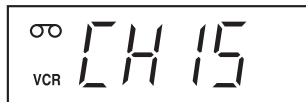

4



Press SP/EP to select the tape speed, SP or EP.

EP (Extended Play) provides recording time three times as long as SP (Standard Play). However, SP produces better picture and audio quality.



5



Press ● REC to start recording.

“REC” appears in the display window.



To stop recording

Press ■ STOP.

To check the remaining tape length

Press DISPLAY. With the display on, press COUNTER/REMAIN to check the remaining time. Each time you press COUNTER/REMAIN, the time counter and the remaining tape length appear alternately. The white bar indicates the current location in relation to the entire tape length. The remaining time also appears in the display window.

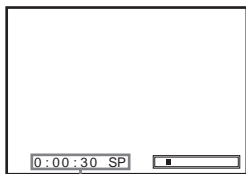

Time counter

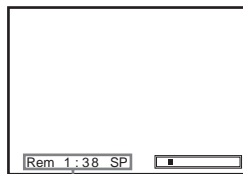

Remaining tape length

To check the remaining tape length of a tape, set “Tape select” in the ADVANCED OPTIONS menu correctly (page 47).

To watch another TV program while recording

- 1 Press TV/VIDEO to turn off the VCR indicator in the display window.
- 2 If your TV is connected to the VCR using A/V connections, set the TV to the TV's antenna input; if not, skip this step.
- 3 Select another channel on the TV.

To save a recording

To prevent accidental erasure, break off the safety tab as illustrated. To record on the tape again, cover the tab hole with adhesive tape.

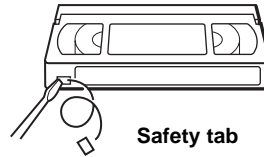

Tips

- To select a channel, you can use the number buttons on the remote commander. Enter the channel number, then press ENTER.
- You can select a video source from the LINE IN 1 or LINE-2 IN jacks using the INPUT SELECT button.
- The display appears on the TV screen indicating information about the tape, but the information will not be recorded on the tape.
- If you do not want to watch TV while recording, you can turn off the TV. When using a cable box, make sure to leave it on.

Notes

- The remaining tape length may not be indicated accurately for short tapes such as T-20 or T-30, or tapes recorded in the LP mode.
- The display does not appear during still (pause) mode or slow-motion playback.
- It may take up to one minute for the VCR to calculate and display the remaining tape length after you press DISPLAY.

Setting the timer

You can preset up to eight programs at one time.

Before you start...

- Check that the VCR clock is set to the correct time.
- Turn on the VCR and the TV and set it to the video channel. When using a cable box, turn it on.
- Insert a tape with its safety tab in place. Make sure the tape is longer than the total recording time.

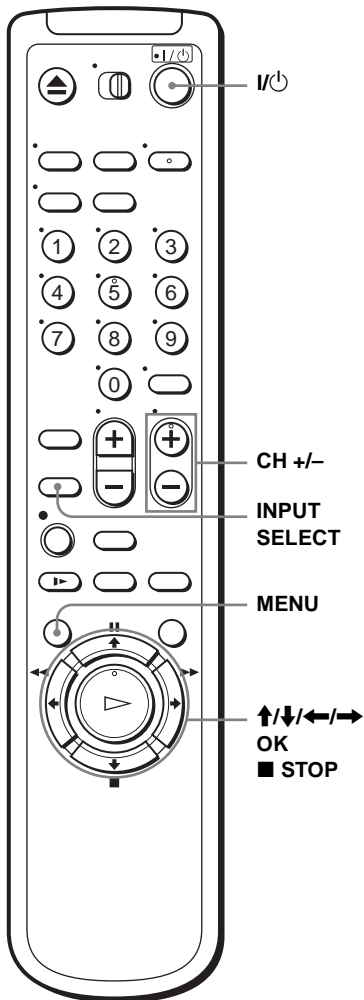

1



Press MENU.

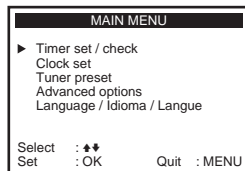

2



Press \uparrow/\downarrow to move the cursor (\blacktriangleright) to “Timer set/check,” then press OK.

CH	START	STOP	DATE	SPD
\blacktriangleright ---	---	---	---	---
---	---	---	---	---
---	---	---	---	---
---	---	---	---	---
---	---	---	---	---
---	---	---	---	---
---	---	---	---	---
Select	: \leftarrow		Set	: \rightarrow
End	: OK		Quit	: MENU

3



If necessary, press \uparrow/\downarrow to move the cursor (\blacktriangleright) to the row that is to be set.

4



Set the channel number, start and stop time, date, and tape speed:

1 Press \rightarrow to flash each item in turn.

2 Press \uparrow/\downarrow to set each item.

CH	START	STOP	DATE	SPD
\blacktriangleright 35	8:00 ^h	9:00 ^h	9/30	SP ^A
---	---	---	---	---
---	---	---	---	---
---	---	---	---	---
---	---	---	---	---
---	---	---	---	---
---	---	---	---	---
---	---	---	---	---
Select	: \leftarrow		Set	: \rightarrow
End	: OK		Quit	: MENU

To correct a setting, press \leftarrow to return to that setting and reset.



To record from a source connected to the LINE IN 1 or LINE-2 IN jacks, press INPUT SELECT or \uparrow/\downarrow to display “L1” or “L2” in the “CH” position.

To record the same program every day or the same day every week, press \downarrow while the date is flashing. For details, see “Daily/weekly recording” below.

To use the Auto Tape Speed function, press \downarrow to display “AUTO” in the “SPD” position. For details, see “To use the Auto Tape Speed function” on page 36.

5



Press OK to confirm the setting.

To enter another setting, press \uparrow/\downarrow to select the next row and repeat step 4.

6



Press MENU to exit the menu.

7



Press I/power to turn off the VCR.

The TIMER indicator appears in the display window and the VCR stands by for recording. When using a cable box, leave it on.

To stop recording

To stop the VCR while recording, press \blacksquare STOP.

continued

Daily/weekly recording

In step 4, press **↓** to select the recording pattern. Each time you press **↓**, the indication changes as shown below. Press **↑** to change the indication in reverse order.

MO~FR → SUN'S → MON'S → → SAT'S → 1 month later → (dates count down) → the current date

To use the Auto Tape Speed function

When you are recording a program in the SP mode and the remaining tape becomes shorter than the recording time, the tape speed is automatically changed to the EP mode. Note that some noise will appear on the picture when the tape speed is changed. If you want to keep the tape speed, select SP. To operate this function, set "Tape select" in the ADVANCED OPTIONS menu correctly (page 47).

To use the VCR after setting the timer

To use the VCR before a timer recording begins, just press **I/⏻**. The TIMER indicator disappears from the display window and the VCR switches on. Remember to press **I/⏻** to reset the VCR to the timer recording standby mode after using the VCR.

You can also do the following tasks while the VCR is recording:

- Reset the counter (page 30).
- Display tape information on the TV screen (page 32).
- Check the timer settings (page 41).
- Watch another TV program (page 33).

Note

- In step 7, make sure a tape is inserted before turning off the VCR. The TIMER indicator appears in the display window even if no tape is inserted.

Tips

- To set the channel, you can also use the number buttons.
- If the **□** indicator appears, the timer settings overlap. To check, change or cancel the program setting, see "Checking/changing/canceling timer settings" on page 41.

Locking the VCR (Child Lock)

After you have set the timer, you can lock all of the buttons on the VCR so that the settings are not canceled by mistake.

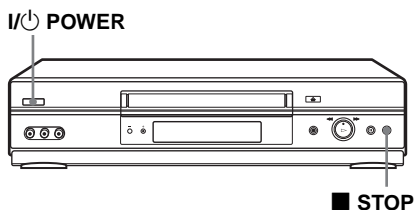

To lock the VCR

When the VCR is turned on, hold down **I/⏻ POWER on the VCR** until “LOC” appears in the display window. The VCR turns off and the **TIMER** indicator remains lit if there is a timer setting. The VCR will not work except for timer recordings.

To unlock the VCR

Hold down **I/⏻ POWER on the VCR** until “LOC” disappears from the display window. The VCR is unlocked and turns on.

To stop timer recording while the VCR is locked, press **■ STOP**. The recording stops and the VCR is unlocked.

Note

- The VCR will be unlocked when:
 - You stop timer recording by pressing **■ STOP**.
 - You insert a tape.
 - The AC power cord is disconnected or power supply stops.

Playing/searching at various speeds

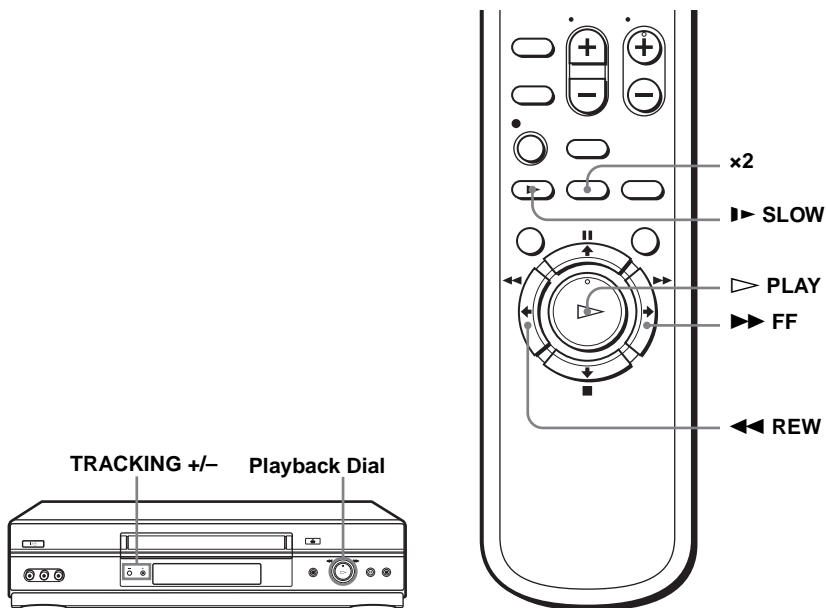

Playback options

To	Do this
View the picture during fast-forward or rewind	During fast-forward, hold down ►► FF. During rewind, hold down ◄◄ REW.
Play at high speed	<ul style="list-style-type: none"> • During playback, briefly press ►► FF or ◄◄ REW. The tape continues to play at high speed. • During playback, hold down ►► FF or ◄◄ REW. When you release the button, normal playback resumes.
Play at twice the normal speed	During playback, press x2.
Play in slow motion	During playback or pause, press ► SLOW.
Play frame by frame	During pause, press ►► FF.

To resume normal playback

Press ▷ PLAY.

Using Playback Dial on the VCR

With Playback Dial, you can operate the following playback options.

To	Do this
View the picture during fast-forward or rewind	During fast-forward, turn and hold Playback Dial to the right (▶▶ FF). During rewind, turn and hold Playback Dial to the left (◀◀ REW).
Play at high speed	<ul style="list-style-type: none">• During playback, quickly turn and release Playback Dial to the right (▶▶ FF) or left (◀◀ REW). The tape continues to play at high speed.• During playback, turn and hold Playback Dial to the right (▶▶ FF) or left (◀◀ REW). When you release Playback Dial, normal playback resumes.

Tips

- Adjust the picture using the TRACKING +/- buttons if:
 - Streaks appear while playing in slow motion.
 - The picture shakes during pause.
- The VCR turns on and starts playback automatically by pressing ▷ PLAY on the VCR with the VCR power turned off.

Notes

- The sound is muted during these operations.
- Tapes recorded in the LP mode on other VCRs can be played back on this VCR but the picture quality cannot be guaranteed.
- The picture may show noise when playing at high speed in reverse.
- Do not turn Playback Dial forcibly. It may damage Playback Dial.

Quick Timer Recording

After you have started recording, you can have the VCR stop recording automatically after a specified duration.

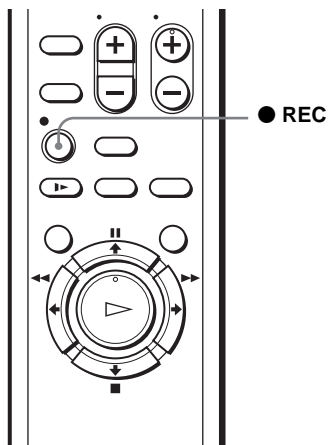

- 1 While recording, press ● REC.
The TIMER indicator appears in the display window.



- 2 Press ● REC repeatedly to set the duration time.
Each press advances the time in increments of 30 minutes.

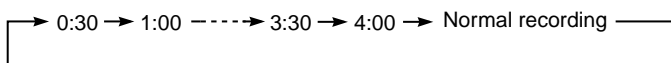

The tape counter decreases minute by minute to 0:00, then the VCR stops recording and turns off automatically.

To extend the duration

Press ● REC repeatedly to set a new duration time.

To cancel the duration

Press ● REC repeatedly until the TIMER indicator disappears and the VCR returns to normal recording mode.

To stop while recording

Press ■ STOP.

Note

- You cannot display the current tape time in the display window when setting the recording duration time.

Checking/changing/canceling timer settings

Before you start...

- Turn on the TV and set it to the video channel.

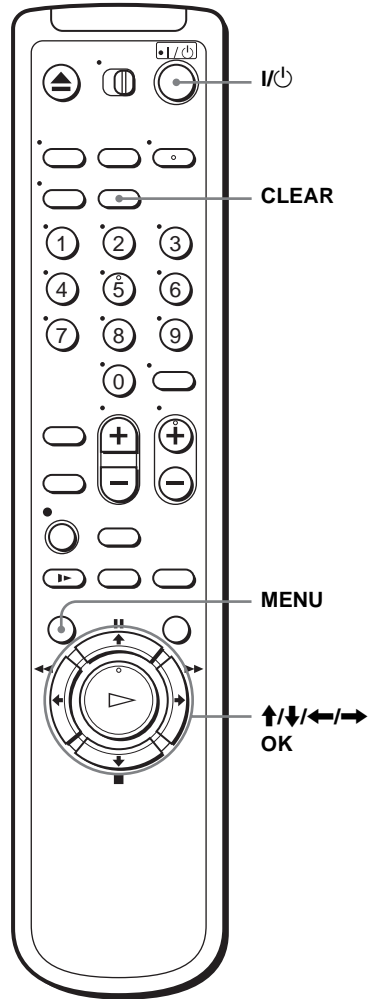

- 1** Press I/Power to turn on the VCR.
- 2** Press MENU.

continued

- 3** Press **↑/↓** to move the cursor (▶) to “Timer set/check,” then press OK.
- If you want to change a setting, go on to the next step.
 - If you do not need to change the settings, press MENU, then turn off the VCR to return to recording standby.

- 4** Press **↑/↓** to move the cursor (▶) to the setting you want to change or cancel.

- To change the setting, press **←/→** to flash the item you want to change, and press **↑/↓** to change it.
- To cancel the setting, press CLEAR.

CH	START	STOP	DATE	SPD
▶ 35	08:00 ^{hr}	9:00 ^{hr}	9/30	SP
20	10:00 ^{hr}	11:30 ^{hr}	10/02	EP
60	08:30 ^{hr}	10:00 ^{hr}	9/30	AUTO
---	---	---	---	--
---	---	---	---	--
---	---	---	---	--
---	---	---	---	--
Select	: ↔		Set	: ↔
End	: OK		Quit	: MENU

- 5** Press OK to confirm the setting.

- 6** Press MENU to exit the menu.

If any timer settings remain, turn off the VCR to return to recording standby.

When the timer settings overlap

The program that starts first has priority and the second program starts recording only after the first program has finished. If the programs start at the same time, the program listed first in the menu has priority.

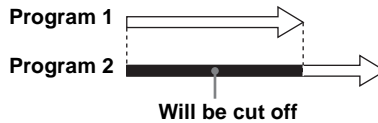

Recording stereo and bilingual programs

Recording stereo programs

When you receive a program broadcast in stereo, press AUDIO MONITOR to display STEREO on the TV screen. You can also select LEFT, RIGHT, or MONO. If there is noise in the stereo program, select MONO. The sound will be recorded in monaural (on both hi-fi and normal audio tracks) but with less noise.

Recording bilingual programs

Press AUDIO MONITOR to display "SAP" on the TV screen. When a SAP (Second Audio Program) is received, "SAP" appears on the TV screen. When MAIN is selected, the VCR records only the main sound.

Selecting the sound during playback

During playback, press AUDIO MONITOR to select the sound you want.

To listen to	On-screen display	Display window
Stereo	HI-FI	Hi-Fi
Left channel	LEFT	Hi-Fi
Right channel	RIGHT	Hi-Fi
Monaural sound on the normal audio track	MONO	No indicator

How sound is recorded on a video tape

The VCR records sound onto two separate tracks. Hi-fi audio is recorded onto the main track along with the picture. Monaural sound is recorded onto the normal audio track along the edge of the tape.

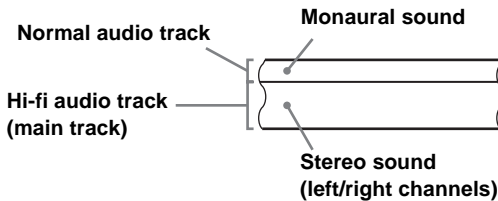

Notes

- To play a tape in stereo, you must use the A/V connections.
- When you play a tape recorded in monaural, the sound is heard in monaural regardless of the AUDIO MONITOR setting.

Searching using various functions

The VCR automatically marks the tape with an index signal at the point where each recording begins.

You can easily find a specific point using various search functions.

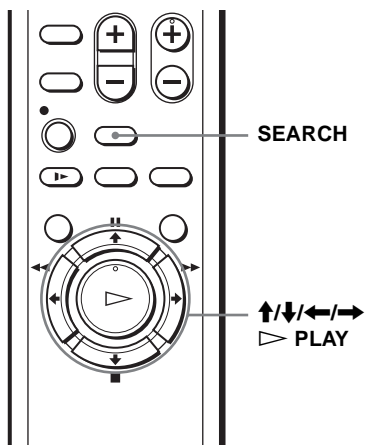

To search using the index function (Scan and Play)

The VCR automatically marks the tape with an index signal at the point where each recording begins. Use these signals as references to find a specific recording.

- 1 Insert an indexed tape into the VCR.
- 2 Press SEARCH.

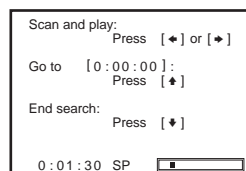

- 3 Press → to scan ahead, or ← to scan backwards.
The VCR searches and then plays back for about five seconds.



- 4 Press ▷ PLAY to view that program.
If you do not press ▷ PLAY, the VCR automatically searches for the next index mark, or until it reaches the end of the tape.

To search for the counter 0:00:00 point

To mark a point on the tape that you want to find later, reset the tape counter to “0:00:00.”

The VCR automatically fast-forwards or rewinds to the 0:00:00 point on the tape counter.

1 Press SEARCH.

2 Press **↑**.

The VCR starts searching and automatically stops at the 0:00:00 point.

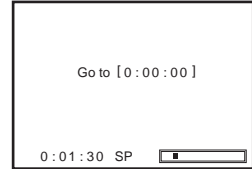

To search for a blank portion of the tape

The VCR automatically searches for the beginning of a blank portion. You can easily find a point you can start recording from.

1 Press SEARCH.

2 Press **↓**.

The VCR starts searching and automatically stops at the beginning of a blank space. If no blank space is found, the VCR reaches the end and the tape will stop.

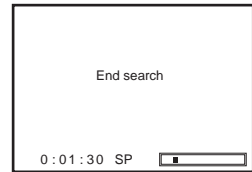

Note

- Once in recording mode, if the VCR is put in pause and then released to start the recording, no index mark will be inserted. An index mark will be inserted if the channel is changed while VCR is put in pause.

Adjusting the picture (tracking)

Although the VCR automatically adjusts the tracking when playing a tape, distortion may occur if the recording is in poor condition. In this case, manually adjust the tracking.

Press TRACKING +/- on the VCR to display the tracking meter. The distortion should disappear as you press one of the two tracking buttons. To resume automatic tracking adjustment, eject the tape and reinsert it.

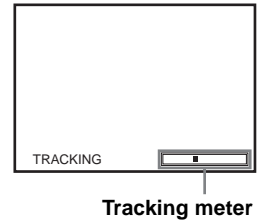

Note

- The auto tracking adjustment cannot be guaranteed to work with tapes recorded in the LP mode on other VCRs.

Changing menu options

- 1 Press MENU.
- 2 Press **↑/↓** to move the cursor (▶) to “Advanced options,” then press OK.

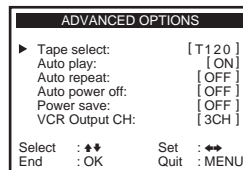

- 3 Press **↑/↓** to move the cursor (▶) to the option to change.
- 4 Press **←/→** to change the setting.
- 5 Press MENU to exit the menu.

Menu choices

Initial settings are indicated in bold print.

Menu option	Set this option to
Tape select	<ul style="list-style-type: none"> • T-120 when using a T-120 or shorter length tape. • T-160 when using a T-160 length tape. • T-180 when using a T-180 or longer length tape. <p>For details, see page 32.</p>
Auto play	<ul style="list-style-type: none"> • ON to start playback automatically, when you insert a tape with its safety tab removed. • OFF to turn off Auto play. You need to press ▷ PLAY to start playback, even if you insert a tape with its safety tab removed.
Auto repeat	<ul style="list-style-type: none"> • ON to play back a tape repeatedly. The VCR rewinds a tape to the beginning and restarts playback automatically. • OFF to turn off Auto repeat.
Auto power off	<ul style="list-style-type: none"> • 1Hr to turn off the VCR automatically one hour after the last operation. • 2Hr to turn off the VCR automatically two hours after the last operation. • OFF to set no specific time to turn off.
Power save	<ul style="list-style-type: none"> • ON to turn off the indicators in the display window during standby mode to reduce the VCR's power consumption to a minimum. • OFF to turn on the indicators in the display window while the VCR is standing by.
VCR Output CH	<ul style="list-style-type: none"> • 3CH when using channel 3 to receive the VCR signal. • 4CH when using channel 4 to receive the VCR signal. <p>For details, see page 48.</p>

continued

Setting the RF Output channel

When connecting the VCR to the TV using only the antenna cable, you must set the “VCR Output CH” in the ADVANCED OPTIONS menu so that the TV can receive the correct signal from the VCR.

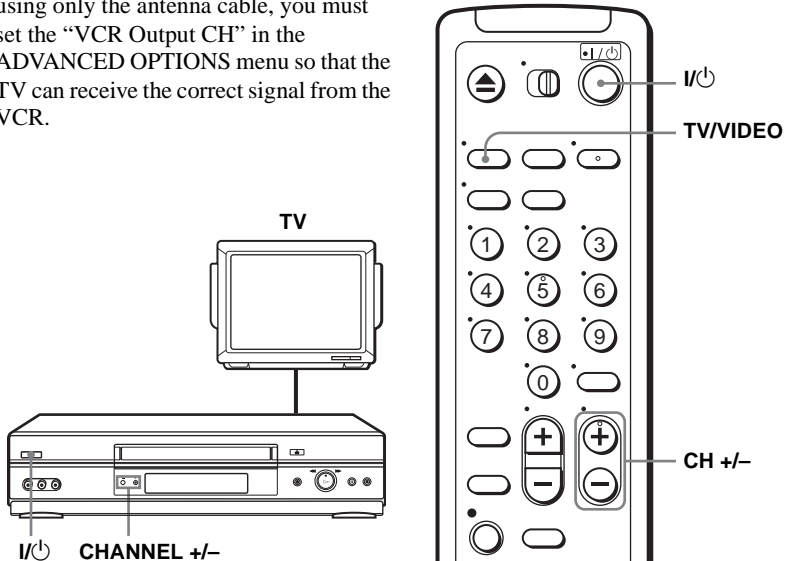

- 1** Set the “VCR Output CH” to “3CH” or “4CH” (see page 47 to set the channel), whichever channel is not used in your area. If both are used, set the “VCR Output CH” to either channel.
- 2** Press I/Power to turn on the VCR.
- 3** Press TV/VIDEO to turn on the VCR indicator in the VCR’s display window.
- 4** Press CH +/- to display a channel number in the display window.
Select an active channel number in your area.
- 5** Turn on your TV and set it to the channel you selected in step 1 (3CH or 4CH).
The channel you selected in step 4 appears on the TV screen. If the channels change when you press CH +/-, you have made the correct setting.
Whenever you use the VCR, set the TV to the channel selected in step 1.

Editing with another VCR

How to connect to record on this VCR

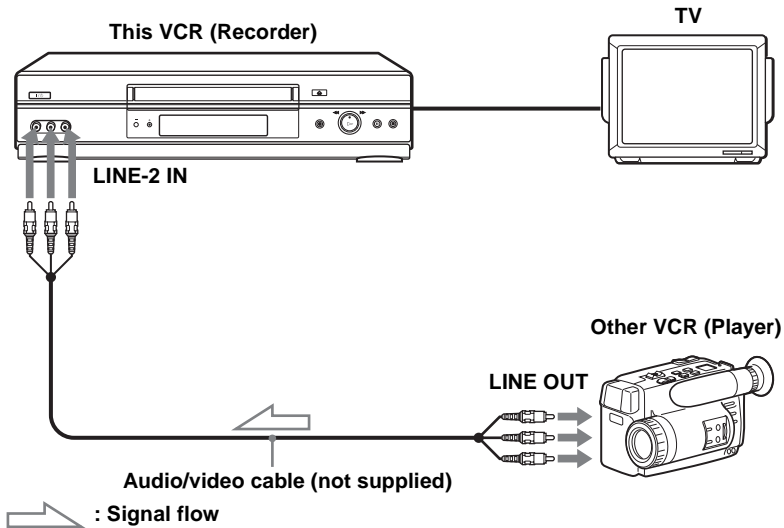

Notes

- Make sure you connect the plugs to jacks of the same color.
- If the other VCR is a monaural type and connected to this VCR's LINE-2 IN jacks, connect the audio plug to the AUDIO L (white) jack. The sound is recorded on both right and left channels. If you connect to the AUDIO R (red) jack, the sound is recorded only on the right channel.
- If you connected this VCR to both the LINE IN and LINE OUT jacks of the other VCR, select the input correctly to prevent a humming noise.
- You can use the LINE IN 1 jacks for editing. If the other VCR is a monaural type the sound is recorded only on the channel whose jack is connected to the audio plug. To record on both right and left channels, connect the audio plugs to the AUDIO R/L jacks using an audio/video cable (not supplied).

Operation (when recording on this VCR)

Before you start editing

- Turn on the VCR and the TV and set it to the video channel.
- Press INPUT SELECT or CHANNEL +/- to display “L1” or “L2” in the display window.
- Press SP/EP to select the tape speed, SP or EP.

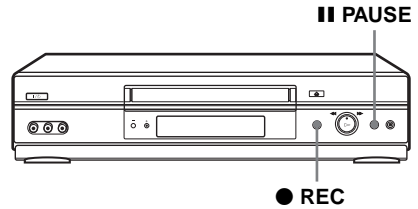

- 1** Insert a source tape with its safety tab removed into the other (playback) VCR. Search for the point to start playback and set it to playback pause.
- 2** Insert a tape into this (recording) VCR. Search for the point to start recording and press **|| PAUSE**.
- 3** Press **● REC** on this VCR to set it to recording pause.
- 4** To start editing, press the **|| PAUSE** buttons on both VCRs at the same time.

To stop editing

Press the **■ STOP** buttons on both VCRs.

Tip

- To cut out unwanted scenes while editing, press **|| PAUSE** on this VCR when an unwanted scene begins. When it ends, press **|| PAUSE** again to resume recording.

Antenna information

Attaching the external antenna connector

When using a 300-ohm twin lead cable for a VHF/UHF antenna, use an antenna connector (not supplied) to connect the antenna to the VCR.

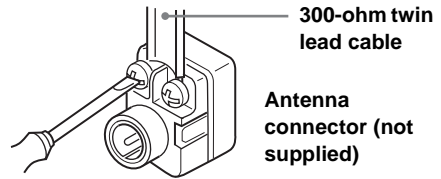

- 1** Loosen the screws on the antenna connector.
- 2** Wind the twin leads around the screws on the antenna connector.
- 3** Retighten the screws.

Attaching a UHF/VHF band mixer

When using both a 75-ohm coaxial cable and a 300-ohm twin lead cable for a VHF/UHF antenna, use a UHF/VHF band separator/mixer (not supplied) to connect the antenna to the VCR.

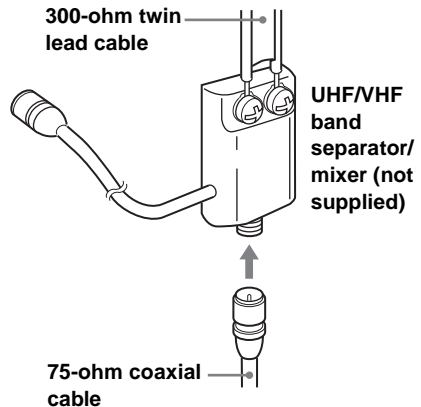

- 1** Loosen the screws on the mixer.
- 2** Wind the twin leads around the screws on the mixer.
- 3** Retighten the screws.
- 4** Connect the 75-ohm coaxial cable to the mixer.

Troubleshooting

If you have any questions or problems not covered below, please consult your nearest Sony dealer.

	Symptom	Remedy
Power	The I/⏻ (on/standby) switch does not function.	<ul style="list-style-type: none"> • Connect the AC power cord securely. • Make sure the VCR is not locked. To unlock, hold down I/⏻ (on/standby) POWER on the VCR until "LOC" disappears.
	The power is turned on but the VCR does not operate.	<ul style="list-style-type: none"> • Moisture condensation has occurred. Turn the power off, unplug the AC power cord and leave the VCR to dry for over three hours.
Clock	The clock has stopped and "--:--" appears in the display window.	<ul style="list-style-type: none"> • The clock stops if the VCR is disconnected from the wall outlet for more than one minute. Reset the clock (and timer).
Playback	The playback picture does not appear on the TV screen.	<ul style="list-style-type: none"> • Make sure the TV is set to the channel for the VCR. If you are using a monitor, set it to video input.
	The picture is not clear.	<ul style="list-style-type: none"> • Adjust the tracking with the TRACKING +/- buttons. • The video heads are dirty (see the last page of "Troubleshooting"). Clean the video heads using a Sony video head cleaning cassette. If a Sony cleaning cassette is not available in your area, have the heads cleaned at your nearest Sony dealer (a standard service fee will be charged). Do not use a commercially available liquid type cleaning cassette, as it may damage the video heads. • The video heads may have to be replaced. Consult your local Sony dealer for more information.
	The picture rolls vertically during picture search.	<ul style="list-style-type: none"> • Adjust the vertical hold control on the TV or monitor.
	The picture has no sound.	<ul style="list-style-type: none"> • The tape is defective. • If you made A/V connections, check the audio cable connection.
Recording	A TV program does not appear on the TV screen.	<ul style="list-style-type: none"> • Make sure the TV is set to the channel for the VCR. If you are using a monitor, set it to video input. • Select the correct source with the INPUT SELECT or CH +/- buttons. Select a channel number when recording TV programs; select "L1" or "L2" when recording from other equipment.
	TV reception is poor.	<ul style="list-style-type: none"> • Adjust the TV antenna.
	The tape starts playing as soon as it is inserted.	<ul style="list-style-type: none"> • The safety tab has been removed. To record on this tape, cover the tab hole.
	The tape is ejected when you press ● REC.	<ul style="list-style-type: none"> • Check that the safety tab has not been removed.
	Nothing happens when you press ● REC.	<ul style="list-style-type: none"> • Make sure the tape is not at its end.

	Symptom	Remedy
Timer recording	The timer does not operate.	<ul style="list-style-type: none"> • Check that the clock is set. • Make sure a tape has been inserted. • Check that the safety tab has not been removed. • Make sure the tape is not at its end. • Make sure a program has been set for timer recording. • Make sure your timer settings are past the current time. • Check that the cable box is turned on. • The clock stops if the VCR is disconnected from the wall outlet for more than one minute. Reset the clock and timer. • Turn the power off and unplug the AC power cord.
	A tape cannot be inserted.	<ul style="list-style-type: none"> • Check that a tape is not already in the tape compartment.
Others	The remote commander does not function.	<ul style="list-style-type: none"> • Make sure you are pointing the remote commander at the remote sensor on the VCR. • Replace all the batteries in the remote commander with new ones if they are weak. • Make sure the •TV / VIDEO switch is set correctly.
	The tracking meter does not appear on the screen.	<ul style="list-style-type: none"> • The recording condition of the tape is very poor and tracking cannot be adjusted.
	You cannot control other TVs.	<ul style="list-style-type: none"> • Set your TV's code number. The code number may change when you replace the batteries of the remote commander.
	The VCR needs to be cleaned.	<ul style="list-style-type: none"> • Clean the cabinet, panel and controls with a dry, soft cloth, or a soft cloth slightly moistened with a mild detergent solution. Do not use any type of solvent, such as alcohol or benzine.

Symptoms caused by contaminated video heads

• Normal picture

• Rough picture

• Unclear picture

• No picture (or black & white screen appears)

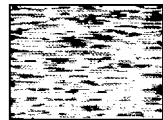

initial
contamination



terminal

Specifications

System

- Format
 - VHS NTSC standard
- Video recording system
 - Rotary head helical scanning FM system
- Video heads
 - Double azimuth four heads
- Video signal
 - NTSC color, EIA standards
- Tape speed
 - SP: 33.35 mm/s (1 $\frac{3}{8}$ inches/s)
 - EP: 11.12 mm/s ($\frac{7}{16}$ inches/s)
 - LP: 16.67 mm/s ($1\frac{1}{16}$ inches/s), playback only
- Maximum recording/playback time
 - 8 hrs. in EP mode (with T-160 tape)
- Rewind time
 - Approx. 1 min (with T-120 tape)

Tuner section

- Channel coverage
 - VHF 2 to 13
 - UHF 14 to 69
 - CATV A-8 to A-1, A to W, W+1 to W+84
- Antenna
 - 75-ohm antenna terminal for VHF/UHF

Inputs and outputs

- LINE IN 1 and LINE-2 IN
 - VIDEO IN, phono jack (1 each)
 - Input signal: 1 Vp-p, 75 ohms, unbalanced, sync negative
 - AUDIO IN, phono jacks (2 each)
 - Input level: 327 mVrms
 - Input impedance: more than 47 kilohms
- LINE OUT
 - VIDEO OUT, phono jack (1)
 - Output signal: 1 Vp-p, 75 ohms, unbalanced, sync negative
 - AUDIO OUT, phono jacks (2)
 - Standard output: 327 mVrms
 - Load impedance: 47 kilohms
 - Output impedance: less than 10 kilohms

Timer section

- Clock
 - Quartz locked
- Timer indication
 - 12-hour cycle
- Timer setting
 - 8 programs (max.)

General

- Power requirements
 - 120 V AC, 60 Hz
- Power consumption
 - 16 W
- Operating temperature
 - 0°C to 45°C (32°F to 113°F)
- Storage temperature
 - 20°C to 60°C (-4°F to 140°F)
- Dimensions including projecting parts and controls (w/h/d)
 - SLV-N750
 - Approx. 430 × 96 × 262 mm (Approx. 17 × 3 $\frac{7}{8}$ × 10 $\frac{1}{2}$ inches)
 - SLV-N650
 - Approx. 360 × 95 × 260 mm (Approx. 14 $\frac{1}{4}$ × 3 $\frac{3}{4}$ × 10 $\frac{2}{5}$ inches)
- Mass
 - SLV-N750
 - Approx. 2.8 kg (Approx. 6 lb 3 oz)
 - SLV-N650
 - Approx. 2.6 kg (Approx. 5 lb 12 oz)

Supplied accessories

- Remote commander (1)
- Size AA (R6) batteries (2)
- 75-ohm coaxial cable with F-type connectors (1)

Design and specifications are subject to change without notice.

ENERGY STAR® is a U.S. registered mark.

As an ENERGY STAR® Partner, Sony Corporation has determined that this product meets the ENERGY STAR® guidelines for energy efficiency.

Index to parts and controls

Refer to the pages indicated in parentheses () for details.

Front panel

SLV-N750

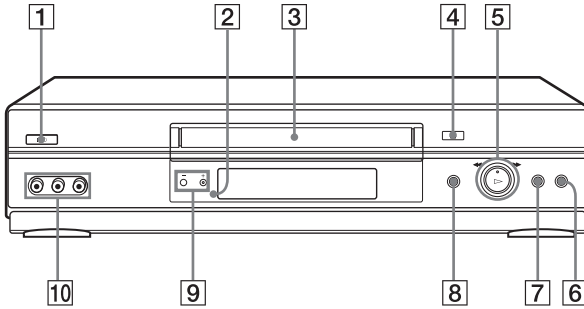

SLV-N650

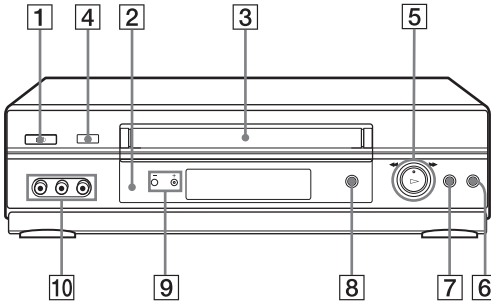

- 1 I/⏻ (on/standby) POWER switch (35)
- 2 Remote sensor (8)
- 3 Tape compartment
- 4 EJECT button (29)
- 5 ▷ PLAY button* (29)/▶▶ FF (fast-forward)/◀◀ REW (rewind) (29) (39)/ Playback Dial (29) (39)
- 6 ■ STOP button (29) (50)

- 7 || PAUSE button (29) (50)
 - 8 ● REC (record) button (32) (40) (50)
 - 9 CHANNEL/TRACKING +/- buttons* (32) (46)
 - 10 LINE-2 IN VIDEO/AUDIO L/R jacks (49)
- * The ▷ PLAY and CHANNEL + buttons have a tactile dot.

continued

Display window

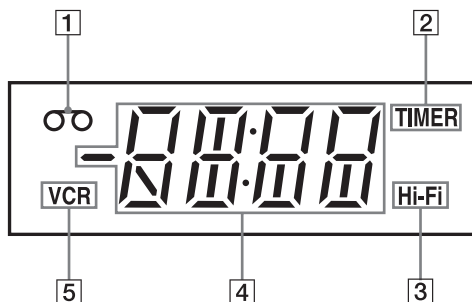

1 Tape indicator (32)

2 TIMER indicator (35)

3 Hi-Fi indicator (43)

4 Time counter/clock/line/channel indicator (30) (32) (50)

5 VCR indicator (33)

Rear panel

SLV-N750

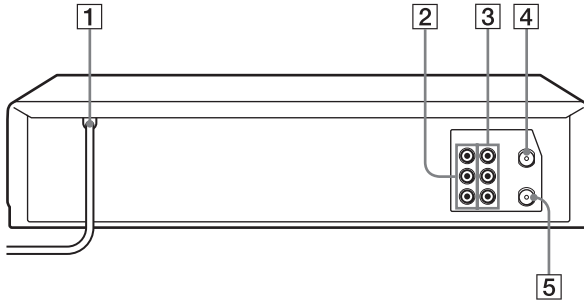

SLV-N650

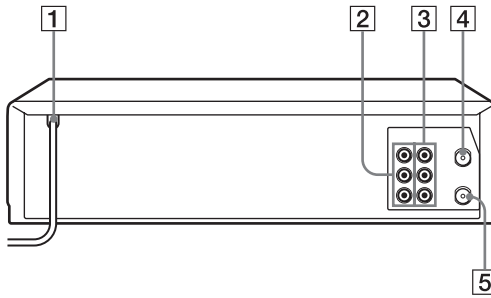

- 1** AC power cord (11) (14) (16)
- 2** LINE OUT AUDIO R/AUDIO L/VIDEO jacks (12)
- 3** LINE IN 1 AUDIO R/AUDIO L/VIDEO jacks (49)
- 4** RF IN (FROM ANT.) connector (13) (15) (17)
- 5** RF OUT (TO TV) connector (13) (15) (17)

continued

Remote commander

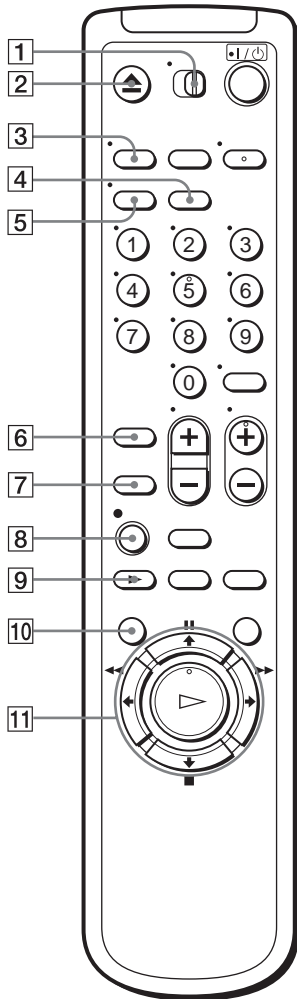

- 1** •TV / VIDEO switch (8)
- 2** ▲ EJECT button (29)
- 3** TV/VIDEO button (9) (33)
- 4** CLEAR button (30) (42)
- 5** DISPLAY button (32)
- 6** SP (Standard Play)/EP (Extended Play) button (32)
- 7** INPUT SELECT button (33) (50)
- 8** ● REC (record) button (32) (40)
- 9** ► SLOW button (38)
- 10** MENU button (18) (34) (41) (47)
- 11** || PAUSE/▲ button (18) (29)
 ■ STOP/▼ button (18) (29)
 ◀ REW (rewind)/ ← button (29) (38)
 ▶▶ FF (fast-forward)/ → button (29) (38)
 ▷ PLAY/OK button* (19) (29)

* The ▷ PLAY button has a tactile dot.

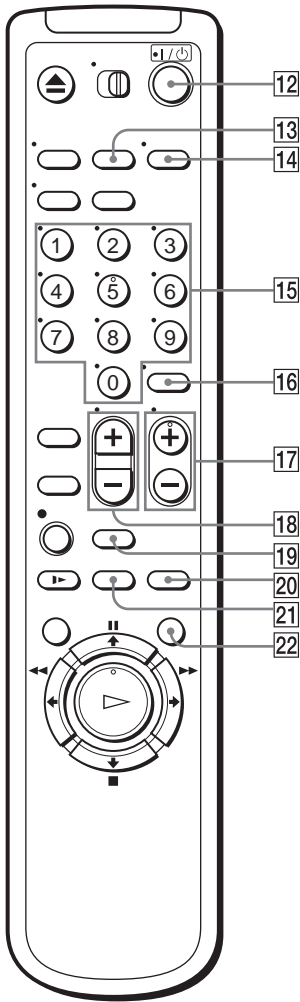

12 I/⏻ (on/standby) (power) switch (9) (35)

13 COUNTER/REMAIN button (32)

14 AUDIO MONITOR button* (43)

15 Number buttons* (33)

16 ENTER button (33)

17 CH (channel) +/- buttons* (9) (32)

18 VOL (volume) +/- buttons (9)

19 SEARCH button (44)

20 REPLAY button (29)

21 ×2 button (38)

22 COMMERCIAL SKIP button (29)

* The AUDIO MONITOR, number 5 and CH + buttons have a tactile dot.

Index

A

- Adjusting
 - picture 46
 - tracking 46
- Advanced option 47
- Antenna hookup 13
- Audio track 43
- Audio/video (A/V) hookup 12
- Auto Clock Set 19
- Auto Tape Speed 36

C

- Cable hookup 11
- Child Lock 37
- Cleaning the video heads 52
- Clock setting 19
- Commercial Skip 29
- Connecting
 - Cable TV 17
 - external antenna connector 51
 - UHF/VHF band mixer 51
- Counter 30

D

- Disabling channels 26
- Dubbing. *see* Editing

E

- Editing 49
- EP mode 32

H

- Hi-fi audio track 43

L

- Language selecting 18
- Locking the VCR 37
- LP mode 33

M

- Monaural 43
- Monitoring audio during playback 43

N

- Normal audio track 43

P

- Picture adjustment 46
- Playback 28
 - at various speeds 38
 - frame by frame 38
 - selecting the sound 43
 - skip 29
 - slow motion 38
- Presetting channels 24

Q

- Quick Timer Recording 40

R

- Recording 31
 - bilingual programs 43
 - SAP broadcasts 43
 - saving 33
 - stereo broadcasts 43
 - timer setting 34
 - while watching another program 33
- RF channel 48

S

- Safety tab 33
- SAP (Second Audio Program) 43
- Searching
 - at various speeds 38
 - for a blank portion 45
 - for the counter 0 point 45
 - Scan and Play 44
- SP mode 32
- Stereo 43

T

- Timer setting 34
 - canceling 41
 - changing 41
 - checking 41
 - daily/weekly recording 36
- Tracking adjustment. *see* Adjusting
- Tuner presetting 24

Quick reference to using the VCR

Hookup 1

To play a tape

- 1 Set the TV to channel 3 or 4 (or to video input, if you made A/V connections).
- 2 Insert a tape and press \triangleright PLAY. If there is no picture on your TV, press the VCR's TV/VIDEO button until the VCR indicator appears in the display window.

To record a program

- 1 Press MENU and select "Timer set/check."
- 2 Set the channel, time, date, and tape speed.
- 3 Press OK.
- 4 Insert a tape.
- 5 Press I/\odot to turn off the VCR.

To watch TV

- 1 Turn off the VCR, or press the VCR's TV/VIDEO button until the VCR indicator in the display window turns off.
- 2 Set the TV to the channel you want to watch.

Hookup 2

To play a tape

- 1 If you made A/V connections, set the TV to video input. If you did not use A/V hookup:
 - Turn on the cable box.
 - Set the cable box to channel 3 or 4.
 - Set the TV to the output channel of the cable box (usually 2, 3, or 4).
- 2 Insert a tape and press \triangleright PLAY.

To record a program

- 1 Press MENU and select "Timer set/check."
- 2 Set the channel, time, date, and tape speed.
- 3 Press OK.
- 4 Insert a tape.
- 5 Press I/\odot to turn off the VCR.

To watch TV

- 1 Turn off your VCR, or press the VCR's TV/VIDEO button until the VCR indicator in the display window turns off.
- 2 Select the channel with your cable box (if you have one) or with your TV.

Hookup 3

To play a tape

- 1 Set the TV to channel 3 or 4 (or to video input, if you made A/V connections).
- 2 Insert a tape and press \triangleright PLAY.

To record a program

- 1 Turn on the cable box.
- 2 Set the cable box to the channel you want to record.
- 3 Press MENU and select "Timer set/check."
- 4 Set the channel, time, date, and tape speed.
- 5 Press OK.
- 6 Insert a tape.
- 7 Press I/\odot to turn off the VCR. Leave the cable box on.

To watch TV

- 1 Turn off your VCR, or press the VCR's TV/VIDEO button until the VCR indicator in the display window turns off.
- 2 Turn on your cable box.
- 3 Set the TV to the cable box output channel (usually 2, 3, or 4).
- 4 Set the cable box to the channel you want to watch.