

SONY.

3-798-373-21 (1)

PROPERTY OF SONY
MIDWEST REGION

Portable MiniDisc Recorder

Operating instructions

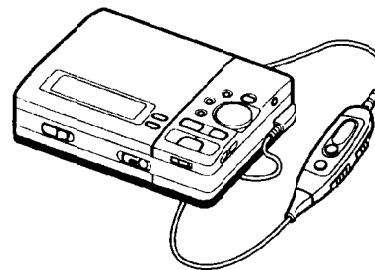

MZ-R3

WARNING

To prevent fire or shock hazard, do not expose the unit to rain or moisture.

To avoid electrical shock, do not open the cabinet. Refer servicing to qualified personnel only.

Caution

The use of optical instruments with this product will increase eye hazard.

Information

For Customers in the USA

This equipment has been tested and found to comply with the limits for a Class B digital device, pursuant to Part 15 of the FCC rules. These limits are designed to provide reasonable protection against harmful interference in a residential installation. This equipment generates, uses, and can radiate radio frequency energy and, if not installed and used in accordance with the instructions, may cause harmful interference to radio communications.

However, there is no guarantee that interference will not occur in a particular installation. If this equipment does cause harmful interference to radio or television reception, which can be determined by turning the equipment off and on, the user is encouraged to try to correct the interference by one more of the following measures:

- Reorient or relocate the receiving antenna.
- Increase the separation between the equipment and the receiver.
- Connect the equipment into an outlet on a circuit different from that to which the receiver is connected.

- Consult the dealer or an experienced radio/TV technician for help.
- You are cautioned that any changes or modifications not expressly approved in this manual could void your authority to operate this equipment.

For Customers in the United Kingdom

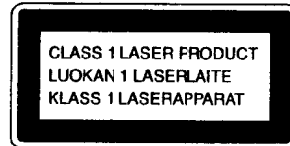

This MiniDisc Recorder is classified as a CLASS 1 LASER product. The CLASS 1 LASER PRODUCT label is located on the bottom exterior.

The built-in battery should be replaced by qualified personnel only.

For Customers in Australia

If the supply cord of AC power adaptor is damaged the AC power adaptor must be returned to the manufacturer of his agent for the cord to be replaced.

IN NO EVENT SHALL SELLER BE LIABLE FOR ANY DIRECT, INCIDENTAL OR CONSEQUENTIAL DAMAGES OF ANY NATURE, OR LOSSES OR EXPENSES RESULTING FROM ANY DEFECTIVE PRODUCT OR THE USE OF ANY PRODUCT.

Owner's Record

The serial number is located inside the battery compartment and the model number is located at the bottom.

Record the serial number in the space provided below. Refer to them whenever you call upon your Sony dealer regarding this product.

Model No. MZ-R3

Serial No. _____

"MD WALKMAN" is a trademark of Sony Corporation.

The headphones with a remote controller

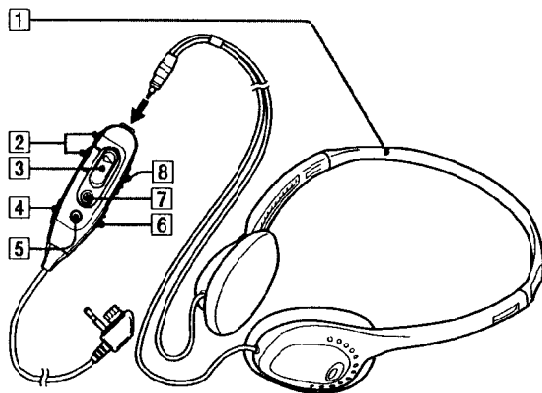

- 1** Headphones
Can be replaced with optional headphones.
- 2** VOL (volume) +/- buttons (9)
- 3** ► (play)/◀◀/▶▶ (search, AMS) buttons (7, 9)
Press ► to play. While playing, press the ◀◀ side to find beginning of the current or preceding tracks or to search backward, or press the ▶▶ side to find the beginning of the succeeding tracks or to search forward.

- 4** TRACK MARK button (13)
- 5** || (pause) button
- 6** AVLS (Automatic Volume Limiter System) switch (2)
Slide to ON to limit the maximum volume.
- 7** ■ (stop) button
- 8** HOLD switch (19)
Slide to lock the controls of the remote controller.

Welcome!

Welcome to the world of the MiniDisc!
Here are some of the capabilities and features you'll discover with the new MiniDisc Recorder.

- High-fidelity recording – High-fidelity sound with little noise and distortion is recorded through the optical digital input jack on the recorder.
- Easy labeling – You can select characters for labeling by simply rotating a dial.
- Various editing functions – You can easily add and erase track marks on the recording, erase a track, erase all the tracks at one time, and change the order of tracks.
- Position indicator – The display shows you the current location on the disc.
- Long-time recording with monaural sound – You can record up to 148 minutes on a disc using monaural recording.
- Date and time stamp function – The built-in clock allows you to record the date and time whenever you make a recording.
- Title function – You can see disc and track titles in the display while you are playing/recording an MD.
- Remote controller – You can play an MD using the remote controller equipped with the stereo headphones.

Table of contents

Recording an MD right away!	6
Playing an MD right away!	8
Various ways of recording	10
Two ways of connection to a sound source	10
Recording with digital input	11
Recording from a microphone	12
Recording in monaural for double the normal recording time of an MD	12
Track marking while recording	13
Tips on recording	14
To monitor the sound being recorded	14
To know the recording condition	14
To start recording precisely	14
To protect a recorded MD	14
To know the remaining time	15
To know the disc name and current time	15
Adjusting the recording level (Manual recording)	16
Setting the clock to stamp the recorded time	17
Various ways of playback	18
Playing tracks repeatedly	18
Tips on playback	18
To know the track name and time	18
To lock the controls	19
To emphasize bass (Bass boost feature)	20
To protect your hearing (AVLS)	20
Connecting to a stereo system	20
Editing recorded tracks	21
Track marking a recording	21
Erasing a track mark	22
Labeling recordings	23
Erasing a track	24
Erasing the whole disc	25
Moving recorded tracks	25

The display window

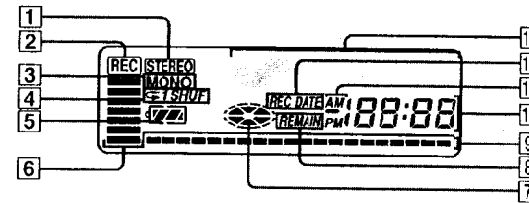

- 1 STEREO indication
- 2 REC indication (7)
Lights up while recording. When flashing, the recorder is in record standby mode.
- 3 MONO (monaural) indication
- 4 Play mode indication (18)
Shows the play mode of the MD.
- 5 Battery indication
Shows battery condition
- 6 Level meter
Shows the volume of the MD being played or recorded.
- 7 Disc indication
Shows that the disc is rotating for recording, playing or editing an MD.
- 8 REMAIN (remaining time/tracks) indication (15, 19)
Lights up along with the remaining time of the track, the remaining time of the MD, or the remaining number of tracks.
- 9 Position indicator (7, 9)
Shows the current location on the MD. The point under recording or playing flashes. The recorded portion lights up.
Current location

Recorded portion
Disc length
- 10 Time display (15, 19)
Shows the recorded time, current time, elapsed time of the track or MD being recorded or played.
- 11 AM/PM indication (17)
Lights up along with the time indication in the 12-hour system.
- 12 REC DATE (recorded/current date) indication (19)
Lights up along with the date and time the MD was recorded. When only "DATE" lights up, the current date and time are displayed.
- 13 Character information display
Displays the disc and track names, date, error messages, track numbers, etc.

Looking at the controls

See pages in () for more details.

The recorder

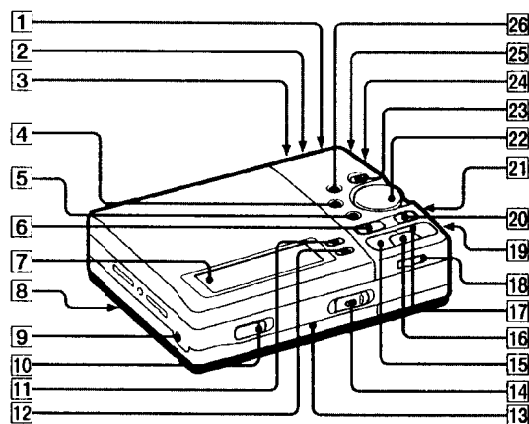

- | | |
|---|---|
| 1 LINE OUT jack (20) | 14 REC (record) switch (7) |
| 2 LINE IN (OPTICAL) jack (6) | 15 ◀◀ (search / AMS) button (7, 9) |
| 3 BASS BOOST switch (20) | 16 ▶▶ (play) button (9) |
| 4 END SEARCH button (7) | 17 ▶▶▶ (search / AMS) button (7, 9) |
| 5 ERASE button (24) | 18 HOLD switch (19) |
| 6 ■ STOP / CHARGE button | 19 VOLUME +/- button (9) |
| 7 Display window (7, 9, 15) | 20 ■■ (pause) button (7, 9) |
| 8 CLOCK SET button (on the bottom) (17) | 21 Battery compartment (on the bottom) (27) |
| 9 DC IN 4.5 V jack (6) | 22 Select dial (23) |
| 10 OPEN button (6) | 23 TITLE / ENTER button (23) |
| 11 DISPLAY button (15) | 24 MIC (PLUG IN POWER) jack (12) |
| 12 MCDE button (12) | 25 ⌂ (headphones) / REMOTE jack (8) |
| 13 Record indicator | 26 TRACK MARK button (13) |

Power sources 27

- Using on dry batteries 27
- Using on a nickel metal hydride rechargeable battery 28
- Using on a lithium ion rechargeable battery 29

Additional information 30

- Precautions 30
- Troubleshooting 32
- System limitations 34
- Error messages 35
- Specifications 37
- What is the MD? 38
- Looking at the controls 40

Recording an MD right away!

Use the supplied line cable to hook up an analog source. The source sound of CDs or tapes will be sent as an analog signal and recorded digitally. The recorded sound will be stereo. Use a "recordable MD" (supplied) to record. Premastered MDs cannot be recorded over.

1 Make connections.

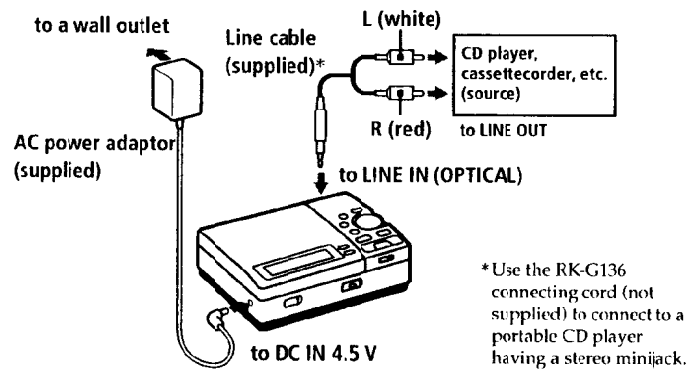

2 Insert a recordable MD.

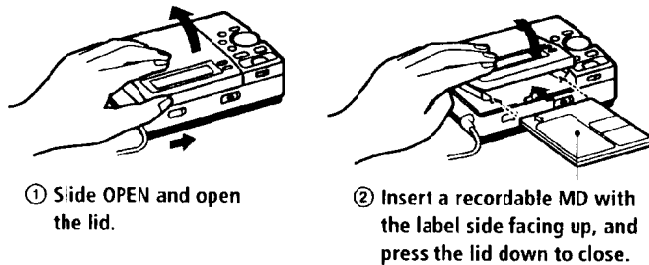

How the MiniDisc got so small
The 2.5-inch MiniDisc, encased in a plastic cartridge that looks like a 3.5-inch diskette (see illustration below), uses a new digital audio compression technology called ATRAC (Adaptive TRAnsform Acoustic Coding). To store more sound in less space, ATRAC extracts and encodes only those frequency components actually audible to the human ear.

Shock-Resistant Memory
One major drawback of optical recording systems is that they can skip or mangle when subjected to vibration. The MD system resolves this problem by using a buffer memory that stores audio data.

Quick Random Access
Like CDs, MDs offer instantaneous random access to the beginning of any music track. Premastered MDs are recorded with location addresses corresponding to each music selection. Recordable MDs are manufactured with a "User TOC Area" to contain the order of the music. The TOC system is similar to the "directory management system" of floppy disks. In other words, starting and ending addresses for all music tracks recorded on the disc are stored in this area. This lets you randomly access the beginning of any track as soon as you enter the track number (AMS), as well as label the location with a track name as you would file on a diskette.

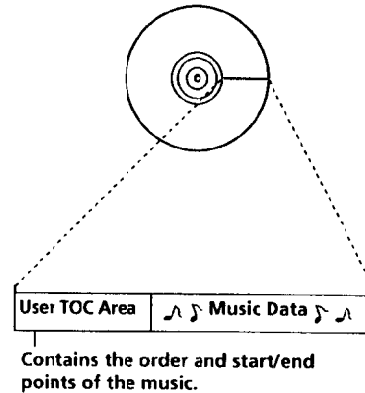

Additional information

Your dealer may not handle some of the above listed accessories. Please ask the dealer for detailed information about the accessories in your country.

US and foreign patents licensed from Dolby Laboratories Licensing Corporation.

Design and specifications are subject to change without notice.

What is the MD?

How MiniDiscs work

MiniDiscs (MD) come in two types: premastered (prerecorded) and recordable (blank). Premastered MDs, recorded at music studios, can be played back almost endlessly. However, they can't be recorded on or over like cassette tapes. To record, you must use a "recordable MD".

Premastered MDs

Premastered MDs are played like regular CDs. A laser beam focuses on the pits in the surface of the MD and reflects the information back to the lens in the recorder. The recorder then decodes the signals and plays them back as music.

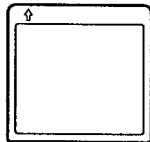

Recordable MDs

Recordable MDs, which use magneto-optical (MO) technology, can be recorded again and again. The laser inside the recorder applies heat to the MD, demagnetizing the magnetic layer of the MD. The recorder then applies a magnetic field to the layer. This magnetic field corresponds exactly to the audio signals generated by the connected source. (The north and south polarities equate to digital "1" and "0".) The demagnetized MD adopts the polarity of the magnetic field, resulting in a recorded MD.

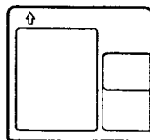

3 Record an MD.

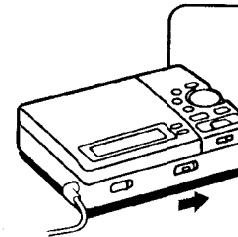

CD player, cassette-corder, etc. (source)

② Play the CD or tape you want to record.

① Slide REC to the right while pressing its button.

"REC" lights up and recording starts from the beginning of the disc. The level of the recorded sound is adjusted automatically.

To stop recording, press ■STOP/CHARGE.

"Toc Edii" flashes to record data of the recording (the track's start and end points, etc.). Do not move or jog the recorder or disconnect the power source while the indication is flashing in the display.

To	Press
Pause	* Press again to resume recording.
Add recording to the end of the previous recording.	END SEARCH and slide REC.
Record over partway through the previous recording.	▶, ▶▶ or ◀◀ to find the start point of recording and press ■STOP/CHARGE to stop. Then slide REC.
Remove the MD.	■STOP/CHARGE and open the lid.**

If the recording does not start

- Make sure the recorder is not locked (page 19).
- Make sure the MD is not record-protected (page 14).

Display window while recording

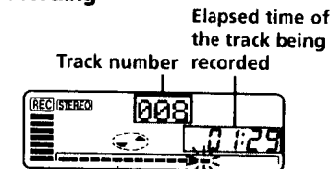

Position indicator (shows the current location on the MD)

- * A new track is added at the point where you pressed ||, and the recording will be marked with the new track number when you resume recording.
- ** Once you open the lid, the point to start recording will change to the beginning of the first track. When recording on a recorded MD, check the point to start recording on the display.

Recording an MD right away!

Playing an MD right away!

If you want to play an MD right now, choose to use your recorder on house current. Other choices are dry batteries and two kinds of rechargeable batteries (see pages 27–29). The recorder automatically switches to play the stereo or monaural sound according to the recorded sound.

1 Make connections.

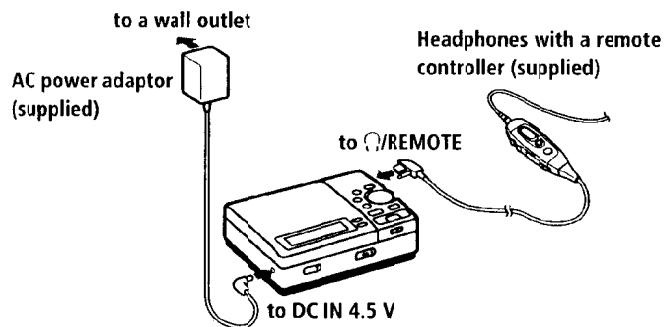

2 Insert an MD.

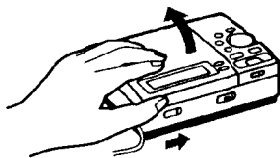

① Slide OPEN and open the lid.

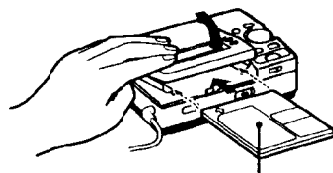

② Insert an MD with the label side facing up, and press the lid down to close.

Specifications

System

Audio playing system

MiniDisc digital audio system

Laser diode properties

Material: GaAlAs

Wavelength: $\lambda = 780 \text{ nm}$

Emission duration: continuous

Laser output: less than $44.6 \mu\text{W}$

(This output is the value measured at a distance of 200 mm from the lens surface on the optical pick-up block.)

Recording and playback time

Maximum 74 minutes (MDW-74, stereo recording)

Maximum 148 minutes (MDW-74, monaural recording)

Revolutions

400 rpm to 900 rpm (CLV)

Error correction

Advanced Cross Interleave Reed

Solomon Code (ACIRC)

Sampling frequency

44.1 kHz

Coding

Adaptive TRansform Acoustic Coding (ATRAC)

Modulation system

EFM (Eight to Fourteen Modulation)

Number of channels

2 stereo channels

1 monaural channel

Frequency response

20 to 20,000 Hz $\pm 2 \text{ dB}$

Wow and Flutter

Below measurable limit

Inputs

Microphone: stereo mini-jack, 0.22–0.78 mV

Line in: stereo mini-jack, 69–194 mV

Optical (Digital) in: optical (digital) mini-jack

Outputs

Headphones: stereo mini-jack, maximum output level 5 mW + 5 mW, load impedance 16 ohm

Line out: stereo mini-jack, 194 mV, load impedance 10 kilohm

General

Power requirements

Sony AC Power Adaptor (supplied) connected at the DC IN 4.5 V jack

120 V AC, 60 Hz (US model)

230–240V AC, 50 Hz (UK model)

240V AC, 50 Hz (Australian model)

Two alkaline batteries (not supplied)

Nickel metal hydride rechargeable battery BP-DM20 (not supplied)

Lithium-ion rechargeable battery LIP-12 (not supplied)

Battery operation time

See "Using on dry batteries" (page 27)

Dimensions

Approx. 115.8 × 29.8 × 81 mm (w/h/d)
(4 5/8 × 1 3/16 × 3 1/4 in.)

Mass

Approx. 265 g (9.4 oz) the recorder only
Approx. 360 g (12.7 oz) incl. a recordable MD, remote controller, and two size AA (R6) batteries

Supplied accessories

AC power adaptor (1)

Connecting cord (1)

Headphones with a remote controller (1)

Battery case (1, for LIP-12 Lithium-ion Battery)

Recordable MD (1)

Carrying case (1)

Optional accessories

BP-DM20 nickel metal hydride rechargeable battery

LIP-12 Lithium-ion rechargeable battery

ACP-MZ60A* AC Power Adaptor/Battery Charger

PDC-MZ1, POC-MZ2 Optical Cable

CPA-8 Car Connecting Pack

ECM-909A, ECM-727P, ECM-717 Stereo Microphones

MDR-D55, MDR-D77 Stereo Headphones

SRS-A50 Sony Active Speakers

MDW-74/74A, MDW-74L/74R/74Y,

MDW-60/60A Recordable MDs

CK-MD4 MiniDisc Carrying Case

CK-MD10 MiniDisc Filing Box

* ACP-MZ60A can only be used as a battery charger. It cannot be used as an AC power adaptor with this recorder.

Error message	Meaning/Remedy
NO SIGNAL	<ul style="list-style-type: none"> • There is no digital input signal. <ul style="list-style-type: none"> ➔ Make sure that the source is connected firmly and it has the same sampling frequency as the recorder (44.1kHz). • When recording from a portable CD player using digital input, set it to pause mode and then start recording. • If the error message appears while recording, press ■STOP/CHARGE to stop recording.
PB DISC	<ul style="list-style-type: none"> • You tried to record or edit on a premastered MD (PB means playback.) <ul style="list-style-type: none"> ➔ Insert a recordable MD.
PROTECTED	<ul style="list-style-type: none"> • You tried to record or edit on a MD with the tab in the record-protect position. <ul style="list-style-type: none"> ➔ Slide the tab back (page 14).
TEMP OVER	<ul style="list-style-type: none"> • Heat has built up in the recorder. <ul style="list-style-type: none"> ➔ Leave the recorder to cool down.
TR FULL	<ul style="list-style-type: none"> • There is no more space for new data when you are editing the MD. <ul style="list-style-type: none"> ➔ Erase unnecessary tracks (page 24).
TRprotect	<ul style="list-style-type: none"> • You tried to record or edit on a track that is protected from erasing. <ul style="list-style-type: none"> ➔ Record or edit on other tracks.

Play an MD.

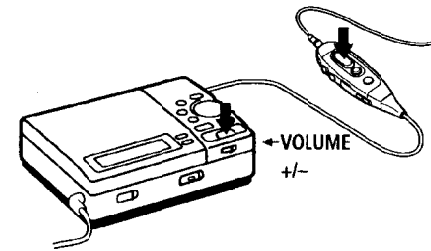

- ① Press .
- The recorder starts to play the first track. A short beep sounds in the headphones.

- ② Press VOLUME +/- to adjust the volume.
- You can check the volume in the display.

To stop play, press ■STOP/CHARGE. A long beep sounds in the headphones.

If the play does not start
Make sure the recorder is not locked (page 19).

Display window while playing back

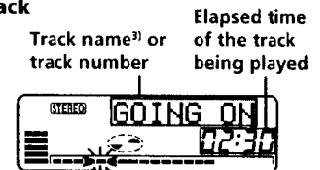

Position indicator (shows the current location on the MD)

To	Press (Beeps in the headphones)
Pause	(Continuous short beeps) Press again to resume play.
Find the beginning of the current track	⏮ once (Three short beeps)
Find the beginning of the next track	⏭ once (Two short beeps)
Go backwards while playing ¹⁾	keep pressing ⏮
Go forward while playing ¹⁾	keep pressing ⏭
Remove the MD	■ STOP/CHARGE and open the lid. ²⁾

- 1) To go backward or forward quickly without listening, press || and keep pressing ⏮ or ⏭.
- 2) Once you open the lid, the point to start play will change to the beginning of the first track.
- 3) Appears only with MDs that have been electronically labeled.

Playing an MD right away!

► Various ways of recording

Two ways of connection to a sound source

The input jack of this recorder works as both digital and analog input jack. Connect the recorder to a CD player or a cassette-corder using either digital input or analog input. To record, see "Recording with digital input" (page 11) to record using digital input, and "Recording an MD right away!" (page 5) to record using analog input.

Difference between digital and analog inputs

Difference (connection)	Input	Digital input	Analog (line) input
Connectable source		Equipment with an optical digital output jack	Equipment with an analog (line) output jack
Usable cord		Digital cable (with an optical or an optical-mini plug)	Line cable (with 2 phono plugs or a stereo-mini plug)
Signal from the source		Digital	Analog Even when a digital source (such as a CD) is connected, the signal sent to the recorder is analog.
Recorded track numbers		Marked (copied) automatically at the same positions as the source.	Marked after more than 2 seconds of silence. You can erase unnecessary marks after recording ("Erasing a track mark", page 22).
Recorded sound level		Same as the source	Adjusted automatically. Can also be adjusted manually ("Adjusting the recording level", page 16).

Note

Track marks may be copied incorrectly

- when you record from some CD players or multi disc players using digital input.
- when the source is in shuffle or program play mode while recording using digital input. In this case, play the source in normal play mode.

Error messages

If the following error messages flash in the display window, check the chart below.

Error message	Meaning/Remedy
BLANKDISC	<ul style="list-style-type: none"> • An MD with no recording on it is inserted. ➔ Insert a recorded MD.
BUSY	<ul style="list-style-type: none"> • You tried to operate the recorder while it was accessing the recorded data. ➔ Wait until the message goes out (in rare cases, it may take 2-3 minutes).
CANNOT	<ul style="list-style-type: none"> • You tried to erase a track mark while playing the MD or at the beginning of the first track. • You tried to erase a track mark to combine tracks the recorder cannot combine. (caused by system limitation)
DISC ERR	<ul style="list-style-type: none"> • The recorder cannot read the disc (it's scratched or dirty). ➔ Reinsert or replace the disc.
DISC FULL	<ul style="list-style-type: none"> • There is no more space on the disc (less than 12 seconds available). ➔ Replace the disc.
FULL	<ul style="list-style-type: none"> • You tried to enter more than 200 characters of track and disc name or the characters entered in an MD are more than 1700. ➔ Enter the characters within the limit.
Hi DC in	<ul style="list-style-type: none"> • Power supply is too high (The supplied AC power adaptor or the recommended car battery cord is not used). ➔ Use the supplied AC power adaptor or the recommended car battery cord.
HOLD	<ul style="list-style-type: none"> • The recorder is locked. ➔ Slide HOLD against the allow to unlock the recorder (page 19).
LOW BATT	<ul style="list-style-type: none"> • Batteries are weak. ➔ Replace the dry batteries or charge the rechargeable battery (pages 27-29).
NO COPY	<ul style="list-style-type: none"> • You tried to make a copy from a disc that is protected by the Serial Copy Management System. You cannot make copies from a digitally connected source which was itself recorded using the digital connection. ➔ Use the analog connection instead (page 6).
NO DISC	<ul style="list-style-type: none"> • You tried to play or record with no disc in the recorder. ➔ Insert an MD.

System limitations

The recording system in your MiniDisc recorder is radically different from those used in cassette and DAT decks and is characterized by the limitations described below. Note, however, that these limitations are due to the inherent nature of the MD recording system itself and not to mechanical causes.

Symptom	Cause
"TR FULL" appears even before the disc has reached the maximum recording time (60 or 74 minutes).	When 254 tracks have been recorded on the disc, "TR FULL" appears regardless of the total recorded time. More than 254 tracks cannot be recorded on the disc. To continue recording, erase unnecessary tracks.
"TR FULL" appears even before the disc has reached the maximum track number or recording time.	Repeating recording and erasing may cause fragmentation and scattering of data. Although those scattered data can be read, each fragment is counted as a track. In this case, the number of tracks may reach 254 and further recording is not possible. To continue recording, erase unnecessary tracks.
Track marks cannot be erased.	When the data of a track is fragmented, the track mark of a fragment under 12 seconds long cannot be erased.
The remaining recording time does not increase even after erasing numerous short tracks.	Tracks of under 12 seconds in length are not counted and so erasing them may not lead to an increase in the recording time.
The total recorded time and the remaining time on the disc may not total the maximum recording time (60 or 74 minutes).	Recording is done in minimum units of 2 seconds each, no matter how short the material. Even if the last unit of recording is less than 2 seconds, it is counted as a unit of 2 seconds. Then 2 seconds' space is put before recording starts again to prevent the last unit of the previous track from being erased. The contents recorded may thus be shorter than the maximum recording capacity.
The edited tracks may exhibit sound dropout during search operations.	The fragmentation of data may cause sound dropout while searching because the tracks are played in higher speed than normal playback.

Recording with digital input

Use an optical cable (POC-MZ1 or POC-MZ2, not supplied) to hook up a digital source such as a CD, etc. The source sound will be sent and recorded as a digital signal.

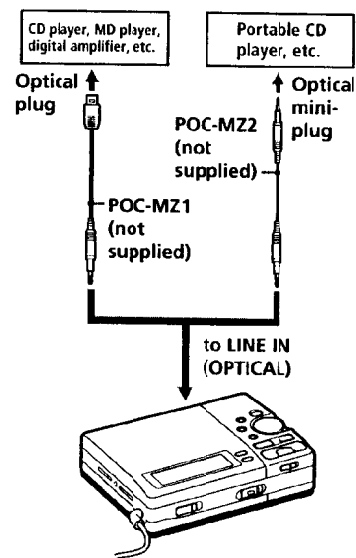

Insert a recordable MD and start recording.

To record, see "Recording an MD right away!" (page 6). To record from a portable CD player, put the CD player on pause and then start recording.

LINE IN (OPTICAL) jack is for both digital and analog input

The recorder automatically recognizes the line cable and switches to digital or analog input.

Notes

- A digital source which has a different sampling frequency (such as the DAT Walkman) cannot be recorded using the digital connection. Use instead the analog (line out) connection (see "Recording an MD right away!" (page 6).
- You can make a digital recording only from an optical type output.
- If you use the above connection to record your MD, you will not be able to make copies from the recorded disc. You can only make copies from a home-recorded MD by using the analog (line out) connection.

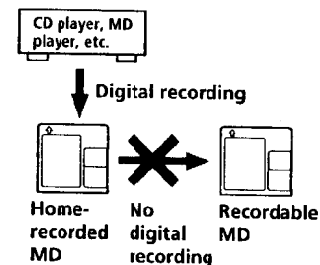

Recording from a microphone

Connect a stereo microphone ECM-909A, ECM-727P, ECM-717, etc., (not supplied) at the MIC (PLUG IN POWER) jack.

Note

To record from a microphone, you must first disconnect any digital source. If connected, the recorder will not switch to microphone input.

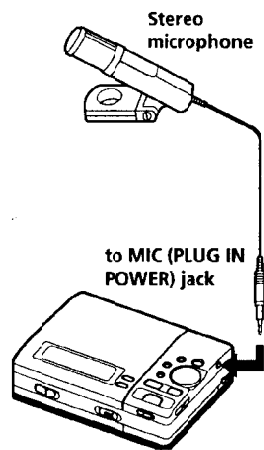

Insert a recordable MD and start recording.
To record, see "Recording an MD right away!" (page 6).

Recording in monaural for double the normal recording time of an MD

For longer recordings, choose to record in monaural sound. The recording time becomes double the normal.

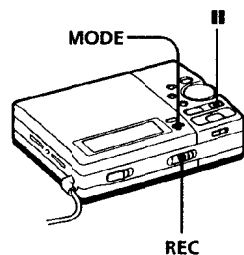

- 1 While pressing **II**, slide REC to the right to enter record standby mode.
- 2 Press MODE. "Mono REC" appears in the display, and the recorder switches to monaural recording.
- 3 Press **II** again to start recording.
- 4 Play the sound source.

To stop recording, press **■**STOP/CHARGE.

The recorder switches back to stereo recording when you record next time.

Notes

- If you record in monaural sound from a stereo source using a digital cable, only the left channel sound of the source will be recorded.
- The MDs recorded in monaural sound can be played back only with an MD player/recorder that has the monaural playing function.

Symptom	Cause/Solution
Playback sound skips.	<ul style="list-style-type: none"> • The recorder is placed where it receives continuous vibration. ➔ Put the recorder on stable place. ➔ A very short track may cause sound to skip.
Sound has a lot of static.	<ul style="list-style-type: none"> • Strong magnetism from a television or such device is interfering with operation. ➔ Move away from the source of strong magnetism.
Cannot find the track marks.	<ul style="list-style-type: none"> • You pressed II after pressing ◀◀ or ▶▶. ➔ Press II before pressing ◀◀ or ▶▶.
Charging the rechargeable battery does not start.	<ul style="list-style-type: none"> • The rechargeable battery has been inserted incorrectly or the AC power adaptor has been connected incorrectly. ➔ Insert the battery correctly or connect the AC power adaptor correctly.
The clock loses time or the display flashes.	<ul style="list-style-type: none"> • The built-in battery for a clock is weak. ➔ Connect the AC power adaptor to DC IN 4.5 V on the recorder and the wall outlet to charge the built-in battery. After charging, set the clock again. Note that the clock normally loses about 2 minutes per month (page 17).
The recording date was not stamped onto the disc.	

Troubleshooting

Should any problem persists after you have made these checks, consult your nearest Sony dealer.

Symptom	Cause/Solution
The recorder does not work or works poorly.	<ul style="list-style-type: none"> • Audio sources may not be securely connected. <ul style="list-style-type: none"> ➔ Disconnect the audio sources once and connect them again (page 6). • Moisture has condensed inside the recorder. <ul style="list-style-type: none"> ➔ Take the MD out and leave the recorder in a warm place for several hours until the moisture evaporates. • The dry batteries or rechargeable battery are weak (□“LOW BATT” flashes). <ul style="list-style-type: none"> ➔ Replace the dry batteries or recharge the battery (pages 27–29). • The dry batteries have been installed incorrectly. <ul style="list-style-type: none"> ➔ Install the batteries correctly (page 27). • You pressed a button while the disc indication was rotating quickly. <ul style="list-style-type: none"> ➔ Wait until the indication rotates slowly. • The recording volume is too low. • The AC adaptor was unplugged during recording or a power outage occurred. • While operating, the recorder received a mechanical shock, too much static, abnormal power voltage caused by lightning, etc. <ul style="list-style-type: none"> ➔ Restart the operation as follows. <ol style="list-style-type: none"> 1 Disconnect all the power sources. 2 Leave the recorder for about 30 seconds. 3 Connect the power source.
No sound comes through the headphones.	<ul style="list-style-type: none"> • The headphones plug is not firmly connected. <ul style="list-style-type: none"> ➔ Connect the headphones with a remote controller plug firmly to ◯/REMOTE. • Volume is too low. <ul style="list-style-type: none"> ➔ Adjust the volume by pressing VOLUME +/- (VOL +/- on the remote commander). • AVLS is on. <ul style="list-style-type: none"> ➔ Slide AVLS to OFF (page 20).
An MD is not played from the first track.	<ul style="list-style-type: none"> • Disc playing stopped before it came to the last track. <ul style="list-style-type: none"> ➔ Press ◀ repeatedly or open and close the lid once to go back to the beginning of the disc, and restart playing after checking the track number in the display.

Track marking while recording

Track marking essentially adds tracks while recording and enables you to quickly find and play from the marked position. The track marking feature is useful particularly when recording a discussion, etc., from a microphone.

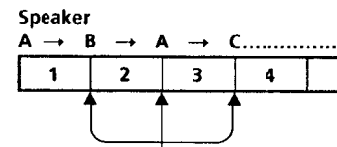

Add track marks when the speaker changes.

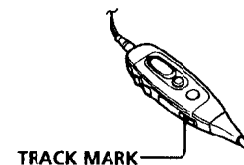
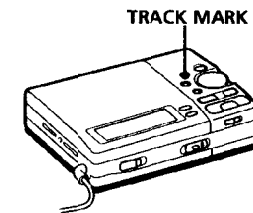

While recording, press TRACK MARK

A track mark is added and the track number will increase by one. When you add a mark, the record indicator flashes and a short beep sounds in headphones.

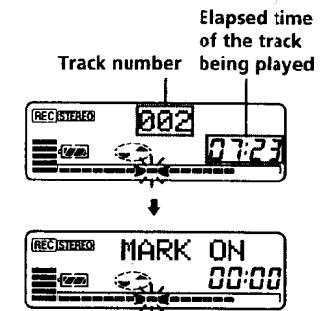

To add track marks after recording
See "Track marking a recording" (page 21).

To erase track marks
See "Erasing a track mark" (page 22).

Tape recording

To monitor the sound being recorded

Connect the headphones to Ω /REMOTE and adjust the volume by pressing VOLUME +/- (VOL +/- on the remote commander). Sound levels are copied onto the MD automatically and independently of the volume for monitoring.

To know the recording condition

The record indicator lights up or flashes according to the recording condition.

Recording condition	Record indicator
While recording	lights up flashes according to the loudness of the source while recording with a microphone (voice mirror)
Recording standby	flashes
Recording with less than 3 minutes' recording time available	slowly flashes

To start recording precisely

- 1 While pressing **II**, slide REC to the right to enter record standby mode.
- 2 Press **II** again to start recording.
- 3 Play the sound source.
The sound source is recorded from the beginning.

To protect a recorded MD

To record-protect an MD, slide open the tab at the side of the MD. In this position, the MD cannot be recorded. To record again, slide the tab back so the tab is visible.

Back of the MD

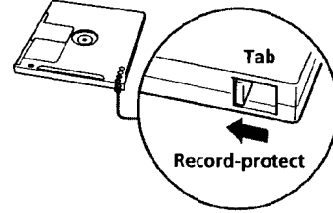

Notes on the batteries

Incorrect battery usage may lead to leakage of battery fluid or bursting batteries. To prevent such accidents, observe the following precautions:

- Install the + and - poles of the batteries correctly.
- Do not install new and used batteries or different kinds of batteries together.
- Do not try to recharge the batteries.
- When the recorder is not to be used for a long time, be sure to remove the batteries.
- If a battery leak should develop, carefully and thoroughly wipe away battery fluid from the battery compartment before inserting new ones.

Note on mechanical noise

The recorder gives out mechanical noise while operating, which is caused by the power-saving system of the recorder and it is not a trouble.

For Customers in the USA

DISPOSAL OF MANGANESE DIOXIDE LITHIUM BATTERY, NICKEL METAL HYDRIDE BATTERY AND LITHIUM ION BATTERY.

MANGANESE DIOXIDE LITHIUM BATTERY, NICKEL METAL HYDRIDE BATTERY AND LITHIUM ION BATTERY. DISPOSE OF PROPERLY.

You can return your unwanted manganese dioxide lithium batteries, nickel metal hydride batteries and lithium ion batteries to your nearest Sony Service Center.

Note: In some areas the disposal of manganese dioxide lithium batteries, nickel metal hydride batteries and lithium ion batteries in household or business trash may be prohibited.

For the Sony Service Center near you call 1-800-222-SONY (United States only)

Caution: Do not handle damaged or leaking manganese dioxide lithium battery, nickel metal hydride battery and lithium ion battery.

To remove the manganese dioxide lithium battery

On disposal of this product, remove the manganese dioxide lithium battery in the battery compartment and treat it as mentioned above.

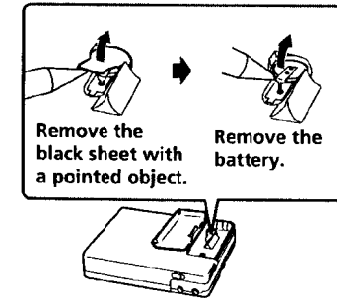

Do not remove the black sheet unless you are disposing of this product, or it may not work properly.

If you have any questions or problems concerning your recorder, please consult your nearest Sony dealer.

Additional information

► Additional information

Precautions

On safety

Do not put any foreign objects in the DC IN 4.5 V jack.

On power sources

- Use the house current, two size AA (R6) batteries, nickel metal hydride rechargeable battery, lithium ion rechargeable battery, or car battery.
- For use in your house: Use the AC power adaptor supplied with this recorder. Do not use any other AC power adaptor since it may cause the recorder to malfunction.

Polarity of the plug



- The recorder is not disconnected from the AC power source (mains) as long as it is connected to the wall outlet, even if the recorder itself has been turned off.
- If you are not going to use this recorder for a long time, be sure to disconnect the power supply (AC power adaptor, dry batteries, rechargeable batteries, or car battery cord). To remove the AC power adaptor from the wall outlet, grasp the adaptor plug itself, never pull the cord.
- For use in the car: Use the CPA-8 car connecting pack (not supplied).

On heat build-up

Heat may build up in the recorder if it is used for an extended period of time. In this case, leave the recorder to cool down.

On installation

- Never use the recorder where it will be subjected to extremes of light, temperature, moisture or vibration.
- Never wrap the recorder in anything when it is being used with

the AC power adaptor. Heat build-up in the recorder may cause malfunction or injury.

On the headphones

Road safety

Do not use headphones while driving, cycling, or operating any motorized vehicle. It may create a traffic hazard and is illegal in many areas. It can also be potentially dangerous to play your recorder at high volume while walking, especially at pedestrian crossings. You should exercise extreme caution or discontinue use in potentially hazardous situations.

Preventing hearing damage

Avoid using headphones at high volume. Hearing experts advise against continuous, loud and extended play. If you experience a ringing in your ears, reduce the volume or discontinue use.

Caring for others

Keep the volume at a moderate level. This will allow you to hear outside sounds and to be considerate of the people around you.

On the MiniDisc cartridge

- Do not break open the shutter.
- Do not place the cartridge where it will be subject to light, temperature, moisture or dust.

On cleaning

- Clean the recorder casing with a soft cloth slightly moistened with water or a mild detergent solution. Do not use any type of abrasive pad, scouring powder or solvent such as alcohol or benzene as it may mar the finish of the casing.
- Wipe the disc cartridge with a dry cloth to remove dirt.
- Dust on the lens may prevent the unit from operating properly. Be sure to close the disc compartment lid after inserting and ejecting an MD.

To know the remaining time

Press DISPLAY while recording. Each time you press the button, the display changes as follows.

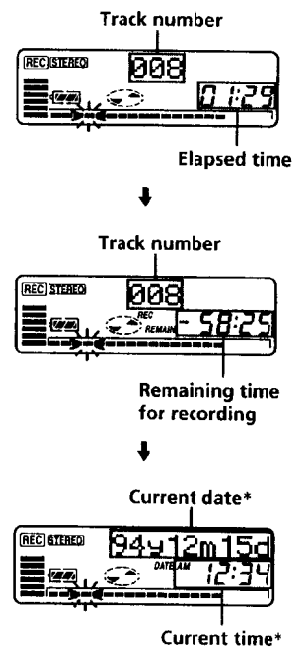

* Appears only when the clock is set.

To know the disc name and current time

Press DISPLAY while the recorder is in stop mode.

Each time you press the button, the display changes as follows.

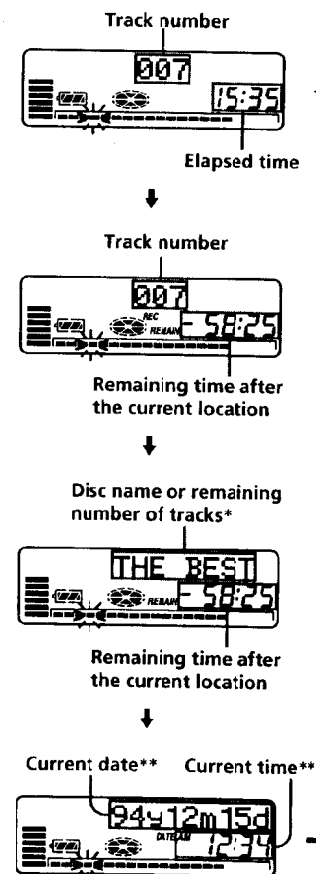

* Remaining number of tracks appears when the MD has no disc name.

** Appears only when the clock is set

Various ways of recording

Adjusting the recording level (Manual recording)

When you record with a microphone or an analog input, the sound level is adjusted automatically. If necessary, you can set the level manually.

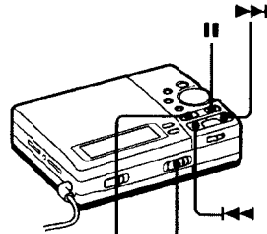

■ STOP/CHARGE REC

- 1 While holding down ■, hold REC to the right for more than 2 seconds. "ManualREC" appears and the recorder enters record pause mode. To return to the automatic control, while the recorder is in record pause mode, hold REC to the right for more than 2 seconds.



- 2 Play the source.

- 3 While observing the level meter in the display, adjust the recording level by pressing ► (+) or ◀ (-). Set the level to around the middle of the level meter.

Volume
decreases increases



Level meter

Note

The recording level should be adjusted while the recorder is in standby mode. You cannot adjust it while recording.

- 4 Press ■ again to start recording.
- 5 Press ■ STOP/CHARGE to stop recording. The recording level control is switched back to automatic control.

Using on a lithium ion rechargeable battery

Before using the LIP-12 lithium ion rechargeable battery (not supplied) for the first time, charge it with the ACP-MZ60A battery charger (not supplied).

- 1 Attach the battery case (supplied).

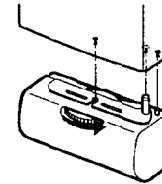

- 2 Insert the charged battery into the battery case.

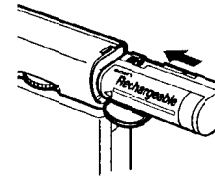
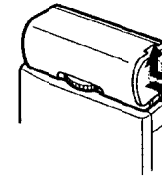

Note

You cannot charge the battery in the recorder.

Using on a nickel metal hydride rechargeable battery

Before using the rechargeable battery (not supplied) for the first time, charge it.

- 1 Connect the supplied AC power adaptor.

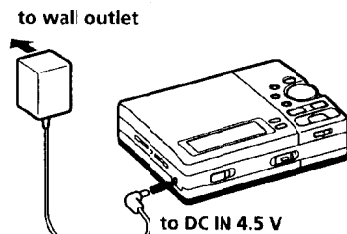

AC power adaptor (supplied)

- 2 Insert the battery, and close the lid.

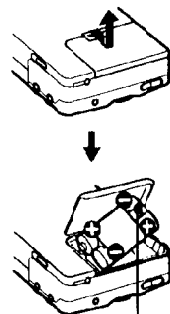

The projection on the battery comes on the right.

- 3 Press ■STOP/CHARGE on the recorder. "Charging" and the battery indication appear in the display and charging starts. When charging is completed, "Charging" and the battery indication go out. A completely discharged battery takes about 3 hours to charge fully. To stop charging before the battery is fully charged, press ■STOP/CHARGE.

- 4 Disconnect the AC power adaptor. As long as the recorder is connected to the AC power, the power will be supplied from the AC source instead of the battery.

Notes

- Be sure to use the supplied AC power adaptor.
- Charging time may vary depending on the battery condition.
- When you use the battery for the first time or after a long period of disuse, the battery life may be shorter. In this case, charge and discharge the battery several times. The battery life will be restored.
- If the rechargeable battery capacity becomes half the normal life, replace it with a new one.

Setting the clock to stamp the recorded time

To stamp the date and time on the MD when you record, you first need to set the clock. When you use the recorder for the first time or after a long period of disuse, charge the built-in battery for the clock after setting the clock.

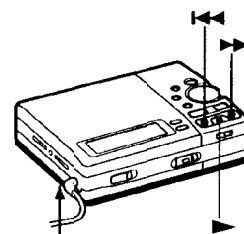

CLOCK SET (on the bottom)

- 1 Connect the power source. Use the supplied AC power adaptor.
- 2 Press CLOCK SET at the bottom of the recorder. Use a pointed object. The digits of the year flash.

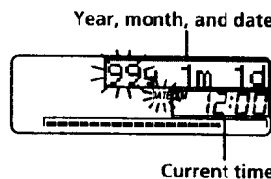

- 3 Enter the current year by pressing ◀◀ or ▶▶. To change the digits rapidly, keep pressing ◀◀ or ▶▶.

- 4 Press ▶. The digit of the month flashes.



- 5 Repeat steps 3 and 4 to enter the current month, date, hour, and minute. When you press ▶ to set the minute, the clock starts operating.

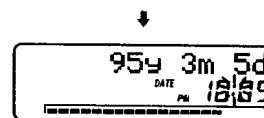
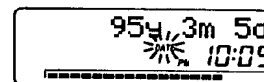

If you make a mistake while setting the clock

Press ■STOP/CHARGE, and set the clock again from step 2. You can skip a step by pressing ▶.

Charging the built-in battery for the clock

After setting the clock, leave the recorder connected to the AC power for about 2 hours to charge the built-in battery for the clock. Once charged, the built-in battery should last about a month without connecting to any of the power sources. The recorder will automatically charge the built-in battery while connected to AC power, dry batteries or a rechargeable battery.

On the clock display

- To display the current time
When the recorder is not operating or while recording, press DISPLAY repeatedly until the current time appears in the display. The time indication disappears after 10 seconds.
- To display the time in the 24-hour system
While setting the clock, press DISPLAY. To display the time in the 12-hour system, press DISPLAY again.

► **Various ways of
back**

Playing tracks repeatedly

You can play tracks repeatedly in three ways—all repeat, single repeat, and shuffle repeat.

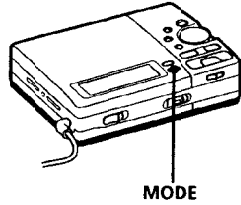

Press MODE while the recorder is playing an MD. Each time you press MODE, the play mode indication changes as follows.

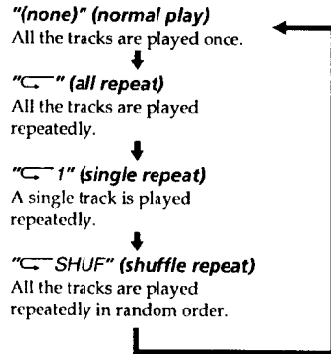
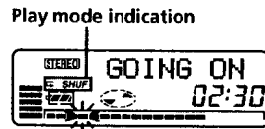

Tips on playback

To know the track name and time

Press DISPLAY while the recorder is playing an MD. Each time you press DISPLAY, the display changes as follows.

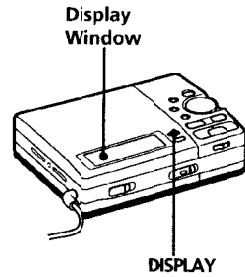

► **Power sources**

You can use the recorder on house current, dry batteries, a nickel metal hydride rechargeable battery, or a lithium ion rechargeable battery.

Using on dry batteries

It is preferable to use the recorder on house current when recording for a long time. Install two size AA (R6) alkaline batteries (not supplied), and close the lid.

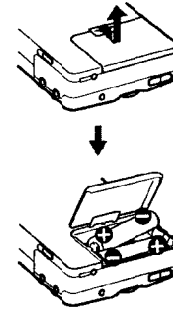

When to replace or charge the batteries

You can check the battery condition with the battery indication displayed while using the recorder.

- ☐ Used batteries
- ↓
- ☐ Weak batteries. Replace all the batteries
- ↓
- ☐ The batteries have gone out. "LOW BATT" flashes in the display, and the power goes off.

Battery life*

Batteries	Record- ing**	Playback
size AA (R6) alkaline batteries	Approx. 2 hours	Approx. 4 hours
Nickel metal hydride rechargeable battery (BP-DM20)	Approx. 2 hours	Approx. 3 hours
Lithium ion rechargeable battery (LIP-12)	Approx. 2.5 hours	Approx. 4 hours
size AA (R6) alkaline batteries and a lithium ion rechargeable battery (LIP-12)	Approx. 4.5 hours	Approx. 8 hours
Nickel metal hydride rechargeable battery (BP-DM20) and a lithium ion rechargeable battery (LIP-12)	Approx. 4.5 hours	Approx. 7 hours

* The battery life may be shorter due to operating conditions and the temperature of the location.
** When you record, use a fully charged rechargeable battery or new dry batteries.

- 4** Press TITLE/ENTER again. Moving is completed and the recorder plays the moved track.

Notes

- When you press ■STOP/CHARGE after you moved a track, "Toc Edit" flashes and the recorder starts writing the new data to the MD. Do not move or jog the recorder while "Toc Edit" is flashing in the display.
- You cannot move tracks on an MD that is record-protected. Before moving tracks, close the tab on the side of the MD.

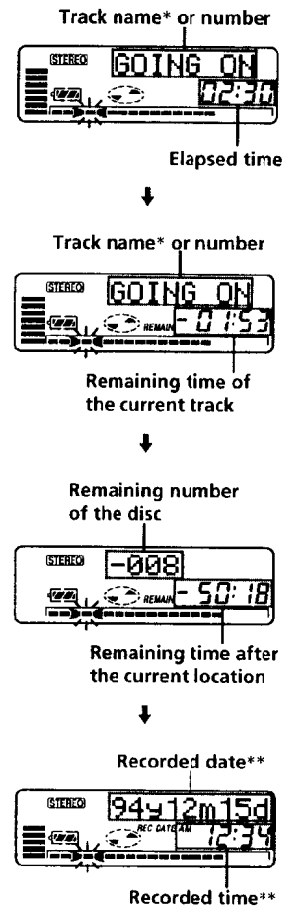

To lock the controls

To prevent the buttons from being accidentally operated when you carry the recorder, use this function.

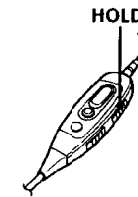
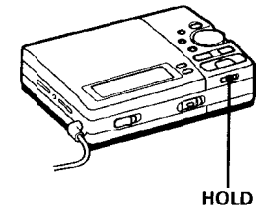

Slide HOLD in the direction of the →. On the recorder, slide HOLD to lock the controls of the recorder. On the remote controller, slide HOLD to lock the controls of the remote controller.

Various ways of playback

* Appears only with MDs that have been electronically labeled.

** If you record without setting the clock or play an MD that has no recorded date, "--y--m--d" and "--:--:" appear.

Emphasize bass (Bass boost feature)
The Bass Boost feature intensifies low frequency sound for richer quality audio reproduction.

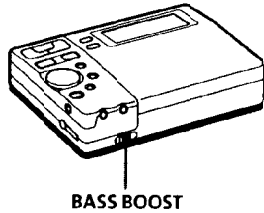

Slide BASS BOOST. Choose MID (slight effect) or MAX (strong effect). To cancel the effect, set BASS BOOST to NORM.

Notes

- If the sound is distorted when emphasizing bass, turn down the volume
- This feature does not affect the sound being recorded.

To protect your hearing (AVLS)

The AVLS (Automatic Volume Limiter System) function keeps down the maximum volume to prevent excessive sound from harming your ears.

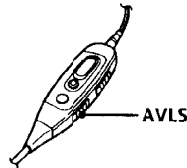

Set AVLS on the remote controller to ON. The volume is kept at a moderate level, even if you try to turn the volume above the limited level.

Connecting to a stereo system

Connect the LINE OUT jack of the recorder to the LINE IN jacks of an amplifier or a tape player with the supplied line cable (or RK-G136, not supplied). The output is analog. The recorder plays the MD digitally and sends analog signals to the connected equipment.

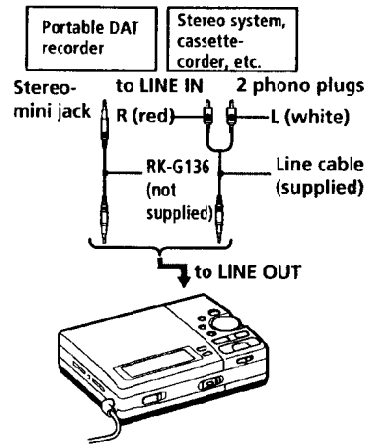

Erasing the whole disc

You can quickly erase all the tracks and data of the MD at a time. Note that once a recording has been erased, you cannot retrieve it.

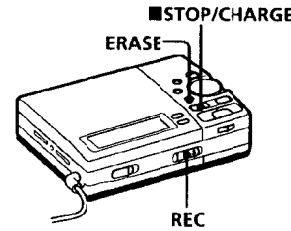

- 1 Play the MD you want to erase. Check the contents of the disc.
- 2 Press ■STOP/CHARGE to stop.
- 3 While pressing ERASE, slide REC to the right. "AllErase" and "PushErase" appear in the display alternately. To cancel erasing, press ■STOP/CHARGE.
- 4 Press ERASE again. "Tot Edit" flashes in the display. When erasing finishes, "BLANKDISC" appears.

Notes

- Do not move or jog the recorder while "Tot Edit" is flashing in the display.
- You cannot erase recordings on an MD that is record-protected. Before erasing, close the tab on the side of the MD.

Moving recorded tracks

You can change the order of the recorded tracks.

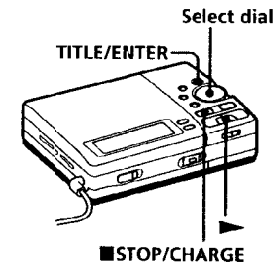
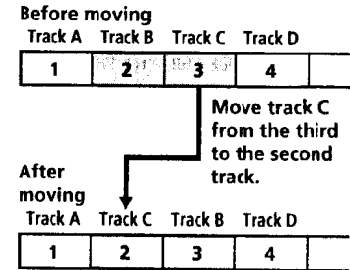

- 1 Play the track you want to move.
- 2 While pressing ►, press TITLE/ENTER. The recorder plays the selected track repeatedly. To cancel moving, press ■STOP/CHARGE.
- 3 Rotate the select dial to select the new track position.

When moving a track to the second track



Continue to next page → 25

Editing recorded tracks

Erasing a track mark

When you record with analog (line) input, unnecessary track marks may be recorded. You can erase a track mark to combine the tracks before and after the track mark. The track numbers will change as follows.

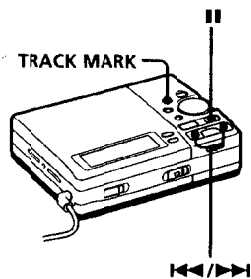
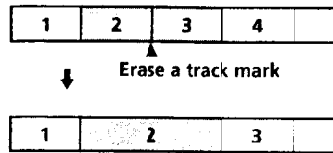

- 1 While the recorder is playing an MD, press **||** to pause.
- 2 Find the track mark you want to erase by pressing **◀◀** or **▶▶** slightly. "MARK" appears in the display. For example, to erase the third track mark, find the beginning of the third track.

Appears for about 2 seconds



- 3 Press **TRACK MARK** on the recorder to erase the mark. The track mark is erased and the two tracks are combined.

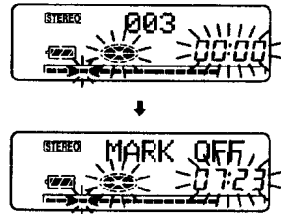

- To erase other track marks**
Repeat steps 2 and 3.

Notes

- When you press **■STOP/CHARGE** after erasing track marks, "Toc Edit" flashes and the recorder starts writing the new data to the MD. Do not move or jog the recorder while "Toc Edit" is flashing in the display.
- You cannot erase track marks on an MD that is record-protected. Before erasing track marks, close the tab on the side of the MD.

Date and time recorded

The combined track whose mark has been erased is recorded with the date and time of the beginning of the first of the two combined tracks.

Labeling recordings

You can label the MDs and tracks you recorded with letters, numbers, and marks. Each label can be made up of up to 200 characters, and each MD can be made up of up to 1700 characters.

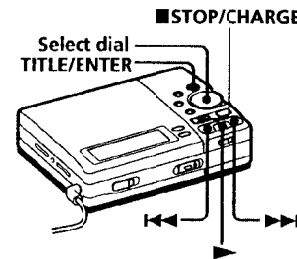

- 1 Insert the MD you want to label. Make sure it is a recordable MD. If the MD is already inserted, press **■STOP/CHARGE** so that the recorder stops operating. Or, to label a particular track, play that track.
- 2 Press **TITLE/ENTER** on the recorder. If you have selected a track in step 1 above, the recorder will play that track repeatedly.
- 3 Rotate the select dial to select a character. Press **▶** to select the first of capital letters, small letters, and numbers quickly.
- 4 Press **▶▶** to move to the next character. Press **◀◀** to move backward.
- 5 Repeat steps 3 and 4 until you have entered all the characters for the label.
- 6 Press the **TITLE/ENTER**. Labeling is completed.

To cancel labeling

Press **■STOP/CHARGE**.

Available characters

- Capital and small letters of the English alphabet
- Numbers 0 to 9
- ! " # \$ % & () * + - . ; < = > ? @ _ ` ' , / : _ (space)

To relabel recordings

Do steps 1 and 2 to display the label of the track or MD. Enter a new character over the one you want to change. To add a character one by one to an already existing name, press **END SEARCH**. To erase characters one by one, press **ERASE**.

Notes

- When you press **■STOP/CHARGE** after labeling, "Toc Edit" flashes and the recorder starts writing the new data to the MD. Do not move or jog the recorder while "Toc Edit" is flashing in the display.
- You cannot label recordings on an MD that is record-protected. Before labeling, close the tab on the side of the MD.
- You cannot relabel premastered MDs or label MDs that have not been recorded.

Erasing a track

Note that once a recording has been erased, you cannot retrieve it. Check the track number before erasing.

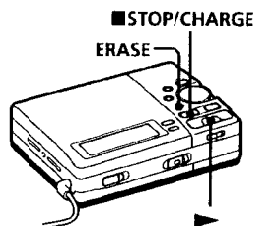

- 1 Play the track you want to erase.
- 2 Press ERASE while playing the track. "AllErase?" and "PushErase" appear in the display alternately, and the recorder plays the selected track repeatedly. To cancel erasing, press ■STOP/CHARGE.
- 3 Check the track number in the display and press ERASE again. The track is erased from the MD and the remaining tracks are renumbered. The recorder then starts to play the succeeding track. If you have erased the last track of the MD, the recorder pauses at the end of the preceding track.

To erase other tracks

Repeat steps 1 to 3.

To erase a part of a track

Add track marks at the beginning and the end of the part you want to erase, then erase the part.

Notes

- When you press ■STOP/CHARGE after erasing a track, "Toc Edit" flashes and the recorder starts writing the new data to the MD. Do not move or jog the recorder while "Toc Edit" is flashing in the display.
- You cannot erase a track on an MD that is record-protected. Before erasing a track, close the tab on the side of the MD.

▶Editing recorded tracks

You can edit your recordings by adding track marks or labeling tracks and MDs. Premastered MDs cannot be edited.

Track marking a recording

You can add track marks so that you can quickly find and play from the marked position.

The track numbers will increase as follows.

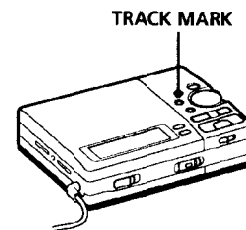
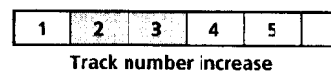
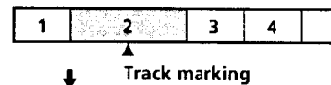

While the recorder is playing an MD, press TRACK MARK on the recorder at the point you want to mark. A track mark is added and the track number will increase by one.

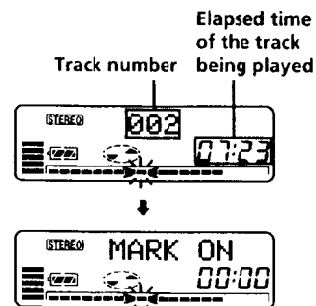

Note

TRACK MARK on the remote commander does not function during playback.

To add track marks while recording

See "Track marking while recording" (page 13).

To erase track marks

See "Erasing a track mark" (page 22).

Notes

- When you press ■STOP/CHARGE after adding track marks, "Toc Edit" flashes and the recorder starts writing the new data to the MD. Do not move or jog the recorder while "Toc Edit" is flashing in the display.
- You cannot add track marks on an MD that is record-protected. Before adding track marks, close the tab on the side of the MD.