

Mini-disc Recorder

# MDS-E12



MDLP

## Operating Instructions

Thank you very much for purchasing this Sony product. Sony products are designed with safety in mind. If electrical products are used incorrectly, however, there is a risk of death or serious injury, so be sure to obey the following to avoid accidents.

## TABLE OF CONTENTS

<b>Warning .....</b>	<b>2</b>
<b>Location and Function of Parts</b>	<b>5</b>
<b>Getting Started .....</b>	<b>15</b>
<b>Recording on MDs .....</b>	<b>18</b>
<b>Playing MDs .....</b>	<b>27</b>
<b>Editing Recorded MDs .....</b>	<b>40</b>
<b>Other Functions .....</b>	<b>52</b>
<b>Rear Panel Terminal Function .</b>	<b>55</b>
<b>Operating the MD Recorder</b>	
<b>Using a Keyboard .....</b>	<b>59</b>
<b>Additional Information .....</b>	<b>64</b>

# WARNING

## Notice for the Customers in the United Kingdom

### IMPORTANT

The wires in this mains lead are coloured in accordance with the following code:

- Blue: Neutral
- Brown: Live

As the colours of the wires in the mains lead of this apparatus may not correspond with the coloured markings identifying the terminals in your plug, proceed as follows:

The wire which is coloured blue must be connected to the terminal which is marked with the letter N or coloured black.

The wire which is coloured brown must be connected to the terminal which is marked with the letter L or coloured red. Do not connect either wire to the earth terminal in the plug which is marked by the letter E or by the safety earth symbol  $\perp$  or coloured green or green-and-yellow.

## For customers in the U.S.A.

**To prevent fire or shock hazard, do not expose the unit to rain or moisture.**

**To avoid electrical shock, do not open the cabinet. Refer servicing to qualified personnel only.**

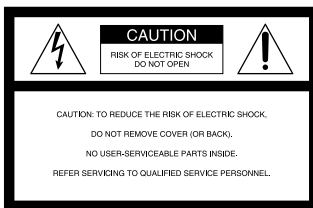

This symbol is intended to alert the user to the presence of uninsulated "dangerous voltage" within the product's enclosure that may be of sufficient magnitude to constitute a risk of electric shock to persons.



This symbol is intended to alert the user to the presence of important operating and maintenance (servicing) instructions in the literature accompanying the appliance.

### CAUTION

You are cautioned that any changes or modification not expressly approved in this manual could void your authority to operate this equipment.

### INFORMATION

This equipment has been tested and found to comply with the limits for a Class B digital device, pursuant to Part 15 of the FCC Rules. These limits are designed to provide reasonable protection against harmful interference in a residential installation. This equipment generates, uses, and can radiate radio frequency energy and, if not installed and used in accordance with the instructions, may cause harmful interference to radio communications.

However, there is no guarantee that interference will not occur in a particular installation. If this equipment does cause harmful interference to radio or television reception, which can be determined by turning the equipment off and on, the user is encouraged to try to correct the interference by one or more of the following measures:

- Reorient or relocate the receiving antenna.
- Increase the separation between the equipment and receiver.
- Connect the equipment into an outlet on a circuit different from that to which the receiver is connected.
- Consult the dealer or an experienced radio/TV technician for help.

## For customers in the Europe.

The laser component in this product is capable of emitting radiation exceeding the limit for Class 1.

This appliance is classified as a CLASS 1 LASER product. The CLASS 1 LASER PRODUCT MARKING is located on the rear exterior.

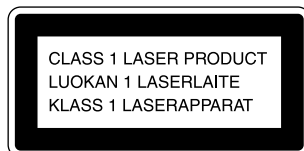

The following caution label is located inside the unit.



## For customers in Canada

This Class B digital apparatus complies With Canadian ICES-003.

### CAUTION

TO PREVENT ELECTRIC SHOCK, DO NOT USE THIS POLARIZED AC PLUG WITH AN EXTENSION CORD, RECEPTACLE OR OTHER OUTLET UNLESS THE BLADES CAN BE FULLY INSERTED TO PREVENT BLADE EXPOSURE.

### ATTENTION

POUR PREVENIR LES CHOCS ELECTRIQUES, NE PAS UTILISER CETTE FICHE POLARISEE AVEC UNPROLONGATEUR, UNE PRISE DE COURANT OU UNE AUTRE SORTIE DE COURANT SAUF SI LES LAMES PEUVENT ETRE INSEREES A FOND SANS EN LAISSER AUCUNE PARTIE A DECOUVERT.

## Setting the voltage selector (voltage selector equipped models only)

Check that the voltage selector on the rear panel is set to the local power line voltage. If not, set the selector to the correct position using a screwdriver before connecting the AC power cord to a wall outlet.

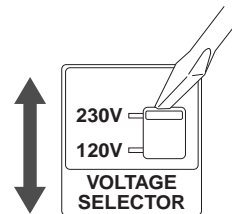

## Owner's Record

The model and serial numbers are located on the rear of the unit. Record the serial number in the space provided below. Refer to them whenever you call upon your Sony dealer regarding this product.

Model No. \_\_\_\_\_  
Serial No. \_\_\_\_\_

IN NO EVENT SHALL SELLER BE LIABLE FOR ANY DIRECT, INCIDENTAL OR CONSEQUENTIAL DAMAGES OF ANY NATURE, OR LOSSES OR EXPENSES RESULTING FROM ANY DEFECTIVE PRODUCT OR THE USE OF ANY PRODUCT.

---

## Precautions

### On safety

- Should any solid object or liquid fall into the cabinet, unplug the recorder and have it checked by qualified personnel before operating it any further.
- Caution – The use of optical instruments with this product will increase eye hazard.

### On power sources

- Before operating the recorder, check that the operating voltage of the recorder is identical with your local power supply. The operating voltage is indicated on the nameplate at the rear of the recorder.
- The unit is not disconnected from the AC power source (mains) as long as it is connected to the wall outlet, even if the unit itself has been turned off.
- If you are not going to use the recorder for a long time, be sure to disconnect the recorder from the wall outlet. To disconnect the AC power cord, grasp the plug itself; never pull the cord.
- AC power cord must be changed only at the qualified service shop.

### On condensation

If the recorder is brought directly from a cold to a warm location, or is placed in a very damp room, moisture may condense on the lenses inside the recorder. Should this occur, the recorder may not operate properly. In this case, remove the MD and leave the recorder turned on for several hours until the moisture evaporates.

### On cleaning

Clean the cabinet, panel and controls with a soft cloth slightly moistened with mild detergent solution. Do not use any type of abrasive pad, scouring powder or solvent such as alcohol or benzine.

If you have any questions or problems concerning your recorder, please consult your nearest Sony dealer.

---

## Handling MDs

The MD is enclosed in a cartridge to protect the disc from debris or fingerprints and to make it easy to handle. However, the presence of debris or a warped cartridge may inhibit the disc from operating properly. To ensure that you can always listen to the highest quality music, follow the precautions below:

- Do not touch the internal disc directly. Forcing the shutter open may damage the internal disc.
- Be sure to stick the labels supplied with the md to the appropriate positions. The shape of the labels may vary depending on the MD brand.

**Proper Location  
of the labels**

**Shutter**

### Where to keep thge MDs

Do not place the cartridge where it may be exposed to direct sunlight or extremely high heat and humidity.

### Regular maintenance

Wipe dust and debris from the surface of the cartridge with a dry cloth.

---

## About This Manual

### Conventions

- Controls in the instructions are those on the recorder; these may, however, be substituted by controls on the remote that are similarly named or, when different, appear in the instructions within brackets.
- The following icons are used in this manual;



Indicates a procedure that requires use of the remote.



Indicates tips for making the task easier and hints.

# TABLE OF CONTENTS

---

## Location and Function of Parts ..... 5

Front Panel Descriptions .....	6
Rear Panel Descriptions .....	7
Remote Descriptions .....	8
Display Window Descriptions .....	10
Using the Display Window .....	11

---

## Getting Started ..... 14

After Unpacking .....	14
Hooking Up the Audio Components .....	15
Setting the Clock .....	17

---

## Recording on MDs ..... 18

Recording on an MD .....	18
Notes on Recording .....	19
Recording for long times .....	20
Adjusting the Recording Level .....	21
Recording Tips .....	22
Marking Track Numbers While Recording (Track Marking) .....	23
Starting Recording With 6 Seconds of Prestored Audio Data (Time Machine Recording) .....	24
Synchro-recording With the Audio Component of Your Choice (Music Synchro-recording) .....	25
Synchro-recording With a Sony CD Player (CD Synchro-recording) .....	25

---

## Playing MDs ..... 27

Playing an MD .....	27
Playing a Specific Track .....	29
Locating a Particular Point in a Track .....	30
Playing Tracks Repeatedly (Repeat Play) .....	31
Playing Tracks in Random Order (Shuffle Play) .....	32
Creating Your Own Program (Program Play) .....	33
Storing the Located Track to Start Play Instantaneously (Multi-access Play) .....	34
Setting Play start position After Play Is Stopped (Resume Play) .....	36
Returning to the Specified Point (Locate Play) .....	36
Pausing After Each Track (Auto Pause) .....	37
Making Track Play Start Soon (Auto Cue) .....	38
Changing Playback Speed (Variable Speed Play) .....	39

---

## Editing Recorded MDs ..... 40

Before you start editing .....	40
Erasing tracks (ERASE) .....	41
Combining Tracks (COMBINE) .....	43
Moving Tracks (MOVE) .....	44
Dividing Tracks (DIVIDE) .....	45
Naming a Track or MD (NAME) .....	46
Undoing the Last Edit (UNDO) .....	50
Changing Recorded Level after Recording (S.F Edit) .....	50

---

## Other Functions ..... 52

Fade IN and Fade Out Z .....	52
Notification of the track end and the disc end (End Of Track/Disc) .....	53
Using a Timer .....	54

---

## Rear Panel Terminal Functions ..... 55

Control terminal functions .....	55
Remote Terminal Functions .....	55
Parallel Input-Output .....	57
RS-232C .....	58

---

## Operating the MD Recorder Using a Keyboard ..... 59

Setting the keyboard .....	59
Naming a Track or MD Using the Keyboard .....	60
Operating the Recorder Through the Keyboard .....	61
Assigning Characters to Keyboard Keys .....	62
Keyboard Operations (English Keyboard Layout) .....	63
Keyboard Operations (10-Keyboard Layout) .....	63

---

## Additional Information ..... 64

System Limitations .....	64
Trouble shooting .....	65
Self-Diagnosis Function .....	66
Display Messages .....	67
Specifications .....	68
Exterior dimensions .....	69
Edit Menu Table .....	70
Setup Menu Table .....	71
Last Mode Memory .....	72

# Location and Function of Parts

## Front Panel Descriptions

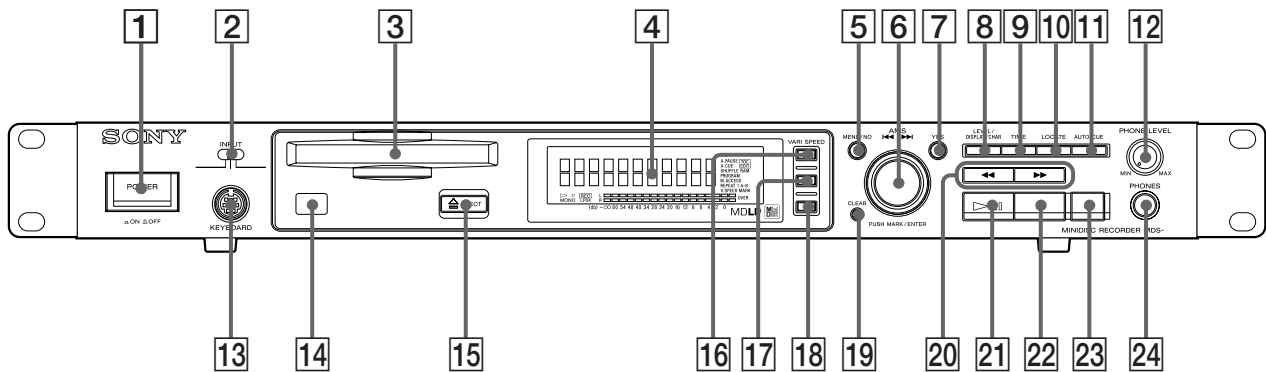

- 1 POWER button**  
Press to turn the recorder on. When you press the button again, the recorder turns off.
- 2 INPUT selector**  
Use to select the input jack (or connector) of the program source to be recorded.
- 3 MD insertion slot**  
Insert the MD as illustrated below.

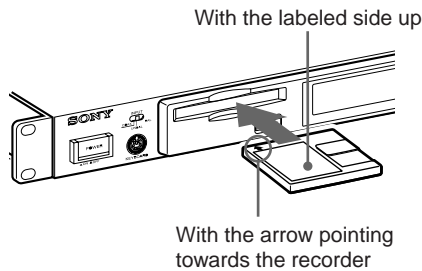

- 4 Display window**  
Shows various information.
- 5 MENU/NO button**  
Press to display "Edit Menu" or "Setup Menu." Also, the MENU mode is cleared.
- 6 AMS control (MARK/ENTER button)**  
Turn to locate tracks, adjust the recording level, select the input characters, or select a menu item and a setting value.
- 7 YES button**  
Press to carry out the selected operation.
- 8 LEVEL/DISPLAY/CHAR button**  
Press to display INPUT or OUTPUT level and disc or track information, select the type of characters to be input, and change to time display.
- 9 TIME button**  
Press to change time information on the disc or track.
- 10 LOCATE button**  
Press to locate pre-marked positions.
- 11 AUTO CUE button**  
Press to set AUTO CUE, AUTO PAUSE, or OFF.
- 12 PHONE LEVEL control**  
Use to adjust the volume of the headphones.
- 13 KEYBOARD jack**  
Connect a keyboard to this jack.
- 14 Remote sensor**  
Receives the infrared signal of the remote for remote operations.
- 15 ▲ EJECT button**  
Press to eject the MD.
- 16 VARI SPEED button**  
Press to turn on and off VARI SPEED.
- 17 VARI SPEED + button**  
Press to increase play speed at 0.5% step when VARI SPEED is on.
- 18 VARI SPEED – button**  
Press to decrease play speed at 0.5% step when VARI SPEED is on.
- 19 CLEAR button**  
Press to cancel the selection.
- 20 ◀/▶ (backward/forward) button**  
Press to locate a portion within a track, change the contents of a program, or change the input character.
- 21 ▷|| (play/pause) button**  
Press to start play and pause or resume play or recording.
- 22 ■ (stop) button**  
Press to stop play or recording, or cancel the selected operation.
- 23 ● (record) button**  
Press to record on the MD, monitor the input signal, or mark track numbers.
- 24 PHONES jack**  
Connect headphones to this jack.

## Rear of the Recorder

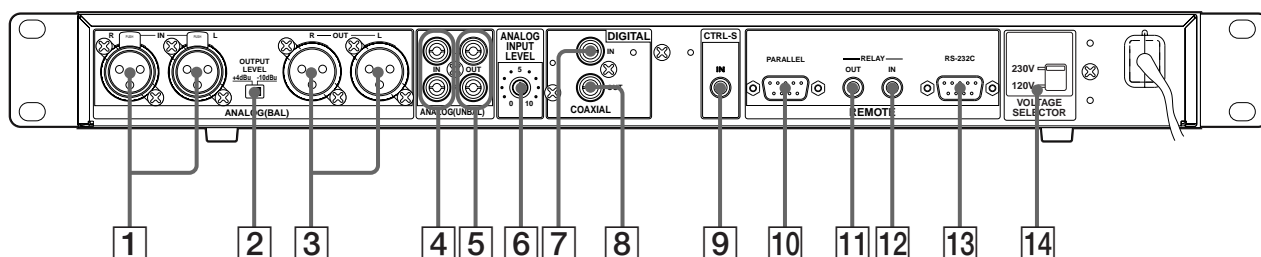

- 1 ANALOG (BALANCE) input terminal (XLR type)**  
Inputs as an analog signal the sound of the component connected by an XLR connecting cable.
- 2 OUTPUT LEVEL (BALANCE) selector**  
Changes the output level of the BALANCE.
- 3 ANALOG (BALANCE) output terminal (XLR type)**  
Outputs as an analog signal the contents of the MD of this recorder to the component connected by an XLR connecting cable.
- 4 ANALOG (UNBALANCE) input jacks**  
Inputs as an analog signal the sound of the component connected by a pin type connecting cable.
- 5 ANALOG (UNBALANCE) output jacks**  
Outputs as an analog signal the contents of the MD of this recorder to the component connected by a pin type connecting cable.
- 6 ANALOG INPUT LEVEL control**  
Can adjust the level of analog input in a range of  $-\infty \sim +15$  dB.  
Normally, this control is used in the position (0 dB) of center click.
- 7 DIGITAL COAXIAL input jack**  
Inputs as a digital signal the sound of the connected component.
- 8 DIGITAL COAXIAL output jack**  
Outputs an a digital signal the contents of the MD of the recorder to the connected component.
- 9 CONTROL-S jack**  
Connects the remote or control equipment.  
If the plug is connected to the jack, the remote sensor does not receive infrared rays.
- 10 PARALLEL connector**  
(D-sub 9-pin female)  
Connects a component with simple circuits for the remote operations of the functions preset in the recorder.
- 11 RELAY OUT connector**
- 12 REELAY IN connector**  
Plays or records successively by connecting multiple recorders and sending a control signal.
- 13 RS-232C connector**  
(D-sub 9-pin male)  
Connects a component that controls the recorder from outside.
- 14 VOLTAGE SELECTOR**  
(Except for the USA/CA models.)  
Select 120V or 230V according to the local power line voltage. (Refer to page 2)

# Remote Descriptions

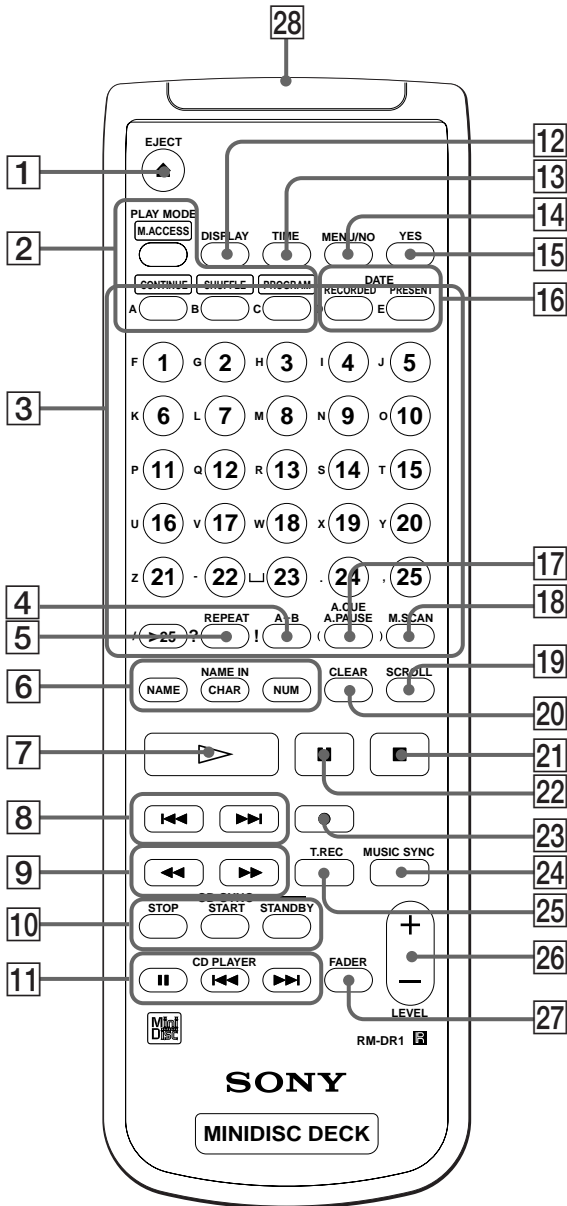

**1** ▲ (EJECT) button

Press to eject the MD.

**2** PLAY MODE button

Press to select multi-access, normal play, Shuffle Play, or Program Play.

**3** Letter/track number input buttons

Press to input letters, numbers, symbols or select track numbers.

**4** A ↔ B button

Press to select Repeat A ↔ B Play.

**5** REPEAT button

Press to select ALL repeat, one track repeat, or repeat off.

**6** NAME button

Press to add the name or change the name of a track or MD.

**CHAR** button

Press to select the type of characters to be input.

**NUM** button

Press to input numbers.

**7** ▷ (play) button

Press to start play.

**8** ◀◀/▶▶ (locating tracks) button

Press to locate tracks, adjust the recording level, or select a menu item and a setting value.

**9** ◀◀/▶▶ (backward/forward) button

Press to locate a portion within a track, change the contents of a program, or change the input character.

**10** CD-SYNCHRO button

Press to operate the CD-Synchro-recording of a CD component.

**11** CD PLAYER button

Press to pause or locate tracks the CD component.

**12** DISPLAY button

Press to select the information to be displayed in the window.

**13** TIME button

Press to change the disc or track time information.

**14** MENU/NO button

Press to display "Edit Menu" or "Setup Menu." The MENU mode is cleared.

**15** YES button

Press to carry out the selected operation.

**16** DATE (RECORDED/PRESENT) button

Press to display the recorded time of a disc recorded by a component which contains a function of recording the recorded date or display the present time of a component which contains a clock function.

**17** A.CUE/A.PAUSE button

Press to set AUTO CUE, AUTO PAUSE, or OFF.



- 
- 18 M.SCAN button**  
Press to successively play the located tracks only for the set time.
- 19 SCROLL button**  
Press to scroll the name of a track or MD.
- 20 CLEAR button**  
Press to cancel the selection.
- 21 ■ (stop) button**  
Press to stop play or recording, or clear the MENU mode.
- 22 || (pause) button**  
Press to pause or resume play or recording.
- 23 ● (record) button**  
Press to record on the MD, monitor the input signal, or mark track numbers.
- 24 MUSIC SYNC button**  
Press to start Music Synchro-recording.
- 25 T.REC button**  
Press to start Time Machine Recording.
- 26 LEVEL + / – button**  
Press to adjust the recording level or output level of analog play.
- 27 FADER button**  
Press to perform Fade-in Play/Recording or Fade-out Play/Recording.
- 28 Control-S jack**  
Can be used as the wired remote by connecting with the control-S jack in the rear of the recorder using a supplied cable.  
If the plug is connected to the jack, the remote does not radiate infrared rays.

# Display Window Discriptions

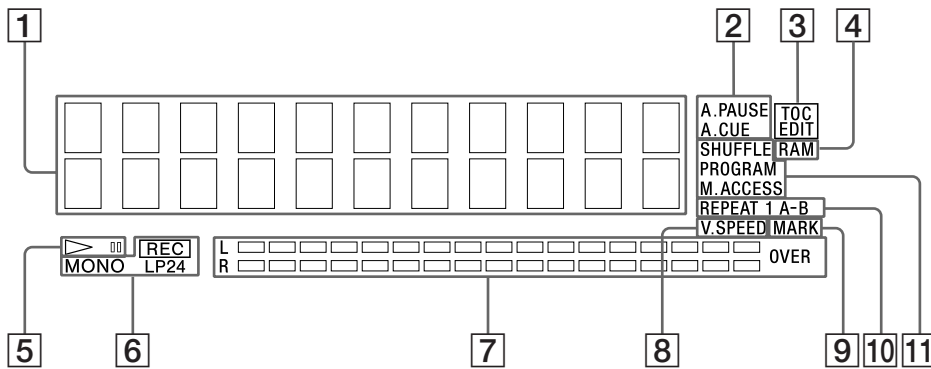

- 1 Disc, track, and time display**  
Displays MD information, the set contents of "Edit Menu" or "Setup Menu," and time information.
- 2 AUTO PAUSE and AUTO CUE display**  
Lights up when AUTO PAUSE or AUTO CUE is selected.
- 3 TOC EDIT display**  
Displays "TOC" when record contents or edit contents are not recorded on MD. Flashes "TOC" when they are recorded on MD.  
"TOC" is displayed during edit operation.
- 4 RAM display**  
Lights up in RAM edit mode in which temporary editing is performed for sending without recording editing results.
- 5 >|| (play/pause) display**  
Displays during play or pause.
- 6 Record and record mode display**  
REC display  
Lights up during recording or pausing.  
Record mode display  
Lights up "MONO" for monaural recording, "LP2" for double-length stereo recording, and "LP4" for 4-time length stereo recording in record mode or mode when the playing track is recorded.
- 7 Level meter display**  
Displays the loudness of the sound of play or recording.
- 8 VARI SPEED display**  
Lights up when the VARI SPEED function is selected.
- 9 MARK display**  
Lights up when the position (MARK) of a located point is selected.
- 10 REPEAT display**  
Displays "REPEAT" when all track repeat is selected, "REPEAT1" when one track repeat is selected, and "REPEAT A-B" when A-B repeat is selected.
- 11 Play mode display**  
Displays "SHUFFLE" when shuffle play is selected, "PROGRAM" when program play is selected, and "M.ACCESS" when multi-access play is selected.

## Using the Display

The display window shows information about the current track. This section describes the information displayed for each recorder state.

### While the recorder is stopped

SONGS  
15 Tr 46 m 08 s

7/4 → 1 → 7 → 5 /  
4 S 1 2 m 3 5 s

Input Level  
Coax 0.0 dB

### When you insert an MD

SONGS  
15 Tr 46 m 08 s

2000 9 15  
18:08 44

SONGS  
15 Tr 46 m 08 s

SONGS  
- 27 m 52 s

### While the recorder is recording

Press LEVEL/DISPLAY/CHAR (or DISPLAY) repeatedly to change the display.

Each press of the button changes the display as follows:

Track number and recorded time of the current track (default display)

No Name  
16 Tr 3m05s

Press

Sampling frequency is indicated only when the digital signal is input.

FS 44.1 KHZ  
16 Tr 3m23s

Press

Level of the input signal

Input Level  
Coax -12.0 dB

Press

You can check the remaining recordable time on the MD. Press TIME when the track number and recorded time are displayed. Each press of the button changes the display as follows:

Track number and recorded time of the current track (default display)

No Name  
16 Tr 3m05s

Press

Recordable time

No Name  
-10m55s

Press

### While the recorder is playing

Press LEVEL/DISPLAY/CHAR (or DISPLAY) repeatedly to change the display.

Each press of the button changes the display as follows:

Track number and elapsed time of the current track (default display)

DREAM  
2 Tr 2m33s

Press

The contents of a program (only when "ROGRAM" lights up)

/ 4 → 1 ÷ 2 → 5 /  
3 S 2m28s PROGRAM

Press

\* Only when "On" of "Next Tr Play" of "Setup Menu" is selected

Next No Name  
4 Tr 4m14s

Press

Disc name and track name

SONGS  
DREAM

Press

Level of the output signal

Output Level  
Anlg -6.0 dB

Press

\* Not displayed if PLAY MODE is PROGRAM or SHUFFLE when "On" of "Next Tr Play" (Next Track Play) is selected.

💡 You can check the remaining time  
 Press TIME. Each press of the button changes the display as follows:

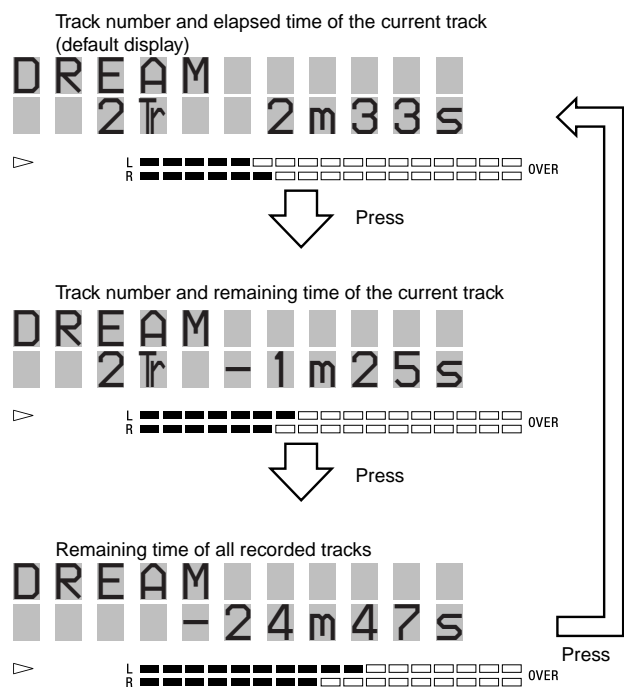

💡 Press SCROLL when disc time information is displayed  
 The track name appears and scrolls. While the track name is scrolling, press the button again to pause scrolling, and again to continue scrolling.

# Getting Started

---

## After Unpacking

Check the supplied accessories.

- Remote commander (remote) RM-DR1E (1)
- AA-size (R6) batteries (2)
- Connecting cable (control S cable) (1)

### Inserting batteries into the remote

Insert two AA-size (R6) batteries with the ⊕ and ⊖ properly oriented to the markings into the battery compartment.

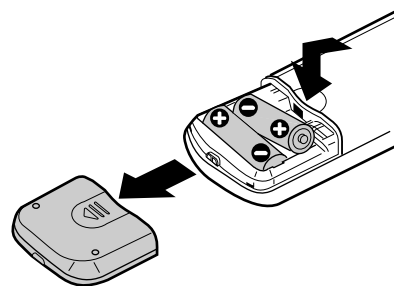

### 💡 When to replace the batteries

Under normal conditions, the batteries should last for about six months. When the remote no longer operates the recorder, replace both batteries with new ones.

### Notes

- If you use the batteries incorrectly, they may leak liquid or be blown up. Be sure to obey the following points:
  - Do not mistake ⊕ and ⊖ terminals.
  - Do not use a new battery with an old one or batteries of different types together.
  - Do not recharge the batteries.
  - If you don't use the remote for an extended period of time, remove the batteries.
  - If the batteries are leaking, wipe to clean the battery compartment before replacing with new ones.
- Do not expose the remote sensor to direct sunlight or lighting apparatus. Doing so may cause a malfunction.

---

## Hooking Up the Audio Components

Hook up a mixer, CD player, DAT recorder, and other components to the MD recorder. Be sure to turn off the power of each component to do so.

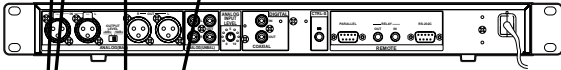

Position of selector	Output level
+4dBu	A signal of -20 dB at the level meter is output at the level of +4 dBu.
-10dBu	A signal of -20 dB at the level meter is output at the level of -10 dBu.

The specifications of the BALANCE I/O connector are shown below.

**Input terminal**  
XLR-3-31 equivalent

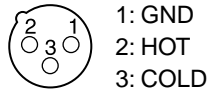

**Output terminal**  
XLR-3-32 equivalent

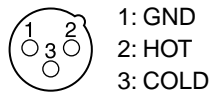

- When connecting with digital components (CD player, DAT recorder, other MD recorders, mixer with a coaxial digital input connector)**  
 When this recorder is connected with a CD player, MD recorder, or DAT recorder, digital recording is possible. Use a coaxial digital connecting cable that can be purchased separately.

When the coaxial digital cable is used

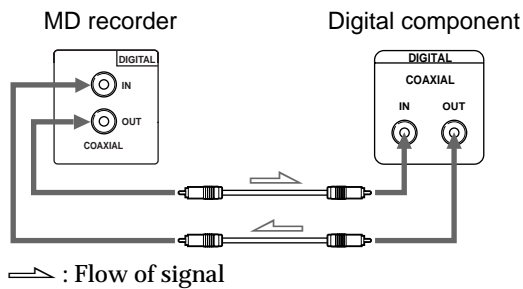

- 💡 A sampling rate converter is mounted in this recorder**  
 All digital input signals are converted to the sampling frequency (44.1 kHz) of an MD recorder for recording.  
 Therefore, this allows you to record sources such as 32 or 48 kHz DAT or satellite broadcasts, as well as CDs and MDs.

### 3 Connect the power cord.



## Setting the Clock

A clock is built in this recorder. The recording time is recorded automatically on the disc to set the clock in advance. You can check the recording time during play.

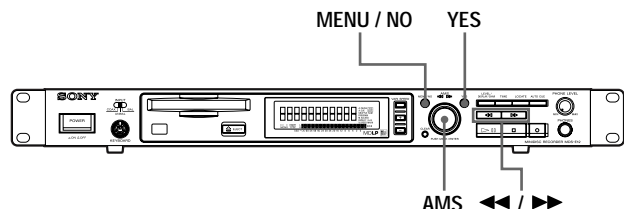

- 1 Press the Menu/NO button twice during stop. "Setup Menu" is displayed.
- 2 Turn AMS (or press **◀◀/▶▶** repeatedly) to display "Calendar" and press AMS. The portion of "Year" flashes.



- 3 Turn AMS (or press **◀◀/▶▶** repeatedly) to set the "Year" and press AMS. The portion of "Year" lights up and the portion of "Month" flashes.

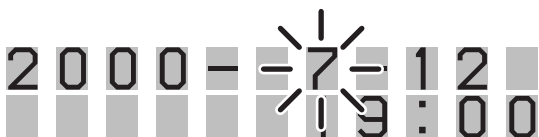

- 4 Similarly with step 3, set "Month," "Day," "Hour," and "Minute" in this order. After "Complete!" is displayed for several seconds and disappears, the clock starts to work.

### Resetting the clock

- 1 Do steps 1 to 2 of "Setting the Clock" on this page.
- 2 Press AMS or **◀◀/▶▶** repeatedly to flash the portion to be changed.
- 3 Turn AMS (or press **◀◀/▶▶** repeatedly) for setting and press AMS.
- 4 After setting, press AMS or **◀◀/▶▶** repeatedly to flash the portion of "Minute" and press AMS or YES.

### Watching the clock

When the power is on, you can watch the clock.

#### Press DATE PRESENT.

When DATE PRESENT is pressed once, the date and time are displayed for about 2 seconds and they are returned to the original display.

- If you want to record more precise recording time, set the clock once a week.

### Checking the recording time

If the built-in clock is set, the recording time is recorded on the MD. You can check the recording time at the display window during play.

- 1 Select a track for which you want to check the recording time. Select a track by **◀◀/▶▶** during stop. Select a track by **◀◀/▶▶** or Number during play or pause of play.
- 2 Press DATE RECORDED. "No Date" is displayed if the clock is not set or for the track recorded by a component without a function of recording the recording time.

### Selecting the order of year, month, and day of clock display

You can select the order of the year, month, and day of clock display from the following three ways:

- 1 Press MENU/NO twice during stop. "Setup Menu" is displayed.
- 2 Turn AMS (or press **◀◀/▶▶** repeatedly) to display "Date Time" and press AMS or YES.
- 3 Turn AMS (or press **◀◀/▶▶** repeatedly) to select the order of the year, month, and day and press AMS or YES.

Order of year, month, and day

Date Time  
Y Y Y Y M M D D

Order of month, day, and year

Date Time  
M M D D Y Y Y Y

Order of day, month, and year

Date Time  
D D M M Y Y Y Y

- 4 Press MENU/NO.

# Recording on MDs

This chapter explains the various ways to record to an MD, as well as how to mark track numbers and perform synchro-recording with other components.

## Recording on an MD

If the MD has recorded material on it, the recorder will automatically start recording from the end of the recorded portion.

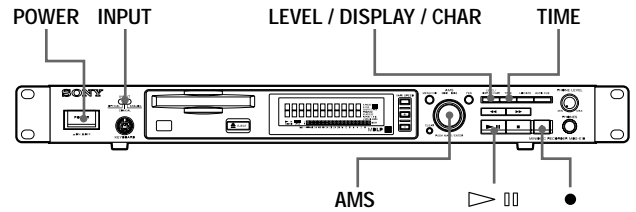

- 1 Turn on the mixer and program source.
- 2 Select the source on the mixer.
- 3 Press POWER to turn on the recorder.
- 4 Insert a recordable MD.
- 5 Use INPUT to select the position that corresponds to the input jacks (connector) connected to the program source.

If the source is connected	Display to be selected to the connector or jacks
----------------------------	--

DIGITAL COAXIAL	COAX
ANALOG (UNBAL)	UNBAL
ANALOG (BAL)	BAL

- 6 If necessary, locate the point on the MD to start recording from.  
If you want to record on a new MD or start recording from the end of the recorded portion, go to step 7.
  - To record over from the beginning of an existing MD track  
Turn AMS (or press ◀▶ repeatedly) until the number of the track to be recorded over appears.
  - To record over from the middle of an MD track  
Turn AMS (or press ◀▶ repeatedly) until the number of the track to be recorded over appears, then press ▶▶ to start playback. Press ▶▶ again at the point you want to start recording from.
- 7 Press ●  
The recorder changes to recording pause.
- 8 If necessary, adjust the recording level.  
For details, see “Adjusting the Recording Level” on page 21.
- 9 Press ▶▶  
Recording starts.
- 10 Start playing the program source.

## Operations you may want to do during recording

To	Press
Stop recording	■
Pause recording	▷
Resume recording after	▷
Eject the MD	after stopping recording ☰

### Changing display during recording

Press LEVEL/DISPLAY/CHAR (DISPLAY) repeatedly. For the contents of display, see "Using the Display Window" on page 12.

### When you pause recording

The track number increases by one. For example, if you pause recording while recording track 4, the track number will be 5 when you resume recording.

### To prevent accidental erasure of the recorded material

To make it impossible to record on an MD, slide the record-protect tab in the direction of the arrow (see illustration below) to open the slot. To enable recording, close the slot.

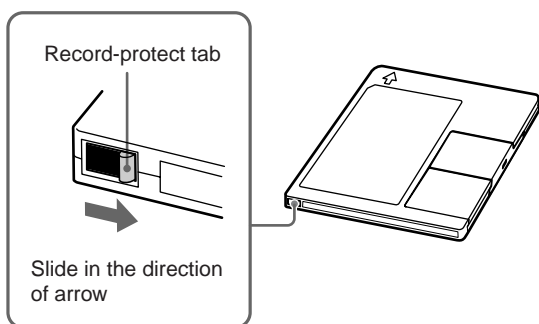

💡 You can play the tracks you have just recorded  
Press ▷|| or AMS immediately after stopping recording.  
The recorder starts to play from the first track of the material just recorded.

💡 You can play from the first track of the MD after recording  
1 Press ■ again after stopping recording.  
2 Press ▷||  
The recorder starts to play from the first track of the MD.

### Notes

- You can't record over existing material when Shuffle Play (page 32), Program Play (page 33), or Multi-access Play (page 34) has been selected. "Impossible" appears in the display at this time.

## Notes on Recording

### When "Protected" is displayed

The MD is record-protected. To record on the MD, slide the tab to close the slot (see "To prevent accidental erasure of the recorded material" on page 19).

When the record-protect slot is closed and recording is possible, "Protected" may be displayed and recording may not be possible. In this case, press ● (record) again to enable recording.

### When "Din Unlock" flashes

- The digital component selected with the INPUT selector is not connected correctly. Connect the component correctly.
- The selected digital component is not turned on. Turn on the component.

### Marking track numbers depends on the program source to be recorded.

- When the CD or MD is a program source and they are recorded through the digital input connector, track numbers are marked similarly with the CD or MD as the program source. However, only one track number may be marked on the recorded portion as below.
  - A portion recorded by repeating the same track of the same disc (by one track repeat)
  - A portion recorded by continuing the same track number of a different disc
- When the MD is the program source, a number for a track of 4 seconds or less may not be marked.
- If the sampling frequency of the input connector changes when the DAT tape is a program source and it is recorded through the digital input connector, track numbers are changed automatically.

### When TOC indicator flashes

Do not turn off the recorder, disconnect the AC power, or move the recorder when recording on the MD because the recording will be lost. If you turn off the recorder or disconnect the AC power immediately after recording, the recording will be lost.

### When PLAY MODE is "PROGRAM," "SHUFFLE," or "M.ACCESS" (pages 32, 33, 34)

PLAY MODE changes automatically to "CONTINUE" and recording pauses.

### When "Cannot Copy" flashes

The mini-disc recorder conforms to the Serial Copy Management System. MDs recorded through the digital input connector cannot be copied to other MDs through the digital output connector (page 65).

The digital output connectors of the mini-disk recorder output the signal input from the digital input connectors as it is during recording or recording pause.

Use an input monitor function (page 22) when only a built-in sampling rate converter is used.

## Recording for long times

In addition to normal stereo recording, this recorder has two long time recording modes: LP2 and LP4. When recording in LP2 stereo mode, you can record 2 times the normal recordable time, and in LP4 Stereo mode, you can record 4 times the normal recordable time. In addition, the recordable time for monaural recording is approximately double the stereo recording time.

### Note

MDs recorded in MD LP (LP2 or LP4 Stereo) mode cannot be played back on a recorder that does not support MD LP mode. In addition, you cannot perform S.F Edit for MDs recorded in MD LP mode.

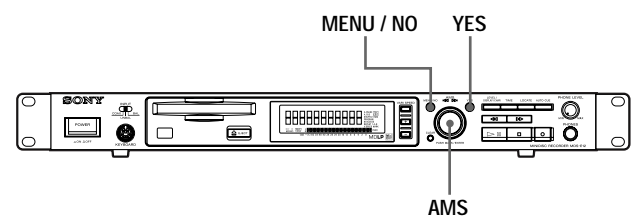

- 1 Do steps 1 to 5 of "Recording on an MD" on page 18.
- 2 Press MENU/NO twice.  
"Set Up Menu" is displayed.
- 3 Turn AMS (or press **◀◀/▶▶** repeatedly) to display "Rec Mode" and press AMS.
- 4 Turn AMS to select record mode and press AMS or YES.

To record in	Display to be selected
Stereo	Stereo
Monaural	Mono
LP2 stereo	Long 2
LP4 stereo	Long 4

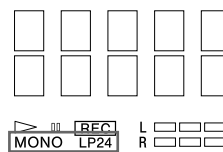

"LP2," "LP4," or "MONO" lights up on the lower left of the display window by the selected mode.

- 5 Press MENU/NO.
- 6 Do steps 6 to 10 of "Recording on an MD" on page 18.

### Hidden "LP:" is recorded at the beginning of tracks during MD LP recording.

This is a confirmation stamp indicating no play when play is performed by the non-MD LP component. The stamp is not displayed by playable MD LP components, but is displayed when play is performed by the non-MD LP component.

If the name of the MD LP-recorded track is copied as the name of the MONO or STEREO recorded track, "LP:" is displayed (page 48).

# Adjusting the Recording Level

You can adjust the recording level for both analog and digital recording.

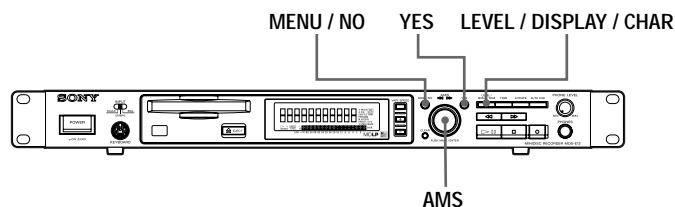

- 1 Do steps 1 to 7 of "Recording on an MD" on page 18.
- 2 Play the portion of the program source with the strongest output.
- 3 Press LEVEL/DISPLAY/CHR (or DISPLAY) repeatedly until the level of the input signal appears.
- 4 Turn AMS (or press LEVEL +/- repeatedly) to adjust the recording level.  
Adjust the recording level so that two rightmost indicators on the peak level meters do not light up when the play level is the highest level.

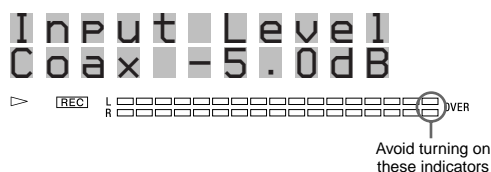

- 5 Stop playing the program source.
- 6 To start recording, continue from step 9 of "Recording on an MD" on page 18.

**💡** You can adjust the recording level using the remote . During recording or recording pause, press LEVEL +/- repeatedly.

- 💡** You can use Setup Menu to adjust the recording level
- 1 During recording or recording pause, press MENU/NO twice.  
"Setup Menu" appears in the display.
  - 2 Turn AMS (or press / repeatedly) to select "Input Level Coax," "Input Level BAL," or "Input Level UNBL," then press AMS or YES.
  - 3 Turn AMS (or press / repeatedly) to adjust the recording level, then press AMS or YES.
  - 4 Press MENU/NO.

**💡** The balance of the left and right recording levels can be adjusted in Setup Menu during analog input

- 1 Press MENU/NO twice.  
"Setup Menu" appears in the display.
- 2 Turn AMS (or press / repeatedly) to select "BAL In L/R" or "UNBAL In L/R" then press AMS or YES.
- 3 Turn AMS (or press / repeatedly) to adjust the balance.  
When you turn AMS clockwise, the level on the L side decreases relatively for R. When you turn it counterclockwise, the level on the R side decreases for L.  
Press AMS or YES.
- 4 Press MENU/NO.

**💡** Turn ANALOG INPUT LEVEL at the rear of the recorder to adjust the recording level of analog input.

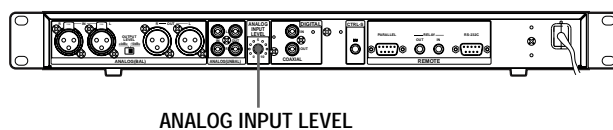

A range of  $-\infty \sim +15$  dB can be adjusted by ANALOG INPUT LEVEL. This adjustment can be used when the analog output level of connected components is too low or too high. Normally use the range in the initialized center position (0dB).

**💡** You can use a peak hold function

The state of the peak level meter when the level of the input/output signal is the highest can be stopped for display until the signal exceeding the level is input.

- 1 Press MENU/NO twice during stop or play.
- 2 Turn AMS (or press / repeatedly) until "Peak Hold" appears, then press AMS or YES.
- 3 Turn AMS (or press / repeatedly) to select "On," then press AMS or YES.
- 4 Press MENU/NO.

To cancel the peak hold function, select "Off" at step 3.

## Note

The volume can only be increased up to +12 dB (for analog recording) or +18.0 dB (for digital recording). Therefore, if the output level of the connected component is low, it may not be possible to set the recording level to maximum.

## Recording Tips

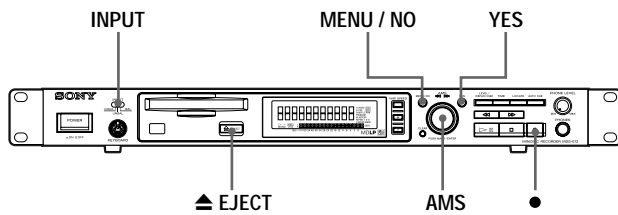

### Monitoring the input signal (Input Monitor)

You can monitor the selected input signal even when you aren't recording it.

- 1 Press **▲** to eject the MD.
- 2 Use **INPUT** to select the program source to be monitored.
- 3 Press **●**.
  - When "UNBAL" or "BAL" is selected by **INPUT**  
The analog signal input from the ANALOG IN jacks is output to the COAXIAL OUT connector after A/D conversion, and then to the ANALOG OUT jacks and PHONES jack after D/A conversion.  
"AD - DA" appears in the display during this time.
  - When "COAXIAL" is selected by **INPUT**  
The digital signal input from the DIGITAL IN connector is output to the DIGITAL OUT connector after passing through the sampling rate converter, and then to the ANALOG OUT jacks and PHONES jack after D/A conversion.  
"- DA" appears in the display during this time.

### Stopping the input monitor

Press **■**.

### Erasing blank portions automatically (Smart Space/Auto Cut)

The recorder can be set to automatically erase any blanks that are produced when the signal is interrupted during recording. The function which activates (Smart Space or Auto Cut) depends on the length of the interruption, as described below.

#### Smart Space

If the signal is interrupted for less than 30 seconds, Smart Space replaces the blank portion with a blank space of about 3 seconds, then continues the recording. "Smart Space" appears in the display during this time.

#### Auto Cut

If the signal is interrupted for about 30 seconds, Auto Cut replaces the blank portion with a blank space of about 3 seconds, then pauses the recording. "Auto Cut" appears in the display during this time.

Do the procedure below to turn Smart Space and Auto Cut on or off.

- 1 While the recorder is stopped, press **MENU/NO** twice.  
"Setup Menu" appears in the display.
- 2 Turn **AMS** (or press **◀◀/▶▶** repeatedly) until "Smart Space" appears, then press **AMS** or **YES**.
- 3 Turn **AMS** (or press **◀◀/▶▶** repeatedly) and select "On" for automatic operation and "Off" for no automatic operation, then press **AMS** or **YES**.
- 4 Press **MENU/NO**.

#### Note

- If you start recording with no signal input, Smart Space and Auto Cut will not operate until the signal is input regardless of the setting.
- Smart Space does not affect the order of the track numbers being recorded, even if the blank space occurs in the middle of a track.
- Auto Cut is automatically turned on or off in tandem with Smart Space.
- If you turn off the recorder or disconnect the AC power cord, the recorder will store the last setting and recall it the next time you turn on the recorder.

## Marking Track Numbers While Recording (Track Marking)

You can mark track numbers either manually or automatically while recording. By marking track numbers at specific points, you can quickly locate the points later or edit the MD easily.

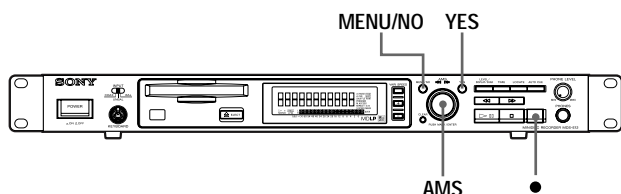

### Marking track numbers manually (Manual Track Marking)

Press ● at the point where you want to add a track number while recording.

### Marking track numbers automatically (Automatic Track Marking)

When recording from a CD player or MD recorder connected to the DIGITAL IN connector, the recorder marks track numbers in the same sequence as the source. When recording from other sources connected to the DIGITAL IN connector or a source connected to the ANALOG IN jacks, do the procedure below to mark track numbers automatically. However, if you hear much noise from the sources of tapes or radios, the recorder cannot mark track numbers.

- 1 While the recorder is stopped, press MENU/NO twice.  
“Setup Menu” appears in the display.
- 2 Turn AMS (or press ◀▶/▶▶ repeatedly) until “Track Mark” appears, then press AMS or YES.
- 3 Turn AMS (or press ◀▶/▶▶ repeatedly) to select the setting, then press AMS or YES.

Automatic tracking marking	Select
Turned on at input level	Level Sync
Turned on at the interval of the fixed time	Interval
Turned off	Off

- 4 Press MENU/NO.

### To set the level of input signals for Automatic Track Marking of “Level Sync”

The recorder marks a track number whenever the input of a signal at the set level or below continues for at least 1.5 seconds and a signal at the set level or above is also input.

- 1 While the recorder is stopped, press MENU/NO twice.  
“Setup Menu” appears in the display.
- 2 Turn AMS (or press ◀▶/▶▶ repeatedly) until “Tr Mark Level” appears, then press AMS or YES.
- 3 Turn AMS (or press ◀▶/▶▶ repeatedly) to select the level at any value from a range of –72 dB, –68 dB, –60 dB, –54 dB, and –48 dB, then press AMS or YES.
- 4 Press MENU/NO.

### To set the interval time of Automatic Track Marking

The recorder marks a track number at intervals at the set time.

- 1 While the recorder is stopped, press MENU/NO twice.  
“Setup Menu” appears in the display.
- 2 Turn AMS (or press ◀▶/▶▶ repeatedly) until “Interval” appears, then press AMS or YES.
- 3 Turn AMS (or press ◀▶/▶▶ repeatedly) to select the time at any value from a range of 1 minute to 10 minutes, then press AMS or YES.

#### Note

When the track number of program sources (CD or MD) changes, a track number changes automatically, or you want to change the track number by ● (REC), the recorder marks a track number at the interval of the fixed time from the beginning of the changed track number.

#### 🔊 Additional information on Automatic Track Marking

- When recording from a CD player or MD recorder connected to the DIGITAL IN connector, the entire material may be recorded as a single track in the following cases:
    - When you consecutively record the same track two or more times using single-track repeat play.
    - When you consecutively record two or more tracks with the same track number but from different CDs or MDs.
    - When you record tracks from certain CD or multi-disc players.
- In either case, divide tracks after recording (page 45).
- If the source is an MD, a track number may not be marked for tracks less than 4 seconds long (during stereo, LP2 stereo, or monaural recording) or less than 8 seconds (during LP4 stereo recording).

- When recording from a component connected to the ANALOG IN jacks with “Track Mark Off” selected or when recording from a DAT recorder or DBS tuner connected to the DIGITAL IN connector, the entire material may be recorded as a single track.
- When recording from a DAT recorder or DBS tuner connected to the DIGITAL IN connector, the recorder will mark a track number whenever the sampling frequency of the input signal changes, regardless of the track marking parameter setting .

💡 You can mark track numbers even after recording has finished. See “Dividing Tracks” on page 45.

#### Note

If you turn off the recorder or disconnect the AC power cord, the recorder will store the last settings of “Track Mark” and recall them the next time you turn on the recorder.

## Starting Recording With 6 Seconds of Prestored Audio Data (Time Machine Recording)

Whenever the recorder is in recording pause, the recorder’s buffer memory continuously stores the latest 6 seconds worth of audio data. When you press AMS (or T.REC), the recording then starts with the data in the buffer memory. Time Machine Recording thus allows you to avoid missing the beginning of material recorded live from an FM or satellite broadcast.

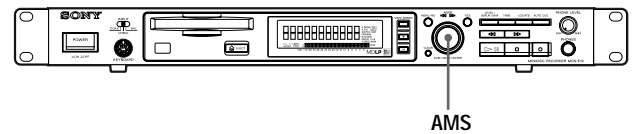

- 1** Do steps 1 to 7 of “Recording on an MD” on page 18.  
The recorder changes to recording pause.
- 2** Start playing the program source.
- 3** Press AMS (or T.REC) at the point where you want to start recording.  
Recording starts with the 6 seconds of prestored data in the buffer memory, then continues recording via the buffer memory thereafter.

#### To stop Time Machine Recording

Press ■.

#### Note

The storage of data in the buffer memory starts from the moment the recorder changes to recording pause. Thus, if you start recording less than 6 seconds worth of data will be recorded from the buffer memory.



## Synchro-recording With the Audio Component of Your Choice (Music Synchro-recording)

The Music Synchro-recording allows you to automatically synchronize recording on the MD recorder with the playing of the selected program source. The Track Marking function, however, will differ according to the program source. For details, see “Marking Track Numbers While Recording” on page 23.

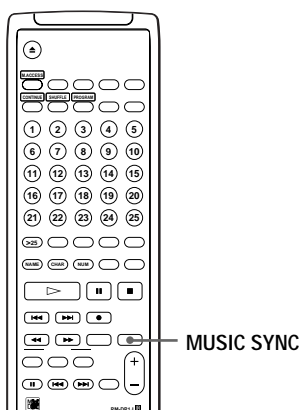

- 1 Do steps 1 to 6 of “Recording on an MD” on page 18.
- 2 Press MUSIC SYNC.  
The recorder changes to recording pause.
- 3 Start playing the program source.  
Recording starts automatically.

### To stop Music Synchro-recording

Press ■.

### Note

During Music Synchro-recording, Smart Space and Auto Cut (page 22) will operate regardless of their setting.

## Synchro-recording With a Sony CD Player (CD Synchro-recording)

When the recorder is connected to a Sony CD player or Hi-Fi component system, you can easily copy the contents of CDs to the MD using the recorder’s remote. As the same remote operates both the MD recorder and the CD player or CD player section of the component system, make sure to place the MD recorder and the CD player as close together as possible.

### Note

- Some CD players do not allow you to synchronize CD recording with the remote of the recorder. In this case, use music synchro-recording on this page to synchronize recording on the CD player and recorder.
- To operate the recorder and CD player, unplug from the jacks of the recorder and remote and use the remote as the wireless remote (page 15).

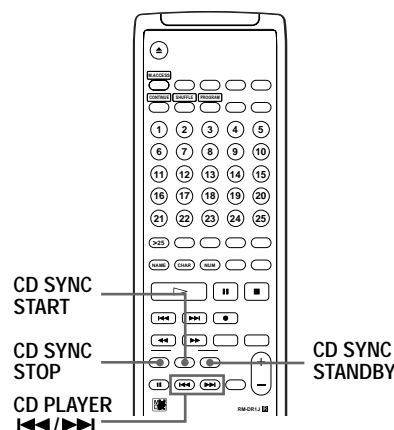

- 1 Turn on the mixer (amplifier) and the CD player, and select CD on the mixer (amplifier).
- 2 Do steps 3 to 6 of “Recording on an MD” on page 18.
- 3 Insert a CD into the CD player and select the playback mode (Shuffle Play, Program Play, etc.) on the CD player.
- 4 Press CD-SYNC STANDBY.  
The CD player changes to play standby and the MD recorder changes to recording standby.
- 5 Press CD-SYNC START.  
The recorder starts recording and the CD player starts playing.  
The track number and elapsed recording time of the track appear in the display.  
**If the CD player doesn’t start playing**  
Some CD players may not respond when you press CD-CYNC START. Press ■■ on the CD player’s remote instead to start playing on the CD player.

## Operations you may want to do during CD

### Synchro-recording

To	Press
Stop recording	CD-SYNCHRO STOP
Pause recording	CD-SYNCHRO STANDBY
Locate the next track to be recorded during recording pause	CD PLAYER ◀◀ / ▶▶
Resume recording after pausing	CD-SYNCHRO START
Check the remaining recordable time on the MD	TIME of the recorder

💡 You can use the remote of the CD player during CD Synchro-recording

Press	To change the recorder to	And change the CD player to
▷	Recording	Play
■	Recording pause	Stop
	Recording pause	Pause

💡 You can change CDs during CD Synchro-recording

- 1 Press ■ on the CD player's remote.
- 2 Change the CD.
- 3 Press ▷ on the CD player's remote.  
Recording resumes.

### Notes

- When performing CD Synchro-recording with a CD player with a mode selector, be sure to set the selector to CD1.
- When you record tracks from certain CD or multi-disc players, the entire material may be recorded as a single track.

# Playing MDs

This chapter explains the various ways to play MDs.

## Playing an MD

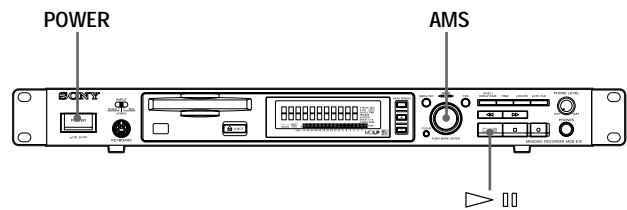

- 1 Turn on the mixer.
- 2 Adjust the fader or level of the connected channel of the mixer.
- 3 Press POWER to turn on the recorder.
- 4 Insert an MD.
- 5 If necessary, turn AMS (or press ◀◀/▶▶ repeatedly) to locate the track you want to start playing from.  
If you want to play from the first track, go to step 6.
- 6 Press ▷||. The recorder starts playing.

### Operations you may want to do during play

To	Press or turn
Stop play	■
Pause play	▷
Resume play after pausing	▷
Locate a succeeding track	AMS clockwise (or press ▶▶ repeatedly)
Locate the beginning of the current track or a preceding track	AMS counterclockwise (or press ◀◀ repeatedly)
Eject the MD	After stopping play ⏏

- 💡 To play the MD on which LP2, LP4 stereo recording or MONO recording has been performed  
By pressing ▷|| in step 6 above, "LP2," "LP4," or "MONO" lights up depending on the mode recorded on the lower left of the display window.

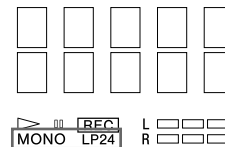

- 💡 To use headphones  
Connect them to PHONES jack. Turn PHONE LEVEL to adjust the volume.

- 💡 You can adjust the analog signal output level.
- 1 While the recorder is playing, press LEVEL/DISPLAY/CHA (or DISPLAY) repeatedly until the line output adjustment display appears.
  - 2 Turn AMS (or press LEVEL +/- repeatedly) to adjust the output signal level.

- 💡 You can use Setup Menu to adjust the analog output level
- 1 Press MENU/NO twice.  
“Setup Menu” appears in the display.
  - 2 Turn AMS (or press ◀▶ repeatedly) to select “Output Level,” then press AMS or YES.
  - 3 Turn AMS (or press ◀▶ repeatedly) to adjust the output level, press AMS or YES.
  - 4 Press MENU/NO.

- 💡 You can make EJECT not function during play or pause to avoid ejecting the MD by mistake.
- 1 Press MENU/NO twice during stop.  
“Setup Menu” appears in the display.
  - 2 Turn AMS (or press ◀▶ repeatedly) to select “Play Pause,” then press AMS or YES.
  - 3 Turn AMS (or press ◀▶ repeatedly) to select “▲ Disable,” then press AMS or YES.
  - 4 Press MENU/NO.

To function EJECT, select “▲ Enable” in step 3.

## Playing a Specific Track

While the recorder is playing, pause or stopped, use the procedure below to quickly play any track.

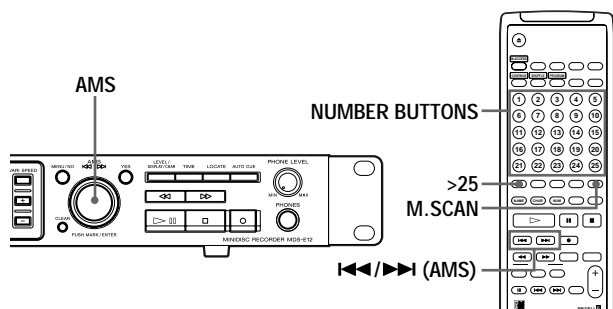

### Locating a track with AMS\*

To go to	Do the following:
The next or a succeeding track during play	Turn AMS clockwise (or press ►► repeatedly).
A preceding track during play	Turn AMS counterclockwise (or press ◀◀ repeatedly).
The beginning of the current track during play	Turn AMS counterclockwise (or press ◀◀ once).
A specific track while the recorder is stopped	1 Turn AMS (or press ◀◀/►► repeatedly) until the track number appears in the display. 2 Press AMS or ►◻.

\* Automatic Music Sensor

💡 To locate the last track of the MD quickly  
While the recorder is stopped, turn AMS counterclockwise (or press ◀◀ once).

💡 If you locate a track while the recorder is stopped or paused  
The recorder will still be stopped or paused at the beginning of the located track.

### Playing a track by entering the track number

Press the number button(s) to enter the track number of the track you want to play.

#### To enter a track number over 26

- 1 Press >25.  
See the examples below for the number of presses.
- 2 Enter the corresponding digits.  
To enter 0, press 10 instead.  
Examples:
  - To play track number 30, press >25, then 3 and 10.
  - To play track number 108, press >25 twice, then 1, 10, and 8.

💡 If you enter a track number while the recorder is paused  
The recorder will be paused at the beginning of the track.

### Locating a point by monitoring the beginning of each track (Music Scan)

If M.SCAN is pressed during stop, the beginning of each track is played sequentially only at the set fix time.  
Press ► for the track you want to monitor.

💡 You can adjust the play time for the beginning of a track by MUSIC SCAN

- 1 Press MENU/NO twice.  
“Setup Menu” appears in the display.
- 2 Turn AMS (or press ◀◀/►► repeatedly) to select “Music Scan,” then press AMS or YES.
- 3 Turn AMS until the desired time of 6 to 20 seconds appears in the display, then press AMS or YES.
- 4 Press MENU/NO.

### Reserving the next track during play (Next Track Play)

A desired one track can be reserved for the next track by turning "Next Tr Play (Next Track Play)" of "Setup Menu" to "On."

- 1 Press MENU/NO twice during stop.  
"Setup Menu" appears in the display.
- 2 Turn AMS (or press ◀◀/▶▶ repeatedly) to select "Next Tr Play," then press AMS or YES.
- 3 Turn AMS to select "On," then press AMS or YES.
- 4 Press MENU/NO.
- 5 Press ▷◻◻.
- 6 Press DISPLAY/LEVEL/CHAR until the reservation of the next track to play appears.



- 7 Turn AMS (or press ◀◀/▶▶ repeatedly) to select a track number to be reserved in the flashing track number display, then press AMS. After reservation, the flashing of the track number stops.
- 8 When the play of the track number reserved in step 7 starts, the flashing of the track number display starts again. Repeat the operation in step 7 to reserve the next track number.

#### Notes

- Tracks cannot be reserved when PLAY MODE is PROGRAM, SHUFFLE, or M.ACCESS.
- The reserved track cannot be located by AMS. If AMS is turned, the reserved track is canceled, a mode is set to select a new reserved track.

## Locating a Particular Point in a Track

You can locate a particular point in a track during play or play pause.

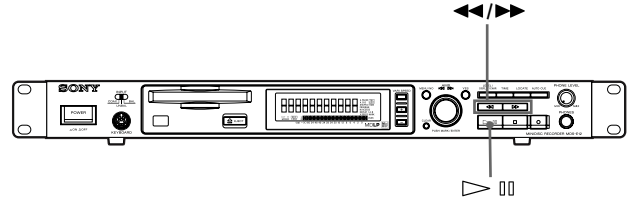

### Locating a point while monitoring the sound (Search)

Press down ◀◀/▶▶ during play.

You will hear intermittent playback as the disc goes forward or in reverse.

When you reach the point you want, release the button.

#### Notes

- If the disc reaches the end while you're pressing ▶▶, the recorder stops.
- Tracks that are only a few seconds long may be too short for monitoring. For such tracks, play the MD at normal speed.

### Locating a point by observing the time indication (High speed search)

Press down ◀◀/▶▶ during play pause.

You won't hear playback.

When you reach the point you want, release the button, then press ▷◻◻.



When "- Over -" appears in the display

The disc has reached the end while you're pressing ▶▶. Turn AMS counterclockwise (or press ◀◀) or press ◀◀ to go back.

## Playing Tracks Repeatedly (Repeat Play)

You can play an entire MD repeatedly. This function can be used with Shuffle Play to repeat all the tracks in random order, or with Program Play to repeat all the tracks in the program. You can also repeat a specific track or portion within a track.

Repeat play cannot be performed during Multi-access play (page 34).

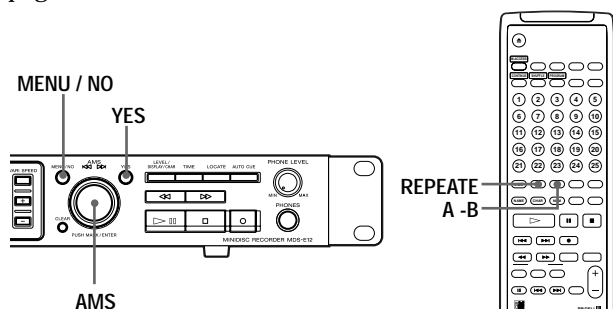

### Note

If you turn off the recorder or disconnect the AC power cord, the recorder will store the last setting of the repeat play ("Repeat All" or "Repeat 1") and recall it the next time you turn on the recorder. However, A - B Repeat is canceled.

## Repeating all the tracks on the MD (Repeat All Play)

All tracks are repeated.

Press REPEAT until REPEAT lights up at the display window.

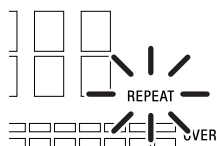

When you play an MD, the recorder repeats the tracks as follows:

When the play mode is	The recorder repeats
Normal play (page 27)	All the tracks in sequence
Shuffle play (page 32)	All the tracks in random order
Program Play (page 33)	All the tracks in the program in sequence

### To resume normal play

Press REPEAT until "REPEAT" at the display window turns off.

You can also set Repeat All Play in the Setup Menu of the recorder.

- 1 Press MENU/NO twice.  
"Setup Menu" appears in the display.
- 2 Turn AMS to select "Repeat Mode," then press AMS or YES.
- 3 Turn AMS to select "Repeat ALL," then press AMS or YES.
- 4 Press MENU/NO.

## Repeating the current track (Repeat 1 Play)

The current track is repeated.

Press REPEAT until "Repeat 1" appears at the display window.

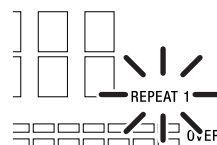

When you play an MD, Repeat 1 Play starts.

### To resume normal play

Press REPEAT until "REPEAT 1" at the display window turns off.

You can also set Repeat 1 Play in the Setup Menu of the recorder.

- 1 Press MENU/NO twice.  
"Setup Menu" appears in the display.
- 2 Turn AMS to select "Repeat Mode," then press AMS or YES.
- 3 Turn AMS to select "Repeat 1," then press AMS or YES.
- 4 Press MENU/NO.

## Repeating a specific portion within a track (Repeat A-B Play)

You can specify a portion within a track to play repeatedly. This is convenient to study language or memorize words. Note that the portion that you specify must be within the boundaries of a single track.

- 1 While the recorder is playing, press A ↔ B at the starting point (point A) of the portion to be played repeatedly.

“REPEAT A-B” lights up.

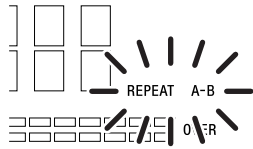

- 2 Continue playing the track or use ►► to locate the ending point (point B) of the portion to be played repeatedly, then press A ↔ B again. The specified portion repeats.

### To stop Repeat A-B Play

Press REPEAT or ■.

### To set a new starting point and ending point during Repeat A-B Play

Specify the starting point and ending point by the same operation.

 You can also set A-B Repeat in the Setup Menu of the recorder.

- 1 Press MENU/NO during play until “Setup Menu” appears in the display.
- 2 Turn AMS until “Repeat Mode” appears at the display window, then press AMS.
- 3 Turn AMS until “A-B Repeat,” then press AMS. The display window returns to the track number and time display (normal display) during play, then “REPEAT A-B” lights up and “A-B” flashes.

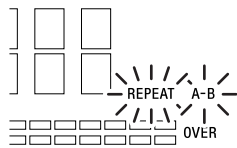

- 4 Press AMS at the starting point (point A) of a portion to be played repeatedly.
- 5 Continue playing the track or use ►► to locate the ending point (point B) of the portion to be played repeatedly, then press AMS again.

### Note

A-B Repeat does not work during Shuffle Play or Multi-access Play.

## Playing Tracks in Random Order (Shuffle Play)

When you select Shuffle Play, the recorder plays all the tracks on the MD in random order.

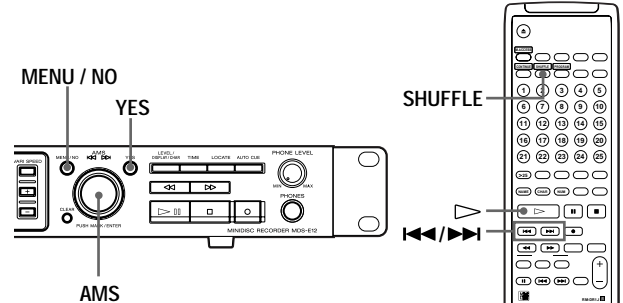

- 1 Press SHUFFLE while the recorder is stopped. “SHUFFLE” lights up at the display window.

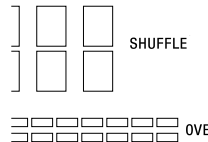



# Creating Your Own Program (Program Play)

You can pick out the tracks that you like and specify the playback order in a program containing up to 25 tracks.

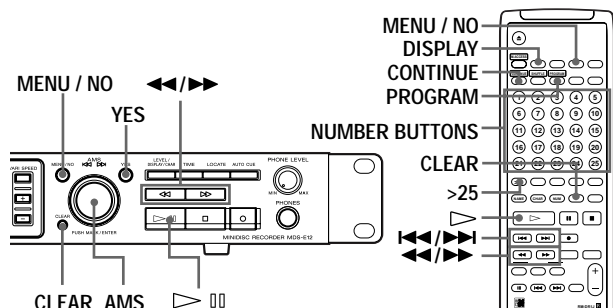

## Programming the tracks

- 1 While the recorder is stopped, press MENU/NO twice. "Set Menu" appears in the display.
- 2 Turn AMS (or press **◀▶** repeatedly) until "Program?" or "Set Menu" appears, then press AMS or YES.
- 3 Turn AMS (or press **◀▶** repeatedly) until the track number you want to add to the program appears, then press AMS (or use the number button(s) to enter the track directly).

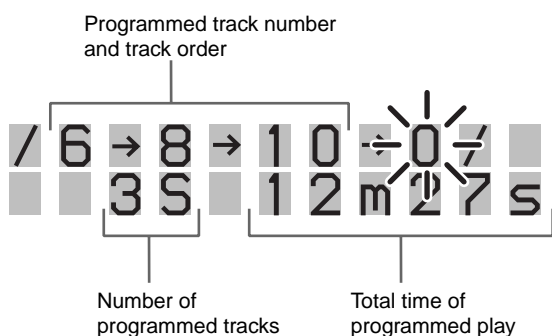

If you entered the wrong track number  
 Press **◀** repeatedly until the wrong track number flashes, then do step 3 above again or press CLEAR to erase the track number.  
 To enter a track number over 26 Use >25. For details, see page 29.

- 4 Repeat step 3 to enter other tracks. The entered track is added to the location where the "0" flashes. Each time you enter a track, the total program time appears in the display.
- 5 Press YES. "Complete!" appears and the program is completed.

- 6 Turn AMS (or press **◀▶** repeatedly) to select "Play Mode," then press AMS or YES.
- 7 Turn AMS (or press **◀▶** repeatedly) to select "Program," then press AMS or YES (or press PROGRAM after step 5 for the remote). "PROGRAM" lights up at the display window.

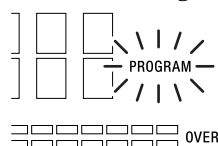

- 8 Press **▶** (▶). Program replay starts.

## To stop Program Play

Press **■**.

## To resume normal play

While the recorder is stopped, press CONTINUE in the remote. "PROGRAM" at the display window turns off.

- 💡 The program remains even after Program Play ends or is stopped. Press **▶** to play from the beginning of the program again. If the play is stopped, the program will not be lost.

## Notes:

- If the MD is ejected, the program will be lost.
- The display shows "— m — s" when the total playing time of the program exceeds 255 minutes.
- "ProgramFull" appears when you try to program 26 th track.
- The set program will be lost when you try record or edit operation.

## Checking the order of tracks in the program

While the recorder is stopped and "PROGRAM" lights up, press LEVEL/DISPLAY/CHAR (or DISPLAY) repeatedly. The first several tracks in the program appear in the display.

- 💡 To see the rest of the program After the first several tracks in the program appear by the above procedure, turn AMS clockwise (or press repeatedly).

### Changing the contents of the program

While the recorder is stopped and "PROGRAM" lights up, do steps 1 and 2 of "Programming the tracks" on page 33, followed by one of the procedures below.

To	Do the following:
Erase a track	Press ◀▶ repeatedly until the number of the unwanted track flashes, then press CLEAR.
Erase all tracks	Press CLEAR repeatedly until all the track numbers disappear.
Add a track at the beginning of the program	Press ◀ repeatedly until "0" flashes before the first track number, then do steps 3 to 5 of "Programming the tracks" on page 33.
Add a track in the middle of the program	Press ◀▶ repeatedly until the track number which will precede the new track flashes. Press AMS to display flashing "0," then do steps 3 to 5 of "Programming the tracks" on page 33.
Add a track to the end of the program	Press ▶ repeatedly until "0" flashes after the last track number, then do steps 3 to 5 of "Programming the tracks" on page 33.
Replace a track	Press ◀▶ repeatedly until the number of the track to be changed flashes, then do steps 3 to 5 of "Programming the tracks" on page 33.

## Storing the Located Track to Start Play Instantaneously (Multi-access Play)

The beginning of track is prestored in memory and play starts instantaneously when the track is selected. Up to 10 tracks can be stored in memory.

**The function below cannot work in Multi-access.** Multi-access is based on single play. This function is used to instantaneously play the track specified by the Number key on the remote (track selected by AMS of the recorder). Therefore, Record, Variable speed play, ◀▶ (backward/forward), Repeat Play, Auto Pause, Auto Cue, Mark, and Locate function are invalid.

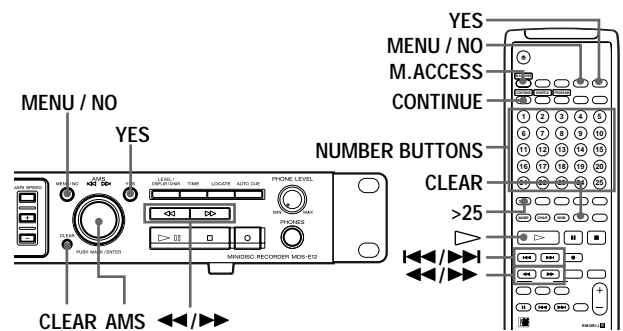

### Programming access play tracks

- 1 While the recorder is stopped, press MENU/NO twice. "Set up Menu" appears in the display.
- 2 Turn AMS (or press ◀▶ repeatedly) to select "M.Access?" then press AMS or YES. The display window displays the access play track in the program.



- 3 Turn AMS (or press ◀▶ repeatedly) to select a track number you want to store, then press AMS or YES. (Or press the Number buttons to directly enter the track number.)

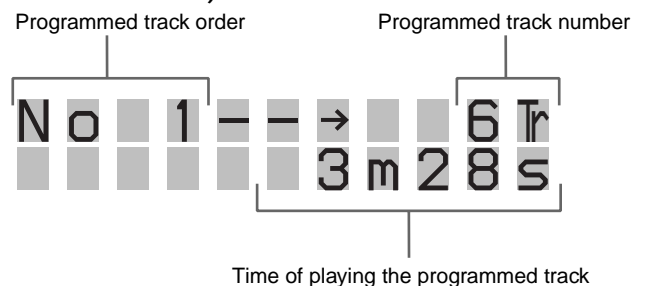

### If you entered the wrong track number

Press ◀ repeatedly until the wrong track number appears and turn AMS (or press ◀/▶) to enter a correct track number. Press CLEAR to erase the track order so that the track order is moved up.

### To enter a track number over 26

Use >25. For details, see page 29.

- 4 Repeat step 3 to store the track you want to access.
- 5 Press YES.  
"Complete!" appears and the track order and track number to be stored are completed.
- 6 Turn AMS (or press ◀/▶ repeatedly) to select "Play Mode" of "Setup Menu" then press AMS or YES.
- 7 Turn AMS (or press ◀/▶ repeatedly) to select "M.Access" then press AMS or YES. (Press M.ACCESS after step 5 for the remote.)  
"M.Access" and "1" (Single Play) light up and "Memorizing" (during recording) flashes, then the normal screen is returned.

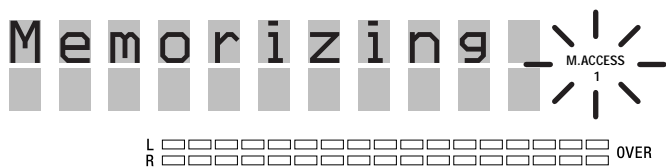

### Note

If the MD is inserted when Multi-access Play is selected, "Memorizing" flashes and track numbers 1 to 10 in the track order are recorded and programmed automatically.

### To stop "Memorizing"

Press ■ (stop) when "Memorizing" is flashing. "Memorizing" stops and "Play Mode" returns to normal play (CONTINUE).

## Multi-access play

Press the Number buttons on the remote you want to play the track order.

- To play by the recorder  
Turn AMS to select the track order, then press AMS.

### To resume normal play

While the recorder is stopped, press CONTINUE on the remote. "M.Access" and "1" at the display window turn off.

- The program is stored until the MD is ejected  
If the play is stopped or Play Mode is changed and "M.Access" turns off, the program is stored. If the multi-access is selected again, "Memorizing" flashes and the entered program is stored in memory.

### Notes

- If the MD is ejected, the program will be lost.
- "ProgramFull" appears when you try to program 11 th track.
- The set program will be lost when you try record or edit operation.

## Checking the program

- 1 While the recorder is stopped, press MENU/NO twice.  
"Setup Menu" appears in the display.
- 2 Turn AMS (or press ◀/▶ repeatedly) to select "M.Access?" then press AMS or YES.
- 3 Press ◀/▶ repeatedly for checking.
- 4 Press MENU/NO to return normal display.

## Changing the contents of the program

Do steps 1 to 2 of "Checking the program" and follow the procedures below.

To	Do the following:
Erase a track	Press ◀/▶ repeatedly until the number of the unwanted track appears, then press CLEAR.
Erase all tracks	Press CLEAR repeatedly until all the track numbers disappear.
Add a track to the end of the program	Press ▶ repeatedly until the track order in which "0" flashes, then do step 3 of "Programming access play tracks" on page 34. If 10 tracks are programmed, "ProgramFull" appears and no addition is made.
Replace a track	Press ◀/▶ repeatedly until the changed track order appears, then do step 3 of "Programming access play tracks" on page 34.

## Setting Play Start Position After Play Is Stopped (Resume Play)

After play is stopped by pressing STOP, you can set play start position when play starts.

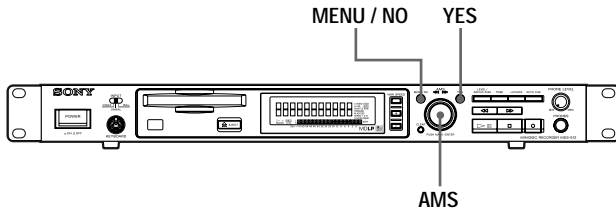

- 1 While the recorder is stopped, press MENU/NO twice.  
"Setup Menu" appears in the display.
- 2 Turn AMS (or press ◀▶ repeatedly) to select "Resume Mode," then press AMS or YES.
- 3 Turn AMS (or press ◀▶ repeatedly) to select from the following three edit modes:  
 Resume Off: No resume play is performed.  
 Resume Play: Play starts from the position of previous stop.  
 Resume Next: Play starts from the beginning of the next track of the previously stopped track.  
 Press AMS or YES.
- 4 Press MENU/NO.

**Note**  
 Resume Play becomes OFF forcibly and does not work during Shuffle Play or Multi-access Play.  
 If you use Resume Play again, reset by the above procedure.

## Returning to the Specified Point (Locate Play)

You can repeatedly locate the desired setting point.

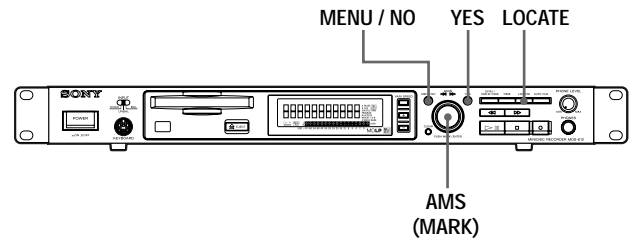

### To mark the desired point (MARK)

The following two ways can be used to determine the point.

- 1 Press AMS (MARK) during play.  
 The play time when AMS is pressed is determined the specified point. "MARK" lights up at the display window.

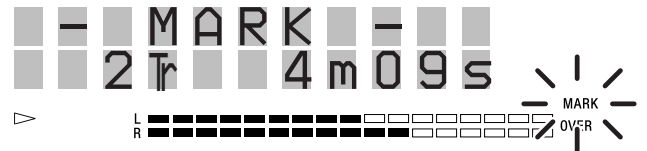

- 2 Specify numeric directly for the track number and play time to set the point.
  - 1 While the recorder is stopped, press MENU/NO twice.  
"Setup Menu" appears in the display.
  - 2 Turn AMS (or press ◀▶ repeatedly) to select "Direct Mark", then press AMS or YES.
  - 3 Turn AMS to display the track number to be located, then turn AMS.



- 4 Similarly with step 3, set minutes, seconds, and frames in order to locate a point.  
 "Complete!" appears and "Mark" lights up at the display window, then normal display is returned. You can slide a position for each frame\* (f) (1 frame = 1/86 seconds).  
 \* Monaural or LP2 stereo tracks move two frames at a time, LP4 stereo tracks move four frames at a time.

To set quickly, press ◀▶ repeatedly in step 4. Change units advanced when AMS is turned (or ◀▶ is pressed) to frames, seconds, or minutes.

## Fine adjusting the marked point (Rehearsal)

You can fine adjust the determined point while monitoring the sound of play.

- 1 While the recorder is stopped, press MENU/NO twice.  
"Setup Menu" appears in the display.
- 2 Turn AMS (or press ◀◀/▶▶ repeatedly) to select "Mark Rehear", then press AMS or YES.  
"-Rehearsal-" flashes and play is repeated for several seconds from the already determined point.

- Rehearsal -  
3m43s04f

- 3 Turn AMS (or press ◀◀/▶▶ repeatedly) to move the location of a track.  
You can slide a position for each frame\* (f) (1 frame = 1/86 seconds).  
\* Moraaural or LP2 stereo tracks move two frames at a time, LP4 stereo tracks move four frames at a time.  
To set quickly, press ◀◀/▶▶ repeatedly in step 4.  
Change units advanced when AMS is turned (or ◀◀/▶▶ is pressed) to frames, seconds, or minutes.
- 4 After the point is determined, press AMS or YES.  
"Complete" appears and normal display is returned.

### Notes

- If the point (MARK) is not determined, "Mark Rehear" of "Setup Menu" does not appear.
- Adjustment of the point in Rehearsal cannot be moved over the track.

## To locate the marked point

When LOCATE is pressed, play pauses in the determined marked point. You can start playing again from the same location.

### Notes

- When one of the following operations is performed, Mark is released. To play Locate, set Mark again.
  - Eject the disc.
  - Perform Edit Menu.
  - Record.
- During the programmed play, if the LOCATE is pressed though the Track in which the marked point is not included to the playing program, "No Program" is displayed.
- Locate does not function during shuffle Play and Multi-access Play.

## Pausing After Each Track (Auto Pause)

You can set the MD recorder so that it pauses automatically at the beginning of the next track after play back of each track. This is convenient to record one track only or several uncontinuous tracks.

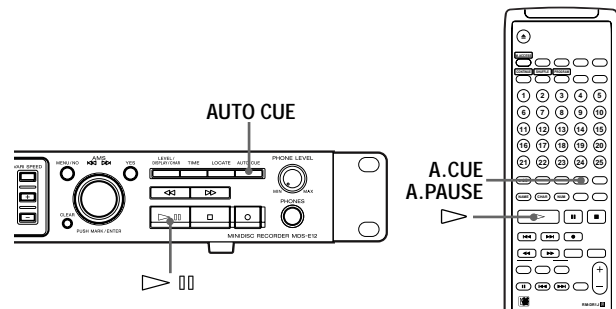

Press AUTO CUE repeatedly until "A.PAUSE" appears at the display window. (Or press A.CUE/A.PAUSE.)

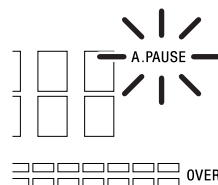

### To stop Auto Pause

Press AUTO CUE repeatedly until "A.PAUSE" at the display window disappears. (Or press A.CUE/A.PAUSE.)

## Making Track Play Start Soon (Auto Cue)

You can skip the portion from the beginning of a track to actual sound playing start. This is convenient to add a sound during video editing (postrecording).

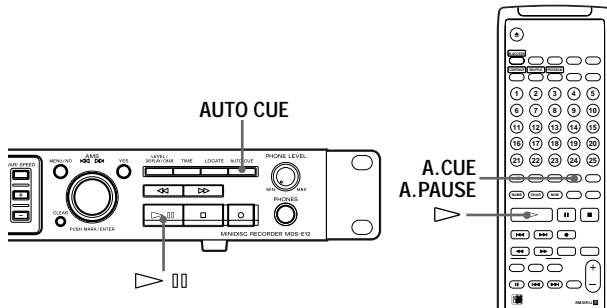

- 1 Press AUTO CUE repeatedly until "A.CUE" lights up at the display window. (Or press A.CUE/A.PAUSE.)

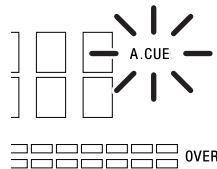

- 2 When you turn AMS to select a track number in which you want to start playing soon, then press AMS (or press Number buttons), the recorder searches the first portion where the sound of the track is made and play pauses.
- 3 When ▷|| is pressed, play starts instantaneously.

### To stop Auto Cue

Press AUTO CUE until "A.CUE" at the display window disappears. (Or press A.CUE/A.PAUSE.)

### Auto Pause and Auto Cue

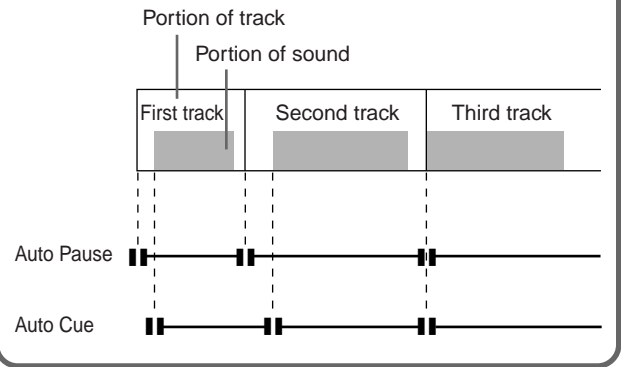

- 💡 You can select the level (threshold level) of a sound in the Auto Cue position

The recorder finds the first point to which a sound of  $-72\text{dB}$  or more is output from the beginning of a track and play pauses.

You can select the level of a sound at the pause point among 5 levels ( $-72\text{ dB}$ ,  $-68\text{ dB}$ ,  $-60\text{ dB}$ ,  $-54\text{ dB}$ , and  $-48\text{ dB}$ ).

- 1 While the recorder is stopped, press MENU/NO twice. "Setup Menu" appears in the display.
- 2 Turn AMS (or press ◀◀/▶▶ repeatedly) until "A.Cue Level" appears, then press AMS or YES.
- 3 Turn AMS (or press ◀◀/▶▶ repeatedly) until the level to be set appears, then press AMS or YES.
- 4 Press MENU/NO.

- 💡 You can slide the stop position by Auto Cue to make the room of the start portion and adjust a slight gap.

- 1 While the recorder is stopped, press MENU/NO twice. "Setup Menu" appears in the display.
- 2 Turn AMS (or press ◀◀/▶▶ repeatedly) to select "A.Cue Offset", then press AMS or YES.
- 3 Turn AMS (or press ◀◀/▶▶ repeatedly) to select a set value to slide within 1 second (86 frames), then press AMS or YES.
- 4 Press MENU/NO.

### Notes

- You cannot slide over the track number.
- You can slide each frame. Sliding is made to the position of frames with a multiple of 2 for monaural or stereo-recorded tracks and with a multiple of 4 for LP4 stereo-recorded tracks. Fractions are omitted.

## Changing Playback Speed (Variable Speed Play)

You can adjust the play time by changing the speed of play.

You can adjust the speed of a track in the normal range of  $\pm 12.5\%$ . You can play late at up to 12.5% of normal speed (in this case, a pitch is low) and fast at up to 12.5% of normal speed (in this case, a pitch is high).

### Note

MDLP-recorded tracks cannot be played faster than normal speed. When you play an MD containing the MDLP-recorded tracks, adjustment of the speed automatically (0 to  $-12.5\%$ ) is made.

If you play an MD containing MDLP-recorded tracks when fast speed is set, the speed becomes 0% automatically.

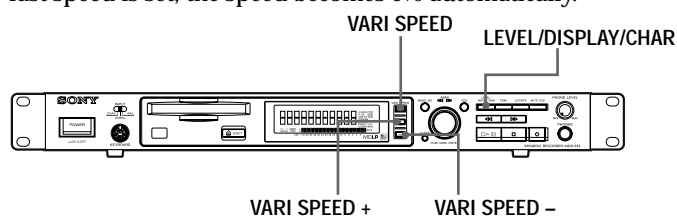

- 1 Press **VARI SPEED** during stop, play or pause.  
“V.SPEED” lights up at the display window.

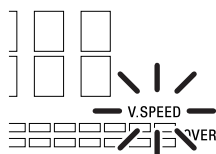

- 2 Press **VARI SPEED +** or **-** to select desired speed.

You can adjust the speed of VARI SPEED when the display window is normal (“Using the Display Window” on page 12).

For other displays, you can turn on and off VARI SPEED, but cannot adjust the speed. You can adjust it when normal display is returned by pressing **DISPLAY/CHAR** and % of the speed to be changed appears.

The speed changes in the unit of 0.5%.

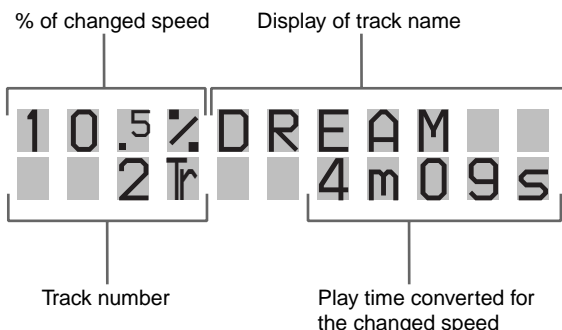

The time display at the display window is also displayed during conversion for the changed speed.

### To stop Variable Speed Play

Press **VARI SPEED** to turn off “V.SPEED” at the display window. The display window also returns to normal display.

# Editing Recorded MDs

This chapter explains the various editing methods that are available.

## Before you start editing

### RAM editing and DISC editing

Two edit modes are available.

**DISC editing :** The results of editing are recorded to the disc's TOC.

**RAM editing :** The results of editing are not recorded, but are only temporarily edited for output.

RAM editing allows for the editing of record-protected discs or premastered discs.

Editing operation methods are common.

### Notes

- To protect music copyright, premastered MD that has been RAM edited cannot be digitally recorded.
- RAM editing is a temporary edit only, so the contents of editing cannot be written to disc. When the disc is removed, the contents of editing is not saved.
- Recording and S.F EDIT cannot be made in RAM edit mode.

### To select RAM editing

Insert a disc while pressing ■ (STOP). "RAM" lights up in the display.

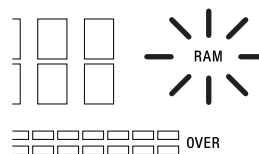

### To select DISC editing

Remove the disc once. The "RAM" indication on the display will disappear, and the mode is returned to DISC editing.



## Using buttons and control for editing operations

The buttons and control of the recorder can be used as described below to erase, divide, move or combine tracks.

### Note

When a name is given to a track or disc, the functions of the buttons and control described below will change. For more details, see the section “Naming track or MD” (page 46).

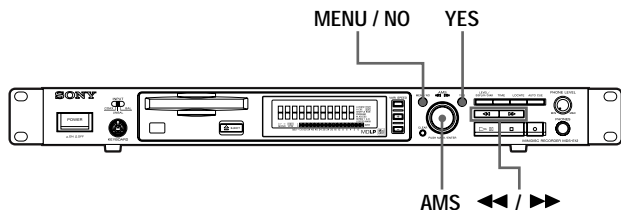

**MENU/NO:** When pressed, “Edit Menu” appears on the display and editing operations can be selected. If the button is pressed during editing, editing is canceled.

**AMS:** The desired editing operation and track number are selected by turning the AMS; confirmation is made by pressing it. It is also used to erase part of a track, or to specify the division of a track.

**YES:** This can be used instead of pressing AMS.

**◀▶:** Press to specify the unit (minute, second, or frame) which playback is advanced when the AMS control is turned.

You can also use these buttons to locate the end point of the portion to be erased.

For more information on the functions of each button, refer the page on the editing operations.

## About indication which appears during editing

**When “Protected” appears in the display.**

The MD’s record-protect slot is open, and editing cannot be made. Slide the record-protect tab to close the slot. For more details, see the section “To prevent accidental erasure of the recorded material” on page 19.

## About indications which appear after editing

**When “TOC” lights up in the display**

The material that has been edited has not yet been recorded to the MD. Remove the MD, or turn off and then turn on power to the recorder; the edited material will be written to disc.

**When “TOC Writing” flashes in the display**

The edited material is being recorded to the MD. Do not disconnect the power supply and do not move the MD—the sound material may not be recorded properly.

## Erasing Tracks (ERASE)

By specifying the number of a track to be erased, or the section to be deleted. All tracks, or any number of tracks, can also be erased.

### Erasing a single track (ERASE)

The track number is selected and the track is erased.

**Example: The second track (track name “BBB”) is to be erased:**

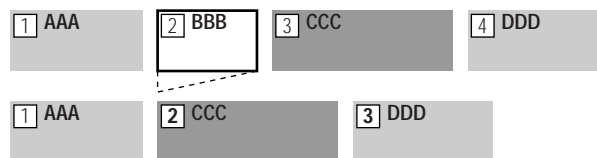

When a track is erased, the track numbers are automatically reassigned. For example, when track two is erased, the previous track number three and all others after it move up one track number.

- 1** Press MENU/NO while the recorder is stopped, playing, or paused.  
“Edit Menu” appears in the display.
- 2** Turn AMS (or press ◀▶ repeatedly) until “TrErase?” appears in the display; press AMS or YES. The track number is displayed and playback of the track begins.
- 3** Turn AMS until the track number of the track to be erased is displayed (or press ◀▶ repeatedly).
- 4** Press AMS or YES.  
“Complete!” appears for a few seconds and then disappears. The track selected in step 3. is erased, and playback of the next track begins.

### To cancel the operation

Press MENU/NO or ■.

- 💡 When “ERASE???” is displayed during procedure 4. above: The track has been record-protected on another MD recorder. If you still want to erase this track, press AMS or YES again while the “ERASE???” indication appears.
- 💡 Erasing more than two tracks  
So that the track numbers do not change during the middle of operations, the tracks are erased from the furthest back first.

### Erasing all tracks on an MD (ALL ERASE)

All tracks on the MD and the all name are erased.

- 1 Press MENU/NO while the recorder is stopped, playing, or paused.  
"Edit Menu" appears in the display.
- 2 Turn AMS (or press ◀◀/▶▶ repeatedly) until "All Erase?" appears, then press AMS or YES.  
"All Erase??" appears in the display.
- 3 Press AMS or YES.  
"Complete!" appears for a few seconds and all the track names and disc name are erased.

#### To cancel the operation

Press MENU/NO or ■.

### Erasing a portion of a track (A-B Erase)

You can easily erase a portion of a track by specifying the starting and ending points of the erasure. This is convenient for erasing the unwanted portions of recordings of satellite or FM broadcasts.

#### Example: Erasing portion "B2" of the second track

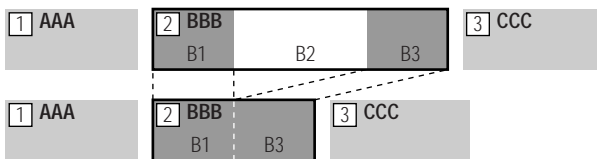

- 1 Press MENU/NO while the recorder is stopped, playing, or paused.  
"Edit Menu" appears in the display.
- 2 Turn AMS (or press ◀◀/▶▶ repeatedly) until "A-B Erase?" appears in the display; press AMS or YES.
- 3 Turn AMS (or press ◀◀/▶▶ repeatedly) until the number of the first track to be erased appears, then press AMS or YES.  
"-Rehearsal-" and "Point A ok?" alternate in the display and the recorder repeatedly plays the portion of the track from the point where AMS or YES was pressed.
- 4 While monitoring the sound, turn AMS (or press ◀◀/▶▶ repeatedly) to locate the starting point of the portion to be erased (point A).  
The position is moved one frame\* (f) at a time (one frame = 1/86 sec.).  
\* Monaural tracks or tracks recorded in LP2 stereo move two frames at a time; LP4 stereo tracks move four frames at a time.

#### To quickly choose point A

Press ◀◀/▶▶ in step 4 repeatedly to select frame, second or minute. The selected unit flashes in the display.

- 5 Repeat step 4 until point A plays properly
- 6 Press AMS or YES to enter point A  
"Point B set" appears, and playback from point A begins.
- 7 Continue playing the track or press ▶▶ to locate the ending point of the portion to be erased (point B), then press AMS or YES.  
"A-B Ers" and "Point B ok?" alternate in the display and a few seconds of the track before point A and after point B play back repeatedly.
- 8 Repeat step 4 until B has been correctly located
- 9 Press AMS or YES to enter point B  
"Complete!" appears for a few seconds, and the portion between A and B is erased.

#### To cancel the operation

Press MENU/NO or ■.

#### Note

When "Impossible" is displayed, the portion of the track cannot be erased.

After repeated editing of a track, it may become impossible to erase a portion of the track any further. This is a technical limitation of the MD system, and is not a mechanical error.

### Erasing consecutive tracks (Multitrack Erase)

Consecutive tracks can be specified to be deleted at one time.

- 1 Press MENU/NO while the recorder is stopped, playing, or paused.  
"Edit Menu" appears in the display.
- 2 Turn AMS (or press ◀◀/▶▶ repeatedly) until "M-Tr Erase?" appears in the display; press AMS or YES.
- 3 Turn AMS (or press ◀◀/▶▶ repeatedly) until the number of the first track to be erased appears, then press AMS or YES.
- 4 Turn AMS (or press ◀◀/▶▶ repeatedly) until the number of the last track to be erased appears, then press AMS or YES.  
"M-Tr Ers OK?" appears with the numbers of the first (※) and last (#) tracks also appearing as "※ - #→Ers".
- 5 Press AMS or YES  
"Complete!" appears for a few seconds, and the tracks selected in steps 3 and 4 are erased.

#### To cancel the operation

Press MENU/NO or ■.

## Combining Tracks (COMBINE)

This allows you to combine any two tracks into a single track. The two tracks do not have to be consecutive to be combined. Tracks from the end of the track order can be combined with those in the front. Several independently selected portions of tracks can be combined into a single track. When two tracks are combined, the tracks are reordered and unneeded track numbers are deleted.

### Notes

- Only tracks of the same recording mode (stereo, monaural, LP2 stereo, or LP4 stereo) can be combined.
- If “Impossible” appears in the display, the tracks can’t be combined because repeated editing has been done to the track(s). This is a technical limitation of the MD system, and is not a mechanical error.
- It is impossible to use the “Undo?” function when combining multiple tracks, so make sure to be careful before completing the combination.

### Combining two tracks (COMBINE)

**Example: combining the second track and fourth track**

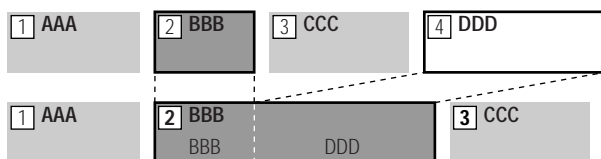

The track name of the first track becomes the name of the combined track.

- 1 Press MENU/NO while the recorder is stopped, playing, or paused.  
“Edit Menu” appears in the display.
- 2 Turn AMS (or press ◀▶ repeatedly) until “Combine?” appears in the display; press AMS or YES.
- 3 Turn AMS (or press ◀▶ repeatedly) until the number of the first track of the two to be combined appears, then press AMS or YES.  
The display for selecting the second track appears and the recorder repeatedly plays the portion where joining will occur (several seconds of the end of the first track and the beginning of the track following it).
- 4 Turn AMS (or press ◀▶ repeatedly) until the number of the second track of the two to be combined appears, then press AMS or YES.  
“Complete!” appears for a few seconds, and the tracks are combined. The recorder begins to play the combined track.

### To cancel the operation

Press MENU/NO or ■.

### Combining consecutive tracks (Multi track combine)

Multiple consecutive tracks are combined.

The track name of the first track becomes the name of the combined track.

- 1 Press MENU/NO while the recorder is stopped, playing, or paused.  
“Edit Menu” appears in the display.
- 2 Turn AMS (or press ◀▶ repeatedly) until “M-Tr Combin?” appears in the display; press AMS or YES.
- 3 Turn AMS (or press ◀▶ repeatedly) until the number of the first track to be combined appears, then press AMS or YES.  
The display for selecting the second track appears.
- 4 Turn AMS (or press ◀▶ repeatedly) until the number of the final track to be combined appears, then press AMS or YES.  
“M-Tr Com OK?” appears with the numbers of the first (※) and last (#) tracks also appearing as “※ - #→※”.
- 5 Press AMS or YES  
“Complete!” appears for a few seconds, then the display returns to normal.

---

## Moving Tracks (MOVE)

This function lets you change the order of any track

**Example: Moving the second track after the third track**

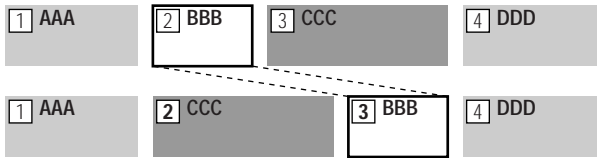

After you move a track, the tracks are automatically renumbered.

- 1 Press MENU/NO while the recorder is stopped, playing, or paused.  
“Edit Menu” appears in the display.
- 2 Turn AMS (or press ◀◀/▶▶ repeatedly) until “Move?” appears in the display; press AMS or YES.
- 3 Turn AMS (or press ◀◀/▶▶ repeatedly) until the number of the track to be moved appears, then press AMS or YES.
- 4 Turn AMS (or press ◀◀/▶▶ repeatedly) until the new track position appears, then press AMS or YES.  
“Complete!” appears for a few seconds, and the track is moved. The recorder begins playback of the moved track.

### To cancel the operation

Press MENU/NO or ■.

## Dividing Tracks (DIVIDE)

This function allows you to divide recorded material that has multiple tracks but only one track number, or to set a new beginning point in the middle of a track.

### Example: Dividing the second track

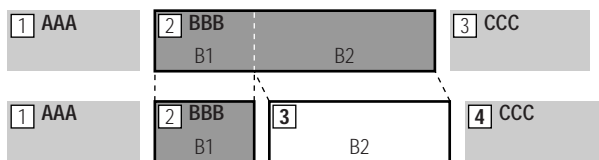

When you divide a track, the total number of tracks are automatically increased by one and renumbered.

### Dividing a track after selecting a track

- 1 Press MENU/NO while the recorder is stopped, playing, or paused.  
“Edit Menu” appears in the display.
- 2 Turn AMS (or press ◀◀/▶▶ repeatedly) until “Divide?” appears in the display; press AMS or YES.
- 3 Turn AMS (or press ◀◀/▶▶ repeatedly) until the number of the track you want to divide appears, then press AMS or YES.  
“-Rehearsal-” appears, press AMS or YES, and a few seconds of the track from that point repeatedly play back.
- 4 While monitoring the sound, turn AMS (or press ◀◀/▶▶ repeatedly) to locate the dividing point  
The position is moved one frame\* (f) at a time (one frame = 1/86 sec.).  
\* Monaural tracks or tracks recorded in LP2 stereo move two frames at a time; LP4 stereo tracks move four frames at a time.

#### To quickly find a point

Press ◀◀/▶▶ repeatedly in step 4 to select the position by frame, second, or minute. The selected unit flashes in the display.

- 5 Repeat step 4 until you’ve located the proper dividing point
- 6 Press AMS or YES.  
“Complete!” appears for a few seconds, the track is divided, and the recorder begins to playback the new track. The new track is not given a new track name.

#### To cancel the operation

Press MENU/NO or ■.

- 💡 You can divide tracks while recording.  
For details, see “Marking Track Numbers While Recording” on page 23.

### Dividing a track after selecting the dividing point

- 1 While the recorder is playing, press (▶) at the point where you want to divide the track
- 2 Press MENU/NO.  
“Edit Menu” appears in the display.
- 3 Turn AMS (or press ◀◀/▶▶ repeatedly) until “Divide?” appears in the display; press AMS or YES.
- 4 If needed, refer to step 4 of “Dividing a track after selecting a track” on page 45, and adjust the position.
- 5 Press AMS or YES.  
“Complete” appears for a few seconds, the track is divided, and the recorder begins to play back the new track. The new track is not given a new track name.

#### To cancel the operation

Press MENU/NO or ■.

- 💡 You can divide tracks while recording  
For details, see “Marking Track Numbers While Recording” on page 23.

# Naming a Track or MD (NAME)

You can enter a name for a recorded MD, as well as for individual tracks. Names can consist of uppercase and lowercase letters, numbers and symbols. A total number of 1,700 characters can be stored for all names on the MD.

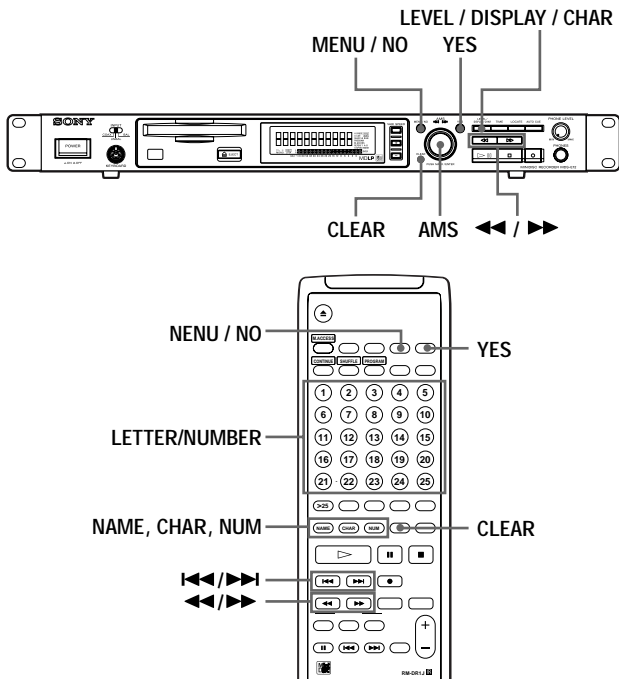

## Notes

If you name a track while it is being recorded, be sure to finish the naming operation before the track ends. If the track ends before you finish, the entered character data will be discarded and the tracks will remain unnamed. Also, you can't name tracks while the recorder is recording over existing material.

## Naming a Track or MD using the controls on the recorder

- 1 Press MENU/NO while the recorder is stopped, playing, or paused. "Edit Menu" appears in the display.
- 2 Turn AMS until "Name?" appears in the display; press AMS or YES.
- 3 Turn AMS until "Nm In?" appears, then press AMS or YES. When naming is being made during recording, the cursor flashes and characters can be entered. Please proceed to step 5.
- 4 Turn AMS until the track number (when naming a track) to "Disc" (when naming the MD) flashes, then press AMS or YES. When the cursor flashes, characters can be entered. The track number flashes, the track begins to play back automatically so the track can be confirmed and the track name entered.



- 5 Press LEVEL/DISPLAY/CHAR repeatedly to select the character type

To select	Press repeatedly until
Uppercase letters	"A" appears in the display
Lowercase letters	"a" appears in the display
Numbers	"0" appears in the display
Symbols*	"," appears in the display

\*Symbols which can be used: '-/.,():!/?&+<>\_=";#\$\$%&@\*`



## To enter a space

Press >> while the cursor is flashing. However, the first character of the name cannot be a space.

**6** Turn AMS to select the character.

The selected character flashes.



To change a selected character

Repeat steps 5 and 6.

**7** Press AMS.

The selected character is entered and is continuously displayed. The cursor moves to the next position, and again flashes.



**8** Repeat steps 5 to 7 to enter the rest of the name.

To change a character

Press ◀/▶ repeatedly until the character to be changed flashes, then repeat steps 5 to 7.

To erase a character

Press ◀/▶ repeatedly until the character to be erased flashes, then press CLEAR.

**9** Press YES.

“Complete!” appears in the display, and the name is entered.

To cancel the operation

Press MENU/NO or ■.

**Naming a track or MD using the remote**

**1** Naming a track or disc is done by the following operations.

- **Naming a track**  
While the track number is displayed and the recorder is stopped, playing, paused or recording, press NAME.
- **Naming a disc**  
When the total number of tracks is displayed and the recorder is stopped, press NAME.  
The cursor flashes, and the characters can be entered.

**2** Repeatedly press CHAR or NUM to select the character type

Character type	Display
Uppercase letters or symbols*	“Selected AB”
Lowercase letters or symbols*	“Selected ab”
Numbers or symbols	“Selected 12”

\* Symbols which can be used: - / , . ( ) ! ?

**3** Press letter/number to enter the characters

After you enter a character, the cursor shifts rightward and waits for the input of the next character.

**4** Repeat steps 2 and 3 to enter the rest of the name.

To change a character

Press ◀/▶ repeatedly until the character to be changed flashes, press CLEAR to erase the character, then repeat steps 2 and 3.

**5** Press YES.

“Complete!” appears in the display, and the name is entered.

To cancel the operation

Press MENU/NO or ■.

## Copying names (Name Copy)

You can copy track or disc names to other tracks within the disc.

- 1 Press MENU/NO while the recorder is stopped, playing, or paused.  
“Edit Menu” appears in the display.
- 2 Turn AMS (or press **◀◀/▶▶** repeatedly) until “Name?” appears in the display; press AMS or YES.
- 3 Turn AMS (or press **◀◀/▶▶** repeatedly) until “Nm Copy?” appears in the display; press AMS or YES.
- 4 Turn AMS (or press **◀◀/▶▶** repeatedly) until the track name (when copying the track name) or “Disc” (when copying the disc name) flashes in the display; press AMS or YES.  
When “No Name” is displayed  
The selected track or disc has no name.
- 5 Turn AMS (or press **◀◀/▶▶** repeatedly) until to the track number to be copied to (when naming a track) or “Disc” (when naming a disc) flashes in the display; press AMS or YES.  
“Complete!” appears for a few seconds, and copying is complete.

### To cancel the operation

Press MENU/NO or **■**.

-  When “Overwrite??” appears in step 5  
A track name or disc name has already existed to the target track. If you still want to copy the name, press AMS or YES again while the indication is displayed.

### Note

When a track name of a track recorded in MDLP (LP2 or LP4) is copied onto a track recorded in stereo or monaural, the “LP:” stamp indicating an MDLP recording is copied to the beginning of the track and displayed.

## Copying the same name to all tracks and disc. (Name All Copy)

You can copy the same name simultaneously to all tracks and disc on the MD.

- 1 Press MENU/NO while the recorder is stopped, playing, or paused.  
“Edit Menu” appears in the display.
- 2 Turn AMS until “Name?” appears in the display; press AMS or YES.
- 3 Turn AMS (or press **◀◀/▶▶** repeatedly) until “NM All Copy?” appears, then press AMS or YES.

- 4 Turn AMS (or press **◀◀/▶▶** repeatedly) until the track name (when copying the track name) or “Disc” (when copying the disc name) flashes in the display; press AMS or YES.

### When “No Name” is displayed

The selected track or disc has no name, and copying cannot be completed. “Empty Name” will be displayed.

- 5 Turn AMS (or press **◀◀/▶▶** repeatedly) until the correct selection (below) appears; press AMS or YES.

Name	Selection
Only the section without a name (No Name) is copied	Copy Only No Name ?
All names are to be overwritten	Copy All Overwrite?

“Complete!” appears for a few seconds, and copying is complete.

### To cancel the operation

Press MENU/NO or **■**.

### Note

- Copying of all names cannot use the “Undo?” function, so make sure to be careful before completing the copying.
- When a track name of a track recorded in MDLP (LP2 or LP4) is copied onto a track recorded in stereo or monaural, the “LP:” stamp indicating an MDLP recording is copied to the beginning of the track and displayed.

## Adding date and time to the name of recorded tracks (Auto Calendar)

The internal clock in the recorder allows you to automatically add the time and date to the name of tracks.

- 1 Press MENU/NO twice while the recorder is stopped  
“Setup Menu” appears in the display.
- 2 Turn AMS (or press **◀◀/▶▶** repeatedly) until “A.Calendar?” appears in the display; press AMS or YES.
- 3 Turn AMS (or press **◀◀/▶▶** repeatedly) until the correct selection (below) appears; press AMS or YES.

Date and time is to be added to tracks	Selection
Yes	On
No	Off

- 4 Press MENU/NO.

### Note

When adding the name of a track recorded by Auto Calendar, be would not record the “LP:” stamp indicating an MDLP recording.



## Renaming a track or MD

- 1 To rename a track or disc name, do the following:
  - To rename a track  
While the track number is displayed and the recorder is stopped, playing, paused or recording, press NAME.
  - To rename a disc  
When the total number of tracks is displayed and the recorder is stopped, press NAME.  
The disc name is displayed.
- 2 Press CLEAR, and the displayed track name or disc name is erased.
- 3 Rename the track or disc. Do steps 5 to 8 of "Naming a track or MD using the controls on the recorder" on page 46, or steps 2 to 4 or "Naming a track or MD using the remote" on page 47.
- 4 Press NAME

## Erasing a track or disc name (Name Erase)

Use this function to erase the name of a track or disc.

- 1 Press MENU/NO while the recorder is stopped, playing, or paused.  
"Edit Menu" appears in the display.
- 2 Turn AMS (or press ◀◀/▶▶ repeatedly) until "Name?" appears in the display; press AMS or YES.
- 3 Turn AMS (or press ◀◀/▶▶ repeatedly) until "Nm Erase?" appears in the display; press AMS or YES.
- 4 Turn AMS (or press ◀◀/▶▶ repeatedly) until the track number (when the erasing the track name) or "Disc" (when erasing the disc name) flashes; press AMS or YES.  
"Complete!" appears for a few seconds, and the name is erased.

### To cancel the operation

Press MENU/NO or ■.

## Erasing all names on the MD (Name All Erase)

You can erase all the track names and disc name on an MD in a single operation.

- 1 Press MENU/NO while the recorder is stopped, playing, or paused.  
"Edit Menu" appears in the display.
- 2 Turn AMS (or press ◀◀/▶▶ repeatedly) until "Name?" appears in the display; press AMS or YES.
- 3 Turn AMS (or press ◀◀/▶▶ repeatedly) until "Nm All Ers?" appears in the display; press AMS or YES.  
"Nm All Ers??" appears in the display.
- 4 Press AMS or YES.  
"Complete!" appears for a few seconds, and all names on the MD are erased.

### To cancel the operation

Press MENU/NO or ■.

- 💡 All the recorded tracks and names of an MD can also be erased at the same time  
For details, see "Erasing all the tracks on an MD" on page 42.

## Undoing the Last Edit (UNDO)

You can undo the last edit operation and restore the contents of the MD to the condition that existed before the operation. Please note, however, that you cannot undo an edit operation if you performed any of the following operations after the edit:

- Pressed REC ● on the recorder
- Pressed MUSIC SYNC or STANDBY MUSC SYNC on the remote
- Performed other editing operations
- Turned off the recorder or ejected the MD
- Disconnected the AC power cord

Also, if “M-TR Combine,” “Nm All Copy” or “S.F Edit” have been used for editing, the “Undo?” function cannot return the tracks or disc to the original condition.

- 1 Press MENU/NO while the recorder is stopped. “Edit Menu” appears in the display.
- 2 Turn AMS (or press ◀▶ repeatedly) until “Undo?” appears in the display. “Undo?” will not appear if no editing has been done.
- 3 Press AMS or YES. One of the following messages will appear, depending on the last edit operation.

Last edit operation	Message
Erasing a track	Erase Undo?
Erasing all the tracks on an MD	
Erasing a portion of a track	
Erasing consecutive tracks	Divide Undo?
Dividing a track	
Combining tracks	Combine Undo?
Moving a track	Move Undo?
Naming a track or MD	Name Undo?
Copying a track or disc name	
Renaming a track or MD	
Erasing a track or disc name	
Erasing all the names on the MD	

- 4 Press AMS or Yes. “Complete!” appears for a few seconds, and the MD is restored to the condition that existed before the edit operation.

### To cancel the operation

Press MENU/NO or ■.

## Changing Recorded Level after Recording (S.F Edit)

With this function, you can change the recorded level of a track. The new level overwrites the original recording. the Fade In/Fade Out function gradually increase the level at the beginning of a track, then gradually decrease the level at the end of the track.

### Notes

- The Undo function cannot be used to return the overwritten data to its original condition. Be sure to make a backup copy before using S.F Edit.
- Tracks recorded by MD LP cannot be altered with S.F Edit. If change is attempted, “Cannot Edit” appears on the display.

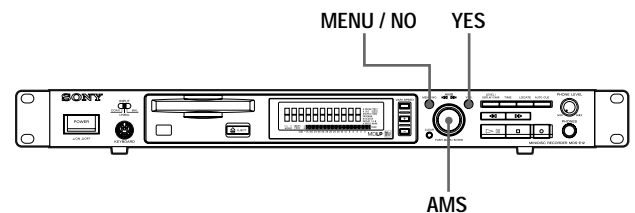

### Changing the level of a whole track

- 1 Press MENU/NO when the recorder is stopped. “Edit Menu” appears in the display.
- 2 Turn AMS (or press ◀▶ repeatedly) until “S. F Edit” appears in the display; press AMS or YES.
- 3 Turn AMS (or press ◀▶ repeatedly) until “Tr Level?” appears in the display; press AMS or YES.
- 4 Turn AMS (or press ◀▶ repeatedly) until the track number of the track to be changed appears in the display; press AMS or YES. “Level 0dB” appears in the display.
- 5 While monitoring to the playback, Turn AMS (or press ◀▶ repeatedly) until the desired level is heard. Level can be changed in 2dB units, from -12dB to +12dB. When the playback level is at the highest setting, be sure to adjust the level so that the right-hand indicator of the peak level meter does not light.

Level 1 - 2dB



This indicator should not illuminate.

- 6 Press AMS or YES. “Edit OK?” appears in the display.
- 7 Press AMS or YES. Overwriting of the track is started. “S.F Edit \*\*%” appears during overwriting. The overwriting of the track takes approximately as long as the playback time of the track or longer. “Complete!” is displayed when overwriting is finished.

### To Use Fade In/Fade Out

- 1 Press MENU/NO while the recorder is stopped.  
"Edit Menu" appears in the display.
- 2 Turn AMS (or press ◀▶ repeatedly) until "S. F Edit" appears in the display; press AMS or YES.
- 3 Turn AMS (or press ◀▶ repeatedly) until "Fade In?" or "Fade Out?" appears in the display; press AMS or YES.
- 4 Turn AMS (or press ◀▶ repeatedly) until the track number of the desired track appears in the display; press AMS or YES.  
"Time 5.0s" appears in the display.
- 5 While listening to the playback, Turn AMS (or press ◀▶ repeatedly) to adjust the fade in or fade out times.  
the section to fade in or fade out is played back repeatedly.  
Fade time is adjustable in 0.1 second intervals, from 1 to 15 seconds. You cannot set the time longer than the track.
- 6 Press AMS or YES.  
"Edit OK?" appears in the display.
- 7 Press AMS or YES.  
Rewriting of the track is started.  
During overwriting, "S. F Edit \*\*%" appears.  
When writing is finished, "Complete!" will appear for a few seconds.

### To cancel the operation

In steps 1 to 5, press MENU/NO ■.

### To force a stop during writing

The portion Already written cannot be returned to its original state, but cancellation can be made with the following steps.

- 1 During writing, press ■ (Stop), MENU/NO or CLEAR.  
"Edit Stop?" will be appear in the display, then "No" will flash.  
When "No" is displayed. press MENU/NO, YES or AMS to continue the overwriting.
- 2 Turn AMS until "YES" appears on the display  
Pressing YES or AMS stops the overwriting of the data.  
Press MENU/NO to continue the overwriting of data.

### Notes

- Do not move the recorder or remove the AC power plug during this operation. The recording information will be damaged, and a good recording will not be made.
- Level change cannot be made with LP2 or LP4 mode recording tracks.
- Do not use damaged or dirty MDs. The recording sometimes cannot be properly completed.
- Repeated change of level will result in a deterioration of sound quality.
- If the level has been changed once, and then changed again to the original level, the recording level will not actually be returned to the original state.
- The "Undo" function cannot be used to return a track where the level has been changed to its original level.

# Other Functions

This chapter explains other useful functions that are available on the MD recorder.

## Fade IN and Fade Out

You can use Fade-in Play to gradually increase the signal level to the ANALOG OUT jacks and the PHONES jack at the start of playback. Fade-out Play gradually reduces the signal level at the end of playback. Fade-in recording gradually increases the signal level at the start of recording. Fade-out recording gradually decreases the signal level at the end of recording.

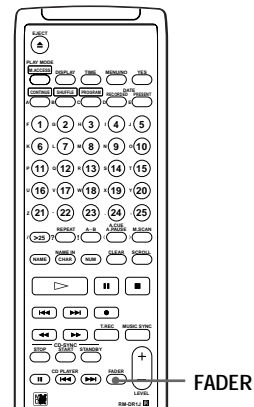

### Note

The level of the signal output from the DIGITAL OUT connector does not change in Fade-in Play or Fade-out Play.

### Fade-in Play and Fade-in Recording

**During pause play (for Fade-in Play) or recording pause (for Fade-in recording), press FADER.**

Fade in begins.

“Fade ◀ 5.0s” appears in the display with the ◀ flashing. The recorder performs Fade-in for five seconds until the counter shows “0.0s”.

### Fade-out Play and Fade-out Recording

**During pause play (for Fade-out Play) or recording pause (for Fade-out recording), press FADER.**

Fade out begins.

“Fade ▶ 5.0s” appears in the display with the ▶ flashing. The recorder performs Fade-out for five seconds until the counter shows “0.0s”. When Fade-out is complete, the recorder is paused automatically.

---

## Notification of the track end and the disc end (End Of Track/Disc)

This function gives an indication by a flashing message in the display when there is very little remaining time to the end of track during playback, or to the end of disc during recording.

### Notification of the track end being Playback-End Of track

### Notification of the disc end being Recorded-End Of Disc

The time for this indication can be set both for the remaining playback time of a track (factory setting of six seconds), or for the remaining time on a disc during recording (factory setting of three minutes).

- 1 Press MENU/NO twice.  
"Setup menu" appears in the display.
- 2 Turn AMS (or press ◀▶ repeatedly) until "End Of Tr/Disc" appears in the display; press AMS or YES.
- 3 Turn AMS (or press ◀▶ repeatedly) to "On" for notification, "Off" for no notification; press AMS or YES.
- 4 Press MENU/NO.

☼ To select the time for notification of the end of track

- 1 Press MENU/NO twice.  
"Setup menu" appears in the display.
- 2 Turn AMS (or press ◀▶ repeatedly) until "EOT(Play)" appears in the display; press AMS or YES.
- 3 Turn AMS (or press ◀▶ repeatedly) to select the desired time from 6 to 20 seconds; press AMS or YES.
- 4 Press MENU/NO.

☼ To select the time of notification to end of disc during recording

- 1 Press MENU/NO twice.  
"Setup menu" appears in the display.
- 2 Turn AMS (or press ◀▶ repeatedly) until "EOD (Rec)" appears in the display; press AMS or YES.
- 3 Turn AMS (or press ◀▶ repeatedly) to select the desired time from three to ten minutes; press AMS or YES.
- 4 Press MENU/NO.

## Using a Timer

By connecting a timer (not supplied) to the recorder, you can start and stop playback/recording operations at specified times. For further information on connecting the timer or setting the starting and ending times, refer to the instructions that came with the timer.

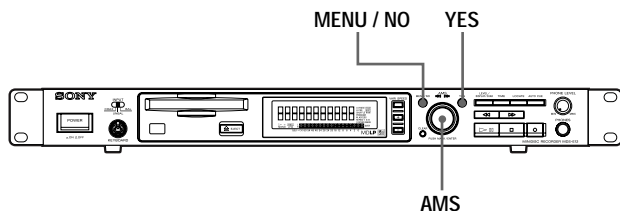

### Playing an MD using a timer

- 1 Do steps 1 to 4 of "Playing an MD" on page 27.
- 2 Press MENU/NO twice.  
"Setup Menu" appears in the display.
- 3 Turn AMS (or press ◀◀/▶▶ repeatedly) until "Timer" appears in the display; press AMS or YES.
- 4 Turn AMS (or press ◀◀/▶▶ repeatedly) to select "Play"; press AMS or YES.
- 5 Press MENU/NO.
- 6 Set the timer as required.
  - When you have set the time for start of playback, the recorder turns off by timer. When the specified time arrives, the recorder turns on and starts playing.
  - When you have set the time for the end of playback, playback continues. When the specified time arrives, timer turns off and the recorder stops playing.
  - When you have set the time for both the start and end of playback, the recorder turns off by timer. When the starting time arrives, the recorder turns on and starts playing. When the ending time arrives, timer turns off and the recorder stops playing.
- 7 **Selecting play mode (pages 32 and 33)**  
When you only want to listen to certain tracks, create a program as shown on page 33. When playback is to continue to a desired time and then stop, press ▷ and playback begins.

#### Note

Because Multi-access playback is based on single playback, Multi-access play is invalid by using "Timer" function.

#### When finished using a timer for playback

If "TIMER" of the "Setup Menu" is left on "PLAY", playback will automatically begin every time power to the recorder is turned on. When timer playback is not desired, set "TIMER" to "OFF".

### Recording on an MD using a timer

- 1 Do the following steps of "Recording on an MD" on page 19.

To specify the time for	Do
the start of recording	Steps 1 to 5, then press ■
The end of recording	Steps 1 to 10
Both start and end of recording	Steps 1 to 5, then press ■

- 2 Press MENU/NO twice.  
"Setup Menu" appears in the display.
- 3 Turn AMS (or press ◀◀/▶▶ repeatedly) until "Timer" appears in the display; press AMS or YES.
- 4 Turn AMS (or press ◀◀/▶▶ repeatedly) to select "Rec"; press AMS or YES.
- 5 Press MENU/NO.
- 6 Set the timer as required.
  - When you have set the time for start of recording, the recorder turns off by timer. When the specified time arrives, the recorder turns on and starts recording.
  - When you have set the time for the end of recording, recording continues. When the specified time arrives, timer turns off and the recorder stops recording.
  - When you have set the time for both the start and end of recording, the recorder turns off by timer. When the starting time arrives, the recorder turns on and starts recording. When the ending time arrives, timer turns off and the recorder stops recording.

#### When finished using a timer for recording

If "TIMER" of the "Setup Menu" is left on "REC", the recorder will automatically start recording every time power is turned on. When timer recording is not desired, set "TIMER" to "OFF".

#### Be sure that power to the recorder is turned on within one week after recording using a timer .

When the power is turned on, the recorded material is recorded to the MD. If power is not turned on over a period of time, the recorded contents may disappear. When this happens, "Initialize" flashes in the display when power is turned on.

#### Notes

- It may take about 30 seconds after the recorder is turned on until recording starts. When recording at a specified time using the timer, be sure to take this time into account when setting the recording start time.
- During timer recording, new material is recorded from the end of the recorded portion of the MD.
- Material recorded during timer recording will be saved to the disc the next time you turn on the recorder. "TOC Writing" will flash in the display at that time. Do not disconnect the power cord or move the recorder while the indication flashes.
- Timer recording will stop if the disc becomes full.

# Rear Panel Terminal Functions

This chapter provides information on the functions of the control and remote rear panel terminals.

---

## Control terminal functions

### Control terminal (CTRL-S) —Mini-jack type

This recorder allows external control by connecting system controller to the CTRL-S terminal as remote.

#### Control functions

The functions are the same as for the recorder's remote. Also, when a plug is inserted into the CTRL-S terminal, the reception of infrared signals is stopped.

---

## Remote Terminal Functions

### RELAY PLAY/REC —Stereo mini-jack type

With the recorder connected to other recorders, the end of recording or playback on the first unit passes a control signal to the RELAY terminal, so that recording or playback automatically begins in the second unit. By making the connection a loop, continuous playback is also possible.

#### Connection for relay playback or recording

Connection between the first recorder, set to RELAY OUT, and the second recorder, set to RELAY IN, is by a stereo mini-plug cable (RK-G136, etc.).

When more than two recorders are connected, both RELAY OUT and RELAY IN are connected in the same way.

The input and output signals are relayed by the direct connection between the output signal terminal of the first recorder and the input signal terminal of the second recorder. Through this connection, an input signal are relayed to all the other recorders as well; likewise the output signal is relayed through the direct connection with the other recorders.

#### Connection for relay play and recording

Set "RELAY" of "Setup Menu" to "OFF".

To relay the input/output signal in "PLAY" or "REC", the same operating conditions as for input monitor (page 22) are applied, and there are restrictions on operations.

#### Note

Please set the input selector of the recorder front panel in accordance with the connection to the input terminal.

## Cabling for Relay

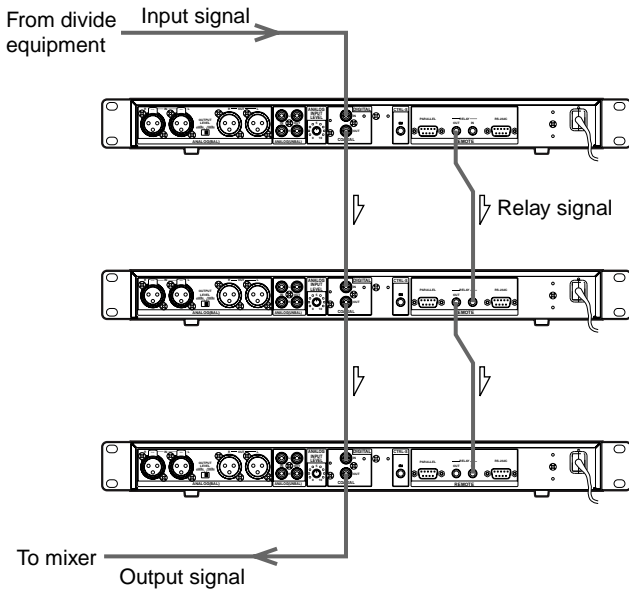

By the connection above, the input and output signals are relayed, but for reasons of the system, the input signal is cut off for about 2 seconds when recording is relay. If you want to perform overlap recording without a blank, connect the input signal as shown below.

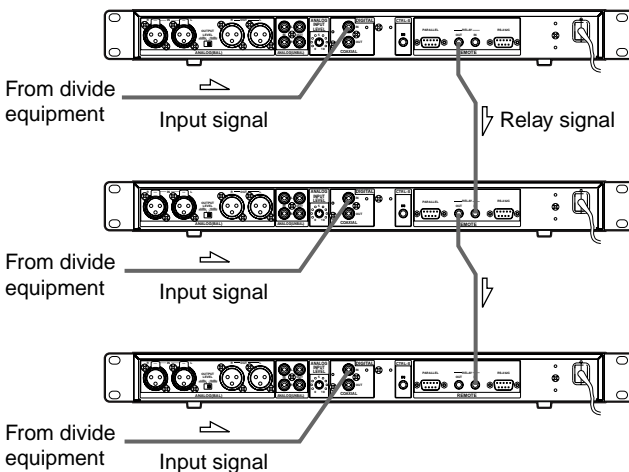

## Relay Playback

Carry out steps 1 to 4 with all recorders connected

- 1 Press MENU/NO twice.  
"Setup Menu" appears in the display.
- 2 Turn AMS (or press ◀◀/▶▶ repeatedly) until "Relay" appears in the display; press AMS or YES.
- 3 Turn AMS (or press ◀◀/▶▶ repeatedly); select "Play" ; press AMS or YES.
- 4 Press MENU/NO.
- 5 Start play on the first unit.
- 6 When the first recorder finishes play, the second recorder begins play.
- 7 Play will continue in the same way for all other recorder if a cable is connected to the RELAY IN terminal.

### Note

For the relay signal to be received and playback to begin in all recorders, the following conditions must be satisfied.

- A disc that is able to play back must be in the recorder.
- The recorder must be stopped.
- The recorders must not be in "Edit Menu" or "Set up Menu".

If REPEAT is set, the control signal is not transmitted and relay playback cannot be made.

## Relay Recording

Carry out steps 1 to 4 with all recorders connected

- 1 Press MENU/NO twice.  
"Setup Menu" appears in the display.
- 2 Turn AMS (or press ◀◀/▶▶ repeatedly) until "Relay" appears in the display; press AMS or YES.
- 3 Turn AMS (or press ◀◀/▶▶ repeatedly); select "Rec" ; press AMS or YES.
- 4 Press MENU/NO.
- 5 Start recording on the first unit.
- 6 When the first recorder finishes recording, the second recorder begins recording.
- 7 Recording will continue in the same way for all other recorders if a cable is connected to the RELAY IN terminal.

### Note

For the relay signal to be received and recording to begin in all recorders, the following conditions must be satisfied.

- A recordable disc must be in the recorder.
- The recorder must be set input selector in accordance with the connection to the input terminal.
- The recorder must be stopped.
- The recorders must not be in "Edit Menu" or "Set up Menu".

Relay recording is always at "New Track Rec."  
In relay recording, it is not possible to record overwrite.



# Parallel Input-Output

## —D-sub 9-pin (female)

When a simple circuit is connected to the parallel in/out terminals, remote control is available.

By connecting input terminal and GND, each function assigned to each terminal can work.

These output terminal are open collector output. The LEDs can be lit on to show the status of the unit.

### Example of input-output terminals circuit

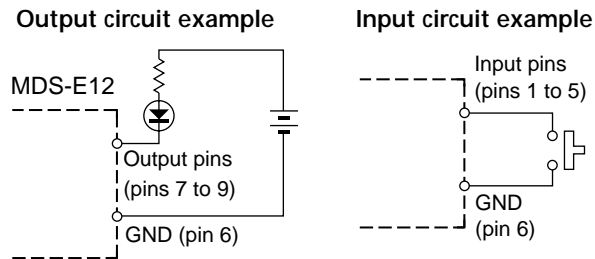

The standard settings (PRESET) or user settings (USER) can be selected by the “Set up Menu.”

The following chart shows input/output of the terminals and functions of the standard setting.

Pin Number	Input-output	Function	Set up Menu names
1	Input	PLAY/PAUSE	PIN1
2	Input	REC	PIN2
3	Input	STOP	PIN3
4	Input	AMS+	PIN4
5	Input	AMS-	PIN5
6	---	GND	
7	Output	REC	POUT1
8	Output	PLAY	POUT2
9	Output	PAUSE	POUT3

The Set up Menu can be used to set user settings, assigning the following functions to PIN1 to PIN5 and POUT 1 to POUT 3. The input/output of each pin is fixed.

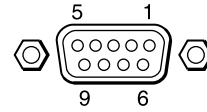

### PIN1 to PIN5 (Input pins)

PLAY	Same function as the remote's PLAY
PAUSE	Same function as the remote's PAUSE
PLAY/PAUSE	Same function as the recorder's PLAY/PAUSE
STOP	Same function as the recorder's STOP
REC	Same function as the recorder's REC
AMS+	Same function as rotation of AMS to the clockwise one click
AMS-	Same function as rotation of AMS to the counterclockwise one click
FF	Same function as the recorder's FF
REW	Same function as the recorder's REW
MARK	Same function as the recorder's MARK
LOCATE	Same function as the recorder's LOCATE
EJECT	Same function as the recorder's EJECT
MUSIC SYNC	Same function as the remote's M. SYNC
T.REC	Same function as the remote's T.REC
Fader PLAY	Same function as the remote's FADER
1-Track PLAY	Same function as the number buttons (1 to 20) of the remote
20-Track PLAY	Same function as the number buttons (1 to 20) of the remote
OFF	No Operation

### POUT1 to POUT3 (Output pins)

REC	Grounded when the recorder's REC indicator lights
PLAY	Grounded when the recorder's ► indicator lights
PAUCE	Grounded when the recorder's ■■ indicator lights
NO DISC	Grounded when the recorder's is turned on and is not inserted disc
EOT	Grounded while EOT messege is on
EOD	Grounded while EOD messege is on
OFF	Constantly floating

## Electrical specifications

### Input terminal

Input system	Make contact
Input on voltage	0.5V or less
Input off voltage	3V or more
Open Terminal voltage	5V
Input pulse width	100msec or more
Input withstand voltage	-0.5 to +10V

### Output terminal

Output system	NPN transistor open collector
On residual voltage	0.5V or less
On maximum inflow current	100mA
Withstand voltage	20V

### Using Fader Play

By connecting the fader of the mixer to the terminal on the recorder which is set as the Fader PLAY of the parallel input, starting play and pause at the beginning of the next track are synchronized to the fader of the mixer.

This can be used in the mixer equipped with fader remote function in which  $-\infty$  position (lowest position) is OFF and the other position are ON.

In the recorder, "AMS+" and "PAUSE" are carried out when the fader is OFF, and "PLAY" is carried out when the fader is ON.

### Notes on Fader PLAY

#### • Operation on the final track number

When you want to continue to use Fader PLAY from the last track number, select the beginning of the track to use recorder manually. AMS+ cannot be used for the last track number, because it is aware that there is no next track number, SO for the final track number, momentarily turn the fader to the OFF position.

#### • To repeat one track

To repeat only one track with Fader PLAY, select the desired track with PROGRAM Mode, and set the REPEAT Mode to "REPEAT ALL". In normal operation, the one-track repeat setting is operated by AMS+, which is the operating standard for making the next track one-track repeat. If the fader is set to OFF, the operation is done by AMS+ and the beginning of the next track will cause the settings to revert to initial settings for the first track, and repeat play will not be made.

## RS-232C

### —D-sub 9-pin (male)

The recorder can be controlled externally through the use of other devices connected through this terminal. For protocols, please consult your dealer.

# Operating the MD Recorder Using a Keyboard

This chapter explains simple ways to name a track or MD using an optional keyboard, as well as how to operate the MD recorder directly through the keyboard.

## Setting the keyboard

You can use any IBM\*-compatible keyboard with a PS/2 interface\*\*. You can select a keyboard with either an English or Japanese key layout. When you use a keyboard with a different layout, you will have to assign characters to the keys. For details, see “Assigning Characters to Keyboard Keys” on page 58.

\* IBM is a trademark of International Business Machines Corporation.

\*\* Note

Some keyboards may not work normally if they draw excessive electrical current. Please use keyboards with a draw of 120mA or less.

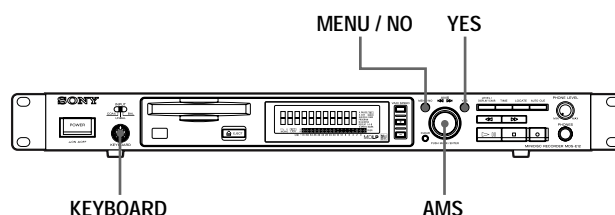

### Connecting a keyboard to the MD recorder

Connect the keyboard to the **KEYBOARD** port on the front panel of the recorder

\* Please turn off the power before connecting the keyboard to the recorder. Connecting the keyboard with the recorder power on can result in malfunctions.

### Selecting keyboard type

The first time you connect a keyboard, you must select the keyboard type.

- 1 While the recorder is stopped, press MENU/NO twice.  
“Setup Menu” appears in the display.
- 2 Turn AMS (or press ◀◀/▶▶ repeatedly) until “Keyboard” appears in the display; press AMS or YES.
- 3 Turn AMS (or press ◀◀/▶▶ repeatedly) until “Type” appears in the display; press AMS or YES.
- 4 Turn AMS (or press ◀◀/▶▶ repeatedly) to select the setting; press AMS or YES.

To use the keyboard with	Select
English keyboard layout	US (factory setting*)
Japanes keyboard layout	JP
10-keyboard layout	10 Key

\* In step 4, pressing CLEAR before AMS or YES will reset the factory settings.

- 5 Press MENU/NO.

# Naming a Track or MD Using the Keyboard

You can easily enter or edit names.

## Short cut to the naming procedure

- 1 To give a name to a track or MD, do the following.
  - To name a track  
Press Num Lock while the desired track number is displayed and the recorder is stopped, playing, paused or recording.
  - To name a MD  
Press Num Lock when no track number is displayed and the recorder is stopped.  
A flashing cursor appears in the display, and the characters can be entered.
- 2 Enter the name  
For more on editing during entry, refer to the chart below.
- 3 Press the Enter key or Num Lock key  
The disc or track name is displayed from its beginning.

## Operations you may wish to do while naming a track or MD

To	Press
Cancel the operation	[Esc]
Switch between uppercase and lowercase letters	[Caps Lock] (or hold down [Shift]* while entering letters for uppercase)
Move the cursor	[←] or [→]
Erase the character at the cursor position	[Delete]
Erase the character preceding the cursor	[Back Space]

\* If you have assigned characters to keys using [Shift] (see page 62), the characters you assigned have priority.

- 🔄 Undoing the naming of a track or MD
- 1 Press [F11]  
"Name Undo?" appears.
  - 2 Press [Enter].  
Press [Esc] to cancel the operation.

## Using the Edit Menu

- 1 Do the following to name a track or MD.
  - To name a track or MD  
Press [Esc] while the recorder is stopped, playing or paused.
  - To name a track during recording.  
Press [Esc] during recording.  
"Edit Menu" appears in the display.
- 2 Press [↑]/[↓] or [Tab]/[Shift]+[Tab] repeatedly until "Name?" appears, then press [Enter].  
While the recorder is recording, a flashing cursor appears in the display, and you can enter a name for the track being recorded. In this case, please go to step 5.
- 3 Press [↑]/[↓] or [Tab]/[Shift]+[Tab] repeatedly until "Nm In?" appears, then press [Enter].
- 4 Press [↑]/[↓] or [Tab]/[Shift]+[Tab] repeatedly until the track number (when naming a track) appears or "Disc" (when naming the MD) flashes, then press [Enter].  
Characters can be entered.
- 5 Enter the name.
- 6 Press [Enter] or [Num Lock].  
"Complete!" appears for a few seconds, and the naming is completed.

# Operating the Recorder Through the Keyboard

You can operate the MD recorder by using the keyboard keys. This allows you to control the recorder and edit MDs without using the recorder buttons and controls or the remote.

For more detail on the functions below, see “Front Panel Descriptions” on pages 6 or “Remote Description” on pages 8 and 9.

## Operations using the US or JP keyboards

Button or function	Key
MENU/NO	[Esc]
AMS or ►►	[↑] or [Tab]
AMS or ◀◀	[↓] or [Shift]+[Tab]
▷/   or YES	[Enter]*
REC ●	[Shift]+[Enter]
MUSIC SYNC	[Ctrl]+[Enter]
■	[Space]
◀◀	[←]
►►	[→]
VARI SPEED	[F1]
VARI SPEED+	[Page Up]
VARI SPEED-	[Page Down]
MARK	[Insert]
LOCATE	[Home]
TIME	[F3]
PLAY MODE	[F5]
SCROLL	[F6]
LEVEL/DISPLAY/CHAR (DISPLAY)	[F7]
Selecting track numbers over 11**	[F9]
FADER	[F10]
Undoing the last editing (see page 50)	[F11]
EJECT	[F12]
REPEAT	[Print Screen]
A↔B	[Scroll Lock]
M.SCAN	[Pause]
CLEAR	[Delete]
Name track or MD	[Num Lock] (see page 60)
Divide track	[/]
Move track	[*]
Erase track	[-]
Combine tracks	[+]

Button or function	Key
Play track number 1	[1]
Play track number 2	[2]
Play track number 3	[3]
Play track number 4	[4]
Play track number 5	[5]
Play track number 6	[6]
Play track number 7	[7]
Play track number 8	[8]
Play track number 9	[9]
Play track number 10	[0]

\* In Edit Menu and Setup Menu, [Enter] operates as YES, in other cases as ▷/||.

\*\* For example, press [F9], then [2] and [0] for track number 20, or press [F9] twice, then [1], [0] and [3] for track number 103.

## Note

When a track has not been selected and [/], [\*], [+] are pressed, “Cannot Edit” will appear on the display.

## Operations using the 10-key pad

Button or function	Key
AMS PUSH (MARK/ENTER)	[Num Lock]
MENU/NO	[/]
YES	[“]
AMS (◀◀)	[-]
AMS (►►)	[+]
Play track number 1	[1]
Play track number 2	[2]
Play track number 3	[3]
Play track number 4	[4]
Play track number 5	[5]
Play track number 6	[6]
Play track number 7	[7]
Play track number 8	[8]
Play track number 9	[9]
Play track number 10	[0]

# Assigning Characters to Keyboard Keys

## Assigning a character

If your keyboard layout is not that of an English or Japanese keyboard, the display may show the wrong characters, or no characters at all, when you press the keys. In this case, you must assign characters to the keys.

- 1 While the recorder is stopped, press [Esc] twice. "Setup Menu" appears in the display.
- 2 Press [↑]/[↓] or [Tab]/[Shift]+[Tab] repeatedly until "Keyboard?" appears; press [Enter].
- 3 Press [↑]/[↓] or [Tab]/[Shift]+[Tab] repeatedly until "Assign?" appears; press [Enter].
- 4 Press [↑]/[↓] or [Tab]/[Shift]+[Tab] repeatedly until the character you want to assign appears. If the character has already been assigned, "User" appears. If it has not been assigned, "Default" appears.
- 5 Press [Enter]. "<Set Key>" flashes in the display.
- 6 Press the key to be assigned on the keyboard. "Key change" appears, and the selected character is assigned to the key.

### If "Same Key" appears

The same character is already assigned to the key.

### If "Remove old assign?" appears

A different character is already assigned to the key.

Press [Enter] to clear the current assignment and assign the new character. Press [Esc] to cancel.

## Notes

- You can assign a character with [Shift] only for symbol and number keys.
- You can't assign a character to the following keys: [Esc], [F1]-[F12], [Back Space], [Tab], [Caps Lock], [Enter], [Shift], [Ctrl], [Alt], [Windows], [Space], [Application], [Print Screen], [Scroll Lock], [Pause], [Insert], [Delete], [Home], [End], [Page Up], [Page Down], [Num Lock], [←], [→], [↑], [↓], and, on the 10-key, [/], [\*], [-], [+].  
Depending on the keyboard, some keys other than those above may also not be able to be assigned.

## Clearing key assignments

Key assignments can be cleared one at a time, or all at once.

### To clear a key assignment

- 1 Do steps 1 to 3 of "Assigning a character" on this page.
- 2 Press [↑]/[↓] or [Tab]/[Shift]+[Tab] repeatedly the character you want to clear appears; press [Enter]. "<Set Key>" flashes in the display.
- 3 Press [Delete].  
"Key Clear" appears and the key assignment is cleared.

### To clear all key assignments

- 1 Do steps 1 to 3 of "Assigning a character" on this page.
- 2 Press [Ctrl], [Alt] and [Delete] simultaneously. "All Reset?" appears in the display.
- 3 Press [Enter].  
"Complete!" appears, and all assignments are cleared.

### To cancel the operation

Press [Esc].

# Keyboard Operations (English Keyboard Layout)

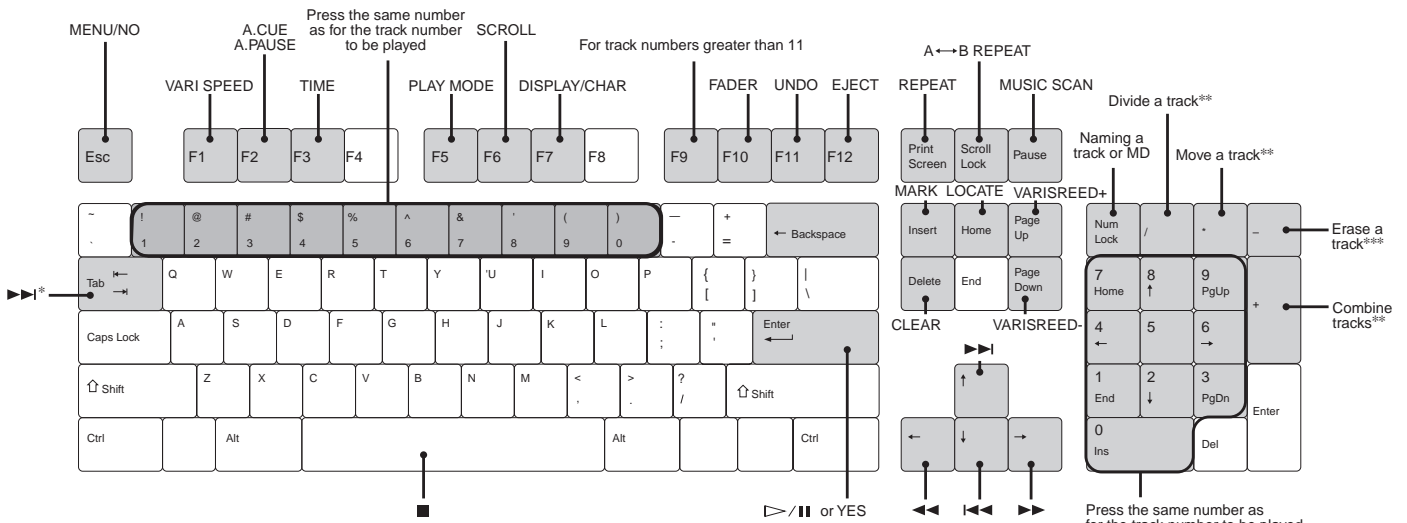

- \* I◀◀: [Shift] + [Tab]
- Rec●: [Shift]+[Enter]
- MUSIC SYNC: [Ctrl]+[Enter]
- \*\* Effective only during track playback (or while choosing a track)
- \*\*\* All tracks are erased at once when stopped.
- While track is playing back (or during track selection), tracks are erased one by one.

# Keyboard Operations (10-Keyboard Layout)

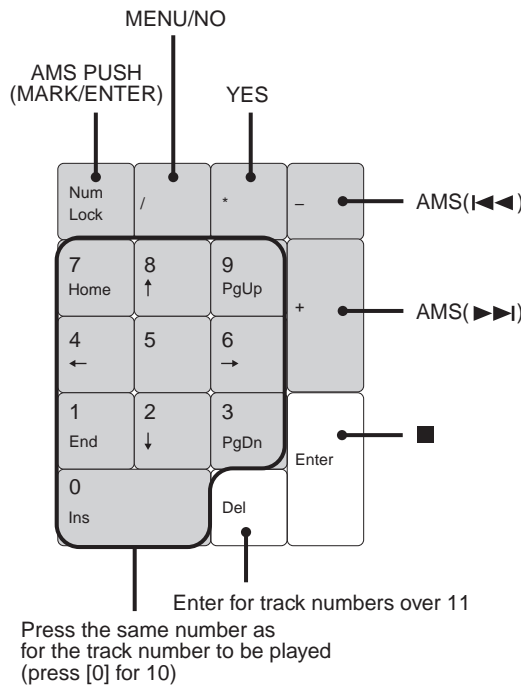

# Additional Information

This chapter provides additional information that will help you understand and maintain your MD recorder.

---

## System Limitations

The recording system of your MD or Mini-disc recorder is radically different from those use din cassette and DAT recorders, and is characterized by the limitations described below. Note, however, that these limitations are due to the inherent nature of the MD recording system itself, and not to mechanical causes.

### **“Disc Full” appears in the display even before the MD has reached the maximum recording time**

When too many tracks have been recorded in the MD, “Disc Full” appears regardless of the total recorded time. More than 256 tracks cannot be recorded on the MD. To continue recording, erase unnecessary tracks or use a second recordable MD.

### **“Disc Full” appears before the maximum number of tracks or the maximum recording time has been reached**

Fluctuations in emphasis within tracks are sometimes interpreted as track intervals, increasing the track count and causing “Disc Full” to appear.

### **The remaining recording time does not increase even after erasing a number of short tracks**

Tracks under 12 seconds\* in length (in stereo mode) are not counted, so erasing them may not lead to an increase in recording time.

\* In stereo recording mode. For monaural and LP2 stereo the length is 24 seconds, for LP4 stereo it is 48 seconds.

### **The total recorded time and the remaining recordable time on the MD may not total the maximum recording time**

Recording is in minimum units of 2 seconds\* each (in stereo mode), no matter how short the material. The contents recorded may therefore be shorter than the maximum recording capacity. Disc space may be further reduced by scratches on the disc, which are automatically deleted, further reducing time.

\* In stereo recording mode. For monaural and LP2 stereo the length is 4 seconds, for LP4 stereo it is 8 seconds.

### **Limitations when recording over an existing track**

- The correct remaining recordable time on the MD may not be displayed.
- You may find it impossible to record over a track if that track has already been recorded over several times. If this happens, erase the track.
- The remaining recording time may be shortened out of proportion to the total recorded time.
- Recording over a track to eliminate noise is not recommended since this may shorten the duration of the track.
- You may find it impossible to name a track while recording over an existing track.



Tracks created by editing may exhibit sound dropouts as you're searching for a point while monitoring the sound.

**Some tracks cannot be combined with others**  
Tracks may not be combined if they have been edited.

**Track numbers are not marked correctly**  
Incorrect assignment or marking of track numbers may result when CD tracks are divided into several smaller tracks during digital recording. Depending on the material recorded, when "Track Mark" of the Setup Menu was set to "Level Sync" and the track number automatically assigned during recording, the track number may not have been accurately assigned.

**"TOC Reading" appears for a long time**  
If the inserted recordable MD is brand new, "TOC Reading" will appear in the display for a longer period than for already-used MDs.

**The correct recorded/playing time may not be displayed during playback of MDs recorded in monaural mode.**

### Guide to the Serial Copy Management System

Digital audio components, such as CDs, MDs, and DATs, make it easy to produce high-quality copies of music by processing music as a digital signal. To protect copyrighted music sources, this recorder uses the Serial Copy Management System, which allows you to make only a single copy of a digitally recorded source through digital-to-digital connections.

**You can make only a first-generation copy<sup>1)</sup> through a digital-to-digital connection.**

Examples are as follows:

- You can make a copy of a commercially available digital sound program (for example, a CD or MD), but you cannot make a second copy from the first-generation copy.
- You can make a copy of a digital signal from a digitally recorded analog sound program (for example, an analog record or a music cassette tape) or from a digital satellite broadcast program, but you cannot make a second copy from the first-generation copy.

1) A first-generation copy means the first recording of a digital audio source through the recorder's digital input connector. For example, if you record from a CD player connected to the DIGITAL IN connector, that copy is a first-generation copy.

#### Notes

The restrictions of the Serial Copy Management System do not apply when you make a recording through the analog-to-analog connections.

## Trouble shooting

Should you have trouble with your MD recorder, first unplug the unit, then plug it back in and check it while using this troubleshooting guide. Should the problem persist, consult your nearest Sony dealer.

**The recorder does not operate or operates poorly**  
➔ The MD may be dirty or damaged. Replace the MD.

**The recorder does not play**  
➔ Moisture has formed inside the recorder/ Take the MD out and leave the recorder in a warm place for several hours until the moisture evaporates.  
➔ Be sure that the power is on.  
➔ The recorder may not be correctly connected to the amplifier. Check the connection.  
➔ The MD is inserted in the wrong direction. Slide the MD into the disc slot with the label side up and the arrow pointing toward the slot.  
➔ The MD may not be recorded. Replace the disc with one that has been recorded.

**The sound has a lot of static**  
➔ Move the recorder away from sources of strong magnetism, such as televisions.

**The recorder does not record**  
➔ The MD is record-protected. Slide the record-protect tab to close the slot.  
➔ The recorder is not connected properly to the program source. Check the connection.  
➔ Select the correct program source using INPUT.  
➔ The recording level is not adjusted properly. Adjust the recording level.  
➔ A premastered MD is inserted. Replace it with a recordable MD.  
➔ There is not enough time left on the MD. Replace it with another recordable MD with fewer recorded tracks, or erase unnecessary tracks.  
➔ There has been a power failure, or the AC power cord has been disconnected during recording. Data recorded to that point may be lost. Repeat the recording procedure.

**The recorder does not perform synchro recording with a CD player**  
➔ The remote supplied with the MD recorder is not set correctly. Reset the remote.

**The keyboard does not operate**  
➔ Disconnect the keyboard, turn off power to the recorder, and reconnect the keyboard.

**The recorder begins playback or recording when the power is turned on**  
➔ "Timer" of the Setup Menu is set to "Play" or "Rec." Set "Timer" to "Off."

**Although neither play or recording are set, there is still output from the recorder**  
➔ "Relay" of the Setup Menu is set to "Play" or "Rec." Set "Relay" to "Off".

When the suggested measures above do not solve the problem, remove the power plug, then plug it back in again.

## Self-Diagnosis Function

The recorder's self-diagnosis function automatically checks the condition of the MD recorder when an error occurs, displays message. Refer to the table below to perform the indicated countermeasure. If after two or three attempts the problem persists, consult your nearest Sony dealer.

Message (code)	Cause/Remedy
Protected	The inserted MD is record-protected. ➔ Take out the MD and close the record-protect slot (page 19)
Cannot copy (C12)	The external CD-ROM or video CD player is playing back a disk in a format that cannot be played back. ➔ Remove the disk and insert a playable music CD
Cannot copy (C41)	The sound source is a copy of a commercial music software, or a CD-R recorded CD. ➔ Because of the serial copy management system, the copy cannot be made (see page 65). Copies also cannot be made from CD-Rs.
REC Error	the recording was not made properly. ➔ Set the recorder on a stable surface, and repeat the recording procedure. The inserted MD is dirty (smudges, fingerprints, etc.), scratched or substandard in quality. ➔ Replace the MD and repeat the recording procedure.
Read Error	The recorder could not read the information on the MD properly. ➔ Eject the MD and insert it again.
TOC Error	The recorder could not read the information on the MD properly. ➔ Insert another MD. ➔ If possible, erase all the tracks on the MD (page 42).

Message (code)	Cause/Remedy
Din Unlock	The sporadic appearance of this message is caused by the digital signal being recorded. This will not affect the recording. While recording from a digital source, the connection cable was unplugged or the digital source was turned off. ➔ Reconnect the cable, or turn the digital component's power back on.
MEMORY NG	A problem occurred with the internal information needed to actuate the recorder. ➔ Consult your nearest Sony dealer.
LASER NG	A problem has occurred with the laser pickup. ➔ There is the possibility that a malfunction has occurred. Consult your nearest Sony dealer.

## Display Messages

The following table explains the various messages that appear in the display. Please also see the recorder's Self Diagnosis function on page 66.

Message	Meaning
Auto Cut	The Auto Cut function is on (page 22)
Blank Disc	A new (blank) or erased MD has been inserted.
Cannot Copy	An attempt was made to make a second copy from a digitally dubbed MD.
Cannot Edit	The MD is a commercially recorded disc and cannot be edited. An attempt was made to edit the MD during Program or Shuffle Play. An attempt was made to edit an MD recorded in LP2 or LP4 stereo.
Disc Full	The MD is full
Impossible	The recorder cannot do the specified operation.
Incomplete!	The change of recording level or Fade-In Fade-Out operations were not properly made due to the recorder being moved, damage to the disc, dirt, etc.
Initialize (flashing)	The Setup Menu settings have been lost. Or the contents recorded by the timer have disappeared over time and are not available for saving to disc, or the playback condition was not stored the last time the recorder was used. (When the power is turned on, this flashes for about four seconds).
Memorizing (flashing)	This flashes while the memory is storing the contents of editing using Multi-access play to edit the track order.
Name Full!	The limitation on the number of characters that can be input for naming has been reached. A maximum of approximately 1,700 characters can be input.
No Change	While changing recording levels, AMS or YES were pushed without the level change being made, so that no changes were recorded.
No Disc	There is no MD in the recorder.
No Name	The track or disc has no name.
No Program!	An attempt was made to start Program Play when no program exists.
Premastered	An attempt was made to record on a premastered MD.
ProgramFull	The program contains the maximum number of tracks, and no more can be added.
REMOTE	The recorder is being controlled by a

connected external device.\*

Message	Meaning
S.F Edit!	During S.F Edit (change of sound level after recording, Fade-In, Fade-Out), another operation was made. During S.F Edit, no other operations can be made.
Smart Space	The Smart Space function is on (page 22).
TOC Reading	After the insertion of the MD, the recorder is reading the recorded material.
M. Access	The button for an operation which cannot be made during Multi-access play was pressed.
No Date	DATE-RECORDED of the remote was pressed with a track without the time and date recorded present.

\* If "REMOTE" appears under other circumstances, turn the recorder off, then turn it on again.

# Specifications

System	Mini-disc digital audio system
Disc	Mini-disc
Laser	Semiconductor laser ( $\lambda=780\text{nm}$ )
Laser output	Emission duration: continuous MAX 44.6 $\mu\text{W}^{1)}$ 1) This output is the value measured at a distance of 200 mm from the objective lens surface on the Optical Pick-up Block with 7 mm aperture.
Laser diode	Material: GaAlAs
Revolutions	400 rpm to 900 rpm (CLV)
Error correction	ACIRC (Advanced Cross Interleave Reed Solomon Code)
Sampling frequency	44.1 kHz
Coding	ATrac (Adaptive Transform Acoustic Coding)/ATrac 3
Modulation system	EFM (Eight-to-Fourteen Modulation)
Number of channels	Two stereo channels
Frequency response	5 to 20,000 Hz $\pm 0.3\text{dB}$
Signal-to-noise ratio	Over 98dB during playback
Wow and flutter	Below measurable limit

## Input Terminals

Terminal name	Terminal type	Input impedance	Reference input level	Maximum input level
Analog IN (BAL)	XLR-3-31 equivalent	30k $\Omega$	+4dBu	+24dBu
Analog IN (UNBAL)	Pin jack	47k $\Omega$	-4dBu	+12dBu
Digital IN (COAXIAL)	Pin jack	75 $\Omega$	0.5 Vp-p $\pm 20\%$	—

## Output Terminals

Terminal name	Terminal type	Reference output level	Load impedance
Analog OUT (BAL)	XLR-3-32 equivalent	Maximum +24/+10dBu (level change-over)	Greater than 600 $\Omega$
PHONES	Standard stereo jack	0 to 10mW (level variable)	32 $\Omega$
Analog OUT (UNBAL)	Pin jack	Maximum + 8dBu	Greater than 10k $\Omega$
Digital OUT (COAXIAL)	Pin jack	0.5 Vp-p (at 75 $\Omega$ )	75 $\Omega$

0dBu=0.775Vrms

## General

### Power requirements

Where purchased	Power requirements
USA and Canada	120V AC, 60 Hz
Other countries	120V or 230V AC Selectable, 50/60 Hz

Power consumption

18W

Dimensions (approx.)

482 x 44 x 290 mm  
(19 x 1 $\frac{3}{4}$  x 11 $\frac{3}{8}$  in)  
(w/h/d, including projecting parts)

MASS (approx.)

3.5 kg (7 lbs. 12 oz.)

Operating temperature

0 °C to +40 °C

Storage temperature:

-5 °C to +60 °C

### Accessories

See page 14

US and foreign patents licensed from Dolby Laboratories.

Design and specifications are subject to change without notice.

## Exterior dimensions

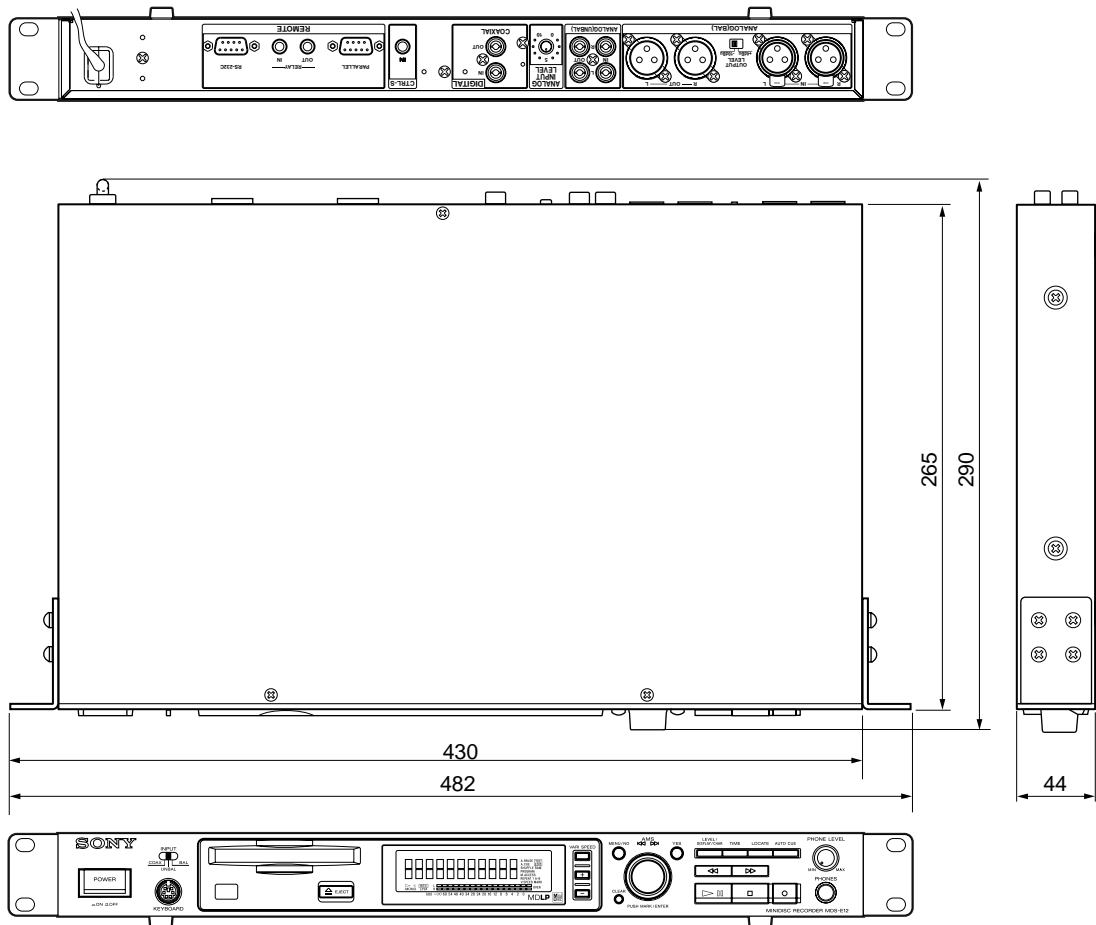

Units: mm

### Rack mounting

This recorder can be rack mounted on a standard EIA 19-inch rack. After removing the four feet, the unit can be mounted in a rack.

To remove the four feet attached to the bottom of the recorder, use a pair of tweezers or similar tool to remove the plastic pin set at the center of each foot. The feet can be detached after the pin has been removed.

# Setup Menu Table

The following table provides an overview of the various Setup Menu items, including their parameters, factory setting, and reference page (s) in the manual.

## To access the Setup Menu

Press MENU/NO twice with the recorder stopped; "Startup Menu" appears in the display.

(Note : The menu items available when MENU/NO is pressed may vary according to the current status of the recorder.)

Menu item	Function	Parameters	Factory setting	Page(s)
Program?	Creates a program	—	—	33
M. Access?	Creates a program	—	—	34
Play Mode	Selects Play Mode	Continue	Continue	27
		Shuffle		32
		Program		33
		M. Access		34
Repeat Mode	Selects repeat mode	Repeat Off	Off	31
		Repeat All		31
		Repeat 1		31
		A-B Repeat		32
A. Cue Level	Sets the level for detecting the start of track	-72 to -48dB	-72dB	38
A Cue Offset	Adjusts the position of the start of auto-cue	±1 sec.	0	38
Music Scan	Adjusts playback time of music scan	6 to 20 sec.	6 sec.	29
Mark Rehear	Adjusts position of mark	—	—	37
Direct Mark	Mark position time is directly input	—	—	36
Output Level	Adjusts analog signal output level	-20.2 to 0 dB	0dB	28
Input Level Coax	Adjusts the level of the input from the COAXIAL terminal	-∞ to +18dB	0dB	21
Input Level BAL	Adjusts the level of the input from the BALANCE terminal	-∞ to +12dB	0dB	21
BAL In L/R	Adjust difference between left and right output of BALANCE signal	—	0dB	21
Input Level UNBAL	Adjusts the level of the input from the UNBALANCE terminal	-∞ to +12dB	0dB	21
UNBAL In L/R	Adjust difference between left and right output of UNBALANCE signal	—	0dB	21
Rec Mode	Selects recording mode	Stereo	Stereo	20
		Mono		20
		Long 2		20
		Long 4		20
Smart Space	Sets Smart Space and auto-cut	On/Off	On	22
Track Mark	Sets track marking method	Level Sync	Level/Sync	23
		Off		23
		Interval		23
Tr Mark Level	Sets base level for auto track marking	-72 to -48dB	-72dB	23
Interval	Sets constant time interval of auto-track marking	1 to 10 min.	1 min.	23
A. Calendar	Automatically writes time to name during recording	On/Off	Off	48
Peak Hold	Indicates the highest level of the input signal	On/Off	Off	21
End Of Tr/Disc	Indicates time to end of track in playback, end of disc in recording	On/Off	Off	53
EOT (Play)	Sets time of indication of end of track in playback	6 to 20 sec.	6 sec.	53
EOD (REC)	Sets time of indication of end of disc in recording	3 to 10 min.	3 min.	53
Resume Mode	Turns off resume mode.	Resume Off	Resume Off	36
	Play starts position of previous stop.	Resume Play		36
	Play starts next track of previous stop.	Resume next		36
Timer	Turns off timer function.	Off	Off	54
	Starts playback when power is turned on.	Play		54
	Starts recording when power is turned on.	Rec		54

Menu item	Function	Parameters	Factory setting	Page(s)
Relay	Turns relay function off	Off	Off	56
	Sets relay playback function	Play		56
	Sets relay record function	Rec		56
Play/Pause ▲	Enables eject during playback	Enable	Enable	28
	Disables eject during playback	Disable		28
Next Tr Play	Reserve the next track during play.	On/Off	Off	30
Date Time	Sets display of date	YYYY MM DD	YYYY MM DD	17
		MM DD YYYY		17
		DD MM YYYY		17
Parallel	Sets and confirms assignment of parallel input-output terminal	Mode User	—	57
		Mode Preset	—	57
Keyboard	Selects the type of keyboard	Type US	US	59
		JP		59
		10-Key		59
	Assigns characters to keyboard	Assign?	—	62
Calendar	Sets clock and date	—	—	17

## Edit Menu Table

The following table provides a quick guide to the various editing functions that can be performed.

### To access the Edit Menu

Press MENU/NO to display "Edit Menu"

(Note : The available menu items may vary depending on the current status of the recorder.)

Menu item	Sub item	Function	Reference page
Name?	Nm In?	Names track or MD	46
	Nm Erase?	Erases name	49
	Nm AllErs?	Erases all names	49
	Nm Copy?	Copies name	48
	Nm AllCopy?	Gives the same name to all tracks	48
Tr Erase?	—	Erases a track	41
Move?	—	Moves a track	44
Combine?	—	Combines tracks	43
Divide?	—	Divides a track	45
A-B Erase?	—	Erases a portion of a track	42
All Erase?	—	Erases all the tracks on an MD	42
M-Tr Erase?	—	Erases consecutive tracks at one time	42
M-Tr Combin?	—	Combines consecutive tracks at one time	43
S. F Edit?	Tr Level?	Changes the overall recorded level after recording	50
	Fade In?	Records over a track using Fade-in Recording	51
	Fade Out?	Records over a track using Fade-out Recording	51
Undo?	—	Undoes the last edit operation	50
Setup?	—	Enters Setup Menu	—

## Last Mode Memory

This function remembers the last mode of the recorder after power was turned off. When the power is turned on again, playback begins under the same conditions.

However, when the MD is ejected, the following functions are not applied.

- Setting of Program track numbers and track order
- Setting of Multi-access track numbers and track order
- Setting of Variable Speed Play
- MARK point
- RAM edit contents

\* Functions of the Setup Menu such as level, ON/OFF, time, etc., will remain.

