

MiniDisc Recorder

Operating Instructions



MDS-E11

WARNING

Notice for the Customers in the United Kingdom

IMPORTANT

The wires in this mains lead are coloured in accordance with the following code:

Blue : Neutral
Brown : Live

As the colours of the wires in the mains lead of this apparatus may not correspond with the coloured markings identifying the terminals in your plug, proceed as follows:

The wire which is coloured blue must be connected to the terminal which is marked with the letter N or coloured black.

The wire which is coloured brown must be connected to the terminal which is marked with the letter L or coloured red. Do not connect either wire to the earth terminal in the plug which is marked by the letter E or by the safety earth symbol \perp or coloured green or green-and-yellow.

To prevent fire or shock hazard, do not expose the unit to rain or moisture.

To avoid electrical shock, do not open the cabinet. Refer servicing to qualified personnel only.

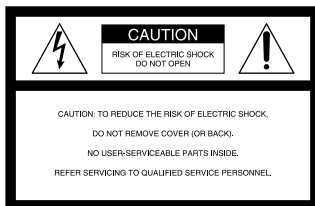

This symbol is intended to alert the user to the presence of uninsulated "dangerous voltage" within the product's enclosure that may be of sufficient magnitude to constitute a risk of electric shock to persons.



This symbol is intended to alert the user to the presence of important operating and maintenance (servicing) instructions in the literature accompanying the appliance.

* The location of the marking is at the rear of the enclosure.

INFORMATION

This equipment has been tested and found to comply with the limits for a Class A digital device, pursuant to Part 15 of the FCC Rules. These limits are designed to provide reasonable protection against harmful interference in a residential installation. This equipment generates, uses, and can radiate radio frequency energy and, if not installed and used in accordance with the instructions, may cause harmful interference to radio communications.

However, there is no guarantee that interference will not occur in a particular installation. If this equipment does cause harmful interference to radio or television reception, which can be determined by turning the equipment off and on, the user is encouraged to try to correct the interference by one or more of the following measures:

- Reorient or relocate the receiving antenna.
- Increase the separation between the equipment and receiver.
- Connect the equipment into an outlet on a circuit different from that to which the receiver is connected.
- Consult the dealer or an experienced radio / TV technician for help.

Precautions

On safety (Refer to the supplied "WARNING".)

Should any solid object or liquid fall into the cabinet, unplug the recorder and have it checked by qualified personnel before operating it any further.

On power sources

- Before operating the recorder, check that the operating voltage of the recorder is identical with your local power supply. The operating voltage is indicated on the nameplate at the rear of the recorder.
- If you are not going to use the recorder for a long time, be sure to disconnect the recorder from the wall outlet. To disconnect the AC power cord, grasp the plug itself; never pull the cord.
- AC power cord must be changed only at the qualified service shop.

On operation

If the recorder is brought directly from a cold to a warm location, or is placed in a very damp room, moisture may condense on the lenses inside the recorder. Should this occur, the recorder may not operate properly. In this case, remove the MD and leave the recorder turned on for about an hour until the moisture evaporates.

On the MiniDisc cartridge

- Do not open the shutter to expose the MD.
- Do not place the cartridge where it will be subject to extremes of sunlight, temperature, moisture or dust.

On cleaning

Clean the cabinet, panel and controls with a soft cloth slightly moistened with a mild detergent solution. Do not use any type of abrasive pad, scouring powder or solvent such as alcohol or benzene.

If you have any questions or problems concerning your recorder, please consult your nearest Sony dealer.

Welcome!

Thank you for purchasing the Sony MiniDisc Recorder. Before operating the recorder, please read this manual thoroughly and retain it for future reference.

About This Manual

Conventions

- Controls in the instructions are those on the recorder; these may, however, be substituted by controls on the remote that are similarly named or, when different, appear in the instructions within brackets.
- The following icons are used in this manual:



Indicates a procedure that requires use of the remote.



Indicates tips for making the task easier and hints.

TABLE OF CONTENTS

Getting Started

Unpacking	4
Connection	4

Basic Operations

Recording on an MD	6
Playing an MD	8

Recording on MDs

Notes on Recording	9
Useful Tips for Recording	9
Recording Over Existing Tracks	11
Adjusting the Recording Level	11
Marking Track Numbers While Recording (Track Marking)	12
Starting Recording With 6 Seconds of Prestored Audio Data (Time Machine Recording)	12
Synchro-Recording With Audio Equipment of Your Choice	13
Synchro-Recording With a Sony CD Player	14
Recording Using a Timer	15

Playing MDs

Using the Display	16
Locating a Specific Track	17
Locating a Particular Point in a Track	18
Playing Tracks Repeatedly	18
Playing Tracks in Random Order (Shuffle Play)	19
Creating Your Own Program (Program Play)	20
Useful Tips When Recording From MDS to Tape	21
Playing Using a Timer	22

Editing Recorded MDs

Notes on Editing	22
Erasing Recordings (Erase Function)	22
Dividing Recorded Tracks (Divide Function)	24
Combining Recorded Tracks (Combine Function)	25
Moving Recorded Tracks (Move Function)	26
Labeling Recordings (Title Function)	26
Undoing the Last Edit (Undo Function)	29

Additional Information

Function of Control Terminal	29
Dimensions	30
Functions of REMOTE Terminals	31
Display Messages	34
System Limitations	34
Troubleshooting	35
Specifications	36
Index of Parts and Controls	37
Guide to the Serial Copy Management System	38

Unpacking

Check that you received the following items:

- Remote commander (remote) RM-D7M (1)
- R6 (size AA) batteries (2)

Inserting batteries into the remote

You can control the recorder using the supplied remote.

Insert two R6 (size AA) batteries by matching the + and - on the batteries. When using the remote, point it at the remote sensor  on the recorder.

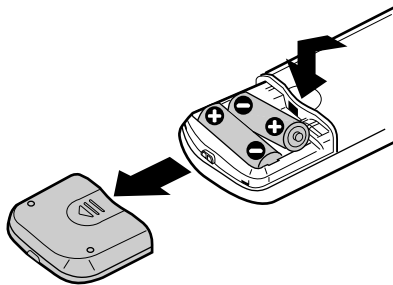

When to replace batteries

With normal use, the batteries should last for about six months. When the remote no longer operates the recorder, replace all the batteries with new ones.

Notes

- Do not leave the remote near an extremely hot or humid place.
- Do not drop any foreign object into the remote casing, particularly when replacing the batteries.
- Do not expose the remote sensor to direct sunlight or lighting apparatuses. Doing so may cause a malfunction.
- If you don't use the remote for an extended period of time, remove the batteries to avoid possible damage from battery leakage and corrosion.

Connection

Overview

This section describes how to hook up the MD recorder to other components such as a mixer, CD player or DAT recorder. Be sure to turn off the power of each component before connection.

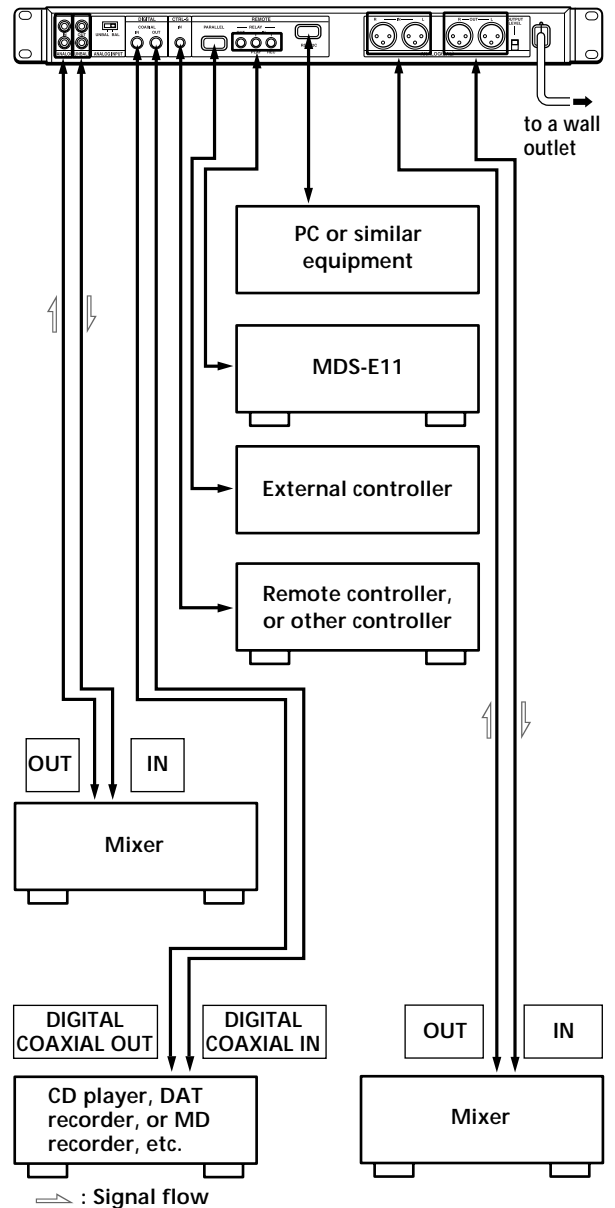

What cords will I need?

- Audio connecting cords (pin type)

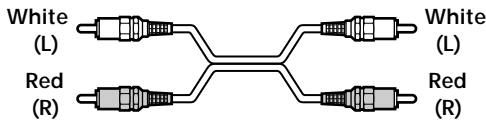

- Audio connecting cords (XLR type)

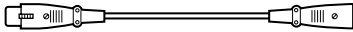

- Coaxial digital connecting cable

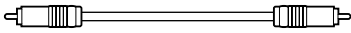

- Control-S cord (mini-jack type)

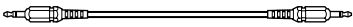

- Relay recording/playback cord (such as RK-G136)
(stereo mini-jack type) (stereo mini-jack type)



Connection

- Connecting the recorder to an analog device
Use the terminals and switches shown below.

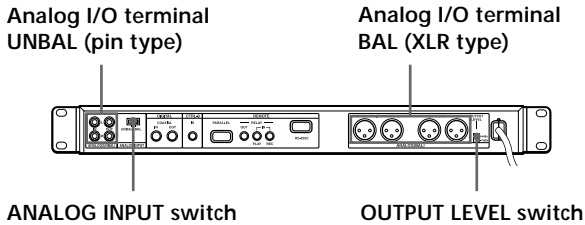

Switch the rear-panel ANALOG INPUT according to the type of the input terminal used.

To record through	Set INPUT to
UNBAL IN (pin type)	UNBAL
BAL IN (XLR type)	BAL

- 💡 Regardless of the setting of the ANALOG INPUT switch, signals are transferred to both the UNBAL and BAL output terminals.
- 💡 If you use the BALANCE output terminal (XLR type), you can use the OUTPUT LEVEL switch to switch the output level.

Switch setting	Output level
+4dBu	Signals having a metered level of -20 dB are generated at a +4 dBu level.
-10dBu	Signals having a metered level of -20 dB are generated at a -10 dBu level.

The BALANCE I/O connector specifications are as follows:

Input terminal XLR-3-31 equivalent

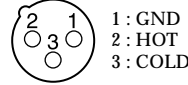

1: GND
2: HOT
3: COLD

Output terminal XLR-3-32 equivalent

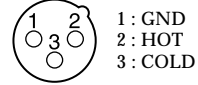

1: GND
2: HOT
3: COLD

- Connecting the recorder to a digital component such as a CD player, DAT recorder, another MD recorder, or mixer
Connect the component through the DIGITAL IN/OUT connectors with two coaxial digital connecting cables.

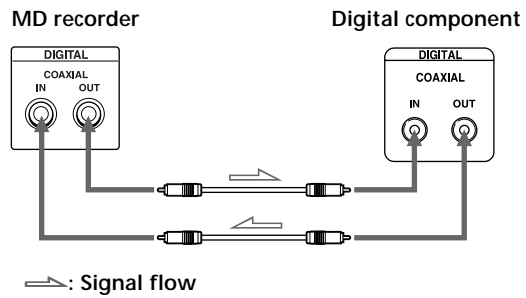

- 💡 **Automatic conversion of digital sampling rates during recording**

A built-in sampling rate converter automatically converts the sampling frequency of various digital sources to the 44.1 kHz sampling rate of your MD recorder.

This allows you to record sources such as 32 and 48 kHz DAT or satellite broadcasts, as well as compact discs and other MDs.

Connecting the AC power cord

Connect the AC power cord to a wall outlet.

Recording on an MD

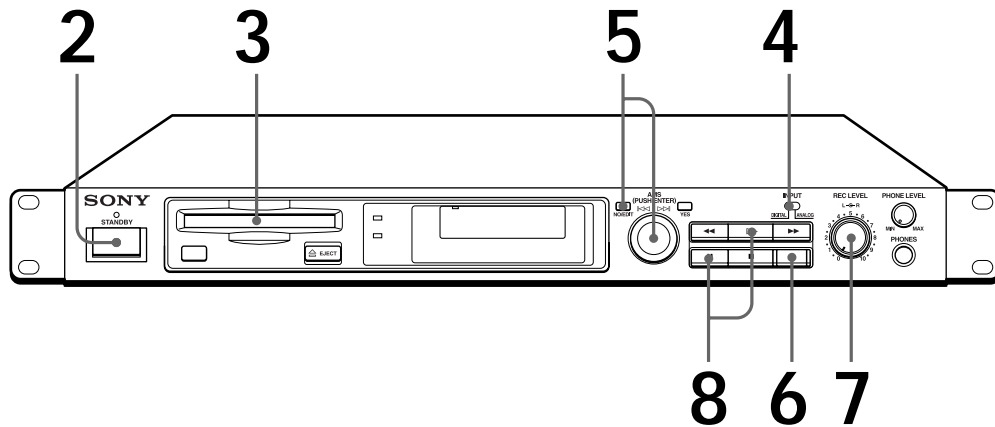

1 Turn on the mixer and program source.

2 Press ①.

3 Insert a recordable MD.

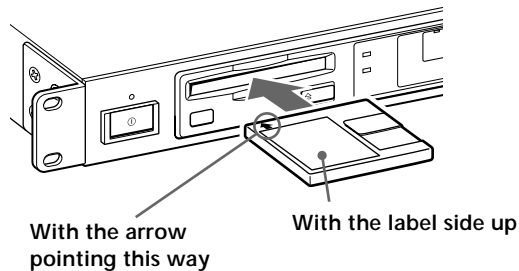

If the MD has a recorded material on it, the recorder will automatically start recording from the end of the last recorded track.

4 Set INPUT to the corresponding input connector.

To record through		Set INPUT to
DIGITAL IN	COAXIAL	DIGITAL
ANALOG IN	BAL or UNBAL	ANALOG

5 Select a recording mode from the Set up Menu.

- 1 Press EDIT/NO twice to display "Setup Menu."
- 2 Wait until "Rec Mode" appears in the display, when press AMS.
- 3 Turn AMS to the desired recording mode (STEREO or MONO) and press AMS.
- 4 Press EDIT/NO..

Monaural recording will last about two times longer than stereo recording.

Analog input

When using the analog input, switch the rear-panel ANALOG INPUT (BAL or UNBAL) according to the type of the input terminal used.

Monitor audio during recording

Even if you set REC MODE to MONO, the monitor signal does not become monaural.

Recording mode

The last recording mode in effect will be restored even when you replace the MD or turn the recorder off and on.

6 Press ●.
The recorder stands by for record.

7 When recording the analog input signal, adjust the recording level with REC LEVEL.
The fourth dot is satisfactory for most purposes. For details, refer to “Adjusting the Recording Level” on page 11.

8 Press ▷ or ■.
Recording starts.

9 Start playing the program source.

When “TOC” indicator flashes in the display

The recorder is currently updating the Table Of Contents (TOC). Do not turn off the power, move the recorder, or pull out the AC power cord, while “TOC” indicator is flashing. Changes to an MD made through recording are saved only when you update the TOC by ejecting the MD.

Do not turn off the power or disconnect the recorder from the power source immediately after recording.

If you do, recorded material may not be saved to the MD. To save the material, after recording, press ≡ EJECT to take out the MD. “TOC” indicator will flash in the display at this time.

After “TOC” indicator stops flashing and is unlit, you can turn off the power or pull out the AC power cord.

To	Press
Stop recording	■
Pause recording*	■. Press the button again or press ▷ to resume recording.
Take out the MD	≡ EJECT after stopping recording

* Whenever you pause recording, the track number increases by one. For example, if you paused recording while recording on track 4, the track number increases by one and recording continues on the new track when restarted.

To protect an MD against accidental erasure

To make it impossible to record on an MD, slide the tab in the direction of arrow, opening the slot. To allow recording, close the slot.

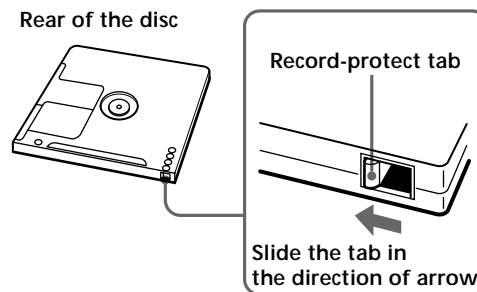

Playing an MD

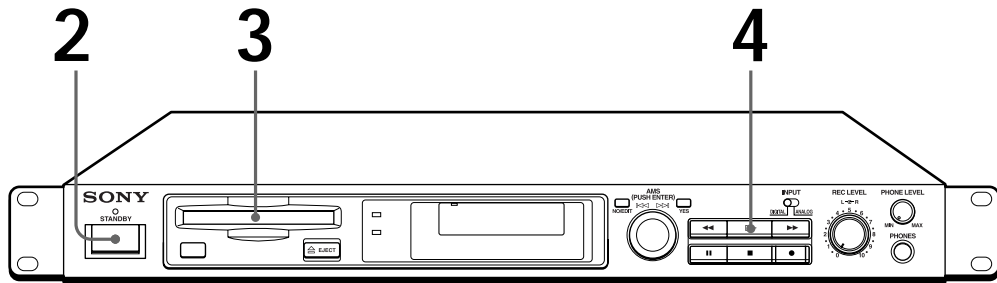

1 Turn on the mixer and adjust the fader or level control of the corresponding channel.

2 Press ①.

3 Insert an MD.

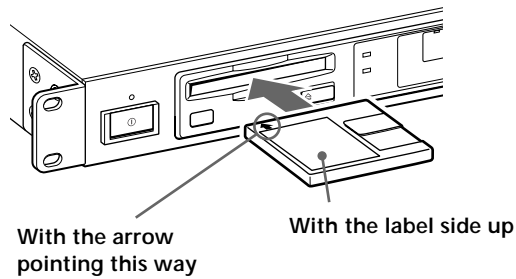

4 Press ▷. The recorder starts playing.

You can locate and play back a track while the recorder is stopped

1 Turn AMS (or press ◀◀ or ▶▶ on the remote) until the number of the desired track appears.

2 Press AMS or ▷.

To use headphones
Connect them to PHONES jack. Use PHONE LEVEL to adjust the volume.

To	Do the following:
Stop playing	Press ■.
Pause playing	Press ■. Press the button again or press ▷ to resume playing.
Go to the next track	Turn AMS clockwise (or press ▶▶ on the remote).
Go to the preceding track	Turn AMS counterclockwise (or press ◀◀ on the remote).
Take out the MD	Press ⏏ EJECT.

Notes on Recording

If "Protected" appears in the display

The MD is record-protected. Close the slot to record on the disc (see "To protect an MD against accidental erasure" on page 7).

If "Din Unlock" flashes in the display

- The digital program source which you set with INPUT in Step 4 on page 6, is not connected.
To continue, connect the program source properly.
- The program source is not on.
Turn on the program source.

Depending on the source being recorded, track numbers are marked in the following ways:

- When recording from a CD or MD with INPUT set to DIGITAL and the source connected through DIGITAL IN: The recorder automatically marks track numbers in the same sequence as the original. If, however, a track is repeated two or more times (e.g. by single-track repeat play) or two or more tracks with the same track number (e.g. from different MDs or CDs) are played, the track or tracks are recorded as a single, continuous track with a single track number.
If the source is an MD, track numbers may not be marked for tracks of less than 4 seconds.
- When recording from DAT or satellite broadcasts with INPUT set to DIGITAL, the recorder automatically marks a track number whenever the sampling frequency of the input signal changes.

When "TOC" indicator flashes in the display

The recorder is currently updating the Table Of Contents (TOC). Do not turn off the power, move the recorder, or pull out the AC power cord. Changes to an MD made through recording are saved when you update the TOC by ejecting the MD.

When the program mode is set to PROGRAM or SHUFFLE (see pages 19 and 20)

It is automatically switched to CONTINUE and the equipment enters the recording standby state.

If "Cannot Copy" appears in the display

The recorder uses the SCMS (Serial Copy Management System).

MDs recorded through digital input connector cannot be copied onto other MDs or DAT tapes through the digital output connector (see page 38).

When recording digital signals that have been emphasized (in the higher frequencies)

The signal is automatically de-emphasized (with attenuation proportional to the degree of emphasis) and the level of the de-emphasized signal is indicated on the peak level meters.

When the recorder is recording or in recording pause, digital signals input through DIGITAL IN are output to DIGITAL OUT with the same sampling rate.

To change the digital input signal to another sampling rate for output (without recording it to an MD), use Input Monitor Function (see page 10).

Useful Tips for Recording

Checking the remaining recordable time on the MD

- When you press DISPLAY repeatedly while recording, the display changes as follows: elapsed recording time, remaining recordable time on the MD, track name.
- When you press DISPLAY repeatedly while the recorder is stopped, the display changes as follows: total recorded time, remaining recordable time on the MD, disc name (see page 16).

Monitoring the input signal (Input Monitor)

Before starting recording, you can monitor the selected input signal through the recorder's output connectors.

- 1 Press EJECT to remove the MD.
- 2 Set INPUT according to the input signal you want to monitor.

When INPUT is set to ANALOG

The analog signal input through LINE (ANALOG) IN is output to DIGITAL OUT after A/D conversion, and then to the LINE (ANALOG) OUT connectors and PHONES jack after D/A conversion.

When INPUT is set to DIGITAL

The digital signal input through DIGITAL IN is output to DIGITAL OUT, and then to the LINE (ANALOG) OUT connectors and PHONES jack after D/A conversion.

Note

Even if you set REC MODE to MONO, the monitor signal does not become monaural.

- 3 Press .
If INPUT is set to ANALOG, "AD-DA" appears in the display.
If INPUT is set to DIGITAL, "-DA" appears in the display.

If "Auto Cut" appears in the display (Auto Cut)

There has been no sound input for 30 seconds while INPUT is set to DIGITAL and the source is connected through DIGITAL IN. The 30 seconds of silence are replaced by a blank of about 3 seconds and the recorder changes to recording pause.



You can turn off the Auto Cut Function

For details, see "If "Smart Space" appears in the display" below.

If "Smart Space" appears in the display (Smart Space)

When there has been an extended silence of up to 30 seconds in length, and the signal is input again, the silence is replaced by a blank of about 3 seconds and the recorder continues recording.

Note

However, if you begin recording during such an extended silent portion, the smart space function will not be activated.

To turn off the Smart Space Function and Auto Cut Function

- 1 While the recorder is stopped, press EDIT/NO twice to display "Setup Menu".
- 2 Turn AMS until "Smart Space" menu appears in the display, then press AMS.
- 3 Turn AMS until "S.Space OFF" appears in the display, then press AMS.
- 4 Press EDIT/NO.

To turn on the Smart Space Function and Auto Cut Function again

- 1 Carry out Steps 1 and 2 in "To turn off the Smart Space Function and Auto Cut Function" above.
- 2 Turn AMS until "S.Space ON" appears in the display, then press AMS.
- 3 Press EDIT/NO.

Notes

- When you turn off the Smart Space Function, the Auto Cut Function is also turned off automatically.
- The Smart Space Function and Auto Cut Function are factory set to on.
- If you turn off the recorder or disconnect the AC power cord, the recorder will recall the last setting (on or off) of the Smart Space and Auto Cut Functions the next time you turn on the recorder.

Recording Over Existing Tracks

Follow the procedure below to record over existing material just as you would on an analog cassette tape.

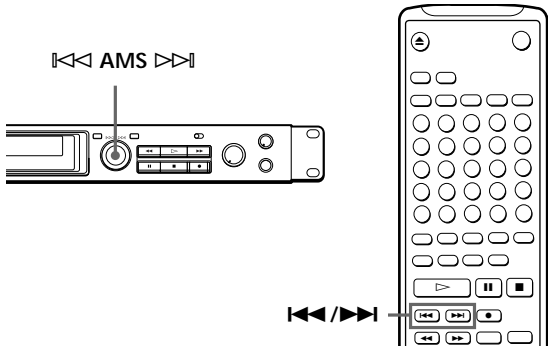

- 1 Carry out Steps 1 to 5 in “Recording on an MD” on page 6.
- 2 Turn AMS (or press ◀◀ or ▶▶) until the number of the track to be recorded over appears.
- 3 To record from the start of the track, continue from Step 6 in “Recording on an MD” on page 7.

- To record from the middle of the track
- 1 After Step 2 above, press ▷ to start playback.
 - 2 Press || where you want to start recording.
 - 3 Continue from Step 6 in “Recording on an MD” on page 7.

Note
You cannot record from the middle of the track during “PROGRAM” or “SHUFFLE” play.

Adjusting the Recording Level

When recording with INPUT set to ANALOG and the signal input through LINE (ANALOG) IN jacks, use REC LEVEL to adjust the recording level before starting recording.

You cannot adjust the recording level during digital recording.

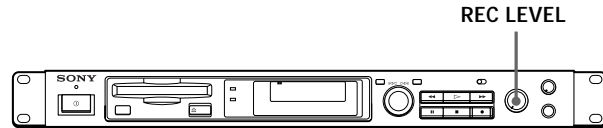

- 1 Carry out Steps 1 to 6 in “Recording on an MD” on pages 6 and 7.
- 2 Play the portion of the program source with the strongest signal level.
- 3 While monitoring the sound, turn REC LEVEL to adjust the recording level so that the peak level meters reach their highest point without turning on the OVER indication. Occasional lighting of “OVER” is acceptable.

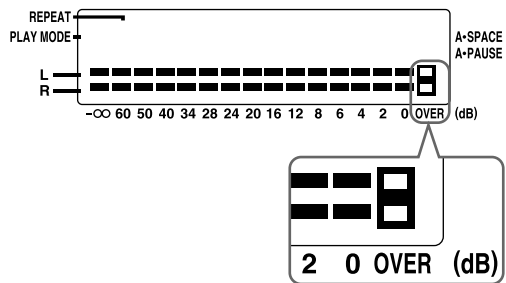

- 4 Stop playing the program source.
- 5 To start recording, follow the procedure starting from Step 8 in “Recording on an MD” on page 7.

Marking Track Numbers While Recording (Track Marking)

You can mark track numbers either manually or automatically. By marking track numbers at specific points, you can quickly locate the points later using the AMS Function or Editing Functions.

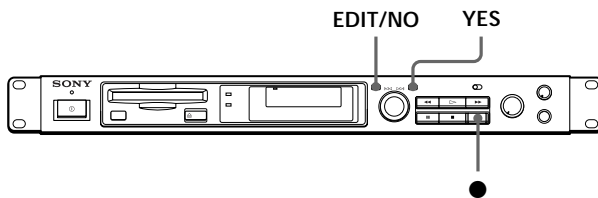

Marking track numbers manually (Manual Track Marking)

You can mark track numbers at any time while recording on an MD.

Press ● at the place you want to add a track mark while recording.

Marking track numbers automatically (Automatic Track Marking)

The recorder adds track marks differently in the following cases:

- When recording from CDs or MDs with INPUT set to DIGITAL and the source connected through DIGITAL IN:
The recorder marks track numbers automatically. When you record from a CD or MD, the track numbers are marked as they are found on the original.
- In the case other than the above
The LEVEL-SYNC function assigns a track number automatically each time the input signal of the source falls to a given level or below and a new input signal exceeding that level is received.

To Cancel Auto Track Marking

- 1 While the recorder is stopped, press EDIT/NO twice to display "Set up Menu".
- 2 Turn AMS until "Level Sync" appears in the display, then press AMS.
- 3 Turn AMS until "Level Sync OFF" appears in the display, then press AMS.
- 4 Press EDIT/NO.

To Turn on Auto Track Marking

- 1 Carry out Steps 1 and 2 in "To Cancel Auto Track Marking" above.
- 2 Turn AMS until "Level Sync ON" appears in the display, then press AMS.
- 3 Press EDIT/NO.

 When you want to mark track numbers after you've finished recording
Use the Divide Function (see "Dividing Recorded Tracks" on page 24.)

Note

If you turn off the recorder or disconnect the AC power cord, the recorder will recall the last setting (Level Sync ON or OFF) of the Automatic Track Marking Function the next time you turn on the recorder.

Starting Recording With 6 Seconds of Prestored Audio Data (Time Machine Recording)

When recording from an FM or satellite broadcast, the first few seconds of material are often lost due to the time it takes you to ascertain the contents and press the record button. To prevent the loss of this material, the Time Machine Recording Function constantly stores 6 seconds of the most recent audio data in the buffer memory so that when you begin recording the program source, the recording actually begins with the 6 seconds of audio data stored in the buffer memory in advance, as shown in the illustration below:

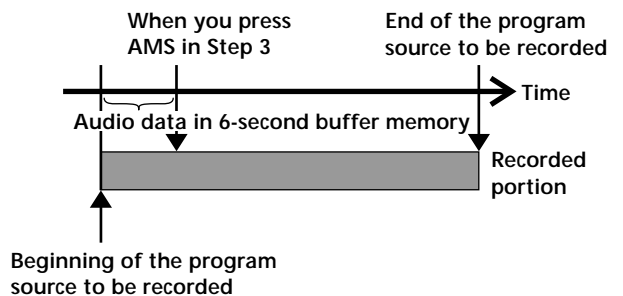

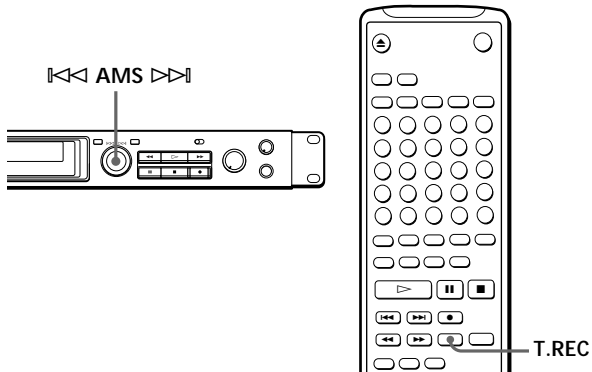

- 1** Carry out Steps 1 to 6 in “Recording on an MD” on pages 6 and 7.
The recorder changes to recording pause.
- 2** Start playing the program source you want to record.
The most recent 6 seconds of audio data is stored in the buffer memory.
- 3** Press AMS (or T.REC) to start Time Machine Recording.
Recording of the program source starts with the 6 seconds of audio data stored in the buffer memory.

 **To stop Time Machine Recording**
Press ■.

Note

The recorder starts storing audio data when the recorder is in recording pause and you start playing the program source. With less than 6 seconds of playing of the program source and audio data stored in the buffer memory, Time Machine Recording starts with less than 6 seconds of audio data.

Synchro-Recording With Audio Equipment of Your Choice

By using the MUSIC SYNC button on the remote, you can automatically start a Synchronized recording with the signal input from the program source through the input jacks.

The method of marking track numbers differs, depending on the program source being recorded and how the recorder is connected to the program source. (See “Notes on Recording” on page 9.)

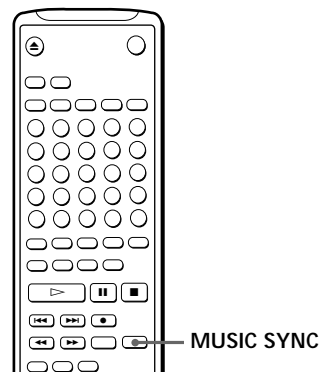

- 1** Carry out Steps 1 to 5 in “Recording on an MD” on page 6.
- 2** Press MUSIC SYNC.
The recorder changes to recording pause.
- 3** Start playing the program source you want to record.
The recorder starts recording automatically.

 **To stop Music Synchro-Recording**
Press ■.

Note

During Music Synchro-Recording, the Smart Space Function and the Auto Cut Function turn on automatically regardless of their settings (ON or OFF) and type of input (digital or analog).

Synchro-Recording With a Sony CD Player

By connecting your recorder to a Sony CD player, you can easily dub CDs onto MDs using the CD synchro buttons on the remote. If your recorder is connected to a Sony CD player by a digital input cable, track numbers are automatically marked as on the original, regardless of whether “LevelSync ON” or “LevelSyncOFF” is selected. If your recorder is connected to a Sony CD player by audio connecting cords through LINE (ANALOG) IN, track numbers are automatically marked when you select “LevelSync ON” (see “Marking Track Numbers While Recording” on page 12).

As the same remote controls both the CD player and the recorder, you may have trouble operating both units if they are far from each other. If you do, place the CD player close to this recorder.

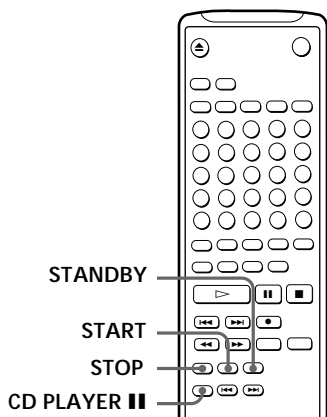

- 1 Turn on the CD player and the mixer.
- 2 Carry out Steps 2 to 5 in “Recording on an MD” on page 6 to prepare the recorder for recording.
- 3 Insert a CD into the CD player.
- 4 Select the playback mode (Shuffle Play, Program Play, etc.) on the CD player.
- 5 Press STANDBY.
The CD player pauses for playing and the recorder pauses for recording.

- 6 Press START.
The recorder starts recording and the CD player starts playback.
The track number and elapsed recording time of the track appear in the display.

If the CD player does not start playing

Some CD player models may not respond when you press START on the remote of the recorder. Press **||** on the remote of the CD player instead.

- 7 Press STOP to stop synchro-recording.

To pause recording

Press STANDBY or CD PLAYER **||**.

To restart recording, press START or CD PLAYER **||**. A new track number is marked each time you pause recording.

You can use the remote of the CD player during synchro-recording

When you press **■**, the CD player stops and the recorder pauses for recording.
When you press **||**, the CD player pauses and the recorder pauses for recording.
To restart synchro-recording, press **▷**.

You can change CDs during synchro-recording

Carry out the following steps instead of Step 7 above.

- 1 Press **■** on the remote of the CD player.
The recorder pauses for recording.
- 2 Change the CD.
- 3 Press **▷** on the remote of the CD player.
Synchro-recording restarts.

You can also do synchro-recording with a Sony video CD player

Using the procedure for synchro-recording with a Sony CD player, you can do synchro-recording with a Sony video CD player also.
To select the video CD player, press button number 2 while pressing down the POWER button before starting the procedure.
To select the CD player again, press button number 1 while pressing down the POWER button.
The recorder is factory set to CD player for synchro-recording.

You can check the remaining recordable time on the MD

Press DISPLAY on the remote controller.

Recording Using a Timer

A commercially available timer connected to the recorder allows it to start or stop recording at a preappointed time. For additional information, refer to the information manual for the timer.

- 1** Turn on the timer.
- 2** Perform steps 1 to 5 in “Recording on an MD” (see page 6).
- 3** Choose “Timer REC” from the Setup Menu.
 1. While the recorder is stopped, press EDIT/NO twice to display “Setup Menu.”
 2. Turn AMS until “Timer” appears in the display, then press AMS.
 3. Turn AMS until “Timer REC” appears in the display, then press AMS.
 4. Press EDIT/NO.
- 4** Set the timer to the desired operation.
- 5** Having finished recording with a timer, choose “Timer OFF” from the Setup Menu.
 1. Perform steps 1 and 2 in step 3 above.
 2. Turn AMS until “Timer OFF” appears in the display, then press AMS.
 3. Press EDIT/NO.

If you leave the setup Menu “Timer REC” setting, the recorder will begin recording automatically next time it is powered on.

After timer recording, be sure to turn on the recorder within one month

When you turn on the recorder next time, the recording will be transferred to the MD. If you leave the recorder unpowered, the recording will not be transferred to the MD when you turn on the recorder.

Using the Display

You can use the display to check disc and track information such as the total track number, total playing time of the tracks, remaining recordable time of the disc and disc name.

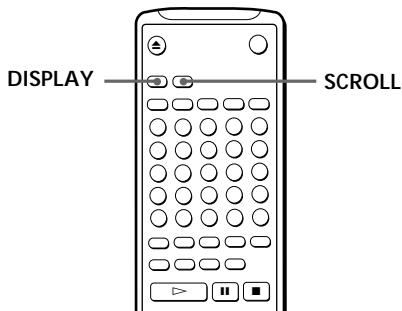

Checking the total track number, total disc playing time, remaining recordable time of the disc and the title of the disc

Each time you press DISPLAY/CHAR (or DISPLAY) while the recorder is stopped, you can change the display as follows:

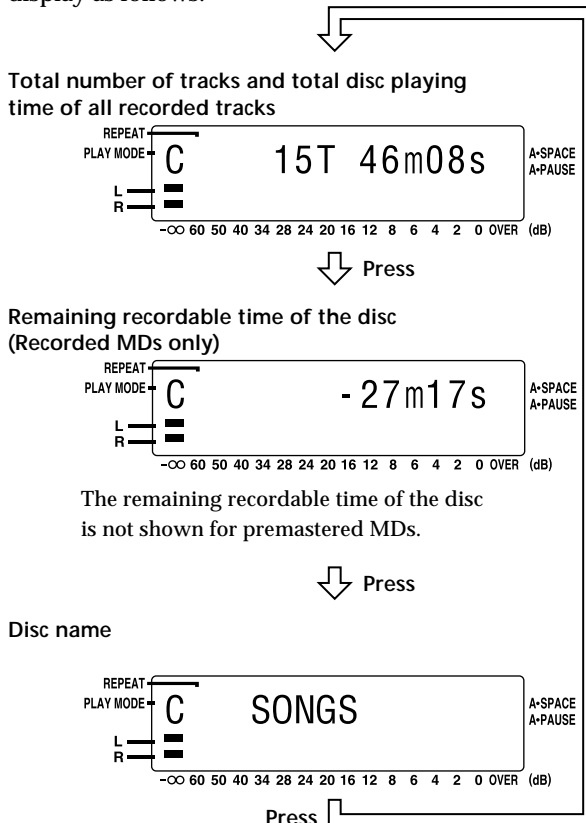

When you insert an MD, the disc name, total number of tracks, and total disc playing time appear in the display as follows:

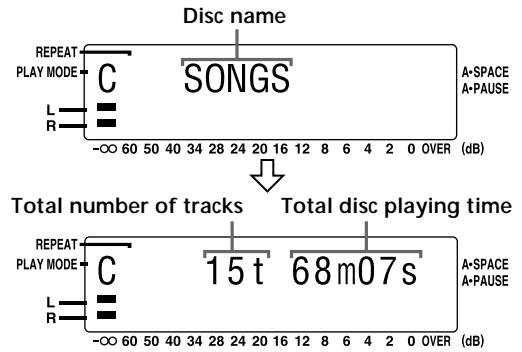

To label a recordable disc and its tracks, see “Labeling Recordings” on page 26.

Note

When you insert a new MD or turn off the recorder and turn it on again, the last item displayed will reappear. However, if you disconnect the AC power cord, the display will show the total number of tracks and total disc playing time of all recorded tracks the next time you turn on the recorder, no matter what the last display was.

Checking remaining time and the title of a track

Press DISPLAY on the remote controller while playing a track. Each time you press DISPLAY, the track number and remaining time of the current track are displayed in the following sequence:

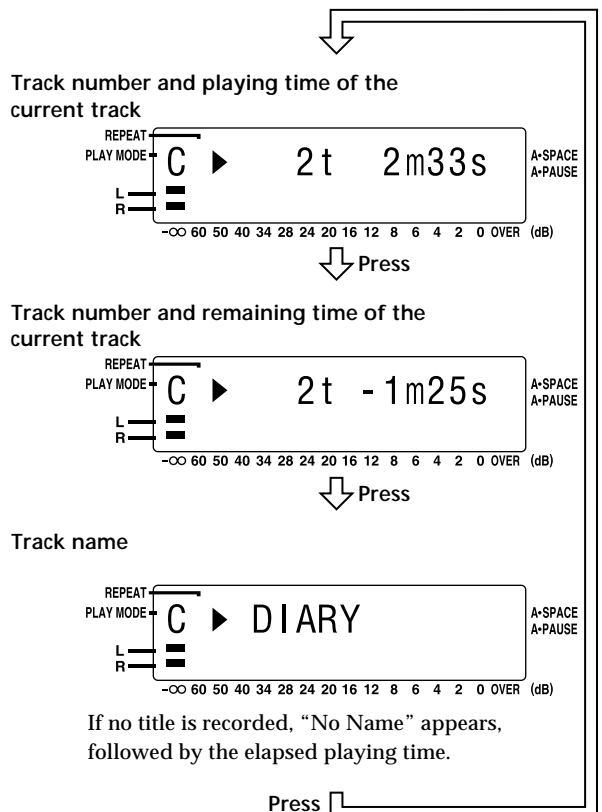



If no title is recorded, “No Name” appears, followed by the elapsed playing time.

(Continued)

💡 You can check the track name at any time while playing an MD 
 Press SCROLL on the remote.
 Since the display shows up to 12 characters at a time, press SCROLL again to see the rest of the track title if the title has 13 characters or more.
 Press SCROLL again to pause scrolling, and again to continue scrolling.

💡 When you directly locate a track with a number over 25 
 You must press >25 first, before entering the corresponding digits.
 Press >25 once if it is a 2-digit track number, and twice if it is a 3-digit track number.
 To enter "0," press button 10.
 Examples: • To play track number 30
 Press >25 once, then 3 and 10.
 • To play track number 100
 Press >25 twice, then 1, 10 and 10.

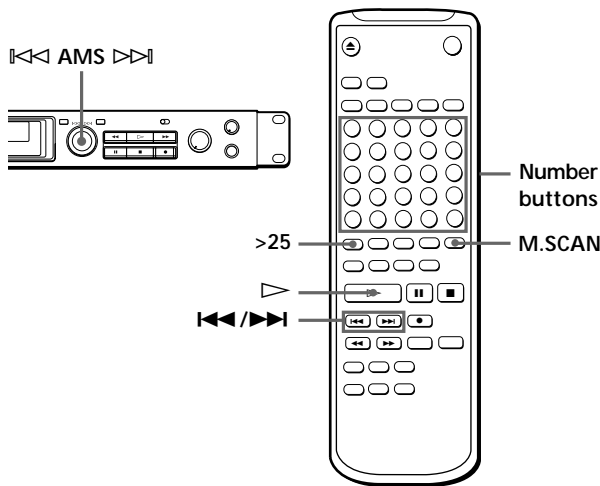

Locating a Specific Track

You can quickly locate any track while playing a disc by using AMS (Automatic Music Sensor),  and , number buttons or M.SCAN on the remote.









💡 You can change the playing time during music scan

- 1 While the recorder is stopped, press EDIT/NO to display "Setup Menu."
- 2 Turn AMS until "Music Scan" menu appears in the display, then press AMS.
- 3 Turn AMS to select the length of the Music SCAN play within the range of 6 to 20 seconds, using steps of about one second, then press AMS.
- 4 Press EDIT/NO.

💡 To pause playing at the beginning of a track
 Turn AMS (or press  or ) after pausing playback.

💡 To go quickly to the beginning of the last track
 Turn AMS counterclockwise (or press ) while the display shows the total number of tracks and total disc playing time, remaining recordable time of the disc, or disc name (see page 16).

To locate	Do the following:
The next or succeeding tracks	During playback, turn AMS clockwise (or press  repeatedly) until you find the desired track.
The current or preceding tracks	During playback, turn AMS counterclockwise (or press  repeatedly) until you find the desired track.
A specific track directly 	Press number buttons to enter the track number.
A specific track by using AMS	<ol style="list-style-type: none"> 1 Turn AMS until the desired track number appears while the recorder is stopped. 2 Press AMS or .
By scanning each track (music scan) 	<ol style="list-style-type: none"> 1 Press M.SCAN before you start playing. 2 When you find the desired track, press  to start playing.

Locating a Particular Point in a Track

You can also use ◀◀ and ▶▶ to locate a particular point in a track during playback or playback pause.

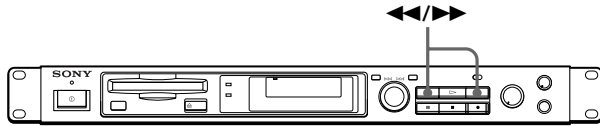

To locate a point	Press
While monitoring the sound	▶▶ (forward) or ◀◀ (backward) and keep pressing until you find the desired point.
Quickly by observing the display during playback pause (high speed search)	▶▶ or ◀◀ and hold until you find the desired point. There is no sound output during this operation.

💡 When "OVER" appears during high speed search
 If the disc reaches the end while you are pressing ▶▶ during playback pause, "OVER" appears in the display. Press ◀◀ (or press ◀◀) or turn AMS (or press ◀◀) counterclockwise to go back.

Notes

- If the disc reaches the end while you are pressing ▶▶ during sound monitoring, the recorder stops.
- Tracks that are only a few seconds long may be too short to scan using the search function. For such tracks, it is better to play the MD at normal speed.

Playing Tracks Repeatedly

You can play tracks repeatedly in any play mode.

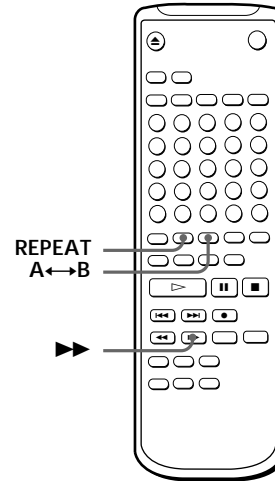

Press REPEAT.

"R" appears in the display, and the recorder will repeat the tracks as follows:

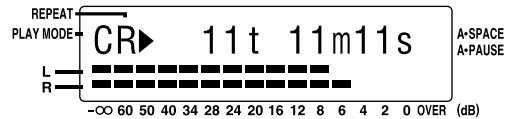

When the MD is played in	The recorder repeats
Normal play (page 8)	All the tracks
Shuffle Play (page 19)	All the tracks in random order
Program Play (page 20)	The same program

To cancel repeat play

Press REPEAT until "R" (REPEAT) disappears from the display.

Repeating the current track

While the track you want to repeat is playing in normal play, press REPEAT several times until "REPEAT 1" appears in the display.

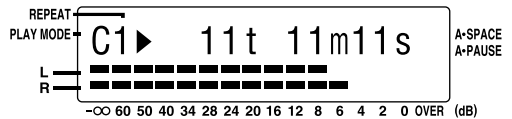

(Continued)

Repeating a specific portion (A-B Repeat)



You can play a specific portion of a track repeatedly. This might be useful when you want to memorize lyrics.

Note that you can only repeat a portion within the boundaries of a single track.

- 1 While playing a disc, press A↔B at the starting point (point A) of the portion to be played repeatedly. "Repeat- A-" appears in the display, with "-" showing in REPEAT.

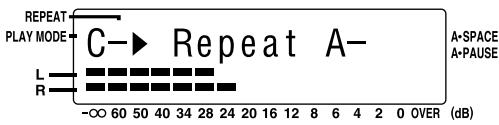

- 2 Continue playing the track or press ►► until you reach the ending point (point B), then press A↔B again. The specified interval is played repeatedly. The recorder starts to play the specified portion repeatedly.

To cancel A-B Repeat
Press REPEAT or ■.

Setting new starting and ending points

You can repeat the portion immediately after the currently specified portion by changing the starting and ending points.

- 1 Press A↔B while "REPEAT A-B" appears. The current ending point B becomes the new starting point A and "Repeat- A-" appears in the display.
- 2 Continue playing the track or press ►► until you reach the new ending point (point B), then press A↔B again. The newly specified interval is played repeatedly.

Note

If you turn off the recorder or disconnect the AC power cord, the recorder will recall the last setting of the Repeat Function the next time you turn on the recorder. The A-B Repeat settings, however, are lost.

Playing Tracks in Random Order (Shuffle Play)



You can have the recorder "shuffle" tracks and play them in random order.

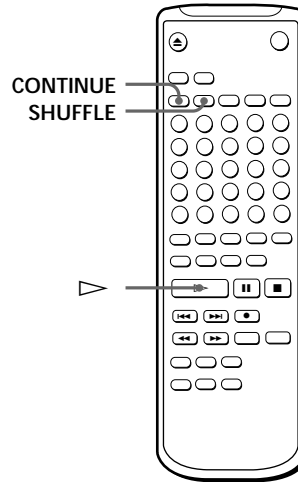

- 1 Press SHUFFLE in the remote controller while the recorder is stopped. "S" is displayed in PLAY MODE in the display.
- 2 Press ▷ to start Shuffle Play.

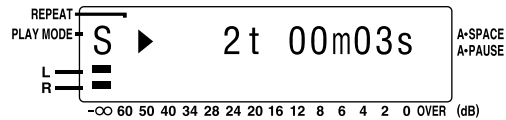

To cancel Shuffle Play

Press CONTINUE in the remote controller while the recorder is stopped. PLAY MODE in the display changes to "C".



You can specify tracks during Shuffle Play

- To play the next track, turn AMS clockwise (or press ►►).
- To play from the beginning of the current track again, turn AMS counterclockwise (or press ◀◀). You cannot use AMS (or ◀◀) to go to tracks that have already been played.

Creating Your Own Program (Program Play)

You can specify the playback order of the tracks on an MD and create your own programs containing up to 25 tracks.

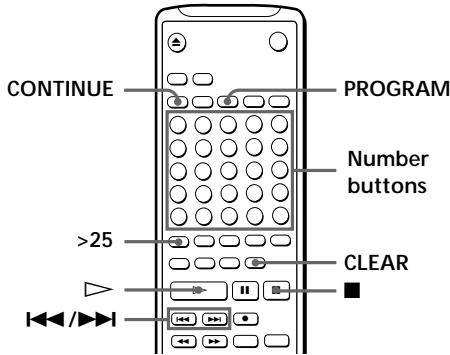

- 1 Press PROGRAM on the remote controller while the recorder is stopped.

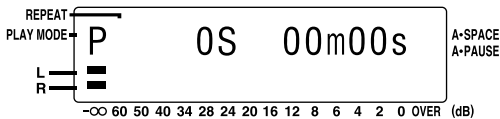

- 2 Press the number buttons to enter the tracks you want to program in the order you want. To program a track with a number over 25, use the >25 button (see page 17).
If you've made a mistake
Press CLEAR, then press the correct number button.
- 3 Repeat Step 2 to enter other tracks. Each time you enter a track, the total program time is calculated and appears in the display.
- 4 Press ▷ to start Program Play.

To cancel Program Play

Press CONTINUE in the remote controller while the recorder is stopped. "P" (PLAY MODE) disappears from the display.

 You can program the same track repeatedly
Press the appropriate number button as many times as you want to repeat.

 The program remains even after Program Play ends
When you press ▷, you can play the same program again.

Notes

- The program created by the Program Play Function is lost when you press EJECT to take out the MD.
- The program created by the Program Play Function is lost when you turn off the recorder or disconnect the AC power cord.
- The display shows "- m - s" instead of the total playing time when the total playing time of the program exceeds 160 minutes.

Checking the track order

You can check the order of tracks in your program during playback or playback pause.

Turn AMS (or press ◀◀ or ▶▶) during playback or playback pause. The track numbers appear in the order they were programmed.

Changing the track order

You can change the order of the tracks in your program before you start playing.

To	Do the following:
Erase the last track in the program 	Press CLEAR. Each time you press this button, the last track will be cleared.
Add tracks to the end of the program	Carry out Steps 2 and 3 in "Creating Your Own Program."
Change the whole program completely	1 Press CONTINUE. 2 Carry out Steps 1 to 3 in "Creating Your Own Program."

Useful Tips When Recording From MDs to Tape

The Auto Space and Auto Pause Functions described in this section make recording from MDs to tape more easy.

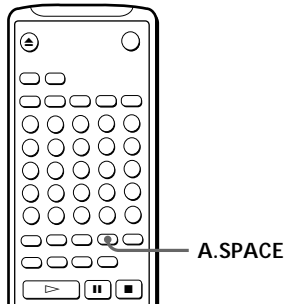

Inserting blank spaces while recording to tape (Auto Space)

The Auto Space Function inserts a 3-second blank space between each track while recording from MDs to tapes, allowing you to use the AMS function during playback later.

Press A.SPACE on the remote controller until a mark appears in A.SPACE in the display.

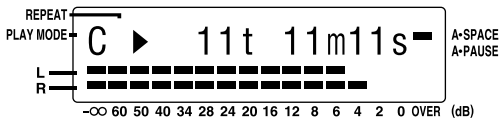

To cancel Auto Space

Press A.SPACE on the remote controller until a mark disappears in A.SPACE in the display.

Note

If the Auto Space Function is on while recording a selection containing multiple track numbers, (for example, a medley or symphony), blank spaces will be inserted within the selection whenever the track number changes.

Pausing after each track (Auto Pause)

When the Auto Pause Function is on, the recorder pauses after playing each track. Auto Pause is convenient when recording single tracks or multiple, non-consecutive tracks.

Press A.SPACE on the remote controller until a mark appears in A.PAUSE in the display.

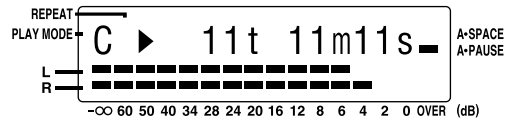

To restart playback

Press ▷ or ■■.

To cancel Auto Pause

Press A.SPACE on the remote controller until a mark disappears in A.PAUSE in the display.

Note

If you turn off the recorder or disconnect the AC power cord, the recorder will recall the last setting of the Auto Space and Auto Pause Functions the next time you turn on the recorder.

Playing Using a Timer

A commercially available timer connected to the recorder allows it to start or stop playing at a preappointed time. For additional information, refer to the information manual for the timer.

- 1 Turn on the timer.
- 2 Perform steps 1 to 3 in "Playing an MD" (see page 8).
- 3 Choose "Timer PLAY" from the Setup Menu.
 1. While the recorder is stopped, press EDIT/NO twice to display "Setup Menu."
 2. Turn AMS until "Timer" appears in the display, then press AMS.
 3. Turn AMS until "Timer PLAY" appears in the display, then press AMS.
 4. Press EDIT/NO.
- 4 Set the timer to the desired operation.

After Finishing Playing with a Timer

If you leave the setup Menu "Timer PLAY" setting, the recorder will begin playing automatically next time it is powered on. If you are not playing with a timer, choose "Timer OFF" from the Setup Menu.

Notes on Editing

You can edit the recorded tracks after recording, using the following functions:

- Erase Function allows you to erase recorded tracks simply by specifying the corresponding track number.
- Divide Function allows you to divide tracks at specified points so that you can quickly locate those points afterwards, using the AMS function.
- Combine Function allows you to combine two consecutive tracks into one.
- Move Function allows you to change the order of tracks by moving a specific track to a desired track position.
- Title Function allows you to create titles for your recorded MDs and tracks.

If "Protected" appears in the display

The recorder could not edit because the record-protect slot on the MD is open. Edit after closing the slot (see page 7.)

When "TOC" indicator flashes in the display

Do not move the recorder or pull out the AC power cord. After editing, "TOC" indicator lights continuously until you eject the MD. "TOC" indicator flashes while the recorder is updating the TOC. When the recorder finishes updating the TOC, "TOC" indicator goes off.

Erasing Recordings (Erase Function)

Follow the procedures below to erase:

- A single track
- All tracks
- Part of a track

Note, however, that once erased, MD data cannot be recovered.

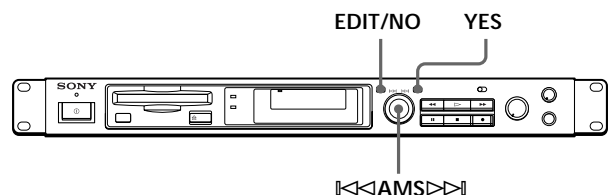

Erasing a single track

You can erase a track simply by specifying the respective track number. When you erase a track, the total number of tracks on the MD decreases by one and all tracks following the erased one are renumbered. Since erasing merely updates the TOC, there is no need to record over material.

 To avoid confusion when erasing multiple tracks, you should proceed in the order of high to low track numbers to prevent the renumbering of tracks that have not been erased yet.

Example: Erasing B

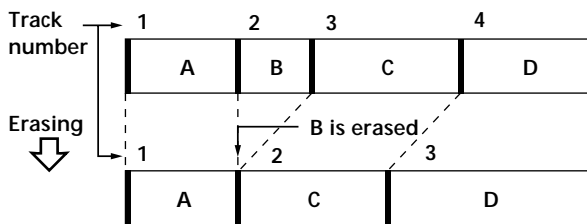

- 1 While the recorder is stopped or during playback pause, press EDIT/NO to display “Edit Menu.”
- 2 Turn AMS until “Erase?” appears in the display, then press AMS.
- 3 Turn AMS until the track number you want to erase appears in the display.
- 4 Press AMS or YES.
When the track selected in Step 3 has been erased, “Complete” appears for a few seconds and the total number of tracks in the music calendar decreases by one.
- 5 Repeat Steps 1 to 4 to erase more tracks.

To cancel the Erase Function
Press EDIT/NO or ■.

Note

If “Erase???” appears in the display, the track was recorded or edited on another MD recorder and is record-protected. If this indication appears, press YES to erase the track.

Erasing all tracks on an MD

You can delete the disc name, all recorded tracks, and titles of the recordable MD at once.

- 1 While the recorder is stopped or during playback pause, press EDIT/NO to display “Edit Menu.”
- 2 Turn AMS until “All Erase?” appears in the display.
- 3 Press AMS or YES.
“All Erase??” appears and all tracks in the music calendar start flashing.
- 4 Press AMS or YES again.
When the disc name, all recorded tracks, and titles on the MD have been erased, “Complete” appears for a few seconds.

To cancel the Erase Function

Press EDIT/NO or ■ and “All Erase?” or “All Erase??” disappears.



You can undo the Erase Function

See “Undoing the Last Edit” on page 29.

Erasing a part of a track

By using the Divide (see page 24), Erase (see page 22) and Combine (see page 25) Functions, you can erase specific portions of a track.

Example: Erasing a part of track A

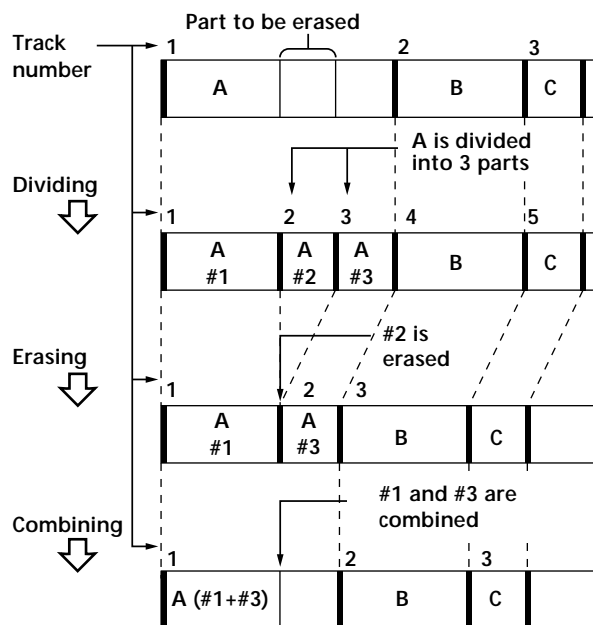

Dividing Recorded Tracks (Divide Function)

With the Divide Function you can assign a track number at places that you want to randomly access afterwards. Use this function to add tracks to MDs recorded from an analog source (and therefore contain no track numbers), or to divide an existing track into multiple portions. When you divide a track, the total number of tracks on the MD increases by one and all tracks following the divided track are renumbered.

Example: Dividing track 2 to create a new track for C

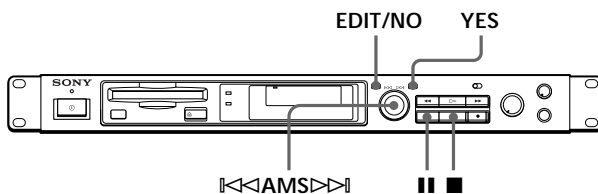
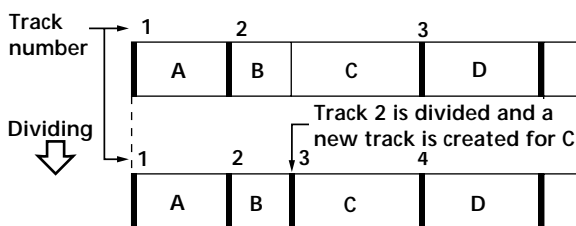

- 1 While playing the MD, press **||** at the point where you want to create a new track.
The recorder pauses playing.
- 2 Press EDIT/NO to display "Edit Menu."
- 3 Turn AMS until "Divide?" appears in the display, then press AMS.
"Rehearsal" alternates with "Position OK?" in the display, the track to be divided starts flashing in the music calendar, and the starting portion of the new track begins playing repeatedly. (If the starting position is correct, proceed with Step 5.)

- 4 While monitoring the sound, turn AMS to find the starting position of the new track.
The starting portion of the new track is played back repeatedly.
"Rehearsal" alternates with "Position OK?" in the display.
The starting position can be moved within a maximum range of -128 to +127 steps of about 0.06 seconds within a track.
- 5 Press YES or AMS when the position is correct.
When the track has been divided, "Complete" appears for a few seconds and the newly created track begins playing. The new track will have no track title even if the original track was labeled.

To cancel the Divide Function
Press **■** or EDIT/NO.

💡 You can undo a track division
Combine the tracks again (see "Combining Recorded Tracks" on page 25) then redivide the tracks if necessary.

💡 You can divide a track while recording
Use the Track Marking Function (see page 12).

Combining Recorded Tracks (Combine Function)

Use the Combine Function while the recorder is stopped, playing or in pause to combine consecutive tracks on a recorded MD. This function is useful for combining several songs into a single medley, or several independently recorded portions into a single track. When you combine two tracks, the total number of tracks decreases by one and all tracks following the combined tracks are renumbered.

Example: Combining B and C

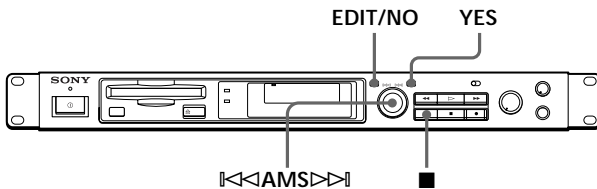
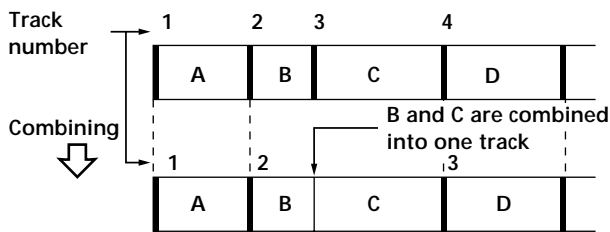

- 1 While the recorder is stopped or during playback pause, press EDIT/NO to display "Edit Menu."
- 2 Turn AMS until "Combine?" appears in the display, then press AMS.
- 3 Turn AMS until the number of the former track of the two to be combined appears in the display, then press AMS.
"Rehearsal" alternates with "Track OK?" in the display. The place where the two tracks will join (i.e., the end of the former track and the beginning of the latter track) repeatedly plays back.
- 4 If the track is the wrong one, press EDIT/NO or ■ then start again from Step 1.
- 5 If the place is correct, press AMS or YES.
When the tracks have been combined, "Complete" appears for a few seconds.
If both of the combined tracks have track titles, the title of the latter track is erased.

To cancel the Combine Function
Press EDIT/NO or ■



You can undo a track combination

Divide the tracks again (see "Dividing Recorded Tracks" on page 24), then repeat the combine function with the correct tracks if necessary.

Note

If "Impossible" appears in the display, the tracks cannot be combined. This sometimes happens when you've edited the same track many times, and is due to a technical limitation of the MD system, not a mechanical error.

Moving Recorded Tracks (Move Function)

Use the Move Function to change the order of any track. After you move a track, the track numbers between the new and old track positions are automatically renumbered.

Example: Moving track C to track position 2

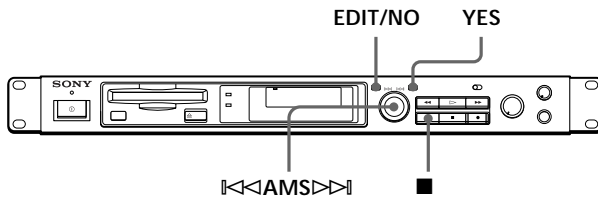
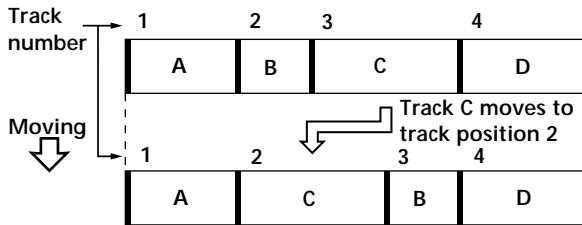

- 1 While the recorder is stopped or during playback pause, press EDIT/NO to display "Edit Menu."
- 2 Turn AMS until "Move?" appears in the display, then press AMS.
- 3 Turn AMS until the track number you want to move appears in the display, then press AMS.
- 4 Turn AMS until the new track position appears.
- 5 Press AMS or YES.
After you have moved the track, "Complete" appears for a few seconds.

To cancel the Move Function
Press EDIT/NO or ■

Labeling Recordings (Title Function)

You can create titles for your recorded MDs and tracks. Titles — which may consist of uppercase and lowercase letters, numbers and symbols for a maximum of about 1,700 characters per disc — appear in the display during MD operation.

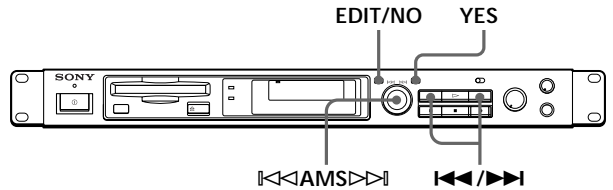

Use the following procedure to label a track or an MD. You can label a track during play, pause, record, or stop mode. If the track is playing or recording, be sure to finish labeling before the track ends. If the track ends before you've completed the labeling procedure, only the characters already entered are recorded automatically.

- 1 Press EDIT/NO to display "Edit Menu."
- 2 Turn AMS until "Name in?" appears in the display, then press AMS.
- 3 Turn AMS to select "Disc" or track number, then press AMS.
When you label an MD, select "Disc" and when you label a track, select the track number. Note that during recording, the recorder changes to character typing mode and a cursor starts flashing.

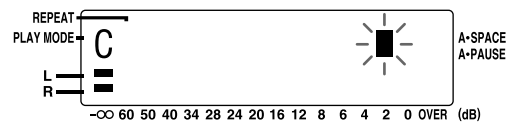

4 Turn AMS to select the character.

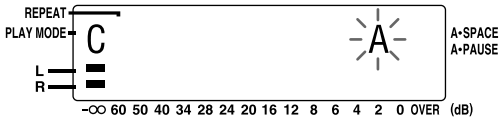

The selected character flashes.

Letters, numbers, and symbols appear in sequential order as you turn AMS.

You can use the following symbols in titles:

! " # \$ % & ' () * + , - . / : ; < = > ? @ _ ` ^

5 Press AMS to enter the selected character.

The cursor shifts rightward and waits for the input of the next character.

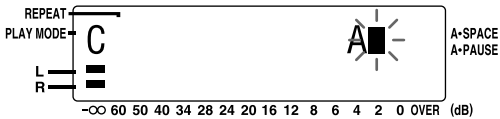

6 Repeat Steps 4 to 5 until you have entered the entire title.

If you entered the wrong character

Press ◀ or ▶ until the character to be corrected starts flashing, and repeat Steps 4 and 5 to enter the correct character.

To erase a character

Press ◀ ▶ until the character to be erased starts flashing, then press EDIT/NO.

To enter a space

Press AMS or ▶ while the cursor is flashing.

7 Press YES.

This completes the labeling procedure and the title appears on the left side of the display.

To cancel labeling

Press ■

Note

You cannot label a track or an MD while you are recording over an existing track.

(Continued)

Labeling tracks and MDs with the remote

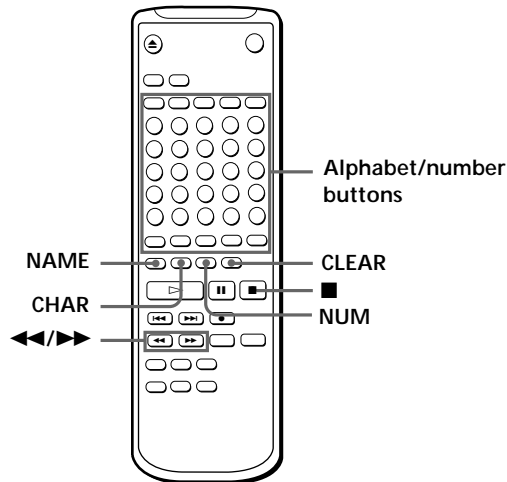

- 1 Press NAME repeatedly until a flashing cursor appears in the display, then do the following:

To label	Make sure that the recorder is
A track	Playing, pausing, recording the track to be labeled, or stopped after locating the track to be labeled
An MD	Stopped with no track number appearing in the display

- 2 Select the character type as follows:

To select	Press
Uppercase letters	CHAR repeatedly until "Selected AB" appears in the display
Lowercase letters	CHAR repeatedly until "Selected ab" appears in the display
Numbers	NUM repeatedly until "Selected 12" appears in the display

- 3 Enter one character at a time.
After you enter a character, the cursor shifts rightward and waits for the input of the next character.

- 4 Repeat Steps 2 and 3 until you have entered the entire title.
If you entered the wrong character
Press ◀▶ until the character to be corrected starts flashing.
Press CLEAR to erase the incorrect character, then enter the correct one.
- 5 Press NAME again.
The entered title appears on the left side of the display window after the label has been recorded.

To cancel labeling
Press ■

Changing an existing title

- 1 Press NAME, then do the following:

To change	Make sure that the recorder is
A track title	Playing, pausing the track whose title is to be changed, or stopped after locating the track whose title is to be changed
A disc name	Stopped with no track number appearing in the display

- 2 Keep pressing CLEAR (or EDIT/NO on the recorder) until the current title is erased.
- 3 Enter the new title.
Carry out Steps 4 to 7 of "Labeling Recordings" on page 26, or Steps 2 to 4 of "Labeling tracks and MDs with the remote" on page 28.
- 4 Press NAME.

Undoing the Last Edit (Undo Function)

You can use the Undo Function to cancel the last edit and restore the contents of the MD to the condition that existed before editing was done. Note, however, that you cannot undo an edit if you do any of the following after the edit:

- Press the ● button on the front panel.
- Press the ● button, the MUSIC SYNC button, or the CD-SYNC STANDBY button on the remote.
- Turn off the power or eject the MD.
- Disconnect the AC power cord.

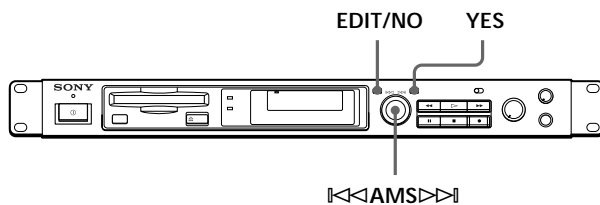

- 1 While the recorder is stopped or during playback pause, press EDIT/NO to display “Edit Menu.”
- 2 Turn AMS until “Undo?” appears in the display, then press AMS.
“Undo?” does not appear if no editing has been done.
One of the following messages appears in the display, depending on the type of editing to be undone:

Editing done:	Message:
Erasing a single track	“Erase Undo ?”
Erasing all tracks on an MD	
Dividing a track	“Divide Undo ?”
Combining tracks	“Combine Undo”
Moving a track	“Move Undo ?”
Labeling a track or an MD	“Name Undo ?”
Changing an existing title	

- 3 Press YES again.
“Complete” appears for a few seconds and the contents of the MD are restored to the condition that existed before the edit.

To cancel the Undo Function
Press EDIT/NO or ■

Function of Control Terminal

Control terminal (CTRL-S)

Mini jack type

When a system controller with CTRL-S terminal is connected to the control terminal of this recorder, it can operate as a remote .

Control functions

The system controller which is connected to the control terminal operates the same as the supplied remote RM-D7M.

Note

When the system controller is connected to the control jack, the remote can not be used because its infrared rays are stopped.

Dimensions

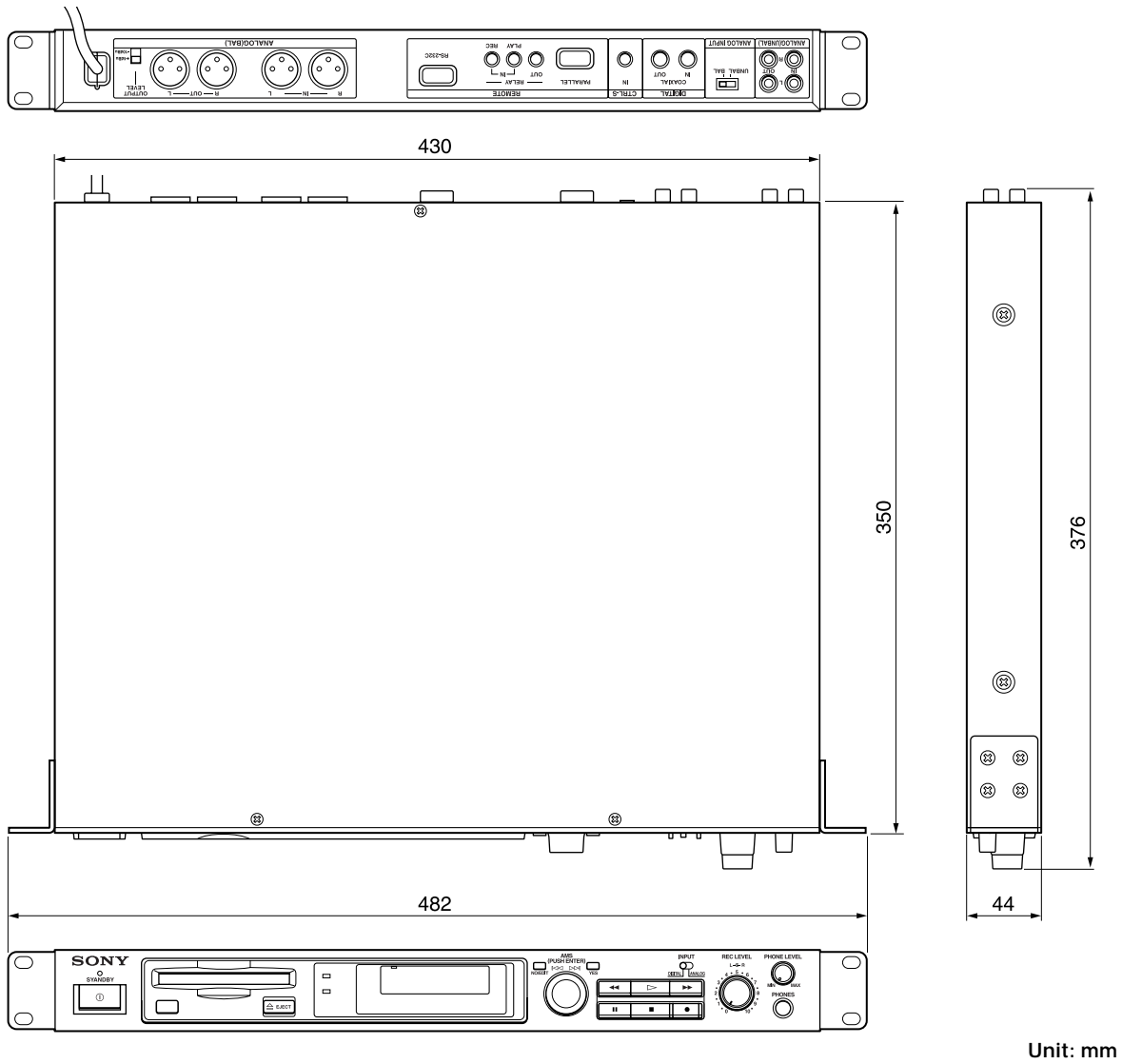

Mounting the recorder

This recorder can be attached to a standard 19 inch rack (type EIA). After detaching the four feet on the bottom of the recorder, mount the recorder on the rack.

Functions of REMOTE Terminals

RELAY REC/PLAY

— Stereo mini-jack terminal

Where multiple recorders are hooked up together, after the first recorder has finished recording or playing, control signals are automatically transferred to the second recorder through the RELAY terminal to direct it to start recording or playing.

Relay Play

Allows multiple recorders hooked up together to repeat continuously in sequence.

Recorders may be hooked up in a loop so they will repeat continuously.

Cabling for Relay Play

Connect RELAY OUT of the first recorder and RELAY IN PLAY of the second recorder with a stereo mini-plug cable (such as RK-G136). Interconnect RELAY OUT and RELAY IN PLAY also when hooking up two or more recorders together.

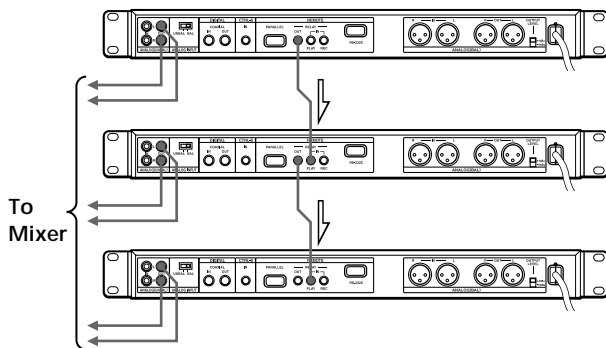

- 1 The first recorder starts playing.
- 2 When the first recorder finishes playing, the second recorder starts playing.
- 3 The third and subsequent connected by cabling to their RELAY IN PLAY terminals start playing in sequence as soon as the preceding recorders in the chain finish playing.

Note

This recorder starts playing when it receives a relay control signal only when:

- It is loaded with a playable MD.
- It is stopped.
- The Edit Menu or Setup Menu is not open.

If REPEAT is set, control signal output will be suppressed, disabling the relay play function.

Relay Record

Allows multiple recorders hooked up together to record continuously in sequence.

Cabling for Relay Record

Connect RELAY OUT of the first recorder and RELAY IN REC of the second recorder with a stereo mini-plug cable (such as RK-G136). Interconnect RELAY OUT and RELAY IN REC also when hooking up two or more recorders together.

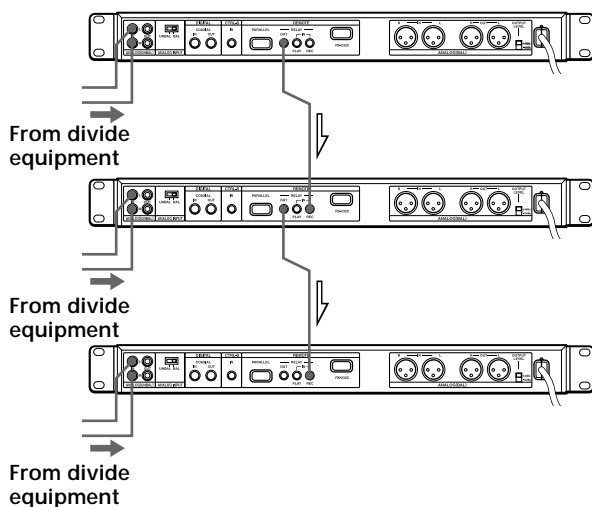

Additional Information

- 1 The first recorder starts recording.
- 2 When the first recorder finishes recording, the second recorder starts recording.
- 3 The third and subsequent connected by cabling to their RELAY IN REC terminals start recording in sequence as soon as the preceding recorders in the chain finish recording.

If the display is set to show the remaining disc time (see page 16) during relay recording, a relay control signal is issued when the remaining recording time is reduced to about 6 seconds, thereby making overlapped recording possible on the first and second recorders.

When a recorder starts recording on receiving a control signal from the RELAY IN REC terminal, its display is automatically set to show the remaining disc time.

Note

This recorder starts recording when it receives a relay control signal only when:

- It is loaded with a recordable MD.
- If digital input signal has been selected, digital audio signal output from the source is available.
- It is stopped.
- The Edit Menu or Setup Menu is not open.

Relay recording always takes place in NewTrackRec mode.

Relay recording while clearing prerecorded discs is not available with this recorder.

Parallel I/O

— D-sub 9 pins (female)

The parallel I/O pins permit remote control with simple external circuits connected. The input pins, when connected to GND, implement the functions assigned to them. The output terminals are open collector outputs, which can be used to turn on LEDs to provide recorder status indications.

Sample I/O pin circuits

<Sample output circuit>

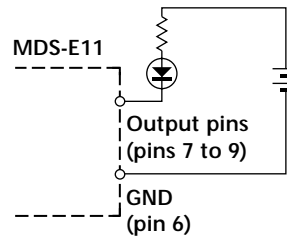

<Sample input circuit>

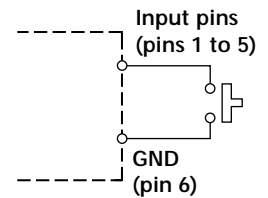

The Setup Menu allows you to select between defaults (PRESET) and user settings (USER).

The table below gives the relationship between the pin I/O and default functions.

Pin No.	I/O	Function	Setup Menu Name
1	Input	PLAY/PAUSE	PIN1
2	Input	REC	PIN2
3	Input	STOP	PIN3
4	Input	AMS+	PIN4
5	Input	AMS-	PIN5
6	-	GND	
7	Output	REC	POUT1
8	Output	PLAY	POUT2
9	Output	PAUSE	POUT3

With user settings (USER), PIN1 to PIN5 and POUT1 to POUT3 in the Setup Menu can be assigned the functions in the table below. Each pin has fixed I/O status.

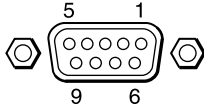

PIN1 to PIN5 (Input pins)

POWER ON	Turns on power. Not functional when already on.
POWER OFF	Turns off power. Not functional when already off.
POWER ON/OFF	Turns power on and off.
▶/	Performs a play or pause operation.
PLAY	Performs the same function as the recorder's PLAY key.
PAUSE	Performs the same function as the recorder's PAUSE key.
STOP	Performs the same function as the recorder's STOP key.
REC	Performs the same function as the recorder's REC key.
AMS+	Performs the same function as giving 1 click clockwise turn to AMS.
AMS-	Performs the same function as giving 1 click counterclockwise turn to AMS.
FF	Performs the same function as the recorder's FF key.
REW	Performs the same function as the recorder's REW key.
EJECT	Performs the same function as the recorder's EJECT key.
M.SYNC	Performs the same function as the remote controller's M.SYNC.
T.REC	Performs the same function as the remote controller's T.REC.
OFF	Performs nothing.

POUT1 to POUT3 (Output pins)

POWER	Grounded when the power is on.
REC	Grounded when the recorder's REC indicator lights.
PLAY	Grounded when the recorder displays ▶.
PAUSE	Grounded when the recorder displays .
NO DISC	Grounded when the recorder is on and is not loaded with a MD.
OFF	Left constantly floating.

Electrical Specifications

Input Terminal

Input method:	Make contact
Input on voltage:	0.5 V or less
Input off voltage:	3 V or more
Open terminal voltage:	3 V
Input pulse width:	100 msec or more
Input withstand voltage:	-0.5 to +10 V

Output Terminal

Output method:	NPN transistor open collector
On-time residual voltage:	0.5 V or less
On-time maximum inflow current:	100 mA
Withstand voltage:	20 V

RS-232C

— D-sub 9 pins (male)

The recorder can be externally controlled from a PC or similar equipment. For control protocols, consult your dealer.

Display Messages

The following table explains the various messages that appear in the display.

Message	Meaning
Blank Disc	A new (blank) or erased MD has been inserted.
Cannot Copy	An attempt was made to make a second copy from a digitally dubbed MD (see page 38.)
Cannot EDIT	An attempt was made to edit the MD during Program, Shuffle, or Normal Play.
Din Unlock	The connected digital sound source is turned off or the recorder is not connected properly to the sound source.
Disc Error	Defected MD is inserted.
Disc Full	The MD is full (see "System Limitations" on this page.)
Impossible	You cannot record or edit the MD due to the system limitations.
Name Full	The titling capacity of the MD has reached its limit (about 1,700 characters.)
No Disc	There is no MD in the recorder.
No Track	The inserted MD has a disc title but no tracks.
Protected	The inserted MD is record-protected.
Retry	The first recording attempt failed due to a disturbance or scratch on the MD, and a second attempt is being made.
Retry Error	Due to vibrations to the recorder or scratches on the MD, several recording attempts were made but with no success.
STANDBY (flashing)	The contents previously recorded are not saved correctly on the MD, or the program created by Program Play is not stored in the recorder's memory.

System Limitations

The recording system in your MiniDisc recorder is radically different from those used in cassette and DAT recorders and is characterized by the limitations described below. Note, however, that these limitations are due to the inherent nature of the MD recording system itself and not to mechanical causes.

"Disc Full" lights up even before the MD has reached the maximum recording time (60 or 74 minutes)
When 255 tracks have been recorded on the MD, "Disc Full" lights up regardless of the total recorded time. More than 255 tracks cannot be recorded on the MD. To continue recording, erase unnecessary tracks or use another recordable MD.

"Disc Full" lights up before the maximum number of tracks is reached
Fluctuations in emphasis within tracks are sometimes interpreted as track intervals, incrementing the track count and causing "Disc Full" to light up.

The remaining recording time does not increase even after erasing numerous short tracks
Tracks under 12 seconds in length are not counted and so erasing them may not lead to an increase in the recording time.

Some tracks cannot be combined with others
Track combination may become impossible when tracks are edited.

The total recorded time and the remaining time on the MD may not total the maximum recording time (60 or 74 minutes)
Recording is done in minimum units of 2 seconds each, no matter how short the material. The contents recorded may thus be shorter than the maximum recording capacity. Disc space may also be further reduced by scratches.

Tracks created through editing may exhibit sound dropout during search operations.

Track numbers are not recorded correctly
Incorrect assignment or recording of track numbers may result (1) when CD tracks are divided into several smaller tracks during digital recording, or (2) while recording certain CDs with the "LEVEL-SYNC" on (i.e., the automatic track marking function on.)

“TOC Reading” appears for a long time
 “TOC Reading” will be displayed for longer than normal when an MD containing many songs is loaded.

Limitations when recording over an existing track

- The correct remaining recording time may not be displayed.
- You may find it impossible to record over a track if that track has been recorded over several times already. If this happens, erase the track using the Erase Function (see page 20.)
- The remaining recording time may be shortened out of proportion to the total recorded time.
- Recording over a track to eliminate noise is not recommended since this may shorten the duration of the track.
- You may find it impossible to label a track while recording over it.

The correct recorded/playing time may not be displayed during playback of monaural-format MDs.

Troubleshooting

If you experience any of the following difficulties while using the recorder, use this troubleshooting guide to help you remedy the problem. Should any problem persist, consult your nearest Sony dealer.

The recorder does not operate or operates poorly.

- ➔ The MD may be damaged (“Disc Error” appears.)
 Take the MD out and insert it again. If “Disc Error” remains, replace the MD.

The recorder does not play back.

- ➔ Moisture has formed inside the recorder. Take the MD out and leave the recorder in a warm place for several hours until the moisture evaporates.
- ➔ The recorder is not on. Press **⓪** to turn the recorder on.
- ➔ The MD is inserted in the wrong direction. Slide the MD into the disc compartment with the label side up and the arrow pointing towards the opening until the recorder grips it.
- ➔ The MD may not be recorded. Replace the disc with one that has been recorded.

The recorder does not record.

- ➔ The MD is record-protected (“Protected” appears.)
 Close the record-protect slot (see page 7.)
- ➔ The recorder is not connected properly to the sound source. Make connections properly to the sound source.
- ➔ The recording level is not adjusted properly (in case of input through LINE (ANALOG) IN.) Turn REC LEVEL to adjust the recording level properly (see page 11.)
- ➔ A premastered MD is inserted. Replace it with a recordable MD.
- ➔ There is not enough time left on the MD. Replace it with another recordable MD with fewer recorded tracks, or erase unnecessary tracks.
- ➔ There has been a power failure or the AC power cord has been disconnected during recording. Data recorded to that point may be lost. Repeat the recording procedure.

The recorder does not work during synchro-recording.

- ➔ The currently selected CD player type (CD player or video CD player) does not match the CD player being used. Reset the CD player type (see page 14.)

The sound has a lot of static.

- ➔ Strong magnetism from a television or a similar device is interfering with operations. Move the recorder away from the source of strong magnetism.

Note

If the recorder does not operate properly even after you've attempted the prescribed remedies, turn off the power, then reinsert the plug into the power outlet.

Specifications

System	MiniDisc digital audio system
Disc	MiniDisc
Laser	Semiconductor laser ($\lambda = 780 \text{ nm}$) Emission duration: continuous
Laser output	Less than $44.6 \mu\text{W}^*$ * This output is the value measured at a distance of 200 mm from the objective lens surface on the Optical Pick-up Block with 7 mm aperture.
Laser diode properties	Material: GaAlAs
Revolutions (CLV)	400 rpm to 900 rpm
Error correction	Advanced Cross Interleave Reed Solomon Code (ACIRC)
Sampling frequency	44.1 kHz
Coding	Adaptive Transform Acoustic Coding (ATRAC)
Modulation system	EFM (Eight-to-Fourteen Modulation)
Number of channels	2 stereo channels
Frequency response	5 to 20,000 Hz $\pm 0.5 \text{ dB}$
Signal-to-noise ratio	Over 92 dB during playback
Wow and flutter	Below measurable limit

Inputs

	Jack type	Input impedance	Reference input	Maximum input
ANALOG (BAL) IN	XLR3-31 equivalent	30 kilohms	+4dBu	+24dBu
ANALOG (UNBAL) IN	Phono jacks	47 kilohms	-4 dBu	+12 dBu
DIGITAL COAXIAL IN	Phono jacks	75 ohms	0.5Vp-p $\pm 20\%$	—

Outputs

	Jack type	Reference output	Load impedance
PHONES	Stereo phone jack	0-10 mW The level varies.	32 ohms
ANALOG (BAL) OUT	XLR3-32 equivalent	Maximum +24/+10 dBu (Switchable)	Over 600 ohms
ANALOG (UNBAL) OUT	Phono jacks	Maximum +8 dBu	Over 10 kilohms
DIGITAL COAXIAL OUT	Phono jacks	0.5Vp-p (at 75 ohms)	75 ohms

0 dBu = 0.775 Vrms

General

Power requirements	Refer to warning letter.
Power consumption	European models: 15W USA models: 14W
Dimensions (approx.) (w/h/d) incl. projecting parts	$482 \times 44 \times 376 \text{ mm}$ ($19 \times 1 \frac{3}{4} \times 14 \frac{7}{8} \text{ in.}$)
Mass (approx.)	5.3 kg (11 lbs 11 oz)

Supplied accessories See page 4.

Optional accessories

Wired/Wireless remote unit: RM-D5ME
Coaxial digital connecting cable: VMC-10, etc.
Recordable MDs: MDW-60 (60 min), MDW-74 (74 min)
Relay record/playback connecting cable (such as RK-G136)

U.S. and foreign patents licensed from Dolby Laboratories Licensing Corporation.

Design and specifications are subject to change without notice.

Index of Parts and Controls

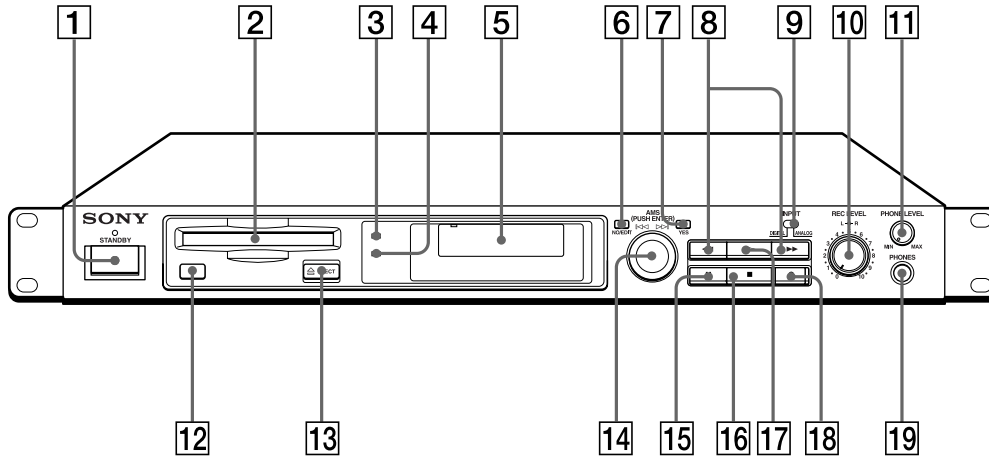

- | | | | |
|----|-----------------------------------|----|---------------------|
| 1 | ⓪ (power) switch | 11 | PHONE LEVEL control |
| 2 | Disc compartment | 12 | Remote sensor |
| 3 | REC indicator | 13 | ⊞ EJECT button |
| 4 | TOC indicator | 14 | AMS control |
| 5 | Display | 15 | ⏸ (pause) button |
| 6 | EDIT/NO button | 16 | ■ (stop) button |
| 7 | YES button | 17 | ▶ (play) button |
| 8 | ⏮/⏭ (fast forward/rewind) buttons | 18 | ● (record) button |
| 9 | INPUT selector | 19 | PHONES jack |
| 10 | REC LEVEL control | | |

Guide to the Serial Copy Management System

This MD recorder uses the Serial Copy Management System, which allows only first-generation digital copies to be made of premastered software via the recorder's digital input jack. An outline of this system appears below:

- 1 You can record from digital program sources (CDs, DATs or premastered MDs) onto a DAT tape or recordable MD via digital input jack on the DAT or MD recorder. You cannot, however, record from this recorded DAT tape or MD onto another DAT tape or recordable MD via the digital input jack on the DAT or MD recorder.

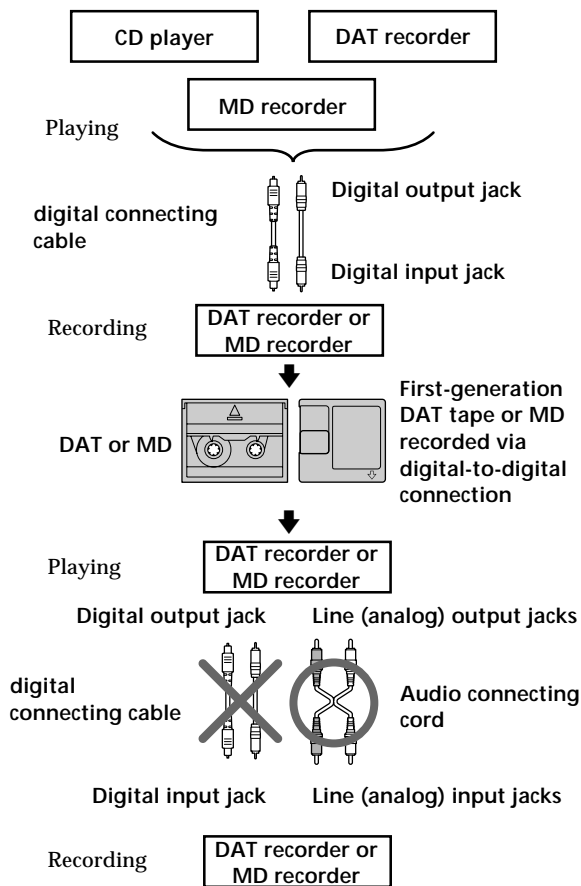

- 2 You can record the digital input signal of a digital satellite broadcast onto a DAT tape or recordable MD via the digital input jack on the DAT or MD recorder which is capable of handling a sampling frequency of 32 kHz or 48 kHz. You can then record the contents of this recorded DAT tape or recordable MD (first-generation) onto another DAT tape or recordable MD via digital input jack on the DAT or MD recorder to create a second-generation digital copy. Subsequent recording from the second-generation copy onto another recordable DAT tape or MD is possible only through the analog input jack on the DAT or MD recorder. Note, however, that on some BS tuners, second-generation digital copying may not be possible.

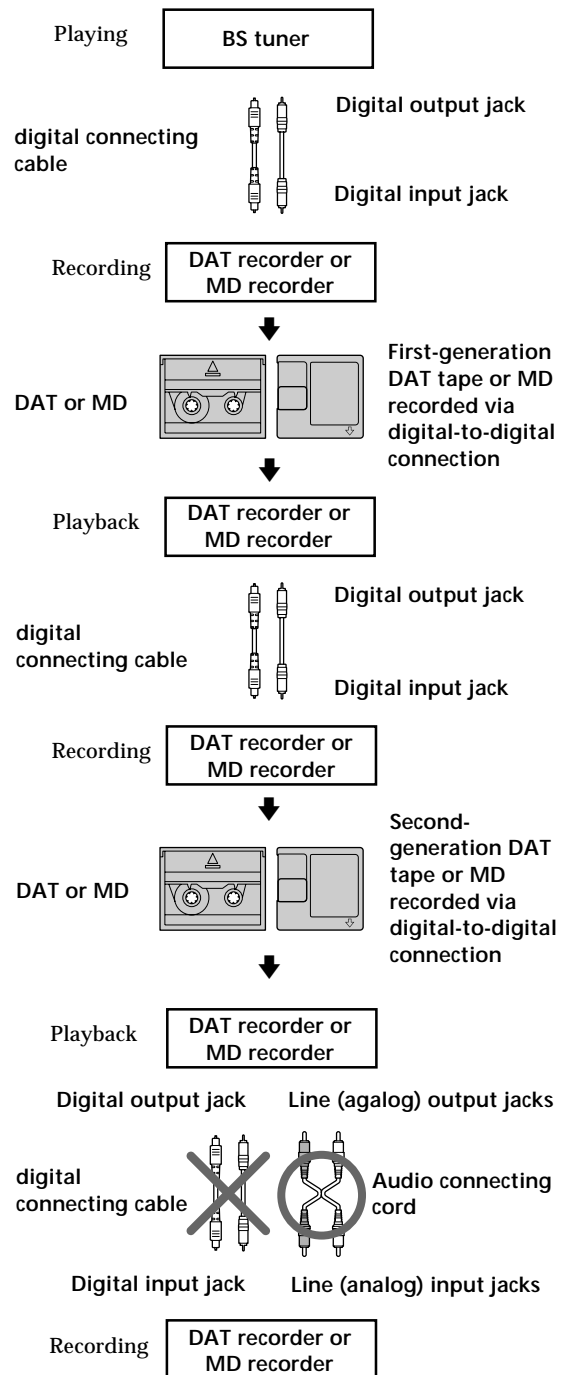

(Continued)

3 You can record a DAT tape or MD recorded via the DAT or MD recorder's analog input jack onto another DAT tape or MD via the DAT or MD recorder's digital output jack. You cannot, however, make a second-generation DAT tape or MD copy via the DAT or MD recorder's digital output jack.

