

LCD Digital Color TV

Operating Instructions

BRAVIA

KDL-40XBR2

KDL-40XBR3

KDL-46XBR2

KDL-46XBR3

XBR

Owner's Record

The model and serial numbers are located at the rear of the TV. Record these numbers in the spaces provided below. Refer to them whenever you call upon your Sony dealer regarding this product.

Model No. _____

Serial No. _____

For Your Convenience

Please contact Sony directly if you:

- Have questions on the use of your television after reading your manual
- Experience difficulty operating your television

Contact Sony Customer Support at:

<http://www.sony.com/tvsupport>

or to speak with a support representative:

United States

1-800-222-SONY (7669)

8:00 AM - 10:00 PM (EST) Mon - Fri

10:30 AM - 7:15 PM (EST) Sat - Sun

Canada

1-877-899-SONY (7669)

8:00 AM - 6:00 PM (Eastern)

8:00 AM - 5:00 PM (Western)

Sony will work to resolve your questions more quickly than your retailer or place of purchase.

Please Do Not Return the Product to the Store

WARNING

To reduce the risk of fire or electric shock, do not expose this apparatus to rain or moisture.



This symbol is intended to alert the user to the presence of uninsulated “dangerous voltage” within the product’s enclosure that may be of sufficient magnitude to constitute a risk of electric shock to persons.



This symbol is intended to alert the user to the presence of important operating and maintenance (servicing) instructions in the literature accompanying the appliance.

The apparatus shall not be exposed to dripping or splashing and no objects filled with liquids, such as vases, shall be placed on the apparatus.

CAUTION

To prevent electric shock, do not use this polarized AC plug with an extension cord, receptacle or other outlet unless the blades can be fully inserted to prevent blade exposure.

Note on Caption Vision

This TV provides display of TV closed captioning in accordance with §15.119 of the FCC rules.

Declaration of Conformity

Trade Name: SONY
 Model: KDL-40XBR2/KDL-46XBR2/
 KDL-40XBR3/KDL-46XBR3
 Responsible Party: Sony Electronics Inc.
 Address: 16530 Via Esprillo
 San Diego, CA 92127 U.S.A.
 Telephone Number: 858-942-2230

This device complies with part 15 of the FCC rules. Operation is subject to the following two conditions: (1) This device may not cause harmful interference, and (2) this device must accept any interference received, including interference that may cause undesired operation.

NOTIFICATION

This equipment has been tested and found to comply with the limits for a Class B digital device, pursuant to Part 15 of the FCC Rules. These limits are designed to provide reasonable protection against harmful interference in a residential installation. This equipment generates, uses and can radiate radio frequency energy and, if not installed and used in accordance with the instructions, may cause harmful interference to radio communications. However, there is no guarantee that interference will not occur in a particular installation. If this equipment does cause harmful interference to radio or television reception, which can be determined by turning the equipment off and on, the user is encouraged to try to correct the interference by one or more of the following measures:

- Reorient or relocate the receiving antenna.
- Increase the separation between the equipment and receiver.
- Connect the equipment into an outlet on a circuit different from that to which the receiver is connected.
- Consult the dealer or an experienced radio/TV technician for help.

Pursuant to FCC regulations, you are cautioned that any changes or modifications not expressly approved in this manual could void your authority to operate this equipment.

For Customers in Canada

This Class B digital apparatus complies with Canadian ICES-003.

Safety

- Operate the TV only on 120-240 V AC.
- The plug is designed, for safety purposes, to fit into the wall outlet only one way. If you are unable to insert the plug fully into the outlet, contact your dealer.
- If any liquid or solid object should fall inside the cabinet, unplug the TV immediately and have it checked by qualified service personnel before operating it further.
- If you will not be using the TV for several days, disconnect the power by pulling the plug itself. Never pull on the cord.
- For details concerning safety precautions, see “Important Safety Instructions” on page 4.

Installing

- The TV should be installed near an easily accessible power outlet.
- To prevent internal heat buildup, do not block the ventilation openings.
- Do not install the TV in a hot or humid place, or in a place subject to excessive dust or mechanical vibration.
- Avoid operating the TV at temperatures below 41°F (5°C).

- If the TV is transported directly from a cold to a warm location, or if the room temperature changes suddenly, the picture may be blurred or show poor color due to moisture condensation. In this case, please wait a few hours to let the moisture evaporate before turning on the TV.
- To obtain the best picture, do not expose the screen to direct illumination or direct sunlight. It is recommended to use spot lighting directed down from the ceiling or to cover the windows that face the screen with opaque drapery. It is desirable to install the TV in a room where the floor and walls are not of a reflective material.

CAUTION

Use the following Sony appliance(s) only with the following WALL-MOUNT BRACKET.

	Sony Appliance Model No.	
	KDL-40XBR2 KDL-46XBR2	KDL-40XBR3 KDL-46XBR3
Sony Wall-Mount Bracket Model No.	SU-WL51	

Use with other WALL-MOUNT BRACKET may cause instability and possibly result in injury.

To Customers

Sufficient expertise is required for installing the specified product. Be sure to subcontract the installation to Sony dealers or licensed contractors and pay adequate attention to safety during the installation.

For Customers in the United States

This product contains mercury. Disposal of this product may be regulated if sold in the United States. For disposal or recycling information, please contact your local authorities or the Electronics Industries Alliance (<http://www.eiae.org>).

Note

This television includes a QAM demodulator which should allow you to receive unscrambled digital cable television programming via subscription service to a cable service provider. Availability of digital cable television programming in your area depends on the type of programming and signal provided by your cable service provider.

(Continued)

Trademark Information

TruSurround XT, SRS and (●) symbol are trademarks of SRS Labs, Inc. TruSurround XT technology is incorporated under license from SRS Labs, Inc.

Manufactured under license from BBE Sound, Inc.

Licensed by BBE Sound, Inc. under one or more of the following US patents: 5510752, 5736897. BBE and BBE symbol are registered trademarks of BBE Sound, Inc.

Macintosh is a trademark licensed to Apple Computer, Inc., registered in the U.S.A and other countries.

Blu-ray Disc is a trademark.

“BRAVIA” and BRAVIA are trademarks of Sony Corporation.

This TV incorporates High-Definition Multimedia Interface (HDMI™) technology. HDMI, the HDMI logo and High-Definition Multimedia Interface are trademarks or registered trademarks of HDMI Licensing LLC.



Manufactured under license from Dolby Laboratories. “Dolby” and the double-D symbol are DIGITAL trademarks of Dolby Laboratories.



Important Safety Instructions

- 1) Read these instructions.
- 2) Keep these instructions.
- 3) Heed all warnings.
- 4) Follow all instructions.
- 5) Do not use this apparatus near water.
- 6) Clean only with dry cloth.
- 7) Do not block any ventilation openings. Install in accordance with the manufacturer’s instructions.
- 8) Do not install near any heat sources such as radiators, heat registers, stoves, or other apparatus (including amplifiers) that produce heat.
- 9) Do not defeat the safety purpose of the polarized or grounding-type plug. A polarized plug has two blades with one wider than the other. A grounding type plug has two blades and a third grounding prong. The wide blade or the third prong are provided for your safety. If the provided plug does not fit into your outlet, consult an electrician for replacement of the obsolete outlet.
- 10) Protect the power cord from being walked on or pinched particularly at plugs, convenience receptacles, and the point where they exit from the apparatus.
- 11) Only use attachments/accessories specified by the manufacturer.
- 12) Use only with the cart, stand, tripod, bracket, or table specified by the manufacturer, or sold with the apparatus. When a cart is used, use caution when moving the cart/apparatus combination to avoid injury from tip-over.
- 13) Unplug this apparatus during lightning storms or when unused for long periods of time.
- 14) Refer all servicing to qualified service personnel. Servicing is required when the apparatus has been damaged in any way, such as power-supply cord or plug is damaged, liquid has been spilled or objects have fallen into the apparatus, the apparatus has been exposed to rain or moisture, does not operate normally, or has been dropped.



USE

For the TV with a three-wire grounding type AC power cord plug (Class 1 unit)

This TV must be connected to an AC power socket outlet with a protective earthing connection.

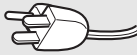

AC power cord

If you damage the AC power cord, it may result in a fire or an electric shock. If the AC power cord is damaged, stop using it and ask your dealer or Sony service center to exchange it.

- Do not place the TV where the power cord is subject to wear or abuse.
- Do not pinch, bend, or twist the cord excessively. The core lines may be bared and cut, and cause a short-circuit, resulting in a fire or an electric shock.
- Do not convert or damage the power cord.
- Do not allow anything to rest on or roll over the power cord.
- Do not pull the power cord.
- Do not move the TV with the power cord plugged in.
- Keep the power cord away from heat sources.
- Be sure to grasp the plug when disconnecting the power cord.

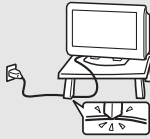

Wall outlet

Do not use a poor fitting outlet.

Insert the plug fully into the outlet. If it is loose, it may cause arcing and result in a fire.

Contact your electrician to have the outlet changed.



Wiring

For your safety, unplug the AC power cord when wiring cables.

Cable wiring

Take care not to catch your feet on the cables. It may damage the TV.

Electric shock

Do not touch the AC power cord or the TV with a wet hand. If you plug/unplug the AC power cord from the TV with a wet hand, it may cause electric shock.



Lightning

For added protection for this TV during a lightning storm, or when it is left unattended and unused for long periods of time, unplug it from the wall outlet and disconnect the antenna. This will prevent damage to the receiver due to lightning and power line surges.

ANTENNA

Outdoor Antenna Grounding

If an outdoor antenna is installed, follow the precautions below. An outdoor antenna system should not be located in the vicinity of overhead power lines or other electric light or power circuits, or where it can come in contact with such power lines or circuits.

WHEN INSTALLING AN OUTDOOR ANTENNA SYSTEM, EXTREME CARE SHOULD BE TAKEN TO KEEP FROM CONTACTING SUCH POWER LINES OR CIRCUITS AS CONTACT WITH THEM IS ALMOST INVARIABLY FATAL.

Be sure the antenna system is grounded so as to provide some protection against voltage surges and built-up static charges.

Section 810 of the National Electrical Code (NEC) in the USA and Section 54 of the Canadian Electrical Code in Canada provides information with respect to proper grounding of the mast and supporting structure, grounding of the lead-in wire to an antenna discharge unit, size of

grounding conductors, location of antenna discharge unit, connection to grounding electrodes, and requirements for the grounding electrode.

Antenna Grounding According to the National Electrical Code, ANSI/NFPA 70

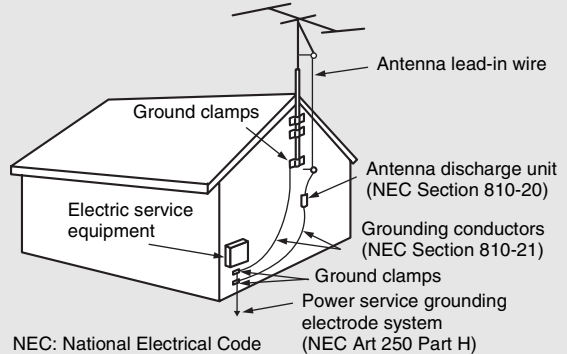

BATTERIES

- Do not dispose of batteries in a fire.
- Do not short circuit, disassemble or overheat the batteries.
- Danger of explosion if battery is incorrectly replaced. Replace only with the same or equivalent type.

Disposal of used batteries

To preserve our environment, dispose of used batteries according to your local laws or regulations.

CLEANING

- Clean the AC power plug regularly. If the plug is covered with dust and it picks up moisture, its insulation may deteriorate and result in a fire. Unplug the AC power plug and clean it regularly.
- Unplug the AC power cord when cleaning this TV. If not, it may result in electric shock.
- Clean the cabinet of the TV with a dry soft cloth. To remove dust from the screen, wipe it gently with a soft cloth. Stubborn stains may be removed with a cloth slightly dampened with a solution of mild soap and warm water. Never use strong solvents such as thinner or benzine for cleaning.
- If using a chemically pretreated cloth, please follow the instruction provided on the package.



MAGNETIC INFLUENCE

This TV contains a strong magnet in the speaker unit that generates a magnetic field. Keep any items susceptible to magnetic fields away from the speaker.

SOUND

If a snapping or popping sound from the TV is continuous or frequent while the TV is operating, unplug the TV and consult your dealer or service technician. It is normal for some TVs to make occasional snapping or popping sounds, particularly when being turned on or off.



(Continued)

VENTILATION

The slots and openings in the TV are provided for necessary ventilation. To ensure reliable operation of the TV, and to protect it from overheating, these slots and openings must never be blocked or covered.

Unless proper ventilation is provided, the TV may gather dust and get dirty. For proper ventilation, observe the following:

- Do not install the TV face up or down or sideways.
- Do not install the TV turned over or upside down.
- Never cover the slots and openings with a cloth or other materials.
- Never block the slots and openings by placing the TV on a bed, sofa, rug or other similar surface.
- Never place the TV in a confined space, such as a bookcase or built-in cabinet, unless proper ventilation is provided.

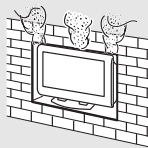

When installing the TV on a wall, allow this much space:

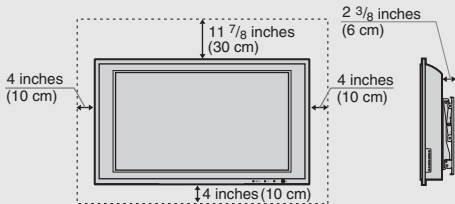

When installing the TV using a stand, allow this much space:

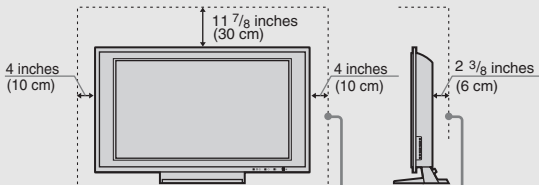

Leave at least this much space.

Never install the TV as follows:

Air circulation is blocked.

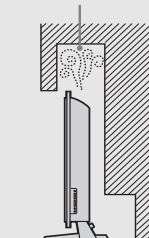

Air circulation is blocked.

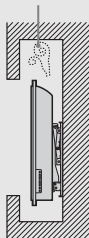

Objects and ventilation holes

Never push objects of any kind into the TV through the cabinet slots as they may touch dangerous voltage points or short out parts that could result in a fire or an electric shock. Never spill liquid of any kind on the TV.

Do not place any objects on the TV.

The TV shall not be exposed to dripping or splashing and no objects filled with liquids, such as vases, shall be placed on the TV.



MOISTURE

Moisture and flammable objects

- Do not use power-line operated sets near water — for example, near a bathtub, washbowl, kitchen sink, or laundry tub, in a wet basement, or near a swimming pool, etc. It may result in a fire or an electric shock.
- Do not let this TV get wet. Never spill liquid of any kind on the TV. If any liquid or solid object does fall through, do not operate the TV. It may result in electric shock or damage to the TV. Have it checked immediately by qualified personnel.
- To prevent fire, keep flammable objects or open flame (e.g. candles) away from the TV.



CARRYING THE TV

Carry the TV in the specified manner

Carrying the TV requires at least two people.

If you carry the TV in a manner other than that specified and without the specified number of persons, it may drop and serious injury may result.

- Carry the TV with the specified number of people.
- Carry the TV holding the upper and bottom frames of the TV as illustrated.
- Hold the TV securely when carrying it. As the glass surface of the TV has a special coating, be careful to avoid touching the glass surface as much as possible.
- When transporting, do not subject the TV to shocks or vibration, or excessive force.
- When lifting or moving the TV, be sure to hold the panel firmly as illustrated. Place your palm directly under the panel, from the rear of the TV.

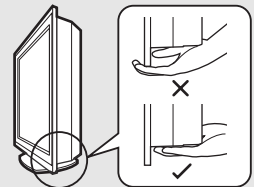

INSTALLATION

When installing or removing, using the Wall-Mount Bracket, be sure to use qualified contractors. Wall mount installation requires the use of a Wall-Mount Bracket. If not properly secured during installation or removal from the Wall-Mount Bracket, the TV may fall and cause serious injury. Please use a qualified contractor when installing or removing.



Placement for viewing

It is recommended to watch the TV at a distance of 3 - 7 times that of the screen height, and in moderate brightness. Watching the TV for too long or in a dark room may cause eye fatigue.

Optional wall mount

Observe the following when installing the TV using a wall-mount bracket. If the TV is not secured properly, it may fall and cause injury.



- Be sure to follow the operating instructions supplied with the wall-mount bracket when installing the TV.
- Be sure to attach the brackets supplied with the wall-mount bracket.
- Do not hang the TV from the ceiling. It may fall and cause serious injury.

Outdoor use

Do not install this TV outdoors. If the TV is exposed to rain, it may result in a fire or an electric shock. If the TV is exposed to direct sunlight, the TV may heat up and cause damage to the TV.



Vehicle

Do not install this TV in a vehicle.

Bumping of the vehicle may cause the TV to fall down and cause injury.



Ship and vessel

Do not install this TV in a ship or vessel. If the TV is exposed to seawater, it may cause a fire or damage the TV.



Corrosion

If you use this TV near the seashore, salt may corrode metal parts of the TV and cause internal damage or fire.

It may also shorten the life of the TV.

Oils

Do not install this TV in restaurants where oily vapors occur. Dust absorbing oil may enter and damage the TV.

Medical institution

Do not place this TV in a place where medical equipment is in use.

It may cause a malfunction of medical instruments.



Preventing the TV from toppling over

Take measures to prevent the TV from toppling over and causing injury. To prevent the TV from toppling over, secure the TV to a wall or pillar.

Installing on a level surface

If you install the TV on an inclined surface, the TV may fall or drop and cause injury or damage.



Placing on a stable surface

If you place the TV on an unstable surface, the TV may fall and cause injury or damage.



Fall

Do not hang anything on the TV.

The TV may fall from the stand or wall-mount, causing damage or serious injury.



Attachments

Do not use attachments not recommended by the manufacturer, as they may cause hazards.



VOLUME ADJUSTMENT

- Adjust the volume so as not to trouble your neighbors. Sound carries very easily at night. Therefore, closing the windows or using headphones is suggested.
- When using headphones, adjust the volume so as to avoid excessive levels, as hearing damage may result.

LCD SCREEN

- Although the LCD screen is made with high-precision technology and has effective pixels of 99.99% or more, black dots or bright points of light (red, blue, or green) may appear constantly on the LCD screen. This is a structural property of the LCD panel and is not a malfunction.
- Do not expose the LCD screen surface to direct sun light. Doing so may damage the LCD panel.
- Do not push or scratch the LCD screen, or place objects on top of the TV. The image may be uneven or the LCD panel may be damaged.
- If the TV is used in a cold place, a smear may occur in the picture or the picture may become dark. This does not indicate a failure. These phenomenon improve as the temperature rises.
- Ghosting may occur when still pictures are displayed continuously. It should disappear after a few moments.
- The screen and cabinet get warm when the TV is in use. This is not a malfunction.
- Avoid spraying insect repellent with volatile material on the screen.
- Avoid prolonged contact with rubber or plastic made material.

Broken pieces

Do not throw anything at the TV.

The screen glass may break by the impact and cause serious injury.

Handling of broken glass and liquid crystal leakage

If the LCD panel gets damaged, crystalline liquid leakage may occur, or scattered broken glass may result. Do not touch broken glass or crystalline liquid (which is toxic), with bare hands as cuts or poisoning/skin irritation may occur. Also, do not let glass fragments or leaked crystalline liquid get into your eyes or mouth. Should either contact your eyes or mouth, rinse the contacted area thoroughly with water and consult your doctor.

(Continued)

SERVICING

Damage requiring service

If the surface of the TV cracks, do not touch the TV until you unplug the AC power cord.

Otherwise electric shock may result.

Servicing

Do not attempt to service the TV yourself since opening the cabinet may expose you to dangerous voltage or other hazards. Refer all servicing to qualified service personnel.



Replacement parts

When replacement parts are required, be sure the service technician certifies in writing that he/she has used replacement parts specified by the manufacturer that have the same characteristics as the original parts.

Unauthorized substitutions may result in a fire, an electric shock or other hazards.



Safety check

Upon completion of any service or repairs to the TV, ask the service technician to perform routine safety checks (as specified by the manufacturer) to determine that the TV is in safe operating condition, and to so certify.

Should the TV not be repairable, ask a qualified service technician to dispose of the TV.



DISPOSAL OF THE TV

- Do not dispose of the TV with general household waste.
- The LCD contains a small amount of liquid crystal. The fluorescent tube used in this display also contains mercury. Follow your local ordinances and regulations for disposal.

Contents

Getting Started

Welcome to the World of BRAVIA™	11
Connecting the TV	11
Cable System and VHF/UHF Antenna System	11
Cable Box/Digital Cable Box and Antenna.....	12
Cable Box/Digital Cable Box	12
Satellite Receiver and Cable/Antenna.....	13
VCR and Cable	14
VCR and Cable Box/Digital Cable Box.....	15
When Connecting to Optional Equipment	16
Installing the TV	18
Preventing the TV from Toppling Over.....	18
Bundling the Connecting Cables	18
When Installing on a Wall.....	19
Setting Up the Channel List – Initial Setup	20

Basic Operations

Remote Control	21
Programming the Remote Control	25
Using Other Equipment with Your Remote Control	27
TV Controls	30

Using the Menus

Overview of MENU	31
Picture Settings	33
Sound Settings	35
Screen Settings	37
Channel Settings	39
Parental Lock Settings	40
Setup Settings	43
PC Settings	46

Other Information

Troubleshooting	48
PC Input Signal Reference Chart	51
Specifications	52
Index	53

Welcome to the World of BRAVIA™

Thank you for purchasing this Sony LCD Digital Color TV. This manual is for models KDL-40XBR2, KDL-46XBR2, KDL-40XBR3 and KDL-46XBR3. The packing box contains accessories that are listed on page 52.

Connecting the TV

To display clear crisp pictures, you must connect your TV correctly and select the correct **Wide Mode** to display the picture in the correct aspect ratio (see “Changing the Wide Screen Mode” on page 24). It is strongly recommended that you connect the antenna/cable input using the supplied 75-ohm coaxial cable to receive optimum picture quality signal. A 300-ohm twin lead cable can be easily affected by radio noise and the like, resulting in signal deterioration. If you use a 300-ohm twin lead cable, keep it as far away from the TV as possible.

You can also connect a variety of optional equipment to your TV (see page 16). For multiple equipment connections, please refer to the separate Quick Setup Guide.

Cable System and VHF/UHF Antenna System

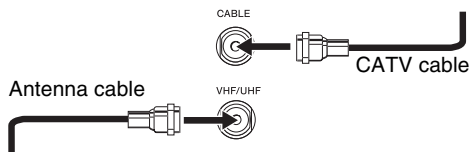

 Press ANT to switch between VHF/UHF and cable.



Cable Box/Digital Cable Box and Antenna

 To change channels using the cable box, set your TV to channel 3 or 4 depending on the cable box channel output.

Use this hookup if

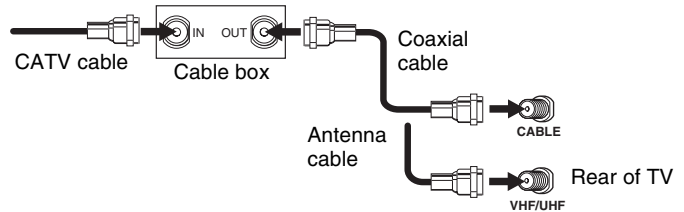
- Your cable company scrambles some channels, such as premium channels. Viewing all channels requires a cable box.
- You do not intend to hook up any other audio or video equipment to your TV.



-  To set up the TV remote control, see “Programming the Remote Control” on page 25.
-  Press SAT/CABLE to begin operating the cable box with the remote control (see page 27). The indicator will light up.
-  Press ANT to switch between VHF/UHF and cable.



Cable Box/Digital Cable Box

 To change channels using the cable box, set your TV to channel 3 or 4 depending on the cable box channel output.

Use this hookup if

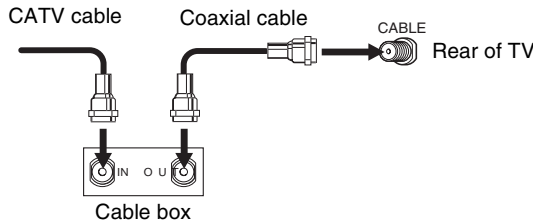
- You subscribe to a cable TV system that uses scrambled or encoded signals requiring a cable box to view all channels, and
- You do not intend to hook up any other audio or video equipment to your TV.



-  To set up the TV remote control, see “Programming the Remote Control” on page 25.
-  Press SAT/CABLE to begin operating the cable box with the remote control (see page 27). The indicator will light up.

Satellite Receiver and Cable/Antenna

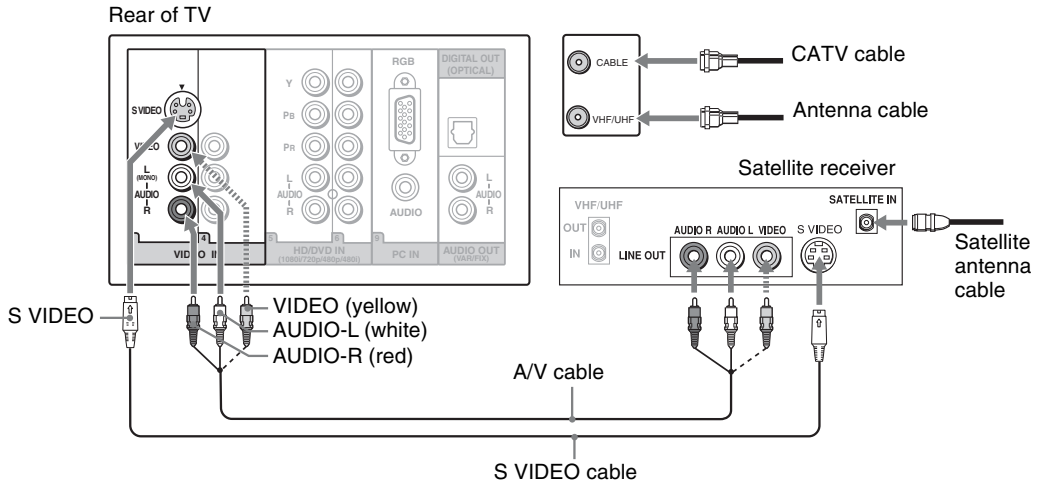

 If your satellite receiver is not equipped with S VIDEO, use a VIDEO cable (yellow) instead of the S VIDEO cable.

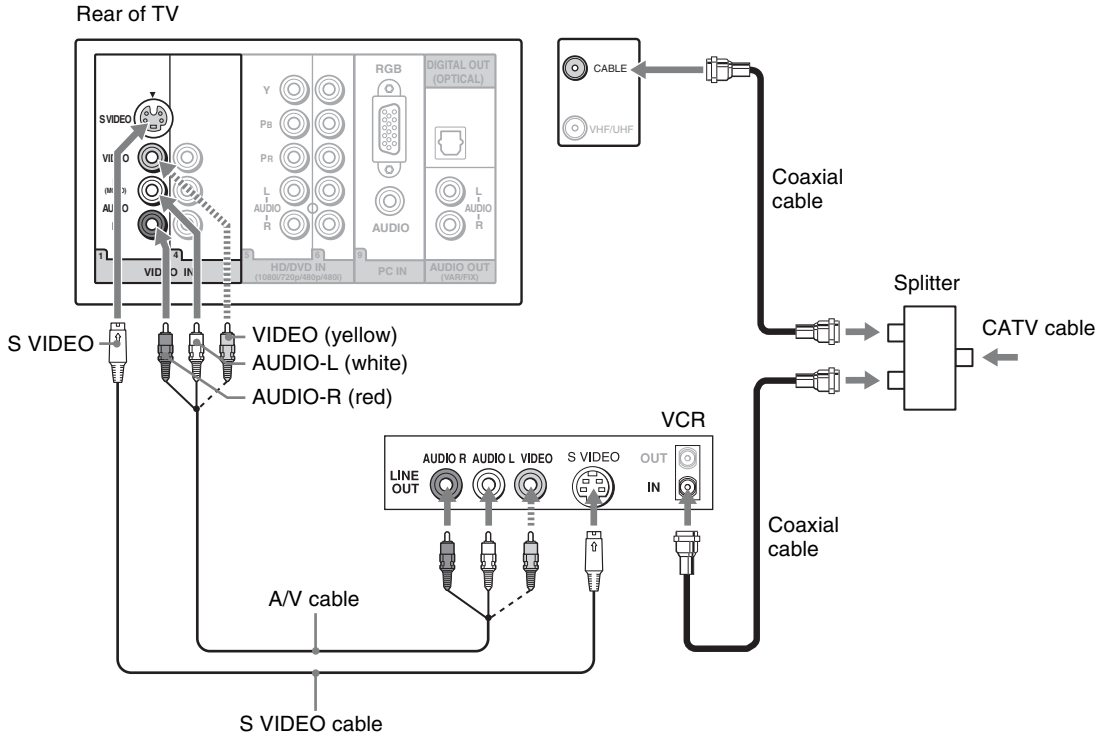

VCR and Cable

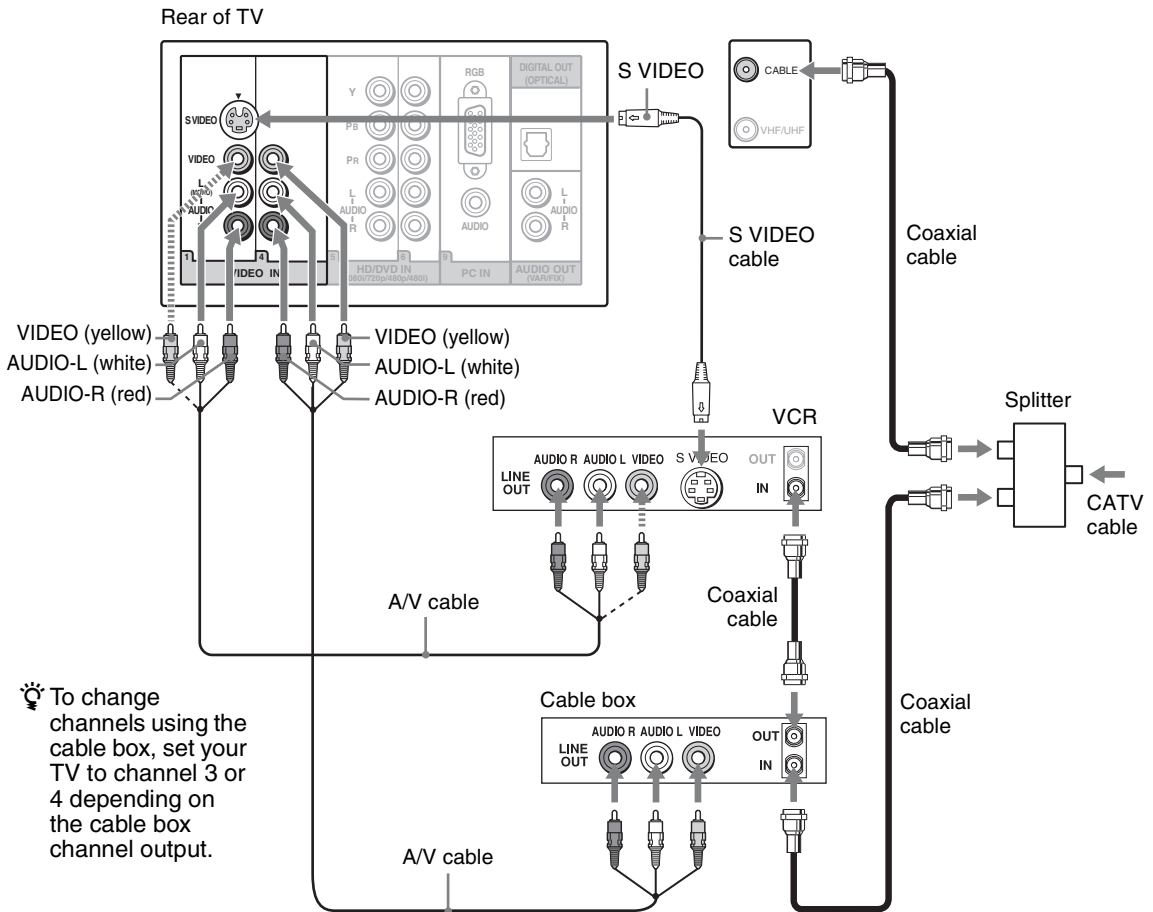

 If your VCR is not equipped with S VIDEO, use a VIDEO cable (yellow) instead of the S VIDEO cable.

VCR and Cable Box/ Digital Cable Box









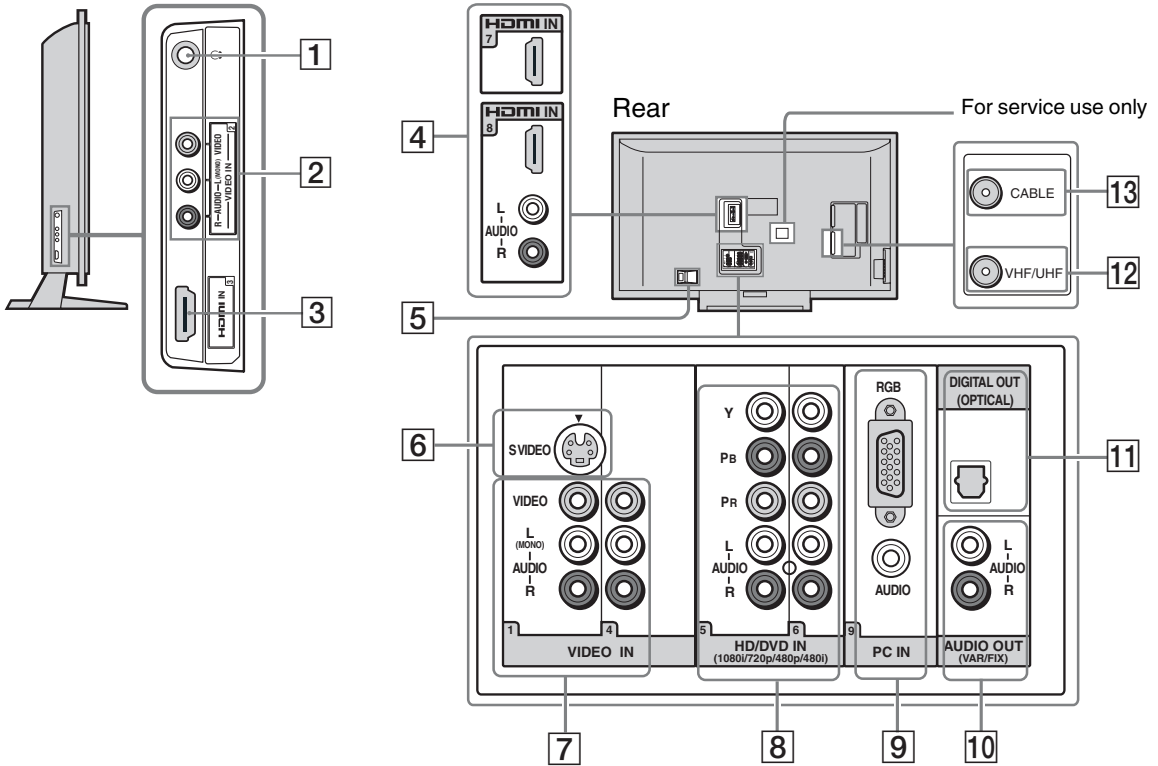

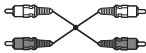

-  If your VCR is not equipped with S VIDEO, use a VIDEO cable (yellow) instead of the S VIDEO cable.
-  If you are connecting a digital cable box, you will need a special bidirectional splitter designed to work with your cable box.

When Connecting to Optional Equipment

Left side



Item	Description
1	Headphones jack Connects to your headphones. If your headphones do not match the jack, use a suitable plug adapter (not supplied).
2	VIDEO IN 2 R-AUDIO- L (MONO)/VIDEO If you have mono equipment, connect its audio output jack to the TV's L (MONO) audio input jack.
3	HDMI IN 3
4	HDMI IN 7/8 HDMI AUDIO IN/ L-R HDMI (High-Definition Multimedia Interface) provides an uncompressed, all-digital audio/video interface between this TV and any HDMI-equipped audio/video equipment, such as a set-top box, Blu-ray Disc™ Player, DVD player, and A/V receiver. HDMI supports enhanced, or high-definition video, plus digital audio. If the equipment has a DVI jack and not an HDMI jack, connect the DVI jack to the HDMI IN 8 (with HDMI-to-DVI cable or adapter) jack, and connect the audio jack to the AUDIO IN(L/R) jacks of HDMI IN 8. (DVI connector is for video signals only.)

Item	Description
	<div style="text-align: center;">  <p>HDMI-to-DVI cable</p>  <p>HDMI adapter</p>  <p>Audio cable</p> </div>
	<ul style="list-style-type: none">  Be sure to use only an HDMI cable that bears the HDMI logo.  Do not connect a PC to the TV's HDMI input. Use the PC IN (RGB IN) input instead when connecting a PC.  HDMI connection is necessary to view 480i, 480p, 720p, 1080i and 1080p formats. Note that this TV displays all format types of picture in a resolution of 1,920 dots × 1,080 lines.
5	AC IN Connects the supplied AC power cord.
6	VIDEO IN 1 S VIDEO Connects to the S VIDEO output jack of your VCR or other video equipment that has S VIDEO. S VIDEO provides better picture quality than composite video (7).
7	VIDEO IN 1/4 VIDEO/L(MONO)- AUDIO-R Connect to the composite video and audio output jacks on your A/V equipment such as a VCR or other video equipment. A third composite video and audio jacks (VIDEO 2) is located on the left side of the TV.
8	HD/DVD IN 5/6 (1080i/720p/ 480p/480i)/ L-AUDIO-R Connect to your equipment's component video (YPbPr) and audio (L/R) jacks. Component video provides better picture quality than the S VIDEO (6) or the composite video (7) connections. <ul style="list-style-type: none">  Component video (YPbPr) connection is necessary to view 480i, 480p, 720p, and 1080i formats. Note that this TV displays all format types of picture in a resolution of 1,920 dots × 1,080 lines.
9	PC IN 9 (RGB/AUDIO) Connect to a personal computer's video output connector using HD15-HD15 cable (analog RGB, supplied). Can also be connected to other analog RGB devices. See "PC Input Signal Reference Chart" on page 51 for the signals that can be displayed. <ul style="list-style-type: none">  For some Apple Macintosh computers, it may be necessary to use an adapter (not supplied). If this is the case, connect the adapter to the computer before connecting the HD15-HD15 cable.  If the picture is noisy, flickering or not clear, adjust the Phase and Pitch of the PC Settings as described on page 47.
10	AUDIO OUT (VAR/FIX) Connect to the left and right audio input jacks of your audio or video equipment. You can use these outputs to listen to your TV's audio through your stereo system. For details, see page 36.
11	DIGITAL OUT (OPTICAL) Connects to the optical audio input of digital audio equipment that is PCM/Dolby* digital compatible. (DIGITAL OUT (OPTICAL) is only available for digital channels.)
12	VHF/UHF Connects to your VHF/UHF antenna.
13	CABLE Connects to your cable signal. This CABLE input jack, in conjunction with the VHF/UHF input jack, lets you set up your TV to switch between scrambled channels (coming through a cable box) and unscrambled cable channels. For details, see page 11. <ul style="list-style-type: none">  VHF/UHF input receives over-the-air broadcast signal frequencies and CABLE input receives CATV signal frequencies.

* Manufactured under license from Dolby Laboratories. "Dolby" and the double-D symbol are trademarks of Dolby Laboratories.



Installing the TV

Preventing the TV from Toppling Over

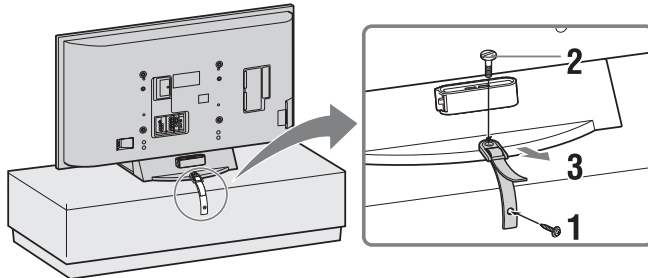
Attaching the Support Belt





- 1 Screw the support belt (supplied) to the TV stand with a wood screw (supplied).
- 2 Attach the support belt to the stand with the securing screw (supplied) using a coin, etc.
- 3 Adjust the length by pulling the support belt toward you while holding the TV stand.

-  Be sure to take measures to prevent the TV from toppling over and causing injury.
-  The supplied wood screw may not be used depending on the type of TV stand. In this case, or when the securing strength is not enough, use commercial screws 3 to 4 mm (1/8 to 3/16 inches) diameter to fit to the TV stand. Consult your dealer about the types of screw.

Bundling the Connecting Cables

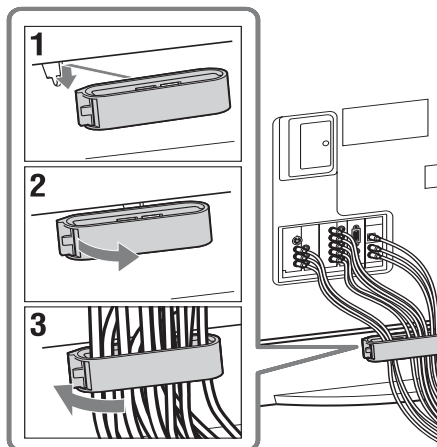
You can bundle the connecting cables as illustrated below.



-  Do not bundle the AC power cord with other connecting cables.

When Installing on a Wall

This TV can be installed on a wall by using a wall-mount bracket (sold separately). Be sure to use the specified Wall-Mount Bracket (see page 3). Before mounting the TV on a wall, you must remove the Table-Top Stand from the TV. Follow the steps below to remove the Table-Top Stand, and then use the instruction guide that came with the Wall-Mount Bracket (sold separately) to mount the TV on the wall.

 Do not remove the Table-Top Stand for any reason other than to wall-mount the TV.

Follow the simple steps below to remove the Table-Top Stand:

- 1** Disconnect all the cables from the TV.
- 2** Start removing the screws from the ones on top. (See illustration below) Do not remove any other screws from the TV.
- 3** When screws are removed, lift the TV out. Make sure that you carry out this task with two people. Do not attempt to lift the TV by yourself.



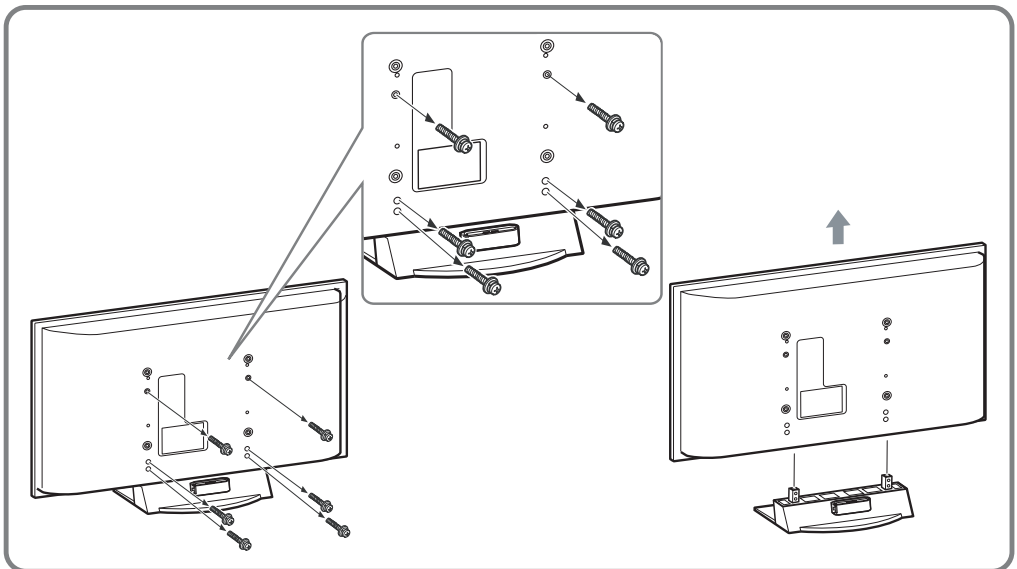

For bracket installation, refer to the instruction guide provided by the Wall-Mount Bracket model for your TV. Sufficient expertise is required in installing this TV, especially to determine the strength of the wall for withstanding the TV's weight. **For product protection and safety reasons, Sony strongly recommends that you use the Wall-Mount Bracket model designed for your TV and the wall-mounting of your TV should be performed by Sony dealers or licensed contractors.**



 Be sure to store the removed screws and Table-Top Stand in a safe place until you are ready to reattach the Table-Top Stand. Keep the screws away from small children.

Setting Up the Channel List – Initial Setup

After you finish connecting the TV, you can run the **Initial Setup** to create a list of available analog and digital channels. The **Initial Setup** screen appears when you turn on the TV for the first time after hooking it up.

- 1 Press ^{TV POWER}  to turn on the TV.
The **Initial Setup** screen appears.
- 2 Press  to highlight the on-screen display language. Then press . The message “Start auto program now?” appears.
- 3 Press  to highlight “Yes” then press .

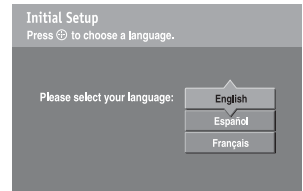

Auto Program performed through **Initial Setup** will automatically create a list of receivable channels from both VHF/UHF antenna and cable TV channels if both sources are connected.

If you choose to set up the channels at a later time, select the **Auto Program** option in the **Channel** settings to scan available channels (see page 39).

 If you select “No” during **Initial Setup**, the **Initial Setup** screen will reappear each time you turn on the TV until you complete **Auto Program**.

Basic Operations

Remote Control

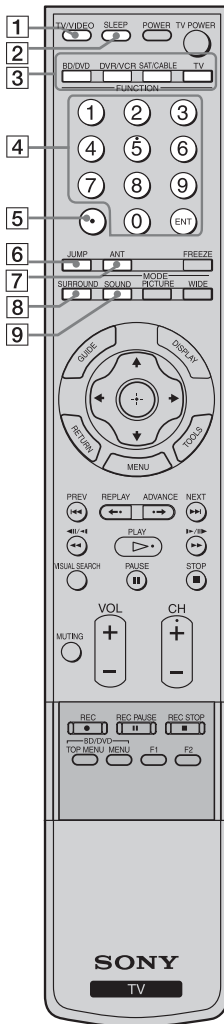

Button	Description
1 TV/VIDEO	Press repeatedly to cycle through the video inputs. See page 43 for information on setting up the video input labels, including the Skip function.
2 SLEEP	Press repeatedly until the TV displays the time in minutes (Off, 15, 30, 45, 60, 90 or 120) that you want the TV to remain on before shutting off. To cancel Sleep, press SLEEP repeatedly until Off appears.
3 FUNCTION Buttons	The FUNCTION button indicator lights up momentarily when pressed to show which external equipment the remote control is operating. When the remote control is set to operate the external equipment, these buttons will operate the equipment you choose. You must first press one of these FUNCTION buttons to operate the corresponding equipment. See page 25 for programming the remote control.
4 0 - 9, ENT	Press 0 - 9 to select a channel; the channel changes after two seconds. Press ENT to change channels immediately.
5	Use with the 0-9 and ENT buttons to select digital channels. For example, to enter 2.1, press (2), (.), (1) and ENT.
6 JUMP	Press to jump back and forth between two channels. The TV alternates between the current channel and the last channel that was selected.
7 ANT	Press to change between the VHF/UHF input and the CABLE input.
8 SURROUND	Press to select TruSurround XT audio effect or Off to turn this feature off.
9 SOUND	Press to cycle through different sound settings: Dynamic for enhanced treble and bass, Standard for spoken dialog and Custom for flat setting.

The 5 button, CH + button and PLAY button have a tactile dot. Use the tactile dot as a reference when operating the TV.

Insert two size AA (R6) batteries (supplied) by matching the and on the batteries to the diagram inside the remote control's battery compartment.

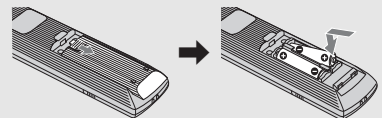

(Continued)

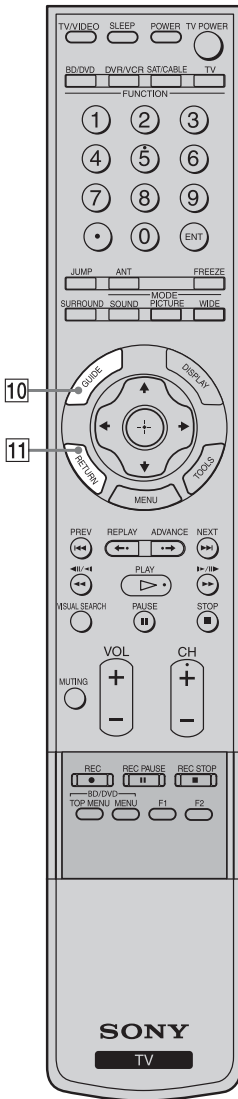

Button **Description**

10 **GUIDE** Press to display the guide when you are watching analog or digital channels.

Using the Guide

The guide allows you to select the channels from a channel list. The guide also provides information about the current program being shown on each channel (if information is available from the station).

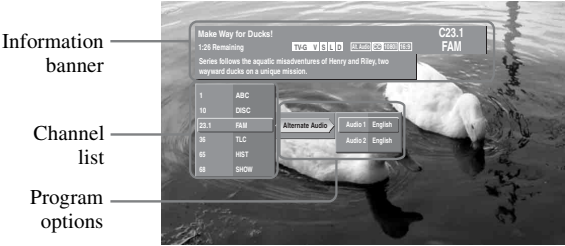

Program information in the guide is provided by the broadcasters. As a result, it may sometimes include only the channel number, without a program title or description.

Using the Program Options Setting

The program options setting allows you to customize the program settings on the currently tuned channel.

Alternate Audio Each program has a main video and audio stream (the video or audio you see or hear when the channel is first tuned), and may have alternate streams. This option allows you to select from the alternate audio stream, when the broadcaster provides an alternate audio stream (for instance, the audio may contain a different language).

11 **RETURN** Press to go back to the previous screen when displaying MENU items and settings.

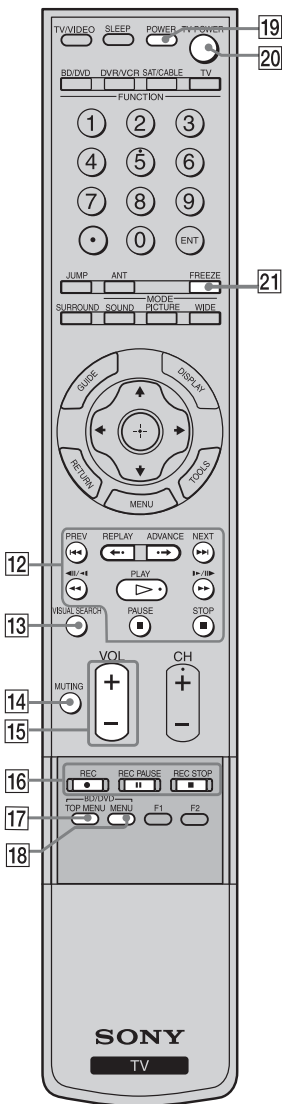

Button	Description
12	<p>BD/DVD or DVR/VCR Operating Buttons</p> <p>When FUNCTION is switched on BD (Blu-ray Disc)/DVD or DVR/VCR, these buttons operate the video equipment you have programmed into the remote control. For details, see "Using Other Equipment with Your Remote Control" on page 27.</p> <p>◀◀ PREV: Press to replay the current program from the previous chapter mark (if any) or from the beginning of the live TV cache.</p> <p>◀◀◀ REPLAY: Press to replay the current program for a set period of time.</p> <p>▶▶ ADVANCE: Press to advance forward a set period of time when playing back a recorded program.</p> <p>▶▶▶ NEXT: Press to advance forward to the next chapter mark (if any) or to live TV when playing back a recorded program.</p> <p>◀◀ (fast reverse): Press to play a program in fast rewind mode.</p> <p>▷ PLAY: Press to play a program at a normal speed.</p> <p>▶▶ (fast forward): Press to play a program in fast forward mode.</p> <p>⏸ PAUSE: Press to pause playback.</p> <p>■ STOP: Press to stop the playback of a recorded program.</p>
13	<p>VISUAL SEARCH</p> <p>Only for Sony DVD recorders with the visual search function. For details, see the operating instructions supplied with the DVD recorder.</p>
14	<p>MUTING</p> <p>Press to mute the sound. Press again or press VOL + to restore the sound.</p> <p><i>✎</i> The MUTING function is not available when Speaker is set to Off, Audio Out is set to Fixed and the headphones are not connected.</p>
15	<p>VOL +/-</p> <p>Press to adjust the volume.</p>
16	<p>DVR/VCR Record Buttons</p> <p>● REC: Press to record. Pressing this button alone starts the recording process.</p> <p>⏸ REC PAUSE: Press to pause the recording.</p> <p>■ REC STOP: Press to stop the recording.</p>
17	<p>BD/DVD TOP MENU</p> <p>Press to display the top menu of the DVD disc. Press to display the DVD disc menu.</p>
18	<p>BD/DVD MENU</p> <p><i>✎</i> For further information, refer to the operating manual of the connected equipment.</p>
19	<p>POWER</p> <p>Press to turn on and off the external equipment selected from the FUNCTION buttons [3].</p>
20	<p>TV POWER</p> <p>Press to turn on and off the TV.</p>
21	<p>FREEZE</p> <p>Press once to display a frozen image of the current program. Press again to return to the program.</p>

Current program in progress

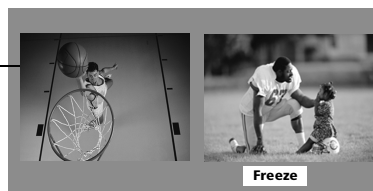

Frozen picture

(Continued)

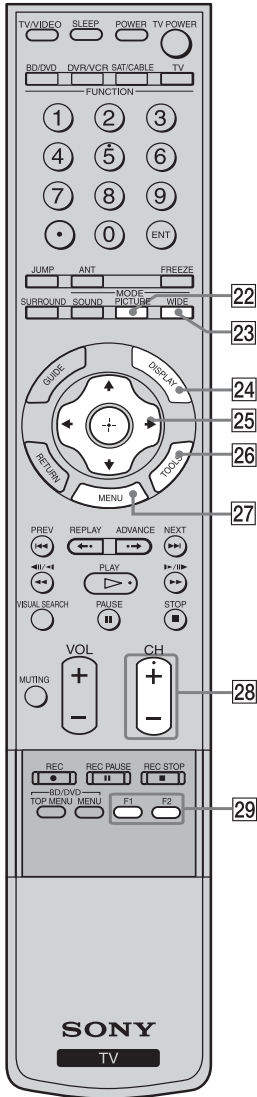

Button	Description										
22 PICTURE	Press repeatedly to cycle through the available picture modes: Vivid, Standard, Custom. The picture modes can be also accessed in the Picture settings. For details, see “Picture Settings” on page 33.										
23 WIDE	Press repeatedly to step through the Wide Mode settings: Wide Zoom, Normal, Full, Zoom. The Wide Mode settings can be also accessed in the Screen settings. See page 37. Changing the Wide Screen Mode										
	<table border="1"> <tr> <td>4:3 Original source Standard definition source </td> <td>16:9 Original source High definition source </td> </tr> <tr> <td>Wide Zoom </td> <td>Wide Zoom </td> </tr> <tr> <td>Normal </td> <td>Normal </td> </tr> <tr> <td>Full </td> <td>Full </td> </tr> <tr> <td>Zoom </td> <td>Zoom </td> </tr> </table>	4:3 Original source Standard definition source 	16:9 Original source High definition source 	Wide Zoom 	Wide Zoom 	Normal 	Normal 	Full 	Full 	Zoom 	Zoom
4:3 Original source Standard definition source 	16:9 Original source High definition source 										
Wide Zoom 	Wide Zoom 										
Normal 	Normal 										
Full 	Full 										
Zoom 	Zoom 										
24 DISPLAY	Press once to display the current channel number, channel label, program-related information (if available), time, Wide Mode settings and remaining sleep time (when Sleep is set, see page 44). The OSD (on screen display) will turn off automatically in a few seconds, or you can press DISPLAY again to turn it off immediately.										
25	Press to move the on-screen cursor. Press to select/confirm an item.										
26 TOOLS	Press to display the Tools menu that is associated with your current input: Picture Mode, Sound Mode, Wide Mode, Add to Favorites, Caption Vision (CC) and Alternate Audio. (See pages 33, 35, 36, 37, 39 and 43.) The menus you can select may vary depending on the input signal.										
27 MENU	Press to display the MENU with TV functions and settings. See “Overview of MENU” on page 31.										
28 CH +/-	Press to scan through channels. To scan quickly through channels, press and hold down either +/-.										
29 F1/F2	Press to select the function of connected components. For details, see “Using Other Equipment with Your Remote Control” on page 27.										

Programming the Remote Control

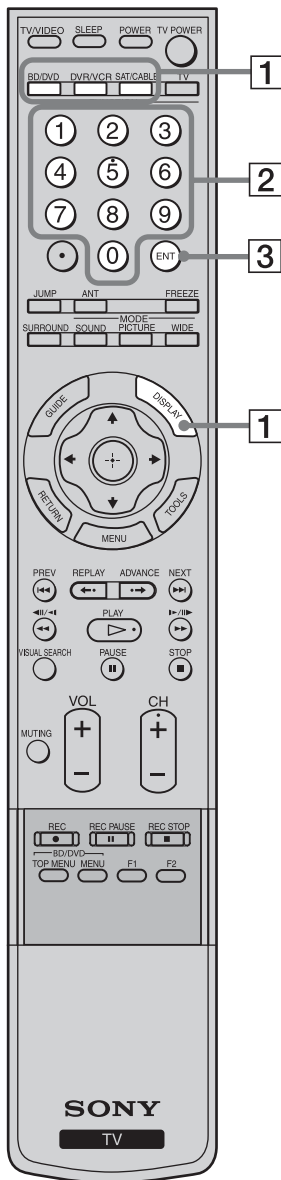

The remote control is preset to operate Sony brand video equipment.

Sony Equipment	Programmable Code Number
BD/DVD	101 (Sony Blu-ray Disc Player)
DVR/VCR	901 (Sony Dream System)
SAT/CABLE	801 (Sony Satellite Receiver)

Follow the steps below to program your TV's remote control to operate non-Sony video equipment.

Find the three-digit code for your equipment from the "Manufacturer's Codes" listed on page 26. If more than one code number is listed, try entering from the code listed first.

- 1** Press and hold the , or FUNCTION button you want to program on the remote control and press the button simultaneously. The selected FUNCTION button (BD/DVD, DVR/VCR or SAT/CABLE) will flash.
- 2** Enter the three-digit manufacturer's code number using the **0-9** buttons while the FUNCTION button is lit. If the code is not entered within 10 seconds, you must start again from step 1.
- 3** Press the **ENT** button while the FUNCTION button is lit.

When the programming is correct, the selected FUNCTION button blinks twice, and when not, blinks five times.

While , and buttons are labeled as such, you can still program any of your connected equipment using any one of the buttons regardless of the label. For example, button can be programmed to operate your VCR. If you have a DVD/VCR combo that you want to operate with your TV remote control, you can program with the or or even the , but remember which button you have programmed for your particular use.

To check if the code works

Aim your TV's remote control at the equipment, and press the green button. If you can turn the equipment on and off by using the remote control, then the programming is complete. If not, try the next code listed.

If no code is input within the above specified time, or an invalid or incorrect code number is input, the remote control automatically goes back to the previous setting.

In some cases, you may not be able to program your remote control to operate other equipment. In such cases, use the equipment's own remote control.

Basic Operations

Manufacturer's Codes

DVD Players

<i>Manufacturer</i>	<i>Code</i>
Sony	751, 763
General	755
Electric/RCA	
Hitachi	758
JVC	756
Magnavox	757
Mitsubishi	761
Oritron	759
Panasonic	753
Philips	757
Pioneer	752, 778
RCA/PROSCAN	755
Samsung	758
Toshiba	754
Zenith	760, 762

DVD/VCR Combo Units

<i>Manufacturer</i>	<i>Code</i>
Sony	767
Broksonic	776
JVC	775
Panasonic	777
Samsung	774
Toshiba	773
Zenith	768

HDD/DVD Combo Units

<i>Manufacturer</i>	<i>Code</i>
Sony	770, 771, 772

DVD Changers

<i>Manufacturer</i>	<i>Code</i>
Sony	765
Panasonic	766

DVR

<i>Manufacturer</i>	<i>Code</i>
Sony	901

Blu-ray Disc Player (BD)

<i>Manufacturer</i>	<i>Code</i>
Sony	101, 102, 103

5.1ch DVD AV System

<i>Manufacturer</i>	<i>Code</i>
Sony (DAV)	601, 602, 603, 604

AV Receivers

<i>Manufacturer</i>	<i>Code</i>
Sony	764

VCRs

<i>Manufacturer</i>	<i>Code</i>
Sony	301, 302, 303 (VHS, 8mm, Beta)

<i>Manufacturer</i>	<i>Code</i>
Sony DV	348
Admiral (M. Ward)	327
Aiwa*	338, 344
Audio Dynamic	314, 337
Broksonic	317, 319
Canon	308, 309
Citizen	332
Craig	302, 332
Curtis Mathes	304, 309, 338
Daewoo	309, 312, 341
DBX	314, 336, 337
Dimensia	304
Emerson	316, 317, 318, 319, 320, 341
Fisher	330, 335
Funai	338
General Electric	304, 309, 329
Go Video	322, 339, 340
Goldstar	332
Hitachi	304, 305, 306, 338
Instant Replay	308, 309
JC Penney	304, 305, 309, 314, 330, 336, 337
JVC	314, 336, 337, 345, 346, 347
Kenwood	314, 332, 336, 337
LG	332
LXI (SEARS)	305, 330, 332, 335, 338
Magnavox	308, 309, 310
Marantz	314, 336, 337
Marta	332
Memorex	309, 335
Minolta	304, 305
Mitsubishi/MGA	323, 324, 325, 326
Multitech	321, 325, 338
NEC	314, 336, 337
Olympic	308, 309
Optimus	327
Orion	317
Panasonic	306, 307, 308, 309
Pentax	304, 305
Philco	308, 309
Philips	308, 309, 310
Pioneer	308
Quasar	306, 308, 309
RCA/PROSCAN	304, 305, 308, 309, 310, 311, 312, 313, 329
Realistic	309, 324, 328, 330, 335, 338
Sansui	314

<i>Manufacturer</i>	<i>Code</i>
Samsung	313, 321, 322
Sanyo	330, 335
Scott	312, 313, 321, 323, 324, 325, 326, 335
Sharp	327, 328
Signature 2000 (M. Ward)	327, 338
SV2000	338
Sylvania	308, 309, 310, 338
Symphonic	338
Tashiro	332
Tatung	314, 336, 337
Teac	314, 336, 337, 338
Technics	308, 309
Toshiba	311, 312
Wards	327, 328, 331, 332, 335
Yamaha	314, 330, 336, 337
Zenith	331

Cable Boxes

<i>Manufacturer</i>	<i>Code</i>
Sony	230
Hamlin/Regal	222, 223, 224, 225, 226
Jerrold/ General Inst./ Motorola	201, 202, 203, 204, 205, 206, 207, 208, 218, 222
Oak	227, 228, 229
Panasonic	219, 220, 221
Pioneer	211, 214, 215
Scientific Atlanta	209, 210, 211
Tocom	216, 217
Zenith	212, 213

Satellite Receivers

<i>Manufacturer</i>	<i>Code</i>
Sony	801
Dish Network	810
Echostar	810
General Electric	802
Hitachi	805
Hughes	804
JVC	810
Mitsubishi	809
Panasonic	803
Philips	811
RCA/PROSCAN	802, 808
Toshiba	806, 807
Samsung	812

* If an Aiwa VCR does not work even though you enter the code for Aiwa, enter the code for Sony instead.

Using Other Equipment with Your Remote Control

To operate other equipment connected to your TV, first turn to page 26 and program the necessary code. For operating video equipment, press TV/VIDEO repeatedly until you see the video input on the screen for your connected equipment. Remote control tips are provided below.

 Some functions cannot be operated depending on the equipment. In that case, operate by the remote control supplied with the equipment.

Operating a Cable Box

To Do This ...	Press ...
Activate the remote control to operate the cable box	SAT/CABLE (FUNCTION)
Turn on/off	POWER

Operating a Satellite Receiver

To Do This ...	Press ...
Activate the remote control to operate the satellite receiver	SAT/CABLE (FUNCTION)
Turn on/off	POWER
Select a channel	0-9, ENT
Change channels	CH +/-
Back to previous channel	JUMP

Operating a VCR

To Do This ...	Press ...
Activate the remote control to operate the VCR	DVR/VCR (FUNCTION)
Turn on/off	POWER
INPUT SELECT	TV/VIDEO
Select a channel	0-9, ENT
Change channels	CH +/-

Operating a DVD Player or DVD Changer

To Do This ...	Press ...
Activate the remote control to operate the DVD	BD/DVD (FUNCTION)
Turn on/off	POWER
If you have a DVD changer, to skip disc	F1
Play	▷
Stop	■
Pause	⏸ (press again to resume normal playback)

To Do This ...	Press ...
Select a channel	0-9, ENT
Change channels	CH +/-
Back to previous channel	JUMP

To Do This ...	Press ...
Display channel number	DISPLAY
Display SAT Guide	GUIDE
Display SAT Menu	MENU
Move highlight (cursor)	⬆ ⬇ ⬇ ⬆
Select item	⊕

To Do This ...	Press ...
Record	●
Play	▷
Stop	■
Fast forward	⏩
Rewind the tape	⏮
Pause	⏸ (press again to resume normal playback)

To Do This ...	Press ...
Step through different tracks of the disc	⏮ to fast reverse or ⏩ to fast forward the disc when pressed during playback
Step through different chapters of the disc	⏭ to step forward or ⏪ to step backward
Select a track directly	0-9, ENT
Display the disc menu or top menu	BD/DVD MENU or TOP MENU
Operate the DVD menu	⬆ ⬇ ⬇ ⬆, ⊕
Display the system MENU	MENU

(Continued)

Basic Operations

Operating a Blu-ray Disc Player (BD)

To Do This ...	Press ...
Activate the remote control to operate the Blu-ray Disc Player	BD/DVD (FUNCTION)
Turn on/off	POWER
Play	▷
Stop	■
Pause	(press again to resume normal playback)

Operating a 5.1ch DVD AV System (Sony DAV)

To Do This ...	Press ...
Activate the remote control to operate the DVD	BD/DVD (FUNCTION)
Turn on/off	POWER
Select other equipment connected to the DAV	F1
Disk skip	F2
Display the disc menu or top menu	BD/DVD MENU or TOP MENU
Select a track directly	0-9, ENT
Play	▷

Operating a DVD/VCR Combo Unit

To Do This ...	Press ...
Activate the remote control to operate the DVD/VCR	DVR/VCR (FUNCTION)
Turn on/off	POWER
Select the DVD	F 1
Select the VCR	F 2
Display the disc menu or top menu	BD/DVD MENU or TOP MENU
Play	▷
Stop	■
Pause	

To Do This ...	Press ...
Step through different tracks of the disc	◀◀ to fast reverse or ▶▶ to fast forward the disc when pressed during playback
Display the POP UP menu (BD)	BD/DVD MENU
Display the disc menu (DVD)	BD/DVD MENU
Display the top menu (BD)	BD/DVD TOP MENU
Display the top menu (DVD)	BD/DVD TOP MENU
Operate the menu	↑ ↓ ← →, (+)

To Do This ...	Press ...
Stop	■
Pause	
Search the picture forward or backward	▶▶ or ◀◀ during playback
Specify the previous chapter/track	◀◀
Specify the next chapter/track	▶▶
Move highlight (cursor)	↑ ↓ ← →
Select item	(+)
Master volume	VOL +/-, MUTING

To Do This ...	Press ...
Search the picture forward or backward	▶▶ or ◀◀ during playback
Move highlight (cursor) and select (DVD)	↑ ↓ ← → (+)
Record (VCR)	●
Change channels (VCR)	CH +/- or 0-9, ENT (using tuner)
Adjust tracking (VCR)	CH +/- (during tape playback)
Index search	◀◀ ▶▶
INPUT SELECT	TV/VIDEO

Operating a HDD/DVD Combo Unit

To Do This ...	Press ...
Activate the remote control to operate the DVD/HDD	DVR/VCR (FUNCTION)
Turn on/off	POWER
Select the HDD Select the DVD	F 1 F 2
Play	▷
Stop	■
Pause	⏸
Search the picture forward or backward	▶▶ or ◀◀ during playback
Move highlight (cursor) and select	↑ ↓ ← → +

Operating an AV Receiver

To Do This ...	Press ...
Activate the remote control to operate the AV Receiver	DVR (FUNCTION)
Turn on/off	POWER

Operating a DVR

To Do This ...	Press ...
Activate the remote control to operate the DVR	DVR/VCR (FUNCTION)
Turn on/off	POWER
Play	▷
Jump back while viewing live or recorded programs	REPLAY
Slow mode	◀◀/◀◀ (press lightly)
Jump forward while viewing recorded programs	•→

To Do This ...	Press ...
Record	●
Record stop	■
Record pause	⏸
Specify the previous chapter/track Specify the next chapter/track	⏮ ⏭
Replay	↶
Advance	•→
Display the disc menu or top menu	BD/DVD MENU or TOP MENU
INPUT SELECT	TV/VIDEO

To Do This ...	Press ...
Master volume	VOL +/-, MUTING
Select other input connected to AV receiver	F1

To Do This ...	Press ...
Jump forward to the next available chapter	⏭
Stop	■
Pause	⏸
Record	●
Record stop	■
Record pause	⏸

TV Controls

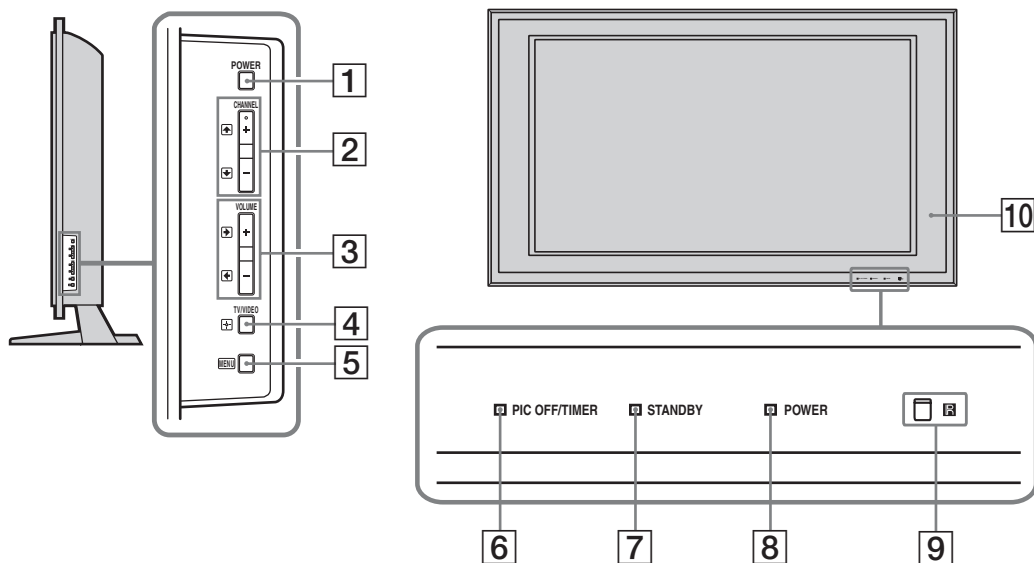

Item	Description
1	POWER Press to turn on and off the TV.
2	CHANNEL +/- Press to scan through channels. To scan quickly through channels, press and hold down either -/+. In the MENU screen, these buttons serve as up/down buttons.
3	VOLUME +/- Press to adjust the volume. In the MENU screen, these buttons serve as left/right buttons.
4	TV/VIDEO Press to cycle through the video inputs. If you set a certain input to Skip in Label Video Inputs, then the input will not appear. For details, see page 43. In the MENU screen, this button serves as confirming the selection or setting.
5	MENU Press to display MENU with TV functions and settings (see “Overview of MENU” on page 31).
6	PIC OFF/TIMER LED Lights up in green when Picture Off is activated. Lights up in orange when the timer is set. When the timer is set, this LED will remain lit even if the TV is turned off. For details, see page 44.
7	STANDBY LED Lights up in red when your TV is in the PC standby mode. If the LED blinks in red continuously, this may indicate the TV needs servicing (see contacting Sony information on page 2).
8	POWER LED Lights up in green when the TV is turned on.
9	(IR) Infrared Receiver/Light Sensor Receives IR signals from the remote control. Do not put anything near the sensor, as its function may be affected.
10	Speaker Outputs the audio signal.

The CHANNEL + button has a tactile dot. Use it as a reference when operating the TV.

Using the Menus

Overview of MENU

MENU provides one-button access for controlling your TV. It enables you to perform a variety of tasks intuitively with a control panel on the screen rather than a variety of remote control button presses. When you press the MENU button, you can select from basic TV functions: External Inputs, Favorites, Cable, Antenna and Settings.

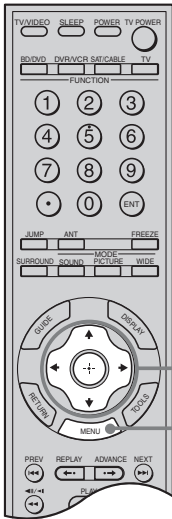

- 1 Press MENU on the remote. The MENU control panel appears.
- 2 Press \uparrow/\downarrow to highlight the item.
- 3 Press \ominus to select an option. Press MENU to exit.

- A dot appears next to the icon of the currently active input (External Inputs, Cable, and Antenna only).
- When the TV is displaying the input from a connected PC, the menu only shows PC settings. For more information about PC settings, see page 46.

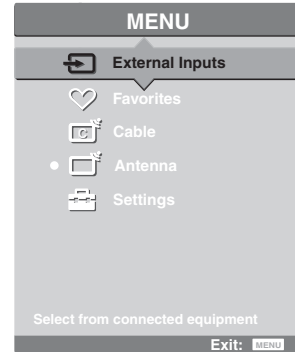

MENU

Description

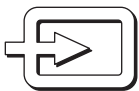

External Inputs





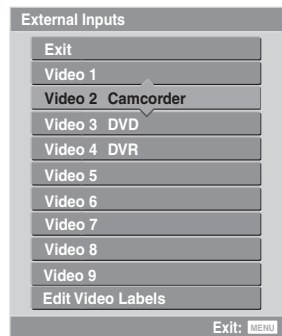



The External Inputs feature lets you select the external inputs connected to your TV. You can also assign a label using Label Video Inputs in the Setup settings (see page 43).

- 1 Highlight External Inputs on the MENU control panel and press \ominus .
- 2 Press \uparrow/\downarrow to highlight the desired external input and press \ominus .



- To display the PC settings, select Video 9 in External Inputs. For more information about PC settings, see page 46.



(Continued)

MENU	Description
 <p data-bbox="99 284 193 309">Favorites</p>	<p data-bbox="337 184 915 244">The Favorites feature lets you select programs from a list of up to 16 favorite channels that you specify.</p> <ol data-bbox="337 249 915 513" style="list-style-type: none"> <li data-bbox="337 249 915 314">1 Highlight Favorites from the MENU control panel and press +. The Favorite Channels list appears. <li data-bbox="337 319 915 513">2 Make your selection by pressing ↑/↓ to highlight the desired channel then press +. To add the current channel to the list of Favorite Channels, highlight Add to Favorites and press +. <div data-bbox="951 201 1229 496" style="border: 1px solid gray; padding: 5px; margin: 10px 0;"> <p style="text-align: center; margin: 0;">Favorite Channels</p> <p style="margin: 2px 0;">Add to Favorites</p> <p style="margin: 2px 0;">5</p> <p style="margin: 2px 0;">12</p> <p style="margin: 2px 0;">23</p> <p style="margin: 2px 0;">Edit Favorites</p> <p style="margin: 2px 0;">Exit</p> <p style="text-align: right; margin: 5px 0;">Exit: MENU</p> </div> <p data-bbox="337 522 1076 586">To manually edit your list of favorite channels, select Edit Favorites. For more information, see page 39.</p>
 <p data-bbox="99 701 158 725">Cable</p>	<p data-bbox="337 591 1193 687">The Cable feature displays the most recently viewed channel on the cable input. When tuned to the channel, the program banner and channel number will be displayed.</p> <div data-bbox="337 696 1229 760" style="border: 1px solid gray; padding: 5px; margin: 10px 0;"> <p data-bbox="337 696 1229 760"> To turn on the program banner, select Settings and set the Info Banner option to On in the Setup settings (see page 43).</p> </div>
 <p data-bbox="99 874 185 899">Antenna</p>	<p data-bbox="337 765 1217 861">The Antenna feature displays the most recently viewed channel on the antenna input. When tuned to the channel, the program banner and channel number will be displayed.</p> <div data-bbox="337 869 1229 933" style="border: 1px solid gray; padding: 5px; margin: 10px 0;"> <p data-bbox="337 869 1229 933"> To turn on the program banner, select Settings and set the Info Banner option to On in the Setup settings (see page 43).</p> </div>
 <p data-bbox="99 1043 185 1067">Settings</p>	<p data-bbox="337 939 1229 1034">The Settings feature lets you enter the settings menu. Settings and adjustments can be performed from the Settings menu. The information on various settings starts from page 33.</p> <p data-bbox="337 1060 662 1090">Navigating Through Settings</p> <ol data-bbox="337 1095 1229 1242" style="list-style-type: none"> <li data-bbox="337 1095 532 1124">1 Press MENU. <li data-bbox="337 1130 505 1159">2 Select . <li data-bbox="337 1164 1229 1194">3 Highlight an item: Picture, Sound, Screen, Channel, Parental Lock, Setup. <li data-bbox="337 1199 696 1242">4 Press + to select an option. <p data-bbox="337 1251 673 1281">To exit Settings, press MENU.</p> <div data-bbox="337 1286 1229 1451" style="border: 1px solid gray; padding: 5px; margin: 10px 0;"> <p data-bbox="337 1286 1229 1347"> The options you can adjust vary depending on the situation. Unavailable options are grayed out or not displayed.</p> <p data-bbox="337 1355 1229 1451"> To display PC settings (see page 46), select Video 9 in External Inputs and switch to PC input. Pressing MENU shows PC settings when the TV is displaying the input from a connected PC.</p> </div>

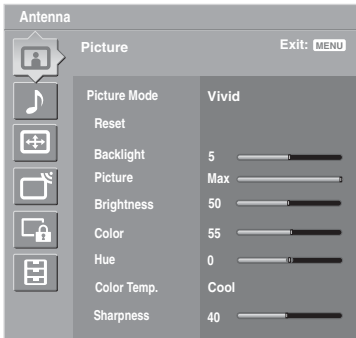



Picture Settings



To display the Picture settings, see “Navigating Through Settings” (see page 32).

Option	Description	
Picture Mode	Vivid	Select for enhanced picture contrast and sharpness.
	Standard	Select for standard picture settings. Recommended for home entertainment.
	Custom	Allows you to store your preferred settings.
	 You can set up a Picture Mode (Vivid, Standard, Custom) independently for the TV input and for each video input (Video 1 to Video 8). Your Picture Mode settings are automatically saved upon selection.	
Reset	Resets the current settings to the default values (except for Advanced Settings).	
Backlight	Adjust to brighten or darken the backlight.	
Picture	Adjust to increase or decrease picture contrast.	
Brightness	Adjust to brighten or darken the picture.	
Color	Adjust to increase or decrease color intensity.	
Hue	Adjust to increase or decrease the green tones.	
Color Temp. <i>White adjustment</i>	Cool	Select to give the white colors a bluish tint.
	Neutral	Select to give the white colors a neutral tint.
	Warm 1, 2	Select to give the white colors a reddish tint. Available only when Picture Mode is set to Custom.
Sharpness	Adjust to sharpen or soften the picture.	
Noise Reduction	Select to reduce the noise level of connected equipment, and the VHF/UHF or cable inputs. Select from Auto, High, Medium, Low and Off.  Auto is not available when you are using either HDMI or component connections.	
DRC Mode	Produces a high-resolution picture for high-density sources (e.g., Blu-ray Disc Player, DVD Player, satellite receiver).	
	Mode 1	Recommended mode.
	Mode 2	Only available for 1080i format. Mode 2 is especially effective when original standard-definition signals have been up-converted to 1080i format.
	Off	Select to turn off DRC Mode.



(Continued)

Option	Description		
	<p> DRC Mode is available when you are watching 480i, 480p, 720p or 1080i sources. It is not available when Game Mode is On or you are using the Freeze feature.</p>		
DRC Palette	Custom	<p>Allows you to customize the level of detail (Reality) and smoothness (Clarity) for input sources. For example, you can create a Custom setting for your cable input's picture, and create another for your DVD player's picture.</p> <ol style="list-style-type: none"> Press the arrow buttons to highlight Custom then press . The DRC palette appears. <div data-bbox="612 465 858 666" data-label="Image"> </div> <ol style="list-style-type: none"> Press the arrow buttons to adjust the position of the marker (●). As you move the ● higher along the Reality axis, the picture becomes more detailed. As you move the ● to the right along the Clarity axis, the picture becomes smoother. To save the setting, press . 	
	<p> DRC Palette is available when you are watching 480i, 480p, 720p or 1080i sources. It is not available when Game Mode is On, DRC Mode is Off or you are using the Freeze feature.</p>		
<p>Advanced Settings Available only when Picture Mode is set to Custom</p>	Reset	Resets all the Advanced Settings to the default values (except for White Balance).	
	Black Corrector	Enhances black areas of the picture for stronger contrast.	
	Advanced C.E. (Advanced Contrast Enhancer)	Automatically optimizes the backlight and contrast. This setting is especially effective for dark image scenes. It will increase the contrast distinction of the darker picture scenes.	
	Gamma	Adjusts the balance between the light and dark areas of the picture.	
	Clear White	Emphasizes white and light colors.	
	Live Color	Makes colors more vivid.	
		<p> Live Color is not available when Color Space is set to Normal.</p>	
	Color Space	Use to select the range of color reproduction from Normal or Wide.	
White Balance	Adjusts the color temperature color by color.		
Detail Enhancer	Enhances the details of the picture.		
Edge Enhancer	Enhances the outline of the picture.		

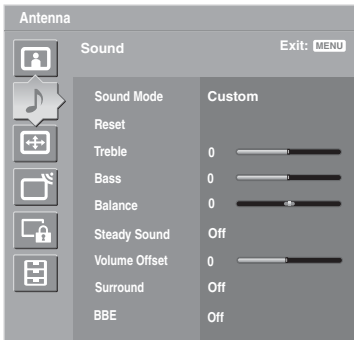
Sound Settings





To display the Sound settings, see “Navigating Through Settings” (see page 32).

Option	Description
Sound Mode	Dynamic Select to enhance treble and bass.
	Standard Suitable for spoken dialog.
	Custom Flat setting. Allows you to store your preferred settings.
	 You can set up a Sound Mode (Dynamic, Standard, Custom) independently for the TV input and for each video input (Video 1 to Video 8). Your Sound Mode settings are automatically saved upon selection.
Reset	Reset the following options to the default value: Treble, Bass, Balance, Steady Sound, Volume Offset, Surround and BBE.
Treble	Adjust to increase or decrease higher-pitched sounds.
Bass	Adjust to increase or decrease lower-pitched sounds.
Balance	Adjust to emphasize left or right speaker balance.
Steady Sound	On Select to stabilize the volume across all programs and commercials.
	Off Select to turn off Steady Sound.
Volume Offset	Adjust the volume level of the current input (TV or video input) relative to other inputs.
Surround	TruSurround XT Select for surround sound (for stereo programs only).
	Off Select for normal stereo or mono reception.
BBE	Select to give sound more impact by compensating for phase effects in speakers. Select from High, Low and Off.  BBE is only available when Sound Mode is set to Custom.
MTS <i>Enjoy stereo, bilingual and mono programs</i>	Stereo Select for stereo reception when viewing a program broadcast in stereo.
	Auto SAP Select to automatically switch to second audio programs when a signal is received. If no SAP signal is present, the TV remains in Stereo mode.
	Mono Select for mono reception. Use to reduce noise during weak stereo broadcasts.  MTS is available only for analog programs.

(Continued)



Using the Menus

Option	Description	
Alternate Audio <i>Digital channels only</i>		Select among the available options to switch among the alternate audio streams. The program you are tuned to may be broadcast in a different language in the alternate audio streams.
		The Alternate Audio option is not available if the program is not broadcast with alternate audio streams.
Speaker	On	Select to turn on the TV speakers.
	Off	Select to turn off the TV speakers and listen to the TV's sound only through your external audio receiver and speakers.
		When you connect the headphones, the TV speakers are disabled.
Audio Out <i>Easy control of volume adjustments</i>	Variable	The audio output from your audio system can be controlled by the TV's remote control.
	Fixed	The audio output of the TV is fixed. Use your audio receiver's remote control to adjust the volume (and other audio settings) through your audio system.
A/V Sync	Off/1/2/3	Use this option to make adjustments to audio and video synchronization when you have external equipment connected to DIGITAL OUT of the TV. Select Off (default value) to make no adjustments. Select 1 , 2 or 3 to synchronize the video and audio from your connected external equipment.

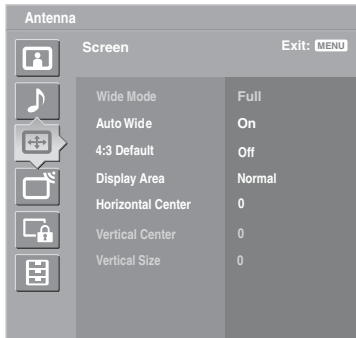
Screen Settings















To display the Screen settings, see “Navigating Through Settings” (see page 32).

Option	Description	
Wide Mode	Wide Zoom	Select to enlarge the 4:3 picture to fill the 16:9 screen, keeping the original image as much as possible.
	Normal	Select to display the 4:3 picture in its original size when the original source is 4:3. When the original source is 16:9, then the picture may be compressed horizontally.
	Full	Select to enlarge the picture horizontally to fill the screen when the original source is 4:3 (standard definition source). When the original source is 16:9 (high definition source), select this mode to display the 16:9 picture in its original size.
	Zoom	Select to enlarge the original picture without distorting the aspect ratio.
	<p> You can set up a Wide Mode (Wide Zoom, Normal, Full, Zoom) independently for the TV input and for each video input (Video 1 to Video 8). Your Wide Mode settings are automatically saved upon selection. For examples of each mode, see page 24.</p> <p> You can switch the Wide Mode settings by pressing the WIDE button on the remote control.</p>	
Auto Wide	On	Select to automatically change to the screen mode that is best for the current program. If frequent screen changes are disturbing to you, select Off.
	Off	Select to turn off the Auto Wide option. Choose a screen mode from the Wide Mode option.

(Continued)

Using the Menus



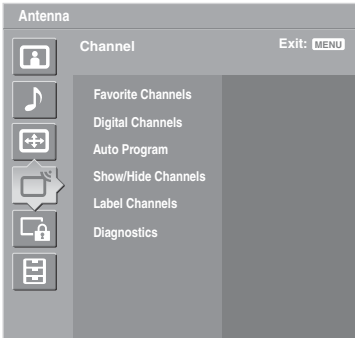

Option	Description
4:3 Default <i>Select the default screen mode to use for 4:3 sources.</i>	Wide Zoom Select to enlarge the 4:3 picture, to fill the 16:9 screen, keeping the original image as much as possible.
	Normal Select to display the 4:3 picture in its original size.
	Full Select to enlarge the 4:3 picture horizontally only, to fill the display area.
	Zoom Select to enlarge the picture horizontally and vertically to an equal aspect ratio that fills the wide screen.
	Off Select to continue using the current Wide Mode setting when the channel or input is changed.
<p> 4:3 Default is not available if Auto Wide is set to Off.</p> <p> If 4:3 Default is set to anything but Off, the Wide Mode setting changes only for the current channel. When you change channels (or inputs), Wide Mode is automatically replaced with the 4:3 Default setting. To retain the current Wide Mode setting as channels and inputs are changed, set 4:3 Default to Off.</p>	
Display Area	Allows you to adjust the screen area of the displayed image.
	Full Pixel Select to display the picture for 1080i or 1080p sources in its original size.
	Normal Select to display the picture in its standard size.
	-1/-2 Select to enlarge the picture to hide the edge of the picture.
Horizontal Center	Allows you to move the position of the picture left and right. Press  /  and press  to adjust.
Vertical Center	Allows you to move the position of the picture up and down. (Available only in Zoom.) Press  /  and press  to adjust.
Vertical Size	Allows you to adjust the vertical size of the picture. (Available only in Wide Zoom and Zoom.) Press  /  and press  to adjust.

 Size adjustment is especially useful for Wide Zoom picture conditions such as news ticker information at the bottom or top of the screen.

Channel Settings



To display the Channel settings, see “Navigating Through Settings” (see page 32).

Option	Description
Favorite Channels	<p>Lets you set up a list of up to 16 of your favorite channels.</p> <ol style="list-style-type: none"> 1 Press ▲/▼ to scroll to the slot you would like to edit. 2 Enter your favorite channel number and press ⊕ to apply and save. To select other favorite channel numbers, repeat steps 1 and 2. <p> To select favorite channel numbers that you specified, see page 32.</p>
Digital Channels	<p>Add Select to add digital channels.</p>
Auto Program	<p>Automatically sets up the channel list on the TV for all receivable channels for the current TV input (either Antenna or Cable).</p>
Show/Hide Channels	<p>Allows you to show or hide channels that appear in the program guide and when you use the CH+/- buttons to channel surf.</p> <ol style="list-style-type: none"> 1 Press ▲/▼ to highlight the channel that you want to show or hide. To move between the Major and Minor subchannel lists, press ◀/▶. 2 To change a channel's setting to Shown or Hidden, press ⊕. <p>To show or hide more channels, repeat steps 1 and 2.</p> <p> Channels that you set to be hidden can be accessed only with the 0-9 buttons.</p> <p> If you select to hide or show a major digital channel, all the subchannels are automatically hidden or shown. To show or hide an individual sub-channel within a digital channel, you must individually select that sub-channel to show or hide.</p> <p> If you hide all sub-channels of a major digital channel, that digital channel is automatically set to Hidden.</p>
Label Channels	<p>Allows you to assign labels (such as station call letters) to channel numbers.</p> <ol style="list-style-type: none"> 1 Press ▲/▼ to scroll through the channel numbers. Then press ⊕ to select the channel number that you want to assign a label. 2 Press ▲/▼ to scroll through the label characters (A-Z, 0-9, etc.). Press ⊕ to move to the next character. Repeat to add up to 7 characters to the label. To assign labels to more channels, repeat steps 1 and 2.
Diagnostics	<p>Display diagnostics information about the current channel and TV. This can be useful in providing information to an authorized technician or repair person.</p>

Parental Lock Settings

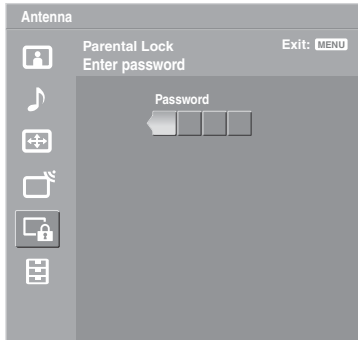

To display the Parental Lock settings, see “Navigating Through Settings” (see page 32).



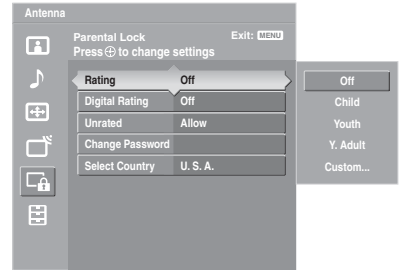

Use 0-9 on the remote control to enter a four-digit password.



The Parental Lock option appears.



Option	Description
Rating	<p>Off Turn Parental Lock off. No programs are blocked from viewing.</p> <p>Child Maximum ratings permitted are: U.S.: TV-Y, TV-G, G Canada: C, G, TV-Y</p> <p>Youth Maximum ratings permitted are: U.S.: TV-PG, PG Canada: C8+, PG, 8 ans+, TV-PG</p> <p>Y. Adult Maximum ratings permitted are: U.S.: TV-14, PG-13 Canada: 14+, 13 ans+, TV-14</p> <p>Custom... Select to set ratings manually. U.S.: See page 41 for details. Canada: See page 42 for details.</p>

 If you are not familiar with the Parental Guideline rating system, you should select Child, Youth, or Y. Adult to help simplify the rating selection. To set more specific ratings, select Custom.

Digital Rating <i>(Available only in U.S.A. where advanced ratings exist)</i>	<p>Off Turn Digital Rating off. No programs that contain downloadable ratings are blocked from viewing.</p> <p>Custom... Select to block programs based on downloadable ratings.</p> <p>Clear All Select to clear the entire downloadable rating system.</p>
	<p> This action will delete the current Digital Rating menu and the menu will no longer be available until the TV is tuned to a channel that contains downloadable ratings.</p> <p> This icon  will appear on the information banner across the screen indicating the availability of the new downloadable rating information when the Digital Rating is set to the Custom option.</p> <p> This setting is only available if digital ratings have been downloaded by your TV and ratings have been set for U.S.A. in Select Country (see page 41).</p>

Option	Description
Unrated <i>(available only in U.S.A.)</i>	Allow Allows programs and movies that are broadcast without a rating.
	Block Blocks all programs and movies that are broadcast without a rating.
	 If you block unrated TV programs, be aware that the following types of programs may be blocked: programs broadcast from another country, emergency broadcasts, political programs, sports, news, public service announcements, religious programs and weather.
Change Password	Select to change your password.
	 You need your password for any future access into the Parental Lock settings. If you lose your password, see “Lost password” on page 50.
Select Country	U.S.A. Select to use U.S.A. ratings (see below).
	Canada Select to use Canadian ratings (see page 42).

US Models: Selecting Custom Parental Lock Rating Options

To select custom rating options for the U.S., select U.S.A. in the Select Country setting (see above).

Option	Description
Movie Rating	G All children and general audience.
	PG Parental guidance suggested.
	PG-13 Parental guidance for children under 13.
	R Restricted viewing, parental guidance is suggested for children under 17.
	NC-17 and X No one 17 or under allowed.
TV Rating <i>Block programs by their rating, content or both</i>	Age-Based Ratings
	TV-Y All children.
	TV-Y7 Directed to children age 7 and older.
	TV-G General audience.
	TV-PG Parental guidance suggested.
	TV-14 Parents strongly cautioned.
	TV-MA Mature audience only.
	Content-Based Ratings
	FV Fantasy violence.
	D Suggestive dialogue.
	L Strong language.
	S Sexual situations.
	V Violence.
	 To ensure maximum blocking capability, set the Age-Based Ratings.

(Continued)

Using the Menus

Canadian Models: Selecting Custom Parental Lock Rating Options

To select custom rating options for Canada, select **Canada** in the **Select Country** setting (see page 41).

<i>Option</i>	<i>Description</i>	
English Rating	C	All children.
	C8+	Children 8 years and older.
	G	General programming.
	PG	Parental guidance.
	14+	Viewers 14 and older.
	18+	Adult programming.
French Rating	G	General programming.
	8 ans+	Not recommended for young children.
	13 ans+	Not recommended for ages under 13.
	16 ans+	Not recommended for ages under 16.
	18 ans+	Programming restricted to adults.
U.S.A. Rating	See TV Rating for “US Models” on page 41.	

Viewing Blocked Programs

You can view blocked programs by entering the password. Press **ENT** when tuned to a blocked program, then enter the password. This temporarily turns the parental control feature off. To reactivate the **Parental Lock** settings, turn off the TV. When the TV is turned on again, your **Parental Lock** settings are reactivated.

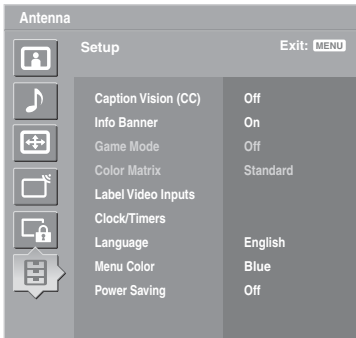

Setup Settings



To display the Setup settings, see “Navigating Through Settings” (see page 32).

Option	Description
Caption Vision (CC)	Allows you to select from several closed-caption modes.
	On Caption Vision (CC) is turned on.
	Off Caption Vision (CC) is turned off.
	Program Allows you to set basic and advanced Caption Vision (CC) options. See “Programming Caption Vision (CC)” on page 45.
Info Banner	Set to On or Off. When On, displays the program name and the program information (if the broadcaster offers this service). Displays for few seconds when the channel is changed or the DISPLAY button is pressed.
Game Mode	On Select to optimize for playing games.
	Off Select to turn off the Game Mode.
Color Matrix	Allows you to reproduce the color-difference signals. It is recommended that you leave this at the factory default setting.
	Standard Automatically optimize based on signal.
	Custom If the tone of the picture from the input source is unnatural, select either ITU601 or ITU709, which normalizes the tone.
Label Video Inputs	Allows you to identify A/V equipment you connected to the TV, such as a VCR, DVD, etc. For example, if you have a DVD player connected to the VIDEO 4 jack, you can select the label DVD for the Video 4 input. Then when you press TV/VIDEO to change inputs, the video label you assigned to that input appears on screen.
	1 Press \uparrow/\downarrow to highlight the video input (Video 1-9) to which you want to assign a label. Then press \oplus to select the input.
	2 Press \uparrow/\downarrow to highlight one of the displayed labels. Then press \oplus to select the label. You can select from the following labels for each input:
	Video 1-8 –, DVD, Cable Box, Satellite, BD, VCR, Receiver, DVR, Game, Camcorder, Edit, Skip
	Video 9 –, PC, Skip
Edit allows you to create a custom 10-character label. You can edit the Label Video Inputs the same way you create channel labels, as described on page 39.	
If you select Skip, your TV skips this input when you press the TV/VIDEO button.	
The Skip label is useful for inputs to which no equipment is connected.	

(Continued)

Option	Description
Clock/Timers	Set the time in minutes (Off, 15 minutes, 30 minutes, 45 minutes, 60 minutes, 90 minutes or 120 minutes) that you want the TV to remain on before shutting off automatically.
Timer 1	You can use the timers to turn the TV on, set the duration time the TV will remain on, and tune to a specific channel at two scheduled times.
Timer 2	
	<p>Timer 1 and Timer 2 will not be available until you set the Current Time.</p> <ol style="list-style-type: none"> Press ▲/▼ to highlight Timer 1 or Timer 2. To set the timer, press ▶. <div style="background-color: #f0f0f0; padding: 5px; margin: 5px 0;"> <p> To go directly to programming Timer 1 or 2, press ⊕ instead of pressing ▶.</p> </div> <ol style="list-style-type: none"> Press ▲/▼ to highlight one of the following options, then press ⊕. Program: Select to set the timer by day, hour, minute, AM/PM, Duration, and Channel. Off: Select to turn off the timer. (Your previous settings are saved.) If you selected Program in step 2, press ▲ and ▼ to set the day(s), hour, minute, AM/PM, duration, and channel number. Press ⊕ or press ▶ to confirm each setting and move to the next setting. Press ◀ to go back to the previous setting. Press MENU to exit Settings.
Current Time	<p>You can set the current time.</p> <ol style="list-style-type: none"> Press ⊕ to select Current Time. Press ▲ and ▼ to set the current time (day, hour, minute, and AM/PM). Press ⊕ (or press ▶) to confirm each setting and move to the next setting. Press ◀ to go back the previous setting. Press MENU to exit Settings.
Language	Select to display all on-screen settings in your language of choice: English, Español, Français.
Menu Color	Enables you to select a specific color for the on-screen settings.
Power Saving	Select to reduce the power consumption by adjusting the backlight brightness. This also enhances the black level. Select from Off, Low, High and Picture Off.
Logo Illumination	Select to illuminate the Sony logo on the front panel of the TV. Select On or Off.
Light Sensor	<p>Select On to enable the automatic picture (screen) brightness control. The light sensor measures the room brightness which allows the TV to automatically adjust the backlight brightness based on the picture settings and the ambient room light conditions.</p> <div style="background-color: #f0f0f0; padding: 5px; margin: 5px 0;"> <p> Be sure not to put anything around the sensor, as its function may be affected. See page 30 for information about the sensor.</p> <p> In low light the range of the backlight control is reduced when Light Sensor is set to On.</p> </div>

Option	Description
CineMotion	Select Auto to optimize the screen display automatically detecting film content and applying a reverse 3-2 pulldown process. Moving pictures will appear clearer and more natural looking. Select Off to disable the detection.
	 CineMotion is only available when you are watching 480i sources, except when the Freeze feature is in use.
Product Information	Select to display the equipment information of your TV.

Programming Caption Vision (CC)

If you selected the Program option under Caption Vision (CC) (see page 43), you can change the following settings:

Option	Description
Basic	Allows you to select basic analog (EIA-608) closed caption options.
	CC1, CC2, CC3, CC4 Displays a printed version of the dialog or sound effects of a program. (Should be set to CC1 for most programs.)
	Text1, Text2, Text3, Text4 Displays network/station information presented using either half or the whole screen (if available).
Digital CC	Allows you to set digital closed captioning to Basic (digital EIA-608) or Advanced (digital EIA-708).
Advanced	Allows you to select advanced digital (EIA-708) closed caption options. Select from the available options.
Advanced Settings	Allows you to make additional settings for digital (EIA-708) closed caption options. Select from As Broadcast , Small Text , Large Text and Custom .
	Custom... Allows you to customize the following settings:
	Character Size Small, Standard, Large
	Character Style Style 1-7
	Character Color Color 1-8
	Character Opacity Solid, Translucent
	Edge Color Color 1-8
	Edge Type None, Raised, Depressed, Outline, Left Shadow, Right Shadow
	Background Color None, Color 1-8
	Background Opacity Solid, Translucent
	Window Color None, Color 1-8
	Window Opacity Solid, Translucent

PC Settings

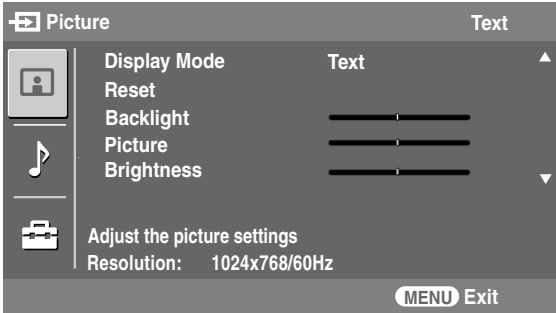

To display the PC settings, see “Navigating Through Settings” (see page 32).

- ✎ Press TV/VIDEO to switch to another input.
- ✎ When you connect a PC to your TV for the first time, you may need to adjust the screen display. In such cases, perform Auto Adjustment or manually adjust Phase, Pitch, Horizontal Center, or Vertical Center in Others.

Option	Description	
Picture	Display Mode	Video Select to view video images.
		Text Select to view text, charts or tables.
	Reset	Reset the current settings to the default values.
	Backlight	Adjust to brighten or darken the backlight.
	Picture	Adjust to increase or decrease picture contrast.
	Brightness	Adjust to brighten or darken the picture.
	Color Temp. <i>White adjustment</i>	Cool Select to give the white colors a bluish tint.
	Neutral Select to give the white colors a neutral tint.	
	Warm 1,2 Select to give the white colors a reddish tint. Warm 2 gives a redder tint than Warm 1.	
Sound	Sound Mode	Dynamic Select to enhance treble and bass.
		Standard Provides standard sound. Recommended for home entertainment.
		Custom Provides a flat response. Sound quality as customized on the connected PC is maintained in the TV sound.

Option	Description		
Others	Auto Adjustment	Select to automatically adjust the display position, Phase and Pitch of the picture when the TV receives an input signal from the connected PC. Note that Auto Adjustment may not work well with certain input signals. In such cases, manually adjust the options below.	
	Reset	Resets the current settings to the default value.	
	Phase	Adjust after Pitch to fine tune overall sharpness.	
	Pitch	Adjust uneven sharpness on screen.	
	✎ For the PC Input Signal Reference Chart, see page 51.		
	Horizontal Center	Allows you to move the position of the picture left and right. Press ◀/▶ and press ⊕ to adjust.	
	Vertical Center	Allows you to move the position of the picture up and down. Press ◀/▶ and press ⊕ to adjust.	
	Wide Mode	Normal	Select to display in the original image size.
		Full 1	Select to enlarge the picture to fill the display area, keeping its original aspect ratio.
		Full 2	Select to enlarge the picture to fill the display area.
Power Management	On	Select to automatically switch to the standby mode when there is no signal input for 30 seconds.	
	Off	Select to turn off Power Management.	
✎ Power Management is not VESA-compliant.			

Other Information

Troubleshooting

If you have additional questions, service needs, or require technical assistance related to the use of your Sony TV, please visit our website or call one of the following numbers:

<http://www.sony.com/TVsupport>

1-800-222-SONY(7669) for US Residents

1-877-899-SONY(7669) for Canadian Residents

Problem	Possible Remedies
No picture.	
No picture.	<input type="checkbox"/> Check Power Saving settings (page 44).
Cannot receive any channels.	<input type="checkbox"/> Make sure the power cord is connected securely.
	<input type="checkbox"/> Turn on the power of the TV.
	<input type="checkbox"/> Check antenna/cable connections.
TV is locked to one channel.	<input type="checkbox"/> Perform Auto Program to add receivable channels that are not presently in the TV's memory (page 39).
Cannot receive or select channels.	<input type="checkbox"/> Perform Auto Program to add receivable channels that are not presently in the TV's memory (page 39).
The TV turns off automatically.	<input type="checkbox"/> Check if the Sleep is activated, or confirm the Duration setting of Timer . (page 44).
	<input type="checkbox"/> If the temperature is too high, the TV may also turn off after a warning message is displayed.
	<input type="checkbox"/> Check Power Management in the PC Settings (page 47).
No picture from some video sources.	<input type="checkbox"/> Check the connection between the optional video equipment and the TV.
	<input type="checkbox"/> Press TV/VIDEO on the remote control (page 21).
	<input type="checkbox"/> Press MENU on the remote control. Select your desired input from the External Inputs list.
Poor picture.	
Double images or ghosts.	<input type="checkbox"/> Check antenna/cable connections.
	<input type="checkbox"/> Check the antenna location and direction.
Only snow and noise appear on the screen.	<input type="checkbox"/> Check if the antenna is broken or bent.
	<input type="checkbox"/> Check if the antenna has reached the end of its serviceable life. (3-5 years in normal use, 1-2 years at the seaside.)
Dotted lines or stripes.	<input type="checkbox"/> Keep the TV away from noise sources such as cars, motorcycles, or hair-dryers.
	<input type="checkbox"/> If using 300 ohm twin lead, move the excess lead away from the TV or try using 75 ohm coaxial cable instead.
No color/Dark picture/Color is not correct/The picture is too bright.	<input type="checkbox"/> Press PICTURE to select the desired picture mode (page 24).
	<input type="checkbox"/> Adjust the Picture Mode options in the Picture settings (page 33).
	<input type="checkbox"/> If you set the Power Saving mode to Low or High , it will enhance the black level.
Noisy picture.	<input type="checkbox"/> Make sure that the antenna is connected using the supplied 75-ohm coaxial cable.
	<input type="checkbox"/> Keep the antenna cable away from other connecting cords.
	<input type="checkbox"/> To avoid TV interference, make sure to use an undamaged antenna cable.

Problem	Possible Remedies
No sound/Noisy sound	
Good picture, no sound.	<ul style="list-style-type: none"> <input type="checkbox"/> Check the volume control. <input type="checkbox"/> Press MUTING or VOL + so that “Muting” disappears from the screen (page 23). <input type="checkbox"/> Disconnect your headphones. <input type="checkbox"/> Set Speaker to On in the Sound settings (page 36). If it is set to Off, sound is not output from the TV’s speakers regardless of the TV’s volume control.
Audio noise.	<ul style="list-style-type: none"> <input type="checkbox"/> Make sure that the antenna is connected using the supplied 75-ohm coaxial cable. <input type="checkbox"/> Keep the antenna cable away from other connecting cords. <input type="checkbox"/> To avoid TV interference, make sure to use an undamaged antenna cable.
Wide Mode changes automatically.	<ul style="list-style-type: none"> <input type="checkbox"/> The current Wide Mode setting is automatically replaced with the 4:3 Default setting when you change the channel or video input, if 4:3 Default in the Screen settings is set to other than Off. If you want to lock in the Wide Mode selected with the WIDE button, set 4:3 Default to Off in the Screen settings (page 38). <input type="checkbox"/> Check the Auto Wide option in the Screen settings (page 37).
“Black box” on screen.	<ul style="list-style-type: none"> <input type="checkbox"/> You have selected a text option in the Caption Vision (CC) feature in the Setup setting and no text is available (see pages 43 and 45 to reset Setup selections). To turn off this feature, set the Caption Vision (CC) option to Off. If you were trying to select closed captioning, select CC1 instead of Text1-4.
Black bands appear at the top and bottom of the screen.	<ul style="list-style-type: none"> <input type="checkbox"/> Some wide screen programs are filmed in aspect ratios that are greater than 16:9 (this is especially common with theatrical releases). Your TV will show these programs with black bands at the top and bottom of the screen. For more details, check the documentation that came with your DVD (or contact your program provider).
Certain programs on DVD or other digital sources display a loss of detail, especially during fast-motion or dark scenes.	<ul style="list-style-type: none"> <input type="checkbox"/> The compression used by certain digital broadcasts and DVDs may cause your TV’s screen to display less detail than usual, or cause artifacts (small blocks or dots, pixelations) to appear on your screen. This is due to your TV’s large screen and ability to show very fine detail, and is normal for certain digitally recorded programs. Adjust the Reality/Clarity in the DRC Palette setting (page 34) to optimize the picture while viewing these sources.
Remote control does not operate.	<ul style="list-style-type: none"> <input type="checkbox"/> Check the polarity of the batteries or replace the batteries. <input type="checkbox"/> Point the remote control at the remote control sensor of the TV. <input type="checkbox"/> Fluorescent/fluorescent lamps can interfere with your remote control operation; try turning off the Fluorescent/fluorescent lamps. <input type="checkbox"/> Keep the remote control sensor area clear from obstacles.
Cannot change channels with the remote control.	<ul style="list-style-type: none"> <input type="checkbox"/> If you are using the TV to change channels, first press TV (FUNCTION) once, and the TV indicator lights up. <input type="checkbox"/> If you are using another device to change channels, be sure you have not inadvertently switched your TV from the channel 3 or 4 setting. <input type="checkbox"/> If you are using another device to change channels, be sure to press FUNCTION for that device. For example, if you are using your cable box to change channels, be sure to press SAT/CABLE (FUNCTION) once, and the SAT/CABLE indicator lights up.
Remote control does not operate non-Sony video equipment.	<ul style="list-style-type: none"> <input type="checkbox"/> If you replaced the batteries to the remote recently, the code numbers for the video equipment may need to be reset. <input type="checkbox"/> There may be more than one code for the equipment that you are attempting to operate. <input type="checkbox"/> There is a possibility that some non-Sony equipment cannot be operated by your Sony TV remote. You may need to use the equipment’s original remote control.

(Continued)

Other Information

Problem	Possible Remedies
Some digital cable channels are not being displayed.	<ul style="list-style-type: none"><input type="checkbox"/> Certain cable companies have limitations on the broadcast of digital cable channels. Check with your cable company for more information.<input type="checkbox"/> The digital cable channel may be set to Hidden in the Show/Hide Channels setting (page 39).
Lost password.	<ul style="list-style-type: none"><input type="checkbox"/> Select the Parental Lock settings on the settings screen, then enter the following master password: 4357. The master password clears your previous password and allows you to enter a new password (page 40).
How to reset the TV to factory settings.	<ul style="list-style-type: none"><input type="checkbox"/> Turn on the TV. While holding down the ▲ button on the remote control, press the POWER button on the TV. (The TV will turn itself off, then back on again.) Release the ▲ button. WARNING: This operation will clear all of your customized settings including Parental Lock setting.

PC Input Signal Reference Chart

Signals	Resolution			Horizontal frequency (kHz)	Vertical frequency (Hz)	Standard
	Horizontal (Pixel)	×	Vertical (Line)			
VGA	640	×	480	31.5	60	VGA
	640	×	480	37.5	75	VESA
	720	×	400	31.5	70	VGA-T
SVGA	800	×	600	37.9	60	VESA Guidelines
	800	×	600	46.9	75	VESA
XGA	1024	×	768	48.4	60	VESA Guidelines
	1024	×	768	56.5	70	VESA
	1024	×	768	60.0	75	VESA
WXGA	1280	×	768	47.4	60	VESA
	1280	×	768	47.8	60	VESA
	1280	×	768	60.3	75	
	1360	×	768	47.7	60	VESA
SXGA	1280	×	1024	64.0	60	VESA
	1280	×	1024	80.0	75	VESA
HDTV	1920	×	1080	67.5	60	

 This TV's PC input does not support Sync on Green or Composite Sync.

 This TV's PC input does not support interlaced signals.

 For the best picture quality, it is recommended to use the signals (boldfaced) in the above chart with a 60Hz vertical frequency from a personal computer. In plug and play, signals with a 60Hz vertical frequency will be selected automatically.

Other Information

Specifications

Television system:

NTSC	American TV standard
ATSC (8VSB terrestrial)	ATSC compliant 8VSB
QAM on cable	ANSI/SCTE 07 2000 (Does not include CableCARD functionality)

Channel coverage:

Terrestrial (analog)	2-69
Cable (analog)	1-125
Terrestrial (digital)	2-69
Cable (digital)	1-135

Antenna: 75-ohm external terminal for VHF/UHF

Screen size (measured diagonally):

KDL-40XBR2:	40 inches
KDL-46XBR2:	46 inches
KDL-40XBR3:	40 inches
KDL-46XBR3:	46 inches

Panel System:

LCD (Liquid Crystal Display) Panel

Display resolution (horizontal × vertical):

1,920 dots × 1,080 lines

VIDEO IN 1/2/4:

S VIDEO (4-pin mini DIN) (VIDEO 1 only):

Y: 1.0 Vp-p, 75 ohms unbalanced, sync negative
C: 0.286 Vp-p (Burst signal), 75 ohms

VIDEO: 1 Vp-p, 75 ohms unbalanced, sync negative

AUDIO: 500 mVrms (100% modulation)

Impedance: 47 kilohms

HD/DVD IN 5/6:

YPbPr (Component Video):

Y: 1.0 Vp-p, 75 ohms unbalanced,
sync negative

PB: 0.7 Vp-p, 75 ohms

PR: 0.7 Vp-p, 75 ohms

Signal format: 480i, 480p, 720p, 1080i

AUDIO: 500 mVrms (100% modulation)

Impedance: 47 kilohms

HDMI IN 3/7/8:

HDMI: Video: 480i, 480p, 720p, 1080i, 1080p

Audio: Two channel linear PCM 32, 44.1 and
48 kHz, 16, 20 and 24 bits

AUDIO (for HDMI IN 8):

500 mVrms (100% modulation)

Impedance: 47 kilohms

AUDIO OUT:

500 mVrms (100% modulation) (Fixed)

1 Vrms at the maximum volume setting (Variable)

DIGITAL OUT (OPTICAL):

Optical Digital Audio Output (PCM/Dolby digital)

PC IN 9:

D-sub 15-pin, analog RGB, 0.7 Vp-p, 75 ohms, positive

See the PC Input Signal Reference Chart on page 51

PC AUDIO INPUT:

Stereo mini jack, 500 mVrms (100% modulation), Impedance: 47 kilohms

Headphones:

Stereo mini jack

Impedance: 16 ohms

Speaker:

KDL-40XBR2/40XBR3

Full Range : 40 × 100 mm (1⁵/₈ × 4 inches) (4)

Tweeter : 40 mm (1⁵/₈ inches) (2)

KDL-46XBR2/46XBR3

Full Range : 50 × 105 mm (2 × 4¹/₄ inches) (4)

Tweeter : 40 mm (1⁵/₈ inches) (2)

Speaker output:

11W + 11W

Power Requirement:

120 V-240 V AC, 50/60 Hz

Power consumption:

In use: KDL-40XBR2: 227W

KDL-46XBR2: 277W

KDL-40XBR3: 227W

KDL-46XBR3: 277W

In standby: Less than 0.5W

Dimensions (W/H/D):

KDL-40XBR2: (with stand) 1111 × 717 × 322 mm

(43³/₄ × 28¹/₄ × 12³/₄ inches)

(without stand) 1111 × 657 × 121 mm

(43³/₄ × 25⁷/₈ × 4⁷/₈ inches)

KDL-46XBR2: (with stand) 1262 × 795 × 322 mm

(49³/₄ × 31³/₈ × 12³/₄ inches)

(without stand) 1262 × 734 × 121 mm

(49³/₄ × 29 × 4⁷/₈ inches)

KDL-40XBR3: (with stand) 1111 × 717 × 322 mm

(43³/₄ × 28¹/₄ × 12³/₄ inches)

(without stand) 1111 × 657 × 123 mm

(43³/₄ × 25⁷/₈ × 4⁷/₈ inches)

KDL-46XBR3: (with stand) 1262 × 795 × 322 mm

(49³/₄ × 31³/₈ × 12³/₄ inches)

(without stand) 1262 × 734 × 123 mm

(49³/₄ × 29 × 4⁷/₈ inches)

Mass:

KDL-40XBR2: (with stand) 35.0 kg (77 lb. 3 oz.)

(without stand) 30.0 kg (66 lb. 3 oz.)

KDL-46XBR2: (with stand) 41.0 kg (90 lb. 7 oz.)

(without stand) 36.0 kg (79 lb. 6 oz.)

KDL-40XBR3: (with stand) 35.0 kg (77 lb. 3 oz.)

(without stand) 30.0 kg (66 lb. 3 oz.)

KDL-46XBR3: (with stand) 41.0 kg (90 lb. 7 oz.)

(without stand) 36.0 kg (79 lb. 6 oz.)

Supplied accessories:

Remote control

RM-YD010 (KDL-40XBR2/46XBR2) (1)

RM-YD013 (KDL-40XBR3/46XBR3) (1)

Size AA batteries (2)

75-ohm coaxial cable (1)

AC power cord (1)

HD15-HD15 cable (1)

Support belt (1), securing screw (1) and wood screw (1)

Cable holder (1)

Operating Instructions (1)

Quick Setup Guide (1)

Warranty Card (1)

Online Registration Card (U.S.A. only) (1)

Optional accessories:

Headphones plug adapter

Connecting cables

Wall-Mount Bracket: SU-WL51

 The availability of optional accessories depends on its stock.

Index

4:3 Default 38

A

A/V Sync 36
AC IN 17
Advanced Settings 34
Alternate Audio 22, 36
ANT button 21
Audio Out 36
AUDIO OUT jack 17
Auto Adjustment 47
Auto Program 39
Auto Wide 37

B

Backlight 33, 46
Balance 35
Bass 35
BBE 35
BD/DVD MENU button 23
BD/DVD or DVR/VCR Operating Buttons 23
BD/DVD TOP MENU button 23
Brightness 33, 46

C

Cable 17
Canadian Models 42
Caption Vision (CC)
 described 43
 programming 45
CH +/- button 24
Change Password 41
CHANNEL +/- button 30
CineMotion 45
Clock/Timers 44
Color 33
Color Matrix 43
Color Temp. 33, 46
Connecting
 Cable Box/Digital Cable Box 12
 Cable Box/Digital Cable Box and Antenna 12
 Cable System and VHF/UHF Antenna System 11
 Satellite Receiver and Cable/Antenna 13
 VCR and Cable 14
 VCR and Cable Box/Digital Cable Box 15

D

Diagnostics 39
Digital Channels 39
DIGITAL OUT 17

Digital Rating 40
Display Area 38
DISPLAY button 24
Display Mode 46
DRC Mode 33
DRC Palette 34
DVR/VCR Record Buttons 23

E

English Rating 42
ENT button 21

F

F1/F2 button 24
Favorite Channels 39
FREEZE button 23
French Rating 42
FUNCTION buttons 21

G

Game Mode 43
GUIDE button 22

H

HD/DVD IN jack (1080i/720p/480p/480i) 17
HDMI IN jacks 16
Headphones jack 16
Horizontal Center 38, 47
Hue 33

I

Info Banner 43
Infrared Receiver (IR)/Light Sensor 30

J

JUMP button 21

L

Label Channels 39
Label Video Inputs 43
Language 44
Light Sensor 44
Logo Illumination 44

M

MENU
 Antenna 32
 Cable 32
 External Inputs 31
 Favorites 32
 Settings 32
MENU button 24, 30
Menu Color 44
Movie Rating 41

MTS 35
MUTING button 23

N

Noise Reduction 33

P

PC IN 17
Phase 47
PIC OFF/TIMER LED 30
Picture 33, 46
PICTURE button 24
Picture Mode 33
Pitch 47
POWER button 23, 30
POWER LED 30
Power Management 47
Power Saving 44
Product Information 45
Program options setting 22

R

Rating 40
Remote control
 inserting batteries 21
 programming 25–26
Reset 33, 35, 46, 47, 50
RETURN button 22

S

S VIDEO jack 17
Select Country 41
Settings
 Channel 39
 Parental Lock 40
 PC Settings 46
 Picture 33
 Screen 37
 Setup 43
 Sound 35
 Sharpness 33
 Show/Hide Channels 39
SLEEP button 21
SOUND button 21
Sound Mode 35, 46
Speaker 30, 36
Specifications 52
STANDBY LED 30
Steady Sound 35
Support Belt 18
Surround 35
SURROUND button 21

T

TOOLS button 24

Treble **35**
Troubleshooting **48–50**
TV POWER button **23**
TV Rating **41**
TV/VIDEO button **21, 30**

U

U.S.A. Rating **42**
Unrated **41**
US Models **41**
Using with remote control
 5.1ch DVD AV System **28**
 AV Receiver **29**
 Blu-ray Disc Player **28**
 Cable Box **27**
 DVD Player or DVD Changer **27**
 DVD/VCR Combo Unit **28**
 DVR **29**
 HDD/DVD Combo Unit **29**
 Satellite Receiver **27**
 VCR **27**

V

Vertical Center **38, 47**
Vertical Size **38**
VHF/UHF input **17**
VIDEO/AUDIO (L/R) jacks **16, 17**
Viewing Blocked Programs **42**
VISUAL SEARCH button **23**
VOL +/- button **23**
VOLUME +/- button **30**
Volume Offset **35**

W

WIDE button **24**
Wide Mode **37, 47**

For Your Convenience

Please contact Sony directly if you:

- Have questions on the use of your television after reading your manual
- Experience difficulty operating your television

Contact Sony Customer Support at:

<http://www.sony.com/tvsupport>

or to speak with a support representative:

United States

1-800-222-SONY (7669)

8:00 AM - 10:00 PM (EST) Mon - Fri

10:30 AM - 7:15 PM (EST) Sat - Sun

Canada

1-877-899-SONY (7669)

8:00 AM - 6:00 PM (Eastern)

8:00 AM - 5:00 PM (Western)

Sony will work to resolve your questions more quickly than your retailer or place of purchase.

Please Do Not Return the Product to the Store



<http://www.sony.net/>



Printed in U.S.A.