



FD Trinitron
WEGA

KD-34XBR970

Operating Instructions

WARNING

To reduce the risk of fire or shock hazard, do not expose the TV to rain or moisture.



This symbol is intended to alert the user to the presence of uninsulated "dangerous voltage" within the product's enclosure that may be of sufficient magnitude to constitute a risk of electric shock to persons.



This symbol is intended to alert the user to the presence of important operating and maintenance (servicing) instructions in the literature accompanying the appliance.

CAUTION

TO PREVENT ELECTRIC SHOCK, MATCH WIDE BLADE OF PLUG TO WIDE SLOT, FULLY INSERT.

CAUTION

When using TV games, computers, and similar products with your TV, keep the brightness and contrast functions at low settings. If a fixed (non-moving) pattern is left on the screen for long periods of time at a high brightness or contrast setting, the image can be permanently imprinted onto the screen. Continuously watching the same program can cause the imprint of station logos onto the TV screen. These types of imprints are not covered by your warranty because they are the result of misuse.

Warning

The CRT in this product employs a protective film on the face. This film must not be removed as it serves a safety function and removal will increase the risk of serious injury.

Note on Caption Vision

This television receiver provides display of television closed captioning in accordance with §15.119 of the FCC rules.

Note on Cleaning the TV

Clean the TV with a soft, dry cloth. Never use strong solvents such as thinner or benzene, which might damage the finish of the cabinet.

Note to CATV System Installer

This reminder is provided to call the CATV system installer's attention to Article 820-40 of the National Electrical Code (NEC) that provides guidelines for proper grounding and, in particular, specifies that the cable ground shall be connected to the grounding system of the building, as close to the point of cable entry as practical.

Use of this television receiver for other than private viewing of programs broadcast on UHF or VHF or transmitted by cable companies for the use of the general public may require authorization from the broadcaster/cable company and/or program owner.



To reduce the risk of electric shock, do not use this polarized plug with an extension cord, receptacle, or other outlet unless the blades can be fully inserted to prevent blade exposure.



Pursuant to FCC regulations you are cautioned that any changes or modifications not expressly approved in this manual could void your authority to operate this equipment.

NOTIFICATION

This equipment has been tested and found to comply with the limits for a Class B digital device pursuant to Part 15 of the FCC Rules. These limits are designed to provide reasonable protection against harmful interference in a residential installation. This equipment generates, uses, and can radiate radio frequency energy and, if not installed and used in accordance with the instructions, may cause harmful interference with radio communications. However, there is no guarantee that interference will not occur in a particular installation. If this equipment does cause harmful interference to radio or television reception, which can be determined by turning the equipment off and on, the user is encouraged to try to correct the interference by one or more of the following measures:

- Reorient or relocate the receiving antennas.
- Increase the separation between the equipment and receiver.
- Connect the equipment into an outlet on a circuit different from that to which the receiver is connected.
- Consult the dealer or an experienced radio/TV technician for help.

You are cautioned that any changes or modifications not expressly approved in this manual could void your authority to operate this equipment.

Installing

- To prevent internal heat buildup, do not block the ventilation openings.
- Do not install the TV in a hot or humid place, or in a place subject to excessive dust or mechanical vibration.
- The AC power cord is attached to the rear of the TV with hooks. Do not attempt to remove the cord from these hooks. Doing so could cause damage to the TV.

Owner's Record

The model and serial numbers are provided on the front of this instruction manual and at the rear of the TV. Refer to them whenever you call upon your Sony dealer regarding this product.

Note

This digital television is capable of receiving analog basic, digital basic and digital premium cable television programming by direct connection to a cable system providing such programming. A security card provided by your cable operator is required to view encrypted digital programming. Certain advanced and interactive digital cable services such as video-on-demand, a cable operator's enhanced program guide and data-enhanced television services may require the use of a set-top box. For more information call your local cable operator.

This television also includes a QAM demodulator which should allow you to receive unscrambled digital cable television programming via subscription service to a cable service provider. Availability of digital cable television programming in your area depends on the type of programming and signal provided by your cable service provider.

IMPORTANT SAFEGUARDS

For your protection, please read these instructions completely, and keep this manual for future reference.

Carefully observe and comply with all warnings, cautions and instructions placed on the set, or described in the operating instructions or service manual.

WARNING

To guard against injury, the following basic safety precautions should be observed in the installation, use, and servicing of the set.

Use

Power Sources

This set should be operated only from the type of power source indicated on the serial/model plate. If you are not sure of the type of electrical power supplied to your home, consult your dealer or local power company. For those sets designed to operate from battery power, refer to the operating instructions.



Grounding or Polarization

This set is equipped with a polarized AC power cord plug (a plug having one blade wider than the other), or with a three-wire grounding type plug (a plug having a third pin for grounding). Follow the instructions below:

For the set with a polarized AC power cord plug

This plug will fit into the power outlet only one way. This is a safety feature. If you are unable to insert the plug fully into the outlet, try reversing the plug. If the plug should still fail to fit, contact your electrician to have a suitable outlet installed. Do not defeat the safety purpose of the polarized plug by forcing it in.



Alternate Warning

For the set with a three-wire grounding type AC plug

This plug will only fit into a grounding-type power outlet. This is a safety feature. If you are unable to insert the plug into the outlet, contact your electrician to have a suitable outlet installed. Do not defeat the safety purpose of the grounding plug.

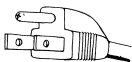

Overloading

Do not overload wall outlets, extension cords or convenience receptacles beyond their capacity, since this can result in fire or electric shock.



Always turn the set off when it is not to be used. When the set is left unattended and unused for long periods of time, unplug it from the wall outlet as a precaution against the possibility of an internal malfunction that could create a fire hazard.



Do not disconnect the antenna or the power cord during a heavy storm. Lightning may strike while you are holding the cable or cord, causing serious injury. Turn off your TV and wait for the weather to improve.

Corrosion

Use of this TV near the seashore may subject the set to excessive salt, corrosion and internal damage and result in deterioration of the TV's performance. If the set will be subjected to these conditions, steps should be taken to reduce the humidity and temperature of the area where the TV is located.

Object and Liquid Entry

Never push objects of any kind into the set through the cabinet slots as they may touch dangerous voltage points or short out parts that could result in a fire or electric shock. Never spill liquid of any kind on the set.



Attachments

Do not use attachments not recommended by the manufacturer, as they may cause hazards.

Do not place any objects, especially heavy objects, on top of the set. The object may fall from the set, causing injury.

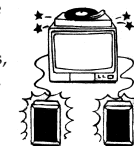

Cleaning

Unplug the set from the wall outlet before cleaning or polishing it. Do not use liquid cleaners or aerosol cleaners. Use a cloth lightly dampened with water for cleaning the exterior of the set.



If a snapping or popping sound from a TV set is continuous or frequent while the TV is operating, unplug the TV and consult your dealer or service technician. It is normal for some TV sets to make occasional snapping or popping sounds, particularly when being turned on or off.

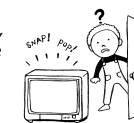

Installation

Always use two or more people to lift or move the set. The set is heavy and the bottom surface is flat. Serious injury can result from trying to move the set by yourself alone, or from unsteady handling. Install the set on a stable, level surface.

Water and Moisture

Do not use power-line operated sets near water — for example, near a bathtub, washbowl, kitchen sink, or laundry tub, in a wet basement, or near a swimming pool, etc.



Accessories

Do not place the set on an unstable cart, stand, tripod, bracket, table or shelf. The set may fall, causing serious injury to a child or an adult, and serious damage to the set. Use only a cart or stand recommended by the manufacturer for the specific model of TV. Any mounting of the product should follow the manufacturer's instructions, and should use a mounting accessory recommended by the manufacturer. An appliance and cart combination should be moved with care. Quick stops, excessive force, and uneven surfaces may cause the appliance and cart combination to overturn.



Disconnect all cables and cords from the set before attempting to move the set.

Do not allow children or pets to climb up onto, or push against, the set. The set may fall, causing serious injury.

Ventilation

The slots and openings in the cabinet and in the back or bottom are provided for necessary ventilation. To ensure reliable operation of the set, and to protect it from overheating, these slots and openings must never be blocked or covered.

- ❑ Never cover the slots and openings with a cloth or other materials.
- ❑ Never block the slots and openings by placing the set on a bed, sofa, rug or other similar surface.
- ❑ Never place the set in a confined space, such as a bookcase, or built-in cabinet, unless proper ventilation is provided.
- ❑ Do not place the set near or over a radiator or heat register, or where it is exposed to direct sunlight.

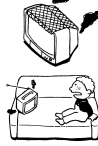

Power Cord Protection

Do not allow anything to rest on or roll over the power cord, and do not place the set where the power cord is subject to wear or abuse.



Antennas

Outdoor Antenna Grounding

If an outdoor antenna is installed, follow the precautions below. An outdoor antenna system should not be located in the vicinity of overhead power lines or other electric light or power circuits, or where it can come in contact with such power lines or circuits.

WHEN INSTALLING AN OUTDOOR ANTENNA SYSTEM, EXTREME CARE SHOULD BE TAKEN TO KEEP FROM CONTACTING SUCH POWER LINES OR CIRCUITS AS CONTACT WITH THEM IS ALMOST INVARIABLY FATAL.

Be sure the antenna system is grounded so as to provide some protection against voltage surges and built-up static charges. Section 810 of the National Electrical Code (NEC) in USA and Section 54 of the Canadian Electrical Code in Canada provide information with respect to proper grounding of the mast and supporting structure, grounding of the lead-in wire to an antenna discharge unit, size of grounding conductors, location of antenna discharge unit, connection to grounding electrodes, and requirements for the grounding electrode.

Antenna Grounding According to the National Electrical Code, ANSI/NFPA 70

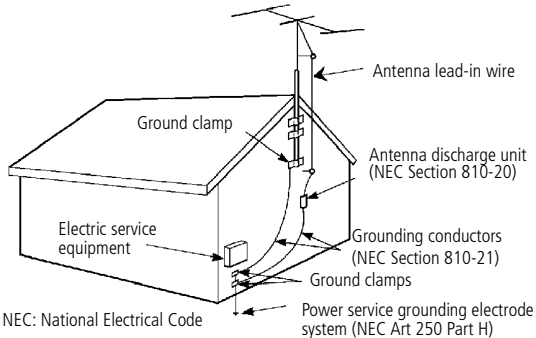

Lightning

For added protection for this television receiver during a lightning storm, or when it is left unattended and unused for long periods of time, unplug it from the wall outlet and disconnect the antenna. This will prevent damage to the receiver due to lightning and power line surges.

Service

Damage Requiring Service

Unplug the set from the wall outlet and refer servicing to qualified service personnel under the following conditions:

- ❑ When the power cord or plug is damaged or frayed.
- ❑ If liquid has been spilled into the set or objects have fallen into the product.
- ❑ If the set has been exposed to rain or water.
- ❑ If the set has been subject to excessive shock by being dropped, or the cabinet has been damaged.
- ❑ If the set does not operate normally when following the operating instructions. Adjust only those controls that are specified in the operating instructions. Improper adjustment of other controls may result in damage and will often require extensive work by a qualified technician to restore the set to normal operation.
- ❑ When the set exhibits a distinct change in performance, it indicates a need for service.

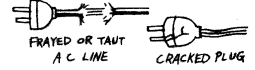

Servicing

Do not attempt to service the set yourself since opening the cabinet may expose you to dangerous voltage or other hazards. Refer all servicing to qualified service personnel.



Replacement Parts

When replacement parts are required, be sure the service technician certifies in writing that he has used replacement parts specified by the manufacturer that have the same characteristics as the original parts.

Unauthorized substitutions may result in fire, electric shock or other hazards.



Safety Check

Upon completion of any service or repairs to the set, ask the service technician to perform routine safety checks (as specified by the manufacturer) to determine that the set is in safe operating condition, and to so certify. When the set reaches the end of its useful life, improper disposal could result in a picture tube implosion. Ask a qualified service technician to dispose of the set.



Trademark Information

WOW, TruSurround and the  symbol are trademarks of SRS Labs, Inc. WOW and TruSurround technology are incorporated under license from SRS Labs, Inc.



Manufactured under license from Dolby Laboratories. Dolby and the double-D symbol are trademarks of Dolby Laboratories.



Manufactured under license from BBE Sound, Inc. Licensed by BBE Sound, Inc. under USP4638258, 5510752 and 5736897. BBE and BBE symbol are registered trademarks of BBE Sound, Inc.



This TV incorporates High-Definition Multimedia Interface (HDMI™) technology. HDMI, the HDMI logo and

High-Definition Multimedia Interface are trademarks or registered trademarks of HDMI Licensing LLC.

Wega, FD Trinitron, Steady Sound, Digital Reality Creation, CineMotion, MagicGate, Super Fine Pitch, MID, Clear Edge, ClearEdge VM and HD Detailer are trademarks of Sony Corporation.



As an ENERGY STAR® Partner, Sony Corporation has determined that this product meets the ENERGY STAR® guidelines for energy efficiency. ENERGY STAR® is a U.S. registered mark.

Contents

Contents

Introducing the FD Trinitron Wega

Overview	1
Presenting the FD Trinitron Wega	1
Package Contents	1
Features	1

Setting Up the TV

Overview	3
About the AC Power Cord	3
TV Controls and Connectors	3
Front Panel	3
Rear Panel	4
Basic Connections: Connecting a Cable or Antenna	5
Cable or Antenna Only	5
Connecting Two RF Inputs	6
Cable Box Only	6
Connecting Optional Equipment	7
Making Video Connections	7
About Using S VIDEO	7
VCR and Cable or Antenna	8
VCR and Cable Box	9
Satellite Receiver	11
Satellite Receiver and VCR	12
DVD Player with Component Video Connectors	14
DVD Player with S VIDEO and Audio Connectors	15
Camcorder	16
Audio Receiver	16
DVI-Equipped Device	17
HDMI-Equipped Device	18
Connecting a Device with Digital Audio IN Connector	19
Setting Up the Channel List	20
Using Initial Setup	20

Using the Remote Control

Overview	21
Inserting Batteries	21
Button Descriptions	22
Programming the Remote Control	24
Using Other Equipment with Your TV Remote Control	26
All Equipment	26
Operating a VCR	26
Operating a Satellite Receiver	26
Operating a Cable Box	27
Operating a DVD Player	27
Operating a DVD/VCR Combination Unit	27

Using the Features

Overview	28
Watching TV	28
Using the Program Guide	29
Using Screen Mode	30
Using Favorites Menu	32
Using the Favorites Menu	32
Using the Channel Settings	32
Using the Favorite Channels Guide	32

Using the Menu

Overview	33
Navigating Through Menu	33
Using the Menu	34
Using the Picture Settings	35
Selecting Picture Options	35
Using the Sound Settings	37
Selecting Sound Options	37
Using the Screen Settings	39
Selecting Screen Mode Options	39
Using the Channel Settings	40
Selecting Channel Options	40
Using the Parental Lock Settings	42
Selecting Parental Lock Options	42
US Models:	
Selecting Custom Rating Options	43
Viewing Blocked Programs	43
Canadian Models:	
Selecting Custom Rating Options	44
Viewing Blocked Programs	44
Using the Setup Settings	45
Selecting Setup Options	45
Programming Caption Vision	46
Using the Applications Settings	47
Selecting Applications Options	47

Other Information

Glossary	49
Contacting Sony	50
Troubleshooting	50
Remote Control	50
Channels	50
Sound	51
Picture	51
General	52
Specifications	53
Optional Accessories	53
Index	54

Introducing the *FD Trinitron Wega*

Overview

This chapter describes the contents of the package in which the TV is shipped and provides an overview of the features of your Wega TV.

Presenting the *FD Trinitron Wega*

The *FD Trinitron Wega* (pronounced VAY-GAH) is characterized by outstanding contrast, uncompromising accuracy, and corner-to-corner detail.

You will recognize the superiority of Wega technology almost immediately. The first thing you will probably notice is minimal glare from the flat picture tube. This flat-screen technology improves picture detail without distortion, unlike conventional curved screens. The *FD Trinitron* delivers outstanding image detail not only at the screen center, but also at the corners — so you can enjoy a bright, clear picture from any location in a room.

Package Contents

Along with your new *Trinitron* TV, the packing box contains a remote control and two AA batteries. These items are all you need to set up and use the TV.

Features

Some of the features that you will enjoy with your new TV include:

- ❑ **Built-in Digital Television Receiver:** You can watch digital television programs and enjoy the improved audio/video quality offered by these programs. With high-definition signal reception, you can watch TV signals broadcast in HDTV for the clearest possible broadcast picture.
- ❑ **Screen Mode:** Enables you to resize the picture.
- ❑ **DRC® (Digital Reality Creation) Multifunction:** Unlike conventional line doublers, the DRC Multifunction feature replaces the signal's NTSC waveform with the near-HD equivalent, while doubling the number of vertical and horizontal lines. This results in four times the density for quality sources, such as DVD, satellite, and digital camcorders. The Picture Settings allow you to select interlaced, progressive, or CineMotion™ output.
- ❑ **Favorites Menu:** Allows you to select from 16 of your favorite channels.

- ❑ **ClearEdge VM™ Velocity Modulation:** Sharpens picture definition by enhancing vertical lines.
- ❑ **Steady Sound®:** Equalizes volume levels so there is consistent output between programs and commercials.
- ❑ **Component Video Inputs:** Offers the best video quality for DVD (480p, 480i), and digital set-top box (HD1080i, 720p) connections.
- ❑ **HD Detailer™:** Wideband video amplifier has a high bandwidth frequency rating, which allows it to send more video information to the screen, resulting in finer picture quality, especially for HD sources.
- ❑ **CineMotion™:** Inverse 3-2 pulldown processing provides optimal picture quality for film-based sources (media originally shot in 24 frames-per-second format).
- ❑ **Parental Control:** V-Chip technology allows parents to block unsuitable programming from younger viewers.
- ❑ **HDMI (High-Definition Multimedia Interface):** Provides an uncompressed, all-digital audio/video interface between this TV and any HDMI-equipped audio/video component, such as a set-top box, DVD player, and A/V receiver. HDMI supports enhanced, or high-definition video, plus two-channel digital audio.
- ❑ **BBE:** Gives sound more impact by using audio technology to compensate for phase effects in speakers.

Setting Up the TV

Overview

This chapter includes illustrated instructions for setting up your TV.

About the AC Power Cord

The AC power cord is attached to the rear of the TV with a hook. Use caution when removing the AC plug from its holder. Gently slide the plug upward to remove it from the hook. Once removed, the AC power plug should automatically disengage from its stored location.

 Do not plug in the AC power cord until you have made all other connections.

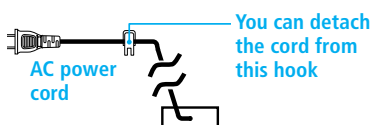

TV Controls and Connectors

Front Panel

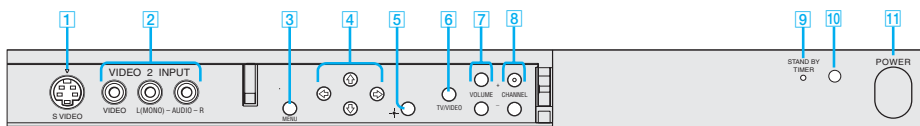

Item	Description
1 S VIDEO VIDEO 2 INPUT	Connects to the S VIDEO OUT jack on your camcorder or other video equipment that has S VIDEO. Provides better picture quality than composite video (2).
2 VIDEO/L(MONO)-AUDIO-R VIDEO 2 INPUT	Connects to the composite A/V output jacks on your camcorder or other video equipment.
3 MENU	Press to display the Menu. Press again to exit from the Menu. For details, see “Using the Menu” on page 33.
4 ↑ ↓ ← →	Press ↑ ↓ ← → to move the TV’s on-screen cursor.
5 +	Press to select an item in the TV’s Menu.
6 TV/VIDEO	Press repeatedly to cycle through the video equipment connected to the TV’s video inputs.
7 -VOLUME +	Press to adjust the volume.
8 -CHANNEL+	Press to scan through channels. To scan quickly through channels, press and hold down either CHANNEL button.
9 TIMER/STAND BY LED	Blinks when the TV is turned on, then shuts off when the picture is displayed. If the LED blinks continuously, this may indicate the TV needs service (see “Contacting Sony” on page 50). When lit, indicates one of the timers is set. When the timer is set, this LED will remain lit even if the TV is turned off. For details, see page 47.
10 Infrared Receiver (IR)	Receives IR signals from the TV’s remote control.
11 POWER	Press to turn on and off the TV.

Rear Panel

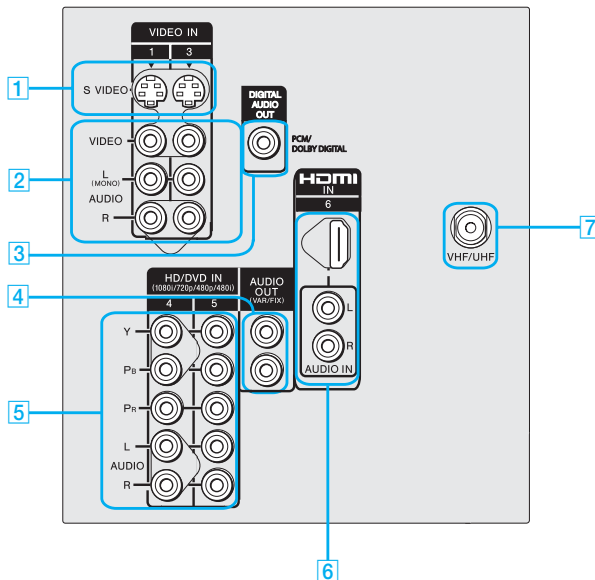

Jack	Description
1 S VIDEO IN 1/3	Connects to the S VIDEO OUT jack of your VCR or other video equipment that has S VIDEO. S VIDEO provides better picture quality than either composite video (2) or VHF/UHF (7) connections.
2 VIDEO IN 1/3 VIDEO/L (MONO) -AUDIO-R	Connect to the composite A/V output jacks on your VCR or other video component. A third composite A/V input jack (VIDEO 2) is located on the front panel of the TV. This video connection provides better picture quality than the VHF/UHF (7) connection.
3 DIGITAL AUDIO OUTPUT (DOLBY DIGITAL PCM)	Connect to the Digital audio input of an audio component that is Dolby* Digital and PCM compatible.
4 AUDIO OUT (VAR/FIX)	Connects to the left and right audio input jacks of your audio or video equipment. You can use these outputs to listen to your TV's audio through your stereo system.
5 HD/DVD IN 4/5 (1080i/720p/480p/480i)	Connect to your DVD player's or digital set-top box's component video (YPbPr) and audio (L/R) jacks. Component video provides better picture quality than 1 , 2 , or 7 .
6 HDMI (VIDEO 6 IN)	HDMI (High-Definition Multimedia Interface) provides an uncompressed, all-digital audio/video interface between this TV and any HDMI-equipped audio/video component, such as a set-top box, DVD player, and A/V receiver. HDMI supports enhanced, or high-definition video, plus two-channel digital audio.
7 VHF/UHF	RF input that connects to your VHF/UHF antenna or cable box.

* Dolby and the double-D symbol are trademarks of Dolby Laboratories.

Basic Connections: Connecting a Cable or Antenna

The way in which you will connect your TV varies, depending on how your home receives a signal (cable, cable box, antenna) and whether or not you plan to connect a VCR.

Cable or Antenna Only

For best results, use one of the following connections if you are connecting a cable or an antenna and you:

- ❑ Do not need a cable box to unscramble channels. (If you have a cable box, see page 6.)
- ❑ Do not intend to connect a VCR. (If you have a VCR, see pages 8 and 9.)

The connection you choose depends on the cable type you have in your home, as described below.

75-ohm coaxial cable

Cable Type	Connect As Shown
VHF Only or VHF/UHF or Cable	 <p>75-ohm coaxial cable</p> <p>TV VHF/UHF</p>
VHF Only or UHF Only or combined VHF/UHF	 <p>300-ohm twin lead cable</p> <p>TV VHF/UHF</p> <p>Antenna connector (not supplied)</p>
VHF and UHF	 <p>75-ohm coaxial cable</p> <p>TV VHF/UHF</p> <p>U/V mixer (not supplied)</p> <p>300-ohm twin lead cable</p>

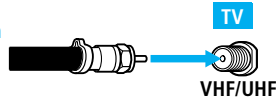

300-ohm twin lead cable

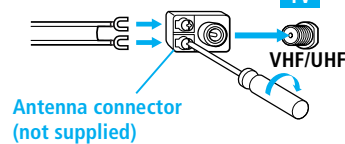

75-ohm coaxial and 300-ohm twin lead cable

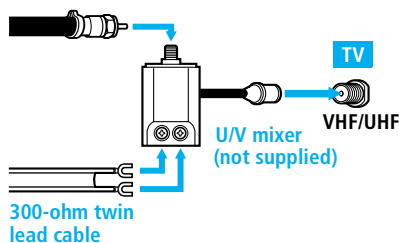

Connecting Two RF Inputs

If you want to watch RF signals for both antenna (over-the-air) and cable broadcast signals, you'll need to use an optional A-B switch for RF inputs (not supplied), as shown below.

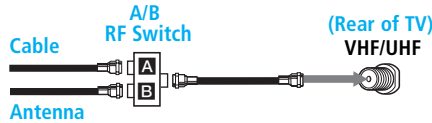

Use the A-B selector to switch between the over-the-air signals and the cable signals. Then set the **Cable** setting in the Channel Settings to **On** or **Off**, as described on page 40.

For best results, be sure to use an RF switch, as shown above, instead of a simple splitter.

Cable Box Only

For best results, use this connection if:

- Your cable company scrambles all channels, which requires you to use a cable box.
- You do not have a VCR. (If you have a VCR, see pages 8 and 9.)

With this connection you can:

- Use the TV remote control to change channels coming through the cable box to the TV's VHF/UHF jack. (You must first program the remote control for your specific cable box.)

To connect the cable box

- 1 Connect the CATV cable to the cable box's input jack.
- 2 Use a coaxial cable to connect the cable box's output jack to the TV's VHF/UHF jack.

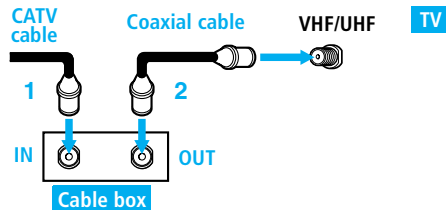

- 3 Run Auto Program, as described in "Setting Up the Channel List" on page 20.

Notes on Using This Connection





To Do This ...	Do This ...
Use the cable box	Tune the TV to the channel the cable box is set to (usually channel 3 or 4) and then use the cable box to switch channels.
Set up the TV remote control to operate the cable box	Program the remote control. See "Programming the Remote Control" on page 24.
Activate the remote control to operate the cable box	Press SAT/CABLE FUNCTION .

Connecting Optional Equipment

Use the directions in this section to connect the following optional equipment:

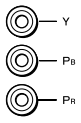
Making Video Connections

Your TV includes several types of video inputs. When connecting your TV, use the outputs that are available on your components that provide the best video performance, as described below.

Best Video Performance	
	HDMI (High-Definition Multimedia Interface)
	Component video
	S VIDEO
	Composite video
	RF/Coaxial
Good Video Performance	

About Using S VIDEO



If the optional equipment you are connecting has an S VIDEO jack (shown at left), you can use an S VIDEO cable for improved picture quality (compared to an A/V cable). Because S VIDEO carries only the video signal, you also need to connect audio cables for sound, as shown below.

Example of an S VIDEO Connection

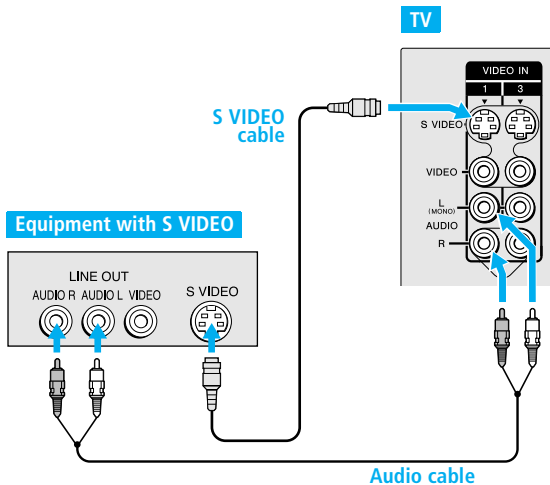

Cables are often color-coded to connectors. Connect red to red, white to white, etc.

VCR and Cable or Antenna



Using
S VIDEO jacks?
See page 7.

For best results, use this connection if:

- Your cable company does not require you to use a cable box.

To connect the VCR and Cable or Antenna

- 1 Connect the CATV cable or Antenna to the VCR's input jack.
- 2 Use a coaxial cable to connect the VCR's output jack to the TV's VHF/UHF jack.
- 3 Use an A/V cable to connect the VCR's A/V output jacks to the TV's A/V input jacks.
- 4 Run Auto Program, as described in "Setting Up the Channel List" on page 20.

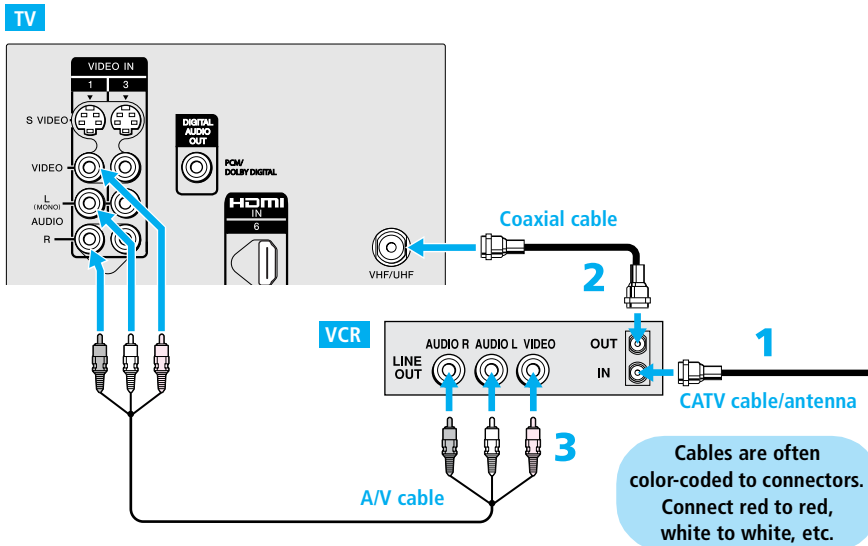

Notes on Using This Connection

To Do This ...	Do This ...
Watch the VCR	Press TV/VIDEO repeatedly to select the VCR input (VIDEO 1 in the illustration).
Watch cable channels	Press TV/VIDEO repeatedly to select the cable input.
Set up the TV remote control to operate the VCR	If you have a non-Sony VCR, you must program the remote control. See "Programming the Remote Control" on pages 24-25.
Activate the TV remote control to operate the VCR	Press VCR/DVD FUNCTION .
Control VCR functions with the TV remote control	See "Operating a VCR" on page 26.
Label video inputs to easily identify equipment connected to the TV	See the instructions for setting up Video Labels on page 45.

VCR and Cable Box

For best results, use this connection if:

- ❑ Your cable company scrambles some channels, such as premium channels (which requires you to use a cable box), but does not scramble all channels.

With this connection you can:

- ❑ Use the TV remote control to change channels coming through the cable box. (You must first program the remote control for your specific cable box; see “Programming the Remote Control” on page 24.)
- ❑ Use the TV remote control to change channels coming directly into the TV’s VHF/UHF jack. (The TV’s tuner provides a better signal than the cable box.)
- ❑ Record channels coming through the cable box and channels coming directly into the TV.

To connect a VCR and cable box, you need:

- ❑ A splitter, which is a small, inexpensive device that you can purchase at your local electronics store.
- ❑ Four coaxial cables.
- ❑ Two A/V cables or two S VIDEO cable with audio cables.

To connect the VCR and cable box

- 1 Connect the CATV cable to the single (input) jack of the splitter.
- 2 Use a coaxial cable to connect one of the splitter’s two output jacks to the TV’s VHF/UHF jack.
- 3 Use a coaxial cable to connect the splitter’s other output jack to the cable box’s input jack.
- 4 Use a coaxial cable to connect the cable box’s output jack to the VCR’s RF input jack.
- 5 Use an A/V cable to connect the cable box’s A/V output jacks to the TV’s A/V input jacks.
- 6 Use an A/V cable to connect the VCR’s A/V output jacks to the TV’s A/V input jacks.
- 7 Run Auto Program, as described in “Setting Up the Channel List” on page 20.



Using
S VIDEO jacks?
See page 7.

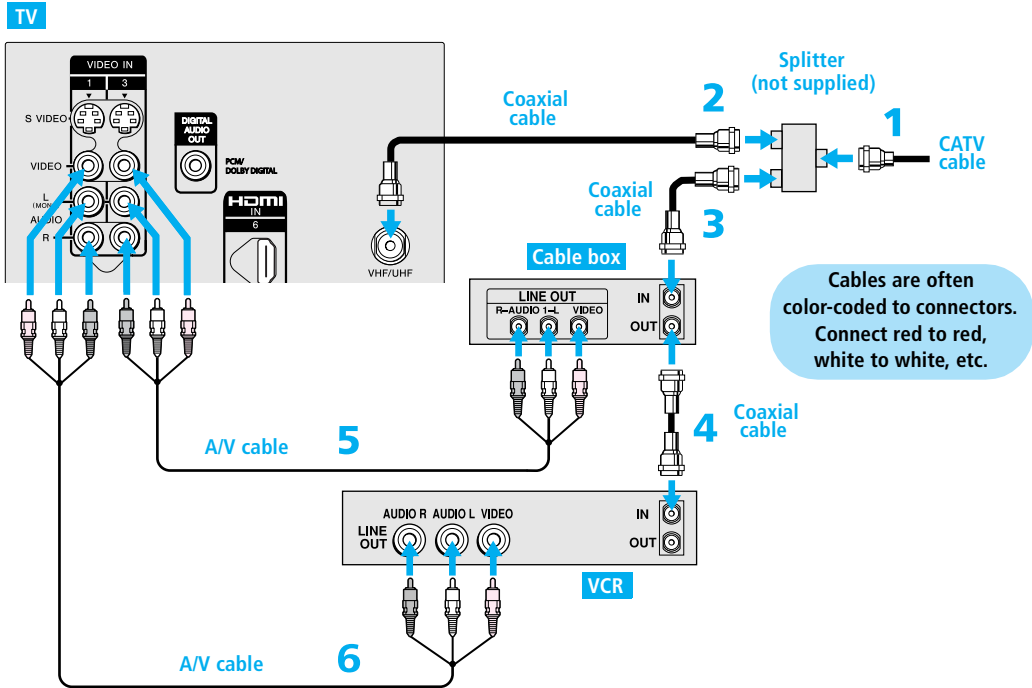

Notes on Using This Connection

To Do This ...	Do This ...
Watch cable (unscrambled) channels	Press TV/VIDEO repeatedly to select the cable input.
Watch cable box (scrambled) channels	Press TV/VIDEO repeatedly to select the cable box input (VIDEO 3 in the illustration). Use the cable box to change channels.
Watch the VCR	Press TV/VIDEO repeatedly to select the VCR input (VIDEO 1 in the illustration).
Set up the TV remote control to operate the cable box or VCR	If you have a non-Sony VCR, you must program the remote control. See "Programming the Remote Control" on pages 24-25.
Activate the remote control to operate the cable box or VCR	For the cable box, press SAT/CABLE FUNCTION . For the VCR, press VCR/DVD FUNCTION .
Control specific cable box and VCR functions with the TV remote control	See "Operating a Cable Box" on page 27 and "Operating a VCR" on page 26.
Label video inputs to easily identify equipment connected to the TV	See the instructions for setting up Video Labels on page 45.

Satellite Receiver



Using
S VIDEO jacks?
See page 7.

To connect a satellite receiver

- 1 Connect the satellite antenna cable to the satellite receiver's satellite input jack.
- 2 Use an A/V cable to connect the satellite receiver's A/V output jacks to the TV's A/V input jacks.
- 3 Connect a CATV cable from your cable or antenna to the TV's CABLE jack.
- 4 Run Auto Program, as described in "Setting Up the Channel List" on page 20.

TV

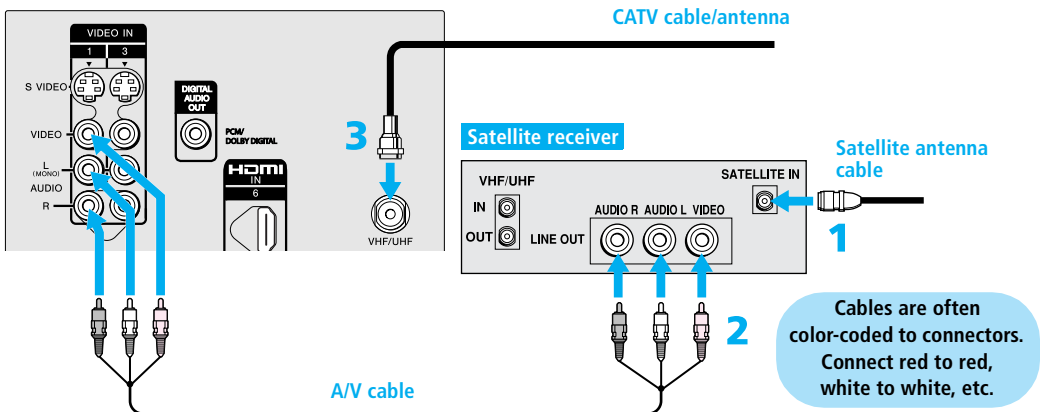

Notes on Using This Connection

To Do This ...	Do This ...
Watch the satellite receiver	Press TV/VIDEO repeatedly to select the satellite receiver input (VIDEO 1 in the illustration).
Set up the TV remote control to operate the satellite receiver	If you have a non-Sony satellite receiver, you must program the remote control. See "Programming the Remote Control" on pages 24-25.
Activate the TV remote control to operate the satellite receiver	Press SAT/CABLE FUNCTION .
Control satellite receiver functions with the TV remote control	See "Operating a Satellite Receiver" on page 26.
Label video inputs to easily identify equipment connected to the TV	See the instructions for setting up Video Labels on page 45.

Satellite Receiver and VCR



Using
S VIDEO jacks?
See page 7.

To connect a satellite receiver and VCR

- 1 Connect the CATV cable or Antenna to the single (input) jack of the splitter.
- 2 Use a coaxial cable to connect one of the splitter's two output jacks to the TV's VHF/UHF jack.
- 3 Use a coaxial cable to connect the splitter's other output jack to the satellite receiver's VHF/UHF input jack.
- 4 Connect the satellite antenna cable to the satellite receiver's satellite input jack.
- 5 Use a coaxial cable to connect the satellite receiver's VHF/UHF output jack to the VCR's VHF/UHF input jack.
- 6 Use an A/V cable to connect the satellite receiver's A/V output jacks to the TV's A/V input jacks.
- 7 Use an A/V cable to connect the VCR's A/V output jacks to the TV's A/V input jacks.
- 8 Run Auto Program, as described in "Setting Up the Channel List" on page 20.

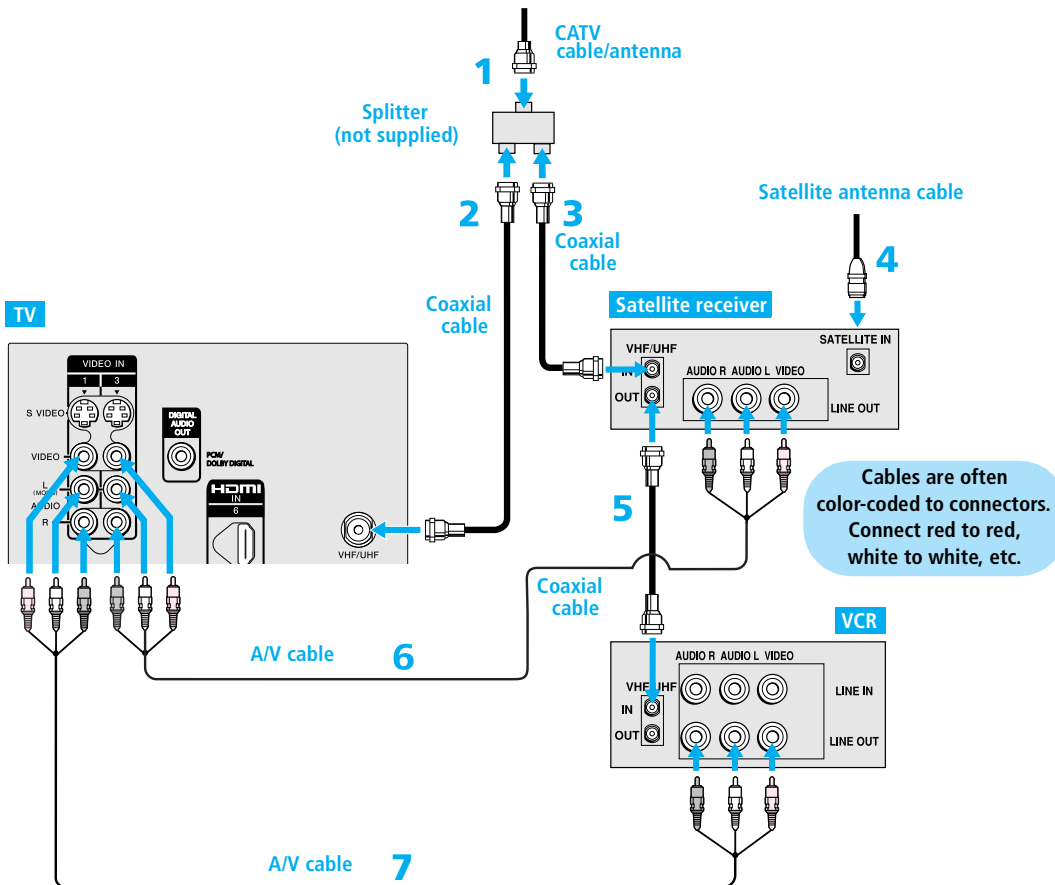

Notes on Using This Connection

To Do This ...	Do This ...
Watch the satellite receiver	Press TV/VIDEO repeatedly to select the VCR input (VIDEO 3 in the illustration).
Watch the VCR	Press TV/VIDEO repeatedly to select the input to which the VCR is connected (VIDEO 1 in the illustration).
Set up the TV remote control to operate the satellite receiver or VCR	If you have a non-Sony VCR or satellite receiver, you must program the remote control. See “Programming the Remote Control” on pages 24-25.
Activate the TV remote control to operate the satellite receiver or VCR	For the satellite receiver, press SAT/CABLE FUNCTION . For the VCR, press VCR/DVD FUNCTION .
Control satellite receiver and VCR functions with the TV remote control	See “Operating a Satellite Receiver” and “Operating a VCR” on page 26.
Label video inputs to easily identify equipment connected to the TV	See the instructions for setting up Video Labels on page 45.

DVD Player with Component Video Connectors

For best results, use this connection if your DVD player has component video (YPbPr) jacks.

To connect a DVD player with component video connectors

- 1 Use three separate component video cables to connect the DVD player's YPbPr jacks to the YPbPr jacks (VIDEO 4) on the TV.

 The YPbPr jacks on your DVD player are sometimes labeled Y, Cb and Cr, or Y, B-Y and R-Y. If so, connect the cables to like colors.

- 2 Use an audio cable to connect the DVD player's audio output jacks to the TV's VIDEO 4 audio input jacks.

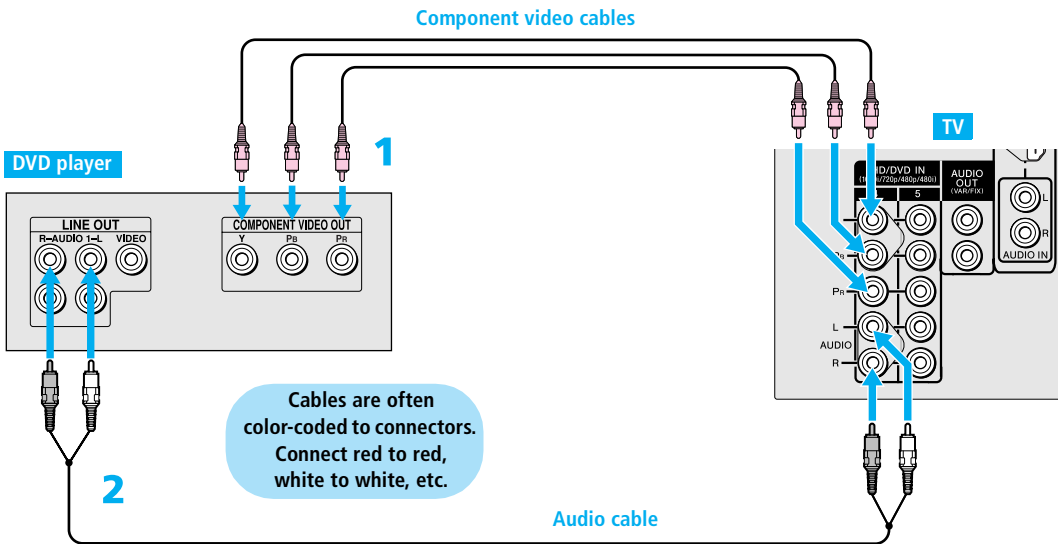

Notes on Using This Connection

To Do This ...	Do This ...
Watch the DVD player	Press TV/VIDEO repeatedly to select the DVD input (VIDEO 4 in the illustration).
Set up the TV remote control to operate the DVD player	If you have a non-Sony DVD player, you must program the remote control. See "Programming the Remote Control" on pages 24-25.
Activate the TV remote control to operate the DVD player	Press VCR/DVD FUNCTION .
Control DVD functions with the TV remote control	See "Operating a DVD Player" on page 27.
Label video inputs to easily identify equipment connected to the TV	See the instructions for setting up Video Labels on page 45.

 You cannot record the signal from any equipment connected into the YPbPr jacks.

DVD Player with S VIDEO and Audio Connectors

Use this connection if your DVD player does not have component video (YPbPr) jacks.

To connect a DVD player with A/V connectors

- 1 Use an audio cable to connect the DVD player's audio output jacks to the TV's audio input jacks.
- 2 Use an S VIDEO cable to connect the DVD player's S VIDEO jack to the TV's S VIDEO jack.

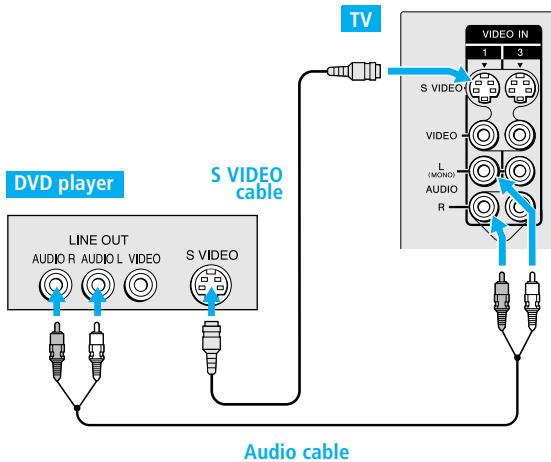

Cables are often color-coded to connectors. Connect red to red, white to white, etc.

Notes on Using This Connection

To Do This ...	Do This ...
Watch the DVD player	Press TV/VIDEO repeatedly to select the DVD input (VIDEO 1 in the illustration).
Set up the TV remote control to operate the DVD player	If you have a non-Sony DVD player, you must program the remote control. See "Programming the Remote Control" on pages 24-25.
Activate the TV remote control to operate the DVD player	Press VCR/DVD FUNCTION .
Control DVD functions with the TV remote control	See "Operating a DVD Player" on page 27.
Label video inputs to easily identify equipment connected to the TV	See the instructions for setting up Video Labels on page 45.

Camcorder



Using
S VIDEO jacks?
See page 7.

For easy connection of a camcorder, the TV has front A/V input jacks. If you prefer, however, you can connect the camcorder to the TV's rear A/V input jacks.

To connect a camcorder

- 1 Use A/V cables to connect the camcorder's A/V output jacks to the TV's A/V input jacks.

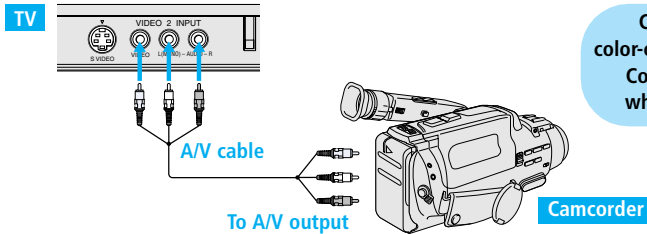

If you have a mono camcorder, connect its audio output jack to the TV's L MONO audio jack.

Notes on Using This Connection

To Do This ...

Watch the camcorder

Label video inputs to easily identify equipment connected to the TV

Do This ...

Press **TV/VIDEO** repeatedly to select the camcorder input (VIDEO 2 in the illustration).

See the instructions for setting up Video Labels on page 45.

Audio Receiver

For improved sound quality, you may want to play the TV's audio through your stereo system.

To connect an audio system

- 1 Use an audio cable to connect the TV's audio output jacks to the audio receiver's line input jacks.

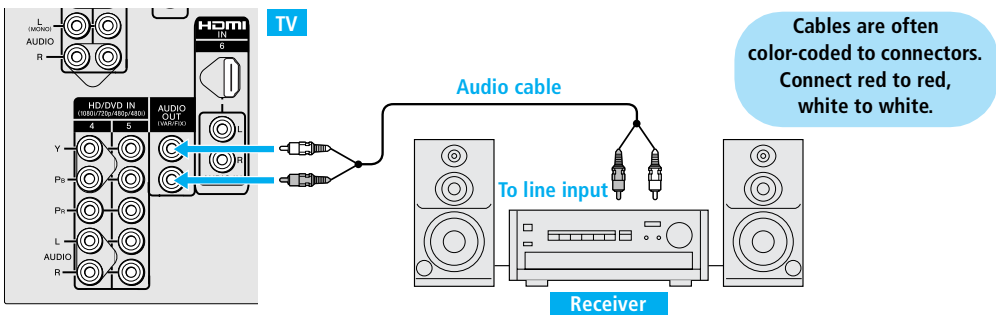

- 2 Using the TV's Sound Settings, set the **Speaker** option to **Off**. Then set the **Audio Out** option to **Fixed** or **Variable**, depending on how you want to control the volume. For details, see "Using the Sound Settings" on page 37.
- 3 Turn on the audio receiver, and then set the receiver's line input to the jack into which you connected the TV.

DVI-Equipped Device

If you have a device, such as an HDTV receiver, that has DVI (Digital Video Interface) output, use the following connection.

To connect a device that has DVI OUT:

- 1 Use an HDMI-to-DVI cable to connect the device's DVI OUT jack to the TV's HDMI IN jack.

 You can purchase HDMI cables (or cable adapters) at your local electronics store.

- 2 Use an audio cable to connect the device's audio output jacks to the TV's HDMI analog audio input jacks.

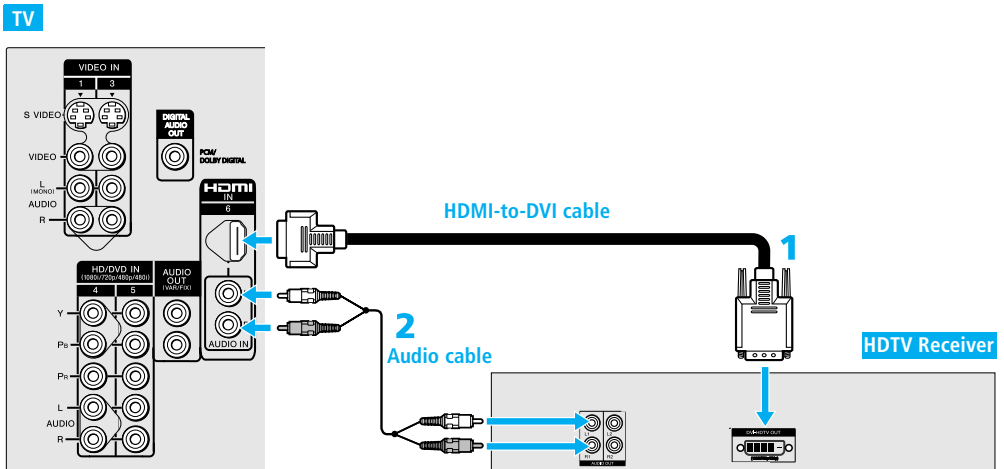

Note on Using This Connection

To Do This ...

Watch the DVI device
Label video inputs to easily
identify equipment connected
to the TV

Do This ...

Press **TV/VIDEO** repeatedly to select the VIDEO 6 input.
See the instructions for setting up Video Labels on page 45.

HDMI-Equipped Device

If you have a device, such as an HDTV receiver, that has a High-Definition Multimedia Interface (HDMI), use the following connection.

To connect a device that has HDMI OUT:

- 1 Use the HDMI cable that came with your device to connect the device's HDMI OUT jack to the TV's HDMI IN jack.

 HDMI cables transmit both audio and video signals. (Separate audio cables are not necessary.) You can purchase HDMI cables at your local electronics store.

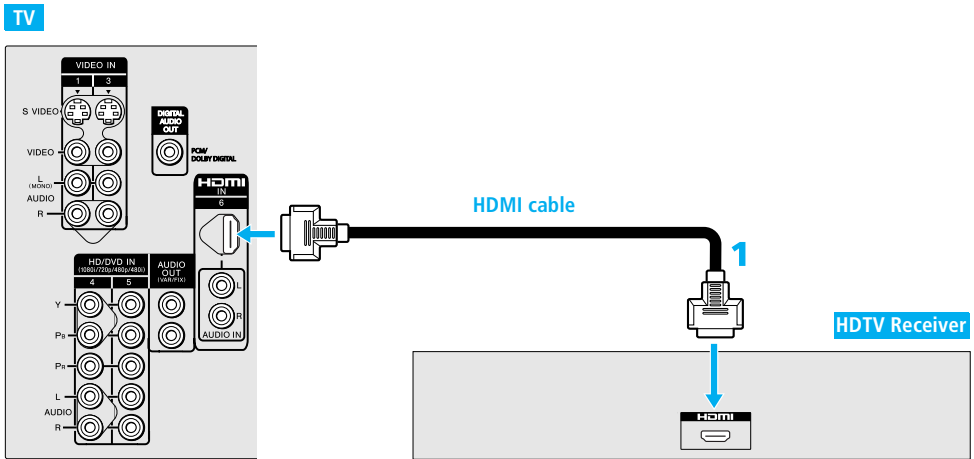

Note on Using This Connection

To Do This ...	Do This ...
Watch the HDMI device	Press TV/VIDEO repeatedly to select the VIDEO 6 input.
Label video inputs to easily identify equipment connected to the TV	See the instructions for setting up Video Labels on page 45.

Connecting a Device with Digital Audio IN Connector

You can use the TV's DIGITAL AUDIO output jack to connect an audio device that is Dolby Digital and PCM compatible, such as an audio amplifier.

- Using a RCA cable, connect the TV's DIGITAL AUDIO output jack to the device's audio DIGITAL AUDIO input jack.

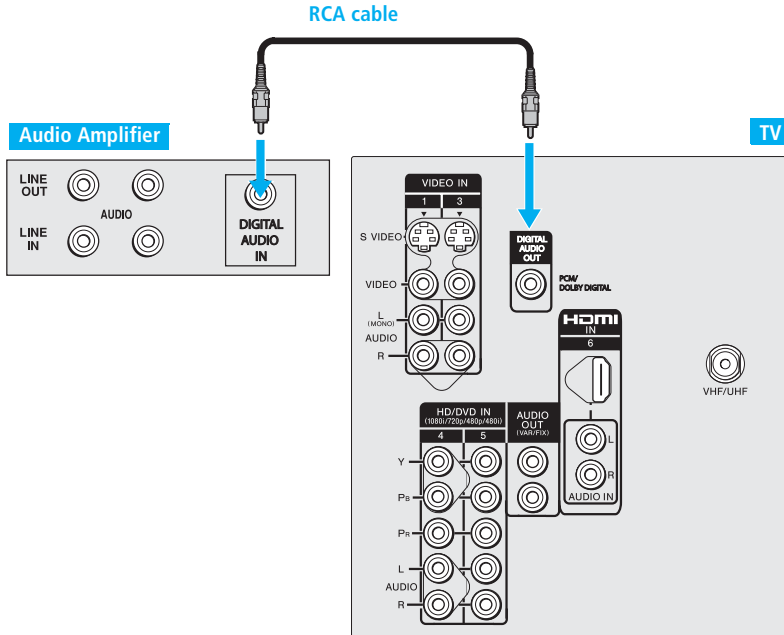



 Because all equipment does not output digital audio, you should also connect the TV's analog audio output jacks to the amplifier's analog audio input jacks, as described on page 16.

Setting Up the Channel List

After you finish connecting the TV, you need to run the Initial Setup feature, which automatically creates a list of available analog and digital channels and lets you correct tilt and vertical correction settings. The Initial Setup screens appear when you turn on your TV for the first time after hooking it up.

Using Initial Setup

 For more details on using Tilt Correction and Vertical Correction, see pages 45-46.







 To exit the Tilt Correction and Vertical Correction screens, press the **MENU** button.

To run Initial Setup

- 1 Press **POWER** to turn on the TV.

The Initial Setup screen appears.

Using the remote control, move the highlight to the desired language, then press  to select that language. The Tilt Correction screen appears.

- 2 Press   to correct any tilt of the picture. You can choose a correction between +7 and -7. When finished, press .
- 3 The Vertical Correction screen appears. Press   to make a vertical correction to the picture. You can choose a correction between +5 and -5. When finished, press .

- 4 The next screen instructs you to connect your cable/antenna. Check that you've connected your signal source correctly.

To start Auto Program, highlight **Yes** and then press .

Auto Program automatically creates a list of receivable analog and digital channels. Auto Program may take 50 minutes or more to complete. A progress bar is displayed while the channel list is being created.

When Auto Program is finished, the lowest numbered channel is displayed.

To run Auto Program again at a later time

- Use the Auto Program feature as described on page 40.

To add individual digital channels

- Use the Digital Channel feature as described on page 40.

To reset the TV to factory settings

- 1 Press **POWER** to turn on the TV.
- 2 Hold down **RESET** on the remote control.
- 3 Press **TV POWER** on the TV. (The TV will turn itself off, then back on).
- 4 Release **RESET**.

Using the Remote Control

Overview

This chapter describes how to set up, program, and use the TV's remote control.

Inserting Batteries

- 1 Remove the battery cover from the remote control.
- 2 Insert two size AA batteries (supplied) by matching the \oplus and \ominus terminals on the batteries to the diagram inside the battery compartment.
- 3 Replace the battery cover.

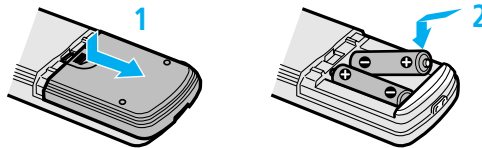

 Remove the batteries to avoid damage from possible battery leakage whenever you anticipate that the remote control will not be used for an extended period.







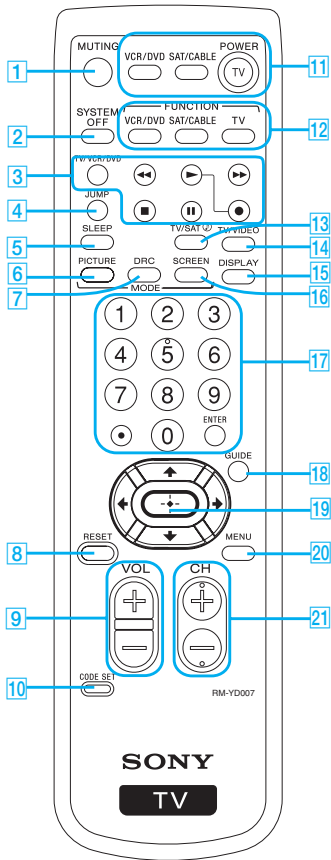

Handle the remote control with care.

Avoid dropping it, getting it wet, placing it in direct sunlight, near a heater, or where the humidity is high.

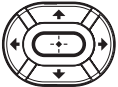
Button Descriptions



Button	Description
1 MUTING	Press to mute the sound. Press again or press VOL+ to restore the sound.
2 SYSTEM OFF	Press to turn off all Sony brand audio/video equipment at once. (May not function with older Sony equipment. Does not function with DVD/VCR combination unit.)
3 TV/VCR/DVD	Press to change the VHF/UHF output of the VCR (or DVD/VCR combination unit).
Transport Buttons	<ul style="list-style-type: none"> ◀◀ Rewind ▶ Play ● Record (press together with ▶) ■ Stop ▶▶ Fast forward Pause
4 JUMP	Press to jump back and forth between two channels. The TV alternates between the current channel and the last channel that was selected.
5 SLEEP	Press repeatedly until the TV displays the time in minutes (15, 30, 45, 60, 90 or 120) that you want the TV to remain on before shutting off automatically. To cancel press until Sleep Off appears. While the Sleep feature is set, press once to display the remaining time.
6 PICTURE MODE	Press repeatedly to cycle through the available video picture modes: Vivid , Standard , Movie , Pro . Also available in the Picture Settings. For details, see "Selecting Picture Options" on page 35.
7 DRC MODE	Press repeatedly to cycle through the available Digital Reality Creation modes: Interlaced , Progressive , CineMotion . Also available in the Picture Settings. For details, see "Selecting Picture Options" on pages 35-36.
8 RESET	Press to reset the settings to the factory defaults. See pages 20, 35, and 37. Also used to clear Favorite Channels (see page 32).
9 VOL +/-	Press to adjust the volume.
10 CODE SET	Press to program the remote control to operate non-Sony video equipment. For details, see "Programming the Remote Control" on page 24.
11 POWER Buttons	<p>VCR/DVD: Press to turn on and off the VCR or DVD player.</p> <p>SAT/CABLE: Press to turn on and off the satellite receiver or cable box.</p> <p>TV: Press to turn on and off the TV.</p>

Button	Description
12 FUNCTION Buttons	<p>The indicator lights up momentarily when pressed to show which equipment the remote control is operating:</p> <p>VCR/DVD: Press to have the remote control operate the VCR or DVD player.</p> <p>SAT/CABLE: Press to have the remote control operate the satellite receiver or cable box.</p> <p>TV: Press to have the remote control operate the TV.</p>
13 TV/SAT	<p>When the remote control is set to operate the satellite receiver, press to switch between the satellite receiver's TV and SAT (satellite) inputs.</p>
	<p>When the remote control is set to operate the TV, press repeatedly to step through the Audio Effect options. Also available in the Sound Settings. For details, see page 37.</p>
14 TV/VIDEO	Press repeatedly to cycle through the TV's video inputs.
15 DISPLAY	Press once to display the current channel number, current time, and channel label (if set) and other information. Press again to turn Display off.
16 SCREEN MODE	Press to toggle between the Screen Mode options. For details on using Screen Mode, see pages 30-31. Also available in the Screen Settings (page 39).
17 0 - 9 ENTER 	Press 0 - 9 to select a channel; the channel changes after 3 seconds. Press ENTER to change channels immediately. Use the  button with 0-9 and ENTER buttons to select digital channels (for example, 2.1). For details on selecting digital channels, see page 28.
18 GUIDE	Press to display the program guide of your satellite program provider.
19 	<p>Press     to move the on-screen cursor. To select an item, press .</p> <p>When no menus are displayed, pressing  displays the Favorite Channels screen. (For more information about Favorites Menu, see page 32.)</p>
20 MENU	Press to display the Menu. Press again to exit from the Menu. For details, see "Using the Menu" on page 33.
21 CH +/-	Press to scan through channels. To scan quickly through channels, press and hold down either CH button.

Programming the Remote Control

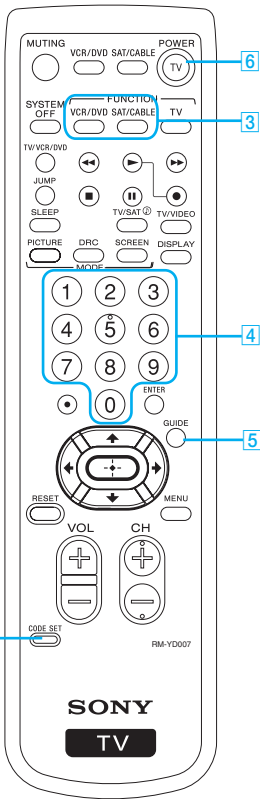

If you have video equipment other than Sony brand (or if you have a Sony DVD/VCR combination unit) that you want to control with the TV's remote control, use the following procedure to program the remote control.

The equipment must have infrared (IR) remote capability in order to be used with the remote control.

- 1 Turn to the list of "Manufacturer's Codes" on page 25, and find the three-digit code number for the manufacturer of your equipment. (If more than one code number is listed, use the number listed first.)
- 2 Press **CODE SET**.
- 3 Press the **VCR/DVD FUNCTION** or **SAT/CABLE FUNCTION** button.
- 4 Using the **0-9** buttons, enter the three-digit manufacturer's code number.
- 5 Press the **ENTER** button.

You must do step 5 within 10 seconds of step 4, or you must redo steps 2 through 5.

- 6 To check if the code number works, aim the TV's remote control at the equipment and press the **POWER** button that corresponds with that equipment. If it responds, you are done. If not, try using another code listed for that manufacturer.

Notes

- ❑ If more than one code number is listed, try entering them one by one until you come to the correct code for your equipment.
- ❑ If you enter a new code number, the code number you previously entered at that setting is erased.
- ❑ In some cases, you may not be able to operate your equipment with the supplied remote control. In such cases, use the equipment's own remote control.
- ❑ Whenever you remove the batteries to replace them, the code numbers may revert to the factory setting and must be reprogrammed.

Manufacturer's Codes

VCRs

<i>Manufacturer</i>	<i>Code</i>
Sony	301, 302, 303
Admiral (M. Ward)	327
Aiwa	338, 344
Audio Dynamic	314, 337
Broksonic	319, 317
Canon	309, 308
Citizen	332
Craig	302, 332
Criterion	315
Curtis Mathes	304, 338, 309
Daewoo	341, 312, 309
DBX	314, 336, 337
Dimensia	304
Emerson	319, 320, 316, 317, 318, 341
Fisher	330, 335
Funai	338
General Electric	329, 304, 309
Go Video	322, 339, 340
Goldstar	332
Hitachi	306, 304, 305, 338
Instant Replay	309, 308
JC Penney	309, 305, 304, 330, 314, 336, 337
JVC	314, 336, 337, 345, 346, 347
Kenwood	314, 336, 332, 337
LXI (Sears)	332, 305, 330, 335, 338
Magnavox	308, 309, 310
Marantz	314, 336, 337
Marta	332
Memorex	309, 335
Minolta	305, 304
Mitsubishi/ MGA	323, 324, 325, 326
Multitech	325, 338, 321
NEC	314, 336, 337
Olympic	309, 308
Optimus	327
Orion	317
Panasonic	308, 309, 306, 307
Pentax	305, 304
Philco	308, 309
Philips	308, 309, 310
Pioneer	308
Quasar	308, 309, 306
RCA/ PROSCAN	304, 305, 308, 309, 311, 312, 313, 310, 329

<i>Manufacturer</i>	<i>Code</i>
Realistic	309, 330, 328, 335, 324, 338
Sansui	314
Samsung	322, 313, 321
Sanyo	330, 335
Scott	312, 313, 321, 335, 323, 324, 325, 326
Sharp	327, 328
Signature 2000 (M. Ward)	338, 327
SV2000	338
Sylvania	308, 309, 338, 310
Symphonic	338
Tashiro	332
Tatung	314, 336, 337
Teac	314, 336, 338, 337
Technics	309, 308
Toshiba	312, 311
Wards	327, 328, 335, 331, 332
Yamaha	314, 330, 336, 337
Zenith	331

Laserdisc Players

<i>Manufacturer</i>	<i>Code</i>
Sony	701
Panasonic	704, 710
Pioneer	702

DVD/VCR Combination Units

<i>Manufacturer</i>	<i>Code</i>
Sony	601
Broksonic	605
JVC	604
Panasonic	609
Samsung	603
Toshiba	602

DVD Players

<i>Manufacturer</i>	<i>Code</i>
Sony	751
Apex	762
General Electric	755
Hitachi	758
JVC	756
Magnavox	757
Mitsubishi	761
Oritron	759
Panasonic	753
Philips	757
Pioneer	752
RCA/Proscan	755
Samsung	758
Toshiba	754
Zenith	760

Cable Boxes

<i>Manufacturer</i>	<i>Code</i>
Sony	230
Hamlin/Regal	222, 223, 224, 225, 226
Jerrold/G. I./ Motorola	201, 202, 203, 204, 205, 206, 207, 208, 218
Oak	227, 228, 229
Panasonic	219, 220, 221
Pioneer	214, 215
Scientific Atlanta	209, 210, 211
Tocom	216, 217
Zenith	212, 213

Satellite Receivers

<i>Manufacturer</i>	<i>Code</i>
Sony	801
Dish Network	810
Echostar	810
General Electric	802
Hitachi	805
Hughes	804
Mitsubishi	809
Panasonic	803
RCA/ PROSCAN	802, 808
Toshiba	806, 807

Using Other Equipment with Your TV Remote Control

All Equipment

To Do This ...	Do This ...
Switch the TV's input to the VCR, DVD player, or other connected equipment	Press TV/VIDEO repeatedly to cycle through the video equipment connected to the TV's video inputs.
Set up the TV remote control to operate non-Sony equipment (and Sony DVD/VCR combination unit)	You must program the remote control the first time you use it. See "Programming the Remote Control" on page 24.

Operating a VCR

To Do This ...	Press
Activate the remote control to operate the VCR	VCR/DVD FUNCTION
Turn on/off	VCR/DVD POWER
Change channels	CH +/- (using tuner)
Adjust tracking	CH +/- (during tape playback)
Record	▶ and ● simultaneously
Play	▶
Stop	■
Fast forward	▶▶
Rewind the tape	◀◀
Pause	
Search the picture forward or backward	▶▶ or ◀◀ during playback (release to resume normal playback)











Operating a Satellite Receiver

To Do This ...	Press
Activate the remote control to operate the satellite receiver	SAT/CABLE FUNCTION
Turn on/off	SAT/CABLE POWER
Select a channel	0-9, ENTER
Change channels	CH +/-
Back to previous channel	JUMP
Display channel number	DISPLAY
Display SAT Guide	GUIDE
Display SAT Menu	MENU
Move highlight (cursor)	↑ ↓ ← →
Select item	⊕

Operating a Cable Box













To Do This ...	Press
Activate the remote control to operate the cable box	SAT/CABLE FUNCTION
Turn on/off	SAT/CABLE POWER
Select a channel	0-9, ENTER
Change channels	CH +/-
Back to previous channel	JUMP

Operating a DVD Player

To Do This ...	Press
Activate the remote control to operate the DVD	VCR/DVD FUNCTION
Turn on/off	VCR/DVD POWER
Play	
Stop	
Pause	
Step through different tracks of the disc	 to step forward or  to step backward
Step through different chapters of a video disc	CH+ to step forward or CH- to step backward
Select tracks directly	0-9,   (to move cursor), ENTER
Display the DVD menu	MENU
Move highlight (cursor)	   
Select item	SELECT

Operating a DVD/VCR Combination Unit

 When the VCR is not playing, TV/VCR/DVD switches between the DVD player and the VCR's tuner.

To Do This ...	Press
Activate the remote control to operate the DVD/VCR	VCR/DVD FUNCTION
Turn on/off	VCR/DVD POWER
Switch between the DVD player and VCR	TV/VCR/DVD
Display the DVD menu	MENU
Play	
Stop	
Pause	
Search the picture forward or backward	 or  during playback
Move highlight (cursor) and select (DVD)	    
Record (VCR)	 and  simultaneously
Change channels (VCR)	CH +/- or 0-9, ENTER (using tuner)
Adjust tracking (VCR)	CH +/- (during tape playback)

Using the Features

Overview

This chapter describes how to use the features of your TV.

Watching TV

 For a complete list of all the functions of the remote control, see pages 21-25.

To Do This ...	Do This ...
Activate the remote control to operate the TV	Press TV FUNCTION
Turn on/off the TV	Press TV POWER
Tune directly to a channel	To tune to analog channels, press 0-9 and then ENTER . For digital subchannels, press 0-9 , ⊖ , press 0-9 again, and then ENTER . For example, to select subchannel 21.13, press 2+1+⊖+1+3 , and then press ENTER .  You can also select channels using the program guide. See page 29 for details.
Adjust the volume	Press VOL +/-
Mute the sound	Press MUTING (press again to unmute)
Alternate back and forth between two channels	Press JUMP The TV alternates between the current channel and the last channel tuned.
Display the current channel number (and other information)	Press DISPLAY once to display the channel number, current time, and channel label (if set). Press DISPLAY again to turn Display off.
Switch the TV's input to the VCR, DVD player, or other connected equipment	Press TV/VIDEO repeatedly to cycle through the video equipment connected to the TV's video inputs, or press MENU and select the External Inputs option. For details, see page 34.
Change External Inputs, Favorite Channels, Settings, and more	Press MENU to display the Menu. For details, see "Using the Menu" on page 33.

Using the Program Guide

The program guide lets you review program information and select both analog and digital channels.

 **The Program Guide cannot be displayed when the TV is tuned to one of the video inputs.**



To display the program guide:

Press **GUIDE** on the TV's remote control. The program guide appears, with the currently selected program showing in the background.

Program title and description, time remaining, rating information, closed-caption availability, format, resolution (if digital), aspect ratio



Channel number, call letters, SAP or Alt. Audio (if available)

Selectable channel list

 **Program information in the guide is provided by the broadcasters. As a result, it may sometimes include only the channel number, without a program title or description.**

To Do This ...	Do This ...
Scroll through the channel list	Press ↑ ↓
Select the currently displayed channel and exit the guide	Press (EXIT) .
Select alternate audio	Press → . When the broadcaster provides an alternate audio stream (for instance, the audio may contain a different language), this option allows you to select from the available audio streams.
Exit the Guide (without changing channels)	Press GUIDE









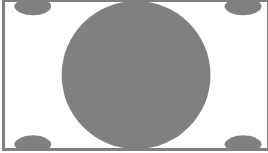

Using Screen Mode

 You can also access the Screen Mode settings in the Screen Settings. For details, see page 39.

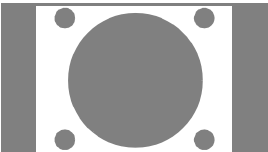
The Screen Mode feature lets you change the picture size for both standard-definition (480i/480p) and high-definition (720p/1080i) sources.

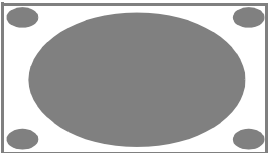











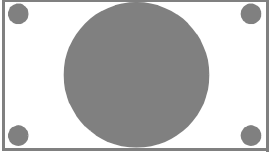

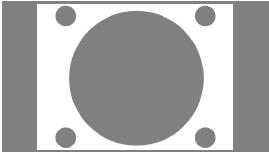
- Press **SCREEN MODE** repeatedly to toggle through the following Screen Mode settings.

Using Screen Mode with Standard Definition (480i/480p) Sources

Example	Description	
  Wide Zoom	Wide Zoom enlarges the center portion of the picture proportionately. The left and right edges of the picture are stretched to fill the 16:9 screen.	
  Normal	Normal displays the 4:3 picture in its original size. Bars are shown to fill the 16:9 screen.	
  Full	Full stretches the 4:3 picture horizontally, to fill the 16:9 screen.	
  Zoom	Zoom enlarges the 4:3 picture proportionately to fill the 16:9 screen. Some clipping may occur. Zoom is useful for watching Letterbox movies.	

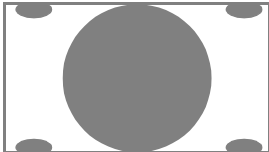
When you change channels or inputs, the Screen Mode settings revert to the **4:3 Default** setting if **Auto Wide** is set to **Off** in the Screen Settings. To retain the current Screen Mode setting as channels and inputs are changed, set **4:3 Default** to **Off** if **Auto Wide** is set to **On**. For details, see page 39.

Using Screen Mode with High-Definition (720p/1080i) Sources

Example	Description
  Full (native 16:9)	<p>Full displays the picture at its original size. If the source is a 16:9 high-definition (720p/1080i) signal, the picture fills the screen.</p> 
 Full (upconverted 4:3)	<p>If the source is a 4:3 standard-definition signal that has been upconverted, bars are shown to fill the 16:9 screen.</p> 
  Zoom	<p>Zoom enlarges the picture proportionately, both vertically and horizontally. Some clipping may occur.</p> 
  Horizontal Expand	<p>Horizontal Expand stretches the picture horizontally. Some clipping may occur.</p> 
  Vertical Expand	<p>Vertical Expand stretches the picture vertically. Some clipping may occur.</p> 

Using Favorites Menu

The Favorites Menu feature lets you select programs from a list of up to 16 favorite channels that you specify. You can create a list using the Favorites Menu option in the Menu, Channel Setting, or by using the Add to Favorites feature in the Favorite Channels guide.

Using the Favorites Menu



 For details on using the Channel Settings, see page 40.

- 1 Press **MENU** to display the Menu.
- 2 Press **↓** to highlight the Favorites and press **(+)**.
- 3 Use **↑** or **↓** to select **Add to Favorites**. Press **(+)** to add the current channel to the list of Favorite Channel.
- 4 To add more channels to your favorites list, repeat step 3.
To clear a Favorite Channel, press **↑** or **↓** to highlight **Edit Favorites** and press **(+)**, then press **→** to select **Reset** and press **(+)**.
- 5 Press **MENU** to exit the Menu.

Using the Channel Settings

- 1 Press **MENU** to display the Menu.
- 2 Press **↑** or **↓** to highlight Settings and press **(+)**.
- 3 Use **↑** or **↓** to select Channel icon and press **(+)**.
- 4 Press **(+)** to select **Favorites Channels**.
- 5 Use **↑** or **↓** to highlight a Favorite Channel number (1-16), then enter the number channel and press **(+)** to add it.
- 6 To add more channels to your favorite list, repeat step 5.
To clear a Favorite Channel, press **↑** or **↓** to highlight **Edit Favorites** and press **(+)**, then press **→** to select **Reset** and press **(+)**.
- 7 Press **MENU** to exit the Menu.

Using the Favorite Channels Guide

- 1 During normal viewing (with no menus on screen), press **(+)**. The Favorite Channels list appears.
- 2 Press **↑** or **↓** to highlight the channel you want to watch.
To add the current channel to the list of Favorite Channels, highlight **Add to Favorites** and press **(+)**.
To change your Favorite Channels list, highlight **Edit Favorites** and press **(+)**.
- 3 Press **(+)** to select the channel you want to watch.

Using the Menu

Overview

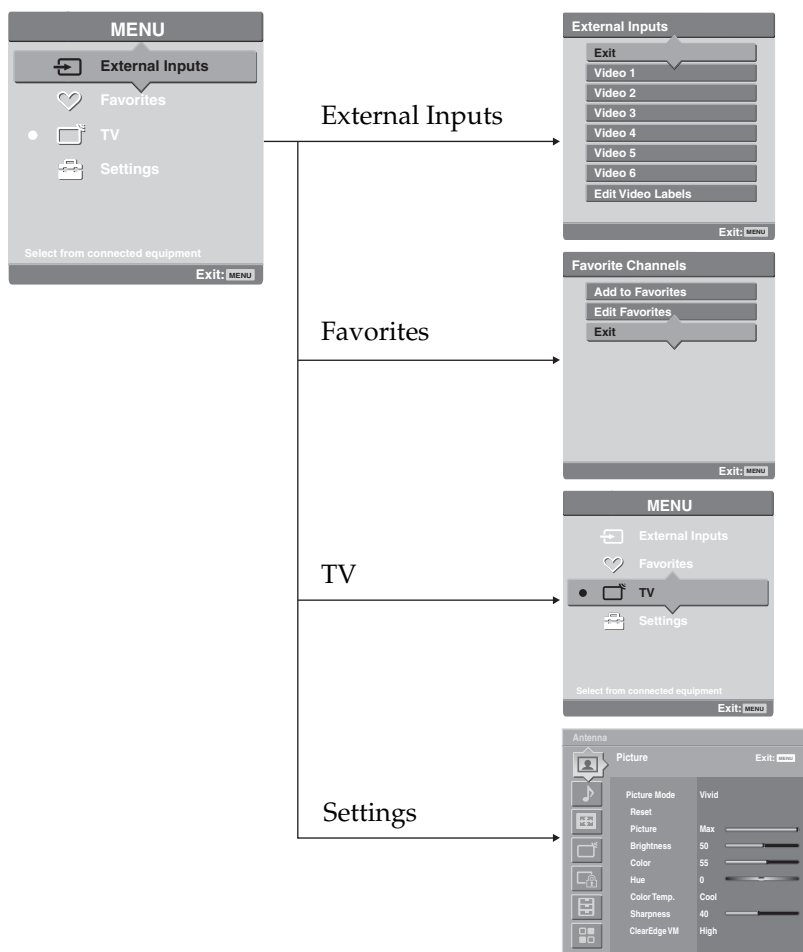

The External Inputs feature lets you select equipment that is connected to your TV. You can assign a label to your equipment or skip unused inputs conveniently.

The Favorites feature lets you select programs from the list of up to 16 favorite channels that you specify.

The TV feature takes you to the most recently viewed Antenna or Cable channel.

This Menu allows you to change the settings of your TV.

Navigating Through Menu

To Do This ...	Press
Display the Menu	MENU
Move through the Menus	↑ ↓ ← →
Select an option to change	⊕
Select (confirm) changed setting	⊕ or ←
Exit the Menu	MENU

Using the Menu



External Inputs in MENU

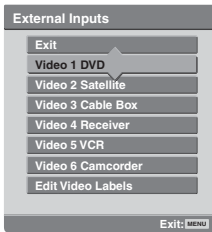

The External Inputs feature lets you select the external inputs connected to your TV. You can also assign a label using Label Video Inputs in the Setup settings.

- 1 Select External Inputs from the MENU control panel and press . The External Inputs list appears. Make your selection.
- 2 Press / to highlight the desired external input and press .



Using Favorites in MENU

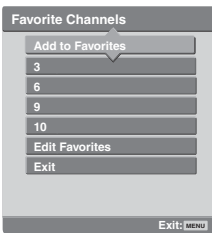

The Favorites feature lets you select programs from a list of up to 16 favorite channels that you specify. You can create a list using the Add to Favorites option.

- 1 Select Favorites from the MENU control panel and press . The Favorite Channels list appears. Make your selection.
- 2 Press / to highlight the desired channel and press .
 - To add the current channel to the list of Favorite Channels, highlight Add to Favorites and press .

When the Favorite Channels list is full, remove a channel from your list using Favorite Channels in the Channel settings and try again.



Using TV in MENU



The TV takes you to the most recently viewed Antenna or Cable channel. The Program Banner and channel number will be displayed.

- 1 Select TV from the MENU control panel and press .



Using Settings in MENU

The Settings feature lets you enter to the settings screen where most of advanced settings and adjustments are performed. See page 35.

Using the Picture Settings



To access the Picture Settings, follow these steps:

1. Display Menu



2. Highlight and select



3. Highlight and select



Press / to highlight.

Press to select.

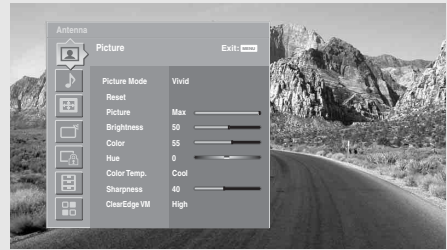

Selecting Picture Options



You can also change the Picture Mode setting using the **PICTURE MODE** button on the remote control.



You can alter the Picture Settings (**Picture**, **Brightness**, **Color**, etc.) for each Mode.

The Picture Settings include the following options:

Option	Description
Picture Mode	Vivid Select for enhanced picture contrast and sharpness.
<i>Customized picture viewing</i>	Standard Select for standard picture settings.
	Movie Select to display a softer picture.
	Pro Select to display a picture with minimum enhancements.
To control how the Picture Mode settings (Vivid , Standard , Movie , Pro) are applied to each video input, see Mode Memory on page 36.	
Reset	Select OK to reset all settings and adjustments to the default setting (except for Advanced Settings).
Picture	Adjust to increase picture contrast and deepen the color, or decrease picture contrast and soften the color.
Brightness	Adjust to brighten or darken the picture.
Color	Adjust to increase or decrease color intensity.
Hue	Adjust to increase or decrease the green tones.
Color Temp.	Cool Select to give the white colors a blue tint.
<i>White intensity adjustment</i>	Neutral Select to give the white colors a neutral tint.
	Warm Select to give the white colors a red tint (NTSC-Standard).
Sharpness	Adjust to sharpen or soften the picture.



You can also change the DRC Mode using the **DRC MODE** button on the remote control.

Option	Description
ClearEdge VM Velocity Modulation	Sharpens picture definition to give every object a sharp, clean edge. Select from High, Medium, Low, Off .
Advanced Settings	Select Program to choose among the Advanced Settings options.
DRC Mode	Creates a high-resolution picture with 4x density, for high quality sources (i.e., DVD player, satellite receiver).
Interlaced	Recommended for moving pictures.
Progressive	Recommended for still images and text.
CineMotion	Provides an optimized display by automatically detecting film content and applying a reverse 3/2 pulldown process. Moving pictures will appear clearer and more natural-looking.
Color Axis	Allows you to control the emphasis of red tones.
Default	Emphasizes red tones.
Monitor	De-emphasizes red tones.
Mode Memory	Allows you to control how the Picture Mode settings (Vivid, Standard, Movie, Pro) are applied to TV viewing and each video input. For details about Picture Mode settings, see page 35.
On	Set to On to customize Picture Mode settings for each video input. Changing inputs might change the Picture Mode setting.
Off	Set to Off to apply the same Picture Mode settings to all video inputs. Changing inputs does not change the Picture Mode setting.

Using the Sound Settings



To access the Sound Settings, follow these steps:

1. Display Menu



2. Highlight and select



3. Highlight and select

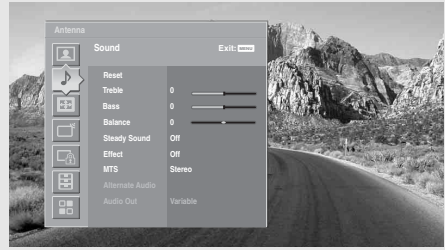

Press **▲** / **▼** to highlight.
Press **○** to select.

Selecting Sound Options

You can also change the Effect using the **⏸** button on the remote control.

The Sound Settings include the following options:

Option	Description
Reset	Reset the following options to the default setting: Treble , Bass , and Balance .
Treble	Adjust to decrease or increase higher-pitched sounds.
Bass	Adjust to decrease or increase lower-pitched sounds.
Balance	Adjust to emphasize left or right speaker balance.
Steady Sound	On Select to stabilize the volume. Off Select to turn off Steady Sound.
 The Steady Sound option is not available if the Effect option is set to TruSurround or Simulated. To use Steady Sound, set Effect to Off.	
Effect	TruSurround XT Select for surround sound (for stereo programs only). WOW Provides a dramatic presence with a full, deep bass sound. When WOW is enabled, BBE is activated to further enhance the audio performance. Simulated Adds a surround-like effect to mono programs. Off Normal stereo or mono reception.
MTS <i>Enjoy stereo, bilingual and mono programs</i>	Stereo Select for stereo reception when viewing a program broadcast in stereo. Auto SAP Select to automatically switch the TV to second audio programs when a signal is received. (If no SAP signal is present, the TV remains in Stereo mode.) Mono Select for mono reception. (Use to reduce noise during weak stereo broadcasts.)
 MTS is available only with analog programs.	



For having access to **Alternate Audio**, you can also use the guide button on the remote control.



Alternate Audio is only available for digital programs.

Option	Description
Alternate Audio <i>(When available)</i>	When the broadcaster provides an alternate audio stream (for instance, the audio may contain a different language), this option allows you to select from the available audio streams.
Speaker	On Select to turn on the TV speakers.
	Off Select to turn off the TV speakers and listen to the TV's sound only through your external audio system speakers.
Audio Out <i>Easy control of volume adjustments</i>	This option can be set only when the Speaker option is set to Off .
	Variable The TV's speakers are turned off, but the volume output from your audio system can still be controlled by the TV's remote control.
	Fixed The TV's speakers are turned off and the volume output of the TV is fixed. Use your audio receiver's remote control to adjust the volume through your audio system.

Using the Screen Settings



To access the Screen Settings, follow these steps:

1. Display Menu



2. Highlight and select

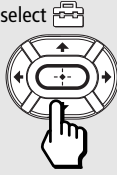

3. Highlight and select

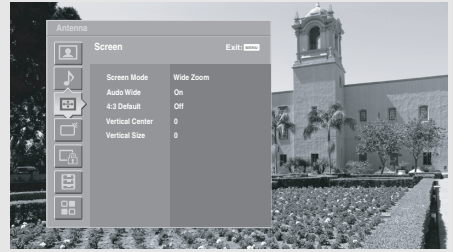

Press **▲** / **▼** to highlight.
Press **○** to select.

Selecting Screen Mode Options



You can also change the Screen Mode using the **SCREEN MODE** button on the remote control.

The Screen Settings include the following options:

Option	Description
Screen Mode	Enables you to change the picture size for both standard-definition (480i/480p) and high-definition (720p/1080i) sources. For 480i/480p sources Select from: Wide Zoom , Normal , Full , Zoom . For details, see page 30. For 720p/1080i sources Select from: Full , Zoom , Horizontal Expand , Vertical Expand . For details, see page 31.
	In some cases, wide-screen programs will be shown in aspect ratios that require the display of bars at the top and bottom of your 16:9 screen. For more details, see page 52.
Auto Wide	On Select to have the screen automatically change to the screen mode that is best for the current program. If frequent screen changes are disturbing to you, select Off . Off Select to turn off the Auto Wide option. Choose a screen mode from the Wide Mode option.
4:3 Default	Select the default Screen Mode to use for 4:3 sources. To select a Screen Mode to use when channels or inputs are changed, select from: Wide Zoom , Normal , Full , Zoom . For details, see page 30. To continue using the current Screen Mode setting when the channel or input is changed, select Off .
Vertical Center	Allows you to move the position of the picture up and down in the window. (Available only in Wide Zoom and Zoom modes.) Press ▲ or ▼ and press ○ to choose a correction between +15 and -15 (Zoom mode), and +5 and -5 (Wide Zoom mode).
Vertical Size	Allows you to adjust the vertical size of the picture. (Available only in Wide Zoom and Zoom modes.) Press ▲ or ▼ and press ○ to choose a correction between +7 and -7.



4:3 Default is only available if **Auto Wide** is set to **On**.

Using the Channel Settings



To access the Channel Settings, follow these steps:

1. Display Menu



2. Highlight and select



3. Highlight and select

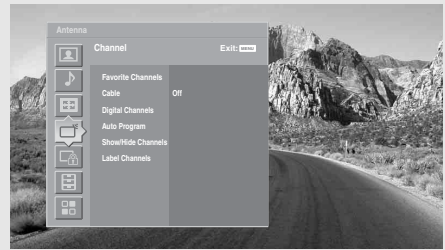

Press **↑** / **↓** to highlight.

Press **↵** to select.

Selecting Channel Options

The Channel Settings include the following options:

Option	Description
Favorite Channels	Lets you set up a list of your favorite channels. For details, see "Using Favorites Menu" on page 32.
Cable	<p>On Select if you are receiving cable channels with a CATV cable.</p> <p>Off Select if you are using a TV antenna.</p> <p>After changing the cable setting the first time, you will need to run Auto Program.</p>
Digital Channels	Add Select to add digital channels.
Auto Program	Automatically sets up the channel list on the TV for all receivable digital channels. Auto Program may take 50 minutes or more to complete. A progress bar will display the approximate progress of the Auto Program and Digital Channels/Add sequences.

 Channels that you set to **Hidden** can be accessed only with the **0-9** buttons.

<i>Option</i>	<i>Description</i>
Show/Hide Channels	<p>Allows you to show or hide channels that appear in the Program Guide (page 29) and when you use the CH+/- buttons to channel surf. Channels that are set to Hidden do not appear in the Program Guide or when you use the CH+/- buttons.</p> <ol style="list-style-type: none">1 Press ▲ or ▼ to highlight the channel that you want to show or hide. To move between the Major and Digital subchannel lists, press ◀ or ▶.2 To change a channel's setting to Shown or Hidden, press ⏏.3 To show or hide more channels, repeat steps 1 and 2.
Label Channels	<p>Allows you to assign labels (such as station call letters) to channel numbers.</p> <ol style="list-style-type: none">1 Press ▲ ▼ to scroll through the channel numbers. Then press ⏏ to select the channel number that you want to assign a label.2 Press ▲ ▼ to scroll through the label characters (A-Z, 0-9, etc.). Then press ⏏ to select the highlighted character. Repeat to add characters to the label.3 To assign labels to more channels, repeat steps 1-2.4 Press ◀ to return to the Channel Settings, or press MENU to exit the Menus.

Using the Parental Lock Settings



The Parental Lock Settings allows you to set up the TV to block programs according to their content and rating levels.

To access the Parental Lock Setting, follow these steps:

1. Display Menu



2. Highlight and select



3. Highlight and select

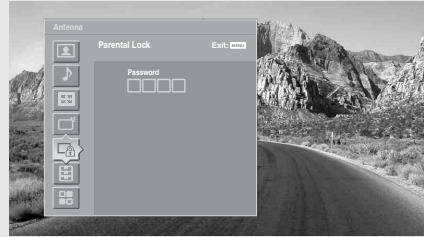

Use the 0-9 buttons on the remote control to enter a four-digit password.

If this is the first time you are creating this password, confirm the password by entering it again. (The Parental Lock Settings options appear.)

To change settings, press **↑ ↓ ← →**. Press **(+)** to confirm the selection.

To exit the Menu, press **MENU**.

You need your password for any future access into the Parental Lock Setting. If you lose your password, see "Lost password" on page 52.

Selecting Parental Lock Options

If you are not familiar with the Parental Guideline rating system, you should select **Child**, **Youth**, or **Y. Adult** to help simplify the rating selection. To set more specific ratings, select **Custom**.

For descriptions of **Child**, **Youth**, and **Y. Adult** ratings, see page 43.

The Parental Lock Settings include the following options:

Option	Description
Rating <i>Turn ratings on/off and select a rating system</i>	<p>Off Parental lock is off. No programs are blocked from viewing.</p> <hr/> <p>Child Maximum ratings permitted are: <input type="checkbox"/> US: TV-Y, TV-G, G <input type="checkbox"/> Canada: C, G, TV-Y</p> <hr/> <p>Youth Maximum ratings permitted are: <input type="checkbox"/> US: TV-PG, PG <input type="checkbox"/> Canada: C8+, PG, 8 ans+, TV-PG</p> <hr/> <p>Y. Adult (Young Adult) Maximum ratings permitted are: <input type="checkbox"/> US: TV-14, PG-13 <input type="checkbox"/> Canada: 14+, 13 ans+, TV-14</p> <hr/> <p>Custom Select to set ratings manually. <input type="checkbox"/> US: See page 43 for details. <input type="checkbox"/> Canada: See page 44 for details.</p>
Digital Rating <i>(When available)</i>	<p>The Parental Lock option in the Digital Rating settings allows you to set up the TV to block digital programs that contain digital ratings. This setting is only available if digital ratings have been downloaded by your TV and ratings have been set for U.S.A. in the Parental Lock settings.</p> <hr/> <p>Off Turn Parental Lock off. No programs are blocked from viewing.</p> <hr/> <p>Custom... Select to block programs based on downloadable ratings.</p> <hr/> <p>Clear All Select to clear all Custom settings.</p>

Option	Description
Unrated <i>Block programs or movies that are broadcast without a rating</i>	Allow Allows programs and movies that are broadcast without a rating.
	Block Blocks all programs and movies that are broadcast without a rating.
Change Password	For changing your password.
Select Country	U.S.A. Select to use U.S.A. ratings.
	Canada Select to use Canadian ratings (see page 44).

US Models: Selecting Custom Rating Options

 The Content-Based Ratings are linked to the level of the Age-Based Rating. For example, a program with an Age-Based Rating of TV-PG V (Violence) rating may contain moderate violence, while a TV-14 V (Violence) rating may contain more intense violence.

 To ensure maximum blocking capability, set the Age-Based Ratings.

 If you block unrated TV programs, be aware that the following types of programs may be blocked: emergency broadcasts, political programs, sports, news, public service announcements, religious programs and weather.

For US models, the Custom Rating Menu includes the following options. (For Canadian models, see page 44.)

Option	Description
Movie Rating	G All children and General Audience.
	PG Parental Guidance suggested.
	PG-13 Parental Guidance for children under 13.
	R Restricted viewing, parental guidance is suggested for children under 17.
	NC-17 and X No one 17 or under allowed.
TV Rating	Age-Based Ratings
<i>Block programs by their rating, content or both</i>	TV-Y All children.
	TV-Y7 Directed to children age 7 and older.
	TV-G General Audience.
	TV-PG Parental Guidance suggested.
	TV-14 Parents Strongly cautioned.
	TV-MA Mature Audience only.
	Content-Based Ratings
	FV Fantasy Violence.
	D Suggestive Dialogue.
	L Strong Language.
	S Sexual situations.
	V Violence.

Viewing Blocked Programs

You can view blocked programs by entering the password. Press the **ENTER** button when tuned to a blocked program, then enter the password. This temporarily switches off the Parental Lock. To reactivate the Parental Lock settings, turn off the TV. When the TV is turned on again, your Parental Lock settings are reactivated.

Canadian Models: Selecting Custom Rating Options

For Canadian models, the Custom Rating Menu includes the following options. (For US models, see page 43.)

Option	Description	
English Rating	C	All children.
	C8+	Children 8 years and older.
	G	General programming.
	PG	Parental Guidance.
	14+	Viewers 14 and older.
French Rating	18+	Adult programming.
	G	General programming.
	8 ans+	Not recommended for young children.
	13 ans+	Not recommended for ages under 13.
U.S.A. Rating	16 ans+	Not recommended for ages under 16.
	18 ans+	Programming restricted to adults.
	See "US Models" on page 43 for details.	

Viewing Blocked Programs

You can view blocked programs by entering the password. Press the **ENTER** button when tuned to a blocked program, then enter the password. This temporarily switches off the Parental Lock. To reactivate the Parental Lock settings, turn off the TV. When the TV is turned on again, your Parental Lock settings are reactivated.

Using the Setup Settings



To access the Setup Settings, follow these steps:

1. Display Menu



2. Highlight and select



3. Highlight and select



Press **▲** / **▼** to highlight.

Press **↵** to select.

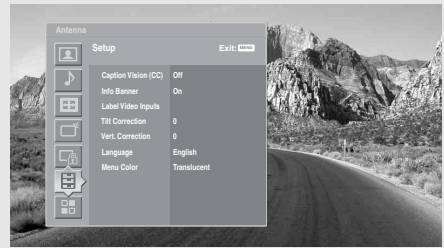

Selecting Setup Options

The Setup Settings include the following options:

Option	Description
Caption Vision (CC)	Allows you to select from several closed caption modes (for programs that are broadcast with closed caption).
On	Caption Vision is turned on.
Off	Caption Vision is turned off.
Program	Allows you to set basic and advanced Caption Vision options. See “Programming Caption Vision” on page 46.
Info Banner	Set to On or Off . When on, displays the program name, time remaining and other information (if the broadcaster offers this service). Displays when the channel is changed or the DISPLAY button is pressed.
Label Video Inputs	Allows you to identify A/V equipment you connected to the TV, such as a VCR, DVD, etc. For example, if you have a DVD player connected to the VIDEO 4 jack, you can select the label DVD for the VIDEO 4 input. Then when you press the TV/VIDEO button to change inputs, the Video Label you assigned to that input appears on screen. 1 Press ▲ or ▼ to highlight the video input (VIDEO 1-6) to which you want to assign a label. Then press ↵ to select the input. 2 Press ▲ or ▼ to highlight one of the displayed labels. Then press ↵ to select the label.
You can select from the following labels for each input:	
Video 1-6	DVD, Cable Box, Satellite, VCR, Receiver, DVR, Game, Camcorder, HD, LD, DTV, Beta, 8mm, Skip

The **Skip** label is useful for inputs that do not have equipment connected to them.

If you select **Skip**, your TV skips this input when you press the **TV/VIDEO** button.

 Normally, **Tilt Correction** and **Vertical Correction** only need to be adjusted the first time you turn on the unit and after the unit is moved to a new location.

Option	Description
Tilt Correction	Allows you to correct any tilt of the picture. Press ← or → to choose a correction between +7 and -7 and press (+/-) .
Vertical Correction	Allows you to make a vertical correction to the picture. Press ↑ or ↓ to choose a correction between +5 and -5 and press (+/-) .
Language	Select to display all on-screen Menus in your language of choice.
Menu Color	Enables you to select a specific color for the on-screen menus.

Programming Caption Vision

If you selected the **Program** option under **Caption Vision** (see page 45), you can change the following settings:

Basic	Allows you to select basic analog (EIA-608) closed caption options.
CC1, CC2, CC3, CC4	Displays a printed version of the dialog or sound effects of a program. (Should be set to CC1 for most programs.)
Text1, Text2, Text3, Text4	Displays network/station information presented using either half or the whole screen (if available). For closed captioning, set to CC1 .
Advanced	Allows you to select advanced digital (EIA-708) closed caption options. Select from the available options.
Digital CC	Allows you to set digital closed captioning to Basic (digital EIA-608) or Advanced (digital EIA-708).
Advanced Settings	Allows you to make additional settings for digital (EIA-708) closed caption options.
As Broadcast	
Small Text	
Large Text	
Custom ...	Allows you to customize the following settings:
Character Size	Small, Standard, Large
Character Style	Style 1-7
Character Color	Color 1-8
Edge Color	Color 1-8
Edge Type	None, Raised, Depressed, Outline, Left shadow, Right shadow
Background Color	None, Color 1-8
Window Color	None, Color 1-8
 Color options can also be set to Solid or Translucent.	

Using the Applications Settings



To access the Applications Settings, follow these steps:

1. Display Menu



2. Highlight and select



3. Highlight and select





Press **▲** / **▼** to highlight.

Press **○** to select.

Selecting Applications Options

 You can also change the **Sleep** options using the **SLEEP** button on the remote control.

 To go directly to programming **Timer 1** or **2**, press **○** instead of pressing **▶**.

 To return to the **Timer Menu** after programming one of the **Timers**, press **○** when the highlight is in the channel number field.

 To return to the **Timer Menu** after setting the **Current Time**, press **○** when the highlight is in the minute field.

The Applications Settings include the following options:

Option	Description
Clock/Timers	Select to set the clock, set the Sleep timer, and to program your TV to turn on and off at two scheduled viewing times.
Sleep	Set the time in minutes (15min , 30min , 45min , 60min , 90min , 120min or Off) that you want the TV to remain on before shutting off automatically.
Timer 1 Timer 2	You can use the Timers to program the TV to turn on and off and tune to a specific channel at two scheduled viewing times.
Timer 1 and Timer 2 are not available to be set until you set the Current Time .	
1	Press ▲ or ▼ to highlight Timer 1 or Timer 2 . To set the timer, press ▶ .
2	Press ▲ or ▼ to highlight one of the following options, then press ○ .
Program	Select to set the Timer by day, time, duration, and channel.
Off	Select to turn off the Timer . (Your previous settings are saved.)
3	If you selected Program in step 2, Press ▲ and ▼ to set the day(s), hour, minute, duration, and channel number. Press ○ or ▶ to confirm each setting and move to the next setting. Press ◀ to go back to the previous setting.
4	Press MENU to exit the Menu. An LED on the front panel will light, indicating the timer has been set.
Current Time	
1	Press ○ to select Current Time .
2	Press ▲ and ▼ to set the current time (day, hour, and minute). Press ○ or ▶ to confirm each setting and move to the next setting. Press ◀ to go back to the previous setting.
3	Press MENU to exit the Menu.
Diagnostics	Displays the strength of the terrestrial digital broadcast signal, to help you adjust your antenna to optimal signal reception.

Other Information

Glossary

analog signal

A signaling method that uses continuous changes in the amplitude or frequency of an electronic transmission to convey information.

aspect ratio

Refers to the ratio between the width and height of the screen and picture image. This model has a 16:9 (widescreen) aspect ratio.

4:3 aspect ratio



16:9 aspect ratio



component video



Component video is sent through three cables: two color shade (chrominance) signals and one brightness (luminance) signal. Component video achieves greater color accuracy than composite video or S VIDEO by splitting chrominance into two separate portions.

composite video



Composite video is sent through a single cable. Composite video combines the color shade (chrominance) and brightness (luminance) information into one video signal.

degauss

A process that demagnetizes the metal components in the TV monitor, which eliminates image distortion that can result from magnetic charges acquired by the TV's components. Your TV degausses automatically when it is turned on.

digital television (DTV)

A new technology for transmitting and receiving broadcast television signals. DTV provides clearer resolution and improved sound quality over analog television.

HDMI (High-Definition Multimedia Interface)

Provides an uncompressed, all-digital audio/video interface between this TV and any HDMI-equipped audio/video component, such as a set-top box, DVD player, and A/V receiver. HDMI supports enhanced, or high-definition video, plus two-channel digital audio.

National Television System Committee (NTSC)

A unit of the Federal Communications Commission, Washington, DC, that establishes television standards in the United States, such as NTSC Color, the standard used in this TV.

RF

Radio Frequency. That part of the frequency spectrum that is used to transmit TV and radio signals.

S VIDEO



S VIDEO requires a single cable, which carries the brightness (luminance) and color (chrominance) signals of the picture separately. S VIDEO provides better resolution than composite video, which carries the signals together.

VHF/UHF

VHF (Very High Frequency) is the part of the frequency spectrum from 30 to 300 megahertz. UHF (Ultra High Frequency) is the part of the frequency spectrum from 300 to 3,000 megahertz.

480i (SD)

Provides 480 lines of resolution. Displays images using interlaced scanning, which first transmits all the odd lines on the TV screen and then the even lines.

480p (SD)

Provides 480 lines of resolution. Displays images using progressive scanning, which transmits each line from top to bottom.

720p (HD)

Provides 720 lines of resolution. Displays images using progressive scanning, which transmits each line from top to bottom.

1080i (HD)

Provides 1080 lines of resolution. Displays images using interlaced scanning, which first transmits all the odd lines on the TV screen and then the even lines. 1080i is one of the formats used by HDTV (High Definition TV).

Contacting Sony

If, after reading these operating instructions, you have additional questions related to the use of your Sony television, please call our Customer Information Services Center at 1-800-222-SONY (7669) (US residents only) or (416) 499-SONY (7669) (Canadian residents only), or visit <http://www.sony.com/TVsupport>.

Before calling Sony customer support or visiting our website, please write down the model and serial numbers of your TV. You'll find this information on the front cover of this manual.

Troubleshooting

Remote Control

<i>Problem</i>	<i>Possible Remedies</i>
Remote control does not operate	<ul style="list-style-type: none"> <input type="checkbox"/> The batteries could be weak. Replace the batteries. <input type="checkbox"/> Check the orientation of the batteries. <input type="checkbox"/> Press the TV FUNCTION button. You may have inadvertently pressed the SAT/CABLE FUNCTION button, which changes the remote control to SAT or CABLE mode. <input type="checkbox"/> Make sure the TV's power cord is connected securely to the wall outlet. <input type="checkbox"/> Locate the TV at least 3-4 feet away from fluorescent lights.
Cannot change channels with the remote control	<ul style="list-style-type: none"> <input type="checkbox"/> If you are using the TV to change channels, first press the TV FUNCTION button. <input type="checkbox"/> If you are using another device to change channels, be sure to press the FUNCTION button for that device. For example, if you are using your cable box to change channels, be sure to press the SAT/CABLE FUNCTION button.
Remote control does not operate non-Sony video equipment	<ul style="list-style-type: none"> <input type="checkbox"/> If you replaced the batteries to the remote recently, the code numbers for the video equipment may need to be reset. <input type="checkbox"/> There may be more than one code for the equipment that you are attempting to operate. <input type="checkbox"/> There is a possibility that some non-Sony equipment cannot be operated by your Sony TV remote. You may need to use the equipment's original remote control.

Channels

<i>Problem</i>	<i>Possible Remedies</i>
Cannot receive upper channels (UHF) when using an antenna	<ul style="list-style-type: none"> <input type="checkbox"/> Use Auto Program in the Channel Settings to add receivable channels that are not presently in the TV's memory (see page 40).
Cannot receive any channels when using cable TV	<ul style="list-style-type: none"> <input type="checkbox"/> Use Auto Program in the Channel Settings to add receivable channels that are not presently in the TV's memory (see page 40).
Cannot receive or select channels	<ul style="list-style-type: none"> <input type="checkbox"/> Use Auto Program in the Channel Settings to add receivable TV channels that are not presently in TV memory (see page 40).

Problem	Possible Remedies
Some digital cable channels are not being displayed	<ul style="list-style-type: none"> ❑ Certain cable TV companies have limitations on the broadcast of digital cable channels. Check with your cable TV company for more information. ❑ Some optional digital cable broadcast formats may not be supported. If your cable TV company is broadcasting digital signals in unsupported broadcast formats, you will need a separate set-top box provided by your cable TV company to view those channels. ❑ The digital cable channel may be set to Hide in the Channel Settings (see page 41). ❑ Use the Digital Channels feature to search for new digital channels (see page 40).

Sound

Problem	Possible Remedies
Good picture, no sound	<ul style="list-style-type: none"> ❑ Press MUTING so that the word Muting disappears from the screen (see page 22). ❑ Make sure the Speaker option is set to On in the Sound Settings (see page 38). ❑ Make sure the MTS option is set to Stereo or Mono (see page 37).
Cannot gain enough volume when using a cable box	❑ Increase the volume of the cable box using the cable box's remote control. Then press TV FUNCTION and adjust the TV's volume.
Sound seems weak or insufficient	❑ The TV's audio might be set to Auto SAP or Mono , when it might be better set to Stereo . In the Sound Settings (see page 37), set the MTS setting to Stereo . If already set to Stereo , switch to Mono (which may reduce background noise during weak stereo broadcasts).
Cannot raise the volume on external audio speakers	<ul style="list-style-type: none"> ❑ If the Speaker option is set to Off and the Audio Out option is set to Fixed (in order to output the sound to your audio system) use your audio receiver to adjust the sound (see page 37). Or, to use the TV remote control, set the Audio Out option to Variable. ❑ To turn on the TV speakers, set the Speaker option to On (see page 38).

Picture

Problem	Possible Remedies
No picture (screen not lit), no sound	<ul style="list-style-type: none"> ❑ If your TV does not turn on, and a red light keeps flashing, your TV may need service. Call your local Sony Service Center. ❑ Make sure the power cord is plugged in. ❑ Press the POWER button on the front of the TV. ❑ Press the TV/VIDEO button to cycle through the connected video sources. ❑ Try another channel; it could be station trouble.
Dark, poor or no picture (screen lit), good sound	<ul style="list-style-type: none"> ❑ Adjust the Picture option in the Picture Settings (see page 35). ❑ Adjust the Brightness option in the Picture Settings (see page 35). ❑ Check the antenna/cable connections.
No color	❑ Adjust the Color option in the Picture Settings (see page 35).
Only snow and noise appear on the screen	<ul style="list-style-type: none"> ❑ Check the antenna/cable connections. ❑ Try another channel; it could be station trouble.
Dotted lines or stripes	<ul style="list-style-type: none"> ❑ Adjust the antenna. ❑ Move the TV away from noise sources such as cars, neon signs, or hair-dryers.

Problem	Possible Remedies
Double images or ghosts	❑ Using a highly directional outdoor antenna or a cable may solve the problem.
“Black box” on screen	❑ You have selected a text option in the Setup Settings and no text is available. (See page 45 to reset Setup selections.) To turn off this feature, set the Caption Vision option to Off . If you were trying to select closed captioning, select CC1 instead of TEXT 1-4 .
Bars appear at the top and bottom of the screen	❑ Some wide-screen programs are filmed in aspect ratios that are greater than 16:9, such as 2.35:1. (This is especially common with theatrical releases). Your TV will show these programs with bars at the top and bottom of the screen. For more details, check the documentation that came with your DVD (or contact your program provider).

General

Problem	Possible Remedies
How to reset TV to factory settings	❑ Turn on the TV. While holding down the RESET button on the remote control, press the POWER button on the TV. (The TV will turn itself off, then back on again.) Release the RESET button.
How to restore Picture settings to factory settings	❑ Press the RESET button on the remote control while in the Picture Settings (see page 35).
How to restore Sound settings to factory settings	❑ Press the RESET button on the remote control while in the Sound Settings (see page 37).
Cannot cycle through the other video equipment connected to the TV	❑ Be sure the Label Video Inputs option is not set to Skip (see page 45).
Cannot operate Menu	❑ If a Menu option appears in gray, this indicates that the TV is in a state in which the Menu option is not available.
Lost password	❑ In the password screen (see page 42), enter the following master password: 4357 . The master password clears your previous password; it cannot be used to temporarily unblock channels.
TV makes “popping” sound when turned on	❑ This is a normal sound that results from the TV automatically degaussing each time it is turned on.
TIMER/STAND BY LED on front panel is lit	❑ This LED blinks when the TV is turned on, then shuts off when the picture is displayed. If the LED blinks for more than a minute, this may indicate the TV needs service.
Digital cable box does not work	❑ If you are connecting a VCR and digital cable box using a splitter, as described on page 9, you must use a special bi-directional splitter that is designed to work with your digital cable box. Contact your cable TV company for details.
Cannot record digital channels to VCR	❑ Only analog channels can be recorded to your VCR.

Specifications

Picture Tube	FD Trinitron® tube	
Antenna	75 ohm external terminal for VHF/UHF	
Television System	NTSC	
	American TV Standard	
	ATSC (8VSB terrestrial)	ATSC compliant 8VSB
Channel Coverage	QAM on cable	ANSI/SCTE 07 2000
	Terrestrial (analog)	2-69
	Cable TV (analog)	1-125
	Terrestrial (digital)	2-69
Power Requirements	Cable TV (digital)	1-135
	120V, 60 Hz	
Inputs/Outputs		
HDMI IN	Video	1080i, 720p, 480p, 480i
	Audio	Two channel linear PCM 32, 44.1 and 48 kHz, 16, 20 and 24 bit
Video (IN)	3 total (1 on front panel)	1 Vp-p, 75 ohms unbalanced, sync negative
S Video (IN)	3 total (1 on front panel)	Y: 1 Vp-p, 75 ohms unbalanced, sync negative C: 0.286 Vp-p (Burst signal), 75 ohms
Audio (IN)	6 total (1 on front panel)	500 mVrms (100% modulation) Impedance: 47 kilohm
Component Video Input	2 (Y _P P _R)	Y: 1.0 Vp-p, 75 ohms unbalanced, sync negative; P _B : 0.7 Vp-p, 75 ohms P _R : 0.7 Vp-p, 75 ohms
Variable/Fixed Audio (OUT)	1	More than 408 mVrms at the maximum volume setting (Variable) More than 408 mVrms (Fixed) Impedance (output): 2 kilohms
Digital Audio Output PCM/Dolby Digital	1	Coaxial
Supplied Accessories	Remote Control	RM-YD007
	AA Batteries	2 supplied for remote control
Visible Screen Size (picture measured diagonally)	34 in (863.6 mm)	
Actual CRT Size (picture measured diagonally)	36 in (914.4 mm)	
Speaker Output	10 W x 2	
Dimensions (W x H x D)	994 x 654 x 604 mm (39 1/8 x 25 3/4 x 23 3/4 in)	
Mass	86.3 Kg (190 lbs)	
Power Consumption	In Use: 240 W	
	In Standby: Less than 1 W	

Design and specifications are subject to change without notice.

Optional Accessories

Accessory	Description	Model Number
Cables	Audio/Video	VMC-810/820/830 HG
	Audio	RKC-515HG
	Component Video	VMC-10/30 HG
TV Stand	SU-34XBR4	

Index

0-9 buttons 23, 28
4:3 Default settings 39

A

Advanced Settings 36
Alternate Audio 38
antenna, connecting 5
Applications Settings 47
Audio Out 38
AUDIO OUT jack 4
audio receiver, connecting 16
Auto Program (channel setup)
20, 40
Auto SAP, MTS setting 37
Auto Wide 39

B

balance, adjusting 37
bass, adjusting 37
batteries, inserting in remote 21
BBE 2
bilingual audio 37
blocking programs. *See ratings.*
brightness, adjusting 35
Built 1

C

Cable 40
cable
connecting 5
with VCR, connecting 8
cable box
connecting with VCR 9
using with TV remote
control 27
Caption Vision (CC) 45
CATV. *See cable*
CH buttons 3, 23
channel list, setting up 20
Channel Settings 40
Channel Skip/Add 41
CineMotion 2, 22, 36
ClearEdge VM 36
ClearEdge VM Velocity
Modulation 2

clearing, Favorite Channels 32
closed caption modes 45
CODE SET button 22
color, adjusting 35
Component Video Inputs 2
Cool, Color Temp. 35

D

degauss 52
DIGITAL AUDIO jack 4
digital channels, adding 40
Digital Reality Creation 1
DISPLAY button 28
DRC Mode 36
DRC MODE button 22
DRC. *See Digital Reality Creation.*
DVD player
using with TV remote
control 27
with A/V connectors,
connecting 15

E

Effect button 23
ENTER button 23, 28
External Inputs, MENU 34

F

Fast-forward button 22
Favorite Channels
clearing 32
in Channel Settings 40
Favorites Menu 1
using 32
Favorites, MENU 34
features 1
Fixed audio setting 38
Full 31
Full (Screen Mode) 30, 31

G

Glossary 49
GUIDE button 23, 29

H

HD Detailer 2
HD/DVD IN
(1080i/720p/480p/480i)
jacks, described 4
High-Definition Multimedia
Interface (HDMI) 2, 17, 18,
49
Horizontal Expand (Screen
Mode) 31
hue, adjusting 35

I

Info Banner 45
Initial Setup 20
interlaced 1, 22, 36, 49

J

JUMP button 22, 28

L

Language, setting 46

M

MENU button 3, 23, 28, 32, 33
Mono, MTS setting 37
Movie mode 35
MTS 37
MUTING button 22, 28

N

Neutral, Color Temp. 35
Normal (Screen Mode) 30

O

off, turning off the TV 3
on, turning on the TV 3

P

parental control, described 2
Parental Lock Settings 42
password, changing 43
Pause button 22
PIC MODE button 22

Picture modes, selecting 35
 Picture Settings 35
 picture, adjusting 35
 Play button 22
 POWER button 3
 power cord, removing from holder 3
 powering on/off, the TV 3
 presetting channels 40
 Pro (Video) mode 35
 Program Guide 29
 progressive 1, 22, 36, 49

R

ratings, setting 42–44
 ratings, viewing blocked programs 43, 44
 Record buttons 22
 remote control
 inserting batteries 21
 programming 24–25
 removing, Favorite Channels 32
 RESET button 22
 resetting
 Picture options 35
 Sound options 37
 Rewind button 22

S

S VIDEO jack, described 3, 4
 SAT/CABLEFUNCTION button 23
 SAT/CABLE POWER button 22
 satellite receiver, using with TV remote control 26
 Screen Mode 30, 39
 SCREEN MODE button 30
 Screen Settings 39
 Settings
 Applications 47
 Channel 40
 Parental Lock 42
 Picture 35
 Screen 39
 Setup 45
 Sound 37
 Settings, MENU 34
 Setup Settings 45
 sharpness, adjusting 35
 Simulated, Effect 37
 SLEEP button 22
 Sound Settings 37

speakers
 turning on/off 38
 using external speakers 38
 Specifications 53
 Standard mode 35
 Steady Sound, described 2
 Steady Sound, setting 37
 Stereo, MTS setting 37
 Stop button 22
 surround sound 37
 SYSTEM OFF button 22

T

Tilt Correction 20, 46
 tilt, correcting 20, 46
 transport buttons 22
 treble, adjusting 37
 Troubleshooting 50–52
 TruSurround XT 37
 TruSurround, Effect 37
 turning on/off the TV 3
 TV FUNCTION button 23, 28
 TV POWER button 22, 28
 TV, MENU 34
 TV/VIDEO button 23, 28

V

Variable audio setting 38
 VCR
 using with TV remote control 26
 with cable box, connecting 9
 with cable, connecting 8
 with satellite receiver, connecting 12
 Vertical Center 39
 Vertical Correction 20, 46
 Vertical Expand (Screen Mode) 31
 Vertical Size, adjusting 39
 VHF/UHF jack, described 4
 VIDEO (L/R)/AUDIO jacks, described 4
 Vivid mode 35
 VOL buttons 3, 22, 28

W

Warm, Color Temp. 35
 Wega, described 1
 Wide Zoom 30
 WOW 37

Z

Zoom (Screen Mode) 30, 31

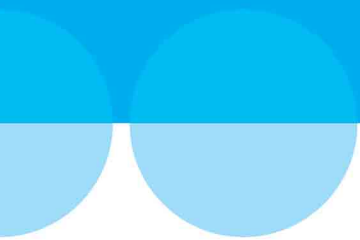

2671222211