



FD Trinitron
WEGA[®]

Operating Instructions

KD-32FS130
KD-36FS130

WARNING

To reduce the risk of fire or electric shock, do not expose the TV to rain or moisture.



This symbol is intended to alert the user to the presence of uninsulated “dangerous voltage” within the product’s enclosure that may be of sufficient magnitude to constitute a risk of electric shock to persons.



This symbol is intended to alert the user to the presence of important operating and maintenance (servicing) instructions in the literature accompanying the appliance.

Note to the CATV Installer

This reminder is provided to call the CATV system installer’s attention to Article 820-40 of the NEC that provides guidelines for proper grounding and, in particular, specifies that the cable ground shall be connected to the grounding system of the building as close to the point of cable entry as practical.

SAFETY PRECAUTIONS

- Operate the TV only on 120 V AC.
- One blade of the power plug is wider than the other for safety purposes and will fit into the power outlet only one way. If you are unable to insert the plug fully into the outlet, contact your dealer.
- If any liquid or solid object falls into the TV, unplug it and have it checked by qualified personnel before operating it further.

CAUTION

When using TV games, computers, and similar products with your TV, keep the brightness and contrast functions at low settings. If a fixed (non-moving) pattern is left on the screen for long periods of time at a high brightness or contrast setting, the image can be permanently imprinted onto the screen. Continuously watching the same channel can cause the imprint of station logos onto the TV screen. These types of imprints are not covered by your warranty because they are the results of misuse.



To reduce the risk of electric shock, do not use this polarized plug with an extension cord, receptacle, or other outlet unless the blades can be fully inserted to prevent blade exposure.



You are cautioned that any changes or modifications not expressly approved in this manual could void your authority to operate this equipment.

NOTIFICATION

This equipment has been tested and found to comply with the limits for a Class B digital device pursuant to Part 15 of the FCC Rules. These limits are designed to provide reasonable protection against harmful interference in a residential installation. This equipment generates, uses, and can radiate radio frequency energy and, if not installed and used in accordance with the instructions, may cause harmful interference with radio communications. However, there is no guarantee that interference will not occur in a particular installation. If this equipment does cause harmful interference to radio or television reception, which can be determined by turning the equipment off and on, the user is encouraged to try to correct the interference by one or more of the following measures:

- Reorient or relocate the receiving antennas.
- Increase the separation between the equipment and receiver.
- Connect the equipment into an outlet on a circuit different from that to which the receiver is connected.
- Consult the dealer or an experienced radio/TV technician for help.

Protecting the TV

- To prevent internal heat build-up, do not block the ventilation openings.
- Do not install the TV in a hot or humid place, or in a place subject to excessive dust or mechanical vibration.

Note on Caption Vision

This television receiver provides display of television closed captioning in accordance with § 15.119 of the FCC rules. Use of this television for other than private viewing of programs broadcast on UHF or VHF or transmitted by cable companies for the use of the general public may require authorization from the broadcaster-cable company and/or program owner.

Owner’s Record

The model and serial numbers are located on the front cover of this manual and at the rear of your TV.

Note

This television also includes a QAM demodulator which should allow you to receive unscrambled digital cable television programming via subscription service to a cable service provider. Availability of digital cable television programming in your area depends on the type of programming and signal provided by your cable service provider.

IMPORTANT SAFEGUARDS

For your protection, please read these instructions completely, and keep this manual for future reference. Carefully observe and comply with all warnings, cautions and instructions placed on the set, or described in the operating instructions or service manual.

WARNING

To guard against injury, the following basic safety precautions should be observed in the installation, use, and servicing of the set.

Use

Power Sources

This set should be operated only from the type of power source indicated on the serial/model plate. If you are not sure of the type of electrical power supplied to your home, consult your dealer or local power company. For those sets designed to operate from battery power, refer to the operating instructions.



Grounding or Polarization

This set may be equipped with a polarized alternating current line plug (a plug having one blade wider than other). This plug will fit into the power outlet only one way. This is a safety feature. If you are unable to insert the plug fully into the outlet, try reversing the plug. If the plug still fails to fit, contact your electrician to replace your obsolete outlet. Do not defeat the safety purpose of the polarized plug.



For the set with a three-wire grounding type AC plug

This plug will only fit into a grounding-type power outlet. This is a safety feature. If you are unable to insert the plug into the outlet, contact your electrician to have a suitable outlet installed. Do not defeat the safety purpose of the grounding plug.

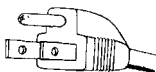

Overloading

Do not overload wall outlets, extension cords or convenience receptacles beyond their capacity, since this can result in fire or electric shock.

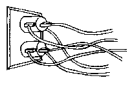

Always turn the set off when it is not to be used. When the set is left unattended and unused for long periods of time, unplug it from the wall outlet as a precaution against the possibility of an internal malfunction that could create a fire hazard.

Do not disconnect the antenna or the power cord during a heavy storm. Lightning may strike while you are holding the cable or cord, causing serious injury. Turn off your TV and wait for the weather to improve.



Object and Liquid Entry

Never push objects of any kind into the set through the cabinet slots as they may touch dangerous voltage points or short out parts that could result in a fire or electric shock. Never spill liquid of any kind on the set.



Attachments

Do not use attachments not recommended by the manufacturer, as they may cause hazards.

Do not place any objects, especially heavy objects, on top of the set. The object may fall from the set, causing injury.



Cleaning

Unplug the set from the wall outlet before cleaning or polishing it. Do not use liquid cleaners or aerosol cleaners. Use a cloth lightly dampened with water for cleaning the exterior of the set.



If a snapping or popping sound from a TV set is continuous or frequent while the TV is operating, unplug the TV and consult your dealer or service technician. It is normal for some TV sets to make occasional snapping or popping sounds, particularly when being turned on or off.



Installation

Always use two or more people to lift or move the set. The set is heavy and the bottom surface is flat. Serious injury can result from trying to move the set by yourself alone, or from unsteady handling.

Install the set on a stable, level surface.

Water and Moisture

Do not use power-line operated sets near water — for example, near a bathtub, washbowl, kitchen sink, or laundry tub, in a wet basement, or near a swimming pool, etc.



Accessories

Do not place the set on an unstable cart, stand, tripod, bracket, table, or shelf. The set may fall, causing serious injury to a child or an adult, and serious damage to the set. Use



only a cart or stand recommended by the manufacturer for the specific model of TV. Any mounting of the product should follow the manufacturer's instructions, and should use a mounting accessory recommended by the manufacturer. An appliance and cart combination should be moved with care. Quick stops, excessive force, and uneven surfaces may cause the appliance and cart combination to overturn.

Ventilation

The slots and openings in the cabinet and in the back or bottom are provided for necessary ventilation. To ensure reliable operation of the set, and to protect it from overheating, these slots and openings must never be blocked or covered.

- Never cover the slots and openings with a cloth or other materials.



- Never block the slots and openings by placing the set on a bed, sofa, rug or other similar surface.

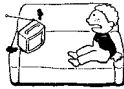

- Never place the set in a confined space, such as a bookcase or built-in cabinet, unless proper ventilation is provided.



- Do not place the set near or over a radiator or heat register, or where it is exposed to direct sunlight.



Power-Cord Protection

Do not allow anything to rest on or roll over the power cord, and do not place the set where the power cord is subject to wear or abuse.



Antennas

Outdoor Antenna Grounding

If an outdoor antenna is installed, follow the precautions below. An outdoor antenna system should not be located in the vicinity of overhead power lines or other electric light or power circuits, or where it can come in contact with such power lines or circuits.

WHEN INSTALLING AN OUTDOOR ANTENNA SYSTEM, EXTREME CARE SHOULD BE TAKEN TO KEEP FROM CONTACTING SUCH POWER LINES OR CIRCUITS AS CONTACT WITH THEM IS ALMOST INVARIABLY FATAL.

Be sure the antenna system is grounded so as to provide some protection against voltage surges and built-up static charges. Section 810 of the National Electrical Code (NEC) in USA and Section 54 of the Canadian Electrical Code in Canada provides information with respect to proper grounding of the mast and supporting structure, grounding of the lead-in wire to an antenna discharge unit, size of grounding conductors, location of antenna discharge unit, connection to grounding electrodes, and requirements for the grounding electrode.

Antenna Grounding According to the NEC

Antenna Grounding According to the National Electrical Code, ANSI/NFPA 70.

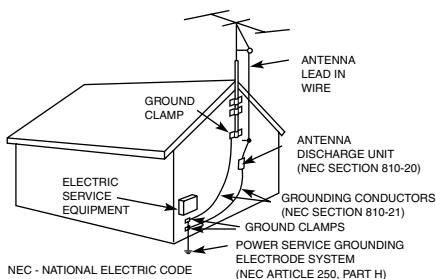

Lightning

For added protection for this television receiver during a lightning storm, or when it is left unattended and unused for long periods of time, unplug it from the wall outlet and disconnect the antenna. This will prevent damage to the receiver due to lightning and power-line surges.

Service

Damage Requiring Service

Unplug the set from the wall outlet and refer servicing to qualified service personnel under the following conditions:

- When the power cord or plug is damaged or frayed.

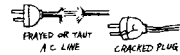

- If liquid has been spilled into the set or objects have fallen into the product.



- If the set has been exposed to rain or water.



- If the set has been subject to excessive shock by being dropped, or the cabinet has been damaged.

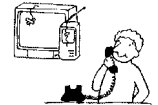

- If the set does not operate normally when following the operating instructions. Adjust only those controls that are specified in the operating instructions. Improper adjustment of other controls may result in damage and will often require extensive work by a qualified technician to restore the set to normal operation.

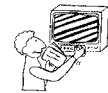

- When the set exhibits a distinct change in performance — this indicates a need for service.

Servicing

Do not attempt to service the set yourself since opening the cabinet may expose you to dangerous voltage or other hazards. Refer all servicing to qualified service personnel.



Replacement Parts

When replacement parts are required, be sure the service technician certifies in writing that he has used replacement parts specified by the manufacturer that have the same characteristics as the original parts. Unauthorized substitutions may result in fire, electric shock, or other hazards.



Safety Check

Upon completion of any service or repairs to the set, ask the service technician to perform routine safety checks (as specified by the manufacturer) to determine that the set is in safe operating condition, and to so certify. When the set reaches the end of its useful life, improper disposal could result in a picture tube implosion. Ask a qualified service technician to dispose of the set.



Trademarks and Copyrights



As an ENERGY STAR® Partner, Sony Corporation has determined that this product meets the ENERGY STAR® guidelines for energy efficiency. ENERGY STAR® is a U.S. registered mark.



SRS and the (●)® symbol are trademarks of SRS Labs, Inc.



Manufactured under license from Dolby Laboratories Licensing Corporation. Dolby and the double-D symbol are trademarks of Dolby Laboratories.



Manufactured under license from BBE Sound, Inc. Licensed by BBE Sound, Inc. under USP 4638258, 5510752 and 5736897. BBE and BBE symbol are registered trademarks of BBE Sound, Inc.

WEGA, FD Trinitron and Steady Sound are registered trademarks of Sony Corporation.

Contents

Introduction

Introducing the FD Trinitron WEGA	
Features	7
About this Manual	8
Batteries for the Remote Control	8
Front Panel Menu Controls	8

Using the Remote Control

Remote Control Description	9
Programming the Remote Control	11
Using your TV Remote Control with Other Equipment.....	13

Connecting Your TV

TV Rear Panel	15
Basic Connections	16
Connecting Additional Equipment	17

Setting Up the TV

Using the Digital Features

Overview	29
Tuning to a Digital Channel	29
Using the Digital Program Guide.....	30
Using the Screen Mode Feature	32
Using Digital Favorite Channels.....	33

Using the Analog Menus

Overview	35
Menu Descriptions	35
Using the Remote Control to Navigate the On-Screen Analog Menus.....	37
Using the Video Menu	38
Using the Audio Menu	39
Using the Channel Setup Menu	41
Using the Parental Control Menu	43
Parental Control	44
United States: Selecting Custom Rating Options	46
Canada: Selecting Custom Rating Options	48
Using the Timer Menu	49
Using the Setup Menu	50
Using the Digital Features Menu	51

Using the Digital Menus

Overview	53
Menu Descriptions	53
Using the Remote Control to Navigate the On-Screen Digital Menus.....	54
Displaying Digital Menus	54
Using the Digital Channels Menu.....	55
Using the Digital Setup Menu	57

Other Information

Troubleshooting.....	59
Specifications.....	63

Index..... 65

Introduction

Congratulations on your purchase of the Sony FD Trinitron WEGA®.

Introducing the FD Trinitron WEGA Features

Some of the features you will enjoy include:

- ❑ **FD Trinitron Flat CRT** — Delivers a picture with uncompromising accuracy and outstanding image detail via a technologically advanced tube.
- ❑ **Analog and Digital Receivers** — Built-in tuners allow you to receive both analog (NTSC) and digital (ATSC and clear-QAM) programming. Digital programming is available via terrestrial signals (over-the-air) or unscrambled cable signals provided by your cable company. (Contact your cable provider for details of digital cable programming availability and restrictions.)
- ❑ **Wide Screen Mode** — Watch digital 16:9 (widescreen) broadcasts in their original widescreen format, or zoom to fill the 4:3 aspect ratio screen.
- ❑ **Y Pb Pr Inputs** — Provides component video inputs for superior picture quality (480i only).
- ❑ **BBE** — Gives sound more impact by using audio technology to compensate for phase effects in speakers.
- ❑ **SRS** — Produces a dynamic three-dimensional sound for stereo programs.
- ❑ **Parental Control (V-Chip)** — Helps parents monitor what their children watch on TV by establishing rating limits.
- ❑ **ClearEdge VM** — Sharpens picture definition to give objects a crisp, clean edge.
- ❑ **Favorite Channels** — Enables you to set up separate Favorite Channel lists for analog and digital channels.
- ❑ **Digital Program Guide** — Select digital channels from an on-screen program guide.
- ❑ **Universal Remote Control** — Operates your connected cable box, VCR, digital satellite receiver, DVD player, or DVD/VCR combination unit.
- ❑ **Energy Star®** — Meets the Energy Star guidelines for energy efficiency.
- ❑ **Front Panel Controls** — Allows access to the on-screen menus without the use of a remote control.
- ❑ **Front A/V Inputs** — Lets you quickly connect video games, camcorders, or stereo/mono equipment.



About this Manual

This manual provides instructions to help you enjoy your new TV. It shows you how to connect to an antenna or cable, cable box, VCR, DVD, satellite receiver, stereo system, or camcorder. Once your TV is connected, follow the instructions and use the remote control to access the on-screen menus.

Batteries for the Remote Control

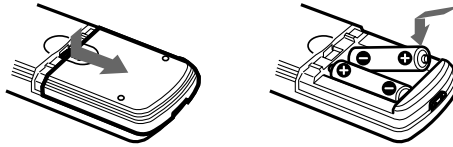
Insert two AA (R6) batteries (supplied) into the remote control using the following illustration as a guide.



-  Under normal conditions, batteries will last up to six months. If the remote control does not operate properly, the batteries might be worn out.
-  If you will not be using the remote control for an extended period of time, remove the batteries to avoid possible damage from battery leakage.

Front Panel Menu Controls

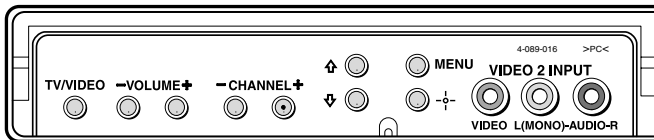

The front Audio/Video panel controls allow you to access the menu without the remote control.

- Press the **MENU** button to display the on-screen menu.
- Use the \uparrow and \downarrow buttons on the front Audio/Video panel instead of your remote control.
- Use the \rightarrow - button on the front Audio/Video panel to navigate through the menus, then select an item. The front panel controls also allow you to change your channels (**-CHANNEL+**), adjust the volume (**-VOLUME+**), and change video inputs (**TV/VIDEO**).

-  To navigate the menus with your remote control, see pages 37 and 54.

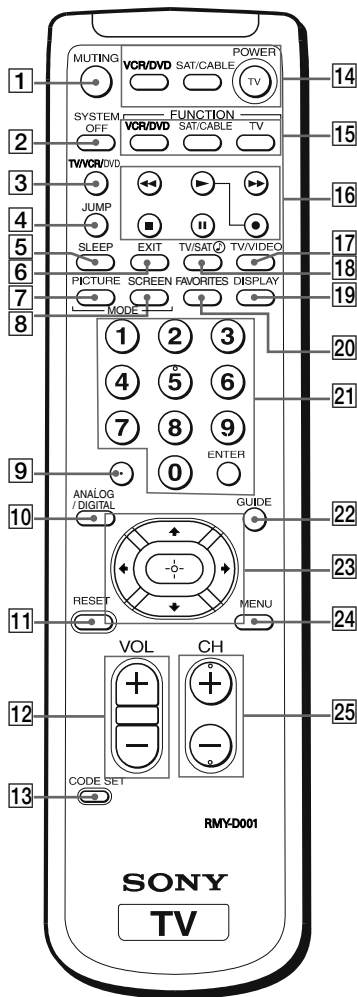

Using the Remote Control

Remote Control Description



Button	Description
1 MUTING	Press to turn off the sound. Press again or press VOL+ to restore sound.
2 SYSTEM OFF	Press to turn off the equipment programmed into the remote control. See "Programming the Remote Control" on page 11. This button does not work with DVD/VCR combo units, and may not work with older Sony equipment.
3 TV/VCR/DVD	Press to change the VHF/UHF output of the VCR (or DVD/VCR combination unit). If you have a non-Sony VCR or DVD, you will need to program the remote control to recognize your VCR or DVD. For details, see "Programming the Remote Control" on page 11.
4 JUMP	Press to jump back and forth between the current channel and the last channel that you selected. (JUMP does not switch between analog and digital channels.)
5 SLEEP	Press repeatedly until the TV displays the time in minutes (15, 30, 45, 60, or 90) that you want the TV to remain on before shutting off automatically. Cancel by pressing until Sleep Off appears.
6 EXIT	Press to exit menus and other on-screen displays.
7 PICTURE MODE	Press repeatedly to step through the available video picture modes: Vivid, Standard, Movie, and Pro. Also available in the Video menu. See "Using the Video Menu" on page 38 for details.
8 SCREEN MODE	D Press to toggle among the Screen Mode options. For details on using Screen Mode, see page 32. Also available in the Digital Setup menu (see page 57).
9	D Use with 0-9 and ENTER buttons to select digital channels (for example, 2.1). For details on selecting digital channels, see page 29.
10 ANALOG /DIGITAL	Press to switch between analog and digital tuning modes.
11 RESET	Press to return to factory settings while in an on-screen menu.
12 VOL (volume)	Press (+) or (-) to adjust the volume.
13 CODE SET	Press to program your remote control to operate connected video equipment. See "Programming the Remote Control" on page 11.

D Indicates feature available only in digital tuning mode.

Button	Description
14 POWER buttons	Press to turn on and off the TV and other audio/video equipment you have programmed into the remote control. For instructions, see "Programming the Remote Control" on page 11.
15 FUNCTION buttons	Press to select the equipment (VCR/DVD, SAT/CABLE, TV) that you want to operate with the remote control. The indicator (LED) lights up momentarily when pressed to show which device the remote control is operating.
16 VCR/DVD (operating)	Press to operate your VCR or DVD. The VCR or DVD must be programmed into the remote control. For instructions, see "Programming the Remote Control" on page 11.
● and ► (to record)	Press the ● button and the ► button at the same time to record programs with your VCR. The remote control must be programmed before you can record.
◀◀	Rewind.
▶▶	Fast-forward.
▶	Play.
■	Stop.
 	Pause. Press again to resume normal playback.
17 TV/VIDEO	Press to cycle through available video inputs.
18 TV/SAT	Press to switch between the TV and SAT (satellite) inputs when in SAT FUNCTION mode.
	Press for a direct selection of Effect settings (Simulated, SRS, Off) when the remote is in TV FUNCTION mode. See "Using the Audio Menu" on page 39 for details.
19 DISPLAY	Press once to display the current time (if set) and the program status such as channel number, Channel Label (if set), video input, Video Label (if set), and Info Banner (if set). Press again to turn off the display.
20 FAVORITES	Press to display the analog or digital Favorite Channels list, depending on the current tuning mode (analog or digital).
21 0-9 and ENTER	Press to change channels. The channel changes after two seconds.
22 GUIDE	D Press to display the digital program guide. For details, see page 30.
23 	Press the arrow buttons to move the cursor in the on-screen menus. Press the center button to select an option. (If no menu or display is shown, pressing the center button displays the Favorite Channels list.)
24 MENU	Press to display and exit the analog menu. For details, see page 35. (To display the digital menu, see page 54.)
25 CH (channel)	Press to change analog or digital channels, depending on the current tuning mode (analog or digital). To scan rapidly through the channels, press and hold down the CH+ or CH- button.

D Indicates feature available only in digital tuning mode.

 If you lose your remote control, see page 60.



Programming the Remote Control

If you have video equipment other than Sony brand (or if you have a Sony DVD/VCR combination unit) that you want to control with the TV's remote control, use the following procedure to program the remote control.



1 Check the list of "Manufacturer's Codes" on page 12 and find the three-digit code number for the manufacturer of your component. If more than one code number is listed, use the number listed first.

2 Press .

 The  and  **FUNCTION** button flash when you press .

3 Press  or  **FUNCTION** button to indicate the type of component you want to program with the remote control.

 You must do step 4 within 10 seconds of step 3, or you must redo steps 2 and 3.

4 Use the - buttons to enter the three-digit manufacturer's code number.

5 Press .

6 To check if the code number works, aim the TV's remote control at the component and press the green **POWER** button (**VCR/DVD**, **SAT/CABLE**) that corresponds with that component. If it responds, you are done. If not try using another code listed for that manufacturer.

 If you have problems programming your remote control, see the remote control troubleshooting section on page 60.

Manufacturer's Codes

VCRs

<i>Manufacturer</i>	<i>Code</i>
Sony	301, 302, 303
Admiral (M. Ward)	327
Aiwa	338, 344
Audio Dynamic	314, 337
Broksonic	319, 317
Canon	309, 308
Citizen	332
Craig	302, 332
Criterion	315
Curtis Mathes	304, 338, 309
Daewoo	341, 312, 309
DBX	314, 336, 337
Dimensia	304
Emerson	319, 320, 316, 317, 318, 341
Fisher	330, 335
Funai	338
General Electric	329, 304, 309
Go Video	322, 339, 340
Goldstar	332
Hitachi	306, 304, 305, 338
Instant Replay	309, 308
JC Penney	309, 305, 304, 330, 314, 336, 337
JVC	314, 336, 337, 345, 346, 347
Kenwood	314, 336, 332, 337
LXI (Sears)	332, 305, 330, 335, 338
Magnavox	308, 309, 310
Marantz	314, 336, 337
Marta	332
Memorex	309, 335
Minolta	305, 304
Mitsubishi/ MGA	323, 324, 325, 326
Multitech	325, 338, 321
NEC	314, 336, 337
Olympic	309, 308
Optimus	327
Panasonic	308, 309, 306, 307
Pentax	305, 304

Philco	308, 309
Philips	308, 309, 310
Pioneer	308
Quasar	308, 309, 306
RCA/PROSCAN	304, 305, 308, 309, 311, 312, 313, 310, 329
Realistic	309, 330, 328, 335, 324, 338
Sansui	314
Samsung	322, 313, 321
Sanyo	330, 335
Scott	312, 313, 321, 335, 323, 324, 325, 326
Sharp	327, 328
Shintom	315
Signature 2000 (M. Ward)	338, 327
SV2000	338
Sylvania	308, 309, 338, 310
Symphonic	338
Tashiro	332
Tatung	314, 336, 337
Teac	314, 336, 338, 337
Technics	309, 308
Toshiba	312, 311
Wards	327, 328, 335, 331, 332
Yamaha	314, 330, 336, 337
Zenith	331

Laserdisc Players

<i>Manufacturer</i>	<i>Code</i>
Sony	701
Panasonic	704, 710
Pioneer	702

DVD/VCR Combination Units

<i>Manufacturer</i>	<i>Code</i>
Sony	601
Broksonic	605
JVC	604
Panasonic	609
Samsung	603
Toshiba	602

DVD Players

<i>Manufacturer</i>	<i>Code</i>
Sony	751
Hitachi	758
JVC	756
Magnavox	757
Mitsubishi	761
Onkyo	762
Oritron	759
Panasonic	753
Philips	757
Pioneer	752
RCA	755
Samsung	758
Toshiba	754
Zenith	760

Cable Boxes









<i>Manufacturer</i>	<i>Code</i>
Sony	230
Hamlin/Regal	222, 223, 224, 225, 226
Jerrold/G.I./ Motorola	201, 202, 203, 204, 205, 206, 207, 208, 218
Oak	227, 228, 229
Panasonic	219, 220, 221
Pioneer	211, 214, 215
Scientific Altanta	209, 210, 211
Tocom	216, 217
Zenith	212, 213

Satellite Receivers

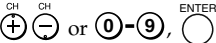



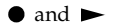



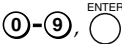

<i>Manufacturer</i>	<i>Code</i>
Sony	801
DIRECT TV	809
Dish Network	810
Echostar	810
General Electric	802
Hitachi	805
Hughes	804
Mitsubishi	809
Panasonic	803
Philips	811
RCA/PROSCAN	802, 808
Samsung	812
Toshiba	806, 807

Using your TV Remote Control with Other Equipment



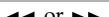





Operating a VCR

Press	To
	Activate the remote control to operate the VCR (FUNCTION button)
	Power on/off the VCR (VCR/DVD green button)
 (using tuner)	Change channels
	Play video tape
	Stop
	Rewind or Fast-forward a video tape
	Pause
 (Simultaneously)	Record
	Switch between VCR and TV inputs

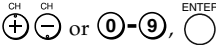







Operating a DVD Player

Press	To
	Activate the remote control to operate the DVD (FUNCTION button)
	Power on/off the DVD (VCR/DVD green button)
	Select chapters
	Search chapters forward or backward
	Play DVD
	Stop
	Pause
	Search the picture forward or backward during playback
	Display the DVD menu
	Use the arrow buttons to move the cursor in the menu, and the center button to select an option
	Switch between DVD and TV inputs

Operating a Cable Box or Satellite Receiver

Press	To
	Activate the remote control to operate the cable box or satellite receiver (FUNCTION button)
	Power on/off the cable box or satellite receiver (SAT/CABLE green button)
 (using tuner)	Change channels
	Change back to previous channel
	Display channel number (satellite receiver)
	Display SAT guide (satellite receiver)
	Display SAT menu (satellite receiver)
	Use the arrow buttons to move the cursor in the menu, and the center button to select an option (satellite receiver)
	Press to switch between the TV and SAT inputs (satellite receiver)

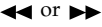
Operating a DVD/VCR Combination Unit

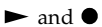
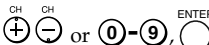
Press	To
	Activate the remote control to operate the DVD/VCR (FUNCTION button)
	Power on/off the DVD/VCR Combination unit (VCR/DVD green button)
	When the VCR is not playing, this button switches between the DVD player and VCR's tuner
	Display the DVD menu
	Play
	Stop
	Pause
	Rewind or fast-forward a video tape (VCR) Search the picture forward or backward during playback (DVD)
	Use the arrow buttons to move the cursor in the menu, and the center button to select an option (DVD)
 (Simultaneously)	Record (VCR)
 (using tuner)	Change channels (VCR)

Connecting Your TV

Read this section before setting up your TV for the first time. This section explains how to make the basic connections and how to connect optional equipment.

TV Rear Panel

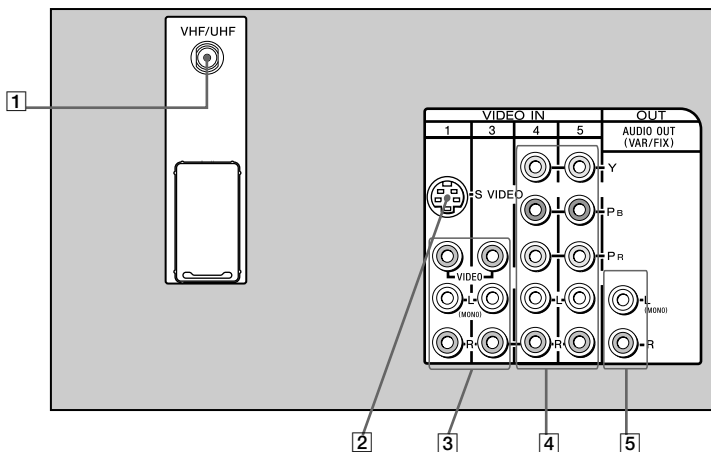

Jack	Description
1 VHF/UHF	This input connects to your VHF/UHF antenna or cable.
2 S VIDEO	This input connects to the S VIDEO OUT jack on your VCR or other video equipment that has S VIDEO. S VIDEO provides better picture quality than the VHF/UHF jacks or the video input jack. S VIDEO does not provide sound, so you still must connect the audio cables.
3 VIDEO/AUDIO L(MONO), R	This input connects to the AUDIO/VIDEO output jacks on your VCR or other video equipment. A third video input jack (VIDEO 2) is located on the front panel of the TV. These AUDIO/VIDEO input jacks provide better picture quality than the VHF/UHF jack.
4 Y P_B P_R/ L, R	This input connects to the component video Y P _B P _R and AUDIO L, R jacks on your DVD player or digital set-top box (480i only).
5 AUDIO OUT (VAR/FIX) L(MONO), R	This jack connects to the AUDIO input jacks on your audio equipment. You can listen to your TV's audio through your stereo system.

Basic Connections

TV with Cable, Indoor, or Outdoor Antenna

Depending on the cable system available in your home, choose one of the connections below:

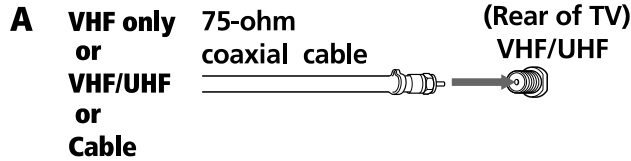

Use option A to connect the TV to a cable system or an antenna with a 75-ohm cable (usually built into newer homes).

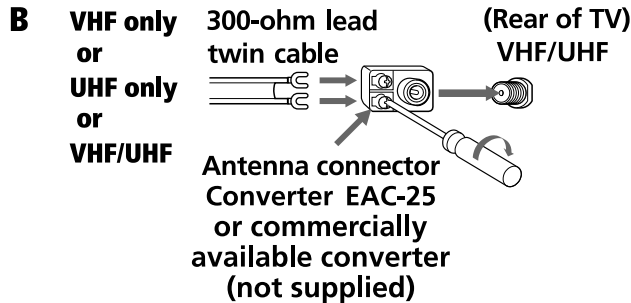

 Converter EAC-25 is commercially known as a 300-to-75 ohm antenna adapter.

Use option B to connect the TV to a dipole antenna, also known as a “rabbit ears antenna” (usually found in older homes).

 If you are connecting to an indoor or outdoor antenna, you may need to adjust the orientation of the antenna for the best reception.

Connecting Two RF Inputs

If you want to watch RF signals for both antenna (over-the-air) and cable broadcast signals, you’ll need to use an optional A-B switch for RF inputs (not supplied), as shown below.

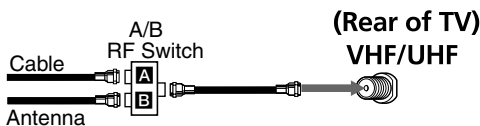

Use the A-B selector to switch between the over-the-air signals and the cable signals. Then set the **Cable** setting in the Channel Setup menu to **On** or **Off**, as described on page 41.

 For best results, be sure to use an RF switch, as shown above, instead of a simple splitter.

Connecting Additional Equipment

Connecting a TV and VCR

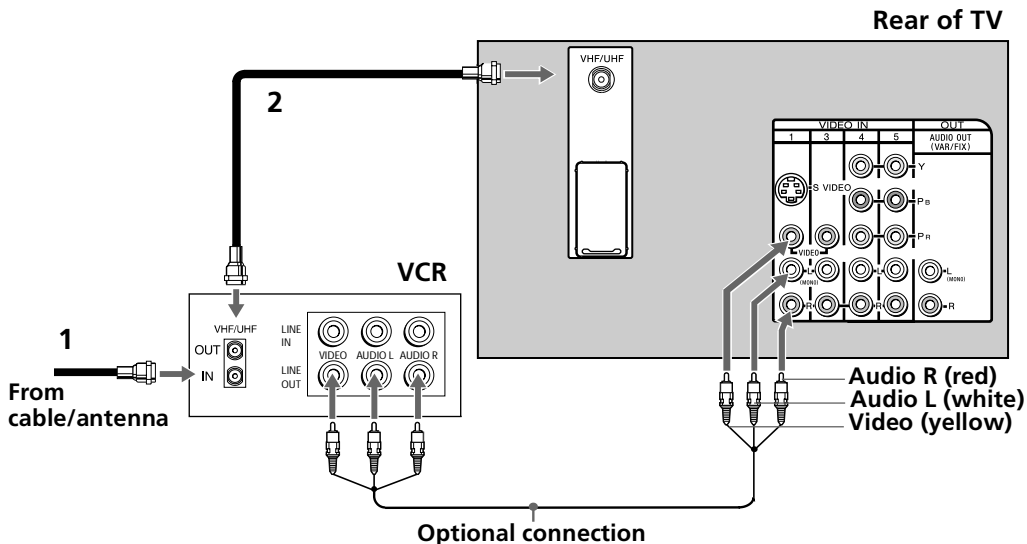



- 1 Connect the coaxial cable from your TV antenna or cable service to the IN jack on your VCR.
- 2 Connect a coaxial cable (not supplied) from the OUT jack on your VCR to the VHF/UHF jack on the TV.

Optional connection

- ❑ If your VCR is equipped with video outputs, you can get better picture quality by connecting audio/video cables (not supplied) from AUDIO/VIDEO OUT on your VCR to AUDIO/VIDEO IN on your TV.
- ❑ For better picture quality, use S VIDEO instead of the yellow video cable. S VIDEO does not provide sound, so you still must connect the audio cables.

Using your TV with this connection

- ❑ Program your Sony remote control to operate your VCR (see "Programming the Remote Control" on page 11).
- ❑ To activate your remote, press the  **FUNCTION** button to operate your VCR. In order to do this, first program your remote control, then use the Channel Fix feature to set your TV to channel 3 or 4 (see page 41).
- ❑ Press  repeatedly to switch between VCR input (VIDEO input) and VHF/UHF (local channels).

Connecting a TV and Cable Box

Some cable TV systems use scrambled or encoded signals that require a cable box to view all channels. If you subscribe to such type of service, use this connection.

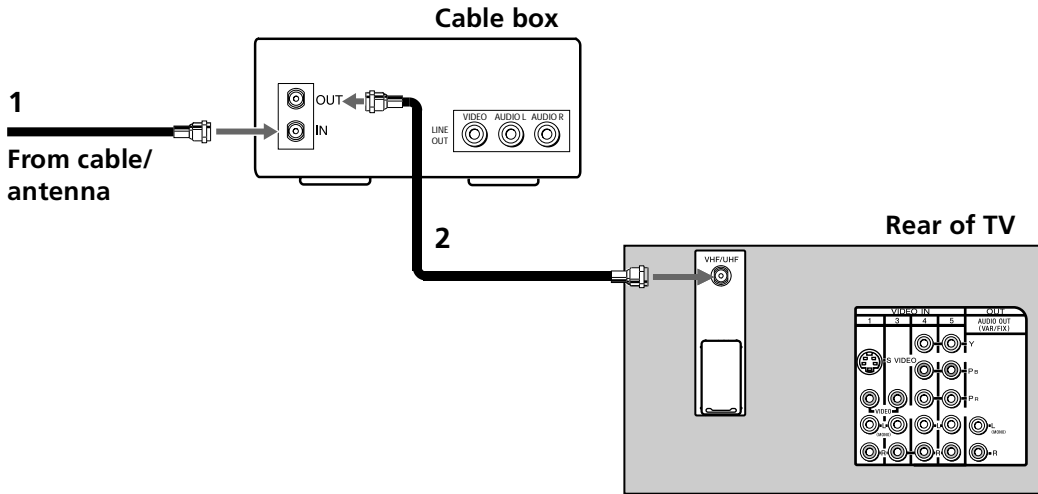

- 1 Connect the coaxial cable from your cable service to the IN jack on your cable box.
- 2 Connect a coaxial cable (not supplied) from the OUT jack on your cable box to the VHF/UHF jack on your TV.

Using your TV with this connection

- Program your Sony remote control to operate your cable box.
- To activate your remote, press the **SAT/CABLE FUNCTION** button to operate your cable box. Then use **⓪-⓪** buttons or **CH+/-** buttons to change the channels. In order to do this, first program your remote control, then use the Channel Fix feature to set your TV to channel 3 or 4 (see page 41).

Connecting a TV, VCR, and Cable Box

 **DIGITAL CABLE BOX USERS:** If you are connecting a digital cable box, you will need a special bi-directional splitter (5-900 Mhz minimum) that is designed to work with your digital cable box.

Use this connection if you subscribe to a cable system that scrambles some channels (pay channels), but not all of them. This setup allows you to:

- ❑ change channels through your cable box or VCR when you are receiving a scrambled signal
- ❑ change channels through your TV

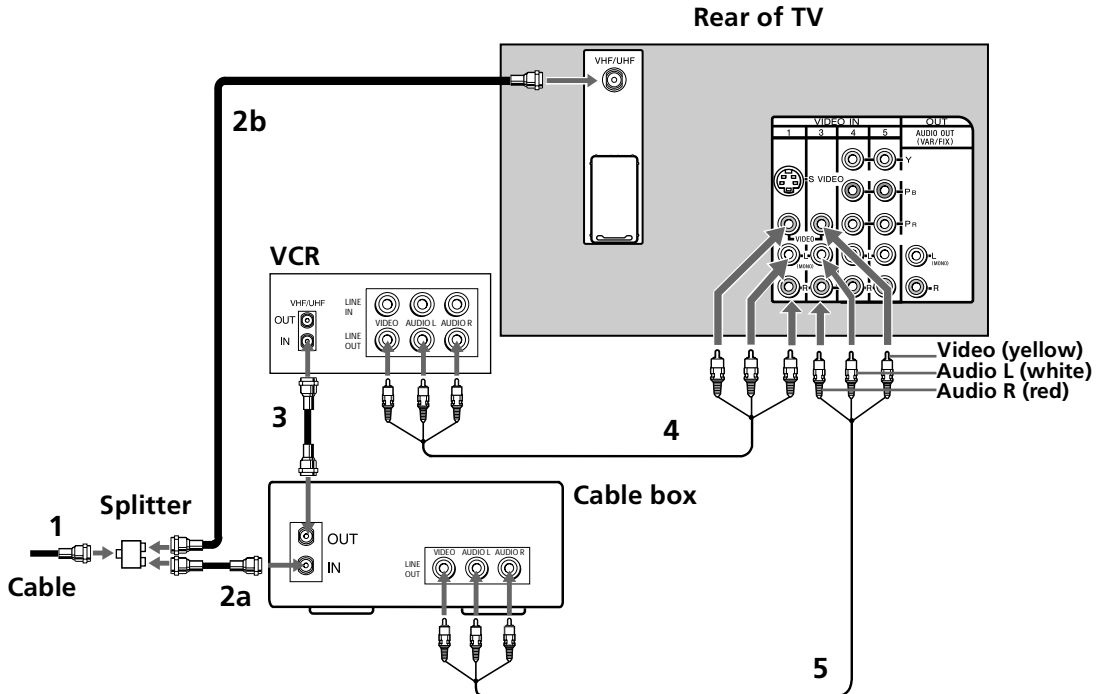



- 1** Connect the single input jack of the splitter (not supplied) to your incoming cable connection.
- 2** Using coaxial cables (not supplied), connect the two output jacks of the splitter (not supplied) to:
 - a) the IN jack on your cable box
 - b) the VHF/UHF jack on the TV
- 3** Using a coaxial cable (not supplied), connect the OUT jack on your cable box to the IN jack on your VCR.
- 4** Using audio/video cables (not supplied), connect AUDIO/VIDEO OUT on your VCR to AUDIO/VIDEO IN on your TV.
- 5** Using audio/video cables (not supplied), connect AUDIO/VIDEO OUT on your cable box to AUDIO/VIDEO IN on your TV.

Optional connection

- ❑ For better picture quality, use S VIDEO instead of the yellow video cable. S VIDEO does not provide sound, so you still must connect the audio cables.

Using your TV with this connection

- ❑ Program your Sony remote control to operate your VCR or cable box (see page “Programming the Remote Control” on page 11).
- ❑ To activate your remote, press the  **FUNCTION** button to operate your VCR or the  **FUNCTION** button to operate your cable box. In order to do this, first program your remote control, then use the Channel Fix feature to set your TV to channel 3 or 4 (see page 41).
- ❑ Press  repeatedly to switch between VCR input (VIDEO input), VHF/UHF (local channels or unscrambled), or cable box (cable system or scrambled channels).

Connecting a TV and Satellite Receiver

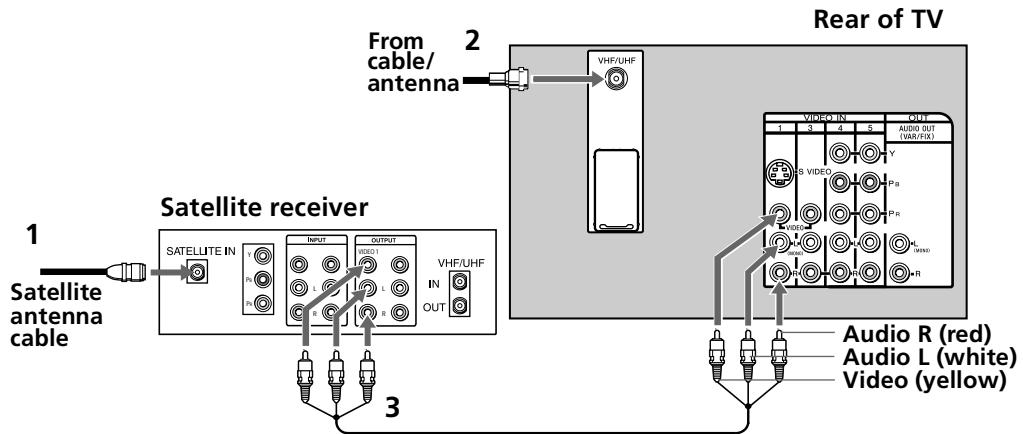

- 1** Connect the cable from your satellite antenna to SATELLITE IN on your satellite receiver.
- 2** Connect the coaxial cable from your cable service or antenna to the VHF/UHF jack on your TV.
- 3** Using audio/video cables (not supplied), connect AUDIO/VIDEO OUT on your satellite receiver to AUDIO/VIDEO IN on your TV.

Using your TV with this connection

- Program your Sony remote control to operate your satellite receiver (see “Programming the Remote Control” on page 11).
- To activate your remote, press the **SAT/CABLE FUNCTION** button to operate your satellite receiver. See page 14 for details on using other functions.
- Press **TV/VIDEO** repeatedly to switch to satellite receiver input (VIDEO input).

Connecting a TV, VCR, Cable/Antenna, and Satellite Receiver using Composite Video (VIDEO/AUDIO L(MONO), R)

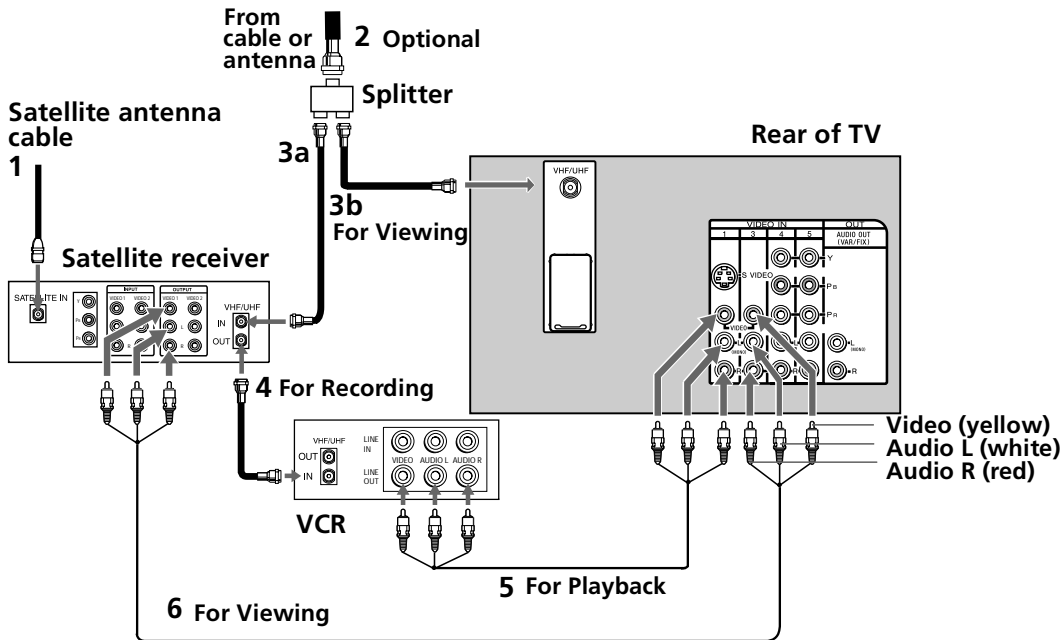

- 1** Connect the cable from your satellite antenna to SATELLITE IN on your satellite receiver.
- 2** Connect the single input jack of the splitter (not supplied) to your incoming cable/antenna (optional connection to view local channels or broadcast).
- 3** Using coaxial cables (not supplied), connect the two output jacks of the splitter (not supplied) to:
 - a)** the IN jack on your satellite receiver
 - b)** the VHF/UHF jack on the TV
- 4** Using a coaxial cable (not supplied), connect the OUT jack on your satellite receiver to the VHF/UHF IN on your VCR.
- 5** Using audio/video cables (not supplied), connect AUDIO/VIDEO OUT on your VCR to AUDIO/VIDEO IN on your TV.
- 6** Using audio/video cables (not supplied), connect AUDIO/VIDEO OUT on your satellite receiver to AUDIO/VIDEO IN on your TV.

Using your TV with this connection

- Program your Sony remote control to operate your VCR or satellite receiver (see "Programming the Remote Control" on page 11).
- To activate your remote, press the **FUNCTION** button to operate your VCR or the **FUNCTION** button to operate your satellite receiver.
- Press repeatedly to switch between VCR input (VIDEO input), VHF/UHF (local channels or unscrambled), or your cable box (cable system or scrambled channels).

Connecting a TV, VCR, and Satellite Receiver using Component Video (Y P_B P_R)

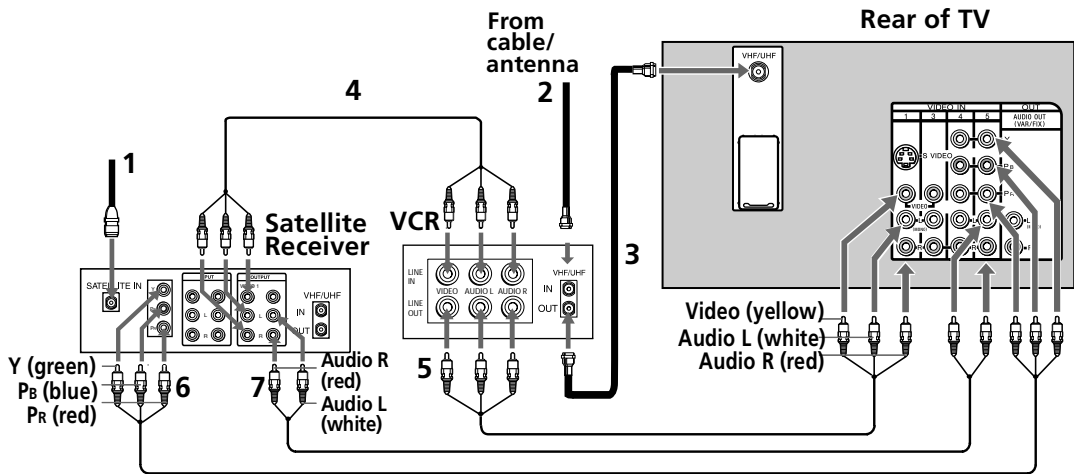

- 1** Connect the coaxial cable from your satellite antenna to SATELLITE IN on the satellite receiver.
- 2** Connect the coaxial cable from your cable service or antenna to the IN jack on your VCR.
- 3** Using a coaxial cables (not supplied), connect the OUT jack on your VCR to the VHF/UHF jack on your TV.
- 4** Using audio/video cables (not supplied), connect AUDIO/VIDEO OUT on your satellite receiver to AUDIO/VIDEO IN on your VCR.
- 5** Using audio/video cables (not supplied), connect AUDIO/VIDEO OUT on your VCR to AUDIO/VIDEO IN on your TV.
- 6** Using component video cables (not supplied), connect Y P_B P_R OUT on your satellite receiver to Y P_B P_R IN on your TV.
- 7** Connect AUDIO OUT on your satellite receiver to AUDIO IN on your TV.

Using your TV with this connection

- Program your Sony remote control to operate your VCR or satellite receiver (see "Programming the Remote Control" on page 11).
- Turn on your VCR to enable your satellite receiver to work with this connection.
- To activate your remote, press the **FUNCTION** button to operate your VCR or the **FUNCTION** button to operate your satellite receiver.
- Press repeatedly to switch between VCR input (VIDEO input), VHF/UHF (local channels or unscrambled), or your cable box (cable system or scrambled channels).

Connecting a DVD Player using Composite Video (VIDEO/AUDIO L(MONO),R)

Using audio/video cables (not supplied), connect AUDIO/VIDEO OUT on your DVD player to AUDIO/VIDEO IN on your TV.

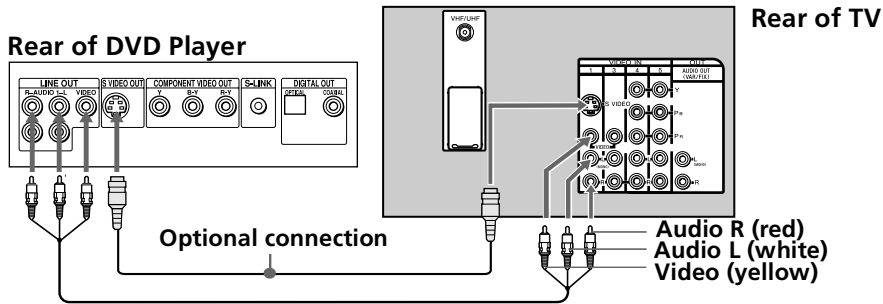

Optional connection

- ❑ For better picture quality, use S VIDEO instead of the yellow video cable. S VIDEO does not provide sound, so you still must connect the audio cables.

Connecting a DVD Player using Component Video (Y Pb Pr R L)

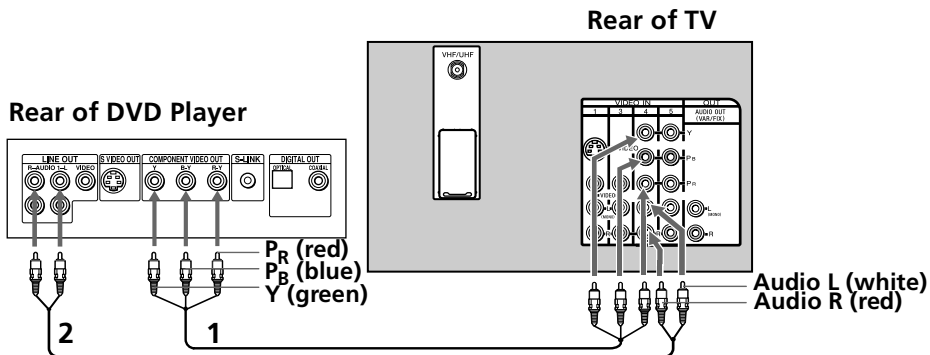

If your DVD player is equipped with component video outputs (Y Pb Pr), you can improve the picture quality by using component video cables (480i only).



- 1 Make sure your DVD player is set up (see page 59). Using component video cables (not supplied), connect Y Pb Pr OUT on your DVD player to Y Pb Pr IN on your TV.
- 2 Connect AUDIO OUT on your DVD player to AUDIO IN on your TV.

 The Y Pb Pr outputs on your DVD player are sometimes labeled Y, C_B, and C_R or Y, B-Y, and R-Y. If so, connect the cables to like colors.

Using your TV with this connection

- ❑ Program your Sony remote control to operate your DVD (see “Programming the Remote Control” on page 11).
- ❑ To activate your remote, press the  **FUNCTION** button to operate your DVD.
- ❑ Press  repeatedly to switch to the DVD player's input (VIDEO input).

Connecting an Audio System

 If you are connecting a Home Theater, please refer to your Home Theater manual for additional connections.

- 1 Using audio/video cables (not supplied), connect AUDIO OUT on your TV to one of the unused line inputs (e.g. TV, AUX, TAPE2) on your stereo.
- 2 Set the Speaker option to Off. For more instructions, see "Using the Audio Menu" on page 39-40.
- 3 After you connect the audio system, you can control the volume level from your TV or audio system.
 - ❑ To control the volume from the TV, use the front panel controls or the **VOL +/-** buttons on the remote.
 - ❑ To control the volume through the connected audio system, open the Audio Out option on the Audio menu and select Fixed. For more instructions, see "Using the Audio Menu" on page 39-40.

Rear of TV

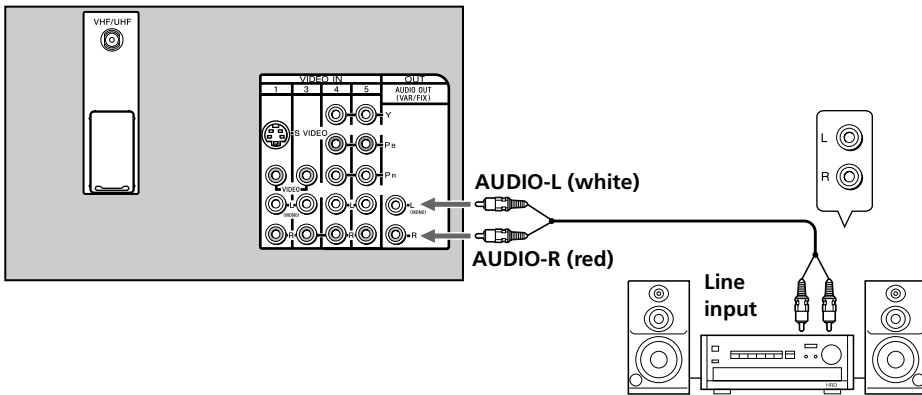

Connecting a Camcorder (for playback)

To connect your camcorder, you can use the Audio/Video inputs on either the front or rear panel of the TV. Using the audio/video cables (not supplied), connect AUDIO/VIDEO OUT on your camcorder to AUDIO/VIDEO IN on your TV.

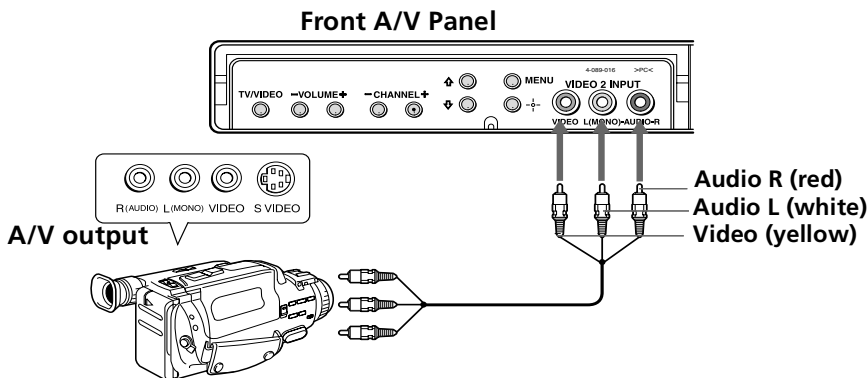

Connecting for Video Tape Editing (VCR and Camcorder)

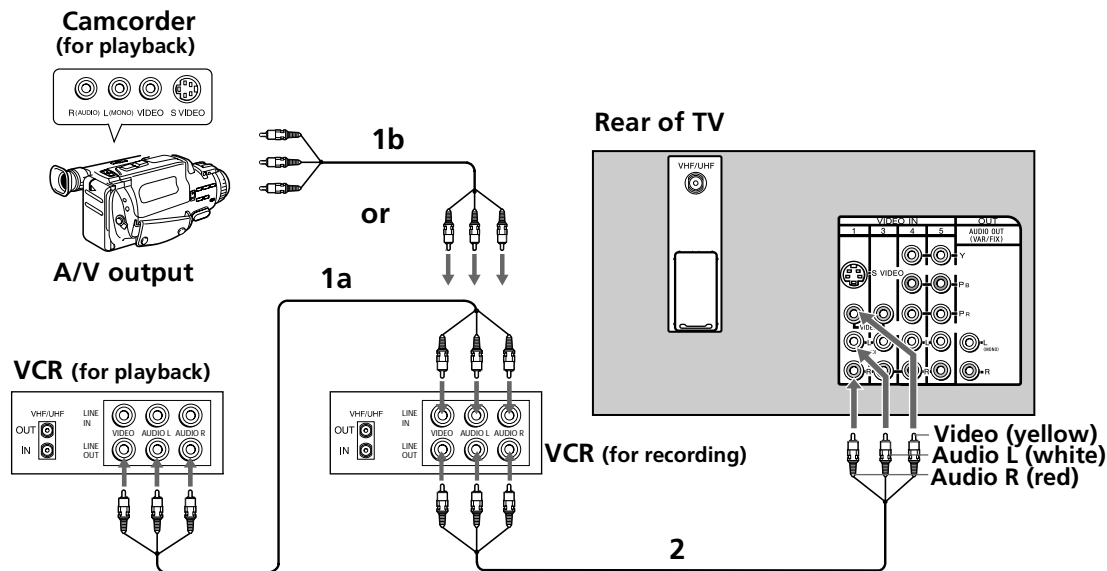

1 For video tape editing, connect the VCR to the following sources:

- ❑ If you are connecting a VCR, use audio/video cables (not supplied) to connect AUDIO/VIDEO OUT on your first VCR to AUDIO/VIDEO IN on your second VCR (option 1a).
- ❑ If you are connecting a camcorder, use audio/video cables (not supplied) to connect AUDIO/VIDEO OUT on your camcorder to AUDIO/VIDEO IN on your VCR (option 1b).

2 Using audio/video cables (not supplied), connect AUDIO/VIDEO OUT on the second VCR to AUDIO/VIDEO IN on your TV.

Using your TV with this connection

- ❑ Program your Sony remote control to operate your VCR (see “Programming the Remote Control” on page 11).
- ❑ To activate your remote, press the  **FUNCTION** button to operate your VCR. See page 13 for details on using other functions.

Setting Up the TV

After you have finished connecting your TV, use Auto Program to set up your analog and digital channel lists. During Auto Program, the TV will automatically search for available channels and program receivable channels.

 After starting Auto Program, wait until the process is complete to avoid missing some channels that are available. To re-program receivable channels, run Auto Program again as described on page 42 (analog channels) and page 55 (digital channels).

- 1** Press the **POWER** button to turn on the TV.
The Initial Setup screen appears.
- 2** Press the **CH+** button on the remote control or on the TV front panel to start Auto Program, or press the **CH-** button to exit.

 The Initial Setup screen appears each time you turn on the TV until you perform Auto Program.

Auto Program automatically creates a list of receivable analog channels. When completed, a screen prompts you to continue searching for digital channels.

Searching for digital channels may take 50 minutes or more to complete. A progress bar is displayed while the channel list is being created.

- 3** When Auto Program is finished, the lowest numbered channel is displayed.



To run Auto Program again at a later time

- Use the Auto Program feature, using the TV's menus. For analog channels, see page 42. For digital channels, see page 55.

To add digital channels

- Use the Digital Channels/Add feature, as described on page 55.

To reset the TV to factory settings

- 1** Turn the TV on.
- 2** Hold down  on the remote control.
- 3** Press and release the **POWER** button on the TV front panel. The TV will turn itself off, then back on.
- 4** Release .

Using the Digital Features

Overview













This chapter describes how to use the features of your TV that are designed to work with digital channels.

Topic	Page
Tuning to a Digital Channel	29
Using the Digital Program Guide	30
Using the Screen Mode Feature	32
Using Digital Favorite Channels	33

Tuning to a Digital Channel

This TV is equipped with a built-in digital tuner, which enables you to receive digital channels. In order to enjoy the digital features of this TV, you need to switch the TV between analog and digital tuning modes by pressing the  button on the remote control, or by switching between analog and digital tuning modes using the TV's Channel Mode menu option (see page 51).

To directly tune to a digital channel:

- 1 If the TV is in analog tuning mode, press  on the remote control to enter digital tuning mode.
- 2 Press , , , press ,  again, and then  .
For example, to select subchannel 21.13, press ++++, and then press .

Using the Digital Program Guide

The digital program guide lets you review program information and select digital channels.

The digital program guide cannot be displayed when: the TV is in analog tuning mode, when there are no digital channels available, when the TV is tuned to one of the video inputs, or when the Channel Fix option is set to anything other than Off (see page 41).

To display the digital program guide:

1 If the TV is in analog tuning mode, press the button on the remote control to switch to digital tuning mode.

You can also see the current tuning mode and switch between analog and digital tuning modes using the Channel Mode menu option (see page 51).

2 Press . The digital program guide appears, with the currently selected program showing in the background.

Program title and description, time remaining, rating information, closed-caption availability, format, resolution, aspect ratio

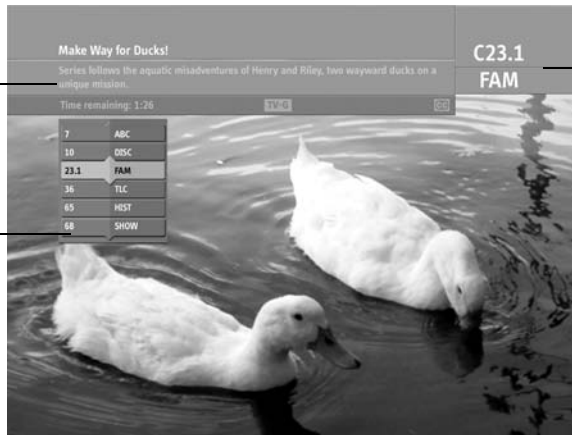

Channel number, call letters, Auto SAP (if available)

Selectable channel list

Program information in the guide is provided by the broadcasters. As a result, it may sometimes include only the channel number, without a program title or description.

To Do This ...	Do This ...
Scroll through the channel list	Press or
Select the currently displayed channel and exit the guide	Press
Display additional options	Press . See "Using Additional Digital Program Guide Options" on page 31.
Exit the Guide (without changing channels)	Press

Using Additional Digital Program Guide Options

Press ⇨ while in the digital program guide's channel list to display the following options, which allow you to customize the settings of the program on the currently tuned channel.

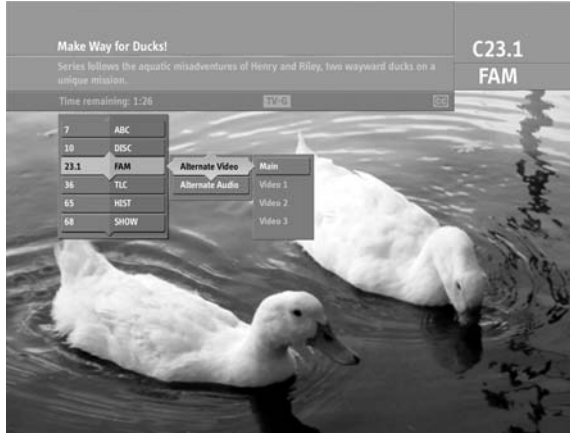

Option	Description
Alternate Video (when available)	Each program has a main video stream (the video that you see when the channel is first tuned), and may have alternate video streams. This option allows you to switch among these alternate video streams.
Alternate Audio (when available)	Each program has a main audio stream (the audio that you hear when the channel is first tuned). This option allows you to switch among these alternate audio streams (e.g., for different languages).







Using the Screen Mode Feature

The Screen Mode feature is useful for adjusting a 16:9 (widescreen) program for optimal viewing on your TV's 4:3 aspect ratio screen. Using the Screen Mode feature, you can enlarge pictures so that they better fill the screen (enlarging the picture so that the black bars on the edges of the screen are clipped off).

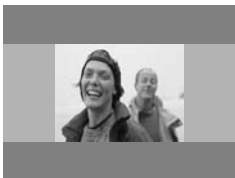
 The Screen Mode option is available only for digital 16:9 programming.

Before using the Screen Mode feature





- If the TV is in analog tuning mode, press the  button to switch to digital tuning mode.

Example	Description
  <p data-bbox="306 687 346 710">Full</p>	<p data-bbox="458 499 912 720">Full displays the 16:9 program in its original aspect ratio. If the program was a 480i 4:3 program that was upconverted to 720p or 1080i (as shown at left), there will be black bars visible at the left, right, top, and bottom sides.</p>
  <p data-bbox="297 951 356 973">Zoom</p>	<p data-bbox="458 769 895 835">Zoom enlarges the picture uniformly. Some clipping may occur.</p>
  <p data-bbox="229 1215 427 1237">Horizontal Expand</p>	<p data-bbox="458 1031 874 1124">Horizontal Expand stretches the picture horizontally. Some clipping may occur.</p>
  <p data-bbox="243 1477 413 1499">Vertical Expand</p>	<p data-bbox="458 1289 888 1355">Vertical Expand stretches the picture vertically. Some clipping may occur.</p>

Using Digital Favorite Channels

The digital Favorite Channels feature lets you select programs from a list of up to 16 favorite digital channels that you specify. You can create a list using the Favorite Channels option in the Digital Channel menu (described on page 55), or by using the Add to Favorites feature in the Favorite Channels list, as described below.

To use Digital Favorite Channels

- 1 If the TV is in analog tuning mode, press the  button to switch to digital tuning mode.
- 2 Press the  button. The Favorite Channels list appears.
- 3 Press  or  to highlight the channel you want to watch.

To add the current channel to the list of Favorite Channels, highlight **Add to Favorites** and press .

To change your Favorite Channels list, highlight **Edit Favorites** and press .

- 4 Press  to select the channel you want to watch.

Using the Analog Menus

Overview

This chapter describes how to use the analog menu features of your TV.

Topic	Page	Topic	Page
Menu Descriptions	35	Using the Parental Control Menu	43
Using the Remote Control to Navigate the On-Screen Analog Menus	37	Using the Timer Menu	49
Using the Video Menu	38	Using the Setup Menu	50
Using the Audio Menu	39	Using the Digital Features Menu	51
Using the Channel Setup Menu	41		

Menu Descriptions

Analog Menu



Description

Video Menu

Adjust your picture settings.

For details, see page 38.



Audio Menu

Change your audio settings.

For details, see page 39.



Channel Setup Menu

(Analog channels only): Customize your channel settings.

For details, see page 41.

Analog Menu



Description

Parental Control Menu

Set rating limits on your TV based on program rating or content.

For details, see page 43.



Timer Menu

Set the clock on your TV and program scheduled viewing using Timer 1 and Timer 2 (*timers work with analog channels only*).

For details, see page 49.



Setup Menu

(*Analog channels only*): Select analog closed captioning options (Caption Vision), display the name of the current program and its remaining time (Info Banner), label video inputs, select menu language, , enhance DVD picture resolution (16:9 Enhanced), and adjust tilt correction.

For details, see page 50.



Digital Features Menu

Access Digital Menu options and select analog or digital tuning modes.

For details, see page 51.

Using the Remote Control to Navigate the On-Screen Analog Menus

To navigate the on-screen analog menus, use the arrow buttons (↑, ↓, ←, →) to move the cursor. Pressing these arrows moves the cursor in the corresponding direction. Press the center button (◁) to select an option.

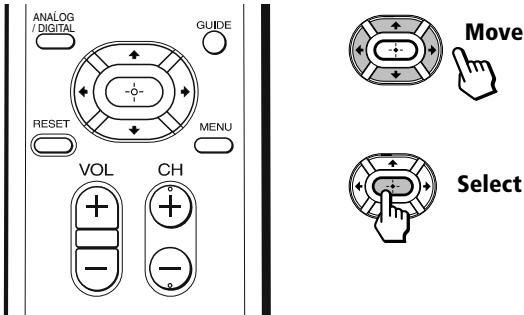

Displaying Analog Menus

To display analog menu

- 1** Press to display the on-screen analog menu.
- 2** Use the ← or → buttons to highlight the desired menu icon. Press to select it.
- 3** Use the ↑ or ↓ buttons to scroll up and down through the features.
- 4** Follow the instructions on the screen.
- 5** Press to exit the menu.

Press once to display the on-screen menu, and press again to return to normal viewing. If no buttons are pressed, the menu closes automatically after about 90 seconds.

To exit the analog menu

- Press (or).

To display the digital menu

- See “Displaying Digital Menus” on page 54.

Using the Video Menu

To access the Video menu, use the following steps:



To Display

MENU



To Select





Press  to highlight an option, then press .



Mode

Customized picture viewing

Use the  or  buttons to highlight one of the following options, then press  to select it.

Vivid: Select for enhanced picture contrast and sharpness.

Standard: Select for a standard picture.

Movie: Select for a finely detailed picture.

Pro: Select for natural picture and sharpness.



Press





on the remote control to directly select picture modes (Vivid, Standard, Movie, Pro).

Picture

Press  to decrease the contrast. Press  to increase the contrast.



Brightness

Press  to darken the picture. Press  to brighten the picture.

Color

Press  to decrease color saturation. Press  to increase color saturation.

Hue



Press  to increase the red tones. Press  to increase the green tones.

Sharpness

Press  to soften the picture. Press  to sharpen the picture.

Color Temp.

White tint adjustment



Use the  or  buttons to highlight one of the following options, then press  to select it.

Warm: Gives white colors a red tint.

Neutral: Gives white colors a neutral tint.

Cool: Gives white colors a blue tint.



ClearEdge VM

Sharpens picture definition to give objects a crisp, clean edge. Use the  or  buttons to highlight: **High**, **Low**, or **Off**, then press  to select it.

Using the Audio Menu

To access the Audio menu, use the following steps:









Press  to highlight an option, then press .



Treble Press  to decrease the higher pitched sounds. Press  to increase the higher pitched sounds.



Bass Press  to decrease the lower pitched sounds. Press  to increase the lower pitched sounds.

Balance Press  to emphasize the left speaker. Press  to emphasize the right speaker.

Steady Sound Use the  or  buttons to highlight one of the following options, then
Stabilizes volume press  to select it.
On: Select to stabilize the volume when changing channels.
Off: Select to turn Steady Sound off.

Effect Use the  or  buttons to highlight one of the following options, then
press  to select it.
SRS: Produces a dynamic three-dimensional sound for stereo programs.
Off: Normal stereo or mono reception.
Simulated: Simulates theater-quality sound for mono programs.

 Press  to directly select Effect settings (Simulated, SRS, Off).

MTS *(Disabled for digital channels.)*
Multi-Channel TV Sound Use the  or  buttons to highlight one of the following options, then press
 to select it.
Stereo: Select when viewing a broadcast in stereo.
Mono: Select to reduce noise in areas of poor reception.
Auto SAP: Select to have the TV automatically switch to a Second Audio Program (SAP) when a signal is received.

 If your TV is set to Auto SAP, some programs may be muted or distorted. If your TV does not output sound, change your Audio MTS setting to Stereo or Mono.

Speaker

*Custom selection
of audio output
source*

Use the  or  buttons to highlight one of the following options, then press  to select it.

On: Select to listen to the sound from the TV speakers with or without a separate stereo system.

Off: Select to turn off the TV speakers and listen to the TV's sound only through external audio system speakers.

Audio Out

*Use to control
the TV's volume
through a stereo*

Use the  or  buttons to highlight one of the following options, then press  to select it.

Variable: Adjust the volume through your TV.

Fixed: Adjust the volume through a connected stereo.

 You can only set Audio Out settings when you have set Speaker to Off.

Using the Channel Setup Menu

To access the Channel Setup menu, use the following steps:

To Display



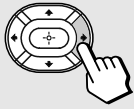

To Highlight



To Select



Press  to highlight an option, then press .











Favorite Channels





Quick access to analog favorite channels

Applies to analog channels only. To set up favorite digital channels, see page 55.

To set up your analog Favorite Channels list:

- 1 Use the  or  buttons to highlight the position (1-5) where you want to set a favorite channel, then press .
- 2 Use the  or  buttons to find the channel you want to add to your favorite channels.
- 3 Press  to select the channel. The TV will automatically change to the selected channel and assign it to the selected position (1-5).
- 4 Press  to return to the Channel Setup menu or press  to exit.

To use your analog Favorite Channels list:

- 1 Press the  button while in analog tuning mode.
- 2 Press  or  to move the cursor to the desired channel number and press .

Cable



Use the  or  buttons to highlight one of the following options, then press  to select it.

- On:** Select if you are receiving cable channels with a CATV cable.
Off: Select if you are using a TV antenna.

 After changing the Cable setting the first time, you will need to run Auto Program. For analog channels, see page 42. For digital channels, see page 55.

Channel Fix

Not available when in digital tuning mode.

Use the  or  buttons to highlight one of the following options, then press  to select it.

- Off:** Channel Fix is not set.
2-6: “Fix” your TV’s channel setting to 2–6 (VHF/UHF input) and use the cable box or satellite receiver to change channels.
Video 1: Select from available video inputs when you have connected video equipment (e.g., a satellite receiver) and you want your TV fixed to it.

 You cannot use Favorite Channels, Cable, Channel Show/Hide, or Channel Label when Channel Fix is set.

Auto Program *Applies to analog channels only. To Auto Program digital channels, see page 55.*

Perform Auto Program whenever setting up your TV. Auto Program will search for available channels and program receivable channels.

Channel Show/Hide *Applies to analog channels only. To Show/Hide digital channels, see page 56.*

Use this feature after you run Auto Program to selectively show or hide channels.

- 1 Use the \uparrow or \downarrow buttons to highlight the position of the desired channel, then press \rightarrow .
- 2 Use the \uparrow or \downarrow buttons to highlight **Shown** or **Hidden**, then press \rightarrow .
- 3 Press \leftarrow to return to the Channel Setup menu or press EXIT to exit.

 Press **CH +** or **CH -** to skip over channels that have been hidden. You can still use the 0-9 buttons to directly tune to hidden channels.

Channel Label *Applies to analog channels only. To label digital channels, see page 56.*

Label up to 40 channels with their call letters

- 1 Press \rightarrow , then use the \uparrow or \downarrow buttons until you reach the desired channel number.
- 2 Press \rightarrow to activate the channel.
- 3 Press \downarrow to highlight **Label**, then press \rightarrow . Use the \uparrow or \downarrow buttons to display the first call letter or number of the label. Press \rightarrow to select. Repeat this process until you finish selecting all the call letters.
- 4 When finished, press \rightarrow to activate.
- 5 Press \leftarrow to return to the Channel Setup menu or press EXIT to exit.

Using the Parental Control Menu

To access the Parental Control menu, use the following steps:

To Display



To Highlight 

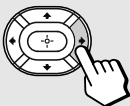

To Select



The Parental Control feature helps parents monitor what their children watch on television.

 Parental Control settings control analog and digital programs.

To use the Parental Control Menu

When you select the Parental Control menu, you are prompted to set a 4-digit password. You cannot access the Parent menu settings without this password.

- 1** Use the **0**-**9** buttons to enter a 4-digit password.
- 2** Confirm your password by entering it again.

 Keep this manual in a safe place. You need your password for any future access to the Parental Control menu. If you forget your password, see page 59.

Parental Control

Setting the Rating

You can change the Rating by selecting one of the Parental Lock options.



1 With **Lock** highlighted, press **+**.

If you are not familiar with Parental Guideline rating system, use one of the following preset categories to simplify the rating selection: Child, Youth, Young Adult.

2 Use the **↑** or **↓** to highlight the desired rating and press **+**.

Rating	TV will allow a maximum rating of
Off	No rating limit
Child	TV-Y, TV-G, G (U.S.), G, C (Canada)
Youth	TV-PG, PG (U.S.), 8 ans + (Canada)
Young Adult	TV-14, PG-13 (U.S.), 14+ (Canada)
Custom	Select to set more restrictive ratings (see next section)

Changing your Password

1 Use the **↑** or **↓** buttons to highlight **Change Password** and press **+**.

2 Follow steps 1 and 2 for “Using the Parental Control Menu” on page 43.

Select a Country



Select U.S.A. to use US ratings (see pages 46-47) or select Canada to use Canadian ratings (see page 48). If you select a Country (U.S. or Canada) that is not where you live, the rating you select will not be activated.

1 Press **↓** to highlight **Country**, then press **+**.

2 Use the **↑** or **↓** to highlight the desired country and press **+**.

Information for Parents

To view a program that exceeds the TV rating

- Press , then use the - buttons to enter your password.

 Entering your password to view a blocked program will temporarily turn **Lock** to Off. To reactivate your Lock settings, turn the TV off then back on; the TV will return to the settings that you have selected.

Using the Custom Menu

Follow the instructions on the screen to make your custom settings. Select the country desired for your TV's rating limit. For more information see page 46 for (U.S. models) and page 48 for (Canadian models).

 Once you have blocked a rating or content, all higher ratings or content will be automatically blocked.

United States: Selecting Custom Rating Options

For the United States, the Custom Rating menu includes the following options: Movie Rating, TV Rating, and Unrated. (For Canada, see page 48.)

Movie Rating

This system defines the rating levels of movies shown in theaters and on prime cable channels.

Rating	Defined as
G	General audience
PG	Parental guidance suggested
PG-13	Parents strongly cautioned
R	Restricted
NC-17	No one 17 and under admitted
X	Adult audience only

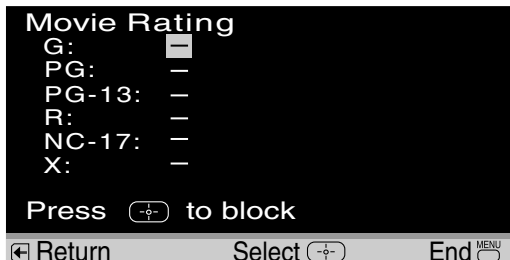

TV Rating

The TV rating is divided into two groups: age-based and content-based.

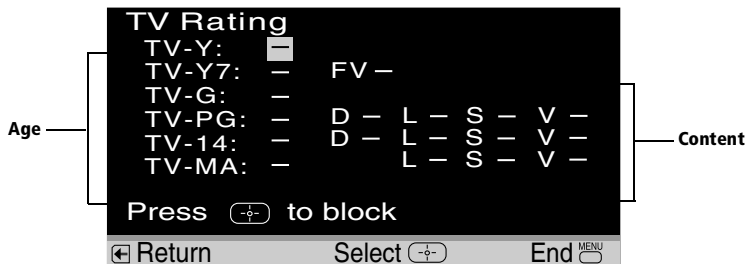

Age	Defined as
TV-Y	All children
TV-Y7	Directed to older children
TV-G	General audience
TV-PG	Parental guidance suggested
TV-14	Parents strongly cautioned
TV-MA	Mature audience only

Content	Defined as
FV	Fantasy violence
D	Suggestive dialogue
L	Strong language
S	Sexual situations
V	Violence

 The content ratings will increase depending on the level of the age-based rating. For example, a program with a TV-PG V (Violence) rating may contain moderate violence, while a TV-14 V (Violence) rating may contain intense violence.

Unrated

You have the option of blocking TV programs or movies that are not rated.

Allow	Allows all unrated programs
Block	Blocks all unrated programs



 If you choose to block unrated TV programs, please be aware that the following programs may be blocked: emergency broadcasts, political programs, pro, news, public service announcements, religious programs, and weather.

Canada: Selecting Custom Rating Options

For Canada, the Custom Rating menu includes the following options: English Rating, French Rating, and U.S.A. Rating.

English Rating

These ratings are for Canadian programs that are broadcast in English.

Rating	Defined as
C	Children
C8+	Children 8 years and older
G	General programming
PG	Parental guidance
14+	Viewers 14 and older
18+	Adult programming

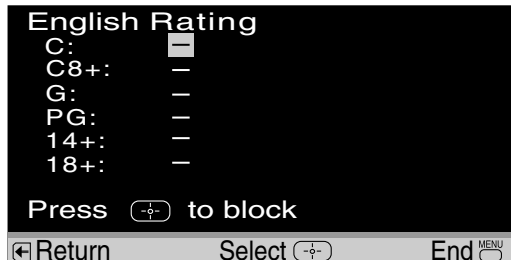

French Rating

These ratings are for Canadian programs that are broadcast in French.

Rating	Defined as
G	General
8 ans+	Not recommended for younger children
13 ans+	Not recommended for children under age 13
16 ans+	Not recommended for ages under 16
18 ans+	This program is restricted to adults

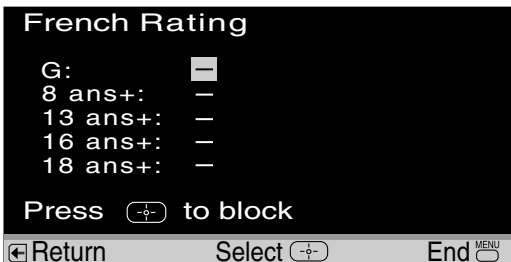

U.S.A. Rating

For programs from the United States, see “TV Rating” on page 46.

Using the Timer 🕒 Menu

To access the Timer menu, use the following steps:

To Display



To Highlight 🕒

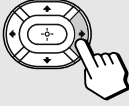

To Select



Timer 1
Timer 2
Scheduled
viewing

Timer functions apply to analog channels only. You cannot set the Timer for digital channels.

Use the timers to program your TV to turn on and off by day, time, duration, and channel. The timer duration is a maximum of six hours. When the channel is fixed, it is not necessary to set the channel.

- 1 Use the \uparrow or \downarrow buttons to highlight **Timer 1** or **Timer 2**, then press \ominus .
- 2 Use the \uparrow or \downarrow buttons to enter the desired day, start time, duration, and channel, then press \ominus . The timer status should be On when the Timer has been set, and the timer light on the front panel of the TV should be on.
- 3 Press EXIT to exit the menu.

Select Off to turn off the Timer. Your previous settings will be saved.

Current Time Set your TV to the current day and time. Press \ominus to open the Current Time menu:

- 1 Use the \uparrow or \downarrow buttons to enter the correct day and time, then press \ominus .
- 2 Press EXIT to exit the menu.

You must set the Current Time before you can use Timer 1 or Timer 2.

When you perform Auto Program, Timer 1 and Timer 2 settings will be cleared. Also, in the event of any loss of power, Current Time, Timer 1, and Timer 2 settings will be cleared.

Using the Setup Menu

To access the Setup menu, use the following steps:

To Display



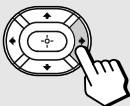

To Highlight 



To Select



Press  to highlight an option, then press .





Caption Vision

Closed-Captioning

Applies to analog channels only. To set closed-caption options for digital channels, see page 57.

Allows you to select from three closed-caption modes for programs that are broadcast with closed captioning.

Use the  or  buttons to highlight one of the following options, then press  to select it.

Off: Caption Vision is not activated.

CC1, 2, 3, 4: Displays printed dialog and sound effects of a program.

Text1, 2, 3, 4: Displays network/station information.



Info Banner



Displays the name of the current program and its remaining time (if available) when you change the channel or press the **DISPLAY** button. Use the  or  buttons to highlight **On** or **Off**. Then press .

Video Label

Label connected equipment

Allows you to identify the video components connected to the TV: VCR, DVD, etc. When you press  to switch inputs, the Video Label appears on-screen.

1 Press the  or  buttons to highlight the input you want to label and press .



2 Press the  or  buttons to highlight a label and press .

3 Press  to return to the Setup menu or press  to exit.

 **If you select Skip, your TV skips this input when you press the TV/VIDEO button.**

Language



Display all menus in the language of your choice.

Use the  or  buttons to select from one of the following options: **English**, **Español** (Spanish) and **Français** (French). Then press .

16:9 Enhanced

Available only when the TV is displaying an external input, such as a DVD player.
Provides enhanced picture resolution for wide-screen sources such as DVD.

Tilt Correction

Use the  or  buttons to set the tilt of the picture from -5 to +5, then press  to activate.

Using the Digital Features Menu

To access the Digital Features menu, use the following steps:

To Display



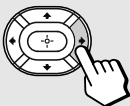

To Highlight 



To Select



Press  to highlight an option, then press .





Digital Menu Provides access to the Digital Channels and Digital Setup options. For details, see “Using the Digital Menus” on page 53.

Channel Mode Enables you to switch between analog and digital tuning modes.

Analog Selects analog tuning mode.

Digital Selects digital tuning mode.

 Press the  button on the remote control to directly switch to analog or digital Channel Mode.

Using the Digital Menus

Overview

This chapter describes how to use the digital menu features of your TV.

Topic	Page
Menu Descriptions	53
Using the Remote Control to Navigate the On-Screen Digital Menus	54
Displaying Digital Menus	54
Using the Digital Channels Menu	55
Using the Digital Setup Menu	57

Menu Descriptions

Digital Menu

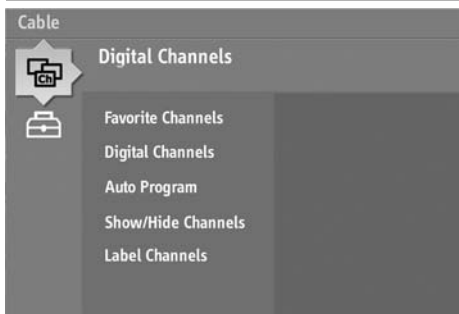

Description

Digital Channels Menu

Select favorite digital channels; add, show, hide, and label digital channels.

For details, see page 55.

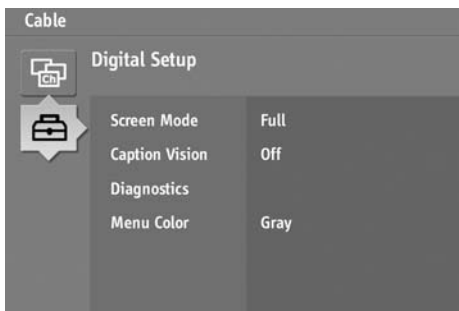

Digital Setup Menu

Provides settings for selecting various screen modes and for Caption Vision. Also includes diagnostics information and allows you to change the colors of the digital menus.

For details, see page 57.

Using the Remote Control to Navigate the On-Screen Digital Menus

To navigate the on-screen digital menus, use the arrow buttons (↑, ↓, ←, →) to move the cursor. Pressing these arrows moves the cursor in the corresponding direction. Press the center button (⏏) to select an option.

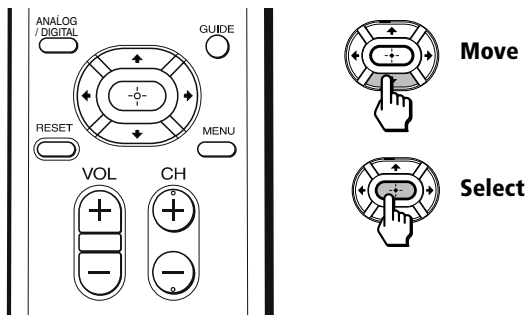

Displaying Digital Menus

To display the digital menus

- 1 Press **MENU** to display the analog menu.
- 2 Press → to highlight the Digital Features menu icon **DTV** and then press **⏏**. (For details, see “Using the Digital Features Menu” on page 51.)
- 3 Press ↓ to highlight **Digital Menu** and then press **⏏**.

 If the TV is in analog tuning mode, it will switch to digital tuning mode when displaying the digital menus.

To exit the digital menus

- ❑ Press **EXIT**.

To display the analog menu directly from within any digital menu

- ❑ Press **MENU**.

Using the Digital Channels Menu

To use the Digital Channels menu, use the following steps:

To Display



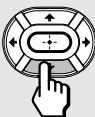

To Highlight 



To Select





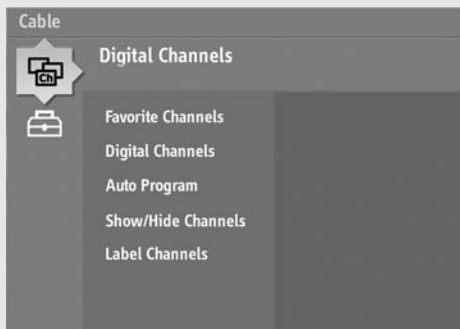





Press  to highlight an option, then press .



Favorite Channels

Applies to digital channels only. To set up analog channels, see page 41.

To set up digital channels in a Favorite Channels list:

- 1 Use the , , and  buttons to enter the channel number that you want to assign to the Favorite Channel number. Press  to select that channel as a Favorite Channel.
- 2 To add more channels to your favorites list, repeat step 1.
- 3 To clear a Favorite Channel, press  or  to highlight the channel you want to clear. Press  and then press .

To use the digital Favorite Channels list, see page 33.

 You can also add Favorite Channels directly to the Favorite Channels list, as described on page 33.

Digital Channels

Applies to digital channels only.

Add Select to add digital channels.

Auto Program

Applies to digital channels only. To Auto Program analog channels, see page 42.

Automatically sets up the channel list on the TV for all receivable channels.

 Auto Program may take 50 minutes or more to complete. A progress bar will display the approximate progress of the Auto Program and Digital Channels/Add sequences.

Show/Hide Channels

Applies to digital channels only. To Show/Hide analog channels, see page 42.

Allows you to show or hide channels that appear when you use the **CH+/-** buttons to channel surf. Channels that are set to **Hidden** do not appear on the Program Guide's channel list, and are skipped when you use the **CH+/-** buttons.

- 1 Press \uparrow or \downarrow to highlight the channel that you want to show or hide. To move between the Major and Digital subchannel lists, press \leftarrow or \rightarrow .
- 2 To change a channel's setting to **Shown** or **Hidden**, press \ominus .
- 3 To show or hide more channels, repeat steps 1 and 2.

 Channels that you set to **Hidden** can be accessed only with the $\textcircled{0}$ - $\textcircled{9}$ buttons.

Label Channels

Applies to digital channels only. To label analog channels, see page 42.

Allows you to assign labels (such as station call letters) to channel numbers.

- 1 Press \uparrow or \downarrow to scroll through the channel numbers. Then press \ominus to select the channel number that you want to assign a label.
 - 2 Press \uparrow or \downarrow to scroll through the label characters (A-Z, 0-9, etc.). Then press \ominus to select the highlighted character.
 - 3 Repeat to add characters to the label.
 - 4 To assign labels to more channels, repeat steps 1-2.
 - 5 Press \leftarrow to return to the Channel Setup menu, or press $\textcircled{\text{EXIT}}$ to exit the menus.
-

Using the Digital Setup Menu

To use the Digital Setup menu, use the following steps:

To Display



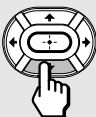

To Highlight 



To Select



Press  to highlight an option, then press .

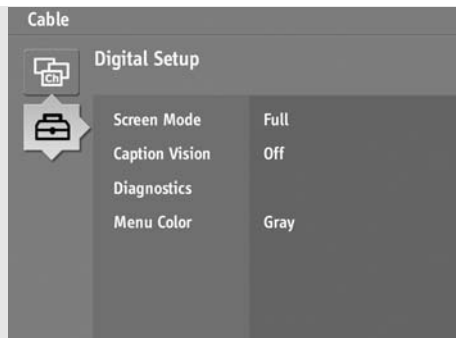

Screen Mode *Applies only to digital channels that have 16:9 or widescreen aspect ratio. You cannot use Screen Mode for analog channels.*

Enables you to change the picture size for digital channels.

Select from: **Full, Zoom, Horizontal Expand, Vertical Expand**. For details, see “Using the Screen Mode Feature” on page 32.

 In some cases, wide-screen programs will be shown in aspect ratios that require the display of bars at the top and bottom of your 16:9 screen. For more details, see page 61.

Caption Vision *Applies to digital channels only. To set closed-caption options for analog channels, see page 50.*

Allows you to select from several closed caption modes (for programs that are broadcast with closed captioning).

On Caption Vision is turned on.

Off Caption Vision is turned off.

Program Allows you to set additional Caption Vision options. See “Programming Caption Vision” on page 58.

Diagnostics Displays information about the currently tuned channel. For terrestrial digital signals, displays the strength of the signal to help you adjust your antenna to optimize signal reception.

Menu Color *Applies to digital menus only. You cannot set colors for analog menus.*

Enables you to select a specific color for the on-screen menus.

Programming Caption Vision

Applies to digital channels only. To set closed-caption options for analog channels, see page 50.

If you selected the Program option under Caption Vision (page 57), you can change the following settings:



Basic	Allows you to select basic closed caption options (EIA-608).		
	CC1, CC2, CC3, CC4	Displays a printed version of the dialog or sound effects of a program. (Should be set to CC1 for most programs.)	
	Text1,Text2, Text3,Text4	Displays network/station information presented using either half or the whole screen (if available). For closed captioning, set to CC1.	
Advanced	Allows you to select advanced digital (EIA-708) closed caption options. Select from the available options.		
Digital CC	Allows you to set digital closed captioning to Basic (digital EIA-608) or Advanced (digital EIA-708).		
Advanced Settings	Allows you to make additional settings for digital (EIA-708) closed caption options.		
	As Broadcast		
	Small Text		
	Large Text		
	Custom ...	Allows you to customize the following settings:	
	Character Size	Small, Standard, Large	
	Character Style	Style 1-7	
	Character Color	Color 1-8	
	Character Opacity	Solid, Translucent	
	Edge Color	Color 1-8	
	Edge Type	None, Raised, Depressed, Outline, Left shadow, Right shadow	
Background Color	None, Color 1-8		
Background Opacity	Solid, Translucent		
Window Color	None, Color 1-8		
Window Opacity	Solid, Translucent		

Other Information

Troubleshooting

If you have a problem with your TV, try the suggestions below. If the problem persists, see “Contacting Sony” at the end of this section.

General

Problem	Possible Remedies
I want to reset the TV to the factory settings	<input type="checkbox"/> Turn on the TV. While holding down the  button on the remote control, press the POWER button on the TV front panel. The TV will turn itself off, then back on again. Release the  button.
The TV is dirty	<input type="checkbox"/> Clean the TV with a soft dry cloth. Never use strong solvents such as thinner or benzene, which might damage the finish of the cabinet.
I lost the parental control password	<input type="checkbox"/> In the password screen, enter the following master password: 4357 . After using the master password, you must create a new password. You cannot use the master to unlock currently blocked channels.
There is a black box on the screen	<input type="checkbox"/> You have selected a text option in the Setup menu (page 50) and no text is available. To turn off this feature, select Off in the Caption Vision option. If you were trying to select closed captioning, select CC1-4 instead of Text1-4.
There was a blackout or power outage, and now the TV won't turn on and the timer LED is flashing	<input type="checkbox"/> Press the POWER button on your remote control or on the TV front panel. If the problem persists, see “Contacting Sony” on page 62.
The digital cable box does not work	<input type="checkbox"/> If you are connecting a VCR and digital cable box using a splitter, as described on page 19, you must use a special bi-directional splitter (5-900 Mhz minimum) that is designed to work with your digital cable box.
I can't connect the DVD player using component video outputs (Y P_B P_R)	<input type="checkbox"/> You must set up your DVD player before you can connect it using component video outputs (Y P _B P _R). Disconnect the DVD player and set it up, referring to the DVD manual for instructions. Then, connect it to the TV again following the instructions on page 24.

Remote Control

Problem	Possible Remedies
I cannot operate the remote control	<ul style="list-style-type: none"><input type="checkbox"/> Press TV (FUNCTION) when operating your TV.<input type="checkbox"/> Check the orientation of the batteries.<input type="checkbox"/> Batteries could be weak. Replace them (page 8).<input type="checkbox"/> Move the TV three to four feet away from fluorescent lights.
I cannot change channels with the remote control	<ul style="list-style-type: none"><input type="checkbox"/> Make sure you have not inadvertently switched your TV from the channel 3 or 4 setting if you are using another device to change channels.<input type="checkbox"/> If you are using another device to control channels, be sure that you have pressed the FUNCTION button for that device. For example, if you are using your VCR to control channels, be sure to press the  FUNCTION button.
I lost the remote control	<ul style="list-style-type: none"><input type="checkbox"/> You can use the front panel controls to access your menus, change channels, adjust the volume, or change video inputs (page 8). Contact your nearest Sony Dealer to order a replacement. To find out the nearest dealer, please call our Sony Direct Accessory and Part Center at 1-800-488-7669 (U.S. residents only).

Programming The Remote Control

Problem	Possible Remedies
More than one code is listed	<ul style="list-style-type: none"><input type="checkbox"/> Try entering them one by one until you come to the correct code for your component.
I entered the wrong code number	<ul style="list-style-type: none"><input type="checkbox"/> If you enter a new code number, the code number you previously entered at that setting is erased. To reenter the correct code number you must reprogram the remote control.
I cannot operate a component with the remote control	<ul style="list-style-type: none"><input type="checkbox"/> Use the component's own remote control.
When I changed the batteries, the code numbers changed back to the factory settings	<ul style="list-style-type: none"><input type="checkbox"/> Reprogram the remote control.

Video

Problem	Possible Remedies
No picture, no sound	<ul style="list-style-type: none"> <input type="checkbox"/> Make sure the power cord is plugged in. <input type="checkbox"/> If a red light flashes on the front of your TV for more than a few minutes, disconnect and reconnect the power cord. If the problem continues, call your local service center. <input type="checkbox"/> Check the TV/VIDEO setting. When watching TV, set it to TV; when watching video equipment, set it to VIDEO 1, 2, 3 or 4. <input type="checkbox"/> Make sure you have inserted the batteries correctly into the remote control (page 8). <input type="checkbox"/> Try another channel to rule out station trouble.
Poor or no picture, good sound	<ul style="list-style-type: none"> <input type="checkbox"/> Adjust the Picture setting in the Video menu (page 38). <input type="checkbox"/> Adjust the Brightness setting in the Video menu (page 38). <input type="checkbox"/> Check the antenna and/or cable connections (page 16).
No color	<ul style="list-style-type: none"> <input type="checkbox"/> Adjust the Color setting in the Video menu (page 38).
Snow on the screen	<ul style="list-style-type: none"> <input type="checkbox"/> Check the Cable setting in the Channel Setup menu (page 41). <input type="checkbox"/> Check the antenna and/or cable connections (page 16). <input type="checkbox"/> Make sure the channel selected is currently broadcasting.
Dotted lines or stripes	<ul style="list-style-type: none"> <input type="checkbox"/> Adjust the antenna. <input type="checkbox"/> Move the TV away from other electronic equipment. Some electronic equipment creates electrical noise, which can interfere with TV reception.
Double images or ghosts	<ul style="list-style-type: none"> <input type="checkbox"/> Check your outdoor antenna or call your cable service.
Bars appear at the top and bottom of the screen	<ul style="list-style-type: none"> <input type="checkbox"/> Some wide-screen programs are filmed in aspect ratios that are greater than 16:9, such as 2.35:1. (This is especially common with theatrical releases). Your TV will show these programs with bars at the top and bottom of the screen. For more details, check the documentation that came with your DVD (or contact your program provider).
Cannot cycle through the other video equipment connected to the TV	<ul style="list-style-type: none"> <input type="checkbox"/> Be sure the Video Label option is not set to Skip (see page 50).
Screen Mode feature does not function	<ul style="list-style-type: none"> <input type="checkbox"/> Screen Mode is available only for digital 16:9 programming in digital tuning mode. See page 32 for details.

Audio

Problem	Possible Remedies
Good picture, no sound	<ul style="list-style-type: none">❑ Press  so that Muting disappears from the screen. Check your Audio settings. Your TV may be set to Auto SAP in the MTS feature (page 39).❑ Make sure the Speaker option is set to On in the Audio menu.❑ Press VOL+ to adjust your TV's volume.
Low or no audio (TV and cable box)	<ul style="list-style-type: none">❑ Some cable boxes have volume level controls. Check and see if your cable box remote has a volume control.

Channels

Problem	Possible Remedies
I cannot receive higher number channels (UHF) when using an antenna	<ul style="list-style-type: none">❑ Make sure Cable is set to Off in the Channel Setup menu (page 41).❑ Perform Auto Program to add channels that are not presently in memory (page 27).
Cable stations don't seem to work	<ul style="list-style-type: none">❑ Make sure Cable is set to On in the Channel Setup menu (page 41).❑ Perform Auto Program to add channels that are not presently in memory (page 27).
I have no digital channels	<ul style="list-style-type: none">❑ You may not have any digital channels available. Try running the Auto Program feature to search for digital channels (see page 55). If there are none available, press the  button to switch to analog mode.

Contacting Sony

Before calling our Customer Information Services Center, reset the TV to factory settings (see page 27). Please have your TV serial number ready. The number is located on the rear of your TV and on the front cover of this manual.

Our Customer Information Services Center phone number is 1-800-222-SONY (7669) (US residents only) or 1-877-899-SONY (7669) (Canadian residents only).

Specifications

For all models (except as noted)

Television system	NTSC	American TV Standard
	ATSC (8VSB terrestrial)	ATSC compliant 8VSB
	QAM on cable	ANSI/SCTE 07 2000 <i>(Does not include CableCARD functionality.)</i>
Channel coverage	Terrestrial (analog)	2-69
	Cable TV (analog)	1-125
	Terrestrial (digital)	2-69
	Cable TV (digital)	1-135
Antenna	75-ohm external antenna terminal for VHF/UHF	
Picture tube	FD Trinitron® tube	
Power requirements	120V, 60 Hz	
Supplied accessories	Size AA (R6) batteries (2) Remote Control RM-YD001 (1)	
Inputs/outputs	Inputs	Outputs
	1 video, 1 audio (front) 2 video, 2 audio (rear) 1 S VIDEO 1 RF 2 Y PB PR, 2 audio	1 AUDIO OUT
Optional accessories	TV Stand: SU-32FS2 for KD-32FS130, SU-36FS2 for KD-36FS130	

KD-32FS130

Screen size	Visible screen size: 803 mm (32 inches) measured diagonally
	Actual screen size: 863.6 mm (34 inches) measured diagonally
Speaker output	10 W x 2
Power consumption	185 W
	Less than 1 W in standby
Dimensions (W/H/D)	898 x 696 x 576 mm (35 ³ / ₈ x 27 ³ / ₈ x 22 ⁵ / ₈ inches)
Mass	74 kg (163.2 lbs)

KD-36FS130

Screen size	Visible screen size: 911 mm (36 inches) measured diagonally
	Actual screen size: 965.2 mm (38 inches) measured diagonally
Speaker output	10 W x 2
Power consumption	185 W
	Less than 1 W in standby
Dimensions (W/H/D)	985 x 776 x 633 mm (38 ³ / ₄ x 30 ¹ / ₂ x 24 ⁷ / ₈ inches)
Mass	103.2 kg (227.5 lbs)

Design and specifications are subject to change without notice.

Index

0-9 buttons **29**
16:9 Enhanced **50**

A

add digital channels **55**
Alternate Audio **31**
Alternate Video **31**
Audio Out **40**
Auto Program **27, 42, 55**
Auto SAP **39**

B

Balance **39**
Bass **39**
Batteries, inserting in remote **8**
Brightness **38**

C

Cable, setting **41**
Caption Vision **50, 57, 58**
Channel Fix **41**
Channel Label **42**
Channel Mode, switching **51**
Channel Show/Hide **42**
ClearEdge VM **38**
closed caption modes (see Caption Vision)
Color Temperature **38**
Color, setting **38**
colors, menus **57**
Connections
 Cable and antenna **16**
 Cable Box and Cable **19**
 Connecting a Camcorder **25**
 Connecting an Audio System **25**
 DVD Player using Component Video **24**
 DVD Player using Composite Video **24**
 TV and Cable Box **18**
 TV and Satellite Receiver **21**
 TV and VCR **17**
 TV, VCR and Cable Box **19**
 TV, VCR, and Satellite Receiver using
 Component Video **23**
 TV, VCR, Cable/Antenna, and Satellite
 Receiver using Composite Video **22**
Current Time **49**

D

Diagnostics **57**
Digital Features Menu **51**
Digital Menu **51**
Digital Menus, exiting **54**

Digital Menus, navigating **54**
Digital Setup Menu **57**

F

Favorite Channels **33, 41**
Features **7**
Front Panel **8**

G

GUIDE button **30**

H

Horizontal Expand (Screen Mode) **32**

I

Info Banner **50**

L

Label Analog Channels **41, 42**
Label Channels **56**
Label Digital Channels **56**
Language **50**

M

Manufacturer's Codes **12**
Menu Color **57**
Menus
 Audio **39**
 Channel **41**
 Digital Channels **55**
 Digital Features **51**
 Digital Setup **57**
 Parent **43**
 Setup **50**
 Timer **49**
 Video **38**
Mode
 Movie **38**
 Pro **38**
 Standard **38**
 Vivid **38**
MTS **39**
 Auto SAP **39**
 Mono **39**
 Stereo **39**

P

Parental Control **44**
Picture **38**
Program Guide **30**
Programming the Remote Control **60**

R

- Rear Panel **15**
- Remote Control
 - described **9–10**
 - Inserting batteries **8**
 - Programming **11**
 - Troubleshooting **60**

S

- Screen Mode **32, 57, 61**
- Setting the Rating
 - English Rating **48**
 - French Rating **48**
 - Movie Rating **46**
 - TV Rating **46**
 - U.S.A. Rating **48**
 - Unrated **47**
- Sharpness **38**
- Show/Hide Channels **56**
- signal strength, adjusting **57**
- Skip **61**
- SLEEP **9**
- Speaker **40**
- Specifications **63**
- SRS **39**
- Steady Sound **39**

T

- Tilt Correction **50**
- Timer 1 and Timer 2 **49**
- Treble **39**
- Troubleshooting **59**

V

- Vertical Expand (Screen Mode) **32**
- Video Label **50, 61**

Sony Corporation

<http://www.sony.net>

Printed in U.S.A.