

**SONY®**

2-108-205-11(1)

# ***DVD/VCR Receiver Home Theater System***

---

Operating Instructions



***HT-V700DP***

©2004 Sony Corporation

## Safety Precautions

### Warning

To prevent fire or shock hazard, do not expose the unit to rain or moisture.

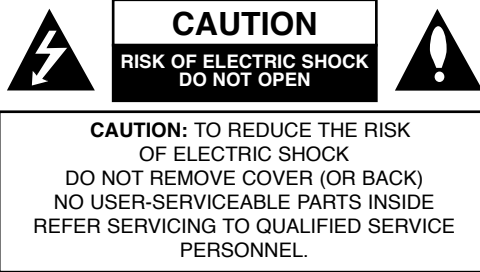

This lightning flash with arrowhead symbol within an equilateral triangle is intended to alert the user to the presence of uninsulated dangerous voltage within the product's enclosure that may be of sufficient magnitude to constitute a risk of electric shock to persons.



The exclamation point within an equilateral triangle is intended to alert the user to the presence of important operating and maintenance (servicing) instructions in the literature accompanying the product.

**WARNING:** TO REDUCE THE RISK OF FIRE OR ELECTRIC SHOCK, DO NOT EXPOSE THIS APPARATUS TO RAIN OR MOISTURE.

**CAUTION:** TO PREVENT ELECTRIC SHOCK, MATCH WIDE BLADE OF PLUG TO WIDE SLOT, FULLY INSERT.  
**ATTENTION:** POUR ÉVITER LES CHOC ÉLECTRIQUES, INTRODUIRE LA LAME LA PLUS LARGE DE LA FICHE DANS LA BORNE CORRESPONDANTE DE LA PRISE ET POUSSER JUSQU'AU FOND.

**WARNING:** Do not install this equipment in a confined space such as a bookcase or similar unit.

**NOTE TO CABLE/TV INSTALLER:** This reminder is provided to call the cable TV system installer's attention to Article 820-40 of the National Electric Code (U.S.A.). The code provides guidelines for proper grounding and, in particular, specifies that the cable ground shall be connected to the grounding system of the building, as close to the point of the cable entry as practical.

### CAUTION:

The use of optical instruments with this product will increase eye hazard.

### CAUTION:

This DVD/VCR Receiver employs a Laser System.

To ensure proper use of this product, please read this owner's manual carefully and retain for future reference. Should the unit require maintenance, contact an authorized service location.

Use of controls, adjustments, or the performance of procedures other than those specified herein may result in hazardous radiation exposure.

**CAUTION:** The apparatus should not be exposed to water (dripping or splashing) and no objects filled with liquids, such as vases, should be placed on the apparatus.

**FCC WARNING:** This equipment may generate or use radio frequency energy. Changes or modifications to this equipment may cause harmful interference unless the modifications are expressly approved in the instruction manual. The user could lose the authority to operate this equipment if an unauthorized change or modification is made.

### REGULATORY INFORMATION: FCC Part 15

This product has been tested and found to comply with the limits for a Class B digital device, pursuant to Part 15 of the FCC Rules. These limits are designed to provide reasonable protection against harmful interference when the product is operated in a residential installation. This product generates, uses, and can radiate radio frequency energy and, if not installed and used in accordance with the instruction manual, may cause harmful interference to radio communications. However, there is no guarantee that interference will not occur in a particular installation. If this product does cause harmful interference to radio or television reception, which can be determined by turning the product off and on, the user is encouraged to try to correct the interference by one or more of the following measures:

- Reorient or relocate the receiving antenna.
- Increase the separation between the product and receiver.
- Connect the product into an outlet on a circuit different from that to which the receiver is connected.
- Consult the dealer or an experienced radio/TV technician for help.

### Copyrights

This product incorporates copyright protection technology that is protected by U.S. patents and other intellectual property rights. Use of this copyright protection technology must be authorized by Macrovision, and is intended for home and other limited viewing uses only unless otherwise authorized by Macrovision. Reverse engineering or disassembly is prohibited.

**SERIAL NUMBER:** The serial number is found on the back of this unit. This number is unique to this unit and not available to others. You should record requested information here and retain this guide as a permanent record of your purchase.

Model No. \_\_\_\_\_

Serial No. \_\_\_\_\_

# IMPORTANT SAFETY INSTRUCTIONS

**CAUTION: PLEASE READ AND OBSERVE ALL WARNINGS AND INSTRUCTIONS IN THIS OWNER'S MANUAL. AND THOSE MARKED ON THE PRODUCT. RETAIN THIS BOOKLET FOR FUTURE REFERENCE.**

This product has been designed and manufactured to assure personal safety. Improper use can result in electric shock or fire hazard. The safeguards incorporated in this product will protect you if you observe the following procedures for installation, use, and servicing.

This product does not contain any parts that can be repaired by the user.

**DO NOT REMOVE THE CABINET COVER, OR YOU MAY BE EXPOSED TO DANGEROUS VOLTAGE. REFER SERVICING TO QUALIFIED SERVICE PERSONNEL ONLY.**

- 1. Read these instructions.** - All these safety and operating instructions should be read before the product is operated.
- 2. Keep these instructions.** - The safety, operating and use instructions should be retained for future reference.
- 3. Heed all warnings.** - All warnings on the product and in the operating instructions should be adhered to.
- 4. Follow all instructions.** - All operating and use instructions should be followed.
- 5. Do not use this product near water.** - For example: near a bath tub, wash bowl, kitchen sink, laundry tub, in a wet basement; or near a swimming pool; and other areas located near water.
- 6. Clean only with dry cloth.** - Unplug this product from the wall outlet before cleaning. Do not use liquid cleaners.
- 7. Do not block any ventilation openings. Install in accordance with the manufacturer's instructions.** - Slots and openings in the cabinet are provided for ventilation and to ensure reliable operation of the product and to protect it from over-heating. The openings should never be blocked by placing the product on a bed, sofa, rug or other similar surface. This product should not be placed in a built-in installation such as a bookcase or rack unless proper ventilation is provided or the manufacturer's instructions have been adhered to.
- 8. Do not install near any heat sources such as radiators, heat registers, stoves, or other apparatus (including amplifiers) that produce heat.**
- 9. Do not defeat the safety purpose of the polarized or grounding-type plug.** A polarized plug has two blades with one wider than the other. A grounding type plug has two blades and a third grounding prong. The wide blade or the third prong are provided for your safety. If the provided plug does not fit into your outlet, consult an electrician for replacement of the obsolete outlet.
- 10. Protect the power cord from being walked on or pinched particularly at plugs, convenience receptacles, and the point where they exit from the product.**
- 11. Only use attachments/accessories specified by the manufacturer.**
- 12. Use only with the cart, stand, tripod, bracket, or table specified by the manufacturer, or sold with apparatus. When a cart is used, use caution when moving the cart/product combination to avoid injury from tip-over.**
- 13. Unplug this product during lightning storms or when unused for long periods of time.**
- 14. Refer all servicing to qualified service personnel. Servicing is required when the product has been damaged in any way, such as power-supply cord or plug is damaged, liquid has been spilled or objects have fallen into the product, the product has been exposed to rain or moisture, does not operate normally, or has been dropped.**



# Table of Contents

## Introduction

Safety Precautions	2
<b>IMPORTANT SAFETY INSTRUCTIONS</b>	<b>3</b>
<b>Table of Contents</b>	<b>4</b>
<b>Before Use</b>	<b>5-6</b>
Playable Discs	5
Precautions	6
Notes on Discs	6
About Symbols	6
<b>Front Panel</b>	<b>7</b>
<b>Display Window</b>	<b>8</b>
<b>Remote Control</b>	<b>9</b>
<b>Rear Panel</b>	<b>10</b>

## Preparation

<b>Connections</b>	<b>11-14</b>
Connecting Antenna/Cable TV to DVD/VCR Receiver	11
Basic TV Connections	12
Optional TV Connections	12
Speaker System Connections	13
Speaker Positioning	13
Radio Antenna Connections	14
Accessory Audio/Video (A/V) Connections to DVD/VCR Receiver	14
Digital Device Connections	14
<b>Selecting the Output/Input Source</b>	<b>15</b>
<b>Before Operation - Sound Mode Descriptions</b>	<b>16</b>
Mini Glossary for Audio Stream & Surround Mode	16
Sound Mode	16
<b>VIDEO Operation Setup</b>	<b>17-19</b>
On-Screen Display(OSD)	17
On-Screen Menus Setup	17
Using the VIDEO Setup Menu	18
Channel Selection	18
Setting the Clock	19
<b>DVD Operation Setup</b>	<b>20-23</b>
General Explanation	20
On-Screen Display	20
Initial Settings	21-23
• General Operation	21
• Language	21
• Picture	21
• Progressive Scan	21
• Speaker Setup	22
• Others(DRC/PBC)	22
• Parental Control	23



## Operation

<b>VIDEO Operation</b>	<b>24-29</b>
Playback	24
Special Effect Playbacks	24
• Search	24
• Still Picture and Frame-by-Frame Playback	24
• Slow Motion	24
• CM SKIP (Commercial Skip)	24
Normal Recording	25
Timer Recording	25-26
Instant Timer Recording (ITR)	27
Dubbing and Editing	27
Copying from DVD to VIDEO	27
VHS Hi-Fi Stereo System/MTS Broadcast	28
Tape Counter Memory Feature	29
Additional Information	29
<b>DVD and Video CD Operation</b>	<b>30-32</b>
Playing a DVD and Video CD	30
General Features	30-32
• Resuming Playback	30

• Selecting Another TITLE	30
• Selecting Another CHAPTER/TRACK	30
• Search	30
• Still Picture	30
• Slow Motion	31
• Shuffle	31
• Repeat	31
• Repeat A-B	31
• Time Search	31
• 3D Surround	31
• Changing Video Mode	32
Special DVD Features	32
• Checking the contents of DVD Video discs: Menus	32
• Title Menu	32
• DVD Menu	32
• Camera Angle	32
• Changing the Audio Language	32
• Changing the Audio Channel	32
• Subtitle	32
• Screen Saver	32
<b>Audio CD and MP3 Disc Operation</b>	<b>33-34</b>
Playing an Audio CD and MP3 Disc	33
Notes on MP3 Files	33
• Pause	34
• Selecting Another Track	34
• Search	34
• Shuffle	34
• Repeat	34
• Repeat A-B	34
• 3D Surround	34
• Changing the Audio Channel	34
<b>JPEG File Operation</b>	<b>35</b>
Viewing JPEG Files on a Disc	35
• Selecting another Files	35
• Still Picture	35
• To flip the picture	35
• To rotate picture	35
• To record the picture slide show	35
Notes on JPEG Files	35
<b>Programmed Playback</b>	<b>36</b>
Programmed Playback with Audio CD and MP3 Disc	36
Programmed Playback with Video CD	36
• Repeat Programmed Tracks	36
• Erasing a Track from Program List	36
• Erasing the whole Program List	36
<b>Speaker Setup</b>	<b>37</b>
<b>Radio Operation</b>	<b>38-39</b>
Presetting the Radio Stations	38
Listening to the Radio	38
To Clear the Stored Radio Stations	38
Tuning into a Station Automatically	39
Labeling Stations	39
<b>Controlling the TV with the Supplied Remote</b>	<b>40</b>
<b>Reference</b>	
<b>Troubleshooting</b>	<b>41-43</b>
<b>Language Code List</b>	<b>44</b>
<b>Area Code List</b>	<b>45</b>
<b>Specifications</b>	<b>46-47</b>
<b>About the symbols for instructions</b>	
 Indicates hazards likely to cause harm to the unit itself or other material damage.	
<b>Note</b> Indicates special operating features of this unit.	
<b>Tip</b> Indicates tips and hints for making the task easier.	

## Before Use

### Playable Discs

	DVD (8 cm / 12 cm disc)
	Video CD (VCD) (8 cm / 12 cm disc)
	Audio CD (8 cm / 12 cm disc)

In addition, this unit can play a DVD-R/±RW, SVCD and CD-R or CD-RW that contains audio titles, MP3, or JPEG files.

#### Notes

- Depending on the conditions of the recording equipment or the CD-R/RW (or DVD-R/±RW) disc itself, some CD-R/RW (or DVD-R/±RW) discs cannot be played on the unit.
- Do not attach any seal or label to either side (the labeled side or the recorded side) of a disc.
- Do not use irregularly shaped CDs (e.g., heart-shaped or octagonal). It may result in malfunctions.

#### Notes on DVDs and Video CDs

Some playback operations of DVDs and Video CDs may be intentionally fixed by software manufacturers. As this unit plays DVDs and Video CDs according to disc content designed by the software manufacturer, some playback features of the unit may not be available or other functions may be added. Make sure to also refer to the instructions supplied with the DVDs and Video CDs. Some DVDs made for business purposes may not be able to be played on the unit.

#### Regional code of the DVD/VCR Receiver and DVDs

This DVD/VCR Receiver is designed and manufactured for playback of region "1" encoded DVD software. The region code on the labels of some DVDs indicates which type of DVD/VCR Receiver can play those discs. This unit can only play DVDs labelled "1" or "ALL". If you try to play any other discs, the message "Check Regional Code" will appear on the TV screen. Some DVDs that have no region code label may still be subject to area restrictions and therefore not playable.



### Disc-related terms

#### Title (DVD only)

The main film content or accompanying feature content or additional feature content, or music album. Each title is assigned a title reference number enabling you to locate it easily.

#### Chapter (DVD only)

Sections of a picture or a musical piece that are smaller than titles. A title is composed of one or several chapters. Each chapter is assigned a chapter number, enabling you to locate the chapter you want. Depending on the disc, chapters may not be recorded.

#### Track (Video CD and audio CD only)

Sections of a picture or a musical piece on a video CD or an audio CD. Each track is assigned a track number, enabling you to locate the track you want.

#### Scene

On a video CD with PBC (Playback control) functions, moving pictures and still pictures are divided into sections called "Scenes". Each scene is displayed in the menu screen and assigned a scene number, enabling you to locate the scene you want.

A scene is composed of one or several tracks.

### Types of video CDs

There are two types of video CDs:

#### Video CDs equipped with PBC (Version 2.0)

PBC (Playback control) functions allow you to interact with the system via menus, search functions, or other typical computer-like operations. Moreover, still pictures of high resolution can be played if they are included in the disc.

#### Video CDs not equipped with PBC (Version 1.1)

Operated in the same way as audio CDs, these discs allow playback of video pictures as well as sound, but they are not equipped with PBC.

#### IMPORTANT NOTE:

SPENT OR DISCHARGED BATTERIES MUST BE RECYCLED OR DISPOSED OF IN A SAFE MANNER IN COMPLIANCE WITH ALL APPLICABLE LAWS. FOR DETAILED INFORMATION, CONTACT YOUR LOCAL COUNTY SOLID WASTE AUTHORITY.

#### Notes

"Music discs encoded with copyright protection technologies"

This product is designed to playback discs that conform to the Compact Disc (CD) standard. Recently, various music discs encoded with copyright protection technologies are marketed by some record companies. Please be aware that among those discs, there are some that do not conform to the CD standard and may not be playable by this product.

## Before Use (Continued)

### Precautions

#### Handling the unit

##### When shipping the unit

The original shipping carton and packing materials come in handy. For maximum protection, re-pack the unit as it was originally packaged at the factory.

##### When setting up the unit

The picture and sound of a nearby TV, VCR, or radio may be distorted during playback. In this case, position the unit away from the TV, VCR, or radio, or turn off the unit after removing the disc.

##### To keep the surface clean

Do not use volatile liquids, such as insecticide spray, near the unit. Do not leave rubber or plastic products in contact with the unit for a long period of time. They will leave marks on the surface.

#### Cleaning the unit

##### To clean the cabinet

Use a soft, dry cloth. If the surfaces are extremely dirty, use a soft cloth lightly moistened with a mild detergent solution. Do not use strong solvents such as alcohol, benzene, or thinner, as these might damage the surface of the unit.

##### To obtain a clear picture

The DVD/VCR Receiver is a high-tech, precision device. If the optical pick-up lens and disc drive parts are dirty or worn, the picture quality will be poor. Regular inspection and maintenance are recommended after every 1,000 hours of use. (This depends on the operating environment.)  
For details, please contact your nearest dealer.

### Notes on Discs

#### Handling discs

Do not touch the playback side of the disc.  
Hold the disc by the edges so that fingerprints will not get on the surface.  
Do not stick paper or tape on the disc.



#### Storing discs

After playing, store the disc in its case.  
Do not expose the disc to direct sunlight or sources of heat, or leave it in a parked car exposed to direct sunlight, as there may be a considerable temperature increase inside the car.

#### Cleaning discs

Fingerprints and dust on the disc can cause poor picture quality and sound distortion. Before playing, clean the disc with a clean cloth. Wipe the disc from the center out.

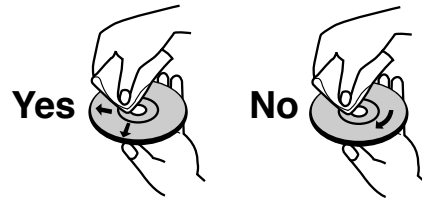

Do not use strong solvents such as alcohol, benzene, thinner, commercially available cleaners, or anti-static spray intended for older vinyl records.







### About Symbols

#### About the symbol display

" " may appear on the TV screen during operation. This icon means the function explained in this owner's manual is not available at that moment or with that specific DVD.

#### About the disc symbols for instructions

A section whose title has one of the following symbols are applicable only to those discs represented by the symbol.

-  DVD
-  Video CDs with the PBC (playback control) function.
-  Video CDs without the PBC (playback control) function.
-  Audio CDs.
-  MP3 Discs.
-  JPEG Files.

#### Selecting the Viewing Source

You must select one of your output sources (DVD or VIDEO) to view on the TV screen.

- **If you want to view DVD deck output source:**  
Press DVD on the remote or DVD/VIDEO on the front panel until DVD indicator in the display window lights and output source of DVD deck is viewed on the TV screen.
- **If you want to view VIDEO deck output source:**  
Press VIDEO on the remote or DVD/VIDEO on the front panel until VIDEO indicator in the display window lights and output source of VIDEO deck is viewed on the TV screen.

#### Notes

- If you insert a cassette tape without an erasure prevention tab intact while the DVD/VCR Receiver is in the DVD mode, the DVD/VCR Receiver will switch to VIDEO function mode automatically.
- You can always view the DVD playback using COMPONENT VIDEO OUT connections although DVD/VCR Receiver is set to other function mode (VIDEO, Radio, etc.)

# Front Panel

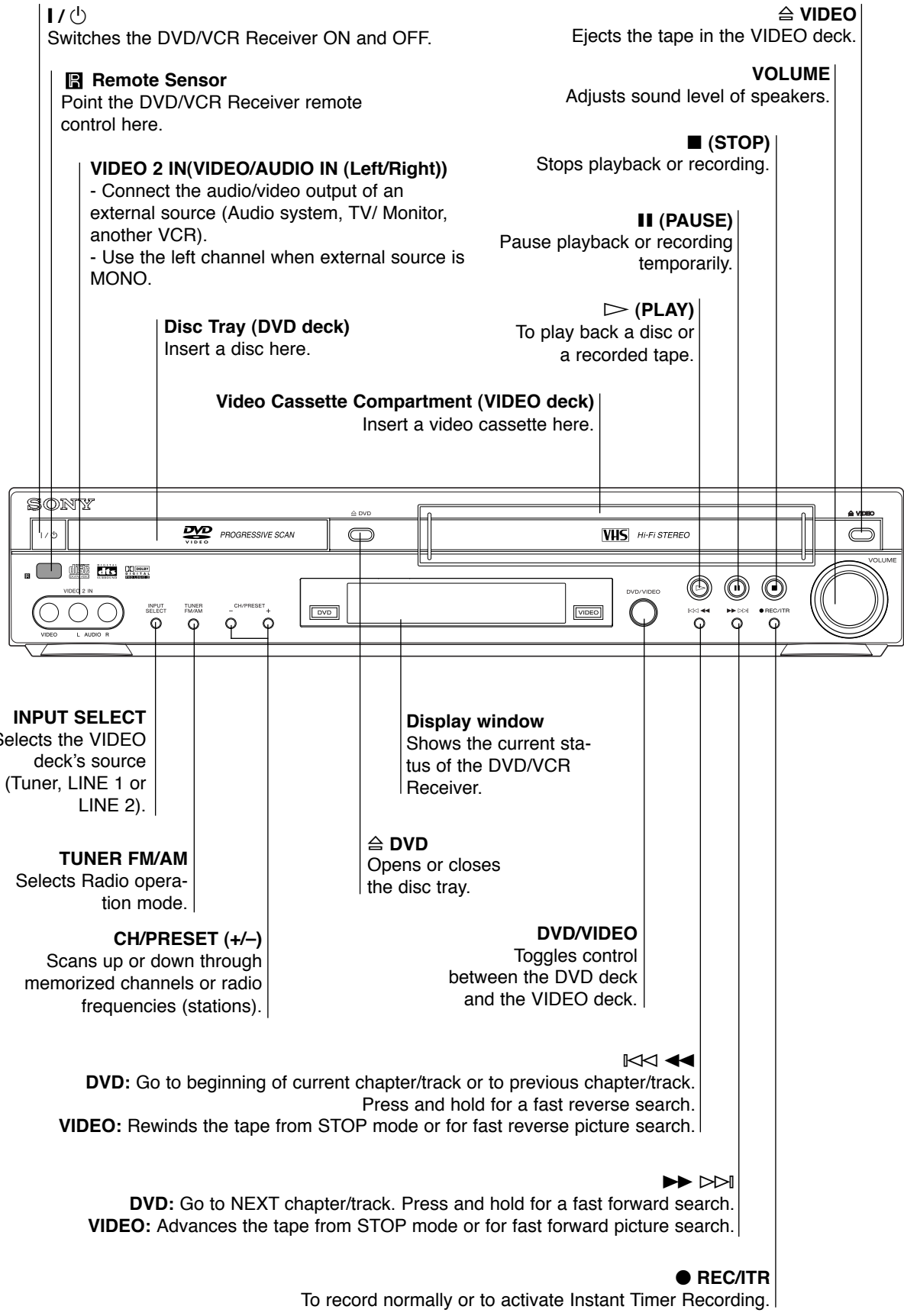

# Display Window

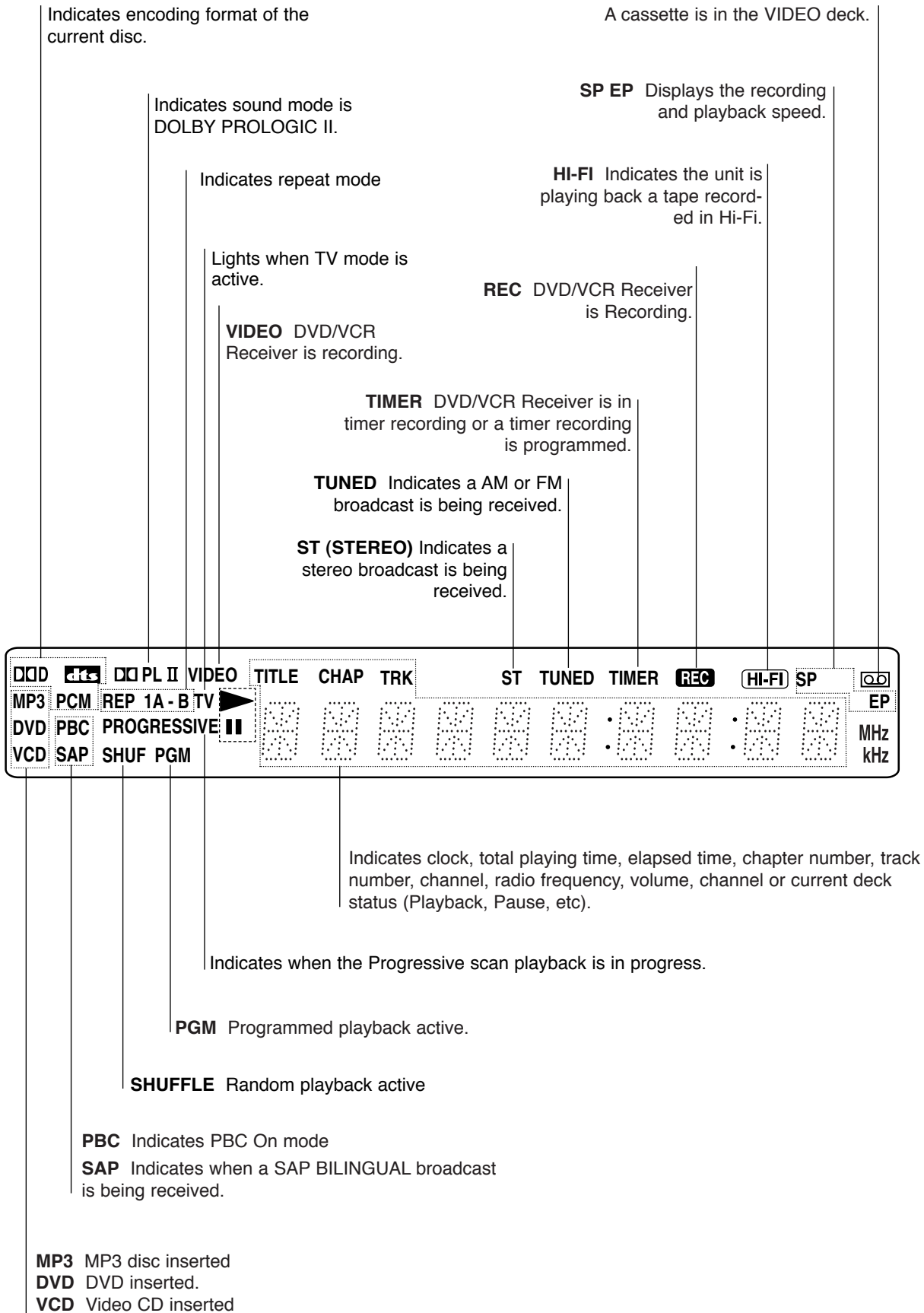



# Remote Control

- VIDEO**  
Select the output source to VIDEO.
- DVD**  
Sets the output source to DVD.
- INPUT SELECT**  
Selects the VIDEO deck's source (L1 OPT, LINE1, LINE2, Tuner).
- TUNER FM/AM**  
Selects the DVD/VCR Receiver's tuner as the listening choice. (FM and AM bands)
- 0-9 numerical buttons**  
Selects numbered options in a menu.
- TUNING (+/-)**  
To tune in the desired station.
- MEMORY**  
Memorize a radio station frequency into the tuner.
- SHUFFLE**  
Plays tracks in random order.
- PROGRAM**  
Enters to the program edit mode or exits from that.
- REC/ITR**  
Records normally or activates Instant Timer Recording.
- TV/VIDEO**  
To view channels selected by the VIDEO tuner or by the TV tuner.
- SP/EP**  
Selects recording speed.
- CM SKIP**  
Fast forwards picture search through 30 seconds of recording.
- ANGLE**  
Selects a DVD camera angle if available.
- SUBTITLE**  
Selects a subtitle language.
- AUDIO**  
Selects an audio language (DVD) or an audio channel (CD).
- REPEAT**  
Repeat chapter, track, title, all.
- A-B**  
Repeats sequence.
- SETUP/MENU**  
Accesses or returns DVD setup menu and VIDEO setup menu.

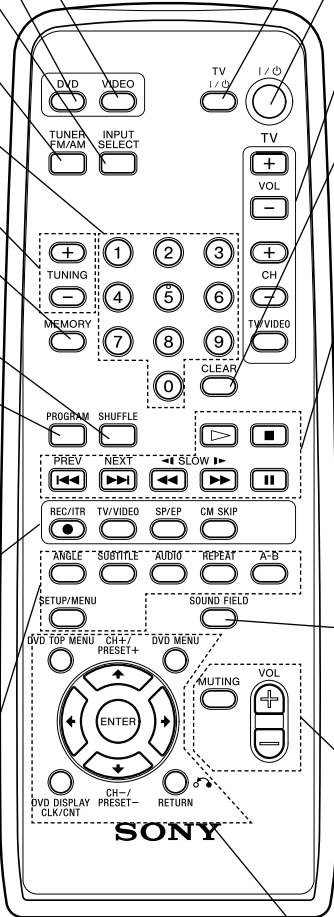

- TV I / ⏻**  
Switches TV ON and OFF.
- I / ⏻**  
Switches DVD/VCR Receiver ON and OFF.
- TV Control Buttons (see page 40)**
  - **VOL +/-**: Adjusts TV's volume.
  - **CH +/-**: Selects TV's channel.
  - **TV/VIDEO**: Selects the TV's source.
- CLEAR**  
Removes a track number on the program menu. To clear preset stations from the tuner memory.
- Playback Control Buttons**
  - **▶ (PLAY)**  
Starts playback.
  - **■ (STOP)**  
Stops playback.
  - **◀◀ (PREV) (DVD mode only)**  
Go to beginning of current chapter or track or go to previous chapter or track.
  - **▶▶ (NEXT) (DVD mode only)**  
Go to next chapter or track.
  - **◀◀/▶▶ (SLOW ◀/▶)**  
DVD: For picture search or slow playback backward or forward.  
VIDEO: Rewinds or advances the tape in STOP mode or for picture search.
  - **⏸ (PAUSE)**  
Pause playback or recording temporarily.
- SOUND FIELD**  
Selects sound mode between AUTO, PRO LOGIC, PRO LOGIC II (MOVIE, MUSIC, MATRIX) and 3D SURROUND.
- VOL (+/-)**  
Adjusts speaker volume.
- MUTING**  
Momentarily silence the speaker of the DVD/VCR Receiver.
- DVD TOP MENU**  
Displays the disc's Title menu, if available.
- DVD MENU**  
Accesses menu on a DVD disc.
  - **◀/▶/▲/▼ (left/right/up/down)**  
Selects an option in the menu.
  - **CH/PRESET(+/-)**: Selects a program of VIDEO or Tuner. Adjusts manually the tape's picture onscreen.
- ENTER**  
Acknowledges menu selection.
- DVD DISPLAY, CLK/CNT**  
Accesses On-Screen display. Switches among the clock and tape counter.
- RETURN**  
Returns the setup menu.

**Note**  
This remote control uses the same buttons for VIDEO and DVD functions (ex. PLAY).  
To use the VIDEO, first press the VIDEO button.  
To use the DVD, first press the DVD button.

## Rear Panel

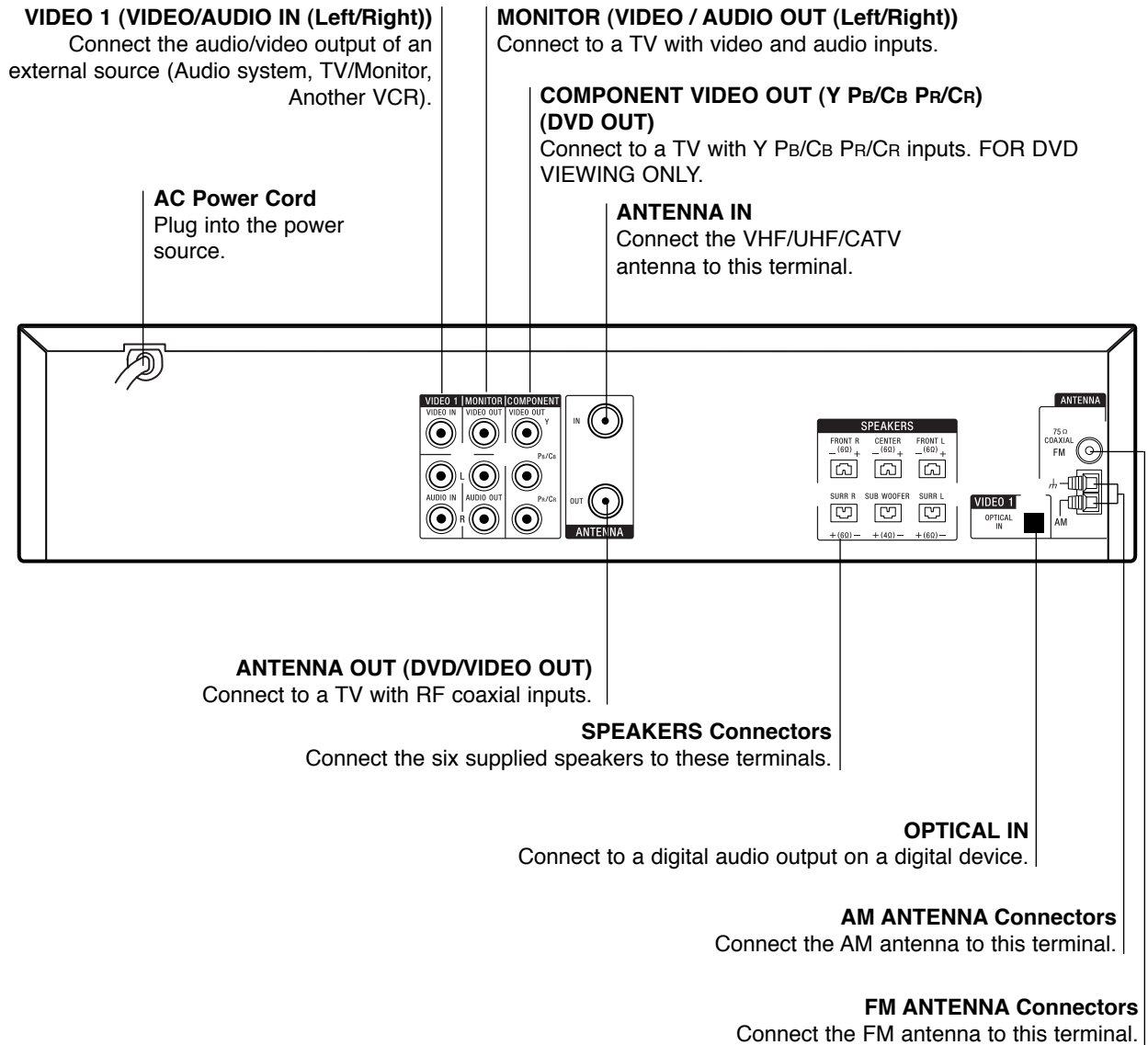

### Dust Protection Cap

Remove the dust protection cap from the OPTICAL IN jack and connect the optical digital cable (not supplied) securely so that the configurations of both the cable and the connector match. Keep the dust protection cap and always reattach the cap when not using the connector to protect against dust intrusion.

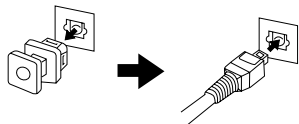

**Do not touch the inner pins of the jacks on the rear panel. Electrostatic discharge may cause permanent damage to the unit.**

### Remote control battery installation

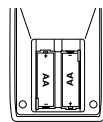

Detach the battery cover on the rear of the remote control, and insert two R6 (size AA) batteries with **+** and **-** aligned correctly.

When using the remote control, point it at the remote sensor  on the unit.



**Caution**  
Do not mix old and new batteries. Never mix different types of batteries (standard, alkaline, etc.).

# Connections

## Tips

- Depending on your TV and other equipment you wish to connect, there are various ways you could connect the DVD/VCR Receiver. Use connections described on pages 11-14.
- Please refer to the manuals of your TV, VCR, Stereo System or other devices as necessary to make the best connections.

## ⚠ Caution

- Make sure the DVD/VCR Receiver is connected directly to the TV. Tune the TV to the correct video input channel.
- Do not connect the DVD/VCR Receiver's AUDIO OUT jack to the phono in jack (record deck) of your audio system.
- Do not connect your DVD/VCR Receiver via your VCR. The DVD image could be distorted by the copy protection system.

## Connecting Antenna/Cable TV to DVD/VCR Receiver

- 1 Disconnect the antenna leads from the rear of the TV.
- 2 Identify the type of cable from your antenna. If it is a round cable as illustrated, it is a 75 ohm coaxial antenna cable. This cable will connect directly to the jack marked ANTENNA IN on your DVD/VCR Receiver.

## Tip

If your antenna lead wire is a flat type antenna cable, connect it to an Antenna Adaptor (300-ohm to 75-ohm) (not supplied) and slip the Adaptor onto the ANTENNA IN jack. The Adaptor does not screw on to the DVD/VCR Receiver, it just slips over the jack.

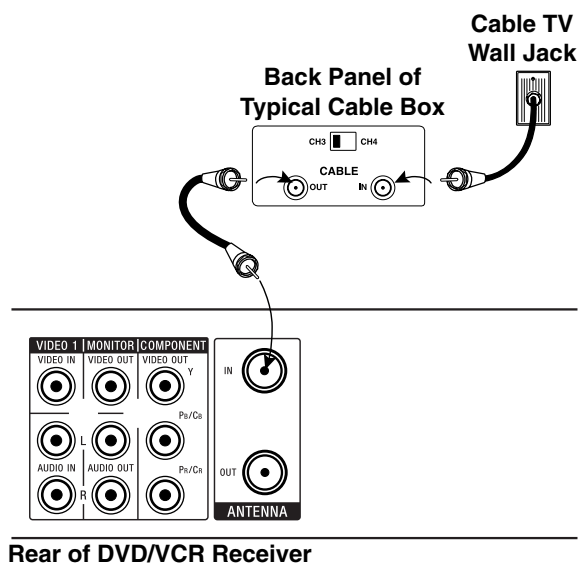

## Without Cable Box

If your cable wire is connected to your TV without a converter or descrambler box, unscrew the wire from your TV and attach it to the ANTENNA IN jack on the DVD/VCR Receiver. Use the supplied round coaxial cable to connect between the DVD/VCR Receiver's ANTENNA OUT jack and the 75 ohm antenna input jack on the TV. With this connection, you can receive all midband, super band, and hyperband channels.

## With Cable Box

If a converter is required in your cable system, follow the instruction below:  
The cable hookup permits both TV and DVD/VCR Receiver operation.

### To view or record a CATV channel

- 1 Tune the TV to the DVD/VCR Receiver output channel (CH 3 or 4).
- 2 Set the DVD/VCR Receiver channel selector to the output channel of the Cable Converter box using CH/PRESET (+/-) or number (0-9) of your DVD/VCR Receiver. (Example: CH3)
- 3 Select the channel to view at the Cable Converter Box.

## Notes

- With this connection, you can not record one program while viewing another.
- If you are using a cable box to tune channels, it is not necessary to do Auto Channel Programming, (Auto Channel Search) as indicated on page 18.

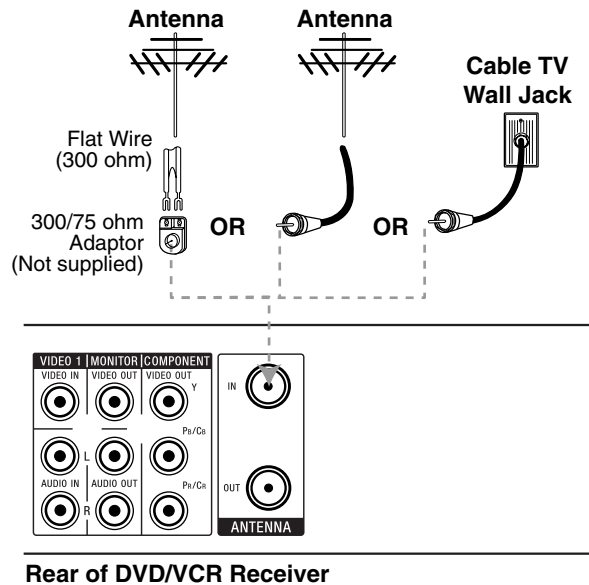

## Connections (Continued)

### Basic TV Connections

Make one of the following connections, depending on the capabilities of your TV.

#### RF coaxial connection

Connect the ANTENNA OUT jack on the DVD/VCR Receiver to the antenna in jack on the TV using the 75-ohm Coaxial Cable supplied (R).

#### Note

If you use this connection, tune the TV to the DVD/VCR Receiver's RF output channel (CH 3 or 4).

#### How to set the DVD/VCR Receiver's RF output channel

When the DVD/VCR Receiver is turned off, press and hold CH/PRESET(+/-) on the front panel for about five seconds to change the RF output channel (CH 03 or CH 04). "RF-03" or "RF-04" appears in the display window.

#### Audio/Video connection

**1** Connect the VIDEO OUT jack on the DVD/VCR Receiver to the video in jack on the TV using the supplied video cable (V).

**2** Connect the Left and Right AUDIO OUT jacks on the DVD/VCR Receiver to the audio left/right in jacks on the TV (A) using the supplied audio cables.

#### Note

If you use this connection, set the TV's source selector to VIDEO.

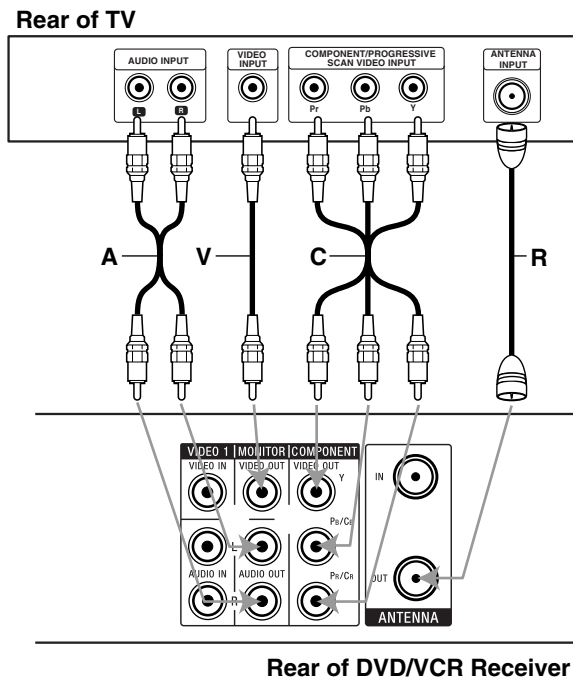

### Optional TV Connections

#### Note

DVD playback can ONLY be done using the COMPONENT VIDEO OUT connection options below. The tuner and VIDEO will still output through the ANTENNA OUT (R) or AUDIO/VIDEO OUT (A, V) jack. (See left)

#### Component Video (Color Stream®) connection

**1** Connect the COMPONENT VIDEO OUT jacks on the DVD/VCR Receiver to the corresponding in jacks on the TV using a component video cables (C).

**2** Connect the Left and Right AUDIO OUT jacks of the DVD/VCR Receiver to the audio left/right in jacks on the TV (A) using the supplied audio cables.

#### Progressive Scan (ColorStream® pro) connection

- If your television is a high-definition or "digital ready" television, you may take advantage of the DVD/VCR Receiver's progressive scan output for the highest video resolution possible.
- If your TV does not accept the Progressive Scan format, the picture will appear scrambled if you try Progressive Scan on the DVD/VCR Receiver.

**1** Connect the COMPONENT VIDEO OUT jacks on the DVD/VCR Receiver to the corresponding in jacks on the TV using a component video cables (C).

**2** Connect the Left and Right AUDIO OUT jacks of the DVD/VCR Receiver to the audio left/right in jacks on the TV (A) using the supplied audio cables.

#### Notes

- Set the Progressive Scan to "On" on the DVD setup menu for progressive signal, see page 21.
- Progressive scan does not work with the analog video connections (yellow VIDEO OUT jack).

## Connections (Continued)

### Speaker System Connections

Connect the speakers using the supplied speaker cords by matching the colors of the terminals and those of the cords. To obtain the best possible surround sound, adjust the speaker parameters (distance, level, etc.).

#### Notes

- Be sure to match the speaker cord to the appropriate terminal on the components: ⊕ to ⊕ and ⊖ to ⊖. If the cords are reversed, the sound will be distorted and lack bass.
- If you use front speakers with low maximum input rating, adjust the volume carefully to avoid excessive volume output to the speakers.
- Do not disassemble the front covers of supplied speakers.

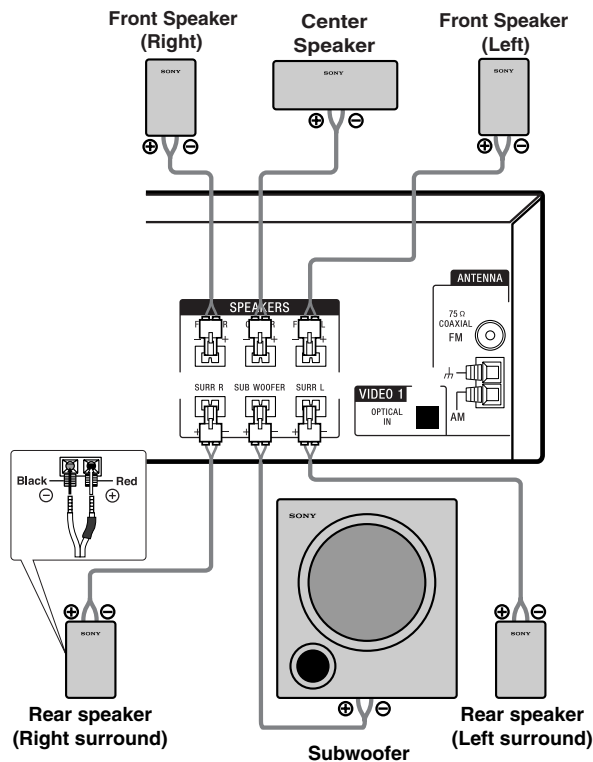

#### About Ferrite Core

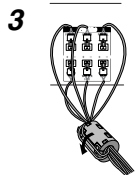
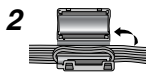
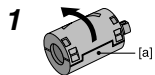

Be sure to attach the ferrite core to the speaker cables (for connecting to this unit). This ferrite core can reduce noises.

#### How to attach the ferrite core.

- 1 Push the stopper [a] of the ferrite core to open.
- 2 Wind the Center and Subwoofer Speaker cables once on the ferrite core. Pass the others straight on the ferrite core.
- 3 Close the ferrite core until it clicks.

### Speaker Positioning

For a normal setup use 6 speakers (2 front speakers, center speaker, 2 rear speakers and subwoofer).

#### • Front Speakers

Based on your listening position, set up the speakers at equal distance. And by hearing position, set up an interval between speakers of 45 degree.

#### • Center Speaker

It is ideal that the center speakers and front speakers are same height. But normally place it above or below the television as shown below.

#### • Rear Speakers

Place the rear surround speakers to the left and right behind the primary listening area. These speakers recreate sound motion and atmosphere required for surround playback. For best results, do not install the rear speakers too far behind the listening position, install them at or above the level of the listener's ears. It is also effective to direct the rear speakers towards a wall or ceiling to further disperse the sound. In the case of a smaller room size, if the audience is near to the rear wall set the rear speakers opposite each other, and set the rear speakers 60 - 90 cm above the listener's ears.

#### • Subwoofer

This can be placed in any front position.

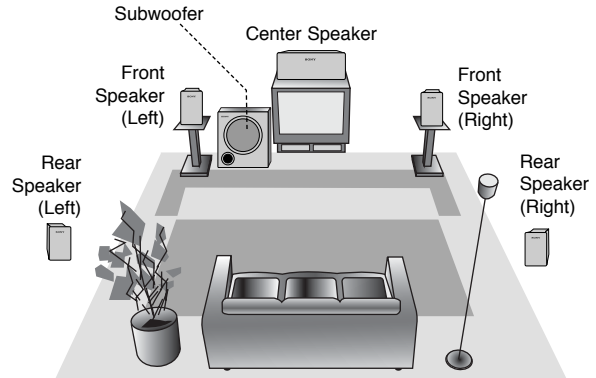

Speaker Positioning Example

#### Note

Speaker stand is optional.

#### Attaching the foot pads

To prevent speaker vibration or movement while listening, attach the supplied foot pads to the speaker, as shown.

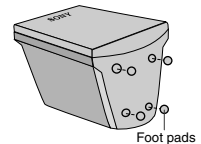

#### Attaching the color labels

Attach the color labels onto the rear panel of the speakers before connecting the speakers.



## Connections (Continued)

### Radio Antenna Connections

Connect the supplied FM/AM antennas for radio listening.

- 1** Connect the AM loop antenna to the AM antenna connectors.
- 2** Connect the FM wire antenna to the FM antenna connectors.

#### Notes

- To prevent noise pickup, keep the AM loop antenna away from the DVD/VCR Receiver and other components.
- Be sure to fully extend the FM wire antenna.
- After connecting the FM wire antenna, keep it as horizontal as possible.

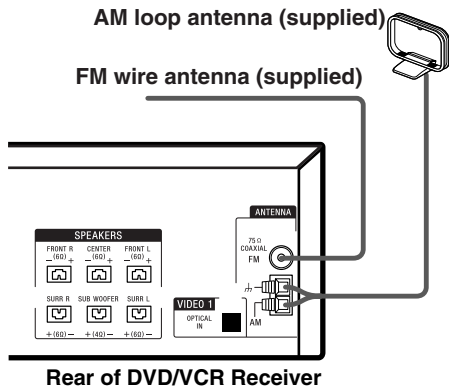

### Accessory Audio/Video (A/V) Connections to DVD/VCR Receiver

Connect the VIDEO 1 or VIDEO 2 jacks on the DVD/VCR Receiver to the audio/video out jacks on your accessory component, using optional audio/video cables.

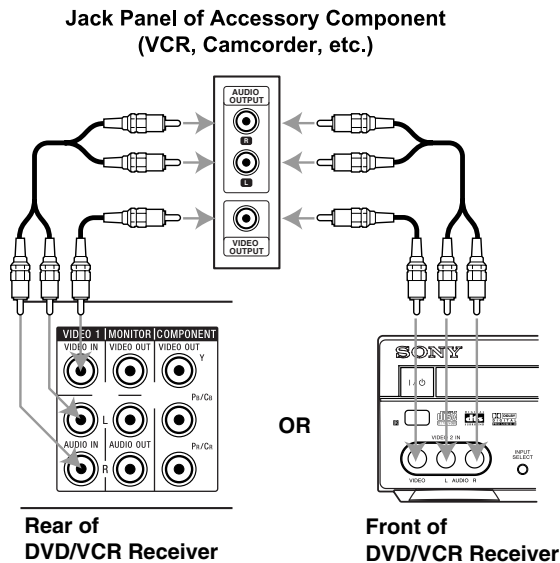

### Digital Device Connections

Connect the OPTICAL IN jacks on the DVD/VCR Receiver to the digital audio out (optical) jacks on your digital device (Game device, Digital Set Top Box, etc.), using optional optical audio cable.

To select source of DVD/VCR Receiver to OPTICAL IN, press INPUT SELECT repeatedly on the remote control until "L1 OPT" appears in the display window.

#### Notes

- If the audio format of the digital output does not match the capabilities of your DVD/VCR Receiver, the DVD/VCR Receiver will produce a strong, distorted sound or no sound at all.
- The Optical input function is available only when the other unit's Sampling Frequency is 32 - 48kHz.

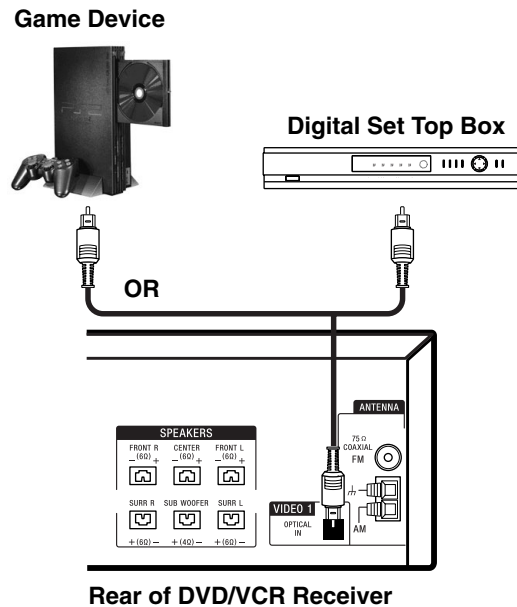

## Selecting the Output/Input Source

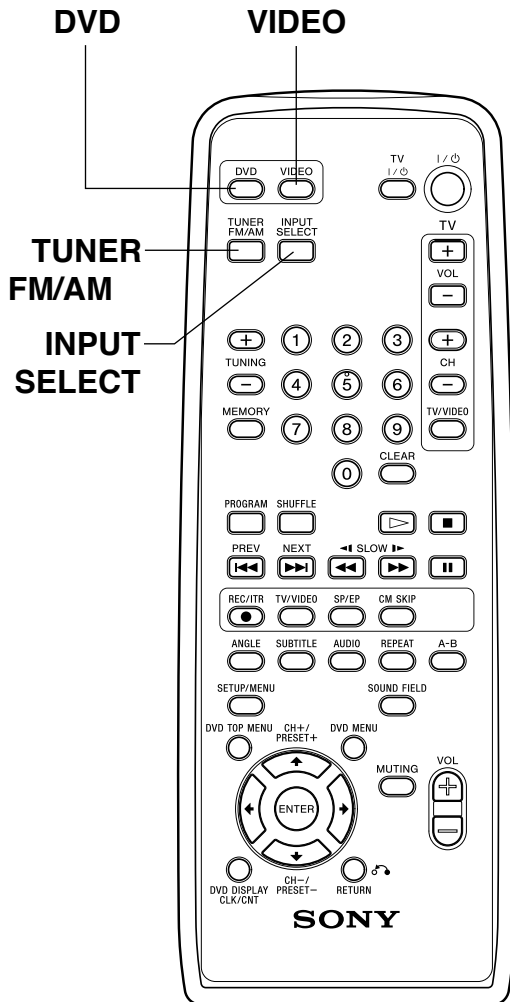

Follow these guidelines to select and switch among the various DVD/VCR Receiver input and output sources:

- **DVD**

- To view output from the DVD deck:**

- Press DVD on the remote or DVD/VIDEO on the front panel until the DVD indicator on the front panel lights and output from the DVD deck is viewed on the TV screen.

- **VIDEO**

- To view output from the VIDEO deck:**

- Press VIDEO on the remote or DVD/VIDEO on the front panel until the VIDEO indicator on the front panel lights and output from the VIDEO deck is viewed on the TV screen.

- **TUNER FM/AM**

- To listen to AM/FM radio broadcasts:**

- Press TUNER FM/AM to toggle between AM and FM radio. The selected frequency appears in the display window.

- **INPUT SELECT**

- To listen and view to an audio source connected to the OPTICAL IN jack with video from VIDEO 1:**

- Press INPUT SELECT on the remote control once. The "L1 OPT" and "LINE 1" appears in the display window and TV screen. Audio will come from an external source connected to the OPTICAL IN jack and video will come from an external source connected to the VIDEO IN jack of VIDEO 1 (for rear panel).

- To listen and view to an audio source connected to the AUDIO IN jack of VIDEO 1 with video from VIDEO 1:**

- Press INPUT SELECT on the remote control a second time. The "L1" and "LINE 1" appears in the display window and TV screen. Audio will come from an external source connected to the AUDIO IN jacks of VIDEO 1 (for rear panel) and video will come from an external source connected to the VIDEO IN jack of VIDEO 1 (for rear panel).

- To listen and view to an audio source connected to the AUDIO IN jack of VIDEO 2 with video from VIDEO 2:**

- Press INPUT SELECT on the remote control a third time. The "L2" and "LINE 2" appears in the display window and TV screen. Audio will come from an external source connected to the AUDIO/VIDEO IN jacks of VIDEO 2 (for front panel).

## Before Operation - Sound Mode Descriptions

### Mini Glossary for Audio Stream & Surround mode

#### (DTS)

Allows you to enjoy 5.1 (or 6) discrete channels of high quality digital audio from DTS program sources such as discs, DVD and compact discs, etc. bearing the trademark. DTS Digital Surround delivers up to 6 channels of transparent audio (which means identical to the original masters) and results in exceptional clarity throughout a true 360 degree sound field. The term DTS is a trademark of DTS Technology, LLC. Manufactured under license from DTS Technology, LLC.

#### (Dolby Digital)

The Dolby Digital surround format lets you enjoy up to 5.1 channels of digital surround sound from a Dolby Digital program source. If you play DVDs with “” mark, you can enjoy even better sound quality, greater spatial accuracy, and improved dynamic range.

#### (Dolby Pro Logic)

Use this mode when playing movie or Dolby Digital 2 channel which carries the “” mark. This mode provides the effect of being in a movie theatre or live concert house—an effect with an intensity which can only be obtained through DOLBY PRO LOGIC SURROUND. The effect of the front/back/left/right movement of the sound image, as well as the sense of fixed position in the sound image, is much clearer and more dynamic than before.

#### (Dolby Pro Logic II)

Dolby Pro Logic II creates five full-bandwidth output channels from two-channel sources. This is done using an advanced, high-purity matrix surround decoder that extracts the spatial properties of the original recording without adding any new sounds or tonal colorations.

##### **MOVIE mode:**

The Movie mode is for use with stereo television shows and all programs encoded in Dolby Surround. The result is enhanced soundfield directionality that approaches the quality of discrete 5.1-channel sound.

##### **MUSIC mode:**

The Music mode is for use with any stereo music recordings, and provides a wide and deep sound space. The Music mode includes controls that allow the sound to be tailored to individual listening tastes.

##### **MATRIX mode:**

The Matrix mode is the same as the Music mode except that the directional enhancement logic is turned off. It may be used to enhance mono signals by making them seem “larger.” The Matrix mode may also find use in auto systems, where the fluctuations from poor FM stereo reception can otherwise cause disturbing surround signals from a logic decoder. The ultimate “cure” for poor FM stereo reception may be simply to force the audio to mono.

#### **3D SURROUND**

This unit can produce a 3D Surround effect, using 3D Surround Sound technology, which simulates multi-channel audio playback from two conventional stereo speakers instead of the five or more speakers normally required to listen to multi-channel audio from a home theatre. This feature works with DVD discs encoded with Dolby Pro Logic and Dolby Digital audio tracks.

#### **AUTO**

Software with multichannel surround audio signals is played according to the way it was recorded.

### Sound Mode

You can enjoy surround sound simply by selecting one of the pre-programmed sound fields according to the program you want to listen to.

Press SOUND FIELD on the remote control repeatedly until the sound mode you want appears in the display window as below.

Each time you press SOUND FIELD button, the sound mode is changed in the following order;



AUTO → PRO LOGIC → MOVIE → MUSIC → MATRIX → 3D SURROUND

#### **When DVD is inserted.**



You can change the sound mode of DVD (Dolby Digital, DTS, PRO LOGIC, etc) by pressing the AUDIO button on the remote during playback.

Although the DVD contents differ from disc to disc, the following explains the basic operation when this feature is used.

Each time you press AUDIO button, the sound mode of DVD is changed as the following order;

 →  → PCM → 

#### **For your reference**

- **The DVD/VCR Receiver memorizes the last mode settings for each source individually.**
- **You can identify the encoding format of program software by looking at its packaging.**
  - Dolby Digital discs are labelled with the  logo.
  - Dolby Surround encoded programs are labelled with the  logo.
  - DTS Digital Surround discs are marked with  logo.

#### **Note**

When you play sound tracks with 96kHz sampling frequency, the output signals will be converted to 48kHz (sampling frequency).

### Volume Control

You can adjust the volume by rotating VOLUME on the front panel or by pressing VOL (+/-) on the remote control repeatedly.

### Muting

#### **Press MUTING to mute your unit.**

You can mute your unit in order, for example, to answer the telephone, “MUTING” indicator in the display window. To exit mute mode, press MUTING again.



# VIDEO Operation Setup

## On-Screen Display (OSD)

Some of these functions appear during VIDEO operation.

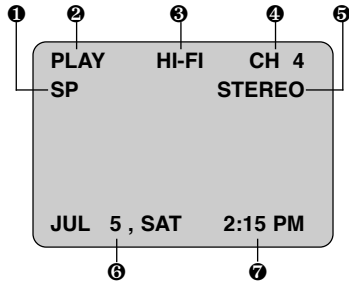

- ❶ **TAPE SPEED DISPLAY**  
Shows the current tape speed.
- ❷ **FUNCTION DISPLAY**  
Indicates the function in progress.
- ❸ **HI-FI DISPLAY**  
Indicates the unit is playing back tape recorded in Hi-Fi.
- ❹ **CHANNEL DISPLAY**  
Indicates the selected channel (or LINE1(L1), LINE2(L2)).
- ❺ **STEREO/SAP DISPLAY (MONO is not displayed)**  
Shows the type of audio signal received by the VIDEO tuner.
- ❻ **DATE DISPLAY**  
Shows the current date. (Month/Date/Day of the week format)
- ❼ **CLOCK/COUNT/REMAIN DISPLAY**  
Shows the current time, the tape counter and remaining time on the tape.

Each press of the ENTER changes the TV on-screen displays in the following sequence.

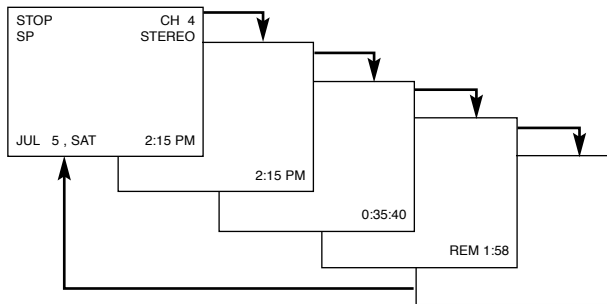

### Notes

- The function displays remain on the TV screen for 5 seconds.
- The clock (or tape counter, tape remaining) mode will remain on the screen until you press ENTER.
- The tape counter and the remaining tape length indicator appear only when a cassette is inserted. Also, the remaining tape length indicator appears after any tape operation.

## EASY INFORMATION

If the Extended Data Service (XDS) signals are provided along with normal TV signal in your area or during playback of a tape recorded with Extended Data Service (XDS) signals, the station ID, program title, and program details are shown on the TV screen.

When viewing a channel with Extended Data Service (XDS) signals, press ENTER and the station ID will appear on the TV screen. Press ENTER again and the program details will appear on the TV screen.

When viewing a tape recorded with Extended Data Service (XDS) signals, press ENTER twice and the program title and program details will appear on the TV screen.

### PROGRAM DETAILS

**LENGTH:** Indicates the run length of a program.

**TIME REMAINING:** Indicates the remaining time of a program.

**RATING:** Indicates the rating of the current program (N/A, G, PG, PG-13, R, NC-17, X and Not Rated). The rating N/A means that the motion picture ratings are not applicable to this program.

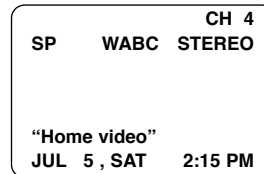

Easy Information Screen (Station ID)

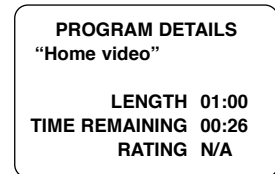

Easy Information Screen (Program details)

## On-Screen Menu Setup

The SETUP, clock setting (CLOCK), and timer recordings (PROGRAM) are accessed conveniently with the on-screen menus, that lead you through each step. The following pages describe the on-screen menu selections available.

### Menu Selection

Your VIDEO allows remote control adjustment of several features.

**1** Press SETUP/MENU and the MAIN menu will appear.

**2** Select the desired menu with ↑/↓ button and then press ENTER.

### Note

Menus remain on-screen for 3 minutes.

### MAIN MENU

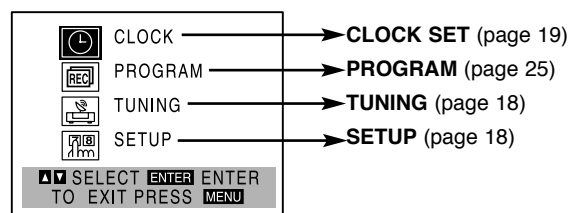

**3** Press SETUP/MENU to return to the TV screen.

## VIDEO Operation Setup (Continued)

### Using the VIDEO Setup Menu

- 1 Press **SETUP/MENU** and the **MAIN** menu will appear.
- 2 Use **↑/↓** to select the **SETUP** menu, then press **ENTER**.  
The **SETUP** menu will appear.

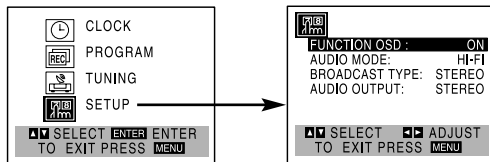

- 3 Use **↑/↓** to select a desired option on the **SETUP** menu. Then use **←/→** to select a desired setting.

#### FUNCTION OSD

The on-screen display of this DVD/VCR Receiver can be turned on or off.

- **FUNCTION OSD** can be switched between **ON** and **OFF** using **←/→**.

#### AUDIO MODE

The DVD/VCR Receiver has two separate audio playback systems, the high quality VHS Hi-Fi system and standard NORMAL mono system. The same audio is generally recorded on both systems. The VHS Hi-Fi system plays on separate (left and right) channels, and the NORMAL system plays monaural sound. The normal track is always played so the cassette can be played on a DVD/VCR Receiver that does not have VHS Hi-Fi.

- **AUDIO MODE** can be switched between **HI-FI** and **NORMAL** using **←/→**.

#### BROADCAST TYPE (STEREO/SAP/MONO)

Multichannel Television Sound (MTS) carries stereo and/or Second Audio Program (SAP) bilingual signals. Set this display to the desired position when both MTS stereo and SAP signals are received. When only one of the MTS signal is received, the DVD/VCR Receiver automatically selects the corresponding receiving mode (Stereo or SAP) regardless of the selected position. For normal operation, the display should be in the **STEREO** position. The DVD/VCR Receiver will then record a **STEREO** program when available, and record a mono program IF the program is **NOT IN STEREO**.

For weak **STEREO** and/or **SAP** broadcasts, changing the display to mono may give clearer sound.

- **BROADCAST TYPE** can be switched between **STEREO**, **SAP**, and **MONO** using **←/→**.

#### AUDIO OUTPUT (STEREO/LEFT/RIGHT)

Used during playback [when **AUDIO MODE** (**HI-FI**/**NORMAL**) is in **HI-FI** position] for selecting the audio output signals from the **AUDIO OUT** terminals (L ch and R ch), and **ANTENNA OUT**. This display setting should normally be left in the stereo position, so that when a stereo tape is played, the stereo sound will be heard through the left and right channels. If a mono tape is played and the audio output is set to stereo, the same mono sound will be heard from both left and right channels.

- **AUDIO OUTPUT** can be switched between **STEREO**, **LEFT**, and **RIGHT** using **←/→**.

- 4 Press **SETUP/MENU** to return to the **TV** screen.

### Channel Selection

This DVD/VCR Receiver is equipped with a frequency synthesized tuner capable of receiving up to 181 channels. These include VHF channels 2-13, UHF channels 14-69 and CATV channels 1-125.

#### Preparation:

- Connect the DVD/VCR Receiver to the desired type of antenna or cable TV system, as shown in Connecting Antenna/Cable TV to DVD/VCR Receiver on page 11.

### AUTO CHANNEL PROGRAMMING

- 1 Press **SETUP/MENU** and the **MAIN** menu will appear.
- 2 Use **↑/↓** to select the **TUNING** menu, then press **ENTER**.  
The **TUNING** menu will appear.

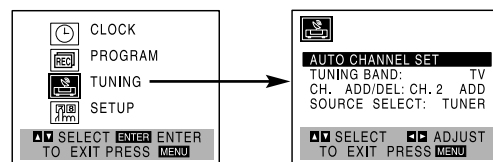

- 3 Use **↓** to select the **SOURCE SELECT** option, then use **←/→** to select **TUNER**.  
Press **←/→** repeatedly to switch between **TUNER**, **LINE1 (L1)** and **LINE2 (L2)**.
- 4 Use **↑/↓** to select the **AUTO CHANNEL SET** option, then use **←/→** to search for channels.  
The tuner will automatically cycle through all available channels in the area and place them in the tuner's memory.
- 5 After the **AUTO CHANNEL SET** proceeding is complete, make sure the **TUNING BAND** is set appropriately (**TV** or **CATV**) using **↑/↓** and choosing the correct **TUNING BAND** (**TV** or **CATV**) by using **←/→** while in the **TUNING** menu. Remember, **TV** is for the air antenna reception, **CATV** is for cable or wireless cable connection.
- 6 Press **SETUP/MENU** to return to the **TV** screen.
- 7 Use **CH/PRESET(+/-)** on the front panel or remote control to cycle the DVD/VCR Receiver through the channels in memory.

#### Note

Channel Selection will not be activated during playback.

### TO ADD OR ERASE CHANNELS FROM MEMORY

This feature allows you to add or erase channels in memory manually.

- 1 Use **↓** to select the **CH. ADD/DEL** option on the **TUNING** menu. Use **←/→** to select a channel to add or erase.
- 2 Use **ENTER** to add or erase the channel.  
Repeat steps 1 and 2 to add or erase channels.
- 3 Press **SETUP/MENU** to return to the **TV** screen.

## VIDEO Operation Setup (Continued)

### Setting the Clock

The DVD/VCR Receiver gives you two ways to set the time and date: the Auto Clock Feature or manually. The Auto Clock feature enables the DVD/VCR Receiver to set up the clock while the DVD/VCR Receiver is turned off.

#### Things to know before starting

- The clock uses the 12-hour system. (Be sure to set AM and PM correctly.)
- The initial Clock Setting is **JANUARY 1, 2004, 12:00 AM**.

### Auto Clock Set

The Auto Clock Set feature is set to ON at the factory. In the ON setting, the DVD/VCR Receiver looks for a channel carrying XDS (Extended Data Services) information. XDS updates the clock using the Coordinated Universal Time.

The Auto Clock feature enables the DVD/VCR Receiver to set up the clock while the DVD/VCR Receiver is turned off.

- 1 Press **SETUP/MENU** and the **MAIN** menu will appear.
- 2 Use **↑/↓** to select the **CLOCK** menu. Press **ENTER** and the **CLOCK** menu will appear.

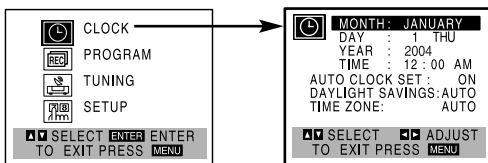

- 3 Use **↓** to select the **AUTO CLOCK SET** option. Use **←/→** to select **ON**.  
The Auto Clock Set feature is set to ON at the factory. In the ON setting, the DVD/VCR Receiver looks for a channel carrying XDS (Extended Data Services) information. XDS updates the clock using the Coordinated Universal Time.
- 4 Use **↓** to select the **DAYLIGHT SAVINGS** option. Use **←/→** to select **AUTO, ON, or OFF**.  
If you select AUTO, the DVD/VCR Receiver sets the clock using the DST information broadcast in the signal (channel). If you select ON, the DVD/VCR Receiver adjusts the clock for Daylight Saving Time automatically.
- 5 Use **↓** to select the **TIME ZONE** option. Use **←/→** to select the correct time zone (**AUTO, EASTERN, CENTRAL, MOUNTAIN, PACIFIC, ALASKA or HAWAII**).  
If "AUTO" is selected as the time zone, the DVD/VCR Receiver sets the clock using the first Coordinated Universal Time information it finds in a broadcast signal.
- 6 Press **SETUP/MENU** to return to the TV screen.
- 7 Turn off the DVD/VCR Receiver and the auto clock set feature sets the time.

#### Note

There are cases where the TV station does not send or sends the wrong time. Therefore, the incorrect time will be set. If this happens we recommend that you set the clock manually.

### Manual Clock Set

- 1 Press **SETUP/MENU** and the **MAIN** menu will appear.
- 2 Use **↑/↓** to select the **CLOCK** menu. Press **ENTER** and the **CLOCK** menu will appear.

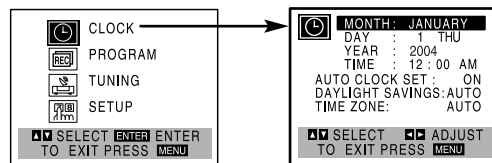

- 3 Use **←/→** to select the month.
- 4 Use **↓** to select the **DAY** option. Use **←/→** to select the date.  
The day of the week will display automatically.
- 5 Use **↓** to select the **YEAR** option. Use **←/→** to select the year.
- 6 Use **↓** to select the **TIME** option. Use **←/→** to select the time. Press and hold **←/→** to advance clock continuously.
- 7 Use **↓** to select the **DAYLIGHT SAVINGS** option. Use **←/→** to select **AUTO, ON, or OFF**.  
If you select AUTO, the VIDEO sets the clock using the DST information broadcast in the signal (channel). If you select ON, the VIDEO adjusts the clock for Daylight Saving Time automatically.

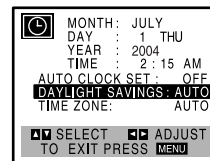

- 8 Press **SETUP/MENU** to return to the TV screen.

#### Notes

- If setting the clock manually, "AUTO CLOCK SET" must set to "OFF". If set to "ON", an incorrect date and/or time will be entered again when the DVD/VCR Receiver is turned off.
- "--:-- --" appears in the display window during clock setting.

# DVD Operation Setup

## General Explanation

This manual gives basic instructions for operating the DVD/VCR Receiver. Some DVDs require specific operation or allow only limited operation during playback. When this occurs, the symbol  appears on the TV screen, indicating that the operation is not permitted by the DVD/VCR Receiver or is not available on the disc.









## On-Screen Display

General playback status can be displayed on the TV screen. Some items can be changed on the menu.

### On-screen display operation

- 1** Press DVD DISPLAY during playback.
- 2** Press  $\uparrow/\downarrow$  to select an item.  
The selected item will be highlighted.
- 3** Press  $\leftarrow/\rightarrow$  to change the setting of an item.  
The number buttons can be also be used for setting numbers (e.g., title number). For some functions, press ENTER to execute the setting.









### Temporary Feedback Field Icons

-  Repeat Title
-  Repeat Chapter
-  Repeat Track (non-PBC Video CDs only)
-  Repeat All Tracks (non-PBC Video CDs only)
-  Repeat A-B
-  Repeat Off
-  Resume play from this point
-  Action prohibited or not available





### Notes

- Some discs may not provide all of the features on the on-screen display example shown below.
- If no button is pressed for 10 seconds, the on-screen display disappears.

### DVD

Items	Function (Press $\uparrow/\downarrow$ to select desired item)	Selection Method
Title Number	 1 / 3 Shows the current title number and total number of titles, and skips to the desired title number.	$\leftarrow/\rightarrow$ , or Numbers, ENTER
Chapter Number	 1 / 12 Shows the current chapter number and total number of chapters, and skips to the desired chapter number.	$\leftarrow/\rightarrow$ , $\lll/\ggg$ or Numbers, ENTER
Time search	 0:20:09 Shows the elapsed playing time, and searches the point directly from the elapsed time.	Numbers, ENTER
Audio language and Digital Audio Output mode	 1 ENG  5.1 CH Shows the current audio soundtrack language, encoding method, and channel number, and changes the setting.	$\leftarrow/\rightarrow$ , or AUDIO
Subtitle language	 OFF Shows the current subtitles language, and changes the setting.	$\leftarrow/\rightarrow$ , or SUBTITLE
Angle	 1 / 1 Shows the current angle number and total number of angles, and changes the angle number.	$\leftarrow/\rightarrow$ , or ANGLE
Sound	 AUTO Shows the current sound mode, and changes the setting.	$\leftarrow/\rightarrow$ , or SOUND FIELD

### VCD2.0 VCD1.1

Items	Function (Press $\uparrow/\downarrow$ to select desired item)	Selection Method
Track Number	 1 / 3 Shows the current track number, total number of tracks and PBC On mode, and skips to the desired track number.	$\leftarrow/\rightarrow$ , or Numbers, ENTER
Time	 0:20:09 Shows the elapsed playing time (Display only)	-
Audio Channel	 ST Shows the audio channel, and changes the audio channel.	$\leftarrow/\rightarrow$ , or AUDIO
Sound	 AUTO Shows the current sound mode, and changes the setting.	$\leftarrow/\rightarrow$ , or SOUND FIELD

## DVD Operation Setup (Continued)

### Initial Settings

You can set your personal preferences on the DVD function mode.



### General Operation

- 1 Press SETUP/MENU.**  
The Setup menu appears.
- 2 Use ↑/↓ to select the desired option.**  
The screen will show the current setting for the selected option, as well as alternate setting(s).
- 3 While the desired option is selected, press →, then ↑/↓ to select the desired setting.**
- 4 Press ENTER to confirm your selection.**  
Some options require additional steps.
- 5 Press SETUP/MENU, RETURN, or ▷ (PLAY) to exit the setup menu.**

### Language

#### Disc Language **DVD**

Select a language for the disc's Menu, Audio, and Subtitle features.

**Original** : The original language set for the disc is selected.

**Other** : To select another language, use number buttons to enter the corresponding 4-digit number according to the language code list on page 44. If you enter the wrong language code, press CLEAR.



#### Note

Disc Language selection may not work for some DVDs.

#### Menu Language

Select a language for the VCR and DVD's Setup menu.

This is the menu you see when you press SETUP/MENU.



### Picture

#### TV Aspect **DVD**

**4:3 Letterbox**: Select when a standard 4:3 TV is connected. Displays pictures with masking bars above and below the picture.

**4:3 Panscan**: Select when a standard 4:3 TV is connected. Displays pictures cropped to fill your TV screen. Both sides of the picture are cut off.

**16:9 Wide**: Select when a 16:9 wide TV is connected.

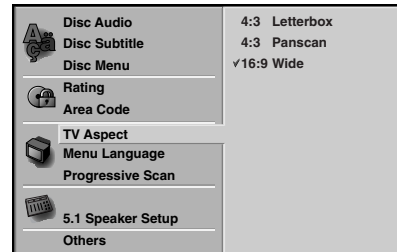

#### Progressive Scan **DVD**

Progressive Scan Video provides the highest resolution pictures with less flicker and line structure.

If you are using the COMPONENT VIDEO OUT jacks, but are connecting the DVD/VCR Receiver to a standard (analog) television, set Progressive Scan to Off. If you are using the Component Video jacks for connection to a TV or monitor that is compatible with a progressive scan signal, set Progressive Scan to On.

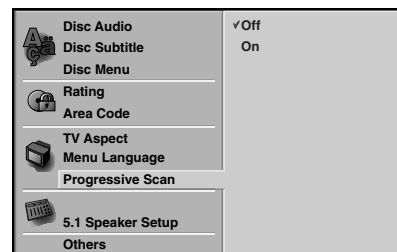

#### Caution

Once the setting for progressive scan output is entered, an image will only be visible on a progressive scan compatible TV or monitor. If you set Progressive Scan to On in error, you must reset the unit. Pointing the remote at the DVD/VCR Receiver, press the ■ (STOP) key to stop any disc that is playing. Next, press the ■ (STOP) key again and hold it for five seconds before releasing it. The video output will be restored to the standard setting, and a picture will once again be visible on a conventional analog TV or monitor.

## DVD Operation Setup (Continued)

### Speaker setup

#### 5.1 Speaker settings **DVD**

Select speaker settings, including volume balance and distance, or test the speaker settings.

Speaker settings are only active on the Analog Multi-Channel Output. (See "Speaker Setup", page 37.)

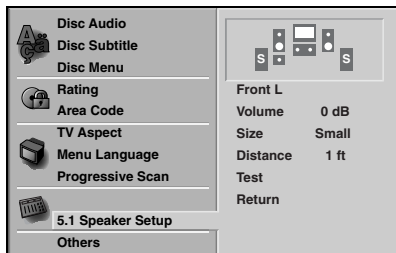

### Others

The DRC and PBC settings can be changed.

- Press  $\uparrow/\downarrow$  to select the desired item and press ENTER. The setting of the selected item is changed between On and Off.

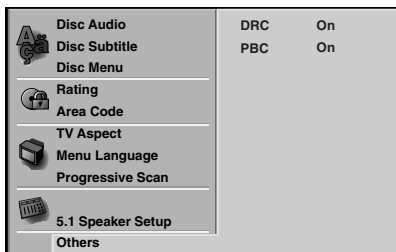

### Dynamic Range Control (DRC)

With the DVD format, you can hear a program's soundtrack in the most accurate and realistic presentation possible, thanks to digital audio technology. However, you may wish to compress the dynamic range of the audio output (the difference between the loudest sounds and the quietest ones). Then, you may listen to a movie at a lower volume without losing clarity of sound. Set DRC to On for this effect.

### Playback Control (PBC)

**On:** Video CDs with PBC are played according to the PBC.

**Off:** Video CDs with PBC are played the same way as Audio CDs.

## DVD Operation Setup (Continued)

### Parental Control

#### Rating **DVD**

Movies on DVDs may contain scenes not suitable for children. Therefore, discs may contain Parental Control information that applies to the complete disc or to certain scenes on the disc. These scenes are rated from 1 to 8, and alternatively, more suitable scenes are available for selection on some discs. Ratings are country dependent. The Parental Control feature allows you to prevent discs from being played by your children or to have certain discs played with alternative scenes.

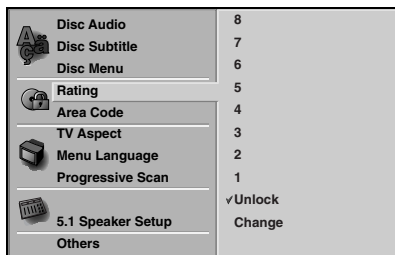

- 1** Select Rating on the Setup menu using **▲/▼** buttons on the setup menu.
- 2** While Rating is selected, press **▶**.
- 3** When you have not entered a password yet. Enter a 4-digit password using the number buttons to create a personal 4-digit security password, then press ENTER. Enter the 4-digit password again and press ENTER to verify.  
**When you have already entered a password;** Enter a 4-digit password using the numerical buttons to confirm the personal 4-digit security password, then press ENTER.  
  
If you make a mistake before pressing ENTER, press CLEAR and enter 4-digit security password again.
- 4** Select a rating from 1 to 8 using **▲/▼** buttons. **One (1) has the least playback restrictions. Eight (8) has the most playback restrictions.**  
**Unlock:** If you select Unlock, Parental Control is not active. The disc will play in full.  
**Ratings 1 to 8:** Some discs contain scenes not suitable for children. If you set a rating for the DVD, all disc scenes with the same rating or lower will be played. Higher rated scenes will not be played unless an alternative scene is available on the disc. The alternative must have the same rating or a lower one. If no suitable alternative is found, playback will stop. You must enter the 4-digit password or change the rating level in order to play the disc.
- 5** Press ENTER to confirm your rating selection, then press SETUP/MENU to exit the menu.

#### Area Code **DVD**

Enter the code of an area whose standards were used to rate the DVD video disc, referring to the list (See "Area Code List", page 45.).

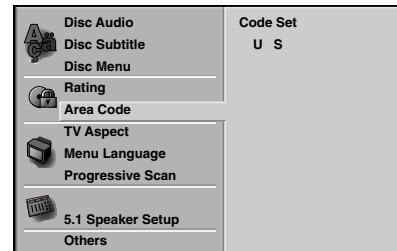

- 1** Select the Area Code option using the **▲/▼** buttons on the setup menu.
- 2** While Area Code is selected, press **▶**.
- 3** Follow step 3 of "Rating" on left.
- 4** Select the first character using the **▲/▼** buttons.
- 5** Press **▶** to shift to second character and select the second character using **▲/▼** buttons.
- 6** Press ENTER to confirm your Area Code selection, then press SETUP/MENU to exit the menu.

#### Note

Confirmation of the 4-digit password is necessary when the password is changed (see Changing the 4-digit password below).

#### Changing the 4-digit password

- 1 Follow Steps 1-2 as shown above to the left (Rating).
- 2 Enter the old password, then press ENTER.
- 3 Select Change using **▲/▼** buttons then press ENTER.
- 4 Enter the new 4-digit password, then press ENTER.
- 5 Enter exactly the same password a second time and verify by pressing ENTER.
- 6 Press SETUP/MENU to exit the menu.

#### If you forget your 4-digit password

If you forget your password, to clear the current password follow the procedure below.

- 1 Press SETUP/MENU to display the setup menu.
- 2 Enter the 6-digit number "210499".  
The 4-digit password is cleared.
- 3 Enter a new password as shown above to the left (Rating).

## VIDEO Operation

### Playback

#### Preparation:

- Turn on the TV.
- Tune the TV to the DVD/VCR Receiver output channel (CH 3 or 4) or set the TV's source selector to VIDEO.
- If a direct VIDEO/AUDIO connection is made between the DVD/VCR Receiver and the TV, set the TV's source selector to VIDEO.
- Set the Output Source to VIDEO as shown in "Selecting the Output/Input Source" on page 15.

#### Note

If you select "L1 OPT", this unit can not activate the playback mode.

#### 1 Insert a prerecorded video cassette.

The  indicator will light and the DVD/VCR Receiver will power-up automatically.

- You have to set the DVD/VCR Receiver to the VIDEO function mode manually.
- Make sure that the TIMER indicator in the display window is not lighted. If it is, press  once.
- If a tape without a safety tab is inserted, the unit will start playback automatically.

#### 2 Press (PLAY).

PLAY appears on the TV screen .

- It is not necessary to select the tape speed for playback. It will be automatically selected by the DVD/VCR Receiver.
- In playback, the TV/VIDEO selector switches to VIDEO mode automatically.

#### 3 Press (STOP) to stop playback.

STOP appears on the TV screen.

- If the tape reaches the end before  (STOP) is pressed, the DVD/VCR Receiver will automatically stop, rewind and eject the tape, and it will turn itself off.

### Tracking Control

#### Auto Tracking

The automatic tracking function adjusts the picture to remove snow or streaks.

The Auto Tracking function works in the following cases:

- A tape is played back for the first time.
- Tape speed (SP, EP) changes.
- Streaks or snow appear because of scratches on the tape.

#### Manual Tracking

If noise appears on the screen during playback, press either CH/PRESET (+/-) on the remote control or front panel until the noise on the screen is reduced.

- If vertical jitter is present, adjust tracking controls very carefully.
- Tracking is automatically reset to normal when the tape is ejected or the power cord is unplugged for more than 3 seconds.

### Special Effect Playbacks



#### Special effects playback notes

- Horizontal lines (noise bars) will appear on the TV screen. This is normal.
- The audio is automatically muted during special effect modes, so there is no sound during search.

- During high-speed picture search mode, a short period is needed to stabilize tape speed when re-entering the PLAY mode. Slight interference may be observed during this period.

### Search

This function lets you quickly and visually search for a desired tape section in either direction: forward or reverse.

1 Press  or  during playback. The DVD/VCR Receiver will be activated in the SEARCH mode.

- If the DVD/VCR Receiver is left in the SEARCH mode for more than 3 minutes, the DVD/VCR Receiver will automatically enter the PLAY mode, to protect the tape and video heads.

2 To return to playback, press  (PLAY).

### Still Picture and Frame-by-Frame Playback

1 Press  (PAUSE) during playback.

Still picture will appear on the TV screen.

- If a still picture vibrates vertically, stabilize it using  on the remote control.
- If the DVD/VCR Receiver is left in the STILL mode for more than 5 minutes, the DVD/VCR Receiver will automatically enter the STOP mode to protect the tape and video heads.

2 Press  (PAUSE) repeatedly to advance the video picture one frame at a time while viewing a still picture.

3 To return to playback, press  (PLAY).

### Slow Motion

1 While in still mode, press SLOW .

The tape will be played back at a speed 1/19 times slower than the normal speed.

- During slow playback, use  on the Remote Control to minimize noise bands.
- If slow motion mode continues for more than 3 minutes, the DVD/VCR Receiver will automatically change to playback mode.

2 To return to playback, press  (PLAY).

### CM Skip (Commercial Skip)

This is useful for skipping commercials or short program segments.

1 Press CM SKIP during playback.

The tape will fast forward picture search through 30 seconds of recording.

- Skipping time can be extended by pressing CM SKIP repeatedly.
- Subsequent presses result in advancing the fast forward picture search time by 30-second increments (maximum 3 minutes).

2 When the search is complete, the DVD/VCR Receiver will go into playback mode automatically.



## VIDEO Operation (Continued)

### Normal Recording

#### Preparation:

- Turn on the power of both the DVD/VCR Receiver and TV.
- Tune the TV to the DVD/VCR Receiver output channel (CH 3 or 4) or set the TV's source selector to VIDEO.
- If a direct VIDEO/AUDIO connection is made between the DVD/VCR Receiver and the TV, set the TV's source selector to VIDEO.

**1** Insert a video cassette with the safety tab intact.

**2** Select the desired channel with CH/PRESET (+/-) or number (0-9) buttons.

If you are recording from another source via audio/video input jacks (at the Rear or Front panel), select LINE1 (L1), LINE2 (L2).

**3** Set the desired recording speed (SP or EP) with the SP/EP button.

**4** Set the MTS mode as desired (See page 18, 28).

**5** Press ● REC/ITR once.

Recording will start. (The REC indicator will light in the display window.)

- REC indicator appears only when the Output Source is set to VIDEO.
- If a cassette with no safety tab is loaded, the cassette will be ejected automatically.

**6** Press ■ (STOP) to stop recording.

If the tape reaches the end before ■ (STOP) is pressed, the DVD/VCR Receiver will automatically stop, rewind, eject the tape and turn itself off.

### To pause recording

**1** Press ■ (PAUSE) to pause the tape during recording.

The REC indicator will flash and RECP appears in the display window.

**2** When you want to continue recording, press

■ (PAUSE) or ● REC/ITR.

- After 5 minutes in Pause mode, the tape will be stopped automatically to protect the tape and the video heads.

### To record one TV program while watching another

**1** Use TV/VIDEO button on the remote to select the TV mode during recording.

"TV" segment and "MUTING" appears in the display window.

**2** Using the TV, select the channel to be viewed.

#### Tip

Always use ■ (PAUSE) for best results when making changes during recording.

For example: To change channels during recording, first press ■ (PAUSE) to put the unit in pause mode. Select the desired channel on the DVD/VCR Receiver, then press ■ (PAUSE) again to resume recording.

### Timer Recording

This DVD/VCR Receiver can be programmed to record up to 8 programs within a period of 1 year. For unattended recording, the timer needs to know the channels to be recorded and the starting and ending times.

#### Things to know before starting

- If you try to set the program timer before setting the clock, PLEASE SET THE CLOCK appears for a moment and then CLOCK menu appears on the TV screen. Set the time and date before proceeding.
- Make sure a tape is in the DVD/VCR Receiver and the safety tab is in place or the tape will be automatically ejected.

#### Preparation:

- Turn on the power of both the DVD/VCR Receiver and the TV.
- Be sure the TV is set to the DVD/VCR Receiver output channel (CH3 or CH4).
- Make sure the TUNING BAND in the TUNING menu is set appropriately (TV or CATV).

**1** Insert a video cassette with the safety tab intact.

**2** Press SETUP/MENU and the MAIN menu will appear.

**3** Use ↑/↓ to select the PROGRAM menu.

**4** Press ENTER to go to the PROGRAM menu. The PROGRAM menu will appear.

- If all 8 programs have been entered, FULLY PROGRAMMED message will appear for a moment and then PROGRAM 1 will appear on the TV screen.

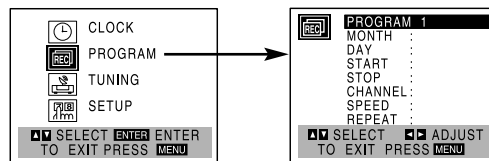

**5** Use ←/→ to select the PROGRAM No. (1-8).

**6** Use ↓ to select the MONTH option. Use ←/→ to select the desired month.

**7** Use ↓ to select the DAY option. Use ←/→ to select the desired day.

**8** Use ↓ to select the START option. Use ←/→ to select the desired start time.

**9** Use ↓ to select the STOP option. Use ←/→ to select the desired stop time.

**10** Use ↓ to select the CHANNEL option. Use ←/→ to select the desired channel (Channel, LINE1(L1) or LINE2(L2)).

**Cable Users:** If you have Cable TV and used Cable Box in Connecting Antenna/Cable TV to DVD/VCR Receiver (page 11), using a cable box converter, you must set the channel in this step to match the cable box output channel (usually CH 3 or 4). Change channels on the cable box instead of with the DVD/VCR Receiver.

## VIDEO Operation (Continued)

- 11** Use  $\downarrow$  to select the **SPEED** option.  
Use  $\leftarrow/\rightarrow$  to select the desired recording speed (**AUTO, SP or EP**).

AUTO mode determines how much tape is left and switches speed from SP to EP, if necessary, to complete recording the program. There will be some picture and sound distortion at the point of the speed change.

- 12** Use  $\downarrow$  to select the **REPEAT** option.  
Use  $\leftarrow/\rightarrow$  to select the desired repeat (**ONCE, WEEKLY or DAILY**).

**ONCE:** for recording up to 8 programs on a single day or over the days within a period of 1 year.

**WEEKLY:** for recording up to 8 programs on a certain day of every week.

**DAILY:** for recording up to 8 programs at the same time(s) Monday through Friday.

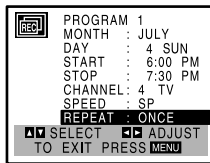

### Tip

If the input data is wrong, use  $\uparrow/\downarrow$  to select the data and correct it using  $\leftarrow/\rightarrow$ .

- 13** Press **SETUP/MENU**, the program will be memorized by the DVD/VCR Receiver.

- **TIMER** indicator lights in the display window.
- If the program preset time has past, the **PAST TIME PROGRAMMED** message will appear on the TV screen. Return to the incorrect program and program it with the correct time.
- If you had entered a past date, timer recording will be performed on that date of the next year.
- Additional programs may be entered by repeating steps 1-12.

**Cable Users:** If your cable hookup is via a TV converter box, you can program multiple recordings only on the converter box output channel. This is because the converter determines what channel you view through your DVD/VCR Receiver.

### Tip

If you are finished programming and you want to set the DVD/VCR Receiver to record the programs you have entered, make sure you have inserted a tape into the DVD/VCR Receiver. The DVD/VCR Receiver is now set to record the preset programs.

### Notes

- If the power fails or the DVD/VCR Receiver is unplugged from the AC outlet, the correct clock time and timer settings are kept in memory for approximately 3 seconds. After 3 seconds, the clock and program timer must be reset when power is restored. Reset the clock according to instructions.
- After setting up a timer recording, recording will start if no other timer recordings are scheduled to occur at the same time (see "Program Priority" at right).
- The timer recording will not start during other program is recording.

### Program Priority

Do not overlap programs, since overlapping portions of the conflicting programs will not be recorded. Earlier recording times have priority over later recording times as shown in the diagram.

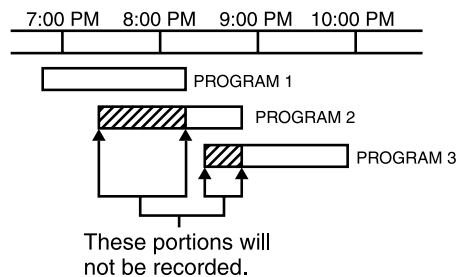

## Checking, Editing or Erasing Timer Record Programming

Programming can be checked whenever the DVD/VCR Receiver is turned on.

- 1 Press **SETUP/MENU** and the **MAIN** menu will appear.
- 2 Use  $\uparrow/\downarrow$  to select the **PROGRAM** menu. Press **ENTER** and the **PROGRAM** menu will appear.

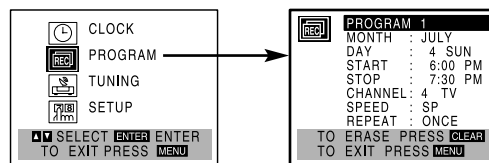

- 3 Use  $\leftarrow/\rightarrow$  to select a program you want to check, edit or erase. To edit the data, use  $\uparrow/\downarrow$  option to edit then edit it using  $\leftarrow/\rightarrow$ . To erase the program, press **CLEAR** on **PROGRAM** number is selected.
- 4 Press **SETUP/MENU** to return to the TV screen.

## VIDEO Operation (Continued)

### Instant Timer Recording (ITR)

Instant Timer Recording allows you to make a recording easily of a preset length without using the programmable timer.

#### Preparation:

- Turn on the power of both the DVD/VCR Receiver and the TV.
- Be sure the TV is set to the DVD/VCR Receiver output channel (CH3 or CH4).
- If a direct VIDEO/AUDIO connection is made between the DVD/VCR Receiver and the TV, set the TV's source selector to VIDEO.

- 1 Insert a video cassette with the safety tab intact.**
- 2 Select the desired channel with CH/PRESET (+/-) or number (0-9) buttons.**

The channel number appears on the TV screen.

  - If you are recording from another source via audio/video input jacks (at the Rear or Front panel), select LINE 1 (L1) or LINE 2 (L2).
- 3 Select the desired recording speed (SP or EP) with the SP/EP button.**

The tape speed will appear on the TV screen.
- 4 Press ● REC/ITR twice.**

The menu as illustrated, will appear on the TV screen.

  - Recording will start. (The TIMER indicator will light)
- 5 Press ● REC/ITR repeatedly to select the recording time length.**

At the end of the recording, the DVD/VCR Receiver will stop recording and shut off.

  - During Instant Timer Recording, changing the channel on the DVD/VCR Receiver will not be possible.
  - Press ■ (STOP) to stop recording.

#### INSTANT TIMER RECORD MENU

INSTANT TIMER RECORD	
CHANNEL	2
SPEED	SP
START LENGTH	NOW 0H30M

0H30M ..... 9H00M → 0H00M  
↑  
Length Display  
(each additional press of  
● REC/ITR increases recording  
time 30 minutes)

### Checking the Recording Time

Press ● REC/ITR once to check the recording time. The recalled setting will automatically return to the TV screen after 6 seconds.

### To extend the Recording Time

The recording time can be extended anytime by pressing ● REC/ITR.

Subsequent presses result in advancing the recording time by 30-minute increments.

#### Notes

- If you press ■ (PAUSE) during instant timer recording, the DVD/VCR Receiver will enter the recording pause mode. Instant timer recording is cancelled.
- If the DVD/VCR Receiver is set to "0H00M", the DVD/VCR Receiver goes to normal recording mode.

### Dubbing and Editing

If you wish to edit or dub your camcorder (or another VCR) recordings to this DVD/VCR Receiver, the rear or Front panel mounted Audio and Video (A/V) input jacks make the connections quick and easy. These direct A/V jacks will also provide better picture results than using the RF jack on the rear panel.

- 1 Connect the camcorder's (or another VCR's) A/V outputs to your DVD/VCR Receiver as illustrated on page 14.**
- 2 Insert a video cassette with the safety tab intact.**
- 3 Select the appropriate input mode on the DVD/VCR Receiver by pressing INPUT SELECT.**

LINE1 (L1) is for VIDEO 1 on the rear panel.  
LINE2 (L2) is for VIDEO 2 on the front panel.
- 4 Play the tape in the camcorder (or another VCR). If you have a TV attached to your DVD/VCR Receiver, you can see the video playing.**
- 5 When you desire the recording to begin, press DVD/VCR Receiver's ● REC/ITR to start.**
- 6 Press ■ (STOP) to stop recording.**

#### Note

Before recording, please confirm the recording start position.

### Copying from DVD to VIDEO

This unit allows you to copy the contents of a DVD to a VHS tape.

- 1 Insert the disc you wish to copy in the DVD deck and close the disc tray.**
- 2 Insert a video cassette with the safety tab intact.**
- 3 Press ▷ (PLAY) on the DVD deck.**

The DVD will go into play mode

  - If the DVD disc menu appears, you may need to press the ▷ (PLAY) manually to begin copying.
- 4 Press ● REC/ITR.**

The DVD/VCR Receiver will go into Record mode.
- 5 Stop the Copy Process.**

When the DVD is finished playing, press ■ (STOP) to end the copy.

You must stop the Copy process manually when the DVD movie ends, or the unit may replay and record over and over again.

#### Notes

- If the DVD you are attempting to copy is copy protected, you will not be able to copy the disc. It is not permitted to copy Macrovision encoded DVDs. "LOCK" and "DISC IS COPY PROTECTED" will appear in the display window and TV screen.
- When you stop the DVD playback during copying, VCR recording mode also stops automatically.
- You must set Progressive Scan to Off to copy process.

## VIDEO Operation (Continued)

### VHS Hi-Fi Stereo System/MTS Broadcast

This DVD/VCR Receiver is equipped with the VHS Hi-Fi audio sound system for recording and playback. The information below gives a brief description of Hi-Fi audio and how to record and play a tape in the Hi-Fi audio mode.

### Playback with Hi-Fi Stereo Audio Sound

A stereo TV with AUDIO/VIDEO input jacks or a stereo audio system is required for true stereo playback. To experience the full and rich stereo sound available with Hi-Fi recorded tapes, we recommend the connection of this unit to a home stereo audio system.

- 1** Insert a prerecorded video cassette with Hi-Fi stereo audio.
- 2** Press **SETUP/MENU** and the **MAIN** menu will appear.
- 3** Use **▲/▼** to select the **SETUP** menu then press **ENTER** to go to the **SETUP** menu.
- 4** Set the **AUDIO MODE** option to **HI-FI** on the **SETUP** menu.

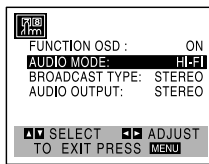

- 5** Set the **AUDIO OUTPUT** option to **STEREO** position.

**STEREO:** The left channel sound (L) is heard from the left speaker and the right channel sound (R) is heard from the right speaker.

**LEFT:** The left channel sound (L) is heard from both speakers.

**RIGHT:** The right channel sound (R) is heard from both speakers.

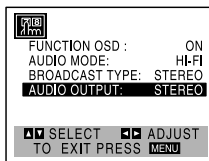

- 6** Press **SETUP/MENU**.

- 7** Press **▷** (**PLAY**).  
Adjust volume at your stereo system.

### MTS (Multi-Channel TV Sound)

This DVD/VCR Receiver will decode MTS stereo and bilingual (SAP) off-the-air broadcast sound signals. It also decodes stereo TV sound from local cable companies, as long as they operate on assigned cable frequencies and use the EIA-recommended MTS stereo/bilingual TV sound system.

### Multichannel TV Sound Indicator (MTS)

Shows onscreen as illustrated below when **ENTER** is pressed.

- One or both of the indicators will light, depending on the MTS broadcast.

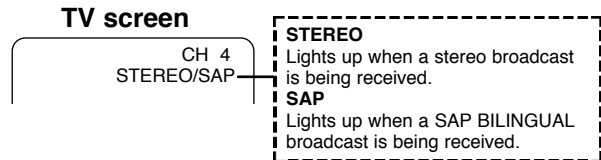

#### If only **STEREO** appears on the TV screen.

The DVD/VCR Receiver can record in stereo onto the VHS Hi-Fi audio tracks when the **BROADCAST TYPE** option is in the **STEREO** position. The DVD/VCR Receiver will also record mono audio onto the mono audio track.

#### If only **SAP** appears on the TV screen.

Set the **BROADCAST TYPE** option to **SAP**.

#### If **STEREO/SAP** appears on the TV screen

Use the **BROADCAST TYPE** option to select the desired recording mode (**STEREO** or **SAP**).

### SAP (Second Audio Program) Recording

Some stations transmit a Second Audio Program, which is used for a second language or additional information. When the station broadcasts a Second Audio Program, follow the procedure below to record the SAP.

- 1** Insert a video cassette with the safety tab intact.
- 2** Press **SETUP/MENU** and the **MAIN** menu will appear.
- 3** Use **▲/▼** to select the **SETUP** menu then press **ENTER** to go to the **SETUP** menu.
- 4** Set the **BROADCAST TYPE** option to **SAP** on the **SETUP** menu.  
Do this if only the **SAP** appears on the TV screen or you know the program will use the **SAP**.

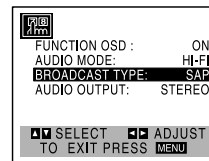

- 5** Press **SETUP/MENU**.

- 6** Select the desired recording speed (**SP** or **EP**) with the **SP/EP** button.

- 7** Select the desired channel. **SAP** should appear on the TV screen.

- 8** Press **● REC/ITR** once.

You are now recording the program you see and hear on the TV.

- 9** Press **■ (STOP)** to stop recording.

## VIDEO Operation (Continued)

### Tape Counter Memory Feature

#### Real-Time Counter

Shows length of tape run in hours, minutes, and seconds. Press CLK/CNT to select the real-time counter display.

Every press of CLK/CNT changes the TV screen as illustrated below.



- Counter changes to "0:00:00" when the cassette is ejected.
- The real-time counter does not operate if nothing is recorded on the tape.
- The real-time counter will not work unless a tape is inserted.

#### Note

During the "L1 OPT" mode, the OSD(On Screen Display) can not be changed.

### Counter Memory Feature

This is useful if there is a section of tape you want to view immediately after recording or if you want to return to the same point several times.

- 1** Begin recording or playing a tape.
- 2** Press CLK/CNT repeatedly to display the real-time counter on the TV screen.
- 3** At the point that you want to locate later, reset the real-time counter to "0:00:00" by pressing CLEAR.
- 4** Continue to play or record.
- 5** Press ■ (STOP) when recording or playback finishes.
- 6** Press ◀◀. The tape automatically stops when the tape counter returns to about "0:00:00".

### Tape Remaining

This function shows the remaining time on the tape during recording or playback.

Press CLK/CNT repeatedly until the REM indicator appears on the TV screen during recording or playback.

#### Note

The remaining tape length indicator may not be displayed correctly depending on the condition of the tape and the kind of the tape (T-140, T-160, or T-210 etc)

### Additional Information

- In manual recording, Timer recording, Instant Timer Recording, playback, or fast forward modes, the DVD/VCR Receiver automatically starts rewinding the tape at the end of the tape. The cassette will stop at the beginning of the tape and be ejected, and the DVD/VCR Receiver will turn itself off.
- After you have finished using the DVD/VCR Receiver, rewind, eject, and remove the cassette. Place the cassette in its protective sleeve to protect it from dust. It is not necessary to rewind the cassette before removing it, but if you do, it will be ready to play or record the next time you use it.
- Be sure the DVD/VCR Receiver Channel Selector is on the correct channel you wish to record. The channel that is being recorded can always be checked by tuning the television to the DVD/VCR Receiver channel (3 or 4) and pressing the TV/VIDEO button to set the DVD/VCR Receiver to VIDEO mode (VCR MODE appears in the display window).
- Do not attempt to hook up more than one television set to the DVD/VCR Receiver for either recording or playback.

### Auto Play System

This DVD/VCR Receiver features automatic playback. Load a cassette (with the safety tab removed).

- The power turns on automatically and playback begins.

#### Note

If you insert the tape during the DVD/VCR Receiver is set to DVD function mode, the Output Source is changed to VIDEO function mode automatically.

- At the end of the tape, the DVD/VCR Receiver stops and rewinds the tape.
- The cassette is ejected after rewinding and the VIDEO turns itself off automatically.

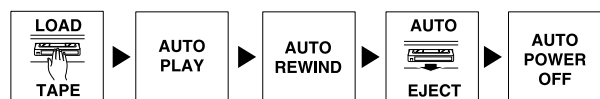

#### Note

Auto power off does not function during regular DVD play mode. (DVD/VCR Receiver power stays on.)

## DVD and Video CD Operation

### Playing a DVD and Video CD

#### Playback Setup **DVD** **VCD2.0** **VCD1.1**

- Turn on the TV and select the video input source connected to the DVD/VCR Receiver.
- Audio system: Turn on the audio system and select the input source connected to the DVD/VCR Receiver.
- Set the Output Source to DVD as shown in Selecting the Output/Input Source on page 15.

**1** Press **≡** DVD to open the disc tray.

**2** Place a disc on the tray, with the label facing up. When a double-sided DVD is inserted, make sure the side you want to play is facing down.

**3** Press **≡** DVD to close the tray. "READING" appears in the display window, and playback starts automatically. If playback does not start, press **▷** (PLAY).  
In some cases, the disc menu might appear instead.

#### If a menu screen is displayed

A menu screen may appear automatically after loading a DVD.

#### **DVD**

Use **◀/▶/▲/▼** buttons to select the title/chapter you want to view, then press ENTER to start playback. Press DVD TOP MENU or DVD MENU to return to the menu screen.

#### **VCD2.0**

- Use the number buttons to select the track you want to view. Press RETURN to return to the menu screen.
- Menu setting and the exact operating procedures for using the menu may differ depending on the disc. Follow the instructions on the each menu screen. You also may set PBC to Off under setup. See page 22.

#### Notes

- If Parental Control is set and the disc is not within the Rating settings (not authorized), the 4-digit password must be entered and/or the disc must be authorized (see Parental Control, on page 23).
- DVDs may have a Region Code.
- Your DVD/VCR Receiver will not play discs that have a Region Code different from your DVD/VCR Receiver. The Region Code for this DVD/VCR Receiver is 1 (one).
- Do not keep a fixed image displayed on the screen for a long time.

### General Features

#### Note

Unless stated otherwise, all operations described use the remote control. Some features may also be available on the Setup menu.

#### Resuming Playback **DVD** **VCD2.0** **VCD1.1** **CD**

When you stop the disc, the player remembers the point where you pressed **■** (STOP) and "RESUME **■**" appears on the TV screen. Press **▷** (PLAY) and play will resume from this point.

#### Tip

To play from the beginning of the disc, press **■** twice, then press **▷**.

#### Notes

- Depending on where you stopped the disc, the recorder may not resume playback from exactly the same point.
- The point where you stopped playing is cleared when:
  - Press **■** in the STOP mode.

#### Selecting Another TITLE **DVD** 1/3

If a disc has more than one title, you can select another title as follows:

- Press DVD DISPLAY, then press the appropriate number buttons (0-9), then use ENTER to select a title number.
- Press DVD DISPLAY, then use **◀/▶** to select a title number, then press ENTER.

#### Selecting Another CHAPTER/TRACK

#### **DVD** **VCD2.0** **VCD1.1** 1/12 1/3

If a title on a disc has more than one chapter or a disc has more than one track, you can move to another chapter/track as follows:

- Press **◀◀** or **▶▶** briefly during playback to return to the beginning of the current chapter/track or to select the next chapter/track.
- Press **◀◀** twice briefly to step back to the previous chapter/track.
- To go directly to any chapter during playback, press DVD DISPLAY. Use **▲/▼** to select chapter/track icon. Then, enter the chapter/track number with the number buttons (0-9) or use **◀/▶** to select chapter. Then, press ENTER.

#### Notes

- For two-digit numbers, press the number buttons (0-9) in rapid succession.
- On a Video CD with PBC, you must set PBC to Off on the setup menu to use this function. See page 22.

#### Search **DVD** **VCD2.0** **VCD1.1**

- 1 Press **◀◀** or **▶▶** for about two seconds during playback. The DVD/VCR Receiver will now go into SEARCH mode.
- 2 Press **◀◀** or **▶▶** repeatedly to select the required speed: X2 **◀**, 1 **◀◀**, 2 **◀◀**, 3 **◀◀** (backward) or X2 **▶**, 1 **▶▶**, 2 **▶▶**, 3 **▶▶** (forward).  
With a Video CD, the Search speed changes: 1 **◀◀**, 2 **◀◀**, 3 **◀◀** (backward) or 1 **▶▶**, 2 **▶▶**, 3 **▶▶** (forward).
- 3 To return to playback, press **▷** (PLAY).

#### Still Picture **DVD** **VCD2.0** **VCD1.1**

- 1 Press **⏸** (PAUSE) during playback. The DVD/VCR Receiver will go into PAUSE mode.
- 2 To return to playback, press or **⏸** (PAUSE) again or **▷** (PLAY).

## DVD and Video CD Operation (Continued)

### General Features (Continued)

#### Slow Motion **DVD** **VCD2.0** **VCD1.1**

- 1 Press **II** (PAUSE) during playback.  
The DVD/VCR Receiver will now go into PAUSE mode.
- 2 Press SLOW **◀** or **▶** during pause mode.  
The DVD/VCR Receiver will enter SLOW mode.
- 3 Use SLOW **◀** or **▶** to select the required speed:  
4 **◀**, 3 **◀**, 2 **◀** or 1 **◀** (backward), or 4 **▶**, 3 **▶**, 2 **▶** or 1 **▶** (forward).
- 4 To return to playback, press **▷** (PLAY).

#### Note

Slow motion playback in reverse is not applicable for Video CD.

#### Shuffle **Karaoke DVD** **VCD2.0** **VCD1.1**

- 1 Press SHUFFLE during playback or in Stop mode.  
The unit automatically begins Shuffle Playback and "SHUFFLE" appears on the TV screen.
- 2 To return to normal playback, press SHUFFLE until "NORMAL" appears on the TV screen.

#### Tip

By pressing **▶▶** during Shuffle playback, the unit selects another title (track) and resumes Shuffle playback.

#### Notes

- This function only works with DVD Karaoke discs and Video CD without PBC.
- On a Video CD with PBC, you must set PBC to Off on the setup menu to use the Shuffle function. See page 22.
- After finishing the Shuffle playback mode, Shuffle function is canceled.

#### Repeat **DVD** **VCD2.0** **VCD1.1**

##### DVD Video Discs - Repeat Chapter/Title/Off

- 1 Press REPEAT when playing a disc.  
The Repeat icon appears on the TV screen.
- 2 Press REPEAT to select a desired repeat mode.



- CHAPT: repeats the current chapter.
- TITLE: repeats the current title on a disc.
- OFF: does not play repeatedly.

##### Video CDs - Repeat Track/All/Off

- 1 Press REPEAT when playing a disc.  
The Repeat icon appears on the TV screen.
- 2 Press REPEAT to select a desired repeat mode.



- TRACK: repeats the current track
- ALL: repeats all the tracks on a disc.
- OFF: does not play repeatedly.

#### Notes

- On a Video CD with PBC, you must set PBC to Off on the setup menu to use the Repeat function. See page 22.
- By pressing **▶▶** during Random playback, the unit selects another title and resumes Random playback.
- When you press **◀◀** twice or **▶▶** during Repeat mode to go to previous track or next track, repeat mode is canceled.

#### Repeat A-B **DVD** **VCD2.0** **VCD1.1**



To repeat a sequence in a title(track):

- 1 During disc playback, Press A-B at your chosen start point.  
"A \* " appears briefly on the TV screen.
- 2 Press A-B again at your chosen end point.  
"A B" appears briefly on the TV screen, and the repeat sequence begins.
- 3 To cancel the sequence and return to normal play, press A-B.

#### Note

Repeat A-B play may not work with some scene of the DVD.

#### Time Search **DVD**



The Time Search function allows you to start playing at any chosen time on the disc.

- 1 Press DVD DISPLAY during playback. The on-screen display appears on the screen.  
The Time Search box shows the elapsed playing time of the current disc.
- 2 Within 10 seconds, use **▲/▼** to select the Time Search icon in the on-screen display.  
The "-:-:-" appears in the Time Search box.
- 3 Within 10 seconds, use the number buttons to enter the required start time. Enter hours, minutes and seconds from left to right in the box.  
If you enter the wrong numbers, press CLEAR to remove the numbers you entered. Then enter the correct numbers.
- 4 Within 10 seconds, press ENTER.  
Playback starts from the selected time on the disc. If you enter an invalid time, playback will continue from the current point.

#### 3D Surround **DVD** **VCD2.0** **VCD1.1**



This unit can produce a 3D Surround effect, which simulates multi-channel audio playback from two conventional stereo speakers, instead of the five or more speakers normally required to listen to multi-channel audio from a home theater system.

- 1 Press SOUND FIELD to select "3D SUR" during playback.
- 2 To turn off the 3D Surround effect, press SOUND FIELD again to select "AUTO".

#### Note

On DVD, you can select "3D SUR" only during playing 2 channel audio.

## DVD and Video CD Operation (Continued)

### General Features (Continued)

#### Changing Video Mode

- With certain discs, the playback picture may be flickering or Dot Crawl is shown on straight lines. That means Vertical interpolation or De-interlace is not perfectly matched with the disc. In this case, the picture quality may be improved by changing the video mode.
- To change the video mode, press and hold DVD DISPLAY about 3 seconds during disc playback. The new video mode number selected is displayed on the TV screen. Check whether the video quality has improved. If not, repeat the above procedure until picture quality is improved.
- Video mode sequence:  
MODE1 → MODE2 → MODE3 → MODE1
- If you turn off the power, the video mode will return to initial default state (MODE1).

#### Detailed Description of each Video Mode

**MODE1** : The source material of the DVD video (film material or video material) is determined from disc information.

**MODE2** : Suitable for playing film based content or video based material recorded by the progressive scan method.





**MODE3** : Suitable for playing video based content with comparatively little motion.

#### Note

The video mode setting only works when the Progressive Scan mode is set to "On" in the Setup menu.

### Special DVD Features

#### Checking the contents of DVD Video discs: Menus

DVDs may contain menus that allow you to access special features. To use the disc menu, press DVD DISPLAY. Then, press the appropriate number button to select an option. Or, use / / /  buttons to highlight your selection, then press ENTER.

#### Title Menu

- 1 Press DVD TOP MENU.

If the current title has a menu, the menu will appear on the screen. Otherwise, the disc menu may appear.

- 2 The menu can list camera angles, spoken language and subtitle options, and chapters for the title.
- 3 To remove the title menu, press DVD TOP MENU again.

#### DVD Menu

- 1 Press DVD MENU.

The disc menu is displayed.

- 2 To remove the disc menu, press DISC MENU again.

#### Camera Angle 1/1

If the disc contains sequences recorded from different camera angles, the angle icon appears on the TV screen. You can then change the camera angle if you wish.

- Press ANGLE repeatedly during playback to select a desired angle.  
The number of the current angle appears on the display.

#### Changing the Audio Language



Press AUDIO repeatedly during playback to hear a different audio language or audio track.

#### Changing the Audio Channel



Press AUDIO repeatedly during playback to hear a different audio channel (ST, LEFT or RIGHT).

#### Subtitle 1 ENG

Press SUBTITLE repeatedly during playback to see the different subtitle languages.

#### Note

If  appears, the feature at that moment or with that specific DVD.

#### Screen Saver

The screen saver picture appears when you leave the DVD/VCR Receiver in Stop mode for about 5 minutes.



## Audio CD and MP3 Disc Operation

### Playing an Audio CD and MP3 Disc

The DVD/VCR Receiver can play MP3 formatted recordings on CD-ROM, CD-R or CD-RW discs. Before playing MP3 disc, read the notes on MP3 files on right.

#### 1 Insert a disc and close the tray.

**Audio CD:** Audio CD menu appears on the TV screen go to step 4.

**MP3 disc:** The MP3/JPEG select menu appears on the TV screen. Go to step 2



#### 2 Use $\uparrow/\downarrow$ to select the MP3 then press ENTER.

The MP3 disc Menu appears on the TV screen. Press RETURN to move to the MP3/JPEG select menu.

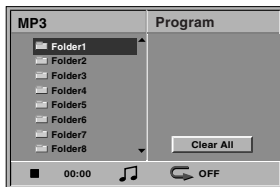

#### 3 Use $\uparrow/\downarrow$ to select a folder, and ENTER.

A list of files in the folder appears.

If a list of files contains another folder, repeat step 3 once more.

#### Tip

If you are in a file list and want to return to the Folder list, use the  $\uparrow/\downarrow$  to highlight  $\square$  and press ENTER to return to the previous menu screen.

#### 4 Use $\uparrow/\downarrow$ to select a track then press $\triangleright$ (PLAY) or ENTER.

Playback starts.

During playback, the current track's elapsed playing time will appear in the display window and menu.

Playback will stop at the end of the disc.

Press DVD TOP MENU to move to the next page.

Press DVD MENU to move to the previous page.

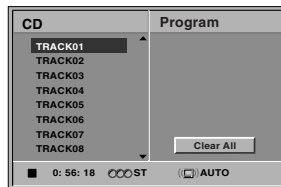

Audio CD Menu

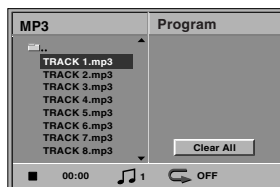

MP3 disc Menu

#### 5 press $\blacksquare$ (STOP) to stop playback.

### Notes on MP3 Files

#### About MP3

- An MP3 file is audio data compressed by using the MPEG1 audio layer-3 file-coding scheme. We call files that have the ".mp3" file extension "MP3 files".
- The DVD/VCR Receiver can not read an MP3 file that has a file extension other than ".mp3".

#### MP3 Disc compatibility with this DVD/VCR Receiver is limited as follows:

- Sampling Frequency : only at 44.1kHz
- Bit rate : within 32 - 320kbps
- CD-R physical format should be "ISO 9660"
- If you record MP3 files using the software which cannot create a FILE SYSTEM, for example "UDF" etc., it is impossible to playback MP3 files. We recommend that you use an ISO9660 file system.
- A single session disc requires MP3 files in the first track. If there is no MP3 file in the 1st track, it cannot playback MP3 files. If you wish to playback MP3 files, format all the data in the disc or use a new one.
- File names should be named using 8 letters or less and must incorporate ".mp3" extension e.g. "\*\*\*\*\*.mp3".
- Do not use special letters such as "/ : \* ? < >" etc.
- Total number of files on the disc should be less than 650.

This DVD/VCR Receiver requires discs/recordings to meet certain technical standards in order to achieve optimal playback quality. Pre-recorded DVDs are automatically set to these standards. There are many different types of recordable disc formats (including CD-R containing MP3 files). That require certain pre-existing conditions (see above) to insure compatible playback.

**Customers should also note that permission is required in order to download MP3 files and music from the Internet. Our company has no right to grant such permission. Permission should always be sought from the copyright owner.**

## Audio CD and MP3 Disc Operation (Continued)

### Pause **CD** **MP3**

- 1 Press **II** (PAUSE) during playback.
- 2 To return to playback, press **II** (PAUSE) again or press **▷** (PLAY).

### Selecting Another Track **CD** **MP3**

If a disc has more than one track, you can move to another track as follows:

- Press **◀◀** or **▶▶** briefly during playback to go to the next track or to return to the beginning of the current track.
- Press **◀◀** twice briefly to step back to the previous track.
- On Audio CDs, to go directly to any track, enter the track number using the number buttons (0-9) during playback.

#### Note

For two-digit numbers, press the number buttons (0-9) in rapid succession.

### Search **CD** **MP3**

- 1 Press **◀◀** or **▶▶** for about two seconds during playback.  
The DVD/VCR Receiver will now go into SEARCH mode.
- 2 Press **◀◀** or **▶▶** repeatedly to select the required speed: 1 **◀◀**, 2 **◀◀**, 3 **◀◀** (backward) or 1 **▶▶**, 2 **▶▶**, 3 **▶▶** (forward).  
Search speed and direction are indicated on the menu screen.
- 3 To return to playback, press **▷** (PLAY).

### Shuffle **CD** **MP3**

- 1 Press SHUFFLE during playback or in Stop mode.  
The unit automatically begins Shuffle Playback and "SHUFFLE" and "SHUF" appears in the display window and menu screen.
- 2 To return to normal playback, press SHUFFLE repeatedly until "SHUFFLE" and "SHUF" disappears from the display window and menu screen.

#### Tip

By pressing **▶▶** during Shuffle playback, the unit selects another track and resumes Shuffle playback.

#### Note

After finishing the Shuffle playback mode, Shuffle function is canceled.

### Repeat **CD** **MP3**

- 1 Press REPEAT when playing a disc.  
The Repeat icon appears on the TV screen.
- 2 Press REPEAT to select a desired repeat mode.



- TRACK: repeats the current track
- ALL: repeats all the tracks on a disc.
- OFF: does not play repeatedly.

#### Note

When you press **◀◀** twice or **▶▶** during Repeat mode to go to previous track or next track, repeat mode is canceled.

### Repeat A-B **CD**

To repeat a sequence in a track.

- 1 During disc playback, press A-B at your chosen starting point.  
The Repeat icon and "A \* " appears on the menu screen.
- 2 Press A-B again at your chosen end point.  
"A B" appears on the menu screen, and the repeat sequence begins.
- 3 To cancel the sequence and return to normal play, press A-B again.  
The Repeat icon and "OFF" appears on the menu screen.

### 3D Surround **CD**

This unit can produce a 3D Surround effect, which simulates multi-channel audio playback from two conventional stereo speakers, instead of the five or more speakers normally required to listen to multi-channel audio from a home theater system.

- 1 Press SOUND FIELD to select "3D SUR" during playback.
- 2 To turn off the 3D Surround effect, press SOUND FIELD again to select "AUTO".

### Changing the Audio Channel **CD**

Press AUDIO repeatedly during playback to hear a different audio channel (ST, LEFT, or RIGHT).

## JPEG File Operation

### Viewing JPEG Files on a Disc **JPEG**

This DVD/VCR Receiver can play discs with JPEG files. Before playing JPEG files, read the notes on JPEG Files on right.

- 1 Insert a disc and close the tray.**  
The MP3/JPEG select menu appears on the TV screen.

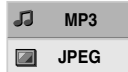

- 2 Use  $\uparrow/\downarrow$  to select the JPEG then press ENTER.**  
The JPEG menu appears on the TV screen.



- 3 Use  $\uparrow/\downarrow$  to select a folder, and ENTER.**  
A list of files in the folder appears.  
Press RETURN to move to the MP3/JPEG select menu.

#### Tip

If you are in a file list and want to return to the Folder list, use the  $\uparrow/\downarrow$  buttons on the remote to highlight “ $\dots$ ” and press ENTER to return to the previous menu screen.

- 4 Use  $\uparrow/\downarrow$  to select a file then press ENTER or  $\triangleright$  (PLAY).**  
Viewing the file function starts.  
While viewing a file, press RETURN to move to the previous menu (JPEG menu).  
Press DVD TOP MENU to move to the next page.  
Press DVD MENU to move to the previous page.

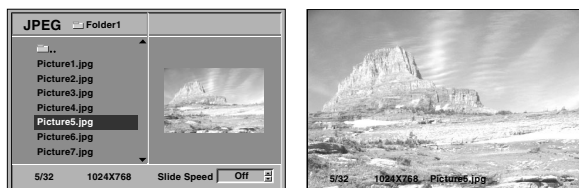

#### Tip

There are three viewing Slide Speed options: Fast, Normal, Slow, and Off. Use  $\leftarrow/\rightarrow$  to highlight the Slide Speed then use  $\uparrow/\downarrow$  to select the option you want to use, and press ENTER.

- 5 Press  $\blacksquare$  (STOP) to stop viewing.**  
The JPEG menu appears.

### Selecting another Files

Press  $\lll$  or  $\ggg$  once while viewing a picture to advance to the next file or to the previous file.

### Still Picture

- Press  $\|\|$  (PAUSE) during slide show.  
The DVD/VCR Receiver will now go into PAUSE mode.
- To return to the slide show, press  $\triangleright$  (PLAY) or  $\|\|$  (PAUSE) again.

### To flip the picture

Press  $\uparrow/\downarrow$  while showing a picture to flip the picture horizontally or a vertically.

### To rotate picture

Press  $\leftarrow/\rightarrow$  while showing a picture to rotate the picture clockwise or counter clockwise.

### To record the picture slide show

Press  $\bullet$  REC/ITR to record.

### Notes on JPEG Files

- Depending upon the size and number of the JPEG files, it could take a long time for the DVD/VCR Receiver to read the disc's contents. If you don't see an on-screen display after several minutes, some of the files are too big — reduce the resolution of the JPEG files to less than 2 mega pixels and burn another disc.
- Total number of files and folders on the disc should be less than 650.
- Some disc may be incompatible due to different recording format or condition of disc.
- If the files have “.jpe” or “.jpeg” extensions, please rename them as “.jpg” files.
- File names without “.jpg” extension will not be able to be read by this DVD/VCR Receiver, even though the files are shown as JPEG image files in windows explorer.

## Programmed Playback with Audio CD and MP3 Disc

The Program function enables you to store your favorite tracks from any disc in the DVD/VCR Receiver memory.

Program can contain 30 tracks.

### 1 Press PROGRAM during playback or in the stop mode to enter the Program Edit mode.

The  mark will appear to the right of the word Program on the right side of the menu screen.

#### Note

Press PROGRAM to exit the Program Edit mode; the  mark will disappear.

### 2 Select a track, then press ENTER to place the selected track on the Program list.

### 3 Repeat step 2 to place additional tracks on the Program list.

Audio CD menu

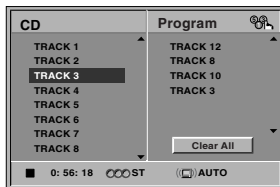

MP3 disc Menu

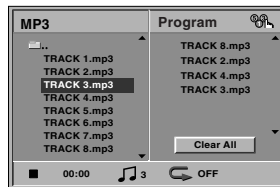

### 4 Press →.

The programmed track you selected last is highlighted on the program list.

### 5 Press ↑/↓ to select the track you want to start playing.

Press DVD TOP MENU to move to the next page.  
Press DVD MENU to move to the previous page.

### 6 Press ▷ (PLAY) or ENTER to start.

Playback begins in the order in which you programmed the tracks and "PGM" appears on the menu screen. Playback stops after all of the tracks on the Program list have played once.

### 7 To return normal playback from programmed playback, press PROGRAM to exit the Program Edit mode. Select a track of CD (or MP3) list and then press ENTER or ▷ (PLAY).

"PGM" indicator disappears in the display window.

## Programmed Playback with Video CD

#### Note

On a Video CD with PBC, you must set PBC to Off on the setup menu to use the Program function. See page 22.

### 1 Insert Video CD and close the tray.

### 2 Press PROGRAM while playback is stopped.

The VCD Program menu will appear.

#### Note

Press RETURN, PROGRAM or ▷ (PLAY) to exit the Program menu.

### 3 Follow steps 2-6 of "Programmed Playback with Audio CD and MP3 disc" on left.

"PGM" and "PROGRAM" appears in the display window and TV screen.

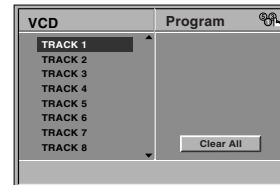

### 4 To return normal playback from programmed playback, press PROGRAM.

"PGM" indicator disappears in the display window.

## Repeat Programmed Tracks

- 1 Press REPEAT when playing the programmed tracks. The Repeat icon appears on the TV screen.
- 2 Press REPEAT to select a desired repeat mode.



- TRACK: repeats the current track
- ALL: repeats all tracks on the program list.
- OFF: does not play repeatedly.

## Erasing a Track from Program List

- 1 Press PROGRAM during playback (Audio CD and MP3 disc only) or stop to enter the Program Edit mode. The  mark will appear.
- 2 Press → to move to the Program list.
- 3 Use ↑/↓ to select the track that you wish to erase from the Program list.
- 4 Press CLEAR. The track will be erased from the Program list.

## Erasing the whole Program List

- 1 Follow steps 1-2 of "Erasing a Track from Program List" as above.
- 2 Use ↑/↓ to select "Clear All", then press ENTER. The complete Program for the disc will be erased.

#### Notes

- The programs are cleared when the disc is removed.
- The programs are cleared when another function mode (VIDEO, radio etc.) is selected.

## Speaker Setup

You can set your personal preferences on the DVD function mode.  
Adjust the following settings for the built-in 5.1 channel surround decoder.

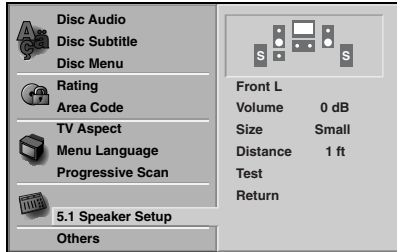

- 1 Press SETUP/MENU.**  
The Setup menu appears.
- 2 Select “5.1 Speaker Setup” using the  $\uparrow/\downarrow$  buttons on the setup menu.**
- 3 While “5.1 Speaker Setup” is selected, press  $\rightarrow$  button.**
- 4 Press  $\rightarrow$  buttons to select the desired speaker.**
- 5 Adjust options by using  $\uparrow/\downarrow/\leftarrow/\rightarrow$  buttons.**

### Speaker selection

Select a speaker that you want to adjust. ((Front speaker (Left), Front speaker (Right), Center Speaker, Surround speaker (Left), Surround speaker (Right), or Subwoofer))

#### Note

Certain speaker settings are prohibited by the Dolby Digital licensing agreement.

### Volume

Press  $\leftarrow / \rightarrow$  to adjust the output level of the selected speaker. (-6dB ~ 6dB)

### Size

Since the speaker settings are fixed, you cannot change the settings.

- Subwoofer's size is fixed "Large" and the other speaker's size are fixed "small".

### Distance

If you connected speakers to your DVD/VCR Receiver, setting the Distance lets the speakers (except subwoofer) know how far the sound has to travel to reach your set listening point. This allows the sound from each speaker to reach the listener at the same time.  
(1 - 20 ft, 1 ft = 0.30 m)

#### Note

You can not set the distance of subwoofer speaker.

### Test

Press ENTER to test the signals of each speaker.  
Adjust the volume to match the volume of test signals memorized in the system.

- Front L (Left)  $\rightarrow$  Center  $\rightarrow$  Front R (Right)  $\rightarrow$  SURROUND R (Right)  $\rightarrow$  SURROUND L (Left)  $\rightarrow$  Sub Woofer

You can stop the test using  $\uparrow/\downarrow$ .

### Return

Press ENTER to return to the previous menu.

## Radio Operation

### Presetting the Radio Stations

You can preset 50 stations for FM and AM. Before tuning, make sure that you have turned down the volume.

- 1 Press **TUNER FM/AM** on the remote control or on the front panel until the frequency band appears on the display and TV screen.

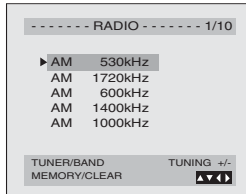

- 2 Press **CH/PRESET (+/-)** on the remote control or front panel to select the desired Station. If you select a blank column, R-SKIP appears in the display window.

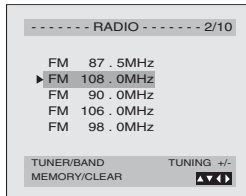

- 3 Press **TUNER FM/AM** on the remote control or front panel to select the desired band.
- 4 Press **TUNING (+/-)** on the remote control to search station.
- 5 Press **MEMORY** on the remote control. The station is stored.

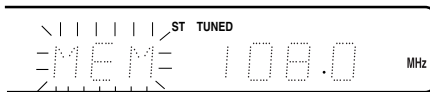

- 6 Repeat steps 2 to 5 to store other stations.

### Listening to the Radio

Preset radio stations in the DVD/VCR Receiver memory first (see "Presetting Radio Stations" on the left).

- 1 Press **TUNER FM/AM** on the remote control or on the front panel until the frequency band appears on the display and TV screen.

The last received station is tuned in.

- 2 Press **CH/PRESET (+/-)** on the remote control or front panel repeatedly to select the preset station you want.

Each time you press the button, the DVD/VCR Receiver tunes in one preset station at a time.

- 3 Adjust the volume by rotating **VOLUME** on the front panel or by pressing **VOL (+/-)** on the remote control repeatedly.

### To Clear the Stored Radio Stations

- 1 Press **TUNER FM/AM** on the remote control or on the front panel until the frequency band appears on the display and TV screen.

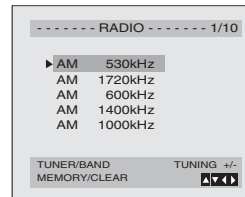

- 2 Press **CH/PRESET (+/-)** on the remote control or front panel to select your desired station.

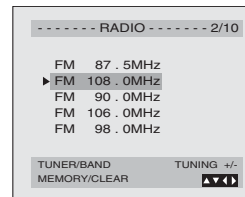

- 3 Press **CLEAR** the remote control to clear the stored radio station.

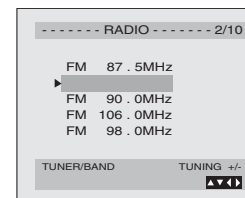

#### Note

While record or record pause mode, the CLEAR function may not be operated.

## Radio Operation (Continued)

### For your reference

#### Weak FM stations

“ST” and “TUNED” may flash when the weak FM stereo signal is received, select another station.

#### To turn off the radio

Press **I** / **⏻** to turn the DVD/VCR Receiver off or select another function mode (DVD, VIDEO, etc).

#### To improve reception

Realign the antenna.

### Tuning into a Station Automatically

- 1** Press **TUNER FM/AM** on the remote control or on the front panel until the frequency band appears on the display and TV screen.
- 2** Press **CH/PRESET (+/-)** on the remote control or front panel to select the desired column.  
If you select a blank column, R-SKIP appears in the display window.
- 3** Press **TUNER FM/AM** on the remote control or front panel to select the desired band.
- 4** Hold down **TUNING (+/-)** on the remote control for 1 or 2 seconds, and a station is searched for automatically.
- 5** Press **MEMORY**.

#### Note

The search may not stop at a station with a very weak signal.

### Labeling Stations

- 1** Press **→** to move to the station name column.

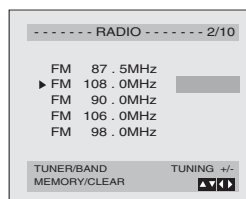

- 2** Use the **↑/↓** buttons to select the character then use the **←/→** buttons to shift to the next or previous character.
- 3** Press **ENTER** to confirm the station name.
- 4** Press **MEMORY** on the remote control.  
The station name is stored.

## Controlling the TV with the Supplied Remote

By adjusting the remote signal, you can control your TV with the supplied remote.

### Notes

- If you enter a new code number, the code number previously entered will be erased.
- When you replace the batteries of the remote, the code number may be reset to the default (SONY) setting. Reset the appropriate code number.

## Controlling TVs with the remote

Press and hold **TV I / ⏻** while entering your TV's manufacturer's code (see the table) using the number buttons and press **ENTER**. Then release **TV I / ⏻**.

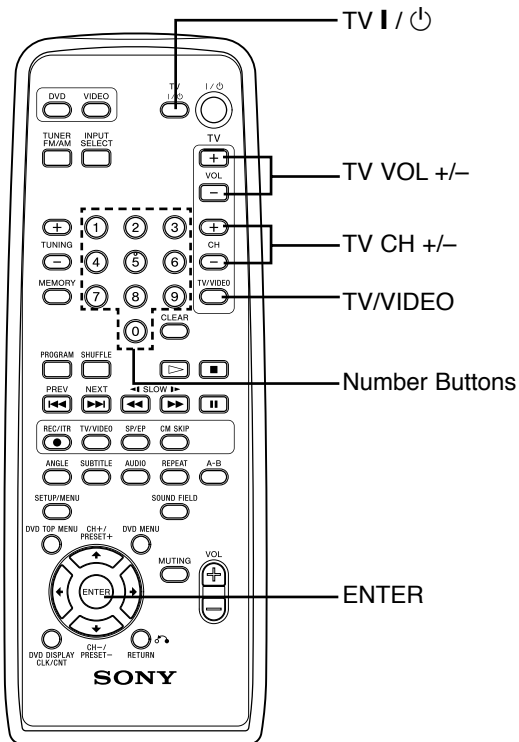

## Code numbers of controllable TVs

If more than one code number is listed, try entering them one at a time until you find the one that works with your TV.

Manufacturer	Code Number
SONY	501
AIWA	553, 501
DAEWOO	504, 505, 506, 507, 515, 544
FISHER	508
GOLDSTAR/LG	503, 511, 512, 515, 534, 544
GRUNDIG	517, 534
HITACHI	513, 514, 515, 544
JVC	516
MAGNAVOX	503, 518, 544
MITSUBISHI/MGA	503, 519, 544
NEC	503, 520, 544
PANASONIC	509, 524
PHILIPS	515, 518
PIONEER	509, 525, 526, 540
RCA/PROSCAN	510, 527, 528, 529, 544
SAMSUNG	503, 515, 531, 532, 533, 534, 544
SANYO	508, 545, 546, 547
SHARP	535
TELEFUNKEN	523, 536, 537, 538
THOMSON	537, 539
TOSHIBA	535, 540, 541
ZENITH	542, 543

## Controlling the TV

You can control your TV using the buttons below.

By pressing	You can
<b>TV I / ⏻</b>	Turn the TV on or off.
<b>TV/VIDEO</b>	Switch the TV's input source between the TV and other input sources.

### Note

Depending on the TV, you may not be able to control your TV or to use some of the buttons above.



## Troubleshooting

Check the following guide for the possible cause of a problem before contacting service.

Symptom	Cause	Correction
No power.	<ul style="list-style-type: none"> <li>The power cord is disconnected.</li> </ul>	<ul style="list-style-type: none"> <li>Plug the power cord into the wall outlet securely.</li> </ul>
The power is on, but the DVD/VCR Receiver does not work.	<ul style="list-style-type: none"> <li>No disc is inserted.</li> <li>No tape is inserted.</li> </ul>	<ul style="list-style-type: none"> <li>Insert a disc or tape. (Check that the disc or tape indicator in the display window is lit.)</li> </ul>
No picture.	<ul style="list-style-type: none"> <li>The TV is not set to receive DVD/VCR Receiver signal output.</li> </ul>	<ul style="list-style-type: none"> <li>Select the appropriate video input mode on the TV so the picture from the DVD/VCR Receiver appears on the TV screen.</li> </ul>
	<ul style="list-style-type: none"> <li>TV/VIDEO mode for DVD/VCR Receiver is set to TV MODE.</li> </ul>	<ul style="list-style-type: none"> <li>Press the TV/VIDEO button on the remote control repeatedly to select VIDEO mode. VCR MODE appears in the display window.</li> </ul>
	<ul style="list-style-type: none"> <li>The video cable is not connected securely.</li> </ul>	<ul style="list-style-type: none"> <li>Connect the video cable securely.</li> </ul>
	<ul style="list-style-type: none"> <li>The connected TV power is turned off.</li> </ul>	<ul style="list-style-type: none"> <li>Turn on the TV.</li> </ul>
No sound.	<ul style="list-style-type: none"> <li>The equipment connected with the audio cable is not set to receive DVD/VCR Receiver signal output.</li> </ul>	<ul style="list-style-type: none"> <li>Select the correct input mode on the audio receiver so you can listen to the sound from the DVD/VCR Receiver.</li> </ul>
	<ul style="list-style-type: none"> <li>The audio cables are not connected securely.</li> </ul>	<ul style="list-style-type: none"> <li>Connect the audio cable securely.</li> </ul>
	<ul style="list-style-type: none"> <li>The power of the equipment connected with the audio cable is turned off.</li> </ul>	<ul style="list-style-type: none"> <li>Turn on the equipment connected with the audio cable.</li> </ul>
	<ul style="list-style-type: none"> <li>The audio connecting cord is damaged.</li> </ul>	<ul style="list-style-type: none"> <li>Replace it with new one.</li> </ul>
The playback picture is poor.	<ul style="list-style-type: none"> <li>The disc is dirty.</li> </ul>	<ul style="list-style-type: none"> <li>Clean the disc.</li> </ul>
	<ul style="list-style-type: none"> <li>Tape heads are dirty.</li> </ul>	<ul style="list-style-type: none"> <li>Clean video heads.</li> </ul>
	<ul style="list-style-type: none"> <li>Tape is a rental or was recorded on another VCR.</li> </ul>	<ul style="list-style-type: none"> <li>Use CH/PRESET(+/-) for manual tracking adjustment while tape is playing.</li> </ul>
The DVD/VCR Receiver does not start playback.	<ul style="list-style-type: none"> <li>No disc is inserted.</li> <li>No tape is inserted.</li> </ul>	<ul style="list-style-type: none"> <li>Insert a disc or tape. (Check that the disc or tape indicator in the display window is lit.)</li> </ul>
	<ul style="list-style-type: none"> <li>An unplayable disc is inserted.</li> </ul>	<ul style="list-style-type: none"> <li>Insert a playable disc. (Check the disc type, color system, and Regional code.)</li> </ul>
	<ul style="list-style-type: none"> <li>The disc is placed upside down.</li> </ul>	<ul style="list-style-type: none"> <li>Place the disc with the playback side down.</li> </ul>
	<ul style="list-style-type: none"> <li>The disc is not placed within the guide.</li> </ul>	<ul style="list-style-type: none"> <li>Place the disc on the disc tray correctly inside the guide.</li> </ul>
	<ul style="list-style-type: none"> <li>The disc is dirty.</li> </ul>	<ul style="list-style-type: none"> <li>Clean the disc.</li> </ul>
	<ul style="list-style-type: none"> <li>The Rating level is set.</li> </ul>	<ul style="list-style-type: none"> <li>Cancel the Rating function or change the rating level.</li> </ul>
	<ul style="list-style-type: none"> <li>Big volume makes a set vibrate.</li> </ul>	<ul style="list-style-type: none"> <li>A speaker is kept away.</li> </ul>
Noise is made in the picture.	<ul style="list-style-type: none"> <li>It is not a trouble.</li> </ul>	<ul style="list-style-type: none"> <li>Auto clock system is moving.</li> </ul>
It has sound inside for a while with POWER-OFF.	<ul style="list-style-type: none"> <li>It is not a trouble.</li> </ul>	<ul style="list-style-type: none"> <li>Auto clock system is moving.</li> </ul>

## Troubleshooting (Continued)

Symptom	Cause	Correction
Some channels are skipped over when using CH/PRESET(+/-).	<ul style="list-style-type: none"> <li>Those channels were deleted with the CH. ADD/DEL option.</li> </ul>	<ul style="list-style-type: none"> <li>Use CH. ADD/DEL option on the TUNING menu to restore channels. See "Channel Selection" on page 18.</li> </ul>
Picture and sound of broadcasting channel are weak or missing.	<ul style="list-style-type: none"> <li>Antenna or cables are loose.</li> </ul>	<ul style="list-style-type: none"> <li>Tighten connections or replace cable.</li> </ul>
	<ul style="list-style-type: none"> <li>Wrong CHANNEL SOURCE option is being used.</li> </ul>	<ul style="list-style-type: none"> <li>Try all CHANNEL SOURCE options. See "Channel Selection" on page 18 for details.</li> </ul>
Camcorder image is not shown.	<ul style="list-style-type: none"> <li>Camcorder is off.</li> </ul>	<ul style="list-style-type: none"> <li>Turn camcorder on and operate properly.</li> </ul>
Camcorder image via A/V input to DVD/VCR Receiver is not shown on TV screen.	<ul style="list-style-type: none"> <li>DVD/VCR Receiver INPUT SELECT is not set to LINE1(L1) or LINE2(L2).</li> </ul>	<ul style="list-style-type: none"> <li>Use INPUT SELECT to select LINE input channel (LINE1(L1) or LINE2(L2)).</li> </ul>
Timer recording is not possible.	<ul style="list-style-type: none"> <li>Clock in DVD/VCR Receiver is not set to correct time.</li> </ul>	<ul style="list-style-type: none"> <li>Set clock to correct time. See "Setting the Clock" on page 19.</li> </ul>
	<ul style="list-style-type: none"> <li>Timer has been programmed incorrectly.</li> </ul>	<ul style="list-style-type: none"> <li>Reprogram Timer. See "Timer Recording" on pages 25 and 26.</li> </ul>
	<ul style="list-style-type: none"> <li>TIMER indicator light does not appear after programming timer.</li> </ul>	<ul style="list-style-type: none"> <li>Reprogram Timer and turn DVD/VCR Receiver off to enable timer.</li> </ul>
Stereo Audio Record and/or Playback is not present.	<ul style="list-style-type: none"> <li>TV is not Stereo-compatible.</li> </ul>	<ul style="list-style-type: none"> <li>No action is possible.</li> </ul>
	<ul style="list-style-type: none"> <li>Broadcast program is not in stereo format.</li> </ul>	<ul style="list-style-type: none"> <li>No action is possible.</li> </ul>
	<ul style="list-style-type: none"> <li>DVD/VCR Receiver A/V Out jacks are not connected to TV A/V In jacks.</li> </ul>	<ul style="list-style-type: none"> <li>Make A/V connections. Stereo is available only via A/V output from DVD/VCR Receiver.</li> </ul>
	<ul style="list-style-type: none"> <li>DVD/VCR Receiver Audio/Video Out is not selected for viewing at the TV.</li> </ul>	<ul style="list-style-type: none"> <li>Select A/V source as TV input.</li> </ul>
	<ul style="list-style-type: none"> <li>DVD/VCR Receiver BROADCAST TYPE mode is set to SAP or MONO.</li> </ul>	<ul style="list-style-type: none"> <li>Set BROADCAST TYPE mode to STEREO. See "Using the VIDEO Setup Menu" on page 18.</li> </ul>

## Troubleshooting (Continued)

Symptom	Cause	Correction
Severe hum or noise is heard.	• The plugs and jacks are dirty.	• Wipe them with a cloth slightly moistened with alcohol.
	• The disc is dirty.	• Clean the disc.
	• The speakers and components are connected poorly.	• Connect the speakers and components securely.
	• The DVD/VCR Receiver is located too close to the TV.	• Move your TV away from the audio components.
Radio stations cannot be tuned in.	• The antenna is positioned or connected poorly.	• Connect the antenna securely. • Adjust the antennas and connect an external antenna if necessary.
	• The signal strength of the stations is too weak (when tuning in with automatic tuning).	• Tune in the station manually.
	• No stations have been preset or preset stations have been cleared (when tuning by scanning preset stations).	• Preset the stations (see page 38).
	• DVD/VCR Receiver source is not set to OPTICAL IN.	• Select L1 OPT by pressing INPUT SELECT.
No sound from OPTICAL IN jack.	• DVD/VCR Receiver source is not set to OPTICAL IN.	• Select L1 OPT by pressing INPUT SELECT.
The remote control does not work properly.	• The remote control is not pointed at the remote sensor of the DVD/VCR Receiver.	• Point the remote control at the remote sensor of the DVD/VCR Receiver.
	• There is an obstacle in the path of the remote control and the DVD/VCR Receiver.	• Remove the obstacle.
	• The batteries in the remote control are exhausted.	• Replace the batteries with new ones.
	• This remote control uses same buttons for VIDEO and DVD (ex. ▷ (PLAY)).	• When using a VIDEO, first press the VIDEO button. When using a DVD, first press the DVD button.

### Moisture Condensation

Moisture condensation can occur:	In locations where moisture condensation may occur:
<ul style="list-style-type: none"> <li>• When the DVD/VCR Receiver is moved from a cold place to a warm place.</li> <li>• Under extremely humid conditions.</li> </ul>	<ul style="list-style-type: none"> <li>• Keep the DVD/VCR Receiver plugged into an AC power outlet with POWER On. This will help prevent condensation.</li> <li>• When condensation has occurred, wait a few hours for the DVD/VCR Receiver to dry before using it.</li> </ul>

### Video Head Cleaning

The dirt accumulating on the head after a long period of time can cause the playback picture to become blurred or broken up. High quality video cassette tapes will not normally deposit dirt onto the video head, but old or damaged tapes might.

## Language Code List

Enter the appropriate code number for the initial settings “Disc Audio”, “Disc Subtitle” and/or “Disc Menu” (See page 21).

Code	Language	Code	Language	Code	Language	Code	Language
6566	Abkhazian	7074	Fiji	7678	Lingala	8373	Singhalese
6565	Afar	7073	Finnish	7684	Lithuanian	8375	Slovak
6570	Afrikaans	7082	French	7775	Macedonian	8376	Slovenian
8381	Albanian	7089	Frisian	7771	Malagasy	8379	Somali
6577	Amharic	7176	Galician	7783	Malay	6983	Spanish
6582	Arabic	7565	Georgian	7776	Malayalam	8385	Sudanese
7289	Armenian	6869	German	7784	Maltese	8387	Swahili
6583	Assamese	6976	Greek	7773	Maori	8386	Swedish
6588	Aymara	7576	Greenlandic	7782	Marathi	8476	Tagalog
6590	Azerbaijani	7178	Guarani	7779	Moldavian	8471	Tajik
6665	Bashkir	7185	Gujarati	7778	Mongolian	8465	Tamil
6985	Basque	7265	Hausa	7865	Nauru	8484	Tatar
6678	Bengali; Bangla	7387	Hebrew	7869	Nepali	8469	Telugu
6890	Bhutani	7273	Hindi	7879	Norwegian	8472	Thai
6672	Bihari	7285	Hungarian	7982	Oriya	6679	Tibetan
6682	Breton	7383	Icelandic	8065	Panjabi	8473	Tigrinya
6671	Bulgarian	7378	Indonesian	8083	Pashto, Pushto	8479	Tonga
7789	Burmese	7365	Interlingua	7065	Persian	8482	Turkish
6669	Byelorussian	7165	Irish	8076	Polish	8475	Turkmen
7577	Cambodian	7384	Italian	8084	Portuguese	8487	Twi
6765	Catalan	7465	Japanese	8185	Quechua	8575	Ukrainian
9072	Chinese	7487	Javanese	8277	Rhaeto-Romance	8582	Urdu
6779	Corsican	7578	Kannada	8279	Romanian	8590	Uzbek
7282	Croatian	7583	Kashmiri	8285	Russian	8673	Vietnamese
6783	Czech	7575	Kazakh	8377	Samoan	8679	Volapük
6865	Danish	7589	Kirghiz	8365	Sanskrit	6789	Welsh
7876	Dutch	7579	Korean	7168	Scots Gaelic	8779	Wolof
6978	English	7585	Kurdish	8382	Serbian	8872	Xhosa
6979	Esperanto	7679	Laothian	8372	Serbo-Croatian	7473	Yiddish
6984	Estonian	7665	Latin	8378	Shona	8979	Yoruba
7079	Faeroese	7686	Latvian, Lettish	8368	Sindhi	9085	Zulu

## Area Code List

Enter the appropriate code number for the initial setting "Area Code" (See page 23).

Code	Area	Code	Area	Code	Area	Code	Area
AD	Andorra	ER	Eritrea	LC	Saint Lucia	SC	Seychelles
AE	United Arab Emirates	ES	Spain	LI	Liechtenstein	SD	Sudan
AF	Afghanistan	ET	Ethiopia	LK	Sri Lanka	SE	Sweden
AG	Antigua and Barbuda	FI	Finland	LR	Liberia	SG	Singapore
AI	Anguilla	FJ	Fiji	LS	Lesotho	SH	Saint Helena
AL	Albania	FK	Falkland Islands	LT	Lithuania	SI	Slovenia
AM	Armenia	FM	Micronesia	LU	Luxembourg	SJ	Svalbard and Jan Mayen Islands
AN	Netherlands Antilles	FO	Faroe Islands	LV	Latvia	SK	Slovak Republic
AO	Angola	FR	France	LY	Libya	SL	Sierra Leone
AQ	Antarctica	FX	France (European Territory)	MA	Morocco	SM	San Marino
AR	Argentina	GA	Gabon	MC	Monaco	SN	Senegal
AS	American Samoa	GB	Great Britain	MD	Moldavia	SO	Somalia
AT	Austria	GD	Grenada	MG	Madagascar	SR	Suriname
AU	Australia	GE	Georgia	MH	Marshall Islands	ST	Saint Tome and Principe
AW	Aruba	GF	French Guyana	MK	Macedonia	SU	Former USSR
AZ	Azerbaijan	GH	Ghana	ML	Mali	SV	El Salvador
BA	Bosnia-Herzegovina	GI	Gibraltar	MM	Myanmar	SY	Syria
BB	Barbados	GL	Greenland	MN	Mongolia	SZ	Swaziland
BD	Bangladesh	GM	Gambia	MO	Macau	TC	Turks and Caicos Islands
BE	Belgium	GN	Guinea	MP	Northern Mariana Islands	TD	Chad
BF	Burkina Faso	GP	Guadeloupe (French)	MQ	Martinique (French)	TF	French Southern Territories
BG	Bulgaria	GQ	Equatorial Guinea	MR	Mauritania	TG	Togo
BH	Bahrain	GR	Greece	MS	Montserrat	TH	Thailand
BI	Burundi	GS	S. Georgia & S. Sandwich Isls.	MT	Malta	TJ	Tadjikistan
BJ	Benin	GT	Guatemala	MU	Mauritius	TK	Tokelau
BM	Bermuda	GU	Guam (USA)	MV	Maldives	TM	Turkmenistan
BN	Brunei Darussalam	GW	Guinea Bissau	MW	Malawi	TN	Tunisia
BO	Bolivia	GY	Guyana	MX	Mexico	TO	Tonga
BR	Brazil	HK	Hong Kong	MY	Malaysia	TP	East Timor
BS	Bahamas	HM	Heard and McDonald Islands	MZ	Mozambique	TR	Turkey
BT	Bhutan	HN	Honduras	NA	Namibia	TT	Trinidad and Tobago
BV	Bouvet Island	HR	Croatia	NC	New Caledonia (French)	TV	Tuvalu
BW	Botswana	HT	Haiti	NE	Niger	TW	Taiwan
BY	Belarus	HU	Hungary	NF	Norfolk Island	TZ	Tanzania
BZ	Belize	ID	Indonesia	NG	Nigeria	UA	Ukraine
CA	Canada	IE	Ireland	NI	Nicaragua	UG	Uganda
CC	Cocos (Keeling) Islands	IL	Israel	NL	Netherlands	UK	United Kingdom
CF	Central African Republic	IN	India	NO	Norway	UM	USA Minor Outlying Islands
CG	Congo	IO	British Indian Ocean Territory	NP	Nepal	US	United States
CH	Switzerland	IQ	Iraq	NR	Nauru	UY	Uruguay
CI	Ivory Coast	IR	Iran	NU	Niue	UZ	Uzbekistan
CK	Cook Islands	IS	Iceland	NZ	New Zealand	VA	Vatican City State
CL	Chile	IT	Italy	OM	Oman	VC	Saint Vincent & Grenadines
CM	Cameroon	JM	Jamaica	PA	Panama	VE	Venezuela
CN	China	JO	Jordan	PE	Peru	VG	Virgin Islands (British)
CO	Colombia	JP	Japan	PF	Polynesia (French)	VI	Virgin Islands (USA)
CR	Costa Rica	KE	Kenya	PG	Papua New Guinea	VN	Vietnam
CS	Former Czechoslovakia	KG	Kyrgyzstan	PH	Philippines	VU	Vanuatu
CU	Cuba	KH	Cambodia	PK	Pakistan	WF	Wallis and Futuna Islands
CV	Cape Verde	KI	Kiribati	PL	Poland	WS	Samoa
CX	Christmas Island	KM	Comoros	PM	Saint Pierre and Miquelon	YE	Yemen
CY	Cyprus	KN	Saint Kitts & Nevis Anguilla	PN	Pitcairn Island	YT	Mayotte
CZ	Czech Republic	KP	North Korea	PR	Puerto Rico	YU	Yugoslavia
DE	Germany	KR	South Korea	PT	Portugal	ZA	South Africa
DJ	Djibouti	KW	Kuwait	PW	Palau	ZM	Zambia
DK	Denmark	KY	Cayman Islands	PY	Paraguay	ZR	Zaire
DM	Dominica	KZ	Kazakhstan	QA	Qatar	ZW	Zimbabwe
DO	Dominican Republic	LA	Laos	RE	Reunion (French)		
DZ	Algeria	LB	Lebanon	RO	Romania		
EC	Ecuador			RU	Russian Federation		
EE	Estonia			RW	Rwanda		
EG	Egypt			SA	Saudi Arabia		
EH	Western Sahara			SB	Solomon Islands		

## Specifications

### General

	<b>(AVD-K700P)</b>
Power requirements	AC 120V, 60 Hz
Power consumption	110 W
Dimensions (approx.)	430 x 83 x 376 mm (17 x 3 <sup>3</sup> / <sub>8</sub> x 14 <sup>7</sup> / <sub>8</sub> inches) (W x H x D)
Mass (approx.)	6.2 kg (13 lb11 oz)
Operating temperature	5°C to 35°C (41°F to 95°F)
Operating humidity	5 % to 90 %
Signal system	NTSC

### DVD Section

Laser system	Semiconductor laser (Wavelength DVD : 650 nm, CD : 780nm)
Frequency response	DVD (PCM 48 kHz): 8 Hz to 22 kHz, CD: 8 Hz to 20 kHz
Signal-to-noise ratio	More than 80 dB (AUDIO OUT jacks)
Harmonic distortion	Less than 0.3%
Dynamic range	More than 85 dB (AUDIO OUT jacks)

### Inputs

ANTENNA IN	Antenna or CATV input, 75 ohms
VIDEO IN	1 Vp-p 75 ohms, sync negative, RCA jack x 2
AUDIO IN	-6.0 dBm more than 47 kohms, RCA jack (L, R) x 2
FM ANTENNA IN	FM antenna input, 75 ohms
AM ANTENNA IN	AM antenna input, 300 ohms
OPTICAL IN	Optical connector x 1

### Outputs

VIDEO OUT	1 Vp-p 75 ohms, sync negative
COMPONENT VIDEO OUT	(Y) 1.0 V (p-p), 75 ohms, negative sync, RCA jack x 1 (PB/CB)/(PR/CR) 0.7 V (p-p), 75 ohms, RCA jack x 2
Audio output (analog audio)	2.0 Vrms (1 KHz, 0 dB), 330 ohms, RCA jack (L, R) x 1
ANTENNA OUT	Channel 3 or 4 (Switchable)

### VIDEO Section

Head system	4 heads helical scan azimuth system
Timer	12-hour display type with AM, PM
Tape speed	SP: 33.35 mm/sec, EP: 11.12 mm/sec
Tape width	12.7 mm
Maximum recording time	SP: 2 HOURS (T-120), EP: 6 HOURS (T-120)/8 HOURS (T-160)
Rewind time	About 150 seconds (T-120)
Antenna	75 ohms (VHF/UHF)
Channel coverage	VHF: 2-13, UHF: 14-69, CATV: 1-125 (4A, A-W, W+1 - W+84, A-5 - A-1)
Frequency range	20Hz to 20kHz
Signal-to-noise ratio	More than 43dB
Dynamic range	More than 85 dB (AUDIO OUT jacks)
Channel separation	More than 55 dB (AUDIO OUT jacks)

### FM Tuner

Tuning Range	87.5 - 108.0 MHz
Intermediate Frequency	10.7 MHz

### AM Tuner

Tuning Range	530 - 1,720 kHz
Intermediate Frequency	450 kHz

## Specifications (Continued)

### AUDIO POWER SPECIFICATION

#### POWER OUTPUT AND TOTAL HARMONIC DISTORTION:

With 6 ohm loads, both channels driven, from 120 - 20,000 Hz; rated 90 watts per channel minimum RMS power, with no more than 10 % total harmonic distortion from 250 milli watts to rated output (USA model only).

#### Amplifier

Stereo mode	90 W + 90 W (6Ω at 1 kHz, THD 10 %)
Surround mode	Front: 90 W/ch (6Ω at 1 kHz, THD 10 %) Center*: 90 W (6Ω at 1 kHz, THD 10 %) Surround*: 90 W/ch (6Ω at 1 kHz, THD 10 %) Subwoofer*: 150 W (4Ω at 30 Hz, THD 10 %)
Inputs	* Depending on the sound mode settings and the source, there may be no sound output. VIDEO 1, VIDEO 2, OPTICAL IN

#### Speaker Section

##### Front/Surround (SS-MSP761)

Speaker system	Full range, magnetically shielded
Speaker units	80mm cone type
Enclosure type	Bass reflex
Rated Impedance	6 Ω
Dimensions (approx.)	90 x 150 x 124.5 mm (3 5/8 x 6 x 5 inches)
Mass (approx.)	0.8 kg (1.13 lbs)

##### Center (SS-CNP761)

Speaker system	Full range, magnetically shielded
Speaker units	80mm cone type
Enclosure type	Bass reflex
Rated Impedance	6 Ω
Dimensions (approx.)	230 x 90 x 127 mm (9 1/8 x 3 5/8 x 5 inches)
Mass (approx.)	1.0 kg (2.4 lbs)

##### Passive Subwoofer (SS-WMSP700)

Speaker system	Magnetically shielded
Speaker units	200mm cone type
Enclosure type	Acoustically loaded bass reflex
Rated Impedance	4 Ω
Dimensions (approx.)	270 x 325 x 333 mm (10 6/8 x 12 7/8 x 13 1/8 inches) including front panel
Mass (approx.)	6.5 kg (14.6 lbs)

#### Accessories

Video cable . . . . .	1	Audio cable . . . . .	1
RF 75-ohm Coaxial Cable . . . . .	1	Speakers . . . . .	6
Speaker cables . . . . .	.6	Speaker color label . . . . .	1
Speaker foot (for satellite speaker) . . . . .	.20	AM loop antenna . . . . .	1
FM antenna . . . . .	1	Remote control . . . . .	1
Batteries . . . . .	.2	Ferrite core . . . . .	1

- Design and specifications are subject to change without notice.
- Manufactured under license from Dolby Laboratories. "Dolby", "Pro Logic", and the double-D symbol are trademarks of Dolby Laboratories. Confidential unpublished works. Copyright 1992-1997 Dolby Laboratories. All rights reserved.
- DTS and DTS Digital Surround are registered trademarks of Digital Theater Systems, Inc.

