

CD/DVD Player

Operating Instructions

For customers in the U.S.A Owner's Record

The model and serial numbers are located at the rear of the unit. Record the serial number in the space provided below. Refer to them whenever you call upon your Sony dealer regarding this product.

Model No. DVP-CX995V

Serial No. _____

For Customers in Canada

If this product is not working properly, please call 1-877-602-2008 for **Peace of Mind Warranty Replacement service**.

For other product related questions please contact our **Customer Information Service Centre** at 1-877-899-7669 or write to us at: Customer Information Service 115 Gordon Baker Road, Toronto, Ontario, M2H 3R6



HDMI™
HIGH-DEFINITION MULTIMEDIA INTERFACE



DVP-CX995V

WARNING

To reduce the risk of fire or electric shock, do not expose this apparatus to rain or moisture.

To avoid electrical shock, do not open the cabinet. Refer servicing to qualified personnel only.

CAUTION

The use of optical instruments with this product will increase eye hazard.

For the customers in the U.S.A.

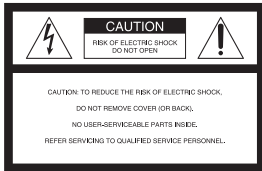

This symbol is intended to alert the user to the presence of uninsulated “dangerous voltage”

within the product’s enclosure that may be of sufficient magnitude to constitute a risk of electric shock to persons.



This symbol is intended to alert the user to the presence of important operating and

maintenance (servicing) instructions in the literature accompanying the appliance.

WARNING

This equipment has been tested and found to comply with the limits for a Class B digital device, pursuant to Part 15 of the FCC Rules. These limits are designed to provide reasonable protection against harmful interference in a residential installation. This equipment generates, uses, and can radiate radio frequency energy and, if not installed and used in accordance with the instructions, may cause harmful interference to radio communications. However, there is no guarantee that interference will not occur in a particular installation. If this equipment does cause harmful interference to radio or television reception, which can be determined by turning the equipment off and on, the user is encouraged to try to correct the interference by one or more of the following measures:

- Reorient or relocate the receiving antenna.
- Increase the separation between the equipment and receiver.
- Connect the equipment into an outlet on a circuit different from that to which the receiver is connected.
- Consult the dealer or an experienced radio/TV technician for help.

CAUTION

You are cautioned that any change or modifications not expressly approved in this manual could void your authority to operate this equipment.

For the customers in Canada

CAUTION

TO PREVENT ELECTRIC SHOCK, MATCH WIDE BLADE OF PLUG TO WIDE SLOT, FULLY INSERT.

Notes About the Discs

- To keep the disc clean, handle the disc by its edge. Do not touch the surface.



- Do not expose the disc to direct sunlight or heat sources such as hot air ducts, or leave it in a car parked in direct sunlight as the temperature may rise considerably inside the car.
- After playing, store the disc in its case.
- Clean the disc with a cleaning cloth. Wipe the disc from the center out.



- Do not use solvents such as benzine, thinner, commercially available cleaners, or anti-static spray intended for vinyl LPs.
- If you have printed the disc’s label, dry the label before playing.

Precautions

On safety

- Caution – The use of optical instruments with this product will increase eye hazard.
- To prevent fire or shock hazard, do not place objects filled with liquids, such as vases, on the apparatus.
- Should any solid object or liquid fall into the cabinet, unplug the player and have it checked by qualified personnel before operating it any further.

On power sources

- The player is not disconnected from the AC power source as long as it is connected to the wall outlet, even if the player itself has been turned off.
- If you are not going to use the player for a long time, be sure to disconnect the player from the wall outlet. To disconnect the AC power cord, grasp the plug itself; never pull the cord.
- Should the AC power cord need to be changed, have it done at a qualified service shop only.

On placement

- Place the player in a location with adequate ventilation to prevent heat build-up in the player.
- Do not place the player on a soft surface such as a rug that might block the ventilation holes.
- Do not place the player in a location near heat sources, or in a place subject to direct sunlight, excessive dust, or mechanical shock.
- Do not install the player in an inclined position. It is designed to be operated in a horizontal position only.
- Keep the player away from equipment with strong magnets, such as microwave ovens, or large loudspeakers.
- Do not place heavy objects on the player.

On operation

- If the player is brought directly from a cold to a warm location, or is placed in a very damp room, moisture may condense on the lenses inside the player. Should this occur, the player may not operate properly. In this case, remove the disc and leave the player turned on for about half an hour until the moisture evaporates.

- When you move the player, take out any discs. If you don't, the disc may be damaged.

On disconnecting the AC power cord

Since this player may read and store the disc information at any time, always set the player to standby mode before unplugging the AC power cord to ensure that the data is stored properly.

On adjusting volume

Do not turn up the volume while listening to a section with very low level inputs or no audio signals. If you do, the speakers may be damaged when a peak level section is played.

On cleaning

Clean the cabinet, panel, and controls with a soft cloth slightly moistened with a mild detergent solution. Do not use any type of abrasive pad, scouring powder or solvent such as alcohol or benzine.

On cleaning discs

Do not use a commercially available cleaning disc. It may cause a malfunction.

IMPORTANT NOTICE

Caution: This player is capable of holding a still video image or on-screen display image on your television screen indefinitely. If you leave the still video image or on-screen display image displayed on your TV for an extended period of time, you risk permanent damage to your television screen. Plasma Display Panel televisions and projection televisions are especially susceptible to this.

On transporting the player

Before transporting the player, follow the procedure below to return the internal mechanisms to their original positions.

- 1 Remove all the discs from the disc slots.
- 2 Press OPEN/CLOSE to close the front cover.
Make sure that "NO DISC" appears on the front panel display.
- 3 Wait for 10 seconds, then press I/O to turn off the player.
The player enters standby mode.
- 4 Disconnect the AC power cord.

If you have any questions or problems concerning your player, please consult your nearest Sony dealer.

Table of Contents

WARNING	2
Notes About the Discs	2
Precautions	3
About This Manual	6
This Player Can Play the Following Discs	6
Index to Parts and Controls	8
Guide to the Control Menu Display	12

Hookups

Hooking Up the Player	15
Step 1: Unpacking	15
Step 2: Preparing the Remote	15
Step 3: Connecting the Video/HDMI Cords	17
Step 4: Connecting the Audio Cords	20
Step 5: Connecting the Power Cord	26
Step 6: Quick Setup	26

Playing Discs

Inserting Discs	30
Playing Discs	32
Resuming Playback From the Point Where You Stopped the Disc (Multi-disc Resume)	34
Using the DVD's Menu	35
Selecting "ORIGINAL" or "PLAY LIST" on a DVD-RW	36
Selecting a Playback Area for a Super Audio CD	37
Playing VIDEO CDs With PBC Functions (PBC Playback)	38
Various Play Mode Functions (Program Play, Shuffle Play, Repeat Play, A-B Repeat Play)	39

Searching for and Managing Discs (Disc Explorer)

Displaying the Disc Information	43
Filing Discs in the Folder (File Mode)	46
Labeling Discs and Folders (Edit Mode)	48
Sorting Discs (Sort Mode)	51

Searching for a Scene

Searching for a Particular Point on a Disc (Scan, Slow-motion Play, Freeze Frame)	52
Searching for a Title/Chapter/Track/Scene, etc.	53
Searching by Scene (PICTURE NAVIGATION)	55

Viewing Information About the Disc

Checking the Playing Time and Remaining Time	56
--	----

Sound Adjustments

Changing the Sound	59
--------------------------	----

Enjoying Movies

Changing the Angles	61
Displaying the Subtitles	61
Adjusting the Playback Picture (CUSTOM PICTURE MODE).....	62
Sharpening the Picture (SHARPNESS).....	63

Enjoying MP3 Audio and JPEG Images

About MP3 Audio Tracks and JPEG Image Files	64
Playing MP3 Audio Tracks or JPEG Image Files.....	65
Enjoying JPEG Images as a Slide Show	68

Using Various Additional Functions

Locking Discs (CUSTOM PARENTAL CONTROL, PARENTAL CONTROL)	70
Controlling Your TV or AV Amplifier (Receiver) With the Supplied Remote	73

Settings and Adjustments







Using the Setup Display.....	76
Setting the Display or Sound Track Language (LANGUAGE SETUP)	77
Settings for the Display (SCREEN SETUP).....	78
Custom Settings (CUSTOM SETUP)	80
Settings for the Sound (AUDIO SETUP)	81
Settings for the Speakers (SPEAKER SETUP)	83

Additional Information

Troubleshooting	86
Glossary	89
Specifications.....	92
Language Code List	93
Index	94





About This Manual

- Instructions in this manual describe the controls on the remote. You can also use the controls on the player if they have the same or similar names as those on the remote.
- “DVD” may be used as a general term for DVD VIDEOS, DVD-Rs, DVD-RWs, DVD+Rs, and DVD+RWs.
- The meaning of the icons used in this manual is described below:

Icons	Meanings
	Functions available for DVD VIDEOS and DVD+Rs/DVD+RWs or DVD-Rs/DVD-RWs in video mode
	Functions available for DVD-RWs in VR (Video Recording) mode
	Functions available for VIDEO CDs (including Super VCDs or CD-Rs/CD-RWs in video CD format or Super VCD format)
	Functions are available for Super Audio CDs
	Functions available for music CDs or CD-Rs/CD-RWs in music CD format
	Functions available for DATA CDs (CD-ROMs/CD-Rs/CD-RWs containing MP3* audio tracks and JPEG image files)

* MP3 (MPEG1 Audio Layer 3) is a standard format defined by ISO (International Standards Organization)/MPEG which compresses audio data.

This Player Can Play the Following Discs

Format of discs	
DVD VIDEO (page 89)	
DVD-RW (page 89)	
Super Audio CD (page 90)	
VIDEO CD	
Music CD	

“DVD VIDEO” and “DVD-RW” are trademarks.

Note about CDs

The player can play CD-ROMs/CD-Rs/CD-RWs recorded in the following formats:

- music CD format
- video CD format
- MP3 audio tracks and JPEG image files of format conforming to ISO 9660* Level 1/ Level 2, or its extended format, Joliet
- KODAK Picture CD format

* A logical format of files and folders on CD-ROMs, defined by ISO (International Organization for Standardization).

Attention Regarding DualDisc software

This product has been engineered to provide the highest entertainment value while playing standard CD and DVD discs. DualDisc used with this product may jam in the slots or racks of disc holders or in the disc consoles and should not be used with this product.

Region code

Your player has a region code printed on the back of the unit and will only play DVD VIDEOS (playback only) labeled with identical region codes. This system is used to protect copyrights.

DVD VIDEOS labeled  will also play on this player.

If you try to play any other DVD VIDEO, the message "Playback prohibited by area limitations." will appear on the TV screen. Depending on the DVD VIDEO, no region code indication may be labeled even though playing the DVD VIDEO is prohibited by area restrictions.

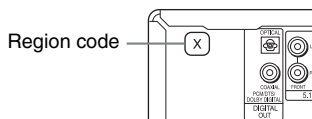

Example of discs that the player cannot play

The player cannot play the following discs:

- CD-ROMs/CD-Rs/CD-RWs other than those recorded in the format listed on the previous page.
- Data part of CD-Extras
- DVD-ROMs
- DVD Audios

Also, the player cannot play the following discs:

- A DVD VIDEO with a different region code.
- A disc recorded in a color system other than NTSC, such as PAL or SECAM (this player conforms to the NTSC color system).
- A disc that has a non-standard shape (e.g., card, heart).
- A disc with paper or stickers on it.
- A disc that has the adhesive of cellophane tape or a sticker still left on it.
- DVD-Rs recorded in VR mode (Video Recording format)
- Copy-Once programs recorded on CPRM* compatible DVD-Rs.
- An 8 cm disc (The 12 cm disc adapter should not be used for 8 cm discs because it

may cause the disc to jam or the player to malfunction).

- * CPRM; Content Protection for Recordable Media is a coding technology that protects copyright for Copy-Once programs.

Notes

- **Notes about DVD+RWs/DVD+Rs, DVD-RWs/DVD-Rs or CD-Rs/CD-RWs**

Some DVD+RWs/DVD+Rs, DVD-RWs/DVD-Rs or CD-Rs/CD-RWs cannot be played on this player due to the recording quality or physical condition of the disc, or the characteristics of the recording device and authoring software.

The disc will not play if it has not been correctly finalized. For more information, see the operating instructions for the recording device. Note that some playback functions may not work with some DVD+RWs/DVD+Rs, even if they have been correctly finalized. In this case, view the disc by normal playback. Also some DATA CDs created in Packet Write format cannot be played.

- **Music discs encoded with copyright protection technologies**

This product is designed to playback discs that conform to the Compact Disc (CD) standard. Recently, various music discs encoded with copyright protection technologies are marketed by some record companies. Please be aware that among those discs, there are some that do not conform to the CD standard and may not be playable by this product.

Note on playback operations of DVDs and VIDEO CDs

Some playback operations of DVDs and VIDEO CDs may be intentionally set by software producers. Since this player plays DVDs and VIDEO CDs according to the disc contents the software producers designed, some playback features may not be available. Also, refer to the instructions supplied with the DVDs or VIDEO CDs.

Copyrights

This product incorporates copyright protection technology that is protected by U.S. patents and other intellectual property rights. Use of this copyright protection technology must be authorized by Macrovision, and is intended for home and other limited viewing uses only unless otherwise authorized by Macrovision. Reverse engineering or disassembly is prohibited.

Index to Parts and Controls

For more information, see the pages in parentheses.

Front panel

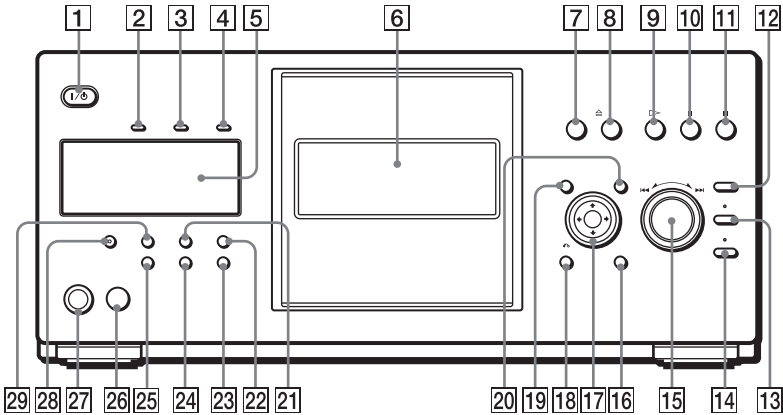

- 1** I/⏻ (on/standby) button (30)
- 2** HDMI* (High-Definition Multimedia Interface) indicator
Lights up when the HDMI OUT jack is correctly connected to a HDCP (High-bandwidth Digital Content Protection) compliant device with HDMI or DVI (Digital Visual Interface) input.
- 3** SA-CD (Super Audio CD) indicator
Lights up when:
— playing a Super Audio CD.
— a Super Audio CD (Hybrid disc) is inserted.
- 4** MULTI CHANNEL indicator
Lights up when playing a track or chapter that contains three or more audio signal channels.
- 5** Front panel display (9)
- 6** Front cover (30)
- 7** OPEN/CLOSE button (30)
- 8** ≡ DISC EJECT button (31)
- 9** ▷ (play) button (32)
- 10** || (pause) button (33)
- 11** ■ (stop) button (33)
- 12** +100 button (33)
- 13** DISC CHANGE button/indicator (30)
- 14** DIRECT SEARCH button/indicator (33)
- 15** ◀◀-/▶▶+/ENTER (previous/next/enter) dial (33)
- 16** DISPLAY button (12)
- 17** ◀/↑/↓/▶/ENTER buttons (35)
- 18** ⏪ RETURN button (34)
- 19** TOP MENU button (35)
- 20** MENU button (35)
- 21** PICTURE MODE button (62)
- 22** REPEAT button (41)
- 23** ONE/ALL DISCS button (39)
- 24** FOLDER button (43)
- 25** LOAD button (43)
- 26** □ (remote sensor) (15)
- 27** KEYBOARD jack (49)
- 28** FL OFF button/indicator (10)
- 29** TIME/TEXT button (56)

* This player is based on version 1.1 of High-Definition Multimedia Interface Specifications.

This DVD player incorporates High-Definition Multimedia Interface (HDMI™) technology. HDMI, the HDMI logo and High-Definition Multimedia Interface are trademarks or registered trademarks of HDMI Licensing LLC.

Front panel display

When playing back a DVD VIDEO/DVD-RW (32)

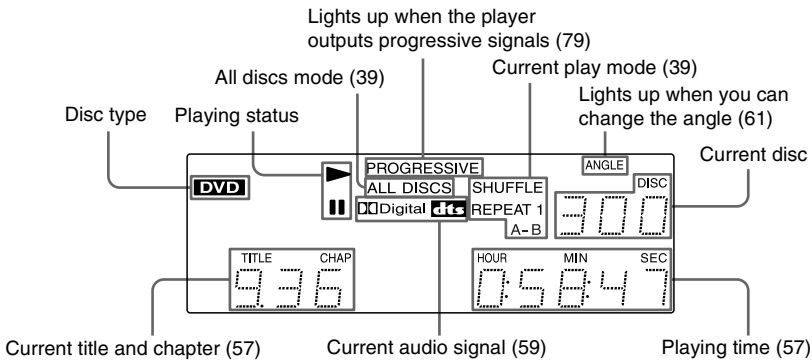

When playing back a VIDEO CD with Playback Control (PBC) (38)

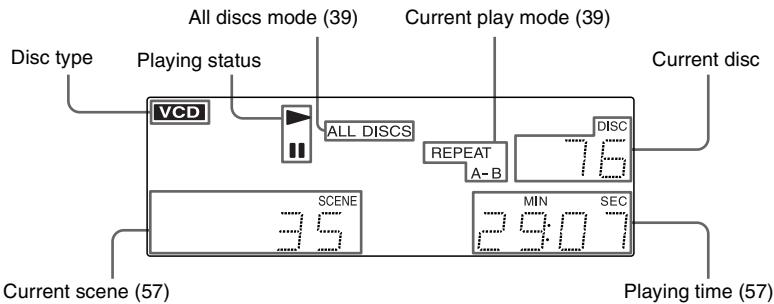

When playing back a CD, Super Audio CD, DATA CD (MP3 audio), or VIDEO CD (without PBC) (32) (65)

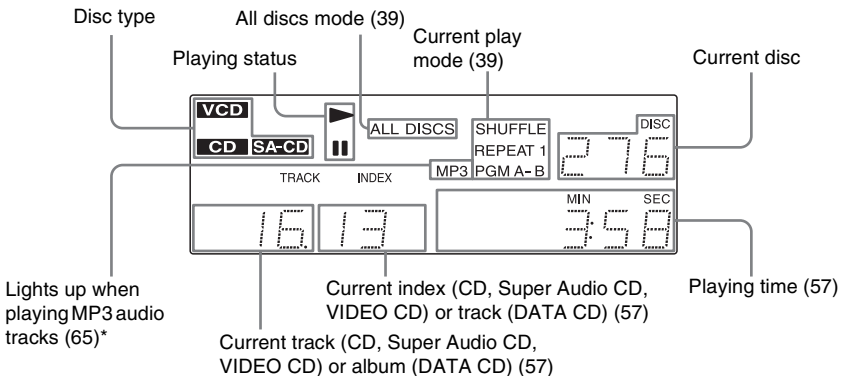

* When playing JPEG image files, "JPEG" appears on the display

To turn off the front panel display

Press FL OFF on the player. The front panel display turns off, and the FL OFF indicator on the player lights up.

💡 Hint

You can adjust the lighting of the front panel display by setting "DIMMER" in "CUSTOM SETUP" (page 80).

Rear panel

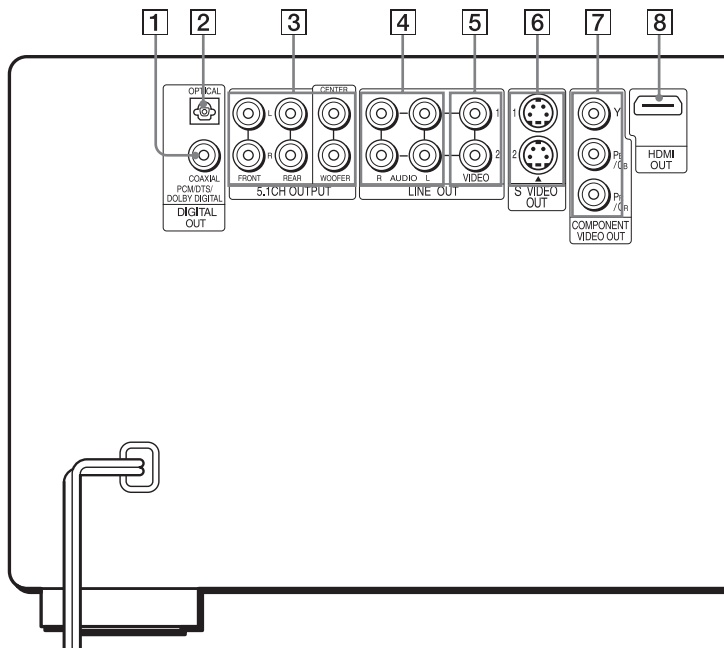

- 1** DIGITAL OUT (COAXIAL) jack (22) (23) (24)
- 2** DIGITAL OUT (OPTICAL) jack (22) (23) (24)
- 3** 5.1CH OUTPUT jacks (24)
- 4** LINE OUT AUDIO L/R 1/2 jacks (21) (22) (23)
- 5** LINE OUT VIDEO 1/2 jacks (17)
- 6** S VIDEO OUT 1/2 jacks (17)
- 7** COMPONENT VIDEO OUT (Y, Pb/Cb, Pr/Cr) jacks (17)
- 8** HDMI OUT (high-definition multimedia interface out) jack (17)

Remote

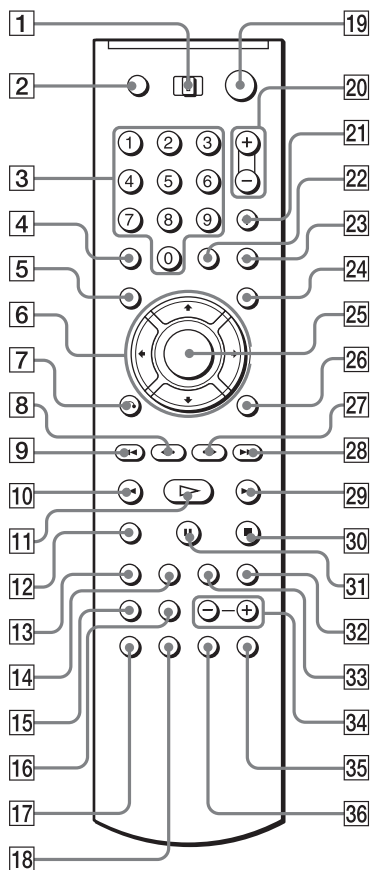

- 1** TV/DISC EXPLORER/DVD switch (44) (73)
- 2** OPEN/CLOSE button (33)
- 3** Number buttons (35)
The number 5 button has a tactile dot.*
- 4** CLEAR button (40)
- 5** TOP MENU/EDIT button (35) (48)
- 6** ←/↑/↓/→ buttons (35)
- 7** ⤵ RETURN button (34) (38) (44)
- 8** ◀◀ ◀• STEP/REPLAY button (33)(52)
- 9** ⏮ PREV (previous) buttons (33)
- 10** ◀◀ ◀◀ SCAN/SLOW buttons (52)
- 11** ▷ PLAY button (32)
The ▷ button has a tactile dot.*

- 12** ZOOM button
- 13** SA-CD MULTI/2CH (Super Audio CD multi/2 channel) button (37)
- 14** SA-CD/CD (Super Audio CD/CD) button (37)
- 15** TIME/TEXT button (56)
- 16** REPEAT button (41)
- 17** AUDIO button (59)
- 18** SUBTITLE button (61)
- 19** ⏻ (on/standby) button (30)
- 20** VOL (volume) +/- buttons (73)
The + button has a tactile dot.*
- 21** TV/VIDEO/DISC SKIP + button (33) (73)
- 22** ENTER/FOLDER button (43)(73)
- 23** WIDE MODE/DISC SKIP – button (33) (73)
- 24** MENU/SORT button (35) (51)
- 25** ENTER button (35)
- 26** DISPLAY/FILE button (12) (46)
- 27** •→ ||▶ STEP/ADVANCE button (33) (52)
- 28** ▶▶ NEXT (next) buttons (33)
- 29** ▶▶▶ SCAN/SLOW buttons (52)
- 30** ■ STOP button (33)
- 31** || PAUSE button (33)
- 32** PICTURE MEMORY button (45)
- 33** PICTURE NAVI (picture navigation) button (55)
- 34** ALBUM +/- buttons (33)(65)
- 35** PICTURE MODE button (62)
- 36** ANGLE button (61)

* Use the tactile dot as a reference when operating the player.

Guide to the Control Menu Display

Use the Control Menu to select a function and to view related information. After sliding the TV/DISC EXPLORER/DVD switch to DVD, press DISPLAY/FILE repeatedly to turn on or change the Control Menu display as follows:

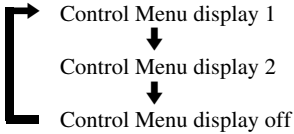

Control Menu





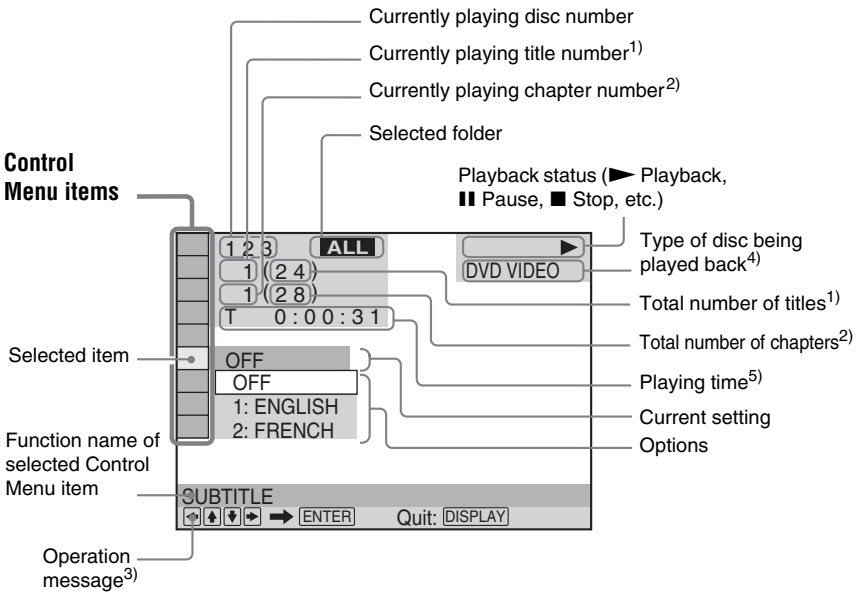











The Control Menu display 1 and 2 will show different items depending on the disc type. For details, see the pages in parentheses.











Example: Control Menu display 1 when playing a DVD VIDEO



- 1) Displays the scene number for VIDEO CDs (PBC is on), track number for VIDEO CDs/Super Audio CDs/CDs, album number for DATA CDs.
- 2) Displays the index number for VIDEO CDs/Super Audio CDs/CDs, MP3 audio track number or JPEG image file number for DATA CDs.
- 3) Displays the DISC MEMO or CD Text when the disc contains title information.
- 4) Displays Super VCD as "SVCD."
- 5) Displays the date for JPEG files.

List of Control Menu items

Item	Item Name, Function, Relevant Disc Type
	DISC (page 53) Selects the disc to be played. DVD-V DVD-RW VIDEO CD C D DATA-CD Super Audio CD
	TITLE (page 53)/SCENE (page 53)/TRACK (page 53) Selects the title, scene, or track to be played. DVD-V DVD-RW VIDEO CD
	CHAPTER (page 53)/INDEX (page 53) Selects the chapter or index to be played. DVD-V DVD-RW VIDEO CD
	ALBUM (page 53) Selects the album to be played. DATA-CD
	TRACK (page 53) Selects the track to be played. C D DATA-CD Super Audio CD
	INDEX (page 53) Selects the index to be played. C D Super Audio CD
	FILE (page 53) Selects the JPEG image file to be played. DATA-CD *
	DATE (page 67) Displays the date the picture was taken by a digital camera. DATA-CD *
	ORIGINAL/PLAY LIST (page 36) Selects the type of titles (DVD-RW) to be played, the ORIGINAL one, or an edited PLAY LIST. DVD-RW
	TIME/MEMO (page 53) Checks the elapsed time and the remaining playback time. Use to input the time code when searching for a scene or music. Displays the Disc Memo you entered in the edit mode of the Disc Explorer function (page 57). DVD-V DVD-RW VIDEO CD C D Super Audio CD
	TIME/TEXT (page 53) Checks the elapsed time and the remaining playback time. Use to input the time code when searching for a scene or music. Displays the DVD/Super Audio CD/CD text or the DATA CD's track name (page 57). DVD-V DVD-RW VIDEO CD C D DATA-CD Super Audio CD
	MULTI/2CH (page 37) Selects the playback area on Super Audio CDs when available. Super Audio CD
	AUDIO (page 59) Changes the audio setting. DVD-V DVD-RW VIDEO CD C D DATA-CD
	SUBTITLE (page 61) Displays the subtitles. Changes the subtitle language. DVD-V DVD-RW
	ANGLE (page 61) Changes the angle. DVD-V
	PARENTAL CONTROL (page 70) Set to prohibit playback on this player. DVD-V DVD-RW VIDEO CD C D DATA-CD Super Audio CD

	<p>SETUP (page 76) QUICK Setup Use Quick Setup to choose the desired language of the on-screen display, the aspect ratio of the TV, the audio output signal, and the size of the speakers you are using. CUSTOM Setup In addition to the Quick Setup setting, you can adjust various other settings. RESET Returns the settings in "SETUP" to the default setting.</p> <p>DVD-V DVD-RW VIDEO CD C D DATA-CD Super Audio CD</p>
	<p>ALL DISCS/ONE DISC (page 39) Selects All Discs or One Disc mode.</p> <p>DVD-V DVD-RW VIDEO CD C D DATA-CD Super Audio CD</p>
	<p>PROGRAM (page 39) Selects the disc, album, or track to play in the order you want.</p> <p>C D DATA-CD** Super Audio CD</p>
	<p>SHUFFLE (page 41) Plays the disc, album or track in random order.</p> <p>DVD-V DVD-RW VIDEO CD C D DATA-CD** Super Audio CD</p>
	<p>REPEAT (page 41) Plays the entire disc (all titles/all tracks/all albums) repeatedly or one title/chapter/track/album repeatedly.</p> <p>DVD-V DVD-RW VIDEO CD C D DATA-CD Super Audio CD</p>
	<p>A-B REPEAT (page 42) Specifies the parts you want to play repeatedly.</p> <p>DVD-V DVD-RW VIDEO CD C D DATA-CD** Super Audio CD</p>
	<p>CUSTOM PICTURE MODE (page 62) Adjusts the video signal from the player. You can select the picture quality that best suits the program you are watching.</p> <p>DVD-V DVD-RW VIDEO CD DATA-CD*</p>
	<p>SHARPNESS (page 63) Exaggerates the outline of the image to produce a sharper picture.</p> <p>DVD-V DVD-RW VIDEO CD DATA-CD*</p>
	<p>INTERVAL (page 69) Specifies the duration for which the slides are displayed on the screen.</p> <p>DATA-CD*</p>
	<p>EFFECT (page 69) Selects the effects to be used for changing slides during a slide show.</p> <p>DATA-CD*</p>
	<p>MODE (MP3, JPEG) (page 68) Selects the data type; MP3 audio track (AUDIO) or JPEG image file (IMAGE) to be played when playing a DATA CD.</p> <p>DATA-CD</p>

* JPEG only

** MP3 only

Hints

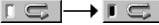
The Control Menu icon indicator lights up in green  when you select any item except "OFF." ("PROGRAM," "SHUFFLE," "REPEAT," "A-B REPEAT," and "SHARPNESS" only).

The other Control Menu icon indicator lights up in green when:

- "ANGLE": when the angles can be changed.
- "CUSTOM PICTURE MODE": when any setting other than "STANDARD" is selected.
- "ORIGINAL/PLAYLIST": when "PLAYLIST" is selected.
- "MULTI/2CH": when "MULTI" is selected.

Hooking Up the Player

Follow steps 1 to 6 to hook up and adjust the settings of the player.

Notes

- Plug cords securely to prevent unwanted noise.
- Refer to the instructions supplied with the components to be connected.
- You cannot connect this player to a TV that does not have a video input jack.
- Be sure to disconnect the power of each component before connecting.

Step 1: Unpacking

Check that you have the following items:

- Audio/video cord (pinplug × 3 ↔ pinplug × 3) (1)
- Remote commander (remote) (1)
- Size AA (R6) batteries (2)

Step 2: Preparing the Remote

You can control the player using the supplied remote. Insert two Size AA (R6) batteries by matching the ⊕ and ⊖ ends on the batteries to the markings inside the compartment. When using the remote, point it at the remote sensor  on the player.

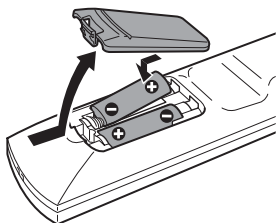

Notes

- Do not leave the remote in an extremely hot or humid place.
- Do not drop any foreign object into the remote casing, particularly when replacing the batteries.
- Do not expose the remote sensor to direct sunlight or lighting apparatus. Doing so may cause a malfunction.
- If you do not use the remote for an extended period of time, remove the batteries to avoid possible damage from battery leakage and corrosion.

When you have more than one Sony DVD player

If the supplied remote interferes with your other Sony DVD player, change the command mode setting for this player and the supplied remote to one that differs from the other Sony DVD player.

The default command mode setting for this player and the supplied remote is DVD 1.

To change the setting for the remote

- 1 Slide the COMMAND MODE switch on the remote to select the command mode (DVD 1, DVD 2, or DVD 3) so that the setting for the remote differs from that of the other DVD players.

For example, if the other DVD players respond to the default command mode setting for the supplied remote (DVD 1), set the remote to DVD 2 or DVD 3.

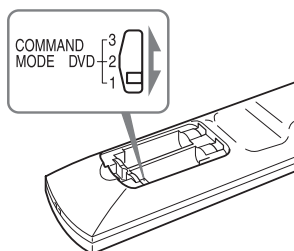

To change the setting for the player

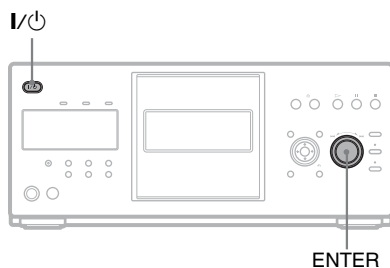

- 1 Press **I/O** to turn off the system.
- 2 Hold down **ENTER** on the player and press **I/O** on the player. The command mode appears on the front panel display.

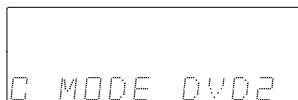

- 3 Repeat steps 1 and 2 until the displayed command mode matches that of the supplied remote.

Step 3: Connecting the Video/HDMI Cords

Connect this player to your TV monitor, projector, or AV amplifier (receiver) using a video cord. Select one of the patterns **A** through **D**, according to the input jack on your TV monitor, projector, or AV amplifier (receiver). In order to view progressive signal pictures with a compatible TV, projector, or monitor, you must use pattern **C**. Select pattern **D** when connecting to a TV, projector, or AV amplifier (receiver) equipped with HDMI input.

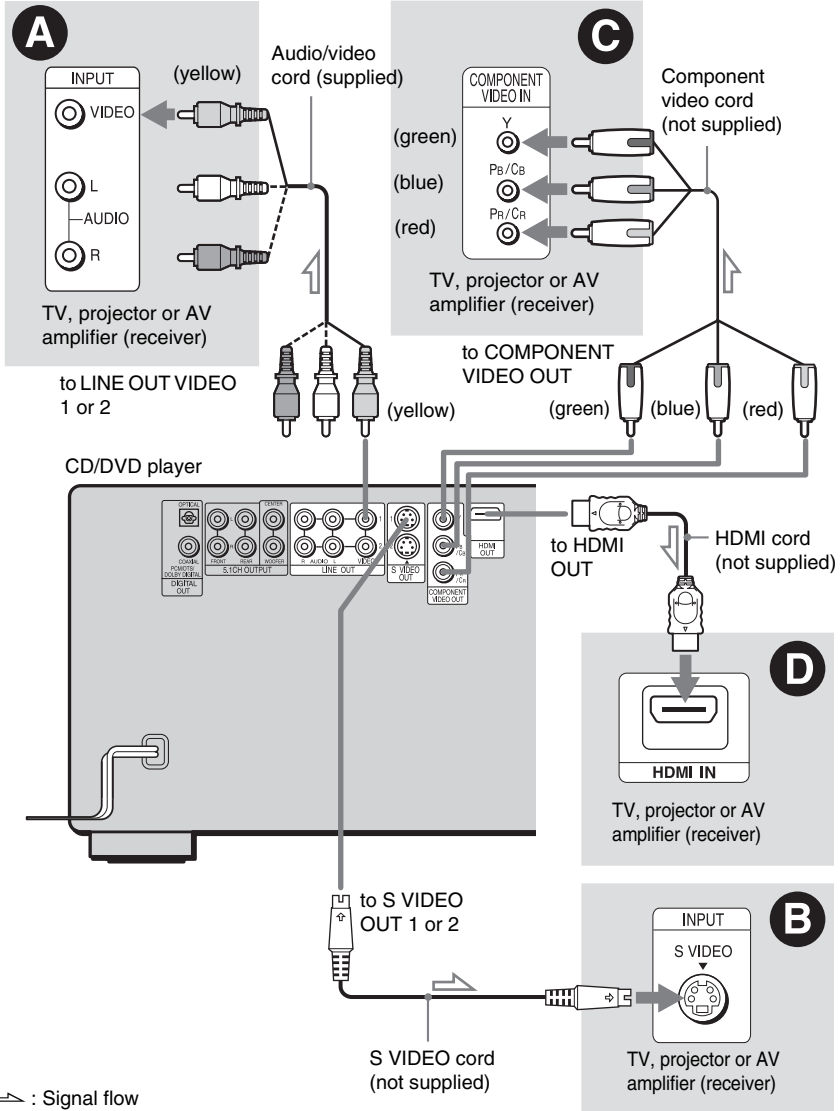

A If you are connecting to a video input jack

Connect the yellow plug of the audio/video cord (supplied) to the yellow (video) jacks. You will enjoy standard quality images.



Use the red and white plugs to connect to the audio input jacks (page 21). (Do this if you are connecting to a TV only.)

B If you are connecting to an S VIDEO input jack

Connect an S VIDEO cord (not supplied). You will enjoy high quality images.



C If you are connecting to a monitor, projector, or AV amplifier (receiver) having component video input jacks (Y, P_b/C_b, P_r/C_r)

Connect the component via the COMPONENT VIDEO OUT jacks using a component video cord (not supplied) or three video cords (not supplied) of the same kind and length. You will enjoy accurate color reproduction and high quality images. If your TV accepts progressive 480p format signals, you must use this connection and set “COMPONENT OUT” in “SCREEN SETUP” to “PROGRESSIVE” (page 79).

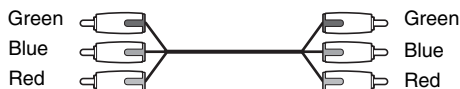

D If you are connecting to an HDMI/DVI input jack

Use a certified HDMI cord (not supplied) to enjoy high quality digital picture and sound through the HDMI OUT jack.

Note that Super Audio CD sound is not output from the HDMI OUT jack.



To connect to a TV with DVI input

Use an HDMI-DVI converter cord (not supplied). The DVI jack will not accept any audio signals, so you have to use another audio connection in addition to this connection (page 20). Furthermore, you cannot connect the HDMI OUT jack to DVI jacks that are not HDCP compliant (e.g., DVI jacks on PC displays).

To change the aspect ratio for the connected TV

Depending on the disc and the TV type (standard 4:3 screen TV or wide screen TV), the image may not fit the TV screen. If this happens, change the aspect ratio (page 78).

Notes

- Connect the player directly to the TV. If you pass the player signals via the VCR, you may not receive a clear image on the TV screen.

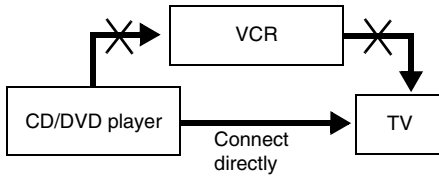

- Consumers should note that not all high definition television sets are fully compatible with this product and may cause artifacts to be displayed in the picture. In case of 480 progressive scan picture problems, it is recommended that the user switch the connection to the 'standard definition' output. If there are questions regarding our TV set compatibility with this model 480p DVD player, please contact our customer service center.
- If the picture appears too white when you are using **A** or **B** connection, set "BLACK LEVEL" in "SCREEN SETUP" to "OFF" (page 79).

Step 4: Connecting the Audio Cords

Refer to the chart below to select the connection that best suits your system. Be sure to also read the instructions for the components you wish to connect.

Select a connection

Select one of the following connections, **A** through **D**.

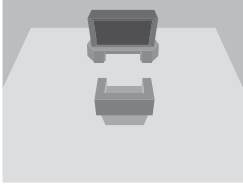
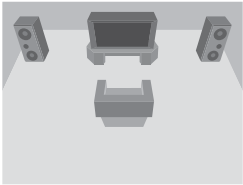
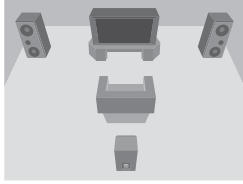
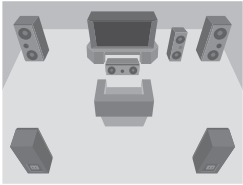
Components to be connected	Connection	Your setup (example)
<u>TV</u>	A (page 21)	
Stereo amplifier (receiver) and two speakers <u>MD deck/DAT deck</u> • Surround effects: – None	B (page 22)	
AV amplifier (receiver) having a Dolby* Surround (Pro Logic) decoder and 3 to 6 speakers • Surround effects: – Dolby Surround (Pro Logic) (page 89)	C (page 23)	
AV amplifier (receiver) with 5.1 ch input jacks and 4 to 6 speakers • Surround effects: – Dolby Digital (5.1 ch) (page 89) – DTS (5.1 ch) (page 89) – Super Audio CD Multi channel (page 90) or AV amplifier (receiver) with digital input jacks having a Dolby or DTS** decoder and 6 speakers • Surround effects: – Dolby Digital (5.1 ch) (page 89) – DTS (5.1 ch) (page 89)	D (page 24)	

Hint

If you have an AV amplifier that conforms to the 96 kHz sampling frequency, use connection **D**.

* Manufactured under license from Dolby Laboratories. “Dolby,” “Pro Logic,” and the double-D symbol are trademarks of Dolby Laboratories.

** “DTS” and “DTS Digital Surround” are registered trademarks of Digital Theater Systems, Inc.

A Connecting to your TV

This connection will use your TV's speakers for sound.

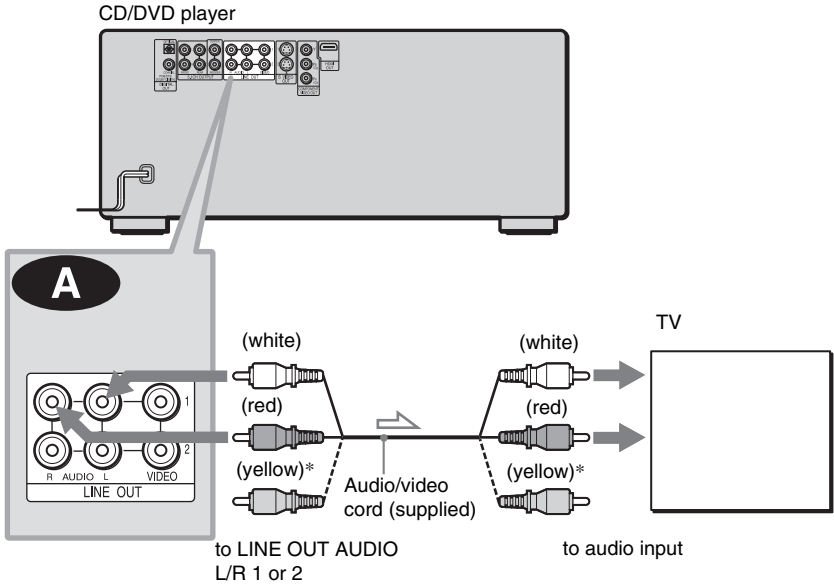

→ : Signal flow

* The yellow plug is used for video signals (page 17).

Hint

When connecting to a monaural TV, use a stereo-mono conversion cord (not supplied). Connect the LINE OUT AUDIO L/R 1 or 2 jacks to the TV's audio input jack.

B Connecting to a stereo amplifier (receiver) and 2 speakers/Connecting to an MD deck or DAT deck

If the stereo amplifier (receiver) has audio input jacks L and R only, use **B-1**. If the amplifier (receiver) has a digital input jack, or when connecting to an MD deck or DAT deck, use **B-2**. In this case, you can also connect the player directly to the MD deck or DAT deck without using your stereo amplifier (receiver).

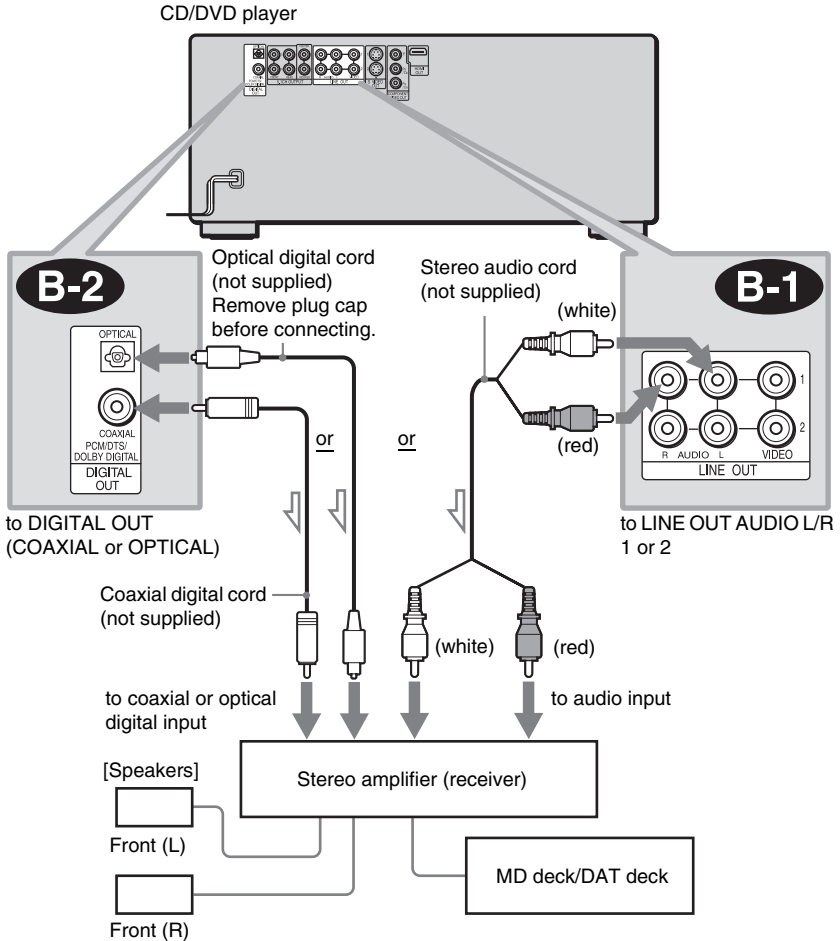

⇒: Signal flow

Hint

To realize better surround sound effects, make sure that your listening position is in between your speakers.

Note

Super Audio CD audio signals are not output from the DIGITAL OUT (COAXIAL or OPTICAL)/HDMI OUT jack.

C Connecting to an AV amplifier (receiver) having a Dolby Surround (Pro Logic) decoder and 3 to 6 speakers

You can enjoy the Dolby Surround effects only when playing Dolby Surround audio or multi-channel audio (Dolby Digital) discs.

If your amplifier (receiver) has L and R audio input jacks only, use **C-1**. If your amplifier (receiver) has a digital input jack, use **C-2**.

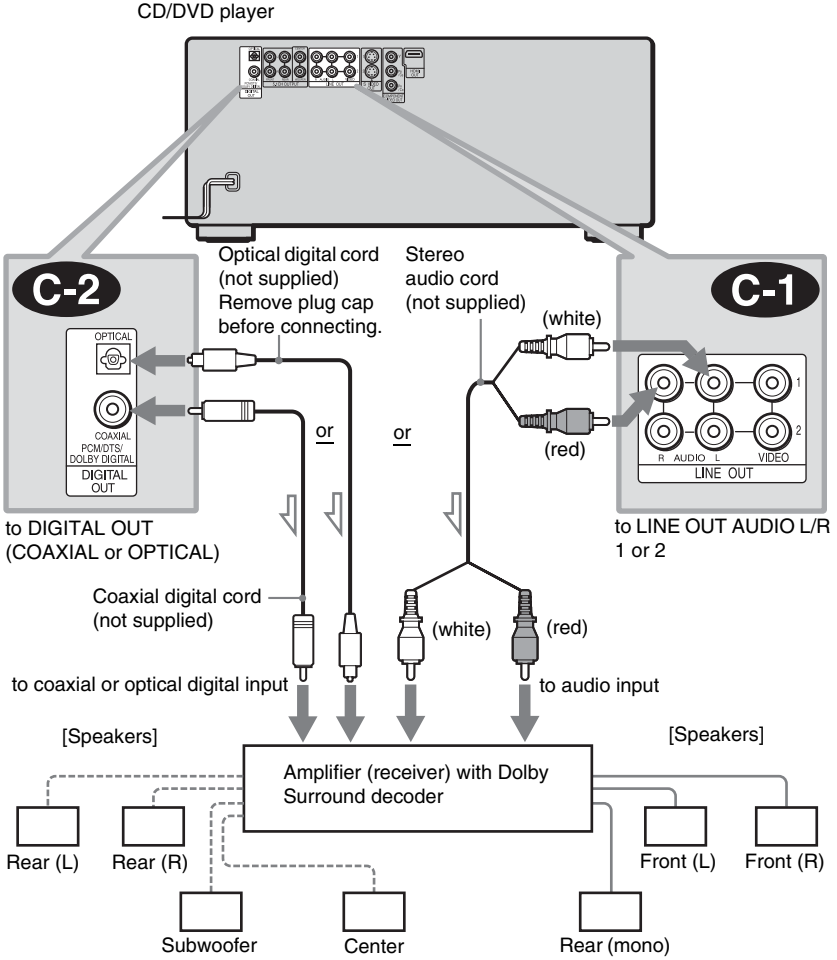

⇒ : Signal flow

Hint

For correct speaker location, refer to the operating instructions of the amplifier (receiver).

Notes

- When connecting 6 speakers, replace the monaural rear speaker with a center speaker, 2 rear speakers and a subwoofer.
- Super Audio CD audio signals are not output from the DIGITAL OUT (COAXIAL or OPTICAL)/HDMI OUT jack.

→ continued

D Connecting to an AV amplifier (receiver) with 5.1 ch input jacks and/or a digital input jack and 4 to 6 speakers

If your AV amplifier (receiver) has 5.1 channel inputs, use **D-1**.

If you want to use the Dolby Digital, or DTS decoder function on your AV amplifier (receiver), connect to its digital jack using **D-2** or **D-3**. With the following connections, you can enjoy a more realistic audio presence in the comfort of your own home.

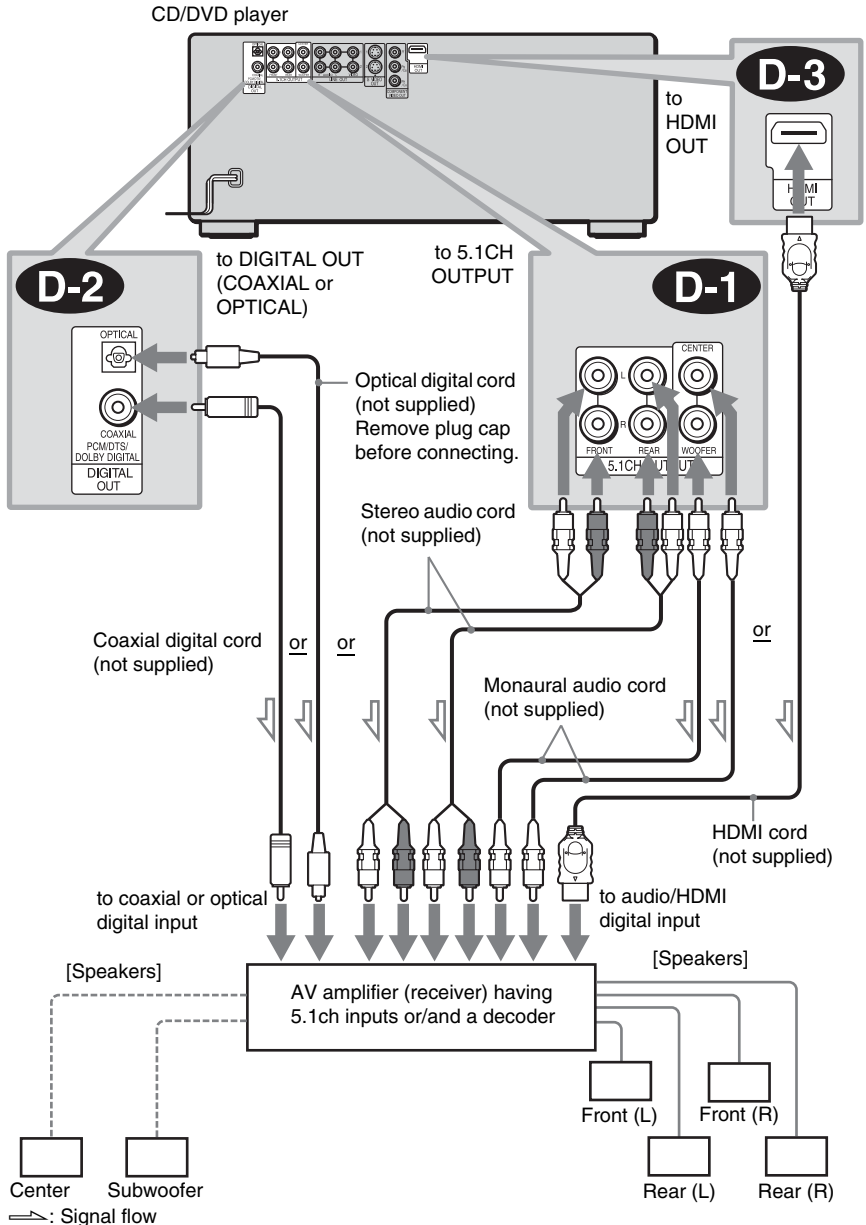

D-1 : Connecting to the 5.1ch input jacks

You can enjoy 5.1ch surround sound using the internal Dolby Digital, DTS, or Super Audio CD Multi decoder of this player.

D-2 or D-3 : Connecting to a digital jack

This connection will allow you to use the Dolby Digital, or DTS decoder function of your AV amplifier (receiver).

 **Hints**

- For correct speaker placement, refer to the instructions of the connected components.
- To enhance the sound performance:
 - Use high-performance speakers.
 - Use front, rear, and center speakers of the same size and performance.
 - Place the subwoofer between the left and right front speakers.

Notes**For connection D-2 or D-3**

- After you have completed the connection, be sure to set “DOLBY DIGITAL” to “DOLBY DIGITAL” and “DTS” to “DTS” in Quick Setup (page 26).
- When you connect an amplifier (receiver) that conforms to the 96 kHz sampling frequency, set “48kHz/96kHz PCM” in “AUDIO SETUP” to “96kHz/24bit” (page 81).
- Super Audio CD audio signals are not output from the DIGITAL OUT (COAXIAL or OPTICAL)/HDMI OUT jack.
- When you connect the player to an AV amplifier (receiver) using an HDMI cord, you will need to do one of the following:
 - Connect the AV amplifier (receiver) to the TV with the HDMI cord.
 - Connect the player to the TV with a video cord other than HDMI cord (component video cord, S VIDEO cord, or audio/video cord).

Step 5: Connecting the Power Cord

Plug the power cords of the player and TV into an AC outlet.

Step 6: Quick Setup

Follow the steps below to make the minimum number of basic adjustments for using the player. To skip an adjustment, press **▶▶I**. To return to the previous adjustment, press **I◀◀**.

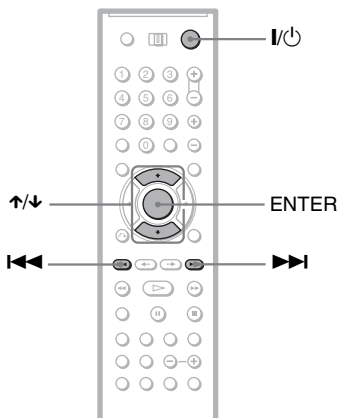

- 1 Turn on the TV.**
- 2 Press I/⏻.**
- 3 Switch the input selector on your TV so that the signal from the player appears on the TV screen.**

“Press [ENTER] to run QUICK SETUP” appears at the bottom of the screen. If this message does not appear, select “QUICK” under “SETUP” in the Control Menu to run Quick Setup (page 77).

- 4 Press ENTER before inserting a disc.**

The Setup Display for selecting the language used in the on-screen display appears.

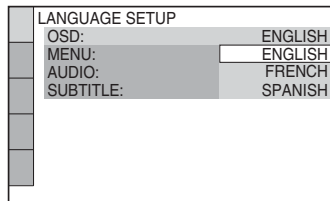

- 5 Press ↑/↓ to select a language.**

The player uses the language selected here to display the menu and subtitles as well.

6 Press ENTER.

The Setup Display for selecting the aspect ratio of the TV to be connected appears.

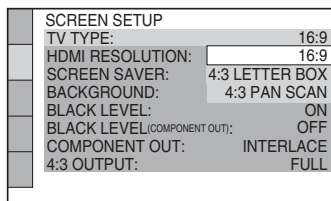

7 Press \uparrow/\downarrow to select the setting that matches your TV type.

◆ If you have a wide-screen TV or a 4:3 standard TV with a wide-screen mode

- 16:9 (page 78)

◆ If you have a 4:3 standard TV

- 4:3 LETTER BOX or 4:3 PAN SCAN (page 78)

8 Press ENTER.

The Setup Display for selecting the type of video signal appears.

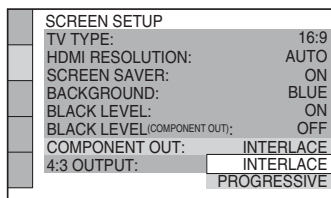

9 Press \uparrow/\downarrow to select the type of signals you wish to output to your TV.

Select “PROGRESSIVE” only if you have made video connection **C** (page 17) and wish to view progressive video signals.

◆ **Interlace format TV (standard TV)**

- INTERLACE (page 79)

◆ **Progressive format TV**

- PROGRESSIVE (page 79)

After selecting, the confirmation display appears. If you do not select “YES” or “NO” within about 10 seconds, the setting is canceled and the display returns to the Setup Display.

10 Press ENTER.

The Setup Display for selecting the type of jack used to connect your amplifier (receiver) appears.

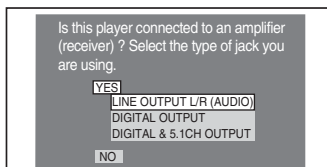

11 Press \uparrow/\downarrow to select the type of jack (if any) you are using to connect to an amplifier (receiver), then press ENTER.

Choose the item that matches the audio connection you selected on pages 21 to 25 (**A** through **D**).

- A**
- If you connect just a TV and nothing else, select “NO.” Quick Setup is finished and connections are complete.

- B-1** **C-1**
- Select “LINE OUTPUT L/R (AUDIO).” Quick Setup is finished and connections are complete.

- B-2** **C-2** **D-2** **D-3**
- Select “DIGITAL OUTPUT.” The Setup Display for “DOLBY DIGITAL” appears.

- D-1**, both **D-1** and **D-2**, or both **D-1** and **D-3**

- Select “DIGITAL & 5.1CH OUTPUT.” The display for “DOLBY DIGITAL” appears.

12 Press \uparrow/\downarrow to select the type of Dolby Digital signal you wish to send to your amplifier (receiver).

Choose the signal that matches the audio connection you selected on pages 22 to 24 (**B** through **D**).

AUDIO SETUP	
AUDIO ATT:	OFF
AUDIO FILTER:	SHARP
DOWNMIX:	DOLBY SURROUND
DIGITAL OUT:	ON
DOLBY DIGITAL:	D-PCM
DTS:	D-PCM
48kHz/96kHz PCM:	DOLBY DIGITAL
AUDIO(HDMI):	AUTO

B-2 **C-2**

- D-PCM (page 82)

D-2 **D-3**

- DOLBY DIGITAL (only if the amplifier (receiver) has a Dolby Digital decoder) (page 82)

13 Press ENTER.

“DTS” is selected.

AUDIO SETUP	
AUDIO ATT:	OFF
AUDIO FILTER:	SHARP
DOWNMIX:	DOLBY SURROUND
DIGITAL OUT:	ON
DOLBY DIGITAL:	D-PCM
DTS:	D-PCM
48kHz/96kHz PCM:	D-PCM
AUDIO(HDMI):	DTS

14 Press \uparrow/\downarrow to select the type of DTS signal sent to your amplifier (receiver).

Choose the item that matches the audio connection you selected on pages 22 to 24 (**B** through **D**).

B-2 **C-2**

- D-PCM (page 82)

D-2 **D-3**

- DTS (only if the amplifier (receiver) has a DTS decoder) (page 82)

15 Press ENTER.

◆ When “DIGITAL OUTPUT” is selected in step 11

- Quick Setup is finished and connections are complete.

◆ When “DIGITAL & 5.1CH OUTPUT” is selected in step 11

- The Setup Display for “SPEAKER SETUP” appears.

16 Press \uparrow/\downarrow to select the size of the center speaker.

If no center speaker is connected, select “NONE” (page 83).

SPEAKER SETUP	
SIZE:	
DISTANCE:	
LEVEL(FRONT):	
LEVEL(REAR):	
TEST TONE:	OFF
FRONT:	LARGE
CENTER:	LARGE
REAR:	LARGE
SUBWOOFER:	SMALL
	NONE

17 Press ENTER.

“REAR” is selected.

SPEAKER SETUP	
SIZE:	
DISTANCE:	
LEVEL(FRONT):	
LEVEL(REAR):	
TEST TONE:	OFF
FRONT:	LARGE
CENTER:	LARGE
REAR:	LARGE
SUBWOOFER:	LARGE
	SMALL
	NONE

18 Press \uparrow/\downarrow to select the size of the rear speakers.

If no rear speaker is connected, select “NONE.”

19 Press ENTER.

“SUBWOOFER” is selected.

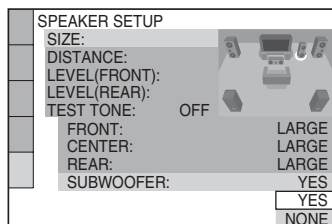

20 Press ↑/↓ to select whether or not you have connected a subwoofer.

21 Press ENTER.

Quick Setup is finished. All connections and setup operations are complete.

Enjoying the surround sound effects

To enjoy the surround sound effects of this player or your amplifier (receiver), set the following items as described below for the audio connection you selected on pages 22 to 24 (**B** through **D**). Each of these is the default setting and does not need to be adjusted when you first connect the player. See page 76 for using the Setup Display.

Audio connection (pages 21 to 24)

A

- No additional settings are needed.

B-1 C-1

- Set “DOWNMIX” to “DOLBY SURROUND” (page 81).

B-2 C-2 D-2 D-3

- Set “DOWNMIX” to “DOLBY SURROUND” (page 81).
- Set “DIGITAL OUT” to “ON” (page 81).

D-1

- Set “DISTANCE” and “LEVEL” according to the connected speakers (page 84).

💡 Hints

- For connections **B-1 C-1 D-1**
If the sound distorts even when the volume is turned down, set “AUDIO ATT” to “ON” (page 81).
- For connections **B-2 C-2 D-2 D-3**
Set “48 kHz/96 kHz PCM” to “96 kHz/24 bit” only if you connect an amplifier (receiver) that conforms to the 96 kHz sampling frequency (page 82).

Playing Discs

Inserting Discs

DVD-V

DVD-RW

VIDEO CD

Super Audio CD

CD

DATA-CD

You can insert up to 400 discs into this player.

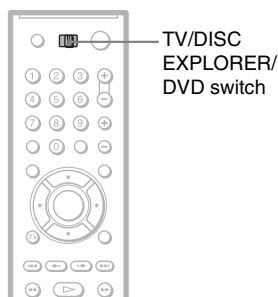
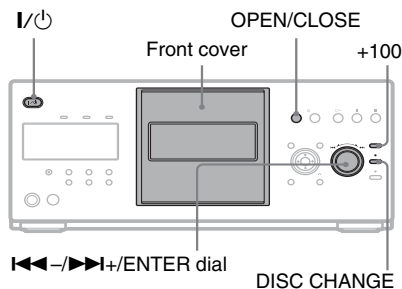

- 1 Slide the TV/DISC EXPLORER/DVD switch to DVD, then press I/⏻.**

The player turns on.

- 2 Press OPEN/CLOSE.**

The front cover opens.

- 3 Press DISC CHANGE.**

The DISC CHANGE indicator lights up.

- 4 While checking the disc slot number indicated on the front panel display or by the slot, turn the I◀◀-/▶▶I+/ENTER dial until you find the disc slot where you want to insert a disc.**

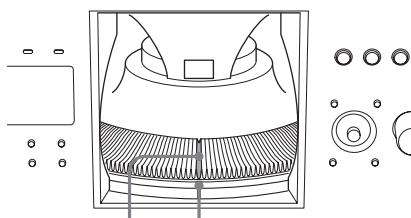

- 5 Insert a disc.**

Gently place the disc all the way into the slot and do not release the disc until it is completely seated. Make sure you have inserted the disc into each slot at a right angle to the rotary table. If the disc is not put in straight, it may damage the player or the disc.

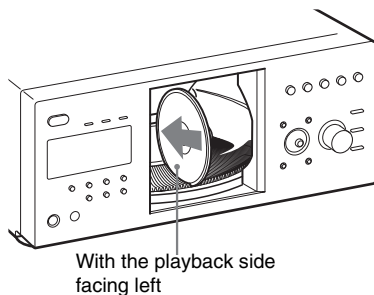

- 6 Repeat steps 4 and 5 to insert more discs.**

- 7 Press OPEN/CLOSE.**

The front cover closes. The rotary table turns and the disc slot selected in step 4 is set to the playing position.

Hint

In step 4, you can select a disc slot number by skipping 10 slots. After sliding the TV/DISC EXPLORER/DVD switch to DISC EXPLORER or DVD, press DISC SKIP +/- on the remote. 10 disc slots before or after the current disc slot number will be skipped. To skip 100 slots, press +100 on the player.

Notes

- Do not turn the turntable by hand.
- Do not reach inside of the turntable compartment. Always follow the correct steps for inserting and removing discs.
- When transporting the player, remove all discs from the player. Failure to remove the discs may cause damage to the player.
- When closing the front cover, be careful not to let anything get caught between the door and the player.

To remove discs

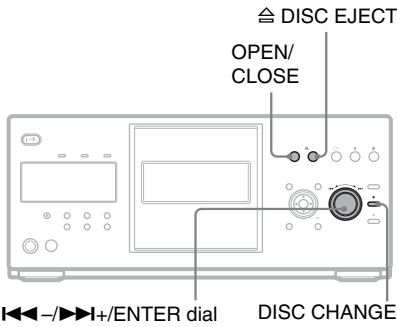

- 1 Press OPEN/CLOSE.
- 2 Press DISC CHANGE.
- 3 While checking the disc slot number indicated on the front panel display or by the slot, turn the ◀◀-/▶▶I+/ENTER dial until you find the disc you want to remove.

- 4 Press ≡ DISC EJECT.
The loading guide rises so that you can remove the disc easily.

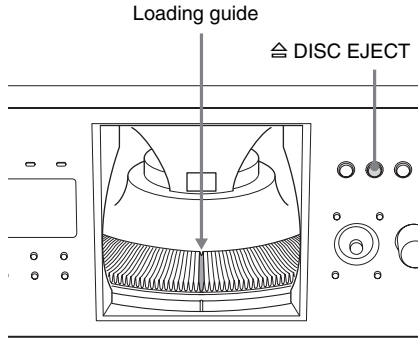

- 5 Remove the disc.
- 6 Repeat steps 3 to 5 to remove other discs.
- 7 Press OPEN/CLOSE.
The front cover closes.

Hint

You can remove the current disc by directly pressing ≡ DISC EJECT on the player.

Playing Discs

DVD-V DVD-RW

VIDEO CD

Super Audio CD

CD

DATA-CD

Depending on the disc, some operations may be different or restricted.

Refer to the operating instructions supplied with your disc.

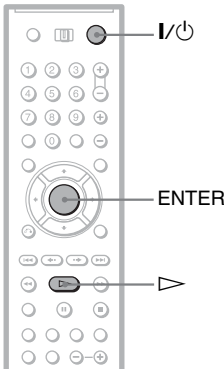
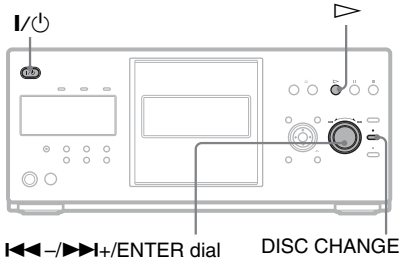

1 Turn on your TV.

2 Press I/⏻.

The player turns on.

3 Switch the input selector on your TV so that the signal from the player appears on the TV screen.

◆ **When using an amplifier (receiver)**



Turn on the amplifier (receiver) and select the appropriate channel so that you can hear sound from the player.



4 Press .

The player starts playing the selected disc. Adjust the volume on the TV or the amplifier (receiver).

Depending on the disc, a menu may appear on the TV screen. For DVD VIDEOS, see page 35. For VIDEO CDs, see page 38.

To change the disc

Press DISC CHANGE to turn the indicator on. Then turn the -+ENTER dial until the desired disc number appears on the front panel display.

Press the -+ENTER dial to start playback.

To turn off the player

Press I/⏻. The player enters standby mode.

Hints

- You can have the player turn off automatically whenever you leave it in stop mode for more than 30 minutes. To turn on this function, set "AUTO POWER OFF" in "CUSTOM SETUP" to "ON" (page 80).
- For details on the types of MP3 audio tracks that you can play on this player, or on their playback order, see "Enjoying MP3 Audio and JPEG Images" (page 64).
- You can select to play a disc from a list of all the discs inserted in the player. For details, see "Displaying the Disc Information" (page 43).

Note

Super Audio CD audio signals are not output from the DIGITAL OUT (COAXIAL or OPTICAL)/HDMI OUT jack.

Additional operations

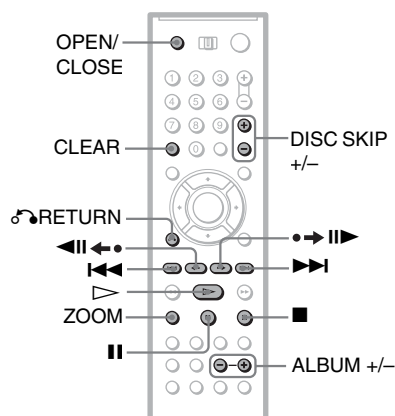
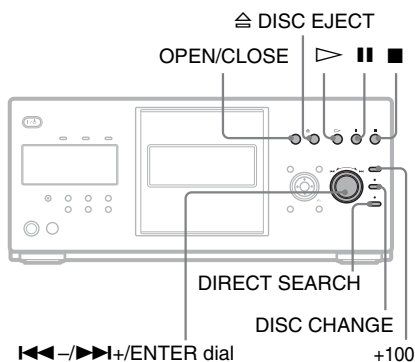

To	Operation
Select a disc	<p>On the player: Press DISC CHANGE to turn the indicator on. Then turn the I◀◀-/▶▶I+/ENTER dial until the desired disc number appears on the front panel display. Press the I◀◀-/▶▶I+/ENTER dial to start playback.</p> <p>On the remote: Press DISC SKIP +/- until the desired disc number appears on the front panel display.</p>

To	Operation
Skip disc slots	<p>On the player: To skip 100 disc slots ahead, press +100. Press ENTER to start playback.</p> <p>On the remote: After sliding the TV/DISC EXPLORER/DVD switch to DISC EXPLORER or DVD, press DISC SKIP +/-.</p>
Stop	Press ■.
Pause	Press II.
Resume play after pause	Press II or ▷.
Go to the next chapter, track, or scene in continuous play mode	<p>On the player: Press DIRECT SEARCH to turn the indicator on. Then turn the I◀◀-/▶▶I+/ENTER dial clockwise.</p> <p>On the remote: Press ▶▶I.</p>
Go back to the previous chapter, track, or scene in continuous play mode	<p>On the player: Press DIRECT SEARCH to turn the indicator on. Then turn the I◀◀-/▶▶I+/ENTER dial counterclockwise.</p> <p>On the remote: Press I◀◀ twice.</p>
Stop play and remove the disc	On the player: Press ≡ DISC EJECT.
Replay the previous scene ¹⁾	Press ◀◀ II ◀◀ (Replay).
Briefly fast forward the current scene ¹⁾	Press ◀◀ II ▶▶ (Advance).
Magnify the image ²⁾	Press ZOOM repeatedly. Press CLEAR to cancel.
Go to the next or previous album ³⁾	Press ALBUM + or - during playback

1) DVD-V/DVD-RW only

2) DVD-V/DVD-RW/VIDEO CD/DATA-CD (JPEG) only

3) DATA-CD only

Hints



- The Replay function is useful when you want to review a scene or dialog that you missed.
- The Advance function is useful when you want to pass over a scene that you don't want to watch.

Notes

- You may not be able to use the Replay or Advance function with some scenes.
- The Replay function does not work with DVD+RWs in VR mode.

Locking the front cover (Child Lock)



You can lock the front cover to prevent children from opening it.

When the player is in standby mode, press  RETURN, ENTER, and then  on the remote.

The player turns on and "LOCKED" appears on the front panel display.

The OPEN/CLOSE button on the player and the remote do not work while the Child Lock is set.

To unlock the front cover

When the player is in standby mode, press  RETURN, ENTER, and then  again. "UNLOCKED" appears on the front panel display.

Note

Even if you select "RESET" under "SETUP" in the Control Menu (page 77), the front cover remains locked.

Resuming Playback From the Point Where You Stopped the Disc (Multi-disc

Resume)  

The player stores the point where you stopped the disc for up to 40 discs and resumes playback the next time you insert the same disc. If you store a resume playback point for the 41st disc, the resume playback point for the first disc is deleted.

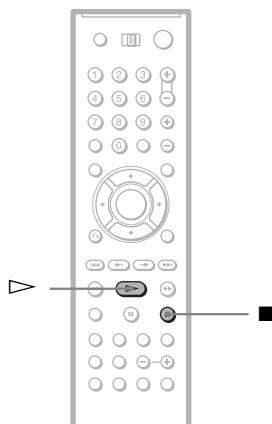



1 While playing a disc, press  to stop playback.

"RESUME" appears on the front panel display.

2 Press .

The player starts playback from the point where you stopped the disc in step 1.

Hint

To play from the beginning of the disc, press  twice, then press .

Notes

- “MULTI-DISC RESUME” in “CUSTOM SETUP” must be set to “ON” for this function to work (page 80).
- The point where you stopped playing is cleared when:
 - you change the play mode.
 - you change the settings on the Setup Display.
- For DVD-RWs in VR mode, CDs, Super Audio CDs, and DATA CDs, the player remembers the resume playback point for the current disc. The resume point is cleared when:
 - you opened the front cover.
 - you disconnect the power cord.
 - the player enters standby mode (Super Audio CD, CD, and DATA CD only).
- Resume Play does not work during Shuffle Play and Program Play.
- This function may not work with some discs.

Using the DVD's Menu

DVD-V

A DVD is divided into long sections of a picture or a music feature called “titles.” When you play a DVD which contains several titles, you can select the title you want using the TOP MENU/EDIT button. When you play DVDs that allow you to select items such as the language for the subtitles and the language for the sound, select these items using the MENU/SORT button.

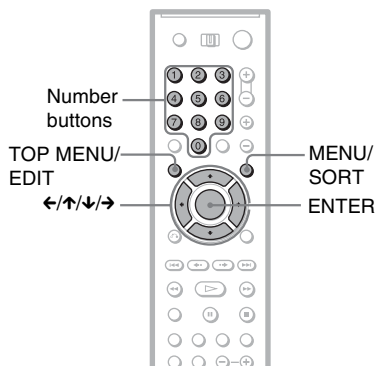

1 Select a disc (page 33).

2 Press **TOP MENU/EDIT** or **MENU/SORT**.

The disc's menu appears on the TV screen. The contents of the menu vary from disc to disc.

3 Press **←/↑/↓/→** or the **number buttons** to select the item you want to play or change.

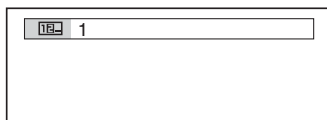

4 Press **ENTER**.

Selecting “ORIGINAL” or “PLAY LIST” on a DVD-RW

DVD-RW

Some DVD-RWs in VR (Video Recording) mode have two types of titles for playback: originally recorded titles (ORIGINAL) and edited titles created on recordable DVD players (PLAY LIST). You can select the type of titles to be played.

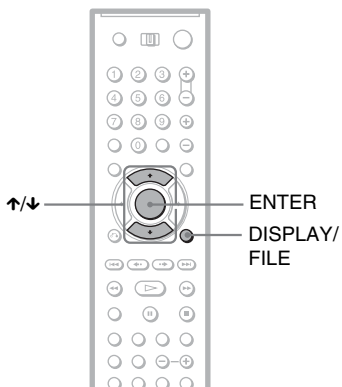

1 Select a disc (page 33).

2 Press DISPLAY/FILE while the player is in stop mode.

The Control Menu appears.

3 Press \uparrow/\downarrow to select  (ORIGINAL/PLAY LIST), then press ENTER.

The options for “ORIGINAL/PLAY LIST” appear.

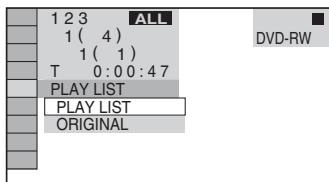

4 Press \uparrow/\downarrow to select the setting.

- PLAY LIST: plays the titles created from “ORIGINAL.”
- ORIGINAL: plays the titles originally recorded.

5 Press ENTER.

To turn off the Control Menu

Press DISPLAY/FILE repeatedly until the Control Menu is turned off.

Selecting a Playback Area for a Super Audio CD

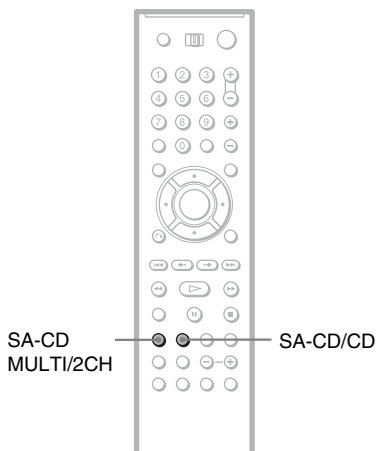

Hint

You can also select “MULTI/2CH” from the Control Menu (page 13).

Selecting the playback layer of hybrid Super Audio CDs

Some Super Audio CDs consist of a Super Audio CD layer and a CD layer. You can select the playback layer you want to listen to.

Press SA-CD/CD while the player is in stop mode.

Each time you press the button, a Super Audio CD layer or a CD layer is alternately selected.

When selecting a CD layer, the “CD” indicator in the front panel display lights up.

Notes

- For details about Super Audio CDs, see page 90.
- Each play mode function works only within the selected layer or playback area (page 39).

Selecting a playback area on a 2 channel + Multi-channel Super Audio CD

Some Super Audio CDs consist of a 2 channel playback area and a multi-channel playback area. You can select the playback area you want to listen to.

1 Press SA-CD MULTI/2CH while the player is in stop mode.

The following display appears.

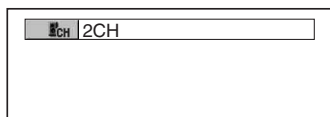

2 Press SA-CD MULTI/2CH repeatedly to select an item.

- MULTI: Plays a multi-channel playback area.
 - 2CH: Plays a 2 channel playback area.
- The “MULTI” indicator in the front panel lights up when selecting a multi-channel playback area.

Playing VIDEO CDs With PBC Functions (PBC Playback)

VIDEO CD

PBC (Playback Control) allows you to play VIDEO CDs interactively by following the menu on the TV screen.

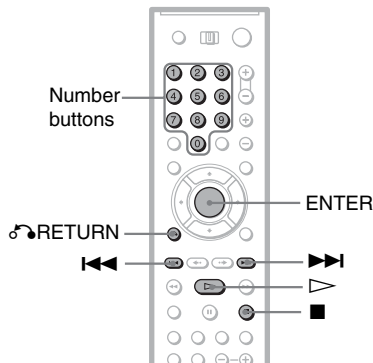

1 Start playing a VIDEO CD with PBC functions.

A menu appears.

2 Select the item number and track you want using the number buttons.

3 Press ENTER.

4 Follow the instructions in the menu for interactive operations.

Refer to the instructions supplied with the disc, as the operating procedure may differ depending on the VIDEO CD.

To return to the menu

Press RETURN.

Hint

To play without using PBC, press **⏮/⏭** while the player is stopped to select a track, then press **▶** or ENTER.

“Play without PBC.” appears on the TV screen and the player starts continuous play. You cannot play still pictures such as a menu.

To return to PBC playback, press **■** twice then press **▶**.

Note

Depending on the VIDEO CD, “Press ENTER” in step 3 may appear as “Press SELECT” in the instructions supplied with the disc. In this case, press **▶**.

Various Play Mode Functions

(Program Play, Shuffle Play, Repeat Play, A-B Repeat Play)

You can set the following play modes:

- Program Play (page 39)
- Shuffle Play (page 41)
- Repeat Play (page 41)
- A-B Repeat Play (page 42)

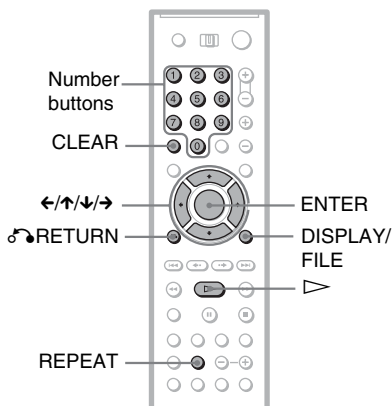

Notes

- The play mode is canceled when:
 - you open the front cover.
 - you press **⏻** and the player enters standby mode.
- Before setting a play mode for Super Audio CDs, select the playback layer or area you want to listen to (page 37). Each play mode function works only within the selected layer or playback area.
- You cannot activate Program Play and Shuffle Play at the same time.

Selecting the disc mode (One Disc or All Discs, ALL ALBUMS or ONE ALBUM)

DVD-V DVD-RW VIDEO CD

Super Audio CD CD DATA-CD

You can play one disc or all of the discs in the player. In the case of DATA CDs, you can play one album or all of the albums in the disc. Before setting Shuffle Play or Repeat Play, you must select whether to apply these play modes to one disc or to all of the discs.

1 Press DISPLAY/FILE twice during playback.

The Control Menu appears.

2 Press ↑/↓ to select or (ONE/ALL DISCS) and press ENTER.

The options for “ONE DISC/ALL DISCS” appear.

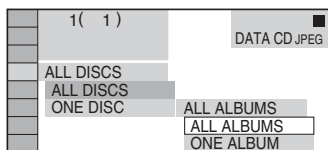

3 Press ↑/↓ to select an item.

- ALL DISCS: Continuously plays all of the discs.
- ONE DISC: Plays the selected disc.
 - ALL ALBUMS*: Plays the selected disc
 - ONE ALBUM*: Plays the selected album.

4 Press ENTER.

* DATA CD only

Hint

You can also select “ONE DISC/ALL DISCS” by pressing ONE/ALL DISCS on the player.

Creating your own program (Program Play)

Super Audio CD CD

DATA-CD

You can play the contents of a disc in the order you want by arranging the order of the tracks on the disc to create your own program.

You can program up to 99 items. You can create a program for all of the discs in the player.

1 Press DISPLAY/FILE twice (or once in the case of DATA CDs).

The Control Menu appears.

- 2** Press \uparrow/\downarrow to select **PROGRAM**, then press ENTER. The options for “PROGRAM” appear.

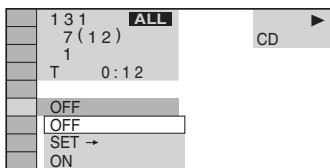

- 3** Press \uparrow/\downarrow to select “SET →” then press ENTER. The display for programming appears.

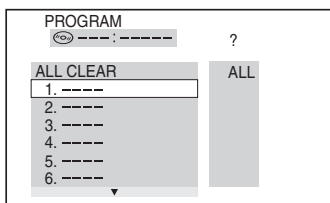

- 4** Press →. The player is ready to program the first disc.

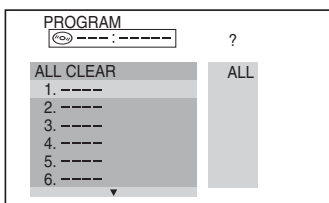

- 5** Select the disc you want to program using the number buttons or \uparrow/\downarrow , then press ENTER. The cursor moves to the title or track row “T” (in this case, “01”).

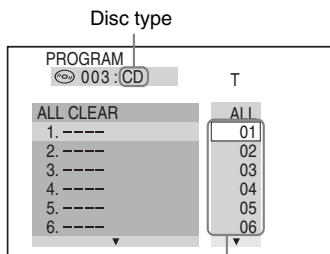

Titles or tracks recorded on a disc

“?” appears when the player has not loaded the disc information in the memory. If an empty slot is loaded, the disc type does not appear.

- 6** Select the track you want to program. For example, select track “04.” Press \uparrow/\downarrow or the number buttons to select “04” under “T,” then press ENTER.

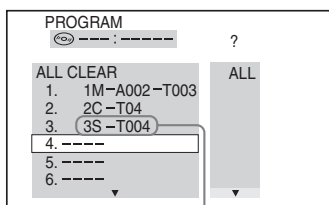

Selected disc and track

- 7** To program other discs or tracks, repeat steps 4 to 6. The programmed discs and tracks are displayed in the selected order.
- 8** Press \triangleright to start Program Play. Program Play begins. When the program ends, you can restart the same program again by pressing \triangleright .

To return to normal playback

Press CLEAR, or select “OFF” in step 3.

To turn off the display

Press DISPLAY/FILE repeatedly until the display is turned off.

To cancel or change a program

- Follow steps 1 to 3 of “Creating your own program (Program Play).”
- Select the program number of the disc or track you want to cancel or change using \uparrow/\downarrow .
- Perform the following.
 - ◆ **To cancel the program**
Press CLEAR.
 - ◆ **To change the program**
Press → and follow step 5 for new programming.

To cancel all of the discs or tracks in the program

- 1 Follow steps 1 to 3 of “Creating your own program (Program Play).”
- 2 Press **↑** and select “ALL CLEAR.”
- 3 Press **ENTER**.

Hint

You can set Repeat Play for the programmed tracks. During Program Play, follow the steps of “Repeat Play” (page 41).

Notes

- JPEG image files cannot be programmed.
- You cannot activate Program Play and Shuffle Play at the same time.

Playing in random order (Shuffle Play)

DVD-V **DVD-RW** **VIDEO CD** **Super Audio CD**

C D **DATA-CD**

You can have the player “shuffle” tracks. Subsequent “shuffling” may produce a different playing order. By selecting All Discs mode (page 39), you can shuffle all of the discs in the player.

- 1 Press **DISPLAY/FILE** twice (or once in the case of DATA-CDs).

The Control Menu appears.

- 2 Press **↑/↓** to select  (SHUFFLE), then press **ENTER**.

The options for “SHUFFLE” appear.

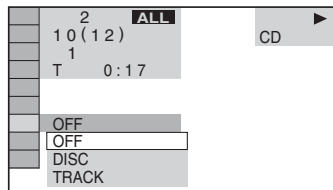

- 3 Press **↑/↓** to select the item to be shuffled.

◆ When playing a DVD VIDEO, DVD-RW or VIDEO CD

- DISC¹⁾

◆ When playing a Super Audio CD or CD

- DISC¹⁾

- TRACK

◆ When playing a DATA CD (MP3)

- DISC¹⁾
- ALBUM²⁾
- TRACK

- 4 Press **ENTER**.

1) You can select “DISC” in All Discs mode only.

2) “ALBUM” is not displayed when the disc mode is set to “ONE ALBUM” (page 39).

To return to normal play

Press **CLEAR**, or select “OFF” in step 3.

Notes

- You cannot activate Program Play and Shuffle Play at the same time.
- When there are more than 96 tracks or albums, they will be played in random order.

Playing repeatedly (Repeat Play)

DVD-V **DVD-RW** **VIDEO CD** **Super Audio CD** **C D**

DATA-CD

You can play all of the titles, albums or tracks on a disc or a single title, chapter, album, or track repeatedly.

You can use a combination of Shuffle or Program Play modes. By selecting All Discs mode (page 39), you can repeat all of the discs in the player.

- 1 Press **REPEAT**.

The following display appears.

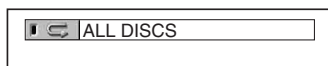

- 2 Press **REPEAT** repeatedly to select the item to be repeated.

◆ When playing a DVD VIDEO

- ALL DISCS: repeats all of the discs in All Discs mode.
- ONE DISC: repeats all of the titles on the current disc in One Disc mode.
- TITLE: repeats the current title.
- CHAPTER: repeats the current chapter.

◆ When playing a DVD-RW

- ALL DISCS: repeats all of the discs in All Discs mode.
- ONE DISC: repeats all of the titles on the selected type (ORIGINAL or PLAYLIST) in One Disc mode.

- **TITLE:** repeats the current title.
- **CHAPTER:** repeats the current chapter.

◆ **When playing a Super Audio CD, VIDEO CD, or CD**

- **ALL DISCS:** repeats all of the discs in All Discs mode.
- **ONE DISC:** repeats all of the titles on the current disc in One Disc mode.
- **TRACK:** repeats the current track.

◆ **When playing a DATA CD**

- **ALL DISCS:** repeats all of the discs in All Discs mode.
- **ONE DISC:** repeats all of the albums on the current disc in One Disc mode.
- **ALBUM:** repeats the current album in One Album mode.
- **TRACK (MP3 audio tracks only):** repeats the current track.

◆ **When Program Play or Shuffle Play is activated**

- **ON:** repeats Program Play or Shuffle Play (audio disc only.)

To return to normal play

Press CLEAR, or select “OFF” in step 2.

⚙️ Hints

- You can set Repeat Play while the player is stopped. After selecting the “REPEAT” option, press ▷. Repeat Play starts.
- You can also select “REPEAT” from the Control Menu (page 14).

Repeating a specific portion (A-B Repeat Play)

VIDEO CD Super Audio CD CD DATA-CD DVD-V DVD-RW

You can play a specific portion of a title, chapter or track repeatedly. (This function is useful when you want to memorize lyrics, etc.)

1 Press DISPLAY/FILE twice (or once in the case of DATA CDs) during playback.

The Control Menu appears.

2 Press ↑/↓ to select  (A-B REPEAT), then press ENTER.

The options for “A-B REPEAT” appear.

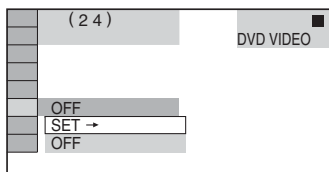

3 Press ↑/↓ to select “SET →,” then press ENTER.

The “A-B REPEAT” setting display appears.

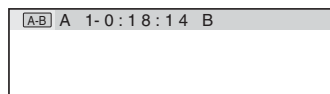

4 During playback, when you find the starting point (point A) of the portion to be played repeatedly, press ENTER.

The starting point (point A) is set.

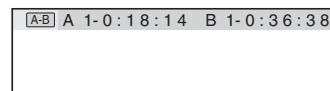

5 When you reach the ending point (point B), press ENTER again.

The set points are displayed and the player starts repeating this specific portion.

To return to normal play

Press CLEAR, or select “OFF” in step 2.

To turn off the Control Menu

Press DISPLAY/FILE repeatedly until the Control Menu is turned off.

Notes

- When you set A-B Repeat Play, the settings for Shuffle Play, Repeat Play, and Program Play are canceled.
- A-B Repeat Play does not work across multiple titles, scenes or MP3 tracks.
- A-B Repeat Play does not work if the title contains a JPEG image file when playing a DVD-RW in VR mode.
- A-B Repeat Play is canceled when ◀◀/▶▶, ◀◀, ▶▶, or ■ is pressed during A-B Repeat Play of a Super Audio CD.

Searching for and Managing Discs (Disc Explorer)

Displaying the Disc Information

DVD-V

DVD-RW

VIDEO CD

Super Audio CD

C D

DATA-CD

You can search for a disc by checking the contents of all the discs loaded in the player on your TV screen.

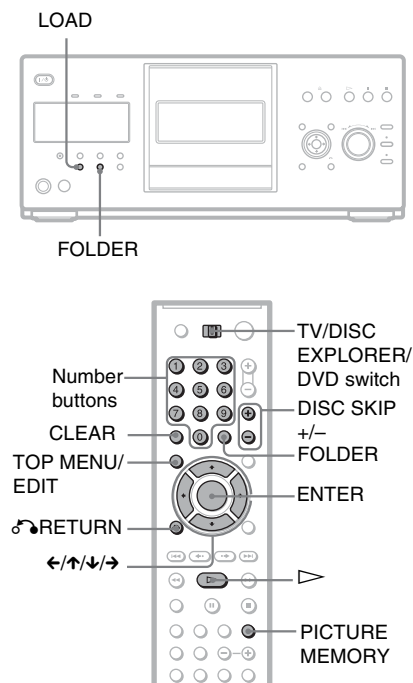

Hint

Slide the TV/DISC EXPLORER/DVD switch to DISC EXPLORER beforehand to use the function that is printed in blue on the remote.

Loading the disc information

Press **LOAD** when the player is in stop or standby mode.

The player reads the disc information of all the discs and loads it into memory so that the disc type, titles and other text information can be displayed.

To cancel loading

Press **■**.

Hint

The player can load the disc information even when the power is in standby mode. Press **LOAD** before turning on the player.

Viewing information about the loaded discs

You can view the loaded discs using the Disc Explorer.

The player has 8 folders (“ALL,” “VIDEO,” “MUSIC,” “PHOTO,” user folder (□)) (subfolders “A” to “D”) and can display the contents of each folder.

All of the discs in the player are filed in the “ALL” folder. At the same time, DVDs and VIDEO CDs are automatically filed in the “VIDEO” folder, Super Audio CDs, CDs, DATA CDs (MP3) are filed in the “MUSIC” folder, and DATA CDs (JPEG) are filed in the “PHOTO” folder. You can file your discs as you like in the “A” to “D” folders (page 46).

1 Slide the TV/DISC EXPLORER/DVD switch to DISC EXPLORER, then press FOLDER.

The Disc Explorer display appears. You can select the folder with the disc you want to play by pressing **←/→**.

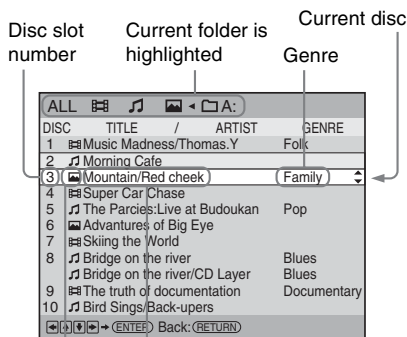

Text information (TITLE/ARTIST)

Media information

- VIDEO (DVD-V/DVD-RW/VIDEO CD)
- MUSIC (Super Audio CD/CD/DATA CD (MP3))
- PHOTO (DATA-CD (JPEG))

→ continued

2 Press \uparrow/\downarrow to select the disc, then press ENTER.

The pop-up menu appears.

3 Press \uparrow/\downarrow to select “Details,” then press ENTER.

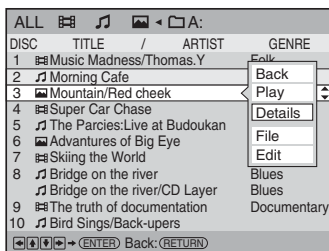

Hint

- If you press TIME/TEXT while the Disc Explorer display appears, you can change the position of TITLE and ARTIST.
- When you insert a Super Audio CD that has two playback areas or a DATA CD that contains MP3 audio tracks and JPEG image files, the information of both areas is displayed.

Detailed Disc Explorer display

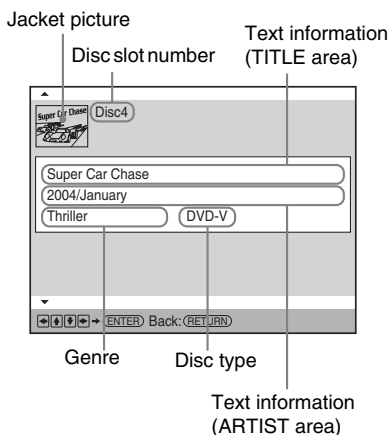

Hint

If you press \uparrow/\downarrow while the detailed Disc Explorer display appears, you can see the information of the previous/next discs.

◆ Jacket picture

The jacket picture recorded on the disc appears automatically. If there is no picture, you can capture one from the disc (page 45). If there is no jacket picture and you have not captured one, the icon of media information is displayed.

◆ Text information (DVD/Super Audio CD/CD text or Disc Memo)

The text information (DVD/Super Audio CD/CD text) recorded on the disc appears automatically. If no text information is recorded, you can store the text information (Disc Memo) yourself (page 48). With DATA CDs, the volume label is displayed.

◆ Genre

You can select the genre of the disc yourself (page 50).

◆ Disc type

The disc type, such as DVD, appears automatically.

Notes

- The disc information that you have edited in the Disc Explorer display is canceled when the disc is removed. When you insert the disc again, you need to re-input the disc information. The disc information that is recorded on the disc in itself is not canceled.
- If you have inserted a disc and it does not play back or the disc information is not loaded into memory of the player, “?” appears in the Media information area (TITLE/ARTIST) of the Disc Explorer display.

Searching for a disc on the Disc Explorer

1 Slide the TV/DISC EXPLORER/DVD switch to DISC EXPLORER, then press FOLDER.

The Disc Explorer display appears.

2 Press \leftarrow/\rightarrow to select the folder with the disc you want to play.

To select subfolders “A” to “D” under user folder (□), press \leftarrow/\rightarrow to select the user folder, then press FOLDER. Press \uparrow/\downarrow to select the subfolder you want, then press ENTER.

3 Select the disc by one of the following operations.

- press **↑/↓**
- Press **DISC SKIP+/-** to change the page, then press **↑/↓**.

4 Press **ENTER**.

The pop-up menu appears.

5 Press **↑/↓** to select “Play,” then press **ENTER**.

The Disc Explorer display disappears and playback starts.

To turn off the Disc Explorer

Press **⏪**RETURN.

Notes

- If you press **FOLDER** during playback, playback stops and the Disc Explorer appears. In this case, Resume Play is not available.
- If you load or try to play an empty slot, it appears as a blank in the Disc Explorer. You cannot select this slot.
- Even if the disc has a jacket picture recorded on it, the jacket picture may not appear on the Disc Explorer.

Capturing a scene for a jacket picture

DVD-V **VIDEO CD** **DATA-CD***

You can capture your favorite scene in a disc to create a personal jacket picture. A personalized jacket picture will make spotting the disc in the Disc Explorer easier. This function is available only if the disc does not contain a pre-recorded jacket picture.

1 Select a disc and play it (page 32, 33).

2 Slide the **TV/DISC EXPLORER/DVD** switch to **DISC EXPLORER**.

3 Press **PICTURE MEMORY** at your favorite scene.

The scene is captured as a still image, and is set as the jacket picture for the Disc Explorer. You can see the jacket picture in the detailed Disc Explorer display.

Note

Depending on the DVD scene, you may not be able to capture the scene.

To erase a stored jacket picture

- 1 Perform steps 1 and 2 in “Searching for a disc on the Disc Explorer” and select the disc you want to edit (page 44).
- 2 After sliding the **TV/DISC EXPLORER/DVD** switch to **DISC EXPLORER**, press **TOP MENU/EDIT**. “EDIT MODE” appears in the top right corner.
- 3 Press **↑/↓** to select the jacket picture.

Highlight the jacket picture

“EDIT MODE” appears

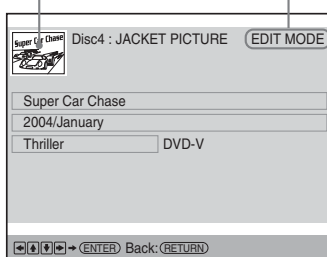

- 4 Press **CLEAR**. The stored jacket picture is deleted.
- 5 Press **TOP MENU/EDIT**. The confirmation display appears. If the contents are correct, select “Ok.” To return to the edit mode, select “Cancel.” If you select “Ok,” the jacket picture is cleared.

To cancel the edit mode

Press **⏪**RETURN. The confirmation display appears. If the contents are correct, select “Ok.” The edit mode ends and the detailed Disc Explorer display appears again. To return to the Disc Explorer display, press **⏪**RETURN. To turn off the Disc Explorer display, press **⏪**RETURN again.

* JPEG only

Filing Discs in the Folder

(File Mode)

You can file your discs in four user folders, "A" to "D." Even if you file discs from folders "ALL," "VIDEO," "MUSIC," or "PHOTO" to folders "A" to "D," those discs are not deleted from the "VIDEO," "MUSIC," or "PHOTO" folders. You can file up to 400 discs in one folder, and the same disc in different folders.

Note that you can set Program Play, Shuffle Play and Repeat Play for discs within a single folder.

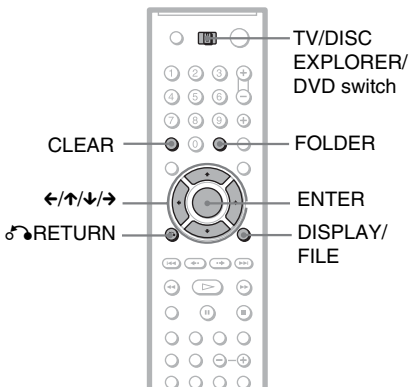

For example, to file DVDs in the no.1 and no.4 slots to the "A" folder:

1 Slide the TV/DISC EXPLORER/DVD switch to DISC EXPLORER, then press FOLDER.

The Disc Explorer display appears.

2 Press \leftarrow/\rightarrow to select the folder with the disc you want to file.

3 Press DISPLAY/FILE.

"FILE MODE" appears in the bottom right corner.

4 Press \uparrow/\downarrow to select the disc (in this case, the disc in slot no.1).

5 Press ENTER.

The disc to be filed (in this case, the disc in slot no.1) is selected.

To file other discs, repeat steps 4 and 5.

Selected disc

Selected folder

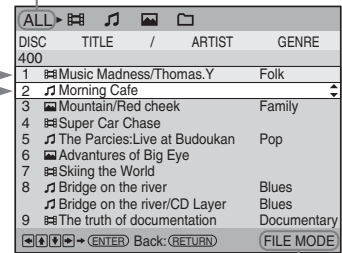

Cursor moves to the next disc.

"FILE MODE" appears.

6 Press FOLDER, then press \uparrow/\downarrow to select the "A" folder.

Selected disc

Selected folder

"A" folder

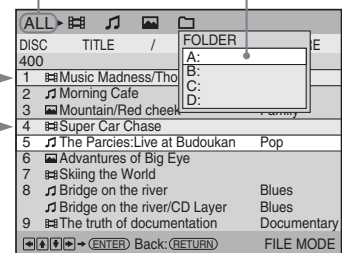

7 Press ENTER.

The file selecting mode ends and the Disc Explorer display appears. The selected file is registered in the selected folder. To see the registered file, select the folder by pressing \leftarrow/\rightarrow .

To cancel the file mode

Press RETURN.

To turn off the Disc Explorer display, press RETURN again.

Hint

- The discs are listed first by slot number in the Disc Explorer display. You can then sort the discs by desired genre or text information and then store them (page 51).
- If you press \uparrow/\downarrow to select the disc and press ENTER while the Disc Explorer display appears, and then select “File” from the pop-up menu display, you can also file discs in the folder. This is convenient for filing just one disc.

Deleting discs from a folder

You can delete unnecessary discs from folders “A” to “D.” You cannot delete discs from folders “ALL,” “VIDEO,” “MUSIC,” or “PHOTO” unless you remove the disc from the player.

1 Slide the TV/DISC EXPLORER/DVD switch to DISC EXPLORER, then press FOLDER.

The Disc Explorer display appears.

2 Press \leftarrow/\rightarrow to select the folder with the disc you want to delete.

3 Press DISPLAY/FILE.

“FILE MODE” appears in the bottom right corner.

4 Press \uparrow/\downarrow to select the disc.

5 Press ENTER.

The disc to be deleted is selected. To delete other discs, repeat steps 4 and 5.

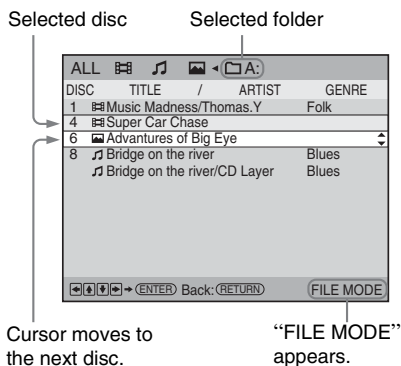

6 Press CLEAR.

The selected disc is deleted from the folder.

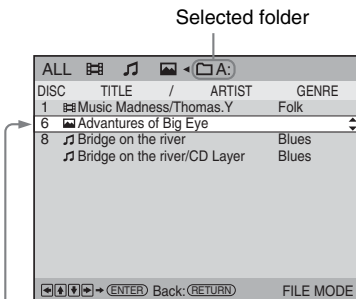

Cursor moves to the next disc.

7 Press DISPLAY/FILE.

The file selecting mode ends and the Disc Explorer display appears.

To cancel the file mode

Press \hookrightarrow RETURN.

To turn off the Disc Explorer display, press \hookrightarrow RETURN again.

Note

When you select a folder and set Program Play, Shuffle Play, or Repeat Play, the playback area varies according to the disc type. Refer to “Various Play Mode Functions” for details (page 39).

Labeling Discs and Folders (Edit Mode)

You can label the disc with a personal title of 32 characters (Disc Memo) (when DVD/CD text is not recorded on the disc). you can also label the folders "A" to "D" with a title of 16 characters. The Disc Memo can be anything you like, such as a title, musician's name, category or date of purchase.

You can also assign a genre label to the disc. This will help you keep your discs organized.

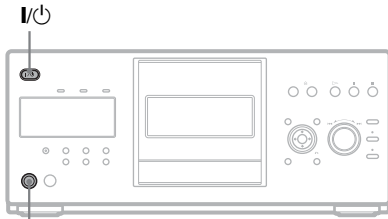

KEYBOARD jack

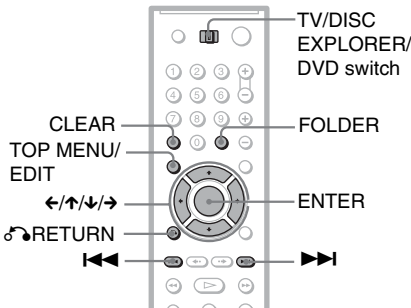

Labeling a disc or folder

DVD-V DVD-RW VIDEO CD Super Audio CD CD

DATA-CD

1 Select the disc or folder you want to label.

◆ To label a disc

Select the disc on the Disc Explorer (for details, see steps 1 to 3 of "Searching for a disc on the Disc Explorer" on page 44). After sliding the TV/DISC EXPLORER/DVD switch to DISC EXPLORER, press TOP MENU/EDIT.

"EDIT MODE" appears in the top right corner. Press \uparrow/\downarrow to select the text you want to edit.

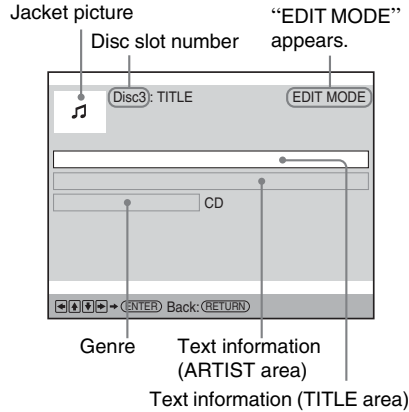

◆ To label a folder

Press FOLDER, then press \leftarrow/\rightarrow to select user folder (). Press FOLDER, then \uparrow/\downarrow to select the subfolder you want to label. After sliding the TV/DISC EXPLORER/DVD switch to DISC EXPLORER, press TOP MENU/EDIT.

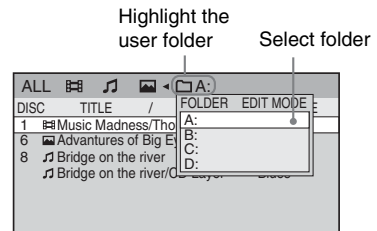

2 Press ENTER.

The "Disc Memo Input" display appears when you have selected a disc. The "Folder Name Input" display appears when you have selected a folder.

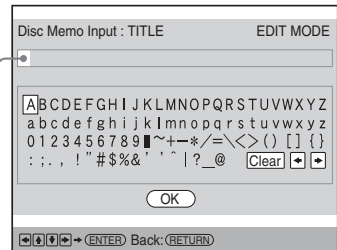

Input area

3 Press ←/↑/↓/→ to select a character.

The selected character changes color.

Input area

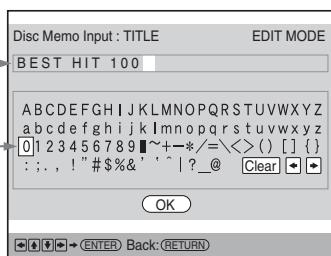

Highlight the selected character

4 Press ENTER.

The selected character is input.

5 Repeat steps 3 and 4 to input other characters.

6 When you have entered all of the characters for the Disc Memo or folder name, press ↑/↓ to select “OK,” then press ENTER.

The “Disc Memo Input” display or the “Folder Name Input” display disappears and the Disc Memo or folder name is stored.

The entered Disc Memo

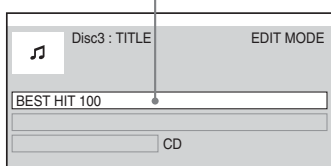

7 Press TOP MENU/EDIT.

The confirmation display appears. If the contents are correct, select “Ok.” To return to the edit mode, select “Cancel.” When you select “Ok,” the Disc memo or folder name is registered.

The entered Disc Memo

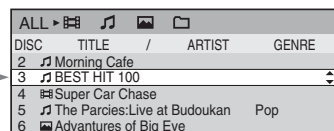

To cancel the edit mode

Press ↵ RETURN. The confirmation display appears. If the contents are correct, select “Ok.” The edit mode ends and the detailed Disc Explorer display appears again. To return to the Disc Explorer display, press ↵ RETURN. To turn off the Disc Explorer display, press ↵ RETURN again.

To erase a character

1 In step 3 of “Labeling a disc or folder” (page 48), press ◀◀ or ▶▶ to move the cursor to the character you want to erase.

2 Press CLEAR.

To insert a character

1 In step 3 of “Labeling a disc or folder” (page 48), press ◀◀ or ▶▶ to move the cursor to the insertion point or the character you want to correct.

2 Press ←/↑/↓/→ to select the correct character.

3 Press ENTER.

🔑 Hint

If you press ↑/↓ to select the disc and press ENTER while the Disc Explorer display appears, and then select “Edit” in the pop-up menu display, you can also enter the edit mode.

Note

The disc information that you have edited in the Disc Explorer display is canceled when the disc is removed. When you insert the disc again, you need to re-input the disc information. The disc information that is recorded on the disc in itself is not canceled.

Labeling a disc or folder using a keyboard



To label the disc or folder, you can use a USA model IBM compatible PC keyboard* (not supplied).

* Power consumption must be 120mA or less.

1 Connect a keyboard to the KEYBOARD jack on the front panel when the player is in standby mode.

- 2 Press **I/⏻** to turn on the player.
- 3 Perform step 1 of “Labeling a disc or folder” (page 48).
- 4 Press **ENTER** on the keyboard.
- 5 Press **↑/↓** to select the item you want to edit, then press **ENTER**.
You can then input characters.
- 6 Input the characters on the keyboard, then press **ENTER** on the keyboard.
The input mode ends and the edit display appears.
- 7 Press **ESC** on the keyboard.
The confirmation display appears. If the contents are correct, select “Ok.” To return to the edit mode, select “Cancel.” When you select “Ok,” the Disc memo or folder name is registered.

To turn off the Disc Explorer display
Press **↶RETURN**.

Notes

- If the cursor keys do not work correctly and you cannot complete the task using the keyboard, disconnect the keyboard. Then, reconnect it to the player and try again.
- If the keyboard is not a USA model, the characters may be input differently from those on the keys. The USA keyboard layout is shown below.



Selecting a genre

VIDEO CD **Super Audio CD** **C D** **DATA-CD** **DVD-V** **DVD-RW**

You can assign a genre to your disc.

- 1 Select the disc on the Disc Explorer display (steps 1 to 3 of “Searching for a disc on the Disc Explorer” (page 44)).
- 2 Slide the TV/DISC EXPLORER/DVD switch to DISC EXPLORER, then press **TOP MENU/EDIT**.

“EDIT MODE” appears in the top right corner.

- 3 Press **↑/↓** to highlight the genre row, then press **ENTER**.

Genre selection for VIDEO source TEXT/Disc Memo
Disc slot number “EDIT MODE” appears.

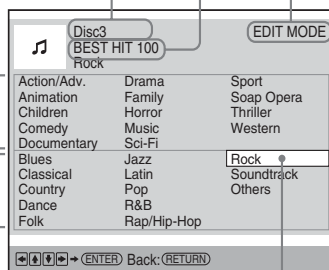

Genre selection for AUDIO source Selected genre

- 4 Press **←/↑/↓/→** to select the genre, then press **ENTER**.

The genre selecting mode ends.

- 5 Press **TOP MENU/EDIT**.

The confirmation display appears. If the contents are correct, select “Ok.” To return to the edit mode, select “Cancel.” When you select “Ok,” the genre is registered.

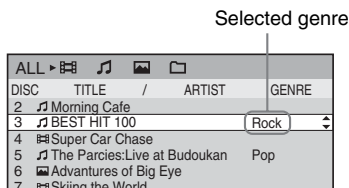

To cancel the edit mode

Press **↶RETURN**. The confirmation display appears. If the contents are correct, select “Ok.” The edit mode ends and the detailed Disc Explorer display appears again. To return to the Disc Explorer display, press **↶RETURN**. To turn off the Disc Explorer display, press **↶RETURN** again.

Note

The genre information is canceled when the disc is removed. The next time you insert the disc, you need to select the genre again.

Sorting Discs (Sort Mode)

DVD-V DVD-RW VIDEO CD Super Audio CD CD

DATA-CD

You can sort the discs in the folder by the disc slot number, text information (DVD/Super Audio CD/CD TEXT or Disc Memo) or genre.

The text information is sorted alphabetically.

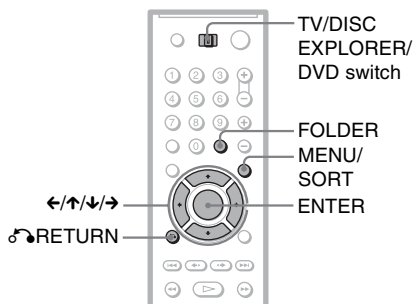

1 Press FOLDER.

The Disc Explorer display appears.

2 Press ←/→ to select the folder with the disc you want to sort.

The Disc Explorer display for the selected folder appears.

3 If you want to sort by text information or genre, select the disc which has the desired text information or genre by pressing ↑/↓ beforehand.

4 Slide the TV/DISC EXPLORER/DVD switch to DISC EXPLORER, then press MENU/SORT.

“SORT MODE” appears in the bottom right corner.

5 Press ←/→ to select the item you want to sort.

You can select the disc slot number, text information (TITLE of ARTIST) or genre.

Select the sorting item from among here.

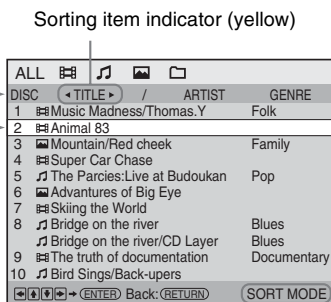

6 Press ENTER.

The discs are sorted and re-displayed. The sorted order is saved even if the power of the player is turned off.

Selected disc

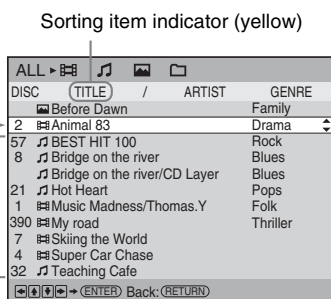

To cancel the sort mode

Press RETURN. “SORT MODE” disappears from the Disc Explorer display. If you press RETURN again, the Disc Explorer display turns off.

Hint

The discs in the same genre are sorted by numeral order according to the disc slot number.

Searching for a Scene

Searching for a Particular Point on a Disc (Scan, Slow-motion Play, Freeze Frame)

You can quickly locate a particular point on a disc by monitoring the picture or playing back slowly.

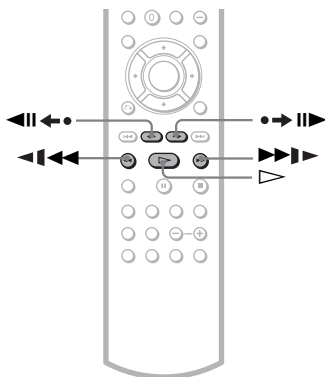

Note

Depending on the DVD/VIDEO CD, you may not be able to do some of the operations described.

Locating a point quickly by playing a disc in fast forward or fast reverse (Scan)

DVD-V **DVD-RW**
VIDEO CD **SCENE CD** **C D** **DATA-CD**

Press \lll or \ggg while playing a disc. When you find the point you want to play back, press \triangleright to return to normal speed.

Each time you press \lll or \ggg during scan, the playback speed changes. With each press, the indication changes as shown below. The actual speed may differ with some discs.

Playback direction

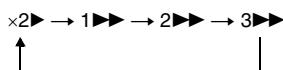

$3 \ggg$ (DVD VIDEO/DVD-RW/VIDEO CD only)

Opposite direction

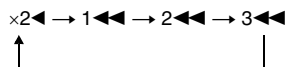

$3 \lll$ (DVD VIDEO/DVD-RW/VIDEO CD only)

The " $\times 2 \ggg$ "/" $\times 2 \lll$ " playback speed is about twice the normal speed. The " $3 \ggg$ "/" $3 \lll$ " playback speed is faster than " $2 \ggg$ "/" $2 \lll$," and the " $2 \ggg$ "/" $2 \lll$ " playback speed is faster than " $1 \ggg$ "/" $1 \lll$."

Watching frame by frame (Slow-motion play)

DVD-V **DVD-RW** **VIDEO CD**

Press \lll or \ggg when the player is in pause mode. To return to the normal speed, press \triangleright .

Each time you press \lll or \ggg during Slow-motion play, the playback speed changes. Two speeds are available. With each press, the indication changes as follows:

Playback direction

$2 \ggg \leftrightarrow 1 \ggg$

Opposite direction (DVD only)

$2 \lll \leftrightarrow 1 \lll$

The " $2 \ggg$ "/" $2 \lll$ " playback speed is slower than " $1 \ggg$ "/" $1 \lll$."

Playing one frame at a time (Freeze Frame)

DVD-V **DVD-RW** **VIDEO CD**

When the player is in the pause mode, press $\bullet \rightarrow \parallel$ (step) to go to the next frame. Press $\lll \parallel \bullet$ (step) to go to the preceding frame (DVD only). If you press and hold the button down, you can view the frames in succession. To return to normal playback, press \triangleright .

Searching for a Title/ Chapter/Track/Scene, etc.

DVD-V DVD-RW VIDEO CD Super Audio CD

CD DATA-CD

You can search a DVD by title or chapter, and you can search a VIDEO CD/Super Audio CD/CD by track, index, or scene. As titles and tracks are assigned unique numbers on the disc, you can select the desired one by entering its number. Or, you can search for a scene using the time code.

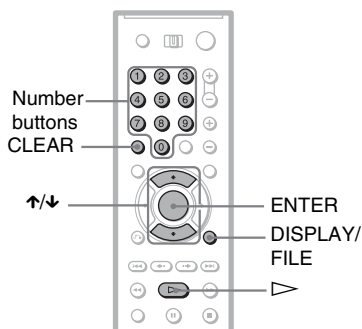

1 Select a disc (page 33).

2 Press DISPLAY/FILE during playback.

The Control Menu appears.

3 Press \uparrow/\downarrow to select the search method.

◆ When playing a DVD VIDEO/DVD-RW

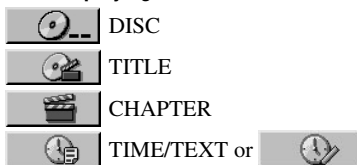

TIME/MEMO

Select "TIME/TEXT" to search for a starting point by inputting the time code.

◆ When playing a VIDEO CD without PBC Playback

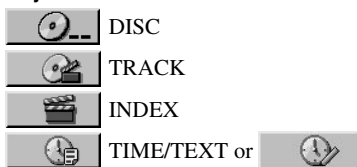

TIME/MEMO

◆ When playing a VIDEO CD with PBC Playback



◆ When playing a Super Audio CD/CD



◆ When playing a DATA CD

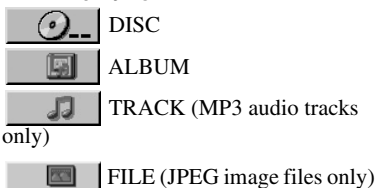

Example: when you select (CHAPTER)

"** (**)" is selected (** refers to a number).

The number in parentheses indicates the total number of titles, tracks, indexes, scenes, etc. of the disc.

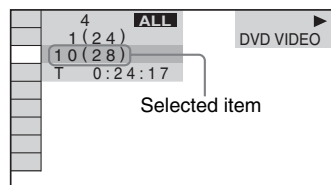

4 Press ENTER.

“** (**)” changes to “-- (**).”

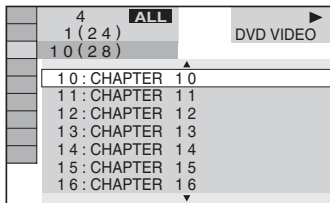

5 Press \uparrow/\downarrow or the number buttons to select the title, chapter, track, index, or scene number you want to search.

If you make a mistake

Cancel the number by pressing CLEAR, then select another number.

6 Press ENTER.

The player starts playback from the selected number.

To search for a scene using the time code (DVD VIDEO/DVD-RW/VIDEO CD without PBC function only)

1 In step 2, select  TIME/TEXT. “T **:**:**” (playing time of the current title) is selected.

2 Press ENTER.
“T **:**:**” changes to “T --:--:--.”

3 Input the time code using the number buttons, then press ENTER.
For example, to find the scene at 2 hours, 10 minutes, and 20 seconds after the beginning, just enter “2:10:20.”

To turn off the display

Press DISPLAY/FILE repeatedly until the display is turned off.

Hints

- You can display the first scene of titles, chapters or tracks recorded on the disc on a screen divided into nine sections. You can start playback directly by selecting one of the scenes. For details, see “Searching by Scene (PICTURE NAVIGATION)” (page 55).
- You can search for a chapter (DVD VIDEO/DVD-RW only) or track (VIDEO CD/Super Audio CD/CD only) by pressing the number buttons and ENTER.

Notes

- You cannot search for a still picture on a DVD-RW in VR mode.
- You cannot search for a scene on a DVD+RW using the time code.
- The title, chapter or track number displayed is the same number recorded on the disc.
- When playing a CD, you cannot play a specific point by selecting it from the index.
- You cannot use the time code to search a VIDEO CD across multiple tracks.

Searching by Scene

(PICTURE NAVIGATION) DVD-V VIDEO CD

You can divide the screen into 9 subscreens and quickly find a desired scene.

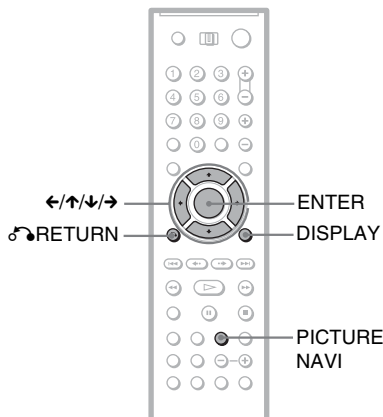

1 Press PICTURE NAVI during playback.

The following display appears.

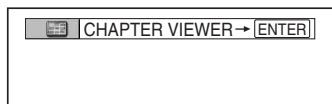

2 Press PICTURE NAVI repeatedly to select an item.

- CHAPTER VIEWER (DVD VIDEO only)
- TITLE VIEWER (DVD VIDEO only)
- TRACK VIEWER (VIDEO CD only)

3 Press ENTER.

The following display appears.

1	2	3	
4	5	6	
7	8	9	▼

4 Press $\leftarrow/\uparrow/\downarrow/\rightarrow$ to select a title, chapter, or track, and press ENTER.

Playback starts.

To return to normal play

Press DISPLAY or RETURN.

Hint

If there are more than nine titles, chapters, or tracks, ▼ is displayed at the bottom right of the screen. To display subsequent titles, chapters, or tracks, select a scene on the bottom row (located at box 7, 8, 9) and press ↓. To return to previous scenes, select a scene on the top row (located at box 1, 2, 3) and press ↑.

Notes

- Depending on the disc, you may not be able to select some items.
- The sound is muted when using this function.

Checking the Playing Time and Remaining Time

Time DVD-V DVD-RW VIDEO CD Super Audio CD

C D DATA-CD

You can check the playing time and remaining time of the current title, chapter, or track. Also, you can check the DVD/Super Audio CD/CD text or track name (MP3 audio) recorded on the disc.

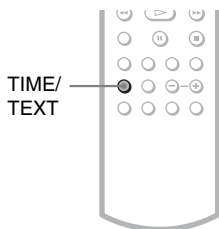

1 Press TIME/TEXT during playback.

The following display appears.

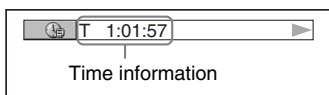

2 Press TIME/TEXT repeatedly to change the time information.

The available time information depends upon the type of disc you are playing.

◆ When playing a DVD VIDEO or DVD-RW

- T *:*:* (hours: minutes: seconds)
Playing time of the current title
- T-*:*:*
Remaining time of the current title
- C *:*:*
Playing time of the current chapter
- C-*:*:*
Remaining time of the current chapter

◆ When playing a VIDEO CD (with PBC functions)

- *:* (minutes: seconds)
Playing time of the current scene

◆ When playing a VIDEO CD (without PBC functions), Super Audio CD, or CD

- T *:* (minutes: seconds)
Playing time of the current track
 - T-*:*
Remaining time of the current track
 - D *:*
Playing time of the current disc
 - D-*:*
Remaining time of the current disc
- #### ◆ When playing a DATA CD (MP3 audio)
- T *:* (minutes: seconds)
Playing time of the current track

To check the DVD/Super Audio CD/VIDEO CD/CD Disc text

Press TIME/TEXT repeatedly in step 2 to display the Disc Memo or Disc text recorded on the DVD VIDEO/Super Audio CD/CD. The DVD/Super Audio CD/CD text appears only when text is recorded in the disc. You cannot change the text. If the disc does not contain text, "NO TEXT" appears. In this case, you can label the disc (page 48).

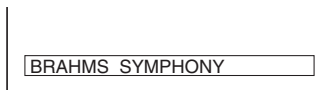

To check DATA CD (MP3 audio) bit rate, album name, or track name

Press TIME/TEXT while playing an MP3 audio track on a DATA CD. You can display the name of an album/track and the audio bit rate (the amount of data per second of the current audio) on your TV screen.

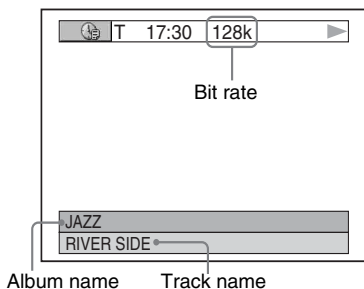

💡 Hint

You can also check the DVD/Super Audio CD/CD/MP3 text using the Disc Explorer (page 44).

Notes

- If the MP3 audio track being played back has an ID3 tag, the ID3 tag information is displayed instead of the track name.
- The name display cannot be scrolled.

Checking the information on the front panel display

You can view the time information and text on the front panel display as well as on the TV screen. The information on the front panel display changes as follows when you change the time information on your TV screen.

When playing a DVD VIDEO or DVD-RW

Title playing time and current disc, title and chapter number

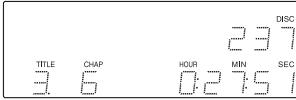

Remaining time of the current title



Playing time and number of the current chapter

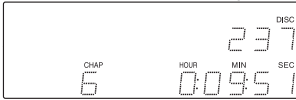

Remaining time of the current chapter

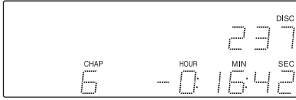

Text

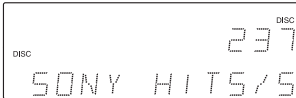

When playing a VIDEO CD (without PBC functions), Super Audio CD, or CD

Track playing time and current disc, track and index number



Remaining time of the current track

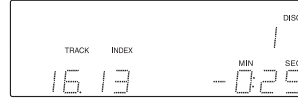

Playing time of the disc



Remaining time of the disc



Text

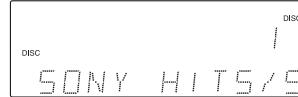

When playing a DATA CD (MP3 audio)

Track playing time and current disc, album and track number

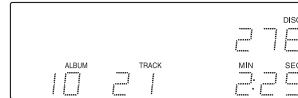

Track name

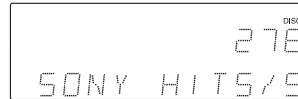

Hints

- When playing VIDEO CDs with PBC functions, the disc number, scene number and the playing time are displayed.
- Long text that does not fit in a single line will scroll across the front panel display.
- You can also check the time information and text by pressing the TIME/TEXT button on the player.
- You can also check the time information and text using the Control Menu (page 13).

Notes

- Depending on the type of disc being played, the DVD/Super Audio CD/CD text or track name may not be displayed.
- The player can only display the first level of the DVD/Super Audio CD/CD text, such as the disc name or title.
- Playing time of MP3 audio tracks may not be displayed correctly.
- If you play a disc containing JPEG image files only, “MODE (MP3, JPEG)” is set to “JPEG” automatically. If you play a disc containing MP3 audio tracks only, “MODE (MP3, JPEG)” is set to “MP3” automatically.

Sound Adjustments

Changing the Sound

DVD-V DVD-RW VIDEO CD CD DATA-CD

When playing a DVD recorded in multiple audio formats (PCM, Dolby Digital, or DTS), you can change the audio format. If the DVD is recorded with multilingual tracks, you can also change the language.

With CDs, DATA CDs, or VIDEO CDs, you can select the sound from the right or left channel and listen to the sound of the selected channel through both the right and left speakers. For example, when playing a disc containing a song with the vocals on the right channel and the instruments on the left channel, you can hear the instruments from both speakers by selecting the left channel.

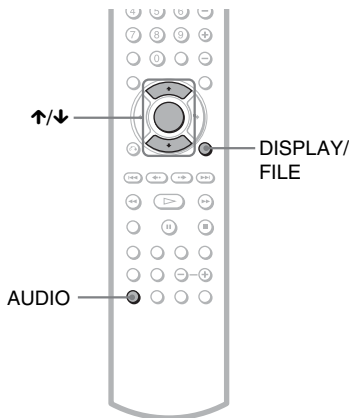

1 Press AUDIO during playback.

The following display appears.

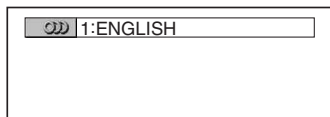

2 Press AUDIO repeatedly to select the desired audio signal.

◆ When playing a DVD VIDEO

Depending on the DVD VIDEO, the choice of language varies.

When 4 digits are displayed, they indicate a language code. See “Language Code List” for the language the code represents (page 93). When the same language is displayed two or more times, the DVD VIDEO is recorded in multiple audio formats.

◆ When playing a DVD-RW

The types of sound tracks recorded on a disc are displayed. The default setting is underlined.

Example:

- 1: MAIN (main sound)
- 1: SUB (sub sound)
- 1: MAIN+SUB (main and sub sound)

◆ When playing a VIDEO CD, CD, or DATA CD (MP3 audio)

The default setting is underlined.

- STEREO: The standard stereo sound
- 1/L: The sound of the left channel (monaural)
- 2/R: The sound of the right channel (monaural)

💡 Hint

You can also select “AUDIO” from the Control Menu (page 13).

Notes

- You cannot change the sound for Super Audio CDs.
- Some DVDs prohibit changing sounds during playback. In this case, change the sounds using the disc’s menu (page 35).

Displaying the disc’s audio information DVD-V

Press DISPLAY/FILE during playback to display the Control Menu. Select “AUDIO” using \uparrow/\downarrow . The channels being played are displayed on the screen.

For example, in Dolby Digital format, multiple signals ranging from monaural to 5.1 channel signals can be recorded on a DVD VIDEO. Depending on the DVD VIDEO, the number of the recorded channels may differ.

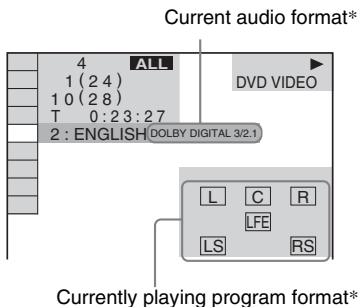

* “PCM,” “DTS,” or “DOLBY DIGITAL” is displayed.

The channels in the currently selected track are displayed by numbers as follows:

For Dolby Digital 5.1 ch:

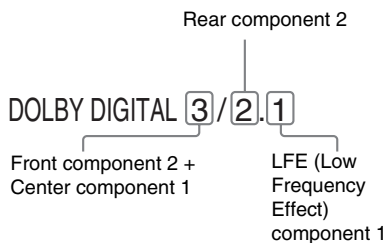

**The letters in the program format display indicate the following sound components:

- L: Front (left)
- R: Front (right)
- C: Center
- LS: Rear (left)
- RS: Rear (right)
- S: Rear (monaural): The rear component of the Dolby Surround processed signal and the Dolby Digital signal
- LFE: Low Frequency Effect signal

Changing the Angles

DVD-V

If various angles (multi-angles) for a scene are recorded on the DVD VIDEO, "ANGLE" appears in the front panel display. This means that you can change the viewing angle.

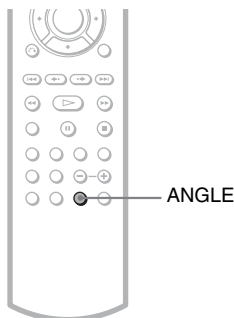

1 Press ANGLE during playback.

The number of the angle appears on the display.

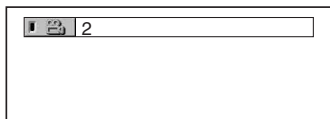

2 Press ANGLE repeatedly to select the angle number.

The scene changes to the selected angle.

Note

Depending on the DVD VIDEO, you may not be able to change the angles even if multi-angles are recorded on the disc.

Displaying the Subtitles

DVD-V DVD-RW

If subtitles are recorded on the discs, you can change the subtitles or turn them on and off whenever you want while playing a DVD.

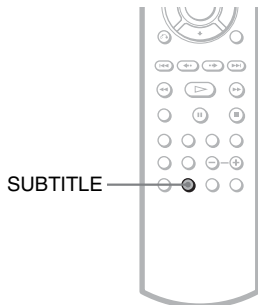

1 Press SUBTITLE during playback.

The following display appears.

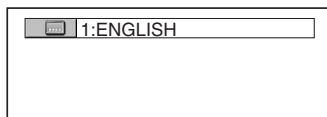

2 Press SUBTITLE repeatedly to select the language.

◆ When playing a DVD VIDEO

Select the language.

Depending on the DVD VIDEO, the choice of language varies.

When 4 digits are displayed, they indicate a language code. See "Language Code List" for the language the code represents (page 93).

◆ When playing a DVD-RW

Select "ON."

To turn off the subtitles

Select "OFF" in step 2.

Note

Depending on the DVD VIDEO, you may not be able to change the subtitles even if multilingual subtitles are recorded on it. You also may not be able to turn them off.

Adjusting the Playback Picture (CUSTOM PICTURE MODE)

DVD-V DVD-RW VIDEO CD DATA-CD

You can adjust the video signal of a DVD or VIDEO CD from the player to obtain the picture quality you want. Choose the setting that best suits the program you are watching. When you select “MEMORY,” you can make further adjustments to each element of the picture (color, brightness, etc.).

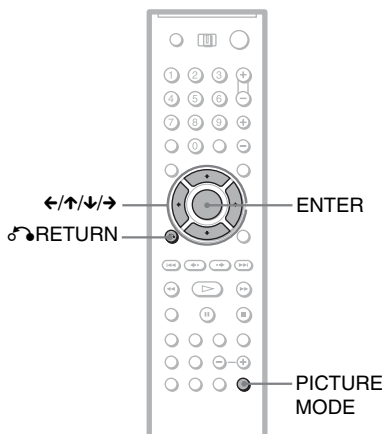

1 Press PICTURE MODE during playback.

The following display appears.

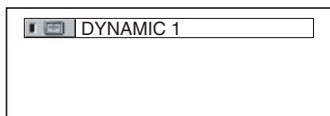

2 Press PICTURE MODE repeatedly to select the setting you want.

The default setting is underlined.

- STANDARD: displays a standard picture.
- DYNAMIC 1: produces a bold dynamic picture by increasing the picture contrast and the color intensity.
- DYNAMIC 2: produces a more dynamic picture than DYNAMIC 1 by further increasing the picture contrast and the color intensity.
- CINEMA 1: enhances details in dark areas by increasing the black level.
- CINEMA 2: white colors become brighter and black colors become richer, and the color contrast is increased.
- MEMORY: adjusts the picture in greater detail.

💡 Hints

- When you watch a movie, “CINEMA 1” or “CINEMA 2” is recommended.
- The picture can be adjusted by pressing the PICTURE MODE button on the player as well.

Adjusting the picture items in “MEMORY”

You can adjust each element of the picture individually.

- PICTURE: changes the contrast
- BRIGHTNESS: changes the overall brightness
- COLOR: makes the colors deeper or lighter
- HUE: changes the color balance

1 Press PICTURE MODE repeatedly to select “MEMORY” and press ENTER.

The “PICTURE” adjustment bar appears.



2 Press ←/→ to adjust the picture contrast, then press ENTER.

The adjustment is saved, and “BRIGHTNESS” adjustment bar appears.

3 Repeat step 2 to adjust “BRIGHTNESS,” “COLOR,” and “HUE.”

The Custom Picture Mode display appears. You can check each adjustment.

To turn off the display

Press  RETURN, or select “RETURN” in step 3 and press ENTER.

Hint

To reset the picture items to the default values, press  after step 3 to select “RESET” and press ENTER.

Sharpening the Picture

(SHARPNESS)   



You can enhance the outlines of images to produce a sharper picture.

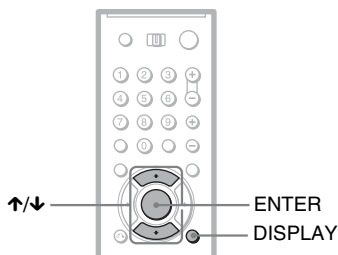

1 Press DISPLAY twice during playback.

The Control Menu appears.

2 Press ↑/↓ to select (SHARPNESS), then press ENTER.

The options for “SHARPNESS” appear.

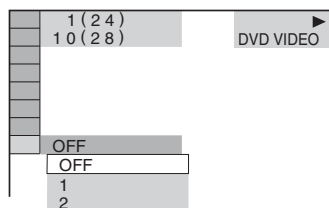

3 Press ↑/↓ to select a level.

- 1: enhances the outline.
- 2: enhances the outline more than 1.

4 Press ENTER.

The disc plays with the setting you selected.

To cancel the “SHARPNESS” setting

Select “OFF” in step 3.

To turn off the Control Menu

Press DISPLAY repeatedly until the Control Menu is turned off.

Enjoying MP3 Audio and JPEG Images

About MP3 Audio Tracks and JPEG Image Files

MP3 is audio compression technology that satisfies the ISO/MPEG regulations. JPEG is image compression technology.

You can play DATA CDs that contain MP3 audio tracks or JPEG image files.

DATA CDs that the player can play

You can play back DATA CDs (CD-ROMs/CD-Rs/CD-RWs) recorded in MP3 (MPEG1 Audio Layer 3) and JPEG format. However, the discs must be recorded according to ISO 9660 Level 1, Level 2 or Joliet format for the player to recognize the tracks (or files). You can also play discs recorded in Multi Session.

Refer to the instructions supplied with the CD-R/CD-RW drives and the recording software (not supplied) for details on the recording format.

Note on Multi Session discs

If MP3 audio tracks or JPEG image files are recorded in the first session, the player will also play MP3 audio tracks or JPEG image files in other sessions. If audio tracks and images in Music CD format or Video CD format are recorded in the first session, only the first session will be played back.

Note

The player may not be able to play some DATA CDs created in the Packet Write format.

MP3 audio track or JPEG image file that the player can play

The player can play the following tracks and files:

- MP3 audio tracks with the extension “.MP3.”
- JPEG image files with the extension “.JPEG” or “.JPG.”

- JPEG image files that conform to the DCF* image file format.

* “Design rule for Camera File system”: Image standards for digital cameras regulated by JEITA (Japan Electronics and Information Technology Industries Association).

Notes

- The player will play any data with the extension “.MP3,” “.JPG,” or “.JPEG,” even if they are not in MP3 or JPEG format. Playing these data may generate a loud noise which could damage your speaker system.
- The player does not conform to audio tracks in MP3PRO format.
- Some JPEG files may not be able to be played.

About playback order of albums, tracks, and files

Albums play in the following order:

◆Structure of disc contents

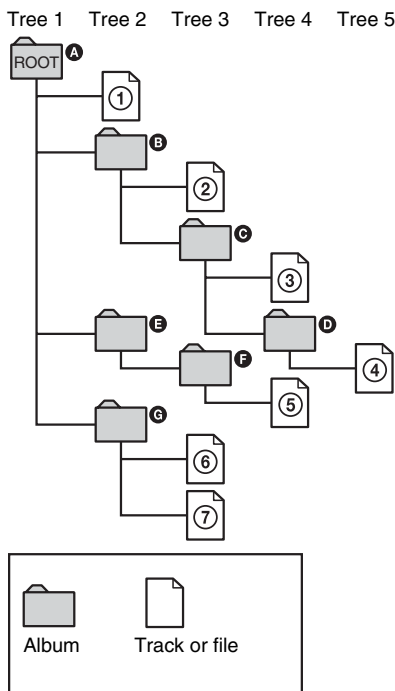

When you insert a DATA CD and press \triangleright , the numbered tracks (or files) are played sequentially, from ① through ⑦. Any sub-albums/tracks (or files) contained within a currently selected album take priority over the next album in the same tree. (Example: **C** contains **D** so ④ is played before ⑤.)

Press DISPLAY, and press \uparrow/\downarrow to select ALBUM, then press ENTER (page 65). The list of albums on the disc appears. The album names are arranged in the following order: **A** \rightarrow **B** \rightarrow **C** \rightarrow **D** \rightarrow **F** \rightarrow **G**. Albums that do not contain tracks (or files) (such as album **E**) do not appear in the list.

Hints

- If you add numbers (01, 02, 03, etc.) to the front of the track/file names when you store the tracks (or files) in a disc, the tracks and files will be played in that order.
- Since a disc with many trees takes longer to start playback, it is recommended that you create albums with no more than two trees.

Notes

- Depending on the software you use to create the DATA CD, the playback order may differ from the above illustration.
- The playback order above may not be applicable if there are more than 500 albums and 999 tracks/files in each album.
- Proceeding to the next or another album may take some time.

Playing MP3 Audio Tracks or JPEG Image Files DATA-CD

You can play MP3 audio tracks and JPEG image files on DATA CDs (CD-ROMs/CD-Rs/CD-RWs).

To play MP3 audio tracks, see “Selecting an MP3 audio track” (page 66). To play JPEG image files, see “Selecting a JPEG image file” (page 66). To play DATA CDs that contain MP3 audio tracks and JPEG image files, see “Selecting the playback mode for a DATA CD (MODE (MP3, JPEG))” (page 68).

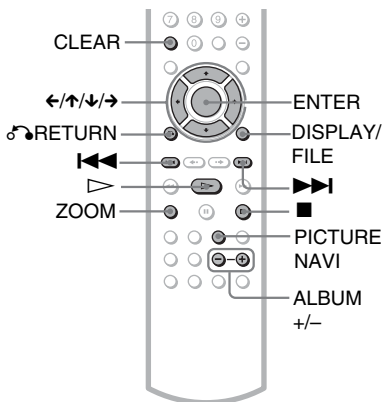

Hint

You can view the disc information while playing MP3 audio tracks and JPEG image files (page 56).

Selecting an album

- 1 Press DISPLAY.**
The Control Menu appears.
- 2 Press \uparrow/\downarrow to select  (ALBUM), then press ENTER.**
The list of albums on the disc appears.

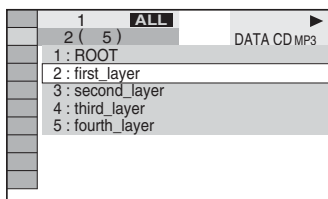

3 Press \uparrow/\downarrow to select the album you want to play, then press ENTER.

Playback starts from the selected album.

To select MP3 audio tracks, see “Selecting an MP3 audio track” (page 66).

To select JPEG image files, see “Selecting a JPEG image file” (page 66).

To stop playback

Press ■.

To turn on or off the Control Menu

Press DISPLAY repeatedly.

💡 Hints

- Of the selected album, you can select to play only the MP3 audio tracks or JPEG image files by setting “MODE (MP3, JPEG)” (page 68).
- During playback, you can press ALBUM +/- to go to the next/previous album without using the album list.

Selecting an MP3 audio track

1 After step 3 of “Selecting an album,” press \uparrow/\downarrow to select (TRACK), then press ENTER.

The list of tracks in the album appears.

1	ALL	▶
2 (5)	DATA CD/MP3	
1 (3)		
1 : 0 1	- Smells Like Teen Spirit	
2 : 0 2	- In Bloom	
3 : 0 3	- Come As You Are	

2 Press \uparrow/\downarrow to select a track, and press ENTER.

Playback starts from the selected track.

To stop playback

Press ■.

To go to the next or previous MP3 audio track

Press \lll/\ggg during playback. You can select the first track of the next album by pressing \ggg during playback of the last track of the current album.

Selecting a JPEG image file

1 After step 3 of “Selecting an album,” press PICTURE NAVI.

The image files in the album appear in 16 subcreens. A scroll box is displayed on the right.

1	2	3	4	
5	6	7	8	
9	10	11	12	
13	14	15	16	

To display subsequent images, select an image on the bottom row and press \downarrow . To return to previous images, select an image on the top row and press \uparrow .

2 Press \leftarrow/\rightarrow to select the image you want to view, and press ENTER.

The selected image appears.

Example

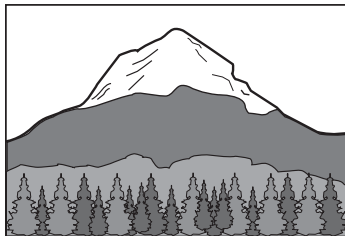

To go to the next or previous JPEG image file

Press \leftarrow/\rightarrow during playback. You can select the first file of the next album by pressing \rightarrow during playback of the last file of the current album.

To rotate a JPEG image

Press \uparrow/\downarrow while viewing the image. Each time you press \uparrow , the image rotates counterclockwise by 90 degrees.

To return to normal view, press CLEAR.

Note that the view also returns to normal if you press \leftarrow/\rightarrow to go to the next or previous image.

Example: when \uparrow is pressed once.

Rotating direction

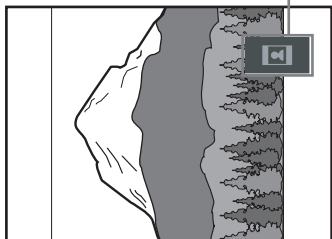

To magnify a JPEG image (ZOOM)

Press ZOOM while viewing the image. You can enlarge the image up to four times the original size, and scroll using $\leftarrow/\uparrow/\downarrow/\rightarrow$.

To return to normal view, press CLEAR.

◆When pressed once (x2)

The image enlarges twice the original size.

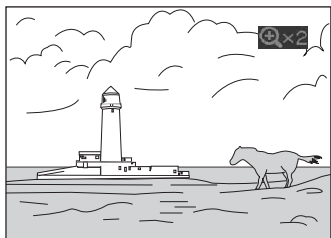

◆When pressed twice (x4)

The image enlarges four times the original size.

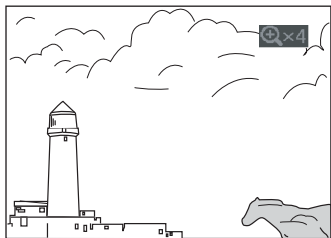

To stop viewing the JPEG image

Press \blacksquare .

💡 Hints

- While viewing JPEG image files, you can set options such as “INTERVAL” (page 69), “EFFECT” (page 69), “SHARPNESS” (page 63), and “CUSTOM PICTURE MODE” (page 62).
- The date the picture was taken is displayed beside “DATE” in the Control Menu (page 13). Note that no date may appear depending on the digital camera.
- You can check the date information during playback when the Exif* tag is recorded in the JPEG image data.

* “Exchangeable Image File Format” is a digital camera image format defined by the Japan Electronics and Information Technology Industries Association (JEITA).

Note

PICTURE NAVI does not work if “AUDIO (MP3)” is selected in “MODE (MP3, JPEG)” (page 68).

Selecting the playback mode for a DATA CD (MODE (MP3, JPEG))

When you play DATA CDs that contain MP3 audio tracks and JPEG image files, you can select to play the MP3 audio tracks or the JPEG image files.

1 Press DISPLAY in stop mode.

The Control Menu appears.

2 Press \uparrow/\downarrow to select (MODE (MP3, JPEG)), and press ENTER.

The options for “MODE (MP3, JPEG)” appear.

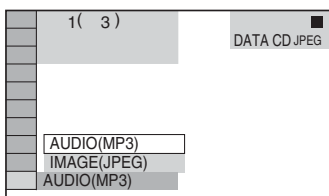

3 Press \uparrow/\downarrow to select a setting, and press ENTER.

The default setting is underlined.

- AUDIO (MP3): plays only MP3 audio tracks continuously.
- IMAGE (JPEG): plays only JPEG image files continuously.

Notes

- If you select an album containing JPEG image files only and “MODE (MP3, JPEG)” is set to “AUDIO (MP3),” “No audio data” appears on the screen.
- If you select an album containing MP3 audio tracks only and “MODE (MP3, JPEG)” is set to “IMAGE (JPEG),” “No image data” appears on the screen.

Enjoying JPEG Images as a Slide Show

You can play JPEG image files on a DATA CD successively as a slide show.

1 Press DISPLAY twice.

The Control Menu appears.

2 Press \uparrow/\downarrow to select (ALBUM), then press ENTER.

The list of albums on the DATA CD appears.

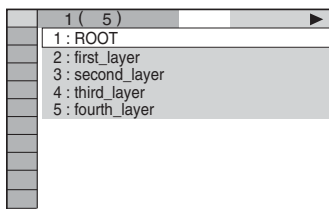

3 Press \uparrow/\downarrow to select an album, then press ENTER.

The JPEG images in the selected album start playing as a slide show.

To stop playback

Press .

Notes

- The slide show stops when \uparrow/\downarrow or ZOOM is pressed. To resume the slide show, press \triangleright .
- This function does not work if “MODE (MP3, JPEG)” is set to “AUDIO (MP3)” (page 68).
- Some JPEG files may take longer to display depending on the file size.

Setting the pace for a slide show (INTERVAL)

You can set the time the slides are displayed on the screen.

1 Press **DISPLAY** twice in stop mode.

The Control Menu appears.

2 Press **↑/↓** to select  (INTERVAL), then press **ENTER**.

The options for “INTERVAL” appear.

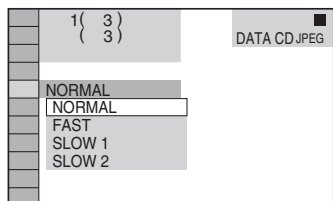

3 Press **↑/↓** to select a setting.

The default setting is underlined.

- **NORMAL**: normally select this position.
- **FAST**: sets a duration shorter than NORMAL.
- **SLOW1**: sets a duration longer than NORMAL.
- **SLOW2**: sets a duration longer than SLOW1.

4 Press **ENTER**.

Note

Some JPEG files may take longer to display than others, which may make the duration seem longer than the setting you selected.

Selecting the slides' appearance (EFFECT)

You can select the way the slides are displayed during a slide show.

1 Press **DISPLAY** twice in stop mode.

2 Press **↑/↓** to select  (EFFECT), then press **ENTER**.

The options for “EFFECT” appear.

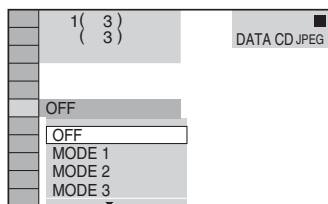

3 Press **↑/↓** to select a setting.

The default setting is underlined.

- **OFF**: turns off this function.
- **MODE1**: the image sweeps in from top to bottom.
- **MODE2**: the image sweeps in from left to right.
- **MODE3**: the image stretches out from the center of the screen.
- **MODE4**: the images randomly cycle through the effects.
- **MODE5**: the next image slides over the previous image.

4 Press **ENTER**.

Using Various Additional Functions

Locking Discs

(CUSTOM PARENTAL CONTROL, PARENTAL CONTROL)

You can set two kinds of playback restrictions for the desired disc.

- Custom Parental Control
You can set playback restrictions so that the player will not play inappropriate discs.
- Parental Control
Playback of some DVD VIDEOS can be limited according to a predetermined level such as the age of the users. Scenes may be blocked or replaced with different scenes. The same password is used for both Parental Control and Custom Parental Control.

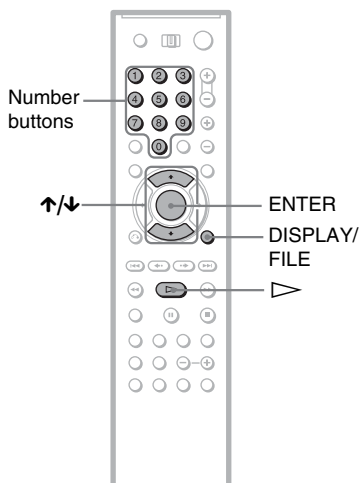

Custom Parental Control

- DVD-V
- DVD-RW
- VIDEO CD
- Super Audio CD
- C D
- DATA-CD

You can set the same Custom Parental Control password for up to 400 discs. When you set the 401st disc, the first disc is canceled.

- 1 Select a disc you want to lock (page 33).**

If the disc is playing, press ■ to stop playback.

- 2 Press DISPLAY/FILE while the player is in stop mode.**

The Control Menu appears.

- 3 Press ↑/↓ to select (PARENTAL CONTROL), then press ENTER.**

The options for “PARENTAL CONTROL” appear.

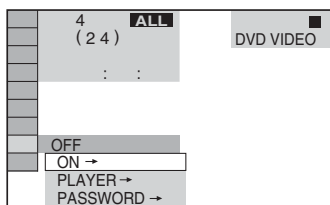

- 4 Press ↑/↓ to select “ON →,” then press ENTER.**

◆ **If you have not entered a password**
The display for registering a new password appears.

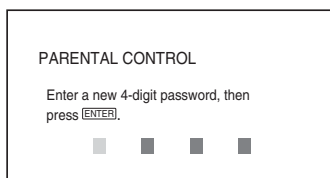

Enter a 4-digit password using the number buttons, then press ENTER. The display for confirming the password appears.

◆ **When you have already registered a password**
The display for entering the password appears.

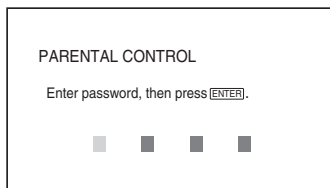

- 5 Enter or re-enter your 4-digit password using the number buttons, then press ENTER.**

“Custom parental control is set.” appears and the screen returns to the Control Menu.

To turn off the Custom Parental Control function

- 1 Follow steps 1 to 3 of “Custom Parental Control.”
- 2 Press \uparrow/\downarrow to select “OFF \rightarrow ,” then press ENTER.
- 3 Enter your 4-digit password using the number buttons, then press ENTER.

To play a disc for which Custom Parental Control is set

- 1 Select the disc for which Custom Parental Control is set.
The “CUSTOM PARENTAL CONTROL” display appears.

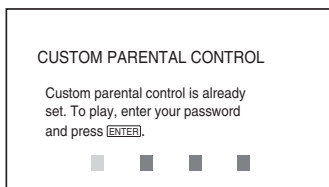

- 2 Enter your 4-digit password using the number buttons, then press ENTER.
The player is ready for playback.

Hint

If you forget your password, enter the 6-digit number “199703” using the number buttons when the “CUSTOM PARENTAL CONTROL” display asks you for your password, then press ENTER. The display will ask you to enter a new 4-digit password.

Parental Control (limited playback)

Playback of some DVD VIDEOS can be limited according to a predetermined level such as the age of the users. The “PARENTAL CONTROL” function allows you to set a playback limitation level.

- 1 Press DISPLAY/FILE while the player is in stop mode.

The Control Menu appears.

- 2 Press \uparrow/\downarrow to select  (PARENTAL CONTROL), then press ENTER.

The options for “PARENTAL CONTROL” appear.

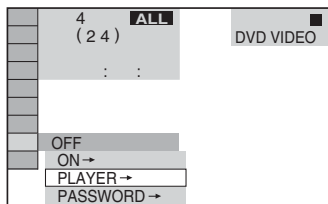

- 3 Press \uparrow/\downarrow to select “PLAYER \rightarrow ,” then press ENTER.

◆ If you have not entered a password

The display for registering a new password appears.

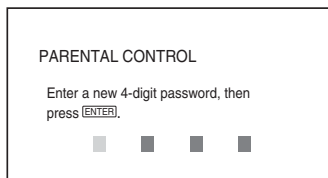

Enter a 4-digit password using the number buttons, then press ENTER. The display for confirming the password appears.

◆ When you have already registered a password

The display for entering the password appears.

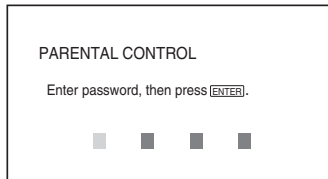

- 4** Enter or re-enter your 4-digit password using the number buttons, then press **ENTER**.

The display for setting the playback limitation level appears.

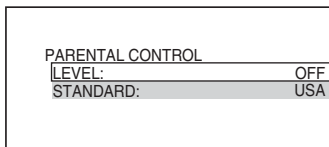

- 5** Press **↑/↓** to select “STANDARD,” then press **ENTER**.

The selection items for “STANDARD” are displayed.

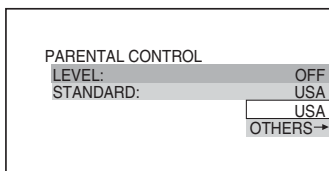

- 6** Press **↑/↓** to select a geographic area as the playback limitation level, then press **ENTER**.

The area is selected.

When you select “OTHERS →,” select and enter a standard code in the table on page 93.

- 7** Press **↑/↓** to select “LEVEL,” then press **ENTER**.

The selection items for “LEVEL” are displayed.

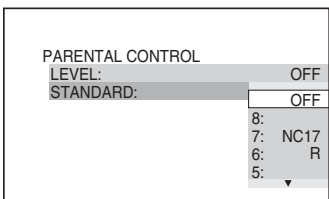

- 8** Select the level you want using **↑/↓**, then press **ENTER**.

Parental Control setting is complete.

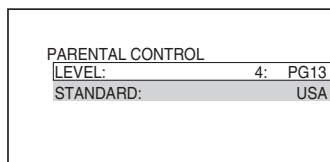

The lower the value, the stricter the limitation.

- To turn off the Parental Control function**
Set “LEVEL” to “OFF” in step 8.

To play a disc for which Parental Control is set

- 1 Select the disc and press **▷**.
The display for entering your password appears.
- 2 Enter your 4-digit password using the number buttons, then press **ENTER**.
The player starts playback.

Hint

If you forget your password, press **OPEN/CLOSE** to open the front cover and repeat steps 1 to 3 of “Parental Control (limited playback).” When you are asked to enter your password, enter “199703” using the number buttons, then press **ENTER**. The display will ask you to enter a new 4-digit password. After you enter a new 4-digit password, press **OPEN/CLOSE** to close the front cover and press **▷**. When the display for entering your password appears, enter your new password.

Notes

- When you play discs which do not have the Parental Control function, playback cannot be limited on this player.
- Depending on the disc, you may be asked to change the parental control level while playing the disc. In this case, enter your password, then change the level. If the Resume Play mode is canceled, the level returns to the previous level.

Changing the password

- 1 Press DISPLAY/FILE while the player is in stop mode.**
The Control Menu appears.
- 2 Press \uparrow/\downarrow to select  (PARENTAL CONTROL), then press ENTER.**
The options for "PARENTAL CONTROL" appear.
- 3 Press \uparrow/\downarrow to select "PASSWORD \rightarrow ," then press ENTER.**
The display for entering the password appears.
- 4 Enter your 4-digit password using the number buttons, then press ENTER.**
- 5 Enter a new 4-digit password using the number buttons, then press ENTER.**
- 6 To confirm your password, re-enter it using the number buttons, then press ENTER.**

If you make a mistake entering your password

Press \leftarrow before you press ENTER and input the correct number.

If you make a mistake

Press  RETURN.

To turn off the display

Press DISPLAY/FILE repeatedly until the display is turned off.

Controlling Your TV or AV Amplifier (Receiver) With the Supplied Remote

By adjusting the remote signal, you can control your TV with the supplied remote. If you connect the player to an AV amplifier (receiver), you can control the volume with the supplied remote.

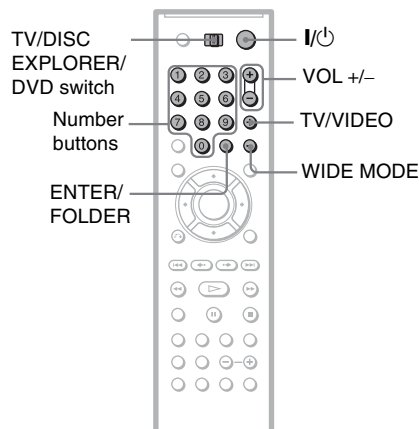

Notes

- Depending on the unit being connected, you may not be able to control your TV using some of the buttons below.
- If you enter a new code number, the code number previously entered will be erased.
- When you replace the remote's batteries, the code number you have set may be reset to the default setting. Set the appropriate code number again.

Controlling TVs with the remote

- 1 Slide the TV/DISC EXPLORER/DVD switch to TV.**
- 2 Hold down I/⏻, and enter the manufacturer's code for your TV using the number buttons (see "Code numbers of controllable TVs" below).**
- 3 Release I/⏻.**
When the TV/DISC EXPLORER/DVD switch is set to TV, the remote performs the following:

I/⏻	Turns the TV on or off
VOL +/-	Adjusts the volume of the TV
Number buttons and ENTER/ FOLDER	Selects the channel of the TV
WIDE MODE	Switches to or from the wide mode of a Sony wide TV
TV/VIDEO	Switches the TV's input source between the TV and other input sources

Code numbers of controllable TVs

If more than one code number is listed, try entering them one at a time until you find the one that works with your TV.

Manufacturer	Code number
Sony	01 (default)
Akai	04
AOC	04
Centurion	12
Coronado	03
Curtis-Mathes	12,14
Daewoo	04,22
Daytron	03,12
Fisher	11
General Electric	04,06,10
Gold Star/LG	03,04,17
Hitachi	02,03,04
J.C.Penney	04,10,12
JVC	09
KMC	03
Magnavox	03,04,08,12,21
Marantz	04,13
MGA/Mitsubishi	04,12,13,17
NEC	04,12
Panasonic	06,19
Philco	02,03,04,08
Philips	08,21
Pioneer	06,16

Manufacturer	Code number
Portland	03
Proscan	10
Quasar	06,18
Radio Shack	05,10,14
RCA	04,10
Sampo	12
Samsung	03,04,12,20
Sanyo	11,14
Scott	12
Sears	07,10,11
Sharp	03,05,18
Sylvania	08,12
Teknika	03,08,14
Toshiba	07,18
Wards	03,04,12
Yorx	12
Zenith	14,15

Controlling the volume of your AV amplifier (receiver) with the remote

- 1 Slide the TV/DISC EXPLORER/DVD switch to DVD.
- 2 Hold down I/⏻, and enter the manufacturer's code for your AV amplifier (receiver) using the number buttons (see "Code numbers of controllable AV amplifiers (receiver)" below).
- 3 Release I/⏻.

The VOL +/- buttons control the AV amplifier's volume.

◆ If you want to control the TV volume
Slide the TV/DISC EXPLORER/DVD switch to TV.

Code numbers of controllable AV amplifiers (receivers)

If more than one code number is listed, try entering them one at a time until you find the one that works with your AV amplifier (receiver).

Manufacturer	Code number
Sony*	78, 79, 80, 91
Denon	84, 85, 86
Kenwood	92, 93
Onkyo	81, 82, 83
Pioneer	99
Sansui	87
Technics	97, 98
Yamaha	94, 95, 96

* If you cannot control the volume of your Sony AV amplifier (receiver) with the remote, try entering the code number 91, and change the command mode of your amplifier (receiver) to “COMMAND MODE [AV1]” (not all amplifiers have this option).

Refer to the instructions supplied with your amplifier (receiver) to change the command mode.

Hint

If you want to control the TV's volume even when the TV/DISC EXPLORER/DVD switch is set to DVD, repeat steps 1 and 2, and then enter the code number 90 (default).

Settings and Adjustments

Using the Setup Display

By using the Setup Display, you can make various adjustments to items such as picture and sound. You can also set a language for the subtitles and the Setup Display, among other things. For details on each Setup Display item, see pages 77 to 85.

Note

Playback settings stored in the disc take priority over the Setup Display settings and not all of the functions described may work.

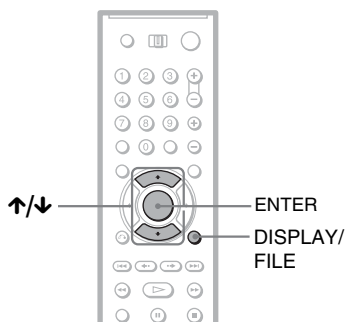

- 1 Press **DISPLAY/FILE** when the player is in stop mode.

The Control Menu appears.

- 2 Press **↑/↓** to select **(SETUP)**, then press **ENTER**.

The options for “SETUP” appear.

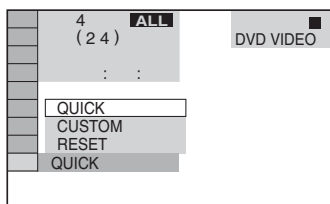

- 3 Press **↑/↓** to select “CUSTOM,” then press **ENTER**.

The Setup Display appears.

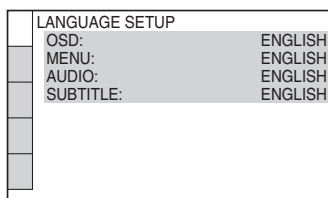

- 4 Press **↑/↓** to select the setup item from the displayed list: “LANGUAGE SETUP,” “SCREEN SETUP,” “CUSTOM SETUP,” “AUDIO SETUP” or “SPEAKER SETUP.” Then press **ENTER**.

The Setup item is selected.

Example: “SCREEN SETUP”

Selected item

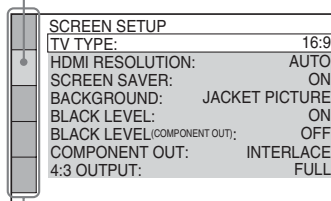

Setup items

- 5 Press **↑/↓** to select an item, then press **ENTER**.

The options for the selected item appear.
Example: “TV TYPE”

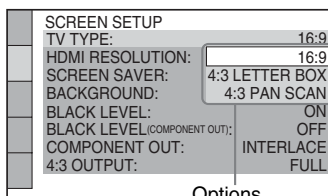

Options

6 Press \uparrow/\downarrow to select a setting, then press ENTER.

The setting is selected and setup is complete.

Example: "4:3 LETTER BOX"

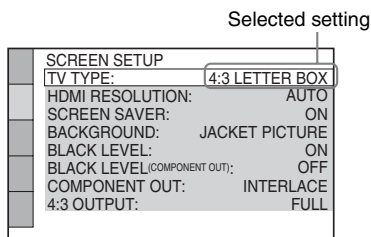

To turn off the display

Press DISPLAY repeatedly until the display is turned off.

To enter the Quick Setup mode

Select "QUICK" in step 3. Follow from step 5 of the Quick Setup explanation to make basic adjustments (page 26).

To reset all of the "SETUP" settings

1 Select "RESET" in step 3 and press ENTER.

2 Select "YES" using \uparrow/\downarrow .

3 Press ENTER.

All of the settings explained on pages 77 to 85 return to the default settings. Do not press \mathbb{I}/\mathbb{O} while resetting the player as it takes a few seconds to complete.

Setting the Display or Sound Track Language

(LANGUAGE SETUP)

"LANGUAGE SETUP" allows you to set various languages for the on-screen display or sound track.

Select "LANGUAGE SETUP" in the Setup Display. To use the display, see "Using the Setup Display" (page 76).

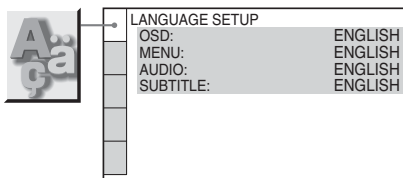

◆ OSD (On-Screen Display)

Switches the display language on the screen.

◆ MENU (DVD VIDEO only)

You can select the desired language for the disc's menu.

◆ AUDIO (DVD VIDEO only)

Switches the language of the sound track.

◆ SUBTITLE (DVD VIDEO only)

Switches the language of the subtitle recorded on the DVD VIDEO.

💡 Hint

If you select "OTHERS \rightarrow " in "MENU," "SUBTITLE," and "AUDIO," select and enter a language code from "Language Code List" on page 93 using the number buttons.

Note

When you select a language in "MENU," "SUBTITLE," or "AUDIO" that is not recorded on the DVD VIDEO, one of the recorded languages will be automatically selected.

Settings for the Display

(SCREEN SETUP)

Choose settings according to the TV to be connected.

Select "SCREEN SETUP" in the Setup Display. To use the display, see "Using the Setup Display" on page 76.

The default settings are underlined.

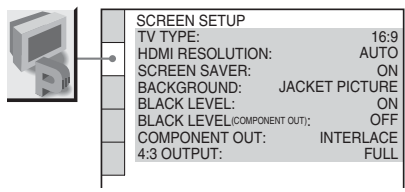

◆ TV TYPE

Selects the aspect ratio of the connected TV (4:3 standard or wide).

<u>16:9</u>	Select this when you connect a wide-screen TV or a TV with a wide mode function.
4:3 LETTER BOX	Select this when you connect a 4:3 screen TV. Displays a wide picture with bands on the upper and lower portions of the screen.
4:3 PAN SCAN	Select this when you connect a 4:3 screen TV. Automatically displays the wide picture on the entire screen and cuts off the portions that do not fit.

16:9

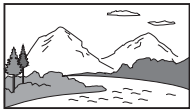

4:3 LETTER BOX



4:3 PAN SCAN

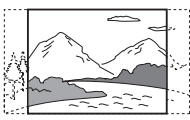

Note

Depending on the DVD, "4:3 LETTER BOX" may be selected automatically instead of "4:3 PAN SCAN" or vice versa.

◆ HDMI RESOLUTION

Selects the type of video signals output from the HDMI OUT jack. When you select AUTO (default), the player outputs video signals of the highest resolution acceptable for your TV. If the picture is not clear, natural or to your satisfaction, try another option that suits the disc and your TV/projector, etc. For details, refer also to the instruction manual supplied with the TV/projector, etc.

<u>AUTO</u>	Normally, select this.
1920×1080i	Sends 1920×1080i video signals.
1280×720p	Sends 1280×720p video signals.
720×480p	Sends 720×480p video signals.

Note

Even when a setting other than "AUTO" is selected and the connected TV cannot accept the resolution, the player automatically adjusts the video signals that are suitable for the TV.

◆ SCREEN SAVER

The screen saver image appears when you leave the player in pause or stop mode for 15 minutes, or when you play a Super Audio CD, CD, or DATA CD (MP3 audio) for more than 15 minutes. The screen saver will help prevent your display device from becoming damaged (ghosting). Press to turn off the screen saver.

<u>ON</u>	Turns on the screen saver.
OFF	Turns off the screen saver.

◆ BACKGROUND

Selects the background color or picture on the TV screen in stop mode or while playing a Super Audio CD, CD, or DATA CD (MP3 audio).

<u>JACKET PICTURE</u>	The jacket picture (still picture) appears, but only when the jacket picture is already recorded on the disc (CD-EXTRA, etc.). If the disc does not contain a jacket picture, the "GRAPHICS" picture appears.
GRAPHICS	A preset picture stored in the player appears.
BLUE	The background color is blue.
BLACK	The background color is black.

◆ BLACK LEVEL

Selects the black level (setup level) for the video signals output from the jacks other than COMPONENT VIDEO OUT/HDMI OUT jacks.

<u>ON</u>	Sets the black level of the output signal to the standard level.
OFF	Lowers the standard black level. Use this when the picture becomes too white.

◆ BLACK LEVEL (COMPONENT OUT)

Selects the black level (setup level) for the video signals output from the COMPONENT VIDEO OUT jacks. You cannot select this when the player outputs progressive signals (page 17).

<u>OFF</u>	Sets the black level of the output signal to the standard level. Normally select this position.
ON	Raises the standard black level. Use this setting when the picture appears too dark.

◆ COMPONENT OUT

Selects the type of signal output from the COMPONENT VIDEO OUT jacks. See page 90 for more information about the two different signal types.

<u>INTERLACE</u>	Select this when the player is connected to a standard (interlace format) TV.
PROGRESSIVE	Select this when you have a TV that can accept progressive signals.

After selecting, the confirmation display appears. If you do not select "Yes" or "No" within about 10 seconds, the setting is canceled and the display returns to the Setup Display.

To force the system to switch to interlace when "PROGRESSIVE" is selected

Hold down  on the player and press DISPLAY on the player.

◆ 4:3 OUTPUT

This setting is effective only when you set "TV TYPE" in "SCREEN SETUP" to "16:9." If you can change the aspect ratio on your progressive format (480p) compatible TV, change the setting on your TV, not the player.

Note that this setting is effective only for HDMI connection, or progressive signals output from the COMPONENT VIDEO OUT jacks.

<u>FULL</u>	Select this when you can change the aspect ratio on your TV.
NORMAL	Select this when you cannot change the aspect ratio on your TV. Shows a 16:9 aspect ratio signal with black bands on left and right sides of the image.

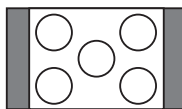

16:9 aspect ratio TV

Custom Settings

(CUSTOM SETUP)

Use this to make playback related adjustments and other settings.

Select "CUSTOM SETUP" in the Setup Display. To use the display, see "Using the Setup Display" (page 76).

The default settings are underlined.

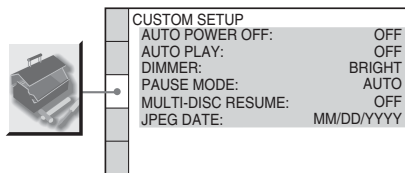

◆ AUTO POWER OFF

Switches the Auto Power Off setting on or off.

<u>OFF</u>	Switches this function off.
ON	The player enters standby mode when left in stop mode for more than 30 minutes.

◆ AUTO PLAY

Switches the Auto Play setting on or off. This function is useful when the player is connected to a timer (not supplied).

<u>OFF</u>	Switches this function off.
ON	Automatically starts playback when the player is turned on.

◆ DIMMER

Adjusts the lighting of the front panel display.

<u>BRIGHT</u>	Makes the lighting bright.
DARK	Makes the lighting dark.
AUTO DARK	Makes the front panel display dark if you do not operate the player or remote for a short while.

◆ PAUSE MODE (DVD VIDEO/DVD-RW only)

Selects the picture in pause mode.

<u>AUTO</u>	The picture, including subjects that move dynamically, is output with no jitter. Normally select this position.
FRAME	The picture, including subjects that do not move dynamically, is output in high resolution.

◆ MULTI-DISC RESUME (DVD VIDEO/VIDEO CD only)

Switches the Multi-disc Resume setting on or off. Resume playback can be stored in memory for up to 40 different DVD VIDEOS/VIDEO CDs (page 34).

<u>ON</u>	Stores the resume setting in memory for up to 40 discs.
OFF	Does not store the resume setting in memory. Playback restarts at the resume point only for the current disc in the player.

◆ JPEG DATA (DATA CD only)

Change the data information order of a JPEG image.

<u>MM/DD/YYYY</u>
DD/MM/YYYY
YYYY/MM/DD

YYYY; Year
MM; Month
DD; Day

Settings for the Sound

(AUDIO SETUP)

“AUDIO SETUP” allows you to set the sound according to the playback and connection conditions.

Select “AUDIO SETUP” in the Setup Display. To use the display, see “Using the Setup Display” (page 76).
The default settings are underlined.

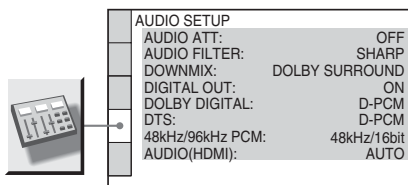

◆ AUDIO ATT (attenuation)

If the playback sound is distorted, set this item to “ON.” The player reduces the audio output level.

This function affects the output of the following jacks:

- LINE OUT AUDIO L/R 1/2 jacks
- 5.1CH OUTPUT jacks

<u>OFF</u>	Normally, select this position.
ON	Select this when the playback sound from the speakers is distorted.

◆ AUDIO FILTER (except Super Audio CD)

Selects a digital filter to reduce noise above 22.05 kHz (Sampling frequency (Fs) of the audio source is 44.1 kHz), 24 kHz (Fs is 48 kHz), or 48 kHz (Fs is above 96 kHz).

<u>SHARP</u>	Provides a wide frequency range and spatial feeling.
SLOW	Provides smooth and warm sound.

Note

There may be little effect by changing the digital filter depending on the disc or playback environment.

◆ DOWNMIX (DVD VIDEO/DVD-RW only)

Switches the method for mixing down to 2 channels when you play a DVD which has rear sound elements (channels) or is recorded in Dolby Digital format. For details on the rear signal components, see “Displaying the disc’s audio information” (page 59). This function affects the output of the following jacks:

- LINE OUT AUDIO L/R 1/2 jacks
- DIGITAL OUT (COAXIAL or OPTICAL)/HDMI OUT jack when “DOLBY DIGITAL” is set to “D-PCM” (page 82).

<u>DOLBY SURROUND</u>	Normally select this position. Multi-channel audio signals are output to two channels for enjoying surround sounds.
<u>NORMAL</u>	Multi-channel audio signals are downmixed to two channels for use with your stereo.

◆ DIGITAL OUT (except Super Audio CD)

Selects if audio signals are output via the DIGITAL OUT (COAXIAL or OPTICAL)/HDMI OUT jack.

<u>ON</u>	Normally select this position. When you select “ON,” see “To set the digital output signal” for further settings.
OFF	The influence of the digital circuit upon the analog circuit is minimal. If the signal is encrypted for copyright protection purposes, the signal is only output as 48 kHz/16 bit PCM.

Notes

- Super Audio CD audio signals are not output from the DIGITAL OUT (COAXIAL or OPTICAL)/HDMI OUT jack.
- If you are using the HDMI OUT jack, make sure that “DIGITAL OUT” is set to “ON.”

To set the digital output signal

The following switches the method of outputting audio signals when you connect a component such as an amplifier (receiver) or MD deck with a digital input jack.

For connection details, see page 20.

Select "DOLBY DIGITAL," "DTS," and "48kHz/96kHz PCM."

AUDIO SETUP	
AUDIO ATT:	OFF
AUDIO FILTER:	SHARP
DOWNMIX:	DOLBY SURROUND
DIGITAL OUT:	ON
DOLBY DIGITAL:	D-PCM
DTS:	D-PCM
48kHz/96kHz PCM:	48kHz/16bit
AUDIO(HDMI):	AUTO

If you connect a component that does not conform to the selected audio signal, a loud noise (or no sound) will come out from the speakers, damaging your ears or speakers.

- DOLBY DIGITAL (DVD VIDEO/DVD-RW only)

Selects the type of Dolby Digital signal.

D-PCM	Select this when the player is connected to an audio component lacking a built-in Dolby Digital decoder. You can select whether the signals conform to Dolby Surround (Pro Logic) or not by making adjustments to the "DOWNMIX" item in "AUDIO SETUP" (page 81).
DOLBY DIGITAL	Select this when the player is connected to an audio component with a built-in Dolby Digital decoder.

- DTS (DVD VIDEO/DTS-CD)

Selects the type of DTS signal.

D-PCM	Select this when the player is connected to an audio component without a built-in DTS decoder.
DTS	Select this when the player is connected to an audio component with a built-in DTS decoder.

Note

When "DTS" is set to "DTS" and a DTS-CD is played back, audio signals are not output from the LINE OUT AUDIO L/R 1/2 jacks. When a component that cannot receive the stream signal of DTS is connected to the HDMI OUT jack, audio signals are not output from the HDMI OUT jack.

- 48kHz/96kHz PCM (DVD VIDEO only)
Selects the sampling frequency of the audio signal.

48kHz/16bit	The audio signals of DVD VIDEOS are always converted to 48 kHz/16 bit.
96kHz/24bit	All types of signals including 96 kHz/24 bit are output in their original format. However, if the signal is encrypted for copyright protection purposes, the signal is only output as 48 kHz/16 bit.

Notes

- The analog audio signals from the LINE OUT AUDIO L/R jacks and 5.1CH OUTPUT jacks are not affected by this setting and keep their original sampling frequency level.
- If the HDMI OUT jack is connected to equipment not compatible with 96 kHz/24 bit signals, 48 kHz/16 bit PCM will be automatically output even when you select "96kHz/24bit."

◆ AUDIO (HDMI)

Selects the type of audio signal output from the HDMI OUT jack.

AUTO	Normally, select this. Outputs audio signals according to the "DIGITAL OUT" settings (page 82).
PCM	Converts Dolby Digital, DTS, or 96 kHz/24 bit PCM signals to 48 kHz/16 bit PCM.

Notes

- A loud noise (or no sound) will be output if you connect the player to a TV that is not compatible with DOLBY DIGITAL/DTS signals and "AUTO" is selected. In this case, select "PCM."
- If you are using the HDMI OUT jack, make sure that "DIGITAL OUT" is set to "ON."

Settings for the Speakers

(SPEAKER SETUP)

To obtain the best possible surround sound, set the size of the speakers you have connected and their distance from your listening position. Then use the test tone to adjust the volume and balance of the speakers to the same level.

This setting is effective when connecting a speaker with 5.1 CH OUTPUT jacks (page 24).

Select "SPEAKER SETUP" in the Setup Display. To use the display, see "Using the Setup Display" (page 76).
The default settings are underlined.

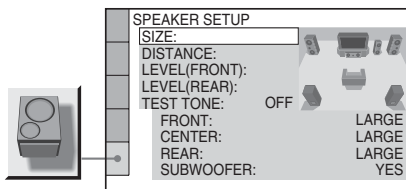

To return to the default setting

Select the item, then press CLEAR. Note that only the "SIZE" setting does not return to the default setting.

◆ SIZE

Selects the size of the speakers.

• FRONT

<u>LARGE</u>	Normally select this position.
SMALL	Select this when the speaker cannot reproduce adequate bass frequencies.

• CENTER

<u>LARGE</u>	Normally select this position.
SMALL	Select this when the speaker cannot reproduce adequate bass frequencies.
NONE	Select this if you do not connect a center speaker.

• REAR

<u>LARGE</u>	Normally select this position. Select according to the rear speakers position.
SMALL	Select this when the sound distorts or the surround effects are difficult to hear. Select according to the rear speaker position.
NONE	Select this if you do not connect rear speakers.

• SUBWOOFER

<u>YES</u>	Select this if you connect a subwoofer to output the LFE (low frequency effect) signals from the subwoofer.
NONE	Select this if you do not connect a subwoofer.

Notes

- If your speakers are too small to reproduce low bass frequencies, utilize a subwoofer for low frequency sound. When you set the speaker settings to "SMALL," the bass redirection circuitry will be activated and the bass frequencies for the speakers are output from the subwoofer.
- Even if there are fewer than 6 speakers connected, the player distributes the audio signal components to the front speakers.
- When you set the front speaker setting to "SMALL," you cannot set the center and rear speaker settings to "LARGE," and the subwoofer setting to "NONE."

◆ DISTANCE

Sets the distance from your listening position to the speakers.

Set the distance to your front speakers in “FRONT” first (A). Then adjust the values in “CENTER” (center speaker B), “REAR” (rear speaker C), and “SUBWOOFER” (D) to reflect the actual distance to your center speaker, rear speakers, and subwoofer.

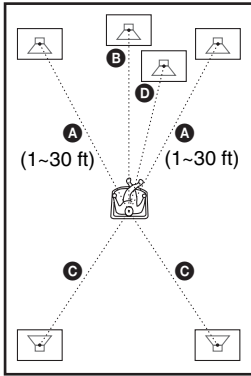

Be sure to change the value in the Setup Display each time you move the speakers. Start from the front speaker. The default adjustments are in parentheses.

FRONT (10 ft)	Set this between 1 and 30 feet in 1 foot increments.
CENTER (10 ft)	Set this within –5 feet of the “FRONT” setting in 1 foot increments. For example, if “FRONT” is set to 20 feet, “CENTER” can be set between 15 and 20 feet.
REAR (10 ft)	Set this within –15 feet of the “FRONT” setting in 1 foot increments. For example, if “FRONT” is set to 20 feet, “REAR” can be set between 5 and 20 feet.

Notes

- If each of the front or rear speakers are not placed at an equal distance from your listening position, set the distance according to the closest speaker.
- The minimum distance is 1 foot.

◆ LEVEL (FRONT)

Varies the level of the front speakers. Be sure to set “TEST TONE” to “ON” for easy adjustment.

The default adjustments are in parentheses.

L (0 dB)	Set this between –6 dB and 0 dB in 0.5 dB increments.
R (0 dB)	Set this between –6 dB and 0 dB in 0.5 dB increments.
CENTER (0 dB)	Set this between –12 dB and 0 dB in 0.5 dB increments.
SUBWOOFER (0 dB)	Set this between –10 dB and 0 dB in 0.5 dB increments.

◆ LEVEL (REAR)

Varies the level of the rear speakers. Be sure to set “TEST TONE” to “ON” for easy adjustment.

The default adjustments are in parentheses.

L (0 dB)	Set this between –12 dB and 0 dB in 0.5 dB increments.
R (0 dB)	Set this between –12 dB and 0 dB in 0.5 dB increments.

To adjust the volume of all the speakers at one time

Use the amplifier’s (receiver’s) volume control.

◆ TEST TONE

The speakers will emit a test tone. Use this when you use the 5.1CH OUTPUT jacks and adjust “LEVEL.”

OFF	The test tone is not emitted from the speakers.
ON	The test tone is emitted from each speaker in sequence.

Adjusting the speaker volume and level

- 1** Select “SPEAKER SETUP” in the Setup Display.
 - 2** Select “TEST TONE” and set to “ON.”
You will hear the test tone from each speaker in sequence.
 - 3** From your listening position, select “LEVEL (FRONT)” or “LEVEL (REAR)” and adjust the value using \uparrow/\downarrow .
 - 4** Select “TEST TONE” and set to “OFF” to turn off the test tone.
-

Note

The test tone signals are not output from the DIGITAL OUT (COAXIAL or OPTICAL)/ HDMI OUT jack.

Troubleshooting

If you experience any of the following difficulties while using the player, use this troubleshooting guide to help remedy the problem before requesting repairs. Should any problem persist, reset the player (page 77) or reconnect the power cord. If the problem still persists, consult your nearest Sony dealer.

Power

The power is not turned on.

- ➔ Check that the AC power cord is connected securely.
- ➔ Disconnect the AC power cord, wait at least 30 seconds, and then reconnect it.

Picture

There is no picture/picture noise appears.

- ➔ Re-connect the connecting cord securely.
- ➔ The connecting cord is damaged.
- ➔ Check the connection to your TV (page 17) and switch the input selector on your TV so that the signal from the player appears on the TV screen.
- ➔ The disc is dirty or flawed.
- ➔ If the picture output from your player goes through your VCR to get to your TV or if you are connected to a combination TV/VIDEO player, the copy-protection signal applied to some DVD programs could affect picture quality. If you still experience problems even when you connect your player directly to your TV, try connecting your player to your TV's S VIDEO input (page 17).
- ➔ You have set "COMPONENT OUT" in "SCREEN SETUP" to "PROGRESSIVE" even though your TV cannot accept the signal in progressive format. In this case, set "COMPONENT OUT" to "INTERLACE."

- ➔ Even if your TV is compatible with progressive format 480p signals, the image may be affected when you set "COMPONENT OUT" to "PROGRESSIVE." In this case, set "COMPONENT OUT" to "INTERLACE."
- ➔ The player is connected to an input device that is not HDCP compliant (the HDMI indicator on the front panel does not light up). See page 18.
- ➔ If the HDMI OUT jack is used for video output, changing the "HDMI RESOLUTION" setting in "SCREEN SETUP" may solve the problem (page 78). Connect the TV and the player using a video jack other than the HDMI OUT jack, and switch the TV's input to the connected video input so that you can see the on-screen displays. Change the "HDMI RESOLUTION" setting in "SCREEN SETUP," and switch the TV's input back to HDMI. If the picture still does not appear, repeat the steps and try other options.

The picture does not fill the screen, even though the aspect ratio is set in "TV TYPE" under "SCREEN SET UP."

- ➔ The aspect ratio of the disc is fixed on your DVD.

Sound

There is no sound.

- ➔ Re-connect the connecting cord securely.
- ➔ The connecting cord is damaged.
- ➔ The player is connected to the wrong input jack on the amplifier (receiver) (page 22, 23, 24).
- ➔ The amplifier (receiver) input is not correctly set.
- ➔ The player is in pause mode or in Slow-motion Play mode.
- ➔ The player is in fast forward or fast reverse mode.
- ➔ If the audio signal does not come through the DIGITAL OUT (COAXIAL or OPTICAL)/HDMI OUT jack, check the audio settings (page 82).
- ➔ Super Audio CD audio signals are not output from the DIGITAL OUT (COAXIAL or OPTICAL)/HDMI OUT jack.
- ➔ The equipment connected to the HDMI OUT jack does not conform to the audio signal format, in this case set "AUDIO(HDMI)" in "AUDIO SETUP" to "PCM" (page 82).

No sound is output from the HDMI OUT jack

- ➔ The HDMI OUT jack is connected to a DVI device (DVI jacks do not accept audio signals).
- ➔ The HDMI OUT jack does not output Super Audio CD sound.

Sound distortion occurs.

- ➔ Set "AUDIO ATT" in "AUDIO SETUP" to "ON" (page 81).

The volume is low.

- ➔ Set "AUDIO ATT" in "AUDIO SETUP" to "OFF" (page 81).

The surround effect is difficult to hear when playing a Dolby Digital, or DTS sound track.

- ➔ Check the speaker connections and settings (page 24, 26, 81).
- ➔ 5.1 channel sound is not recorded on the disc being played.

The sound only comes from the center speaker.

- ➔ Depending on the disc, the sound may come from the center speaker only.

Operation

The remote does not function.

- ➔ The batteries in the remote are weak.
- ➔ There are obstacles between the remote and the player.
- ➔ The distance between the remote and the player is too far.
- ➔ The remote is not pointed at the remote sensor on the player.
- ➔ The COMMAND MODE switch setting on the remote does not match the setting on the player (page 16).

The disc does not play.

- ➔ The disc is skewed.
- ➔ The player cannot play certain discs (page 6).
- ➔ The region code on the DVD does not match the player.

- ➔ Moisture has condensed inside the player (page 3).
- ➔ The player cannot play a recorded disc that is not correctly finalized (page 7).

The MP3 audio track cannot be played (page 39).

- ➔ The DATA CD is not recorded in an MP3 format that conforms to ISO9660 Level 1/ Level 2 or Joliet.
- ➔ The MP3 audio track does not have the extension ".MP3."
- ➔ The data is not formatted in MP3 even though it has the extension ".MP3."
- ➔ The data is not MPEG1 Audio Layer 3 data.
- ➔ The player cannot play audio tracks in MP3PRO format.

The JPEG image file cannot be played (page 65).

- ➔ The DATA CD is not recorded in a JPEG format that conforms to ISO 9660 Level 1/ Level 2, or Joliet.
- ➔ The file has an extension other than "JPEG" or ".JPG."
- ➔ The image is larger than 5760 (width) × 3840 (height) in normal mode, or more than 8 M pixels in progressive JPEG. (Some progressive JPEG files cannot be displayed even if the file size is within this specified capacity.)
- ➔ The image does not fit the screen (the image is reduced).
- ➔ "MODE (MP3, JPEG)" is set to "AUDIO (MP3)" (page 68).

The title of the MP3 audio album or track is not correctly displayed.

- ➔ The player can only display numbers and alphabet. Other characters are displayed as "*.*"

The disc does not start playing from the beginning.

- ➔ Program Play, Shuffle Play, Repeat Play, or A-B Repeat Play has been selected (page 39).
- ➔ Resume play has taken effect (page 34).

The player starts playing the disc automatically.

- ➔ The disc features an auto playback function.
- ➔ “AUTO PLAY” in “CUSTOM SETUP” is set to “ON” (page 80).

Playback stops automatically.

- ➔ While playing discs with an auto pause signal, the player stops playback at the auto pause signal.

Some functions such as Stop, Search, Slow-motion Play, Repeat Play, Shuffle Play, or Program Play cannot be performed.

- ➔ Depending on the disc, you may not be able to do some of the operations above. Refer to the operating manual that comes with the disc.

The language for the sound track cannot be changed.

- ➔ Try using the DVD’s menu instead of the direct selection button on the remote (page 35).
- ➔ Multilingual tracks are not recorded on the DVD being played.
- ➔ The DVD prohibits the changing of the language for the sound track.

The subtitle language cannot be changed or turned off.

- ➔ Try using the DVD’s menu instead of the direct selection button on the remote (page 35).
- ➔ Multilingual subtitles are not recorded on the DVD being played.
- ➔ The DVD prohibits the changing of subtitles.

The angles cannot be changed.

- ➔ Try using the DVD’s menu instead of the direct selection button on the remote (page 35).
- ➔ Multi-angles are not recorded on the DVD being played.
- ➔ The angle can only be changed when the “ANGLE” indicator lights up on the front panel display (page 9).
- ➔ The DVD prohibits changing of the angles.

The player does not operate properly.

- ➔ When static electricity, etc., causes the player to operate abnormally, unplug the player.

The front cover does not open and “LOCKED” appears on the front panel display.

- ➔ Child Lock is set (page 34).

The front cover does not open and “TRAY LOCKED” appears on the front panel display.

- ➔ Contact your Sony dealer or local authorized Sony service facility.

“Data error” appears on the TV screen when playing a DATA CD.

- ➔ The MP3 audio track/JPEG image file you want to play is broken.
 - ➔ The data is not MPEG1 Audio Layer 3 data.
 - ➔ The JPEG image file format does not conform to DCF (page 64).
 - ➔ The JPEG image file has the extension “.JPG” or “.JPEG,” but is not in JPEG format.
-

Glossary

Chapter (page 9, 13, 53)

Sections of a picture or a music feature that are smaller than titles. A title is composed of several chapters. Depending on the disc, no chapters may be recorded.

Dolby Digital (page 24, 82)

Digital audio compression technology developed by Dolby Laboratories. This technology conforms to multi-channel surround sound. The rear channel is stereo and there is a discrete subwoofer channel in this format. Dolby Digital provides the same discrete channels of high quality digital audio found in "Dolby Digital" theater surround sound systems. Good channel separation is realized because all of the channel data are recorded discretely and little deterioration is realized because all channel data processing is digital.

Dolby Surround (Pro Logic) (page 23, 81)

Audio signal processing technology that Dolby Laboratories developed for surround sound. When the input signal contains a surround component, the Pro Logic process outputs the front, center and rear signals. The rear channel is monaural.

DTS (page 24, 82)

Digital audio compression technology that Digital Theater Systems, Inc. developed. This technology conforms to multi-channel surround sound. The rear channel is stereo and there is a discrete subwoofer channel in this format. DTS provides discrete channels of high quality digital audio. Good channel separation is realized because all of the channel data is recorded discretely and little deterioration is realized because all channel data processing is digital.

DVD VIDEO (page 6)

A disc that contains up to 8 hours of moving pictures even though its diameter is the same as a CD.

The data capacity of a single-layer and single-sided DVD is 4.7 GB (Giga Byte), which is 7 times that of a CD. The data capacity of a double-layer and single-sided DVD is 8.5 GB, a single-layer and double-sided DVD is 9.4 GB, and double-layer and double-sided DVD is 17 GB.

The picture data uses the MPEG 2 format, one of the worldwide standards of digital compression technology. The picture data is compressed to about 1/40 (average) of its original size. The DVD also uses a variable rate coding technology that changes the data to be allocated according to the status of the picture. Audio information is recorded in a multi-channel format, such as Dolby Digital, allowing you to enjoy a more real audio presence.

Furthermore, various advanced functions such as the multi-angle, multilingual, and Parental Control functions are provided with the DVD.

DVD-RW (page 6, 36)

A DVD-RW is a recordable and rewritable disc that is the same size as the DVD VIDEO. The DVD-RW has two different modes: VR mode and Video mode.

DVD-RWs created in Video mode have the same format as a DVD VIDEO, while discs created in VR (Video Recording) mode allow the contents to be programmed or edited.

DVD+RW (page 6)

A DVD+RW (plus RW) is a recordable and rewritable disc. DVD+RWs use a recording format that is comparable to the DVD VIDEO format.

Film based software, Video based software

DVDs can be classified as Film based or Video based software. Film based DVDs contain the same images (24 frames per second) that are shown at movie theaters. Video based DVDs, such as television dramas or sit-coms, displays images at 30 frames (or 60 fields) per second.

HDMI (High-Definition Multimedia Interface)

HDMI is an interface that supports both video and audio on a single digital connection. The HDMI connection carries standard to high definition video signals and multi-channel audio signals to AV components such as HDMI equipped TVs, in digital form without degradation.

Since the video signals are compatible with the current DVI (Digital Visual Interface) format, HDMI jacks can be connected to DVI jacks by way of an HDMI-DVI converter cord. The HDMI specification supports HDCP (High-bandwidth Digital Contents Protection), a copy protection technology that incorporates coding technology for digital video signals.

Index (Super Audio CD/CD)/ Video Index (VIDEO CD) (page 9, 13, 53)

A number that divides a track into sections to easily locate the point you want on a Super Audio CD, CD or VIDEO CD. Depending on the disc, no index may be recorded.

Normal (Interlace) format (page 79)

Normal (Interlace) format shows every other line of an image as a single “field” and is the standard method for displaying images on television. The even number field shows the even numbered lines of an image, and the odd numbered field shows the odd numbered lines of an image.

Progressive format (page 79)

Compared to the Normal (Interlace) format that alternately shows every other line of an image (field) to create one frame, the Progressive format shows the entire image at once as a single frame. This means that while the Normal (Interlace) format can show 25 or 30 frames (50-60 fields) in one second, the Progressive format can show 50-60 frames in one second. The overall picture quality increases and still images, text, and horizontal lines appear sharper. This player is compatible with the 525 or 625 progressive format.

Scene (page 9)

On a VIDEO CD with PBC (playback control) functions, the menu screens, moving pictures and still pictures are divided into sections called “scenes.”

Super Audio CD (page 6)

Super Audio CD is a new high-quality audio disc standard where music is recorded in the DSD (Direct Stream Digital) format (conventional CDs are recorded in the PCM format). The DSD format, using a sampling frequency 64 times higher than that of a conventional CD, and with 1-bit quantization, achieves both a wide frequency range and a wide dynamic range across the audible frequency range, and so provides music reproduction extremely faithful to the original sound.

Types of Super Audio CDs

There are two types of discs, depending on the Super Audio CD layer and CD layer combination.

- Super Audio CD layer: A high-density signal layer for Super Audio CD
- CD layer¹⁾: A layer that is readable by a conventional CD player

Single layer disc
(a disc with a single Super Audio CD layer)

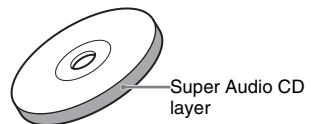

Hybrid disc²⁾
(a disc with an Super Audio CD layer and a CD layer)

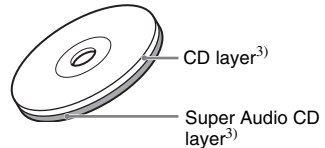

A Super Audio CD layer consists of the 2 channel area or the multi-channel area.

- 2 channel area: An area in which 2 channel stereo tracks are recorded
- Multi-channel area: An area in which multi-channel (up to 5.1 channels) tracks are recorded

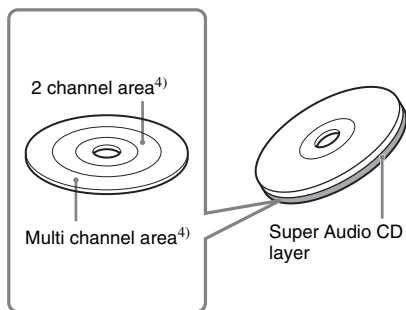

- 1) You can play the CD layer on a conventional CD player.
- 2) Since both layers are on one side, it is not necessary to turn the disc over.
- 3) To select a layer, see "Selecting a Playback Area for a Super Audio CD" (page 37).
- 4) To select an area, see "Selecting a Playback Area for a Super Audio CD" (page 37).

Title (page 9, 13, 53)

The longest section of a picture or music feature on a DVD, movie, etc., in video software, or the entire album in audio software.

Track (page 9, 13, 53)

Sections of a picture or a music feature on a VIDEO CD, Super Audio CD, CD, or DATA CD (MP3) (the length of a song).

Specifications

System

Laser: Semiconductor laser

$\lambda = 780$ nm for CD

$\lambda = 650$ nm for Super Audio CD and DVD

Emission duration: continuous

Signal format system: NTSC

Audio characteristics

Frequency response: DVD VIDEO (PCM 96 kHz): 2 Hz to 44 kHz (44 kHz: -2 dB ± 1 dB), Super Audio CD: 2 Hz to 100 kHz (50 kHz: -3 dB ± 1 dB), CD: 2 Hz to 20 kHz (± 0.5 dB)

Signal-to-noise ratio (S/N ratio): 115 dB (LINE OUT AUDIO L/R 1/2 jacks only)

Harmonic distortion: 0.003 %

Dynamic range: DVD VIDEO/Super Audio CD: 103 dB, CD: 99 dB

Wow and flutter: Less than detected value ($\pm 0.001\%$ W PEAK)

Outputs

(Jack name): Jack type/Output level/Load impedance)

LINE OUT AUDIO L/R 1/2: Phono jack/ 2 Vrms/10 kilohms

DIGITAL OUT (OPTICAL): Optical output jack/ -18 dBm (wave length: 660 nm)

DIGITAL OUT (COAXIAL): Phono jack/ 0.5 Vp-p/75 ohms

HDMI OUTPUT: TypeA (19 pin)

5.1CH OUTPUT: Phono jack/2 Vrms/ 10 kilohms

COMPONENT VIDEO OUT(Y, P_B/C_B, P_R/C_R):

Phono jack/Y: 1.0 Vp-p/P_B/C_B, P_R/C_R: interlace¹⁾ = 0.648 Vp-p, progressive or interlace²⁾ = 0.7 Vp-p/75 ohms

1) BLACK LEVEL (COMPONENT OUT) is ON

2) BLACK LEVEL (COMPONENT OUT) is OFF

LINE OUT (VIDEO) 1/2: Phono jack/ 1.0 Vp-p/75 ohms

S VIDEO OUT 1/2: 4-pin mini DIN/Y: 1.0 Vp-p, C: 0.286 Vp-p/75 ohms

General

Power requirements:

120 V AC, 60 Hz

Power consumption: 25 W

Dimensions (approx.): 430 × 189 × 545 mm (17 × 7 1/2 × 21 1/2 in.) (width/height/depth) incl. projecting parts

Mass (approx.): 8.6 kg (18 lb 15 oz)

Operating temperature: 5 °C to 35 °C (41 °F to 95 °F)

Operating humidity: 25 % to 80 %

Supplied accessories

See page 15.

Specifications and design are subject to change without notice.

ENERGY STAR® is a U.S. registered mark. As an ENERGY STAR® Partner, Sony Corporation has determined that this product meets the ENERGY STAR® guidelines for energy efficiency.

Language Code List

For details, see pages 59, 61, 77.

The language spellings conform to the ISO 639: 1988 (E/F) standard.

Code	Language	Code	Language	Code	Language	Code	Language
1027	Afar	1183	Irish	1347	Maori	1507	Samoan
1028	Abkhazian	1186	Scots Gaelic	1349	Macedonian	1508	Shona
1032	Afrikaans	1194	Galician	1350	Malayalam	1509	Somali
1039	Amharic	1196	Guarani	1352	Mongolian	1511	Albanian
1044	Arabic	1203	Gujarati	1353	Moldavian	1512	Serbian
1045	Assamese	1209	Hausa	1356	Marathi	1513	Siswati
1051	Aymara	1217	Hindi	1357	Malay	1514	Sesotho
1052	Azerbaijani	1226	Croatian	1358	Maltese	1515	Sundanese
1053	Bashkir	1229	Hungarian	1363	Burmese	1516	Swedish
1057	Byelorussian	1233	Armenian	1365	Nauru	1517	Swahili
1059	Bulgarian	1235	Interlingua	1369	Nepali	1521	Tamil
1060	Bihari	1239	Interlingue	1376	Dutch	1525	Telugu
1061	Bislama	1245	Inupiak	1379	Norwegian	1527	Tajik
1066	Bengali;	1248	Indonesian	1393	Occitan	1528	Thai
	Bangla	1253	Icelandic	1403	(Afan)Oromo	1529	Tigrinya
1067	Tibetan	1254	Italian	1408	Oriya	1531	Turkmen
1070	Breton	1257	Hebrew	1417	Punjabi	1532	Tagalog
1079	Catalan	1261	Japanese	1428	Polish	1534	Setswana
1093	Corsican	1269	Yiddish	1435	Pashto;	1535	Tonga
1097	Czech	1283	Javanese		Pushto	1538	Turkish
1103	Welsh	1287	Georgian	1436	Portuguese	1539	Tsonga
1105	Danish	1297	Kazakh	1463	Quechua	1540	Tatar
1109	German	1298	Greenlandic	1481	Rhaeto-	1543	Twi
1130	Bhutani	1299	Cambodian		Romance	1557	Ukrainian
1142	Greek	1300	Kannada	1482	Kirundi	1564	Urdu
1144	English	1301	Korean	1483	Romanian	1572	Uzbek
1145	Esperanto	1305	Kashmiri	1489	Russian	1581	Vietnamese
1149	Spanish	1307	Kurdish	1491	Kinyarwanda	1587	Volapük
1150	Estonian	1311	Kirghiz	1495	Sanskrit	1613	Wolof
1151	Basque	1313	Latin	1498	Sindhi	1632	Xhosa
1157	Persian	1326	Lingala	1501	Sangho	1665	Yoruba
1165	Finnish	1327	Laothian	1502	Serbo-	1684	Chinese
1166	Fiji	1332	Lithuanian		Croatian	1697	Zulu
1171	Faroese	1334	Latvian;	1503	Singhalese		
1174	French		Lettish	1505	Slovak		
1181	Frisian	1345	Malagasy	1506	Slovenian	1703	Not specified

Additional Information

Parental Control Area Code List

For details, see page 71.

Code	Area	Code	Area	Code	Area	Code	Area
2044	Argentina	2115	Denmark	2304	Korea	2436	Portugal
2047	Australia	2165	Finland	2363	Malaysia	2489	Russia
2046	Austria	2174	France	2362	Mexico	2501	Singapore
2057	Belgium	2109	Germany	2376	Netherlands	2149	Spain
2070	Brazil	2248	India	2390	New Zealand	2499	Sweden
2079	Canada	2238	Indonesia	2379	Norway	2086	Switzerland
2090	Chile	2254	Italy	2427	Pakistan	2528	Thailand
2092	China	2276	Japan	2424	Philippines	2184	United Kingdom

Index

Numerics

- 16:9 78
- 4:3 LETTER BOX 78
- 4:3 OUTPUT 79
- 4:3 PAN SCAN 78
- 48kHz/96kHz PCM 82
- 5.1 Channel Surround 20, 24

A

- A-B REPEAT 42
- Advance 33
- ALBUM 53
- Album 64
- ANGLE 61
- AUDIO 59, 77
- AUDIO ATT 81
- AUDIO FILTER 81
- AUDIO SETUP 81
- AUTO PLAY 80
- AUTO POWER OFF 80

B

- Batteries 15
- BLACK LEVEL 79
- BLACK LEVEL
(COMPONENT OUT) 79

C

- CD 32
- CHAPTER 13, 53
- Chapter 9, 89
- CHAPTER VIEWER 55
- Child Lock 34
- COMMAND MODE 16
- COMPONENT OUT 79
- Connecting 17
- Continuous play
- DATA CD 64
- DVD 32
- Super Audio CD/CD/
VIDEO CD 32
- Control Menu 12
- CUSTOM 76
- CUSTOM PARENTAL
CONTROL 70
- CUSTOM PICTURE MODE
62
- CUSTOM SETUP 80

D

- DATA CD 6, 64
- DATE 67
- DIGITAL OUT 81
- Digital output 82
- DIMMER 80
- DISC 53

- Disc Explorer 43
- Disc Memo 48
- Disc Memo Input 48
- Display
- Control Menu Display 12
- Disc Explorer display 44
- Front panel display 9, 57
- Setup Display 76
- DISTANCE 84
- DOLBY DIGITAL 23, 24,
59, 82, 89
- DOWNMIX 81
- DTS 24, 59, 82, 89
- DVD VIDEO 6, 32, 89
- DVD+RW 89
- DVD/Super Audio CD/CD
text 56
- DVD-RW 6, 36, 89

E

- EDIT 48
- EFFECT 69

F

- Fast forward 52
- Fast reverse 52
- FILE 46, 53
- FOLDER 46
- Folder Name Input 48
- Front panel display 9, 57

G

- Genre 50

H

- handling discs 2
- HDMI
- AUDIO (HDMI) 82
- HDMI 90
- HDMI RESOLUTION 78
- Hooking up 17
- Hooking up 15

I

- INDEX 13, 53
- Index 90
- INTERLACE 79, 90
- INTERVAL 69

J

- JACKET PICTURE 45
- JPEG 64

K

- Keyboard 49

L

- LANGUAGE SETUP 77
- LEVEL 84
- Loading Discs 43
- Locating
a point on a disc 52

M

- MENU 77
- Menu
- DVD's menu 35
- Top menu 35
- MODE (MP3, JPEG) 68
- MP3 6, 64
- Multi/2CH 37
- MULTI-DISC RESUME 80

O

- ONE/ALL DISCS 39
- On-screen display
- Control Menu Display 12
- Disc Explorer display 44
- Setup Display 76
- ORIGINAL 36
- ORIGINAL/PLAY LIST 36
- OSD 77

P

- PARENTAL CONTROL 70
- PAUSE MODE 80
- PBC Playback 38
- PICTURE NAVIGATION
55, 66
- PLAY LIST 36
- PRO LOGIC 23, 89
- PROGRAM 39
- Program Play 39
- PROGRESSIVE 79, 90

Q

- QUICK 77
- Quick Setup 26, 77

R

- Remote 15, 73
- REPEAT 41
- Repeat Play 41
- Replay 33
- RESET 77
- Resume Play 34

S

S VIDEO output 17
SCENE 13, 53
Scene 9, 90
SCREEN SAVER 78
SCREEN SETUP 78
Searching 52
Selecting a disc 33, 44
SETUP 76, 77
Setup Display 76
SHARPNESS 63
SHUFFLE 41
Shuffle Play 41
SIZE 83
Skipping discs 31
Slide Show 68
Slow-motion Play 52
SORT 51
SPEAKER SETUP 83
Speakers
 Hooking up 20
SUBTITLE 61, 77
Super Audio CD 37, 90
Super Audio CD/CD layer 37

T

TEST TONE 84
TIME/MEMO 13, 53
TIME/TEXT 13, 53, 56
TITLE 13, 53
Title 9, 91
TITLE VIEWER 55
TOP MENU 35
TRACK 13, 53
Track 9, 91
TRACK VIEWER 55
Troubleshooting 86
TV TYPE 78

U

Usable discs 6

V

Various 39
VIDEO CD 6, 32

Z

ZOOM 67

