

DVD Home Theatre System

Operating Instructions



MP3

*Digital Direct
Twin Drive Subwoofer*

DAV-FR1/FR8/FR9

WARNING

To prevent fire or shock hazard, do not expose the unit to rain or moisture.

Caution – The use of optical instruments with this product will increase eye hazard.

For the customers in the U.S.A

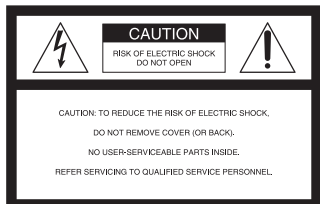

This symbol is intended to alert the user to the presence of uninsulated “dangerous voltage” within the product’s enclosure that may be of sufficient magnitude to constitute a risk of electric shock to persons.



This symbol is intended to alert the user to the presence of important operating and maintenance (servicing) instructions in the literature accompanying the appliance.

Owner’s Record

The model and serial numbers are located at the bottom of the unit. Record the serial number in the space provided below. Refer to them whenever you call upon your Sony dealer regarding this product.

Model No. DAV-FR1/FR8/FR9

Serial No. _____

WARNING

This equipment has been tested and found to comply with the limits for a Class B digital device, pursuant to Part 15 of the FCC Rules. These limits are designed to provide reasonable protection against harmful interference in a residential installation. This equipment generates, uses, and can radiate radio frequency energy and, if not installed and used in accordance with the instructions, may cause harmful interference to radio communications. However, there is no guarantee that interference will not occur in a particular installation. If this equipment does cause harmful interference to radio or television reception, which can be determined by turning the equipment off and on, the user is encouraged to try to correct the interference by one or more of the following measures:

- Reorient or relocate the receiving antenna.
- Increase the separation between the equipment and system.
- Connect the equipment into an outlet on a circuit different from that to which the system is connected.
- Consult the dealer or an experienced radio/TV technician for help.

CAUTION

You are cautioned that any changes or modifications not expressly approved in this manual could void your authority to operate this equipment.

Note to CATV system installer:

This reminder is provided to call the CATV system installer’s attention to Article 820-40 of the NEC that provides guidelines for proper grounding and, in particular, specifies that the cable ground shall be connected to the grounding system of the building, as close to the point of cable entry as practical.

For the customers in Canada

CAUTION

TO PREVENT ELECTRIC SHOCK, MATCH WIDE BLADE OF PLUG TO WIDE SLOT, FULLY INSERT.

Precautions

Safety

- If anything falls into the cabinet, unplug the unit and have it checked by qualified personnel before operating it any further.
- The unit is not disconnected from the AC power source (mains) as long as it is connected to the mains outlet, even if the unit itself has been turned off.
- Unplug the unit from the wall outlet if you do not intend to use it for an extended period of time. To disconnect the cord, pull it out by the plug, never by the cord.

Installing

- Allow adequate air circulation to prevent internal heat buildup.
- Do not place the unit on surfaces (rugs, blankets, etc.) or near materials (curtains, draperies) that may block the ventilation slots.
- Do not install the unit near heat sources such as radiators, or air ducts, or in a place subject to direct sunlight, excessive dust, mechanical vibration, or shock.
- Do not install the unit in an inclined position. It is designed to be operated in a horizontal position only.
- Keep the unit and discs away from equipment with strong magnets, such as microwave ovens, or large loudspeakers.
- Do not place heavy objects on the unit.
- If the unit is brought directly from a cold to a warm location, moisture may condense inside the DVD Home Theatre System and cause damage to the lenses. When you first install the unit, or when you move it from a cold to a warm location, wait for about 30 minutes before operating the unit.



ENERGY STAR® is a U.S. registered mark. As an ENERGY STAR® partner, Sony Corporation has determined that this product meets the ENERGY STAR® guidelines for energy efficiency.

Welcome!

Thank you for purchasing Sony DVD Home Theatre System. Before operating this system, please read this manual thoroughly and retain it for future reference.

Precautions

On power sources

AC power cord must be changed only at the qualified service shop.

On placement

- Place the system in a location with adequate ventilation to prevent heat build-up in the system.
- At high volume, over long periods of time, the cabinet becomes hot to the touch. This is not a malfunction. However, touching the cabinet should be avoided. Do not place the unit in a confined space where ventilation is poor as this may cause overheating.
- Do not block the cooling fan or ventilation slots by putting anything on the system. Also, do not place the system on a soft surface such as a rug that might block the ventilation holes on the bottom. The system is equipped with a high power amplifier. If the cooling fan or ventilation slots are blocked, the unit can overheat and malfunction.
- Do not place the system in a location near heat sources, or in a place subject to direct sunlight, excessive dust, or mechanical shock.

On operation

- If the system is brought directly from a cold to a warm location, or is placed in a very damp room, moisture may condense on the lenses inside the system. Should this occur, the system may not operate properly. In this case, remove the disc and leave the system turned on for about half an hour until the moisture evaporates.
- When you move the system, take out any disc. If you don't, the disc may be damaged.
- For power saving purposes, set the system to standby mode by pressing the  button (the STANDBY indicator lights up). To turn off the system completely, remove the AC power cord (mains lead) from the wall outlet (mains).

On adjusting volume

Do not turn up the volume while listening to a section with very low level inputs or no audio signals. If you do, the speakers may be damaged when a peak level section is suddenly played.

On cleaning

Clean the cabinet, panel, and controls with a soft cloth slightly moistened with a mild detergent solution. Do not use any type of abrasive pad, scouring powder or solvent such as alcohol or benzine.

If you have any questions or problems concerning your system, please consult your nearest Sony dealer.

On cleaning discs

Do not use a commercially available CD/DVD cleaning disc. It may cause a malfunction.

On your TV's color

If the speakers should cause the TV screen to have color irregularity, turn off the TV at once then turn it on after 15 to 30 minutes. If color irregularity should persist, place the speakers farther away from the set.

The nameplate is located on the bottom exterior of the unit.

IMPORTANT NOTICE

Caution: This system is capable of holding a still video image or on-screen display image on your television screen indefinitely. If you leave the still video image or on-screen display image displayed on your TV for an extended period of time you risk permanent damage to your television screen. Projection televisions are especially susceptible to this.

On moving the system

When you carry the system, use the following procedure to protect the inner mechanism.

- 1 Make sure that a disc is removed from the system.
- 2 Press FUNCTION repeatedly to select "DVD."
- 3 Press **◀◀**, **▶▶**, and **DISC1 ▲** simultaneously.
The front panel display is changed to "MECHA LOCK."
To cancel, press **⏻**.
- 4 Remove the AC power cord (mains lead) from the wall outlet (mains).

Table of Contents

Welcome!	3
Precautions	3
About This Manual	7
This System Can Play the Following	
Discs	7
Terms for Discs	7
Notes about Discs	9
Note on DVD 5-DISC changer	10
Guide to the Control Menu Display	11

Getting Started

Unpacking	13
Inserting Batteries into the Remote	13
Step 1: Speaker System Hookup	14
Step 2: Antenna (aerial) Hookups	21
Step 3: TV and Video Component	
Hookups	23
Step 4: Connecting the AC Power Cord	
(Mains Lead)	27
Step 5: Performing the Quick Setup	27
Speaker Setup	29

Playing Discs

Playing Discs	30
Resuming Playback from the Point Where	
You Stopped the Disc	32
(Resume Play)	
Using the DVD's Menu	33
Playing VIDEO CDs with PBC Functions	
(Ver. 2.0)	33
(PBC Playback)	
Playing an MP3 Audio Track	34
Playing JPEG Image Files	36
Selecting the Play Mode	38
(All Discs, One Disc, or Album)	
Creating Your Own Program	39
(Program Play)	
Playing in Random Order	41
(Shuffle Play)	
Playing Repeatedly	42
(Repeat Play)	
Searching for a Particular Point on	
a Disc	43
(Scan, Slow-motion Play)	

Searching for a Title/Chapter/Track/ Index/Album/File	44
Viewing Disc Information	46

Sound Adjustments

Changing the Sound	51
Enjoying Surround Sound	53
Selecting the Surround Back Decoding	
Mode	57
Using the Sound Effect	59

Using Various Additional Functions

Changing the Angles	60
Displaying Subtitles	61
Locking Discs	62
(CUSTOM PARENTAL CONTROL, PARENTAL CONTROL)	

Other Operations

Controlling TV with the Supplied	
Remote	67
Using the SONY TV DIRECT	
Function	69
Using the Video or Other Units	70
Enjoying Multiplex Broadcast Sound	
(DUAL MONO)	71
Enjoying the Radio	72
Using the Sleep Timer	75
Changing the Brightness of the Front	
Panel Display	75
Returning to the Default Settings	76

continued

Settings and Adjustments







Using the Setup Display.....	77
Setting the Display or Sound Track	
Language	78
(LANGUAGE SETUP)	
Settings for the Display.....	78
(SCREEN SETUP)	
Custom Settings	80
(CUSTOM SETUP)	
Settings for the Speakers.....	81
(SPEAKER SETUP)	
Quick Setup and Resetting	
the System.....	87
(SETUP)	

Additional Information

Troubleshooting	88
Specifications.....	91
Glossary	93
Index to Parts and Controls.....	97
Language Code List	102
DVD Setup Menu List	103
AMP Menu List	105
Index	106
Quick Reference for Remote	
Commander	Back cover



About This Manual





- The instructions in this manual describe the controls on the remote. You can also use the controls on the system if they have the same or similar names as those on the remote.
- The instructions in this manual are for DAV-FR1, DAV-FR8, and DAV-FR9. DAV-FR1 is the model used for illustration purposes only. Any difference in operation is clearly indicated in the text, for example, “DAV-FR9 only.”
- The following symbols are used in this manual.

Symbol	Meaning
	Functions available for DVD VIDEOS, DVD-Rs/DVD-RWs in video mode, and DVD+Rs/DVD+RWs
	Functions available in VIDEO CD mode
	Functions available in CD mode
	Functions available in Super Audio CD and Audio CD mode
	Functions available for MP3* audio tracks
	Functions available for JPEG files

* MP3 (MPEG1 Audio Layer 3) is a standard format defined by ISO/MPEG which compresses audio data.

This System Can Play the Following Discs

Format of discs	Disc logo
DVD VIDEO	
Super Audio CD	 SUPER AUDIO CD
VIDEO CD	

Format of discs	Disc logo
Audio CD	
CD-R/CD-RW (audio data) (MP3 files) (JPEG files)	 
	 

The “DVD VIDEO” logo is a trademark.

Terms for Discs

- **Title**
The longest section of a picture or music feature on a DVD, movie, etc., in video software, or the entire album in audio software.
- **Chapter**
Section of a picture or a music piece that is smaller than titles. A title is composed of several chapters. Depending on the disc, no chapters may be recorded.
- **Album**
Section of a music piece or an image on a data CD containing MP3 audio tracks or JPEG files.
- **Track**
Section of a picture or a music piece on a VIDEO CD, Super Audio CD, CD, or MP3.
- **Index (Super Audio CD, CD) / Video Index (VIDEO CD)**
A number that divides a track into sections to easily locate the point you want on a VIDEO CD, Super Audio CD, or CD. Depending on the disc, no indexes may be recorded.
- **Scene**
On a VIDEO CD with PBC functions (page 33), the menu screens, moving pictures and still pictures are divided into sections called “scenes.”
- **File**
Section of a picture on a data CD containing JPEG image files.

continued

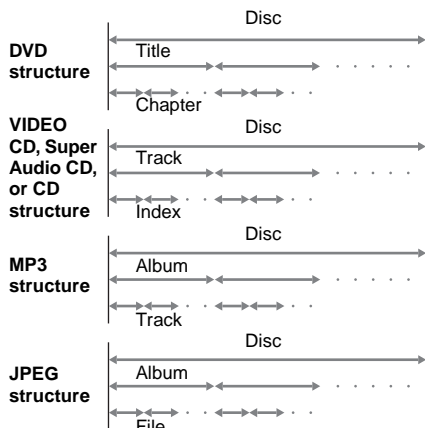

Note on PBC (Playback Control) (VIDEO CDs)

This system conforms to Ver. 1.1 and Ver. 2.0 of VIDEO CD standards. You can enjoy two kinds of playback depending on the disc type.

Disc type	You can
VIDEO CDs without PBC functions (Ver. 1.1 discs)	Enjoy video playback (moving pictures) as well as music.
VIDEO CDs with PBC functions (Ver. 2.0 discs)	Play interactive software using menu screens displayed on the TV screen (PBC Playback), in addition to the video playback functions of Ver. 1.1 discs. Moreover, you can play high-resolution still pictures, if they are included on the disc.

About Multi Session CD

- This system can play Multi Session CDs when an MP3 audio track is contained in the first session. Any subsequent MP3 audio tracks recorded in later sessions can also be played back.
- This system can play Multi Session CDs when a JPEG image file is contained in the first session. Any subsequent JPEG image files recorded in later sessions can also be played back.
- If audio tracks and images in music CD format or video CD format are recorded in the first session, only the first session will be played back.

Region code

Your system has a region code printed on the back of the unit and will only play DVDs labeled with the same region code.

DVDs labeled  will also play on this system. If you try to play any other DVD, the message [Playback prohibited by area limitations.] will appear on the TV screen. Depending on the DVD, no region code indication may be given even though playing the DVD is prohibited by area restrictions.

Examples of discs that the system cannot play

The system cannot play the following discs:

- CD-ROMs (except for extension “.MP3,” “.JPG,” or “.JPEG”)
 - CD-Rs/CD-RWs other than those recorded in the following formats:
 - audio CD format
 - video CD format
 - MP3/JPEG format that conforms to ISO9660* Level 1/Level 2, or its extended format, Joliet
 - Data part of CD-Extras
 - DVD-ROMs
 - DVD Audio discs
 - DVD-RAMs
 - DVD-RWs in VR (Video Recording) mode
 - Progressive JPEG file
- * A logical format of files and folders on CD-ROMs, defined by ISO (International Organization for standardization)

Do not load the following discs:

- A DVD with a different region code (page 8, 95).
- A disc that is neither standard nor circular (e.g., card, heart, or star shape).
- A disc with paper or stickers on it.
- A disc that has adhesive or cellophane tape still left on it.

Notes about CD-R/CD-RW/DVD-R/DVD-RW (Video mode)/DVD+R/DVD+RW

In some cases, CD-R/CD-RW/DVD-R/DVD-RW (Video mode)/DVD+R/DVD+RW cannot be played on this player due to the recording quality or physical condition of the disc, or the characteristics of the recording device and authoring software.

The disc will not play if it has not been correctly finalized. For more information, see the operating instructions for the recording device.

Note that discs created in the Packet Write format cannot be played.

Music discs encoded with copyright protection technologies

This product is designed to play back discs that conform to the Compact Disc (CD) standard.

Recently, various music discs encoded with copyright protection technologies are marketed by some record companies. Please be aware that among those discs, there are some that do not conform to the CD standard and may not be playable by this product.

Note on playback operations of DVDs and VIDEO CDs

Some playback operations of DVDs and VIDEO CDs may be intentionally set by software producers. Since this system plays DVDs and VIDEO CDs according to the disc contents the software producers designed, some playback features may not be available. Also, refer to the instructions supplied with the DVDs or VIDEO CDs.

Copyrights

This product incorporates copyright protection technology that is protected by U.S. patents and other intellectual property rights. Use of this copyright protection technology must be authorized by Macrovision, and is intended for home and other limited viewing uses only unless otherwise authorized by Macrovision. Reverse engineering or disassembly is prohibited.

This system incorporates with Dolby* Digital and Dolby Pro Logic (II) adaptive matrix surround decoder and the DTS** Digital Surround System.

- * Manufactured under license from Dolby Laboratories. "Dolby", "Pro Logic", and the double-D symbol are trademarks of Dolby Laboratories.
- ** Manufactured under license from Digital Theater Systems, Inc. "DTS", "DTS-ES", "Neo:6", and "DTS Digital Surround" are trademarks of Digital Theater Systems, Inc.

Notes about Discs

On handling discs

- To keep the disc clean, handle the disc by its edge. Do not touch the surface.
- Do not stick paper or tape on the disc.



- Do not expose the disc to direct sunlight or heat sources such as hot air ducts, or leave it in a car parked in direct sunlight as the temperature may rise considerably inside the car.
- After playing, store the disc in its case.

On cleaning

- Before playing, clean the disc with a cleaning cloth. Wipe the disc from the center out.



- Do not use solvents such as benzine, thinner, commercially available cleaners, or anti-static spray intended for vinyl LPs.

This system can only play back a standard circular disc. Using neither standard nor circular discs (e.g., card, heart, or star shape) may cause a malfunction.

Do not use a disc that has a commercially available accessory attached, such as a label or ring.

Note on DVD 5-DISC changer

Disc changer system

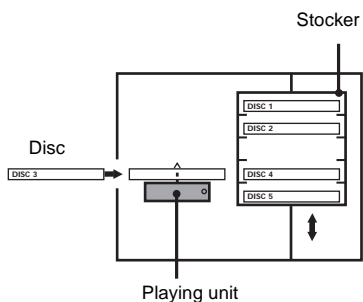

The disc changer consists of a playing unit and a stocker which transports the discs to the disc slot and the playing unit.

For example, if you press DISC 3, the stocker moves until the DISC 3 comes to the position of the playing unit and then moves the DISC 3 over the playing unit.

Notes

- Do not insert or eject discs while playing.
- Noise may come from the disc changer when changing discs or turning the system on and off. However, this is just noise produced by the operation of the internal mechanisms and does not indicate a malfunction.
- 8 cm (3-inch) CDs or DVDs cannot be stored in the stocker.







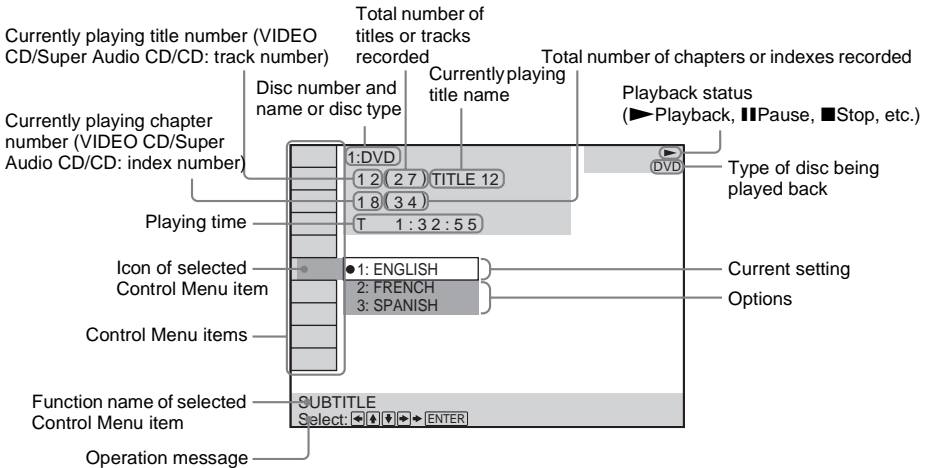



Do not insert an 8 cm (3-inch) CD with an 8 cm (3-inch) adapter. It may damage the system and disc.

Guide to the Control Menu Display







Use the Control Menu to select a function that you would like to use. The Control Menu display appears when the DVD DISPLAY button is pressed. For details, refer to the page in parentheses.



List of Control Menu Items

	DISC	Displays the disc name or the disc type inserted into the system.
	TITLE (DVD only) (page 44)/ SCENE (only VIDEO CD in PBC playback) / TRACK (VIDEO CD only) (page 44)	Selects the title (DVD), or the track (VIDEO CD) to be played. Displays the scene (VIDEO CD in PBC playback).
	CHAPTER (DVD only) (page 45)/ INDEX (VIDEO CD only) (page 45)	Selects the chapter (DVD) or the index (VIDEO CD) to be played.
	ALBUM (MP3 only) (page 35, 44)	Selects the album (MP3) to be played.
	TRACK (Super Audio CD/CD/ MP3 only) (page 35, 44)	Selects the track (Super Audio CD/CD/MP3) to be played.
	INDEX (Super Audio CD/CD only) (page 45)	Displays the index and selects the index (Super Audio CD) to be played.
	TIME (page 46)	Checks the elapsed time and the remaining playback time. Inputs the time code for picture and music searching.
	AUDIO (DVD/VIDEO CD/Super Audio CD/CD/MP3 only) (page 51)	Changes the audio setting.
	SUBTITLE (DVD only) (page 61)	Displays the subtitles. Changes the subtitle language.
	ALBUM (JPEG only) (page 36)	Selects the album (JPEG) to be played.

continued

	FILE (JPEG only) (page 36)	Selects the file (JPEG) to be played.
	DATE (JPEG only) (page 50)	Displays the date information.
	ANGLE (DVD only) (page 60)	Changes the angle.
	PLAYMODE (VIDEO CD/Super Audio CD/CD/MP3/JPEG only) (page 38, 41)	Selects the play mode.
	REPEAT (page 42)	Plays the entire disc (all titles/all tracks), one title/chapter/track/album, or contents of program repeatedly.
	CUSTOM PARENTAL CONTROL (page 62)	Sets the disc to prohibit playing.

Tips

- Each time you press DVD DISPLAY, the Control Menu display changes as follows:

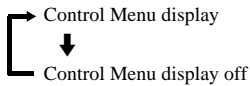

The Control Menu items vary, depending on the disc.

- The Control Menu icon indicator lights up in green  →  unless you set the [REPEAT] setting to [OFF].
- The [ANGLE] indicator lights up in green only when multiple angles are recorded on the disc.

Check that you have the following items:

- Speakers (5)
- Subwoofer (1)
- AM loop antenna (aerial) (1)
- FM wire antenna (aerial) (1)
- Speaker cords (3.5m × 3, 10m × 2) (12ft. × 3, 34ft. × 2)
- Video cord (1)
- Remote Commander (remote) RM-SP350 (1)
- Size AAA (R03) batteries (2)
- Operating Instructions
- Speakers - Connection and Installation (card) (1)

Inserting Batteries into the Remote

You can control the system using the supplied remote. Insert two size AAA (R03) batteries by matching the ⊕ and ⊖ ends on the batteries to the markings inside the compartment. When using the remote, point it at the remote sensor  on the system.

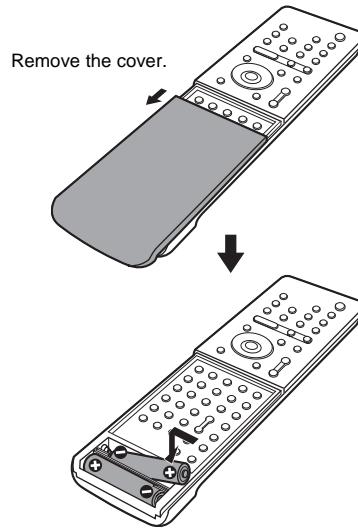

Notes

- Do not leave the remote in an extremely hot or humid place.
- Do not use a new battery with an old one.
- Do not drop any foreign object into the remote casing, particularly when replacing the batteries.
- Do not expose the remote sensor to direct light from the sun or lighting apparatus. Doing so may cause a malfunction.
- If you do not use the remote for an extended period of time, remove the batteries to avoid possible damage from battery leakage and corrosion.

Step 1: Speaker System Hookup

Connect the supplied speaker system using the supplied speaker cords by matching the colors of the jacks to those of the cords. Do not connect any speakers other than those supplied with this system. To obtain the best possible surround sound, specify the speaker parameters (distance, level, etc.) on page 29.

Required cords

Speaker cords

The connector and the color tube of the speaker cords are the same color as the label of the jacks to be connected.



Terminals for connecting the speakers

Connect the	To the
Front speakers	SPEAKER FRONT L (white) and R (red) jacks
Surround speakers	SPEAKER SURR L (blue) and R (gray) jacks
Center speaker	SPEAKER CENTER (green) jack
Subwoofer	SPEAKER WOOFER (purple) jacks

DAV-FR1

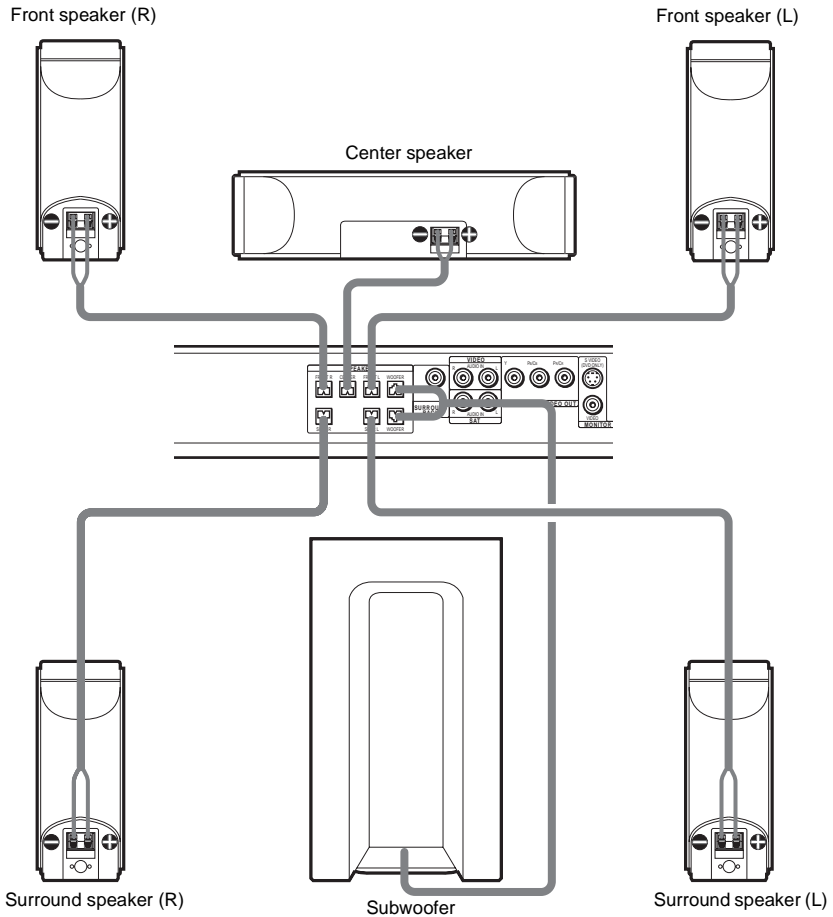

continued

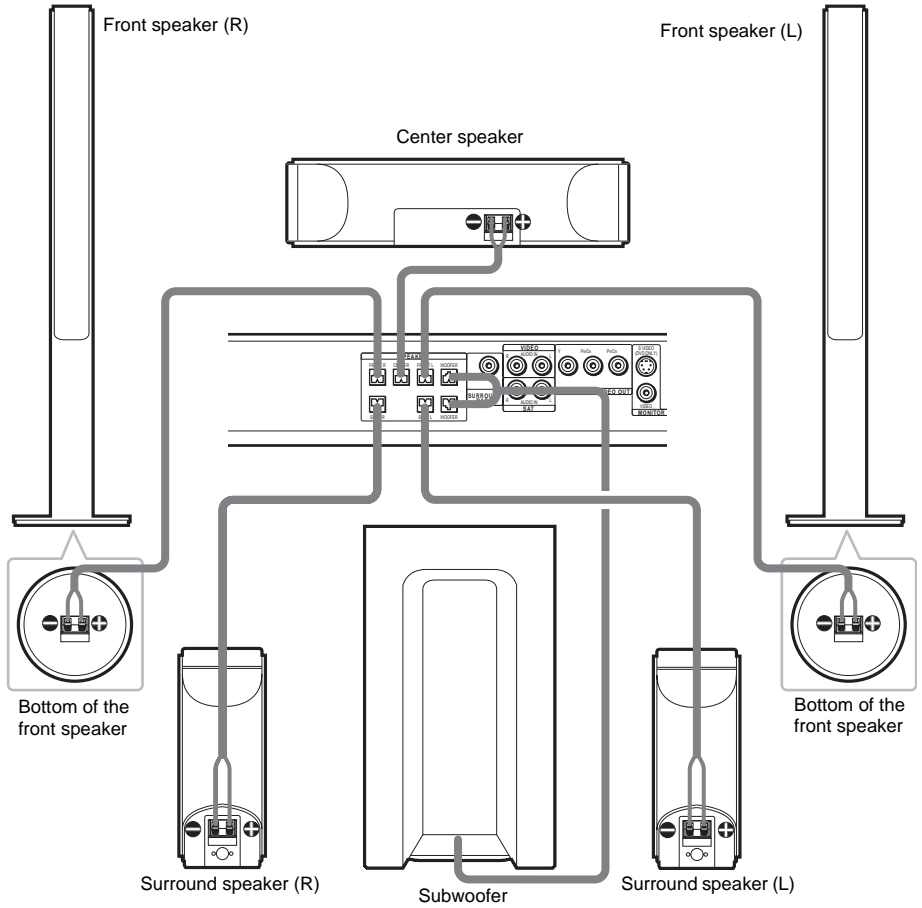

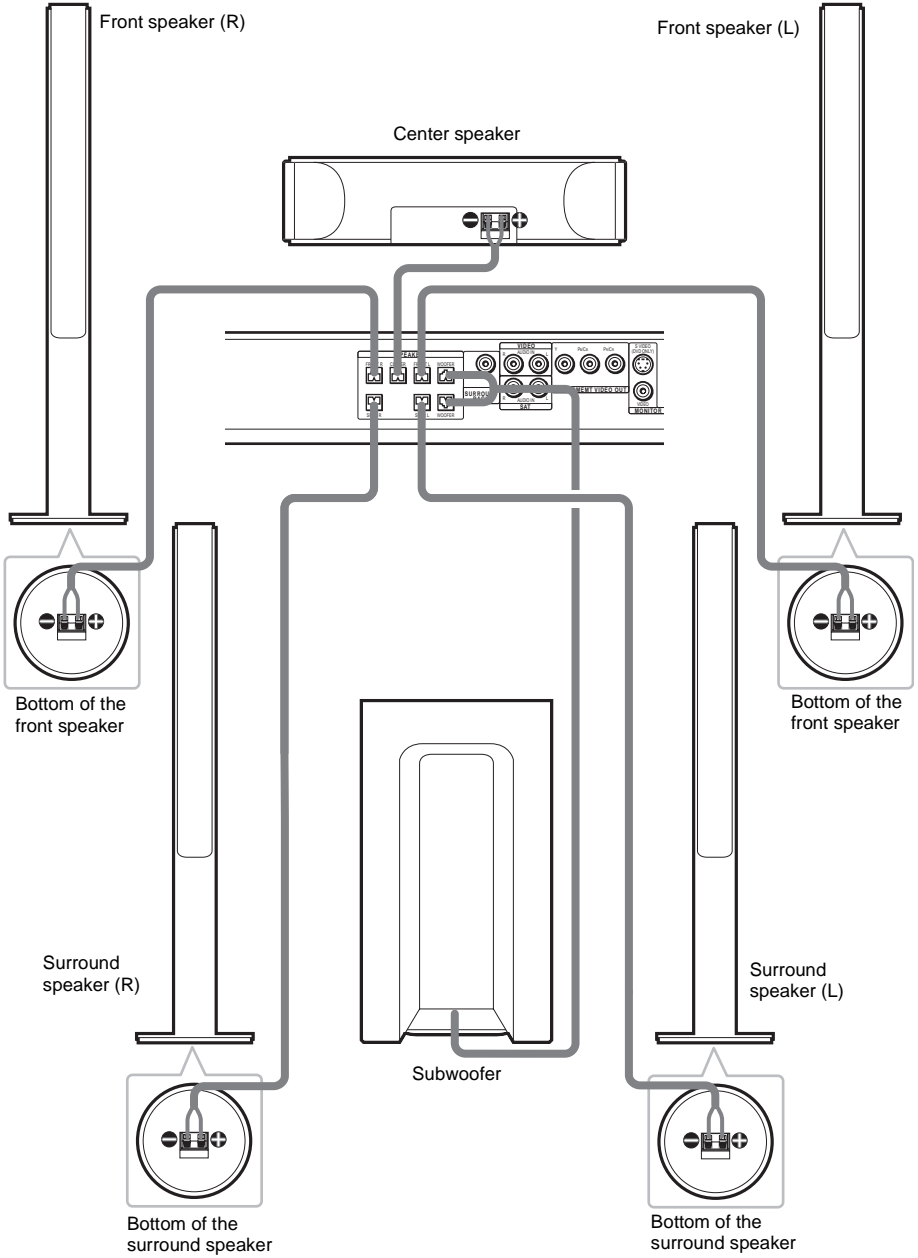

Note on placing speakers

- Do not set the speakers in an inclined position.
- Do not place the speakers in locations that are:
 - Extremely hot or cold
 - Dusty or dirty
 - Very humid
 - Subject to vibrations
 - Subject to direct sunlight
- Use caution when placing the speakers and/or speaker stands (not supplied) that are attached with the speakers on a specially treated (waxed, oiled, polished, etc.) floor, as staining or discoloration may result.
- Do not lean or hang on the speaker, as the speaker may fall down.

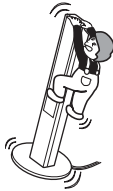

Note

Do not catch the speaker cable insulation in the SPEAKER jack.

Tip

Connect the speaker cable after bending the speaker wire at the end of the insulation. This prevents the speaker cable from being caught in the SPEAKER jack.

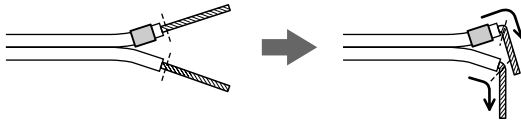

To connect the surround back speaker

This system is compatible with the 6.1 surround system. When you enjoy a DVD that is compatible with the 6.1 surround system such as a DTS-ES disc, connect the surround back speaker (not supplied) and set its parameters (see “Settings for the Speakers” on page 81).

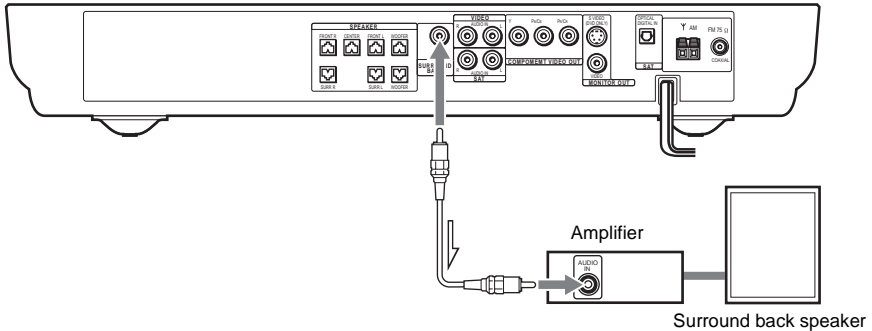

Tip

You can also enjoy the 6.1 surround sound when you play a 2 or 5.1 channel source by using the surround back decoding function (see “Selecting the Surround Back Decoding Mode” on page 57).

To avoid short-circuiting the speakers

Short-circuiting of the speakers may damage the system. To prevent this, be sure to follow these precautions when connecting the speakers. Make sure the bare wire of each speaker cord does not touch another speaker jack or the bare wire of another speaker cord.

Examples of poor conditions of the speaker cord

Stripped speaker cord is touching another speaker terminal.

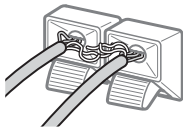

Stripped cords are touching each other due to excessive removal of insulation.

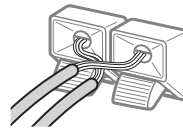

After connecting all the components, speakers, and AC power cord (mains lead), output a test tone to check that all the speakers are connected correctly. For details on outputting a test tone, see page 83. If no sound is heard from a speaker while outputting a test tone, or a test tone is output from a speaker other than the one currently displayed in the front panel display, the speaker may be short-circuited. If this happens, check the speaker connection again.

Notes

- Be sure to match the speaker cord to the appropriate terminal on the components: \oplus to \oplus , and \ominus to \ominus . If the cords are reversed, the sound will lack bass and may be distorted.
- If you connect the speaker cord incorrectly or turn up the volume in a state of a short circuit, “PROTECT” appears in the front panel display and the system enters standby mode. In this case, disconnect and then reconnect the AC power cord (mains lead) from the wall outlet (mains), and then turn the system on.

To change the speaker cables

If you want to use a different speaker cable, you can detach the plug for attachment to another cable.

Detaching

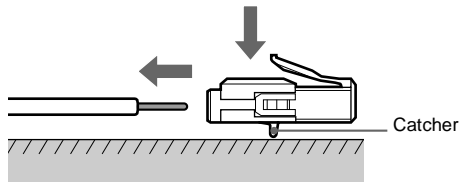

With the catcher facing down, press and hold the plug down against a flat surface and remove the cords from plug.

Attaching

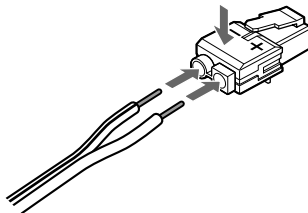

While pressing the plug down against a flat surface, insert the new speaker cords. Note that the cord marked with a line should be attached to the minus (-) side of the plug.

Notes

- Be careful not to damage the surface you use (desk, etc.) when attaching/detaching the speaker cords.
- When using the subwoofer cord, note that the two outside black cords or the cords marked with letters are negative.

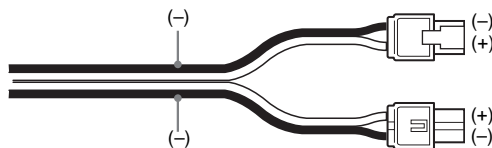

- If you connect the subwoofer cord incorrectly or turn up the volume in a state of a short circuit, “PROTECT” appears in the front panel display and the system enters standby mode. In this case, disconnect and then reconnect the AC power cord (mains lead) from the wall outlet (mains), and then turn the system on.

Tips

- You can use any commercially sold speaker cable of gauge cord AWG #18 - AWG #22.
- Before attaching a new cable, strip off 10 mm (13/32 in.) of its insulation and twist the bare wires of both cords.

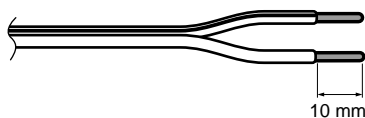

Step 2: Antenna (aerial) Hookups

Connect the supplied AM/FM antennas (aerials) for listening to the radio.

Terminals for connecting the antennas (aerials)

Connect the	To the
AM loop antenna (aerial)	AM terminals
FM wire antenna (aerial)	FM 75Ω COAXIAL jack

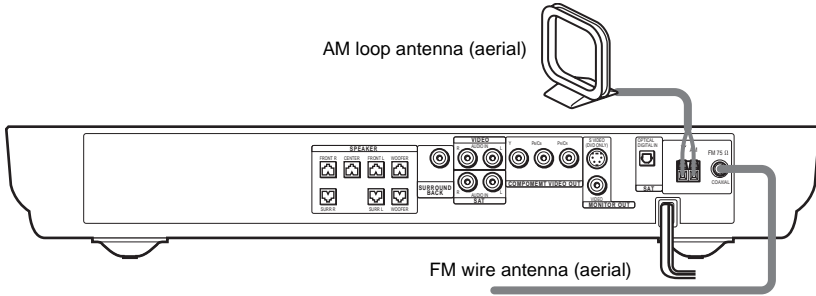

Notes

- To prevent noise pickup, keep the AM loop antenna (aerial) away from the system and other components.
- Be sure to fully extend the FM wire antenna (aerial).
- After connecting the FM wire antenna (aerial), keep it as horizontal as possible.

Tip

When you connect the supplied AM loop antenna (aerial), the cord (A) and the cord (B) can be connected in either terminal.

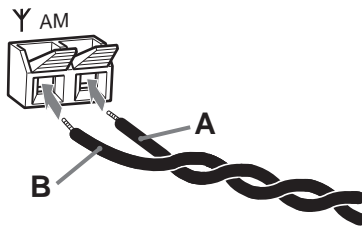

Tip

If you have poor FM reception, use a 75-ohms coaxial cable (not supplied) to connect the system to an outdoor FM antenna (aerial) as shown below.

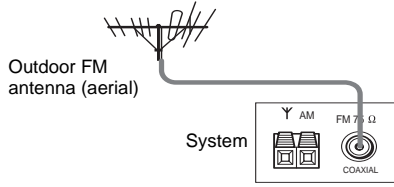

Step 3: TV and Video Component Hookups

Required cords

Video cord for connecting a TV



Yellow

Audio cords (not supplied)

When connecting a cord, be sure to match the color-coded sleeves to the appropriate jacks on the components.

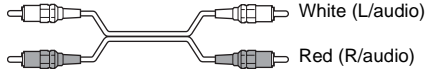

White (L/audio)

Red (R/audio)

Terminals for connecting video components

Connect the	To the
TV (VIDEO IN)	MONITOR OUT (VIDEO) jack
VCR (AUDIO OUT)	VIDEO (AUDIO IN) jacks
Digital satellite receiver (AUDIO OUT)	SAT (AUDIO IN) jacks

Notes

- The video signal is output as below:
 - When [COMPONENT OUT] is set to [INTERLACE] in [SCREEN SETUP] (page 79) (default)
The video signal is output from the S VIDEO and VIDEO jacks of MONITOR OUT.
 - When [COMPONENT OUT] is set to [PROGRESSIVE] in [SCREEN SETUP] (page 79)
The video signal is output from the COMPONENT VIDEO OUT jacks only.
- When you connect a VCR or digital satellite receiver to the VIDEO/SAT jacks of this system, change the function to VIDEO or SAT (page 70).

Tips

- When using the S video jack instead of the video jacks, your TV monitor must also be connected via an S video jack. S video signals are on a separate bus from the video signals and will not be output through the video jacks.
- When using the COMPONENT VIDEO OUT jacks (Y, P_B/C_B, P_R/C_R) instead of the video jacks, your TV monitor must also be connected via COMPONENT VIDEO OUT jacks (Y, P_B/C_B, P_R/C_R). If your TV accepts progressive format signals, you must use this connection and set [COMPONENT OUT] to [PROGRESSIVE] in [SCREEN SETUP] (page 79).

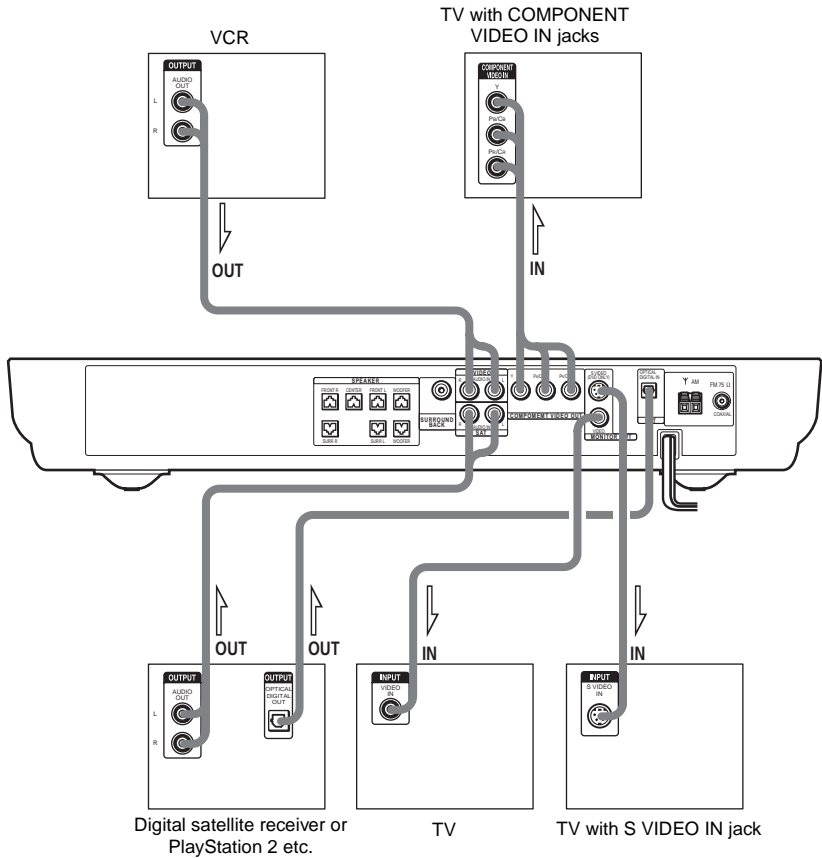

Notes

- Make connections securely to prevent unwanted noise.
- Refer to the instructions supplied with the TV.
- The system cannot output an audio signal to the connected TV. Only the audio signal of the TV is output from the system speakers.

If you connect a digital satellite receiver with an OPTICAL OUT jack

The digital satellite receiver can be connected to the SAT OPTICAL DIGITAL IN jack instead of the SAT AUDIO IN (L/R) jacks of the system.

The system can accept both the digital and analogue signals. Digital signals have priority over analogue signals. If the digital signal ceases, the analogue signal will be processed after 2 seconds.

If you connect a digital satellite receiver without an OPTICAL OUT jack

Connect the digital satellite receiver to the SAT AUDIO IN (L/R) jacks only of the system.

To listen to the game machine (e.g., PlayStation 2) sound by using the system

Connect the audio output jacks of the game machine to the SAT AUDIO IN (L/R) jacks of the system with the audio cords (not supplied).

When connecting to a standard 4:3 screen TV

Depending on the disc, the image may not fit your TV screen.
If you want to change the aspect ratio, please refer to page 78.

Does your TV accept progressive signals?

Progressive is the method for displaying TV images which reduces flickering, and sharpens the image. To display using this method, you need to connect to a TV that accepts progressive signals and set the output signal of COMPONENT VIDEO OUT to the progressive format. For details, see “To set to [PROGRESSIVE]” on page 79.

If your TV does not accept progressive signals and progressive format is set by mistake

The image may not appear, or will appear distorted. In this case, return the setting to interlace format.

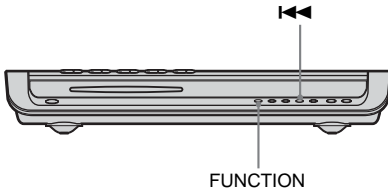

- 1 Press FUNCTION repeatedly until “DVD” appears in the front panel display.
 - 2 While holding down ◀◀, press FUNCTION.
- The output signal is changed to interlace format.

Output the TV or VCR sound from the speakers

1 Connect audio cords.

Connect the AUDIO OUT (L/R) jacks of TV or VCR to the VIDEO jacks (AUDIO IN L/R) of this system with audio cords.

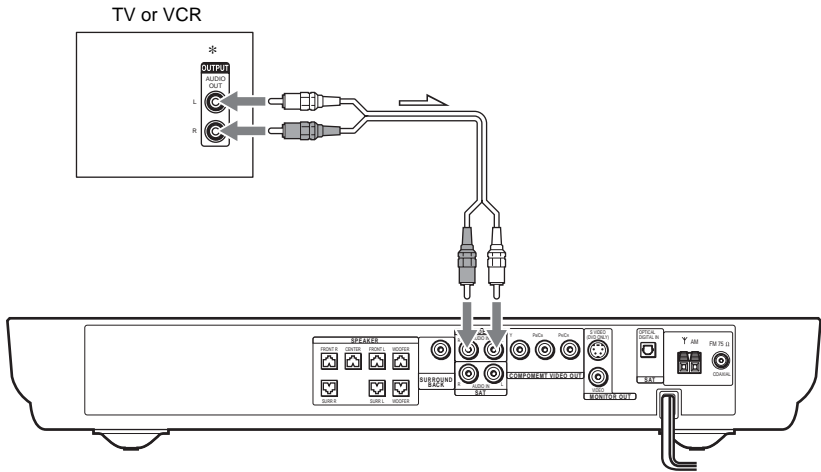

* AUDIO OUT (L/R) jacks

If your TV does not have AUDIO OUT (L/R) jacks, you cannot output the TV sound from the speakers of this system.

2 Change the mode of this system.

Press FUNCTION repeatedly to select “VIDEO.”

Note

Be sure to make the connections securely to avoid hum and noise. If using the VIDEO jack distorts the sound, reconnect the TV or VCR to SAT.

Tip

When you want to output the TV sound or stereo sound of a 2 channel source from the 6 speakers, select any sound field other than “AUTO FORMAT DIRECT AUTO” or “2 CHANNEL STEREO” (page 53).

Step 4: Connecting the AC Power Cord (Mains Lead)

Before connecting the AC power cord (mains lead) of this system to a wall outlet (mains), connect the speakers to the system (see page 15).

Step 5: Performing the Quick Setup

After completing the first 4 steps, make initial settings using the Quick Setup. You can set the initial setting of [LANGUAGE SETUP], [ROOM SIZE], [LISTENING POSITION], and [TV TYPE] step by step.

After performing the Quick Setup, the system is ready for playing back of movies, music CDs, etc. To perform further speakers settings, see “Settings for the Speakers” on page 81.

How to use the Quick Setup

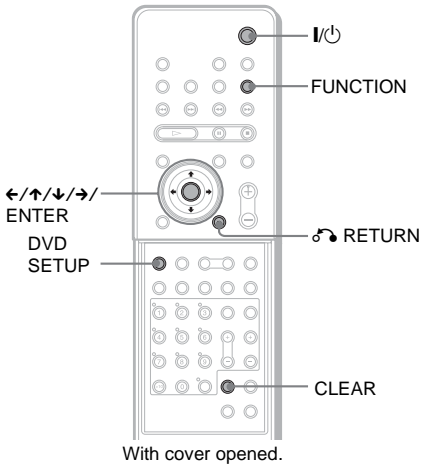

- 1 Turn on your TV.**
- 2 Switch the input selector on the TV to this system.**
- 3 Press I/Power.**
- 4 Press FUNCTION to select “DVD.”**

The guide message appears on the TV screen.

Note

When a disc is in the system, the guide message does not appear on the TV screen.

5 Press ENTER.

[LANGUAGE SETUP] appears.

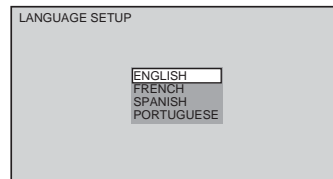

Notes

- The selectable language is different depending on the area.
- The language you select in [LANGUAGE SETUP] is also used for [OSD], [DVD MENU], and [SUBTITLE] (page 78).

6 Select a language using ↑/↓, then press ENTER.

Setting is selected and [ROOM SIZE] appears.

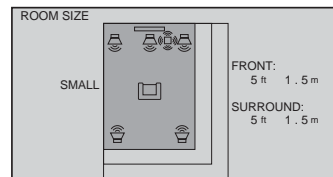

7 Select a suitable room size from [SMALL], [MEDIUM], or [LARGE] using \uparrow/\downarrow , then press ENTER.

Setting is selected and [LISTENING POSITION] appears.

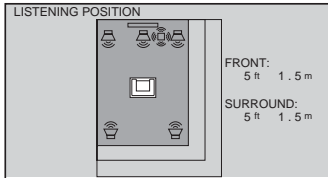

The [LISTENING POSITION] number you can select varies, depending on the [ROOM SIZE] setting.

[SMALL]: Three positions

[MEDIUM]: Four positions

[LARGE]: Five positions

8 Select a suitable listening position using \uparrow/\downarrow , then press ENTER.

Setting is selected and [TV TYPE] appears.

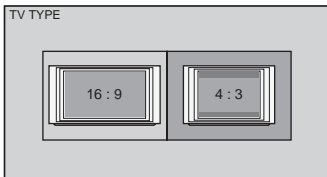

9 Select a TV type connecting to the system using \leftarrow/\rightarrow , then press ENTER.

The Quick Setup is complete.

When the Quick Setup is completed, the settings are saved and the guide message will not appear the next time you turn on the system.

If you make a mistake

Press \rightarrow RETURN, then select the item again.

To quit the Quick Setup

Press DVD SETUP in any Step.

Notes

- When you press CLEAR in guide message, the message disappears. When you need to change settings, select [QUICK] from [SETUP] in Setup Display (page 87).
- When you select [4:3] in [TV TYPE], [4:3 LETTER BOX] is selected (page 78).
- The distance and level of each speaker will be set automatically according to the selection of [ROOM SIZE] and [LISTENING POSITION] (page 81).
- If you want to change each setting, see "Using the Setup Display" on page 77.
- The illustrations displayed for [ROOM SIZE] and [LISTENING POSITION] are only examples and may differ from the actual room size and layout. The settings for [SPEAKER SETUP] (page 81) do not appear on these displays.

Speaker Setup

Positioning the speakers

For the best possible surround sound, all the speakers other than the subwoofer should be the same distance from the listening position (A). However, this system allows you to place the center speaker up to 1.6 meters (5 ft)^a closer (B) and the surround speakers up to 4.6 meters (15 ft)^b closer (C) to the listening position. The front speakers can be placed from 1.0 to 7.0 meters (3 to 23 ft)^c (A) from the listening position.

North American numerical equivalents:

- a) 5 feet (1.5 meters)
- b) 15 feet (4.5 meters)
- c) 3 to 23 feet (0.9 to 6.9 meters)

Place speakers as illustrated below

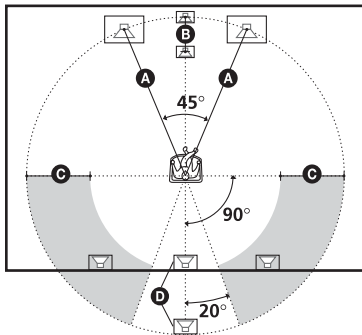

Notes

- Do not place the center and surround speakers farther away from the listening position than the front speakers.
- When you connect an optional surround back speaker, place the surround back speaker behind the listening position (place (D) as illustrated above). In this case, set [SURROUND BACK] to [YES] in the [SIZE] setting (page 81) to output sound from the surround back speaker.

About magnetically shielded speakers (to prevent color irregularity occurring on the TV screen)

The subwoofer in this system is magnetically shielded to prevent magnetic leakage. However, some leakage may occur, as a high-strength magnet is employed. If the subwoofer is used with a CRT-based TV or projector, install the subwoofer at least 0.3 meter (1 ft) from the TV set. If it is installed too close, color irregularity may occur on the screen. If color irregularity occurs, turn off the TV set once, then turn it on after 15 to 30 minutes. If color irregularity occurs again, place the subwoofer farther away from the TV set. If color irregularity still occurs after performing the above, make sure that no magnetic object is placed near the subwoofer. Color irregularity may occur as a result of interaction between the subwoofer and the magnetic object.

Examples of possible sources of magnetic interference include: magnetic latches on a TV stand, etc., healthcare devices, toys, etc.

Specifying the speaker parameters

To obtain the best possible surround sound, first specify the distance of the speakers from your listening position, then set the level and balance. Use the test tone to adjust the speaker level and balance to the same level.

Select [SPEAKER SETUP] in the setup display. For details, see “Settings for the Speakers” (page 81).

Playing Discs

Playing Discs



Depending on the DVD or VIDEO CD, some operations may be different or restricted. Refer to the operation details supplied with your disc.

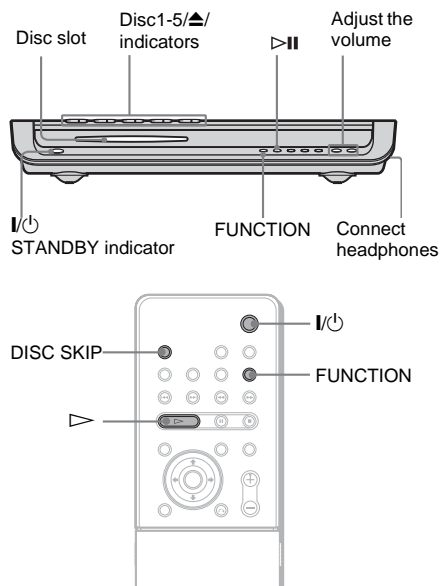

- 1 Turn on your TV.**
- 2 Switch the input selector on the TV to this system.**
- 3 Press I/⏻ on the system.**

The system turns on.

Unless the mode of the system is set to "DVD," press FUNCTION to select "DVD."

"NO DISC" appears in the front panel display and the system is ready for loading the disc.

4 Press DISC1-5 ▲.

Press the ▲ button of the disc number you want.

"NO DISC" appears in the front panel display and the system is ready for loading the disc.

Example: When you want to load the disc to the disc stocker 1, press DISC1 ▲.

If there is a disc in the stocker that you select, the disc is ejected, "NO DISC" appears in the front panel display, then the system is ready for loading the disc.

5 Load a disc.

Push the disc into the disc slot until the disc is pulled in automatically.

The disc is drawn into the system automatically and "READING" appears in the front panel display.

With the playback side facing down

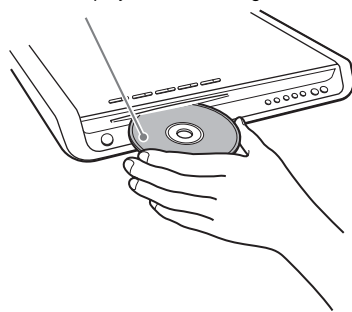

To load other discs, press DISC1-5 ▲ (that is not loaded a disc) and load the disc after "NO DISC" appears in the front panel display.

6 Press ▷ on the remote or ▷|| on the system.

The system starts playback (continuous play) of the disc whose DISC indicator is green.

To play back other discs, press DISC SKIP on the remote or DISC1-5 of the system. Adjust the volume on the system.

After following Step 6

Depending on the disc, a menu may appear on the TV screen. You can play the disc interactively by following the instructions on the menu. (DVD: page 33), (VIDEO CD: page 33).

To remove the disc

Press **DISC1-5 ▲** on the system. Remove the disc after it is ejected from the system. “NO DISC” appears in the front panel display.

To turn on the system

Press **I/⏻** on the system. The system turns on. In standby mode, the system also turns on by loading a disc.

To turn off the system

Press **I/⏻**. The system enters standby mode and the **STANDBY** indicator lights up in red. To turn off the system completely, remove the AC power cord (mains lead) from the wall outlet (mains).

While playing a disc, do not turn off the system by pressing **I/⏻**. Doing so may cancel the menu settings. When you turn off the system, first press **■** to stop playback and then press **I/⏻**.

Tip

The DISC1-5 indicators change their colors as follows:

- green: the disc is chosen, or the disc is being play backed.
- off: there is no disc.
- orange: a disc is loaded to the disc stocker, however, the disc is not chosen.

To save the power in standby mode

Press **I/⏻** while the system turns on (the **STANDBY** indicator on the system lights up).

To cancel standby mode

Press **I/⏻** once.

Additional operations

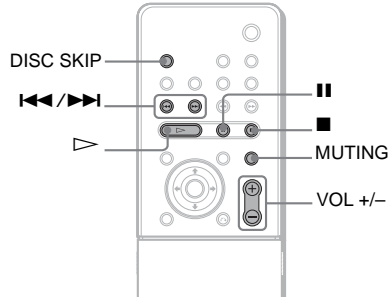

To	Press
Stop	■
Pause*	
Resume play from pause	or ▷
Go to the next chapter, track, scene, or file in continuous play mode	▶▶
Go back to the preceding chapter, track, scene, or file in continuous play mode	◀◀
Mute the sound	MUTING. To cancel muting, press it again or VOL + to adjust the sound volume.
Change a disc while playing another disc	DISC SKIP
Play the desired disc directly	DISC1-5 on the system.
Stop play and remove the desired disc	DISC1-5 ▲ on the system.

* You cannot pause during JPEG playback.

Notes

- If there is no disc in the system, “NO DISC” appears on the front panel display.
- If DVD playback is paused for approximately one hour, the system automatically turns off.

Tip

If a DVD has more than two titles, you cannot go to the next title or go back to the preceding title by pressing **◀◀** or **▶▶**. These buttons work only within a single title. If you want to go to the next title or go back to preceding title, press **DVD TOP MENU** or **DVD MENU** and then select the title you want to go to from the control menu.

Resuming Playback from the Point Where You Stopped the Disc

Tip

To play from the beginning of the disc, press ■ twice, then press ▷.

(Resume Play)



When you stop the disc, the system remembers the point where you pressed ■ and “RESUME” appears in the front panel display. As long as you do not remove the disc, Resume Play will work even if the system enters standby mode by pressing I/⏻.

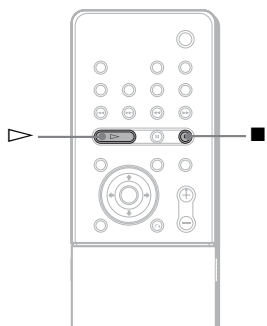

1 While playing a disc, press ■ to stop playback.

“RESUME” appears in the front panel display, so you can restart the disc from the point where you stopped the disc.

If “RESUME” does not appear, Resume Play is not available.

2 Press ▷.

The system starts playback from the point where you stopped the disc in Step 1.

Notes

- You cannot perform Resume Play during Shuffle Play or Program Play.
- Depending on where you stop the disc, the system may not resume playback from exactly the same point.
- The point where you stopped playing is cleared if:
 - you change the play mode.
 - you change the setting on the Setup Menu.

Using the DVD's Menu

DVD

A DVD is divided into a lot of sections, which make up a picture or music feature. These sections are called "titles." When you play a DVD which contains several titles, you can select the title you want using DVD TOP MENU/ALBUM-.

When you play DVDs that allow you to select items such as the language for the subtitles and the language for the sound, select these items using DVD MENU/ALBUM+.

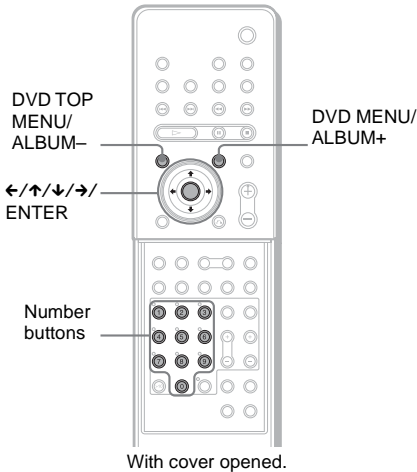

1 Press DVD TOP MENU/ALBUM- or DVD MENU/ALBUM+.

The disc's menu appears on the TV screen. The contents of the menu vary from disc to disc.

2 Press ←/↑/↓/→ or the number buttons to select the item you want to play or change.

3 Press ENTER.

Note

If the DVD top menu or a DVD menu is displayed during DVD playback for approximately one hour, the system automatically turns off.

Playing VIDEO CDs with PBC Functions (Ver. 2.0)

(PBC Playback)

VIDEO CD

With PBC (Playback Control) functions, you can enjoy simple interactive operations, search functions, and other such operations.

PBC playback allows you to play VIDEO CDs interactively by following the menu on the TV screen.

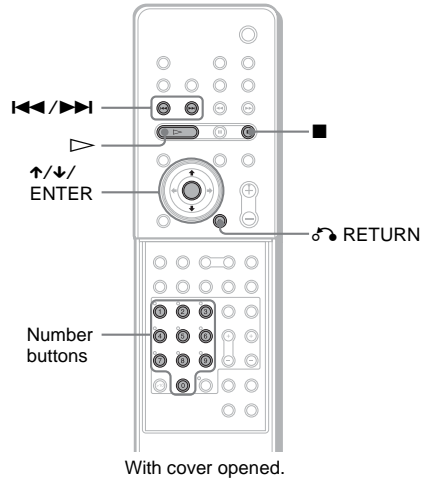

1 Start playing a VIDEO CD with PBC functions.

The menu for your selection appears.

2 Select the item number you want by pressing ↑/↓ or the number buttons.

3 Press ENTER.

4 Follow the instructions in the menu for interactive operations.

Refer to the operation details supplied with the disc, as the operating procedure may differ, depending on the VIDEO CD.

To go back to the menu

Press RETURN.

Notes

- Depending on the VIDEO CD, the menu does not appear in Step 1.
- Depending on the VIDEO CD, “Press ENTER” in Step 3 may appear as “Press SELECT” in the instructions supplied with the disc. In this case, press \triangleright .

Tip

To play without using PBC, press $\blacktriangleleft/\blacktriangleright$ or the number buttons while the system is stopped to select a track, then press \triangleright or ENTER.

“Play without PBC” appears on the TV screen and the system starts continuous play. You cannot play still pictures such as a menu. To return to PBC playback, press \blacksquare twice, then press \triangleright .

Playing an MP3 Audio Track

MP3

You can play MP3 audio tracks on CD-ROMs, CD-Rs, or CD-RWs. However, the discs must be recorded according to ISO9660 level 1, level 2, or Joliet format for the system to recognize the tracks. You can also play discs recorded in Multi Session. See the instructions of the CD-R/RW device or recording software (not supplied) for details on the recording format.

1 Load a data disc recorded in MP3 into the system.

2 Press \triangleright .

The system starts to play the first MP3 audio track in the first album on the disc.

Notes

- The system can play MP3 (MPEG1 Audio Layer3) audio. The system cannot play audio tracks in MP3PRO format.
- This system can play Multi Session CDs when an MP3 audio track is located in the first session. Any subsequent MP3 audio tracks, recorded in the later sessions, can also be played back.
- Maximum number of albums on a disc: 99 (The maximum number of MP3 audio tracks that can be contained on an album is 250.)
- An album that does not include an MP3 audio track is skipped.
- If you put the extension “.MP3” to data not in MP3 format, the system cannot recognize the data properly and will generate a loud noise which could damage your speaker system.
- If the system cannot play MP3, set [DATA CD PRIORITY] to [MP3] in the [CUSTOM SETUP] setting (page 81).
- The system can play to a depth of 8 directories, including a root directory.

Selecting an album and track

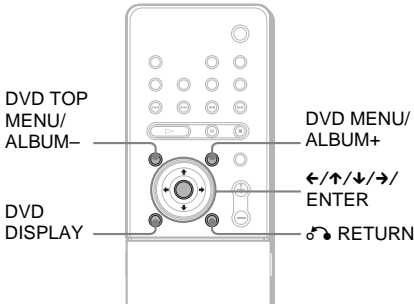

1 Press DVD DISPLAY.

The Control Menu and name of the MP3 data disc appears.

2 Press \uparrow/\downarrow to select (ALBUM) then press ENTER or \rightarrow .

The list of albums contained in the disc appears.

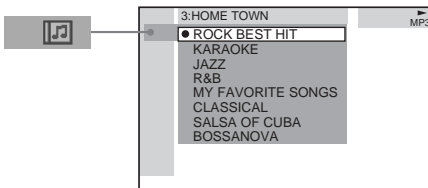

3 Select an album you want to play using \uparrow/\downarrow and press ENTER.

4 Select (TRACK) using \uparrow/\downarrow and press ENTER.

The list of tracks contained in the current album appears.

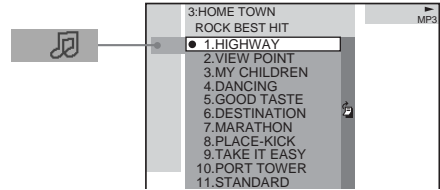

When the list of all tracks or albums cannot be displayed on the window, the jump bar appears. Press \rightarrow to select the jump bar icon, and then scroll the jump bar to display the rest of the list using \uparrow/\downarrow . Press \leftarrow or \curvearrowright RETURN to return to the track or the album list.

5 Select a track using \uparrow/\downarrow and press ENTER.

The selected track starts playing.

To return to the previous display
Press \curvearrowright RETURN or \leftarrow .

To turn off the display
Press DVD DISPLAY.

Notes

- Only alphabetical letters and numbers can be used for album or track names. Anything else is displayed as “ ”.
- If the MP3 file you play back has an ID3 tag, the ID3 tag information is displayed as a track name.
- ID3 tag applies only to version 1.
- If an MP3 file of VBR (variable bit rate) is played, indicated elapsed time may be different from the actual time.
- Until playing the disc or selecting an album in step 2, album name is displayed as “**Album” (** refers to a number) in the Control Menu, after which the album name is displayed.

Tip

When an MP3 data disc is inserted, you can select an album using the DVD MENU/ALBUM+ or DVD TOP MENU/ALBUM- on the remote.

Playing JPEG Image Files

JPEG

You can play JPEG image files on CD-ROMs, CD-Rs, or CD-RWs. However, the discs must be recorded according to ISO9660 level 1, level 2 or Joliet format for the system to recognize the files. You can also play discs recorded in Multi Session. See the instructions of the CD-R/RW device or recording software (not supplied) for details on the recording format.

1 Load a data disc recorded in JPEG into the system.

2 Press \blacktriangleright .

The system starts to play the first JPEG image file in the first album on the disc.

Notes

- The system can play the extension “.JPG” or “.JPEG.”
- The system can play Multi Session CDs.
- An album that does not include a JPEG file is skipped.
- If the system cannot play JPEG, set [DATA CD PRIORITY] to [JPEG] in the [CUSTOM SETUP] setting (page 81).
- A JPEG image file of a length or width of more than 4,720 dots cannot be played.
- A JPEG image file with a high width to length ratio cannot be displayed.
- Some CD-Rs or CD-RWs cannot be played on this system depending on file format.
- The system can play to a depth of 8 directories, including a root directory.
- Progressive JPEG image files cannot be played on this system.
- Maximum number of albums on a disc: 99 (The maximum number of JPEG image files that can be contained on an album is 250.)

Tip

When you go to the next file or to go back to the previous file, press \blacktriangleleft or \blacktriangleright .

Selecting an album and file

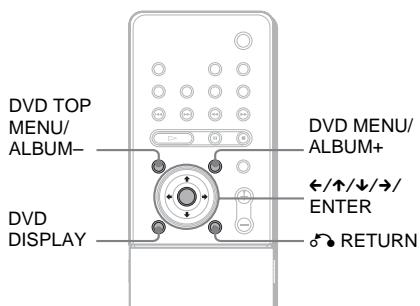

1 Press DVD DISPLAY.

The Control Menu and name of the JPEG data disc appears.

2 Press \uparrow/\downarrow to select  (ALBUM) then press ENTER or \rightarrow .

The list of albums contained in the disc appears.

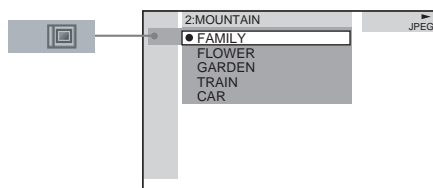

3 Select an album you want to play using \uparrow/\downarrow and press ENTER.

4 Select  (FILE) using \uparrow/\downarrow and press ENTER.

The list of files contained in the current album appears.

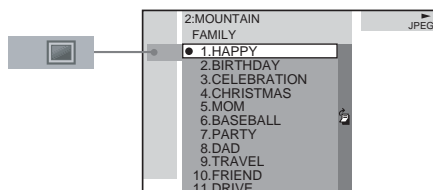

When the list of all files or albums cannot be displayed on the window, the jump bar appears. Press **→** to select the jump bar icon, and then scroll the jump bar to display the rest of the list using **↑/↓**. Press **←** or **↶ RETURN** to return to the file or the album list.

5 Select a file using ↑/↓ and press ENTER.

The selected file starts playing.

To return to the previous display

Press **↶ RETURN** or **←**.

To turn off the display

Press **DVD DISPLAY**.

Notes

- Only alphabetical letters and numbers can be used for album or file names. Anything else is displayed as “ ”.
- Until playing the disc or selecting an album in step 2, album name is displayed as “**Album” (** refers to a number) in the Control Menu, after which the album name is displayed.

Tip

When a JPEG data disc is inserted, you can select an album using the **DVD MENU/ALBUM+** or **DVD TOP MENU/ALBUM-** on the remote.

Enjoying Slide show on a JPEG data disc

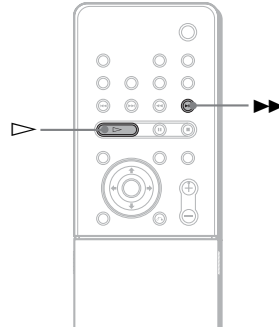

1 Press ►► while displaying a JPEG image.

Slide show starts from the current image.

2 Press ▷ when you want to exit Slide show.

Return to normal play from the current image.

To change the interval time of Slide show

Each time you press **►►** during Slide show, the interval time changes. With each press, the indication changes as follows:

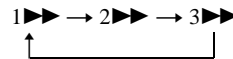

The **3 ►►** interval time is faster than **2 ►►**.

Note

Slide show can play in only one direction.

To rotate the current image

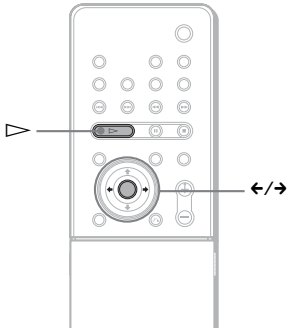

Rotate the current image using ←/→.

Each time you press →, the image turns clockwise by 90°.

Each time you press ←, the image turns anticlockwise by 90°.

Note

You cannot rotate the image during Slide show. Press ▷ to return to normal play before this operation.

Selecting the Play Mode

(All Discs, One Disc, or Album)



You can select the play mode that plays all discs continuously, one disc, or album.

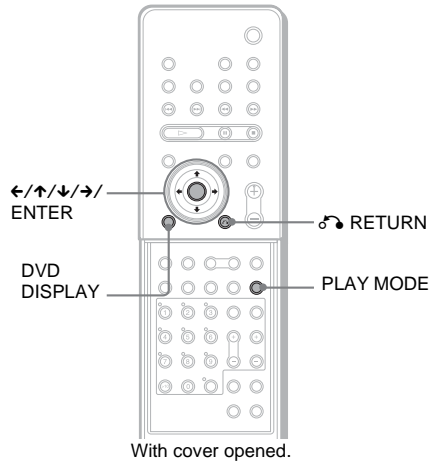

- 1** In stop mode, press DVD DISPLAY.
- 2** Press ↑/↓ to select **PLAY MODE** (PLAY MODE), then press ENTER or →.

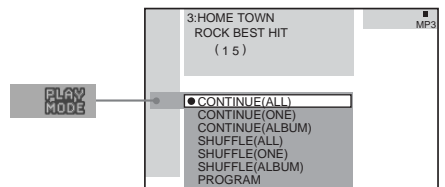

To check the tracks or albums that you have already created once, press **←** to select the jump bar icon, and then scroll the jump bar to display the rest of the list using **↑/↓**. Press **→** or **↶** RETURN to return to the track list.

You can select the jump bar icon only if there are more than 9 programmed tracks or albums.

2 Press **→**, then press **↑/↓** to select the disc.

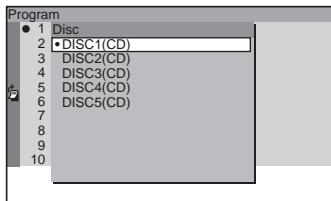

3 Press **→**.

The cursor moves to the track (in this case, “1”). Before programming the MP3 tracks, it is required to select the album.

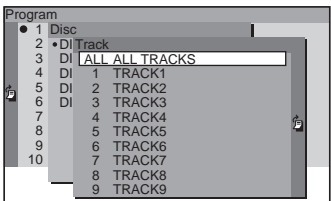

To select a track that is not displayed on the window, press **→** to select the jump bar icon, and then scroll the jump bar to display the rest of the list using **↑/↓**. Press **←** or **↶** RETURN to return to the track list.

You can select the jump bar icon only if there are more than 9 tracks.

4 Select the track you want to program.

For example, select track “7.”

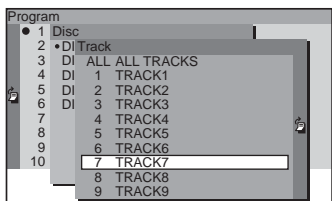

5 Press **↑/↓** or the number buttons to select “7” then press **ENTER**.

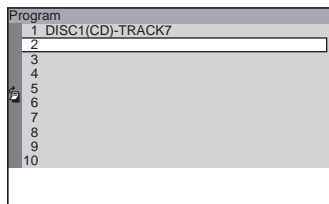

6 To program other tracks, repeat Steps 2 to 5.

The programmed tracks are displayed in the selected order.

7 Press **▷** to start Program Play.

Program Play begins.

When the program ends, you can restart the same program again by pressing **▷**.

To return to normal play

In stop mode, press **PLAY MODE** repeatedly until “ALL DISCS” or “1 DISC” appears in the front panel display.

Other Operations

To	Do this
Turn off the Program Menu	In stop mode, press PLAY MODE to turn off the Program Menu.
Cancel the programmed order	Press CLEAR in Step 5, and the last program is cancelled one by one.

Note

Program Play function is not available for DVDs and JPEG.

Tip

You can perform Repeat Play of programmed tracks. Press **REPEAT**, or set **[REPEAT]** to **[ALL]** in the Control Menu display during Program Play (page 42).

Playing in Random Order

(Shuffle Play)



You can have the system “shuffle” tracks and play them in random order. Subsequent “shuffling” will produce a different playing order.

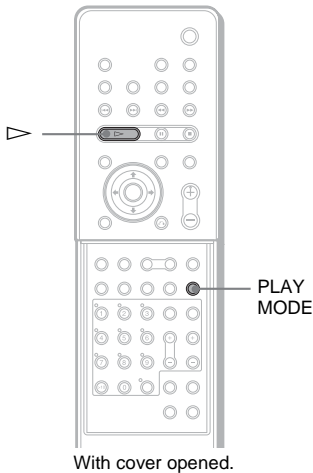

With cover opened.

- 1 In stop mode, press PLAY MODE repeatedly until “SHUF” appears in the front panel display.**

You can play all tracks on all discs in a random order, or all tracks on the specific disc in a random order.

When you play an MP3 disc, you can play all tracks in albums in random order.

For details on album shuffle, see page 41.

- 2 Press ▷.**

To return to normal play

In stop mode, press PLAY MODE repeatedly until “SHUF” disappears from the front panel display (SHUFFLE cancelled). The same applies to cancel SHUFFLE (ALBUM).

Setting the shuffle mode in the Control Menu

You can select either normal shuffle or album shuffle (MP3 only).

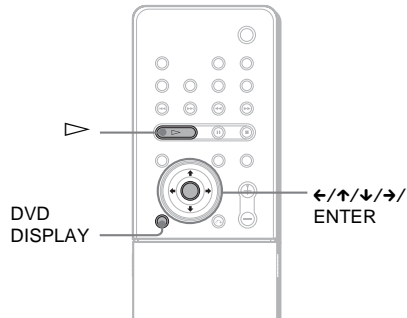

- 1 Press DVD DISPLAY.**
The Control Menu appears.
- 2 Press ↑/↓ to select **PLAY MODE** (PLAY MODE), then press ENTER or →.**

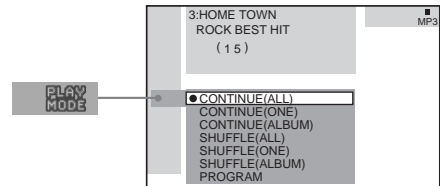

- 3 Select [SHUFFLE (ALL)], [SHUFFLE (ONE)], or [SHUFFLE (ALBUM)] using ↑/↓ and press ENTER.**

[SHUFFLE (ALL)]: Plays all tracks on all discs in random order.

[SHUFFLE (ONE)]: Plays tracks on the disc in random order.

[SHUFFLE (ALBUM)]: Plays tracks from a selected album in random order.

- 4 Press ▷.**

The selected Shuffle Play begins.

Note

While shuffling all discs, you cannot operate DISC SKIP on the remote or DISC1-5 on the system.

Playing Repeatedly

(Repeat Play)



You can play all the titles/tracks/files or a single title/chapter/track on a disc.

In Shuffle or Program Play mode, the system repeats tracks in shuffled or programmed order.

You cannot perform Repeat Play during PBC playback of VIDEO CDs (page 33).

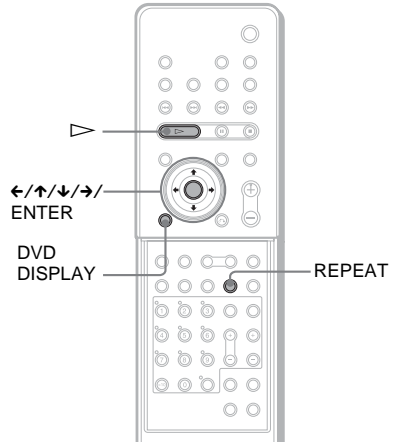

With cover opened.

- 1 Press DVD DISPLAY.**
The Control Menu appears.
- 2 Press \uparrow/\downarrow to select  (REPEAT), then press ENTER or \rightarrow .**
If you do not select [OFF], the [REPEAT] indicator lights in green.
- 3 Select the Repeat Play setting, then press ENTER.**

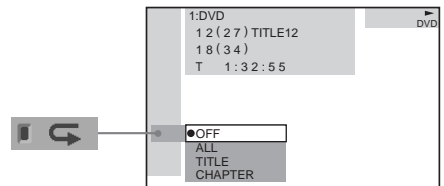

■ **When playing a DVD**

- **OFF**: does not play repeatedly.
- **ALL**: repeats all the titles (except SHUFFLE (ALL)).
- **TITLE**: repeats the current title on a disc.
- **CHAPTER**: repeats the current chapter.

■ **When playing a VIDEO CD/Super Audio CD/CD/MP3, and when Program Play is set to OFF**

- **OFF**: does not play repeatedly.
- **ALL**: repeats all the tracks on the disc, or repeats the current album (only when CONTINUE (ALBUM) or SHUFFLE (ALBUM) in the play mode is selected) (except SHUFFLE (ALL)).
- **TRACK**: repeats the current track.

■ **When playing a JPEG**

- **OFF**: does not play repeatedly.
- **ALL**: repeats all the files on the disc (when CONTINUE is selected in the play mode), or repeats the current album (when CONTINUE (ALBUM) is selected in the play mode).

■ **When Program Play is set to ON**

- **OFF**: does not play repeatedly.
- **ALL**: repeats Program Play.

Notes

- Depending on the DVD disc, Repeat Play does not work.
- If [ALL] is selected, Repeat Play is limited to 5 times.

Tips

- You can set Repeat Play during stop mode. After selecting the [REPEAT] item, press ▷. The system starts Repeat Play.
- You can quickly display the [REPEAT] status. Press REPEAT on the remote.
- You can perform Repeat Play for DVD titles that contain chapters.

Searching for a Particular Point on a Disc

(Scan, Slow-motion Play)



You can locate a particular point on a disc quickly by monitoring the picture or by playing back slowly.

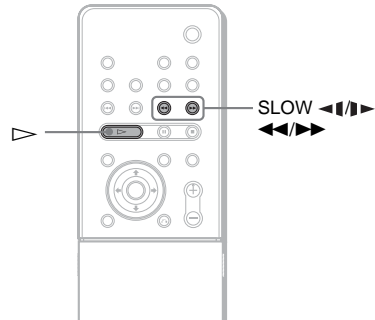

Notes

- Depending on the DVD/VIDEO CD, you may not be able to perform some of the operations described.
- During Scan or Slow-motion Play, no sound is output.

Locating a point quickly by playing a disc in fast forward or fast reverse (Scan)

- 1** Press ◀◀ or ▶▶ while playing a disc.
- 2** When you find the point you want, press ▷ to return to normal speed.

To change the scan speed (DVD/VIDEO CD only)

Each time you press ◀◀ or ▶▶ during scan, the playback speed changes. Two speeds are available. With each press, the indication changes as follows:

Playback direction

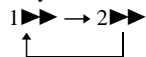

Opposite direction

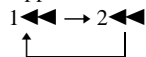

The 2▶▶/2◀◀ playback speed is faster than 1▶▶/1◀◀.

Watching frame by frame (Slow-motion Play) (DVD/VIDEO CD only)

Press ◀◀ or ▶▶ when the system is in the pause mode.

To return to normal speed, press ▷.

To change the speed of Slow-motion Play

Each time you press ◀◀ or ▶▶ during Slow-motion Play, the playback speed changes. Two speeds are available. With each press, the indication changes as follows:

Playback direction

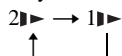

Opposite direction (DVD only)



The 2▶▶/2◀◀ playback speed is slower than 1▶▶/1◀◀.

Searching for a Title/Chapter/Track/Index/Album/File



You can search a title (DVD), chapter (DVD), track (CD, VIDEO CD, Super Audio CD, MP3), index (VIDEO CD, Super Audio CD), album (MP3, JPEG), and file (JPEG). As titles, tracks, albums and files are assigned unique names on the disc, you can select the desired one from the Control Menu. Also chapters and indexes are assigned unique numbers on the disc, so you select the desired one by entering its number. Or you can search a particular point using the time code (TIME SEARCH).

You cannot search a scene of a VIDEO CD (when the PBC function is on).

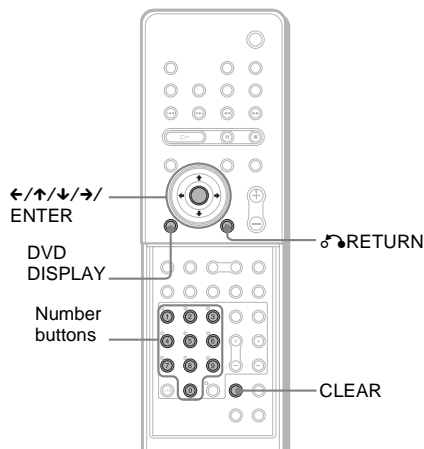

With cover opened.

Searching for a title/track/album/file

- 1 Press DVD DISPLAY.**
The Control Menu appears.
- 2 Press ↑/↓ to select the search method, then press ENTER or →.**

■ When playing a DVD



■ When playing a VIDEO CD



■ When playing a Super Audio CD

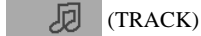

■ When playing a CD



■ When playing an MP3



■ When displaying a JPEG file

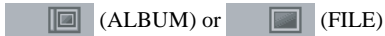

Example: when you select (TRACK)

The list of tracks contained in the disc appears.

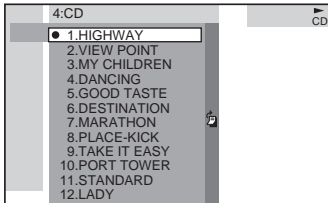

When the list of all tracks or albums cannot be displayed on the window, the jump bar appears. Press **→** to select the jump bar icon, and then scroll the jump bar to display the rest of the list using **↑/↓**. Press **←** or **↶** RETURN to return to the track or the album list.

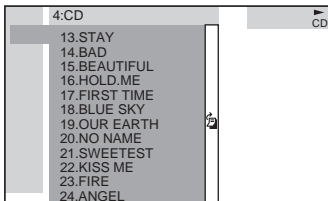

3 Press **↑/↓** to select the desired track, then press **ENTER**.

The system starts playback from the selected track.

Searching for a chapter/index

1 Press **DVD DISPLAY**.

The Control Menu appears.

2 Press **↑/↓** to select the search method.

■ When playing a DVD



■ When playing a VIDEO CD (without PBC functions)



■ When playing a Super Audio CD



Example: when you select (CHAPTER)

“** (**)” is selected (** refers to a number).

The number in parentheses indicates the total number of chapters or indexes.

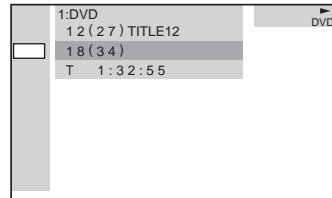

3 Press **ENTER** or **→**.

“** (**)” changes to “-- (**).”

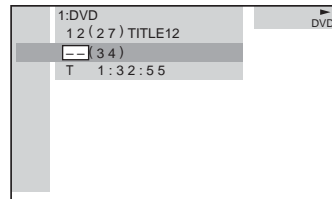

4 Press **↑/↓** or the number buttons to select the chapter or index number you want to search.

If you make a mistake

Cancel the number by pressing **CLEAR**, then select another number.

5 Press ENTER.

The system starts playback from the selected number.

Note

When you play a VIDEO CD with PBC functions, the index search function does not work.

To turn off the Control Menu

Press DVD DISPLAY repeatedly until the Control Menu is turned off.

To search for a particular point using the time code (TIME SEARCH)

Example: If you search for the playing time of the current title on a DVD

- 1 In Step 2, select  (TIME).
“T **: **: **: **: **” (playing time of the current title) is selected.
- 2 Press ENTER or →.
“T-: -: -: -” appears above “T **: **: **: **: **.”
- 3 Input the time code using the number buttons, then press ENTER.
For example, to find a desired point at 2 hours, 10 minutes, and 20 seconds after the beginning, just enter “2:10:20.”

Notes

- The title, chapter or track number displayed is the same number recorded on the disc.
- The time search function does not work on a VIDEO CD (when the PBC function is on).
- If you play a DVD, input the playing time of the current title using the time code. If you play a CD, Super Audio CD, VIDEO CD, or MP3, input the playing time of the current track using the time code.

Tip

You can change the display to show playing time or remaining time. For details, see “Checking the Playing Time and Remaining Time” (page 49).

Viewing Disc Information



Viewing the playing time and remaining time in the front panel display

You can check disc information, such as the remaining time, total number of titles in a DVD, or tracks in a Super Audio CD, CD, VIDEO CD, or MP3, using the front panel display (page 98).

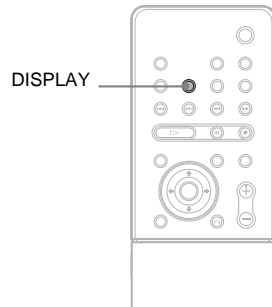

Press DISPLAY.

Each time you press DISPLAY while playing the disc, the display changes as shown in the charts.

When playing back a DVD

Playing time and number of the current title

TITLE	CHAP	
1	2	1.22.30

Remaining time and number of the current title

TITLE	CHAP	
1	2	-1.10.30

Playing time and number of the current chapter

CHAP	
2	0.12.30

Remaining time and number of the current chapter

CHAP	
2	-0.05.30

Title name

SONY

Current sound field

A F. D. AUTO

When playing back a VIDEO CD (without PBC functions), Super Audio CD or CD

Playing time and current track number

TRK	
3	2.30

Remaining time and current track number

TRK	
3	-1.30

Playing time of the disc

12.30

Remaining time of the disc

-31.30

Track name

SONY

Current sound field

A F. D. AUTO

When playing back an MP3

Playing time and current track number

TRK
3 2:30

Remaining time of the
current track

TRK
3 --1:30

Track (file) name

SONY

Album (folder) name

SONY ROCK

Current sound field

A F. D. AUTO

Notes

- Depending on the type of disc being played and the playing mode, the disc information may not be displayed.
- ID3 tag applies only to version 1.
- If the MP3 file you play back has an ID3 tag, the ID3 tag information is displayed as a track (file) name.
- Only alphabetical letters and numbers can be used for album, track, or file names. Anything else is displayed as “ ”.
- In the following case, elapsed playing time and current track remaining time may not be displayed accurately.
 - when an MP3 file of VBR (variable bit rate) is played.

Tips

- When playing VIDEO CDs with PBC functions, only the playing time of the scene is displayed.
- The playing time and remaining time of the current chapter, title, track, scene, or disc will also appear on your TV screen. See the following section “Checking the Playing Time and Remaining Time” for details on how to read this information.

When playing back a JPEG

Current file number

12

File name

SONY

Album (folder) name

SONY ROCK

Current sound field

A F. D. AUTO

Checking the Playing Time and Remaining Time

You can check the playing time and remaining time of the current title, chapter, or track, and the total playing time or remaining time of the disc. You can also check the DVD/CD/Super Audio CD text and MP3 folder name/file name/ID3 tag (only song title) recorded on the disc.

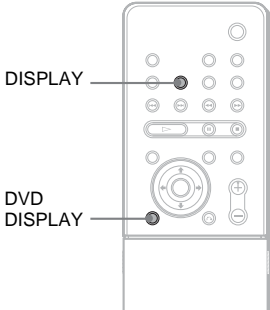

- 1 Press DVD DISPLAY during playback.**
The Control Menu appears.

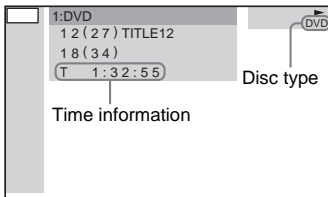

- 2 Press DISPLAY repeatedly to change the time information.**

The display and the kinds of time that you can check depend on the disc you are playing.

■ When playing a DVD

- T **:*:*
Playing time of the current title
- T_**:*:*
Remaining time of the current title
- C **:*:*
Playing time of the current chapter

- C_**:*:*
Remaining time of the current chapter
- **:*:*
Playing time of the menu or current title without a chapter

■ When playing a VIDEO CD (with PBC functions)

- **:*:*
Playing time of the current scene

■ When playing a VIDEO CD (without PBC functions), Super Audio CD or CD

- T **:*:*
Playing time of the current track
- T_**:*:*
Remaining time of the current track
- D **:*:*
Playing time of the current disc
- D_**:*:*
Remaining time of the current disc

■ When playing an MP3

- T **:*:*
Playing time of the current track
- T_**:*:*
Remaining time of the current track

To turn off the Control Menu

Press DVD DISPLAY repeatedly until the Control Menu is turned off.

Notes

- Only alphabetical letters and numbers can be displayed.
- Depending on the type of disc being played, the system can only display a limited number of characters. Also, depending on the disc, not all text characters will be displayed.

Checking the date information (JPEG only)

You can check the date information during playback when the Exif* tag is recorded in the JPEG image data.

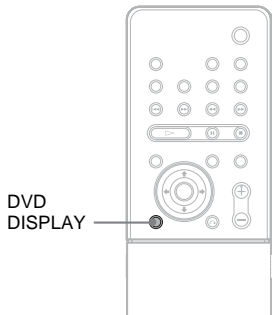

Press DVD DISPLAY during playback.

The Control Menu appears.

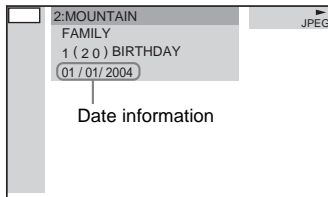

* “Exchangeable Image File Format” is a digital camera image format defined by the Japan Electronics and Information Technology Industries Association (JEITA).

Note

If there is no date information or data is damaged on the disc, the system cannot display the date information.

Tip

You can change the date information order in [JPEG DATE] of [CUSTOM SETUP] (page 81).

Sound Adjustments

Changing the Sound



If a DVD is recorded with multilingual tracks, you can select the language you want while playing the DVD.

If the DVD is recorded in multiple audio formats (PCM, Dolby Digital, MPEG audio, or DTS), you can select the audio format you want while playing the DVD.

With stereo CDs, VIDEO CDs, or MP3, you can select the sound from the right or left channel and listen to the sound of the selected channel through both the right and left speakers (in this case, the sound loses its stereo effect). For example, when playing a disc containing a song with the vocals on the right channel and the instruments on the left channel, you can select the left channel and hear only the instruments from both speakers.

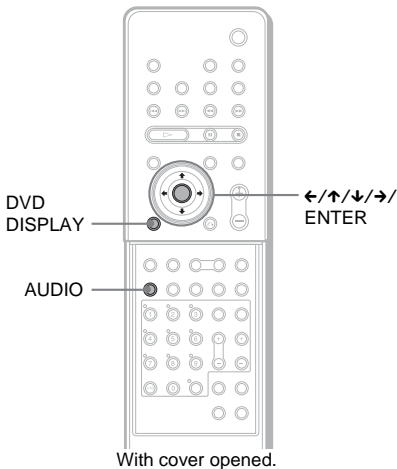

- 1 Press DVD DISPLAY during playback.**
The Control Menu is displayed.

- 2 Press \uparrow/\downarrow to select  (AUDIO), then press ENTER or \rightarrow .**

The options for AUDIO appear.

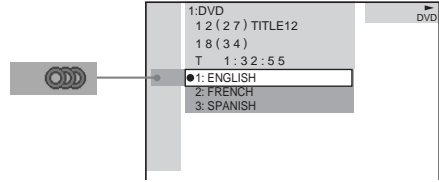

- 3 Press \uparrow/\downarrow to select the desired audio signal.**

■ When playing a DVD

Depending on the DVD, the choice of language varies.

When 4 digits are displayed, they represent the language code. Refer to the language code list on page 102 to see which language the code represents. When the same language is displayed two or more times, the DVD is recorded in multiple audio formats.

■ When playing a VIDEO CD, CD, or MP3

The default setting is underlined.

- STEREO: The standard stereo sound
- 1/L: The sound of the left channel (monaural)
- 2/R: The sound of the right channel (monaural)

■ When playing a Super Audio CD

In stop mode, depending on the Super Audio CD, the choice of settings varies.

- MULTI: The disc has a multi-channel playback area.
- 2CH: The disc has a 2 channel playback area.
- CD: When you want to play the disc as a conventional CD.

Note

Not all discs give you the three choices above when in Super Audio CD playback. It all depends on the layer configuration of the Super Audio CD to be played.

- 4 Press ENTER.**

To turn off the Control Menu

Press DVD DISPLAY repeatedly until the Control Menu is turned off.

Notes

- For discs not in multiple audio format, you cannot change the sound.
- During DVD playback, the sound may change automatically.

Tip

You can select [AUDIO] directly by pressing AUDIO. Each time you press the button, the item changes.

Displaying the audio information of the disc (DVD only)

When you select [AUDIO], the channels being played are displayed on the screen.

For example, in Dolby Digital format, multiple signals ranging from monaural to 5.1 channel signals can be recorded on a DVD. Depending on the DVD, the number of recorded channels may differ.

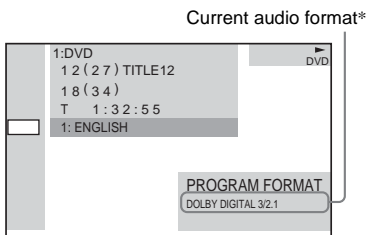

* [PCM], [MPEG], [DTS], or [DOLBY DIGITAL] is displayed.

For [DOLBY DIGITAL], the channels in the playing track are displayed numerically as follows:

For Dolby Digital 5.1 ch:

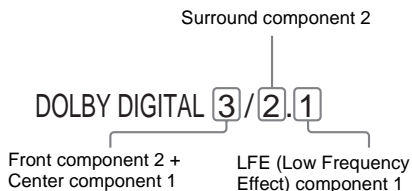

The display examples are as follows:

- PCM (stereo)

PROGRAM FORMAT
PCM 48kHz 24bit

- Dolby Surround

PROGRAM FORMAT
DOLBY DIGITAL 2/0
DOLBY SURROUND

- Dolby Digital 5.1ch

PROGRAM FORMAT
DOLBY DIGITAL 3/2.1

- DTS

PROGRAM FORMAT
DTS 3/2.1

Tips

- When the signal contains surround signal components such as LS, RS, or S, the surround effect is enhanced.
- If you play MPEG AUDIO sound tracks, the system outputs PCM (stereo) signals.
- Even though the audio stream contains a surround back component, the surround back channel is not displayed. Dolby Digital-EX or DTS-ES source is displayed as "3/2.1" on the screen.

Enjoying Surround Sound



You can take advantage of surround sound simply by selecting one of system's pre-programmed sound fields. They bring the exciting and powerful sound of movie theaters into your home.

To select sound field, press **AUTO FORMAT DIRECT** or **MODE** on the remote repeatedly until the sound field you want appears in the front panel display.

Tip

When you want to output the TV sound or stereo sound of a 2 channel source from the 6 speakers of the system, select a sound field other than "AUTO FORMAT DIRECT AUTO" or "2 CHANNEL STEREO".

Automatic decoding of the audio input signal (AUTO FORMAT DIRECT AUTO)

The auto decoding function automatically detects the type of audio signal being input (Dolby Digital, DTS, or standard 2 channel stereo) and performs the proper decoding if necessary. This mode presents the sound as it was recorded/encoded, without adding any effects (e.g. reverberation).

However, if there are no low frequency signals (Dolby Digital LFE, etc.), it will generate a low frequency signal for output to the subwoofer.

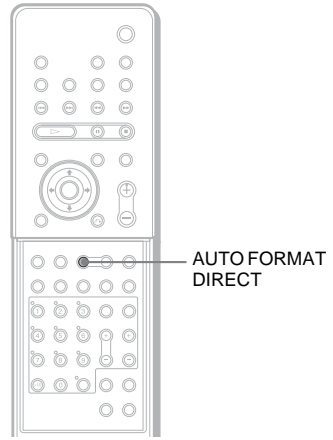

With cover opened.

Press AUTO FORMAT DIRECT repeatedly until "A.F.D. AUTO" appears in the front panel display.

Sound field	Display
AUTO FORMAT DIRECT	A.F.D. AUTO
AUTO	AUTO

Using only the front speaker and subwoofer (2 CHANNEL STEREO)

This mode outputs the sound from the front left and right speakers and subwoofer. Standard two channel (stereo) sources completely bypass the sound field processing. Multi channel surround formats are downmixed to two channels.

This allows you to play any source using only the front left and right speakers and subwoofer.

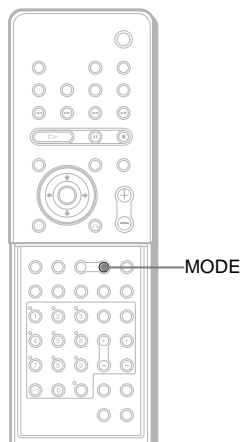

With cover opened.

Press MODE repeatedly until “2CH STEREO” appears in the front panel display.

Sound field	Display
2 CHANNEL STEREO	2CH STEREO

Selecting a sound field (AUTO FORMAT DIRECT button)

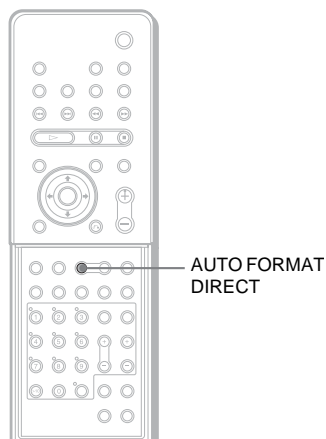

With cover opened.

Press AUTO FORMAT DIRECT repeatedly until the sound field you want appears in the front panel display.

Sound field	Display
AUTO FORMAT DIRECT PRO LOGIC	DOLBY PL
AUTO FORMAT DIRECT PRO LOGIC II MOVIE	PLII MOVIE
AUTO FORMAT DIRECT PRO LOGIC II MUSIC	PLII MUSIC
Neo:6 CINEMA	NEO:6 CIN
Neo:6 MUSIC	NEO:6 MUS

■ AUTO FORMAT DIRECT PRO LOGIC

Dolby Pro Logic produces five output channels from two-channel sources. This mode performs Pro Logic decoding to the input signal and output to front, center, and surround speakers. Meanwhile, the surround channel becomes monaural.

■ AUTO FORMAT DIRECT PRO LOGIC II MOVIE/MUSIC

Dolby Pro Logic II produces five full-bandwidth output channels from two-channel sources. This is done using an advanced, high-purity matrix surround decoder that extracts the spatial properties of the original recording without adding any new sounds or tonal colorations.

■ Neo:6 CINEMA

Performs the DTS Neo:6 Cinema mode decoding.

■ Neo:6 MUSIC

Performs the DTS Neo:6 Music mode decoding. This setting is ideal for standard stereo sources, such as CDs.

Notes

- When the input signal is a multi-channel source, PRO LOGIC, PRO LOGIC II MOVIE/MUSIC, and Neo:6 Cinema/Music are cancelled and the multi channel source is output directly.
- Neo:6 Cinema/Music mode decoding is not available for DTS 2channel signal.
- This system is not compatible with the DTS 96/24 decoding function. When you play the DTS 96/24 disc, the system plays it as a normal disc.

Selecting a sound field (MODE button)

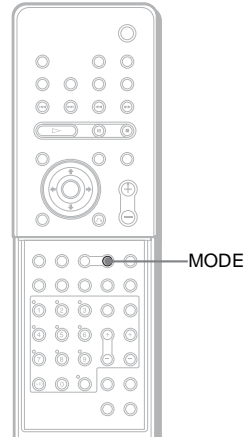

With cover opened.

Press MODE repeatedly until the sound field you want appears in the front panel display.

For movie

Sound field	Display
CINEMA STUDIO EX A	C. ST. EX A*
CINEMA STUDIO EX B	C. ST. EX B*
CINEMA STUDIO EX C	C. ST. EX C*

*Use DCS Technology

About DCS (Digital Cinema Sound)

In collaboration with Sony Pictures Entertainment, Sony measured the sound environment of their studios and integrated the data of the measurement and Sony's own DSP (Digital Signal Processor) technology to develop "Digital Cinema Sound." "Digital Cinema Sound" simulates in a home theater an ideal movie theater sound environment based on the preference of the movie director.

■ C. ST. EX A (Cinema Studio EX A)

Reproduces the sound characteristics of the Sony Pictures Entertainment "Cary Grant Theater" cinema production studio. This is a standard mode, great for watching most any type of movie.

continued

■ C. ST. EX B (Cinema Studio EX B)

Reproduces the sound characteristics of the Sony Pictures Entertainment “Kim Novak Theater” cinema production studio. This mode is ideal for watching science-fiction or action movies with lots of sound effects.

■ C. ST. EX C (Cinema Studio EX C)

Reproduces the sound characteristics of the Sony Pictures Entertainment scoring stage. This mode is ideal for watching musicals or classic films where music is featured in the soundtrack.

About Cinema Studio EX

Cinema Studio EX is ideal for enjoying the movie software encoded with multi channel format, such as the Dolby Digital DVD. This mode reproduces the sound characteristics of Sony Pictures Entertainment’s studios. Cinema Studio EX consists of the following three elements.

- Virtual Multi Dimension
Creates 5 sets of virtual speakers surrounding the listener from a single pair of actual surround speakers.
- Screen Depth Matching
In a movie theater, sound seems to come from inside the image reflected on the movie screen. This element creates the same sensation in your listening room by shifting the sound of the front speakers “into” the screen.
- Cinema Studio Reverberation
Reproduces the reverberations peculiar to a movie theater. Cinema Studio EX is the integrated mode which operates these elements simultaneously.

Notes

- The virtual speaker effect may cause increased noise in the playback signal.
- When listening with sound fields that employ virtual speakers, you will not be able to hear any sound coming directly from the surround speakers.

For music or others

Sound field	Display
HALL	HALL
JAZZ CLUB	JAZZ CLUB
LIVE CONCERT	L. CONCERT
GAME	GAME
SPORTS	SPORTS
MONO MOVIE	MONO MOVIE

■ HALL (Hall)

Reproduces the acoustics of a rectangular concert hall.

■ JAZZ CLUB (Jazz club)

Reproduces the acoustics of a jazz club.

■ L. CONCERT (Live concert)

Reproduces the acoustics of a 300-seat live concert.

■ GAME (Game)

Obtains maximum audio impact from video game software.

■ SPORTS (Sports)

Simulates the arena or stadium sound.

■ MONO MOVIE (Mono movie)

Reproduces mono sound that is good for old movies.

When using headphones

Sound field	Display
HEADPHONE 2CH	HP 2CH
HEADPHONE THEATER	HP THEATER

■ HEADPHONE 2CH

This mode outputs the sound from the headphone L/R. Standard 2 channel (stereo) sources completely bypass the sound field processing. Multi channel surround formats are downmixed to two channels.

■ HEADPHONE THEATER

This mode outputs the sound as surround from headphone L/R.

To turn the surround effect off
Press **AUTO FORMAT DIRECT** repeatedly
until “A.F.D. AUTO” appears in the front panel
display.

When connecting the headphones to the PHONES jack



Press **AUTO FORMAT DIRECT** or **MODE**
repeatedly until “HP 2CH” appears in the front
panel display.

Notes

- This function is unavailable when playing Super Audio CDs and when the input stream is dts 2048 frame.
- When you play a Super Audio CD (Direct Stream Digital), the sound field changes to “AUTO FORMAT DIRECT AUTO” automatically.
- This system is not compatible with the DTS 96/24 decoding function. When you play the DTS 96/24 disc, the system plays it as a normal disc.

Tips

- When you want to output the TV sound or stereo sound of a 2 channel source from the 6 or 7 speakers, select any sound field other than “AUTO FORMAT DIRECT AUTO” or “2CH STEREO.”
- The system memorizes the last sound field selected for each function mode.
Whenever you select a function such as DVD or TUNER, the sound field that was last applied to function is automatically applied again. For example, if you listen to DVD with HALL as the sound field, then change to another function, and then return to DVD, HALL will be applied again. With the tuner, sound fields are memorized separately for all preset stations.

- You can identify the encoding format of program software by looking at its packaging.
 - Dolby Digital discs are labeled with the  logo.
 - DTS-ES encoded programs are marked with DTS-ES.
 - Dolby Surround encoded programs are labeled with the  logo.
 - DTS Digital Surround discs are marked with DTS.

Selecting the Surround Back Decoding Mode

DVD

This function lets you select the decoding mode for the surround back signals of the multi channel input stream.

By decoding the surround back signal of DVD software, etc., recorded in Dolby Digital EX, DTS-ES Matrix, DTS-ES Discrete 6.1 format, etc., you can enjoy the kind of surround sound originally intended for the film (page 93, 94).

Note

This function works only when you connect the surround back speaker to the system (page 19) and set [SURROUND BACK] to [YES] in the [SIZE] setting (page 81).

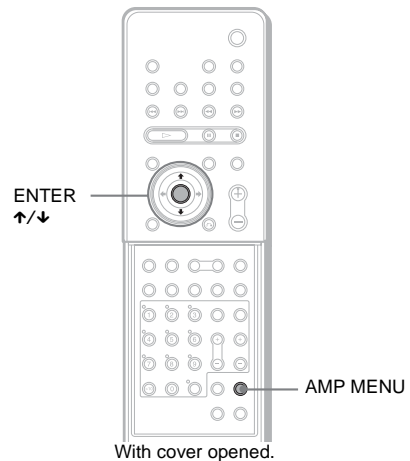

- 1 Press **AMP MENU**.
- 2 Press **↑/↓** repeatedly until “CUSTOMIZE” appears in the front panel display, then press **ENTER**.
- 3 Press **↑/↓** repeatedly until “SB DEC” appears in the front panel display, then press **ENTER**.

continued

4 Press \uparrow/\downarrow to select the surround back mode you want according to the input stream, then press ENTER or AMP MENU.

The default setting is “SB MATRIX.”

When selecting “SB MATRIX”

Dolby Digital EX or DTS-ES is applied to decode the surround back signal regardless of the 6.1 channel decode flag^{a)} in the input stream. This decoder conforms to Dolby Digital EX or DTS-ES.

Input stream	Output channel	Applied surround back decoder
Dolby Digital 5.1	6.1	Matrix decoder conforms to Dolby Digital EX
DTS 5.1	6.1	DTS Matrix decoder
Dolby Digital EX ^{b)}	6.1	Matrix decoder conforms to Dolby Digital EX
DTS-ES Matrix 6.1 ^{c)}	6.1	DTS Matrix decoder
DTS-ES Discrete 6.1 ^{d)}	6.1	DTS Discrete decoder

When selecting “SB AUTO”

When you input stream contains the 6.1 channel decoding flag^{a)}, the appropriate decoder is applied to decode the surround back signal.

Input stream	Output channel	Applied surround back decoder
Dolby Digital 5.1	5.1	—
DTS 5.1	5.1	—
Dolby Digital EX ^{b)}	6.1	Matrix decoder conforms to Dolby Digital EX
DTS-ES Matrix 6.1 ^{c)}	6.1	DTS Matrix decoder
DTS-ES Discrete 6.1 ^{d)}	6.1	DTS Discrete decoder

When selecting “SB OFF”

Surround back decoding is not performed.

- a) 6.1 channel decode flag is information recorded in software like DVD.
- b) Dolby Digital DVD that includes a Surround EX flag. Check the Dolby Corporation web page help for information about Surround EX films.
- c) Software encoded with a flag to denote it has both Surround EX and 5.1 channel signals.
- d) Software encoded with both 5.1 channel signals and an extension stream designed for returning those signals to 6.1 discrete channels. Discrete 6.1 channel signals are DVD specific signals, not used in movie theaters.

Notes

- You can select the surround back decoding only when AUTO FORMAT DIRECT AUTO mode is selected (page 53). In other sound fields, this function is bypassed internally.
- Some discs have no Dolby Digital EX flag, even though their packaging may contain a Dolby Digital Surround EX logo. In this case, select “SB MATRIX.”

Using the Sound Effect

DVD

VIDEO
CD

SA-CD
CD

MP3

This system provides you with 2 types of sound effect, simply by pressing a button. Choose the sound to suit your needs.

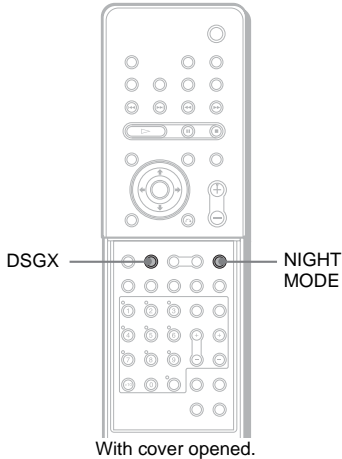

Press NIGHT MODE or DSGX on the remote.

The sound effect is activated.

■ NIGHT MODE

In this mode, you can enjoy sound effects or dialogue, as you would in a movie theater, even at low volume. It is useful for watching movies at night.

■ DSGX

With DSGX on, bass frequencies are effectively reinforced.

To turn off the sound effect

Press NIGHT MODE or DSGX again.

Notes

- The NIGHT MODE function is activated only when the input stream is Dolby Digital format.
- When you connect headphones to the system, the DSGX function does not work.
- These two types of sound effect cannot be activated at the same time.
- Depending on the input stream, the DSGX function may not be effective.

Using Various Additional Functions

Changing the Angles

DVD

If various angles (multi-angles) for a scene are recorded on a DVD, you can change the viewing angle.

For example, while playing a scene of a train in motion, you can display the view from either the front of the train, the left window of the train, or from the right window without having the train's movement interrupted.

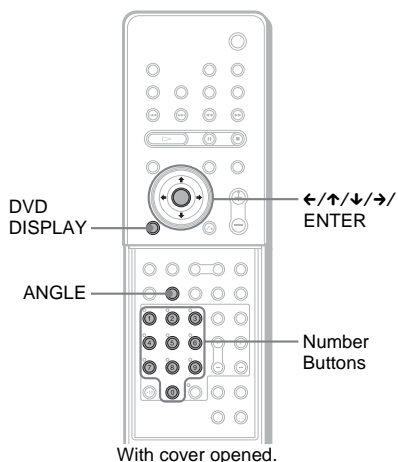

1 Press DVD DISPLAY during playback.

The Control Menu appears.

2 Press \uparrow/\downarrow to select (ANGLE).

The angle number appears.

The number in parentheses indicates the total number of angles. The [ANGLE] indicator lights up in green when angles are recorded on the disc.

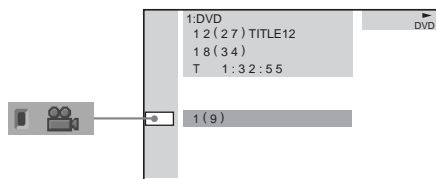

3 Press ENTER or \rightarrow .

The angle number changes to “-.”

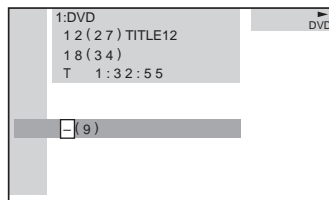

4 Select the angle number using the number buttons or \uparrow/\downarrow , then press ENTER.

The angle is changed to the selected angle.

To turn off the Control Menu

Press DVD DISPLAY repeatedly until the Control Menu is turned off.

Note

Depending on the DVD, you may not be able to change the angles, even if multi-angles are recorded on the DVD.

Tip

You can select the angle directly by pressing ANGLE. Each time you press the button, the angle changes.

Displaying Subtitles

DVD

If subtitles are recorded on a disc, you can turn the subtitles on or off while playing. If multilingual subtitles are recorded on the disc, you can change the subtitle language while playing, or turn the subtitles on or off whenever you want. You can select the language you want to practice, for example, turn on the subtitles for better understanding.

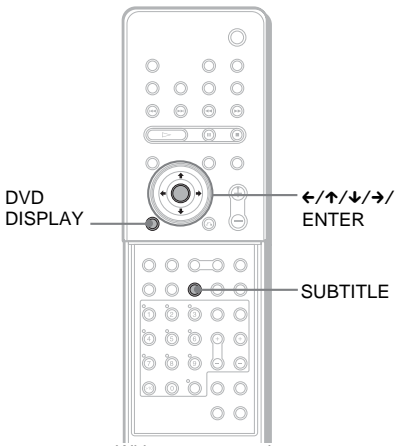

With cover opened.

1 Press DVD DISPLAY during playback.

The Control Menu appears.

2 Press ↑/↓ to select (SUBTITLE), then press ENTER or →.

The options for [SUBTITLE] appear.

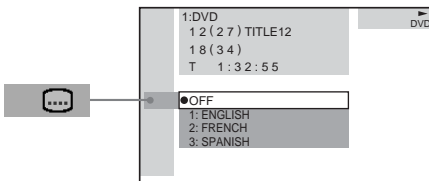

3 Press ↑/↓ to select the language.

Depending on the DVD, the choice of language varies.

When 4 digits are displayed, they indicate the language code. Refer to the language code list on page 102 to see which language the code represents.

4 Press ENTER.

To cancel the [SUBTITLE] setting
Select [OFF] in Step 3.

To turn off the Control Menu

Press DVD DISPLAY repeatedly until the Control Menu is turned off.

Note

Depending on the DVD, you may not be able to change the subtitles, even if multilingual subtitles are recorded on it.

Tip

You can select subtitles directly by pressing SUBTITLE. Each time you press the button, the language changes.

Locking Discs

(CUSTOM PARENTAL CONTROL, PARENTAL CONTROL)



You can set two kinds of playback restrictions for a disc.

- Custom Parental Control

You can set the playback restrictions so that the system will not play inappropriate discs.

- Parental Control

Playback of some DVDs can be limited according to a predetermined level, such as the age of the viewer.

The same password is used for both Parental Control and Custom Parental Control.

Custom Parental Control

You can set the same Custom Parental Control password for up to 25 discs. If you set a 26th disc, the playback restriction of the disc for which you first set the password is cancelled.

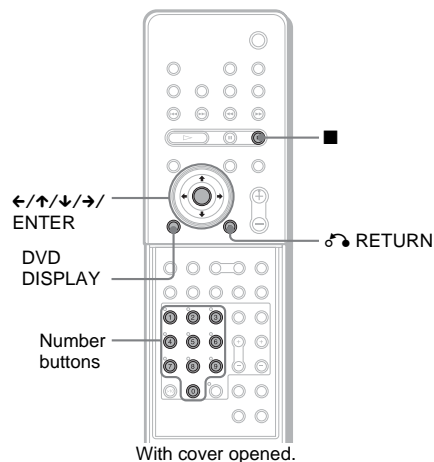

1 Insert the disc you want to lock.

If the disc is playing, press ■ to stop playback.

2 In stop mode, press DVD DISPLAY.

The Control Menu appears.

3 Press \uparrow/\downarrow to select (CUSTOM PARENTAL CONTROL), then press ENTER or \rightarrow .

[CUSTOM PARENTAL CONTROL] is selected.

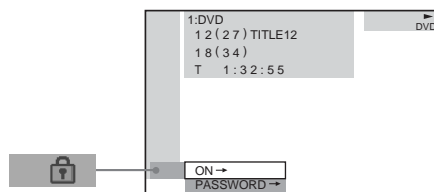

4 Press \uparrow/\downarrow to select [ON \rightarrow], then press ENTER.

■ If you have not entered a password yet

The display for registering a new password appears.

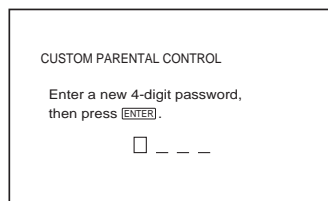

Enter a 4-digit password by using the number buttons, then press ENTER.

The display for confirming the password appears.

■ If you have already registered a password

The display for entering the password appears.

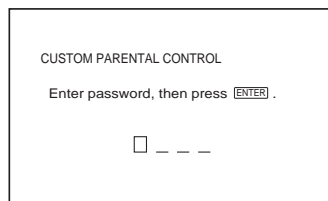

5 Enter your 4-digit password by using the number buttons, then press ENTER.

[Custom parental control is set.] appears and the screen returns to the Control Menu display.

If you make a mistake entering your password

Press **←** before you press ENTER and input the correct number.

If you make a mistake

Press **↶** RETURN, then start from Step 3 again.

To turn off the Control Menu

Press DVD DISPLAY repeatedly until the Control Menu is turned off.

To turn off the Custom Parental Control function

1 In Step 4, select [OFF →], then press ENTER.

2 Enter your 4-digit password using the number buttons, then press ENTER.

To change the password

1 In Step 4, press **↑/↓** to select [PASSWORD →], then press ENTER.

The display for entering the password appears.

2 Enter your 4-digit password using the number buttons, then press ENTER.

3 Enter a new 4-digit password using the number buttons, then press ENTER.

4 To confirm your password, re-enter it using the number buttons, then press ENTER.

Playing the disc for which Custom Parental Control is set

1 Insert the disc for which Custom Parental Control is set.

The [CUSTOM PARENTAL CONTROL] display appears.

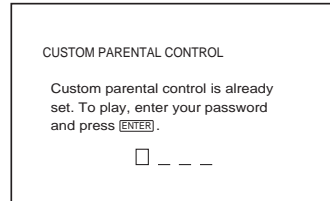

2 Enter your 4-digit password using the number buttons, then press ENTER.

The system is ready for playback.

Notes

- When you change the layer or area in a Super Audio CD which has Custom Parental Control set, the display for entering the password may appear.
- When you set the Custom Parental Control password for a Hybrid Super Audio CD, the Custom Parental Control setting only works for the current layer.

Tip

If you forget your password, enter the 6-digit number “199703” using the number buttons when the [CUSTOM PARENTAL CONTROL] display asks you for your password, then press ENTER. The display will ask you to enter a new 4-digit password.

Limiting playback for children (Parental Control) (DVD only)

Playback of some DVDs can be limited according to a predetermined level, such as the age of the viewer. The “Parental Control” function allows you to set a playback limitation level.

A scene that is limited is not played, or it is replaced by a different scene.

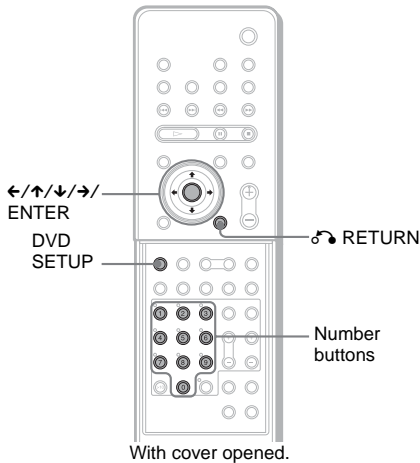

- 1 In stop mode, press DVD SETUP.**
The Setup Display appears.
- 2 Press ↑/↓ to select [CUSTOM SETUP], then press ENTER or →.**
[CUSTOM SETUP] is displayed.

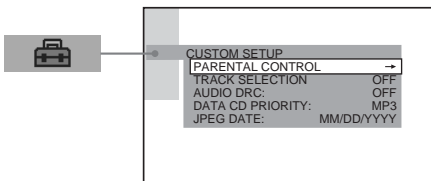

- 3 Press ↑/↓ to select [PARENTAL CONTROL →], then press ENTER or →.**

■ **If you have not entered a password**
The display for registering a new password appears.

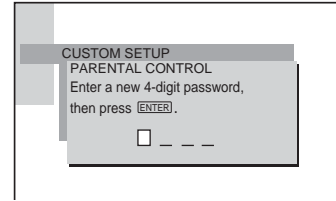

Enter a 4-digit password using the number buttons, then press ENTER.

The display for confirming the password appears.

■ **When you have already registered a password**

The display for entering the password appears.

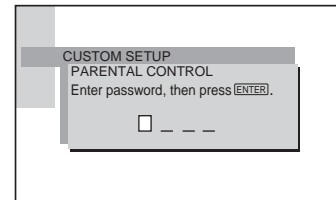

- 4 Enter your password using the number buttons, then press ENTER.**

The display for setting the playback limitation level and changing the password appears.

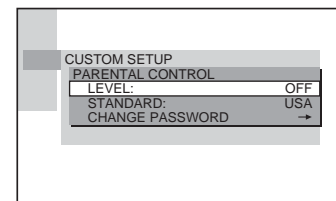

5 Press \uparrow/\downarrow to select [STANDARD], then press ENTER or \rightarrow .

The selection items for [STANDARD] are displayed.

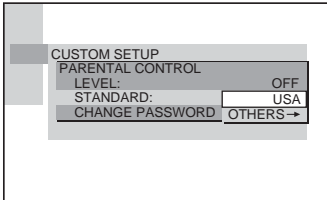

6 Press \uparrow/\downarrow to select a geographic area as the playback limitation level, then press ENTER.

The area is selected.

If you select [OTHERS \rightarrow], select and enter the standard code in the table on page 66 using the number buttons.

7 Press \uparrow/\downarrow to select [LEVEL], then press ENTER or \rightarrow .

The selection items for [LEVEL] are displayed.

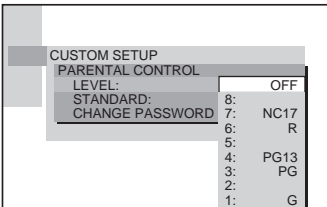

8 Select the level you want using \uparrow/\downarrow , then press ENTER.

The Parental Control setting is complete.

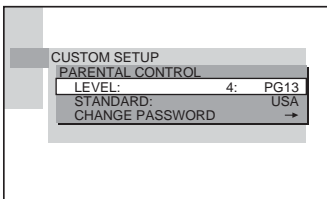

The lower the value, the more strict the limitation.

If you make a mistake

Press \rightarrow RETURN or \leftarrow to go back to the previous screen.

To turn off the Setup Display

Press DVD SETUP repeatedly until the Setup Display is turned off.

To turn off the Parental Control function and play the DVD after entering your password

Set [LEVEL] to [OFF] in Step 8.

To change the password

1 In Step 5, select [CHANGE PASSWORD \rightarrow] using \downarrow , then press ENTER or \rightarrow . The display for entering the password appears.

2 Follow Step 3 to enter a new password.

Playing the disc for which Parental Control is set

1 Insert the disc and press \triangleright .

The [PARENTAL CONTROL] display appears.

2 Enter your 4-digit password using the number buttons, then press ENTER.

The system starts playback.

Notes

- If you play a DVD which does not have the Parental Control function, playback cannot be limited on this system.
- Depending on the DVD, you may be asked to change the Parental Control level while playing the disc. In this case, enter your password, then change the level. If the Resume Play mode is cancelled, the level returns to the original level.

Tip

If you forget your password, remove the disc and repeat Step 1 to 3 of “Limiting playback for children.” When you are asked to enter your password, enter “199703” using the number buttons, then press ENTER. The display will ask you to enter a new 4-digit password. After you enter a new 4-digit password in Step 3, replace the disc in the system and press \triangleright . When the [PARENTAL CONTROL] display appears, enter your new password.

Area Code

Standard	Code number
Argentina	2044
Australia	2047
Austria	2046
Belgium	2057
Brazil	2070
Canada	2079
Chile	2090
China	2092
Denmark	2115
Finland	2165
France	2174
Germany	2109
Hong Kong	2219
India	2248
Indonesia	2238
Italy	2254
Japan	2276
Korea	2304
Malaysia	2363
Mexico	2362
Netherlands	2376
New Zealand	2390
Norway	2379
Pakistan	2427
Philippines	2424
Portugal	2436
Russia	2489
Singapore	2501
Spain	2149
Sweden	2499
Switzerland	2086
Taiwan	2543
Thailand	2528
United Kingdom	2184

Other Operations

Controlling TV with the Supplied Remote

By adjusting the remote signal, you can control your TV with the supplied remote.

Notes

- If you enter a new code number, the code number previously entered will be erased.
- When you replace the batteries of the remote, the code number may reset itself to the default (SONY) setting. Reset the appropriate code number.

Controlling TVs with the remote

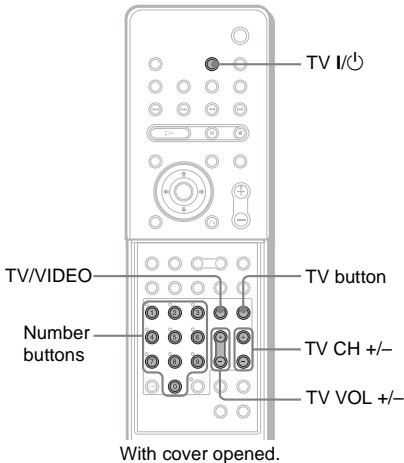

Press and hold TV I/O while entering your TV's manufacturer's code (see the table) using the number buttons. Then release TV I/O.

If you set successfully the manufacturer's code, the TV button flashes twice slowly. If the setting is unsuccessful, the TV button flashes five times quickly.

Code numbers of controllable TVs

If more than one code number is listed, try entering them one at a time until you find the one that works with your TV.

TV

Manufacturer	Code number
SONY	001
Admiral	012, 016, 039
AKAI	002
AOC	002
Bell&Howell	016, 039
Broksonic	002
Croslex	034
CURTIS-MATHES	002, 046
DAEWOO	002, 004, 005, 006
Daytron	020
EMERSON	002, 020
FISHER	009
General Electric	002, 012, 049
HITACHI	002, 014, 015, 020
JC Penny	002, 012
JVC	018
KTV	002, 020
LG/Goldstar	002, 020
LXI(Sears)	002, 009, 012, 034, 046
MAGNAVOX	002, 020, 027, 034
MARANTZ	022
Mitsubishi/MGA	002, 022
NEC	002
PANASONIC	049, 050
Philco	002, 004, 015, 020, 034
PHILIPS	027, 034
PIONEER	029, 046, 049
Portland	002
QUASAR	039, 049
RADIO SHACK	002, 012, 022
RCA/PROSCAN	002, 012, 032, 033
SAMSUNG	002, 020, 028, 036
SANYO	009, 010
SCOTT	002
SHARP	020, 039, 040
Signature	016, 039, 040
SYLVANIA	002, 034
TOSHIBA	039, 046

continued

Manufacturer	Code number
Videch	002, 015
WARDS	002, 020
ZENITH	016, 017

CATV

Manufacturer	Code number
SONY	101
HAMLIN/REGAL	123, 124, 125, 126, 127
OAK	128, 129, 130
PANASONIC	120, 121, 122
PIONEER	115, 116
SCIENTIFIC	110, 111, 112
ATLANTA	
TOCOM	117, 118, 131
ZENITH	113, 114

Controlling the TV

You can control your TV using the buttons below.

By pressing	You can
TV I/⏻	Turn the TV on or off.
TV/VIDEO	Switch the TV's input source between the TV and other input sources.
TV VOL +/-	Adjust the TV volume.
TV CH +/-	Select the TV channel.

Using the number buttons for controlling the TV

When you set the remote to the TV mode, you can use the number buttons for controlling the TV.

Press the TV button.

The TV button turns red and the remote is set to the TV mode. You can select the TV channels by using the number buttons.

>10 is for selecting the channel number greater than 10.

To cancel the TV mode, press the TV button again.

Notes

- Depending on the TV, you may not be able to control your TV or to use some of the buttons above.
- The TV button turns off when you do not operate the remote for 10 seconds.

Tip

Depending on the TV manufacture, the following method also works. Press >10, then the number. (For example, for channel 25, press >10, then 2 and 5.)

Using the SONY TV DIRECT Function

SONY TV DIRECT allows you to turn on your SONY TV and this system, change the system mode to “DVD,” and then switch the TV’s input source you set with one button push.

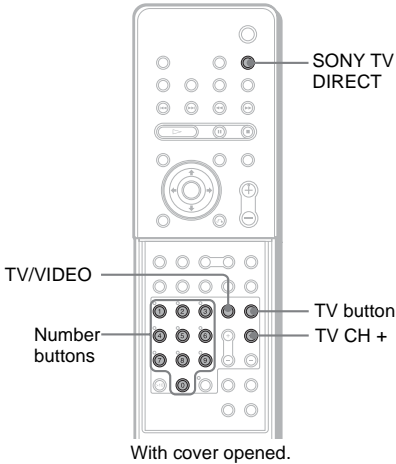

Preparation

Register the TV’s input source connected to this system.

Press and hold TV/VIDEO while entering the code for the TV’s input source to connect this system (see table below) using the number buttons.

TV’s input source is selected.

If you successfully set the TV’s input source code, the TV button flashes twice slowly. If the setting is unsuccessful, the TV button flashes five times quickly.

By pressing	Number	TV’s input source
TV/VIDEO	0	No input source (Default)
	1	VIDEO1
	2	VIDEO2
	3	VIDEO3
	4	VIDEO4
	5	VIDEO5
	6	VIDEO6
	7*	COMPONENT1 INPUT
	8*	COMPONENT2 INPUT

* Except for North American models.

Operation

Point the remote to the direction of TV and this system, then press SONY TV DIRECT once.

While transmitting the code from the remote, the TV button flashes.

If this function does not work, change the transmit time. The transmit time varies depending on the TV.

To change the transmit time

Press and hold TV CH + while entering the code for transmit time (see table below) using the number buttons.

The transmit time from the remote is selected.

If you successfully set the transmit time code, the TV button flashes twice slowly. If the setting is unsuccessful, the TV button flashes five times quickly.

By pressing	Number	Transmit time
TV CH+	1	0.5 (Default)
	2	1
	3	1.5
	4	2
	5	2.5
	6	3
	7	3.5
	8	4

Notes

- This function is only for SONY TV series.
- If distance between TV and this system is too far, this function may not work. Install the system near the TV.
- Keep the remote pointed in the direction of the TV and this system while the TV button is flashing.

Using the Video or Other Units

You can use VCRs or other units connected to the VIDEO or SAT jacks. Refer to the operation manual supplied with the unit for further information on the operation.

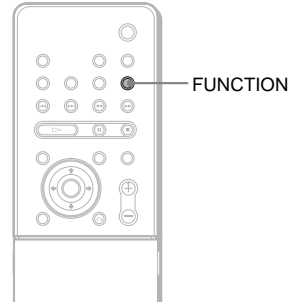

Press FUNCTION repeatedly until VIDEO or SAT that you connected the unit to appears in the front panel display.

Each time you press FUNCTION, the mode of the system changes in the following sequence.
FM → AM → VIDEO → SAT → DVD → FM...

Enjoying Multiplex Broadcast Sound (DUAL MONO)

You can enjoy multiplex broadcast sound when the system receive the AC-3 multiplex broadcast signal.

Note

To receive the AC-3 signal, you need to connect a digital satellite tuner to the system with an OPTICAL cable (page 24) and set the digital output mode of the digital satellite tuner to AAC.

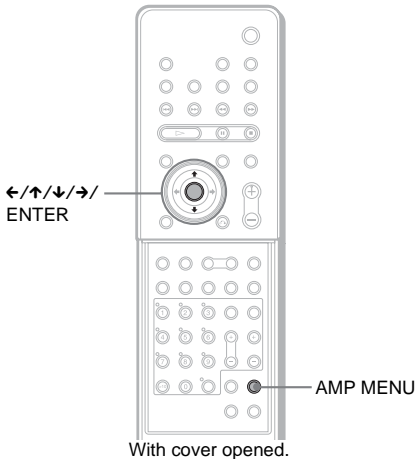

- 1 Press AMP MENU.**
- 2 Press ↓/↑ repeatedly until "CUSTOMIZE" appears in the front panel display, then press ENTER or →.**
The system enters the Customize Menu mode.
- 3 Press ↓/↑ repeatedly until "DUAL MONO" appears in the front panel display, then press ENTER or →.**
- 4 Press ↓/↑ to select the sound you want.**

■ MAIN

Main sound is output from the left and right speakers.

■ SUB

Sub sound is output from the left and right speakers.

■ MAIN+SUB

Main sound and Sub sound are output from the left and right speakers.

■ MAIN/SUB

Main sound is output from the left speaker and Sub sound is output from the right speaker.

5 Press AMP MENU.

Turns off the AMP menu.

Enjoying the Radio

Presetting Radio Stations

You can preset 20 FM stations, and 10 AM stations. Before tuning, make sure to turn down the volume to minimum.

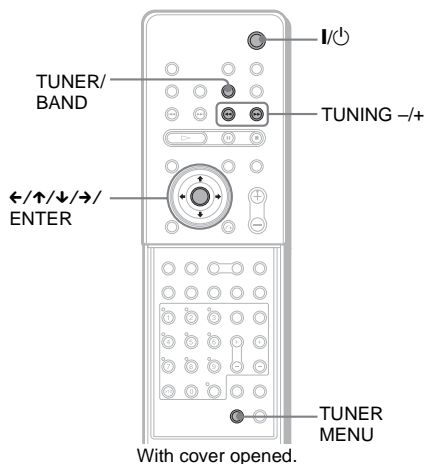

- 1 Press TUNER/BAND repeatedly until the band you want appears in the front panel display.**

Each time you press TUNER/BAND, the band toggles between AM and FM.

- 2 Press and hold TUNING + or – until scanning starts, then release.**

Scanning stops when the system tunes in a station. "TUNED" and "ST" (for stereo program) appear in the front panel display.

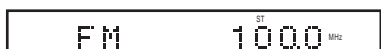

- 3 Press TUNER MENU.**

- 4 Press ←/→/↓/↑ repeatedly until "MEMORY ?" appears in the front panel display.**

- 5 Press ENTER.**

A preset number appears in the front panel display.

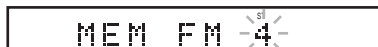

- 6 Press ←/→/↓/↑ to select/ the preset number you want.**

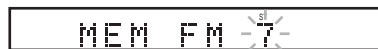

- 7 Press ENTER.**

The station is stored.



- 8 Repeat 1 to 7 to store other stations.**

To change the preset number
Restart from step 1.

To change the AM tuning interval

The AM tuning interval can be set to either 10 kHz (default) or 9 kHz (for some areas).

To change the AM tuning interval, first tune in any AM station, then turn off the system by pressing I/⏻ on the remote, or I/⏻ on the system. While holding down VOLUME + on the system, press I/⏻ on the system to turn on the power. If you change the interval, AM preset stations will be erased.

To reset the interval, repeat the same procedure.

Listening to the Radio

Preset radio stations in the system's memory first (see "Presetting Radio Stations" on page 72).

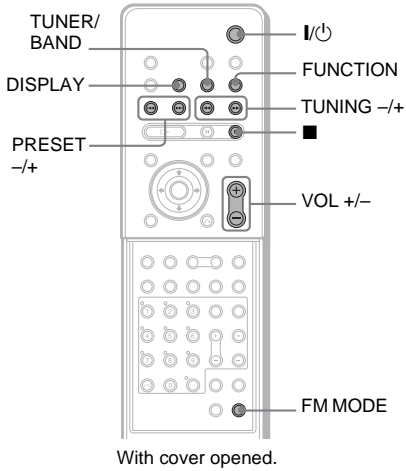

- 1 Press **FUNCTION** repeatedly until "FM" or "AM" appears in the front panel display.

The last received station is tuned in.



- 2 Press **PRESET + or -** repeatedly to select the preset station you want.

Each time you press the button, the system tunes in one preset station.

Each time you press **TUNER/BAND**, the band toggles between AM and FM.

- 3 Adjust the volume by pressing **VOL +/-**.

To turn off the radio

Press **I/⏻**.

To listen to non-preset radio stations

Use manual or automatic tuning in Step 2.

For manual tuning, press **TUNING + or -** on the remote repeatedly.

For automatic tuning, press and hold **TUNING + or -** on the remote. Press **■** when you stop the automatic tuning.

Tips

- If an FM program is noisy, press **FM MODE** on the remote so that "MONO" appears in the front panel display. There will be no stereo effect, but the reception will improve. Press the button again to restore the stereo effect.
- To improve reception, reorient the supplied antennas (aerials).

To check the frequency or sound field

Press **DISPLAY** repeatedly.

Each time you press **DISPLAY**, the front panel display changes as follows:

index name of the station* → frequency → sound field → index name of the station...

* This is displayed if you have entered a name for a preset station (page 74).

Naming Preset Stations

You can enter a name of up to 8 characters for preset stations. These names (for example, “XYZ”) appear in the system’s front panel display when a station is selected.

Note that no more than one name can be entered for each preset station.

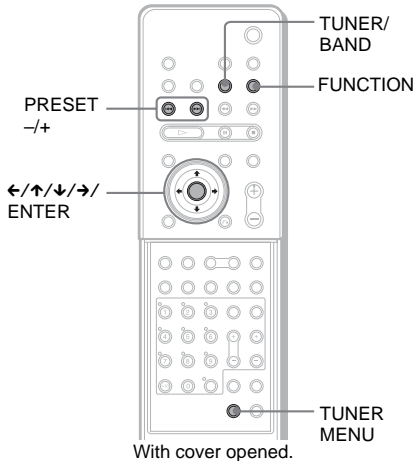

1 Press FUNCTION repeatedly until “FM” or “AM” appears in the front panel display.

Each time you press TUNER/BAND, the band toggles between AM and FM.

The last station you received is tuned in.

Each time you press FUNCTION, the mode of the system changes in the following sequence:

FM → AM → VIDEO → SAT → DVD → FM...

2 Press PRESET+ or – repeatedly to select the preset station you want to create an index name for.

3 Press TUNER MENU.

4 Press ←/→ repeatedly until “NAME IN?” appears in the front panel display.

5 Press ENTER.

6 Create an index name by using the cursor buttons:

Press ↑/↓ to select a character, then press → to move the cursor to the next position.

If you make a mistake

Press ←/→ repeatedly until the character to be changed flashes, then press ↑/↓ to select the desired character. Capital letters, numbers, and other symbols can be input for a radio station name.

7 Press ENTER.

The station name is stored.

Using the Sleep Timer

You can set the system to turn off at a preset time, so you can fall asleep listening to music. You can preset the time in 10 minutes decrements.

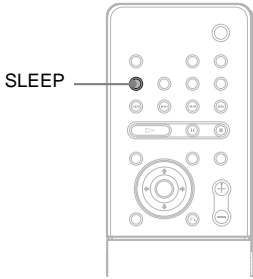

Press SLEEP.

Each time you press this button, the minutes display (the remaining time) changes as follows:

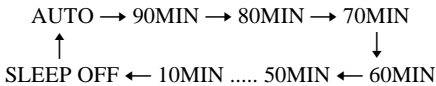

When you choose AUTO

The system turns off when the current disc finishes playback (up to 240 minutes). The system turns off if you manually stop playing a disc.

“AUTO” mode works only with functions such as DVD that is selected before setting to “AUTO.”

To check the remaining time

Press SLEEP once. You cannot check the remaining time if you select “AUTO.”

To change the remaining time

Press SLEEP repeatedly to select the desired time.

To cancel the Sleep Timer function

Press SLEEP repeatedly until “SLEEP OFF” appears in the front panel display.

Changing the Brightness of the Front Panel Display

You can change the brightness of the front panel display by two steps.

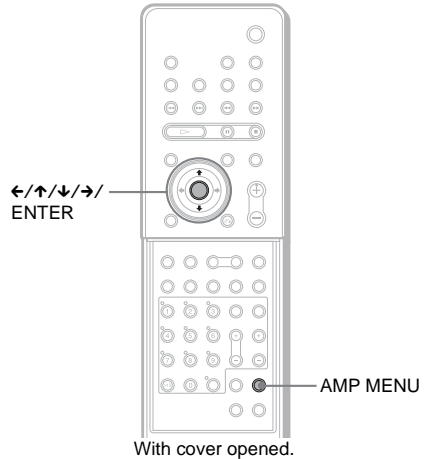

- 1 Press AMP MENU.
- 2 Press ↓/↑ repeatedly until “CUSTOMIZE” appears in the front panel display, then press ENTER or →. The system enters the Customize Menu mode.
- 3 Press ↓/↑ repeatedly until “DIMMER” appears in the front panel display, then press ENTER or →.
- 4 Press ↓/↑ to select the brightness of the front panel display.
- 5 Press AMP MENU. Turns off the AMP menu.

Returning to the Default Settings

You can return the system parameters such as speaker settings and preset stations, to the default settings.

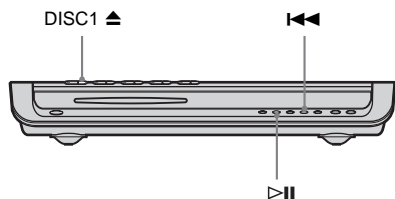

Press ◀◀, ▶||, or DISC1 ▲ on the system at the same time.

“COLD RESET” appears in the front panel display and the default settings are returned.

Settings and Adjustments

Using the Setup Display



By using the Setup Display, you can make various adjustments to items, such as picture and sound. You can also set the subtitle language and the Setup Display, among other things. For details on each Setup Display item, see page 78-84. For an overall list of Setup Display items, see page 103.

How to use the Setup Display

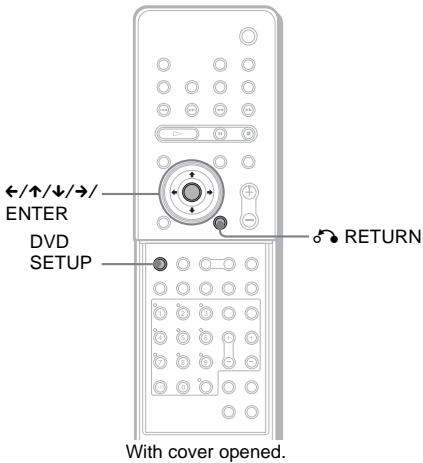

1 In stop mode, press DVD SETUP.

The Setup Display appears.

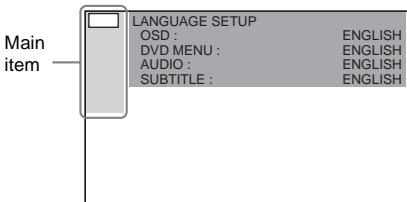

2 Press \uparrow/\downarrow to select the setup item from the displayed list: [LANGUAGE SETUP], [SCREEN SETUP], [CUSTOM SETUP], [SPEAKER SETUP], and [SETUP]. Then press ENTER or \rightarrow .

The selected Setup item appears.

Example: [SCREEN SETUP]

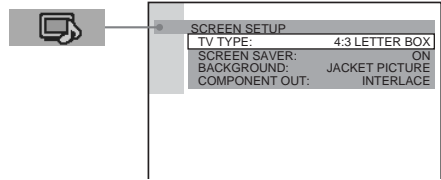

3 Select an item using \uparrow/\downarrow , then press ENTER or \rightarrow .

The options for the selected item appear.

Example: [TV TYPE]

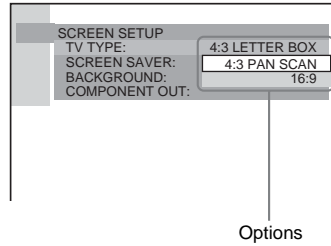

Press \leftarrow or RETURN to return to setup items.

4 Select a setting using \uparrow/\downarrow , then press ENTER.

The setting is selected and setup is complete.

Example: [4:3 PAN SCAN]

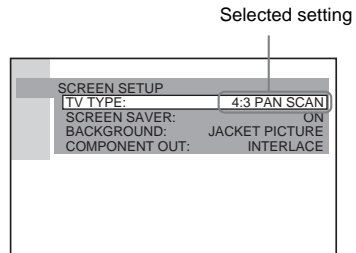

To turn off the Setup Display

Press DVD SETUP repeatedly until the Setup Display is turned off.

Setting the Display or Sound Track Language

[LANGUAGE SETUP]



[LANGUAGE SETUP] allows you to set various languages for the on-screen display or sound track.

Select [LANGUAGE SETUP] in the Setup Display. For details on using the display, see “Using the Setup Display” (page 77).

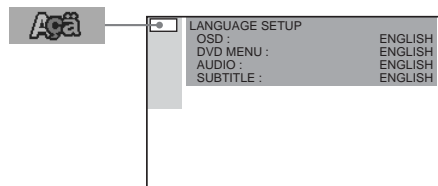

■ OSD (On-Screen Display)

Selects the display language on the screen. Select the language from the displayed list.

■ DVD MENU (DVD only)

Selects the desired language for the DVD menu. Select the language from the displayed list.

■ AUDIO (DVD only)

Selects the language of the sound track. Select the language from the displayed list.

■ SUBTITLE (DVD only)

Selects the language of the subtitle. Select the language from the displayed list.

Note

If you select a language that is not recorded on the DVD, one of the recorded languages will be automatically selected (except for [OSD]).

Tip

If you select [OTHERS →] in [DVD MENU], [AUDIO], or [SUBTITLE], select and enter the language code from the list using the number buttons (page 102).

After you have made a selection, the language code (4 digits) is displayed the next time you select [OTHERS →].

Settings for the Display

(SCREEN SETUP)



Choose settings according to the TV to be connected.

Select [SCREEN SETUP] in the Setup Display. For details on using the display, see “Using the Setup Display” (page 77).

The default settings are underlined.

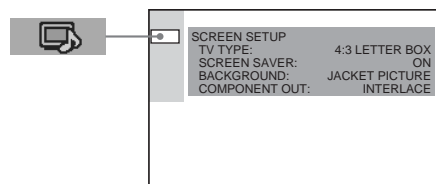

■ TV TYPE (DVD only)

Selects the aspect ratio of the connected TV (4:3 standard or wide).

4:3 LETTER BOX	Select this if you connect a 4:3 screen TV. Displays a wide picture with bands on the upper and lower portions of the screen.
4:3 PAN SCAN	Select this if you connect a 4:3 screen TV. Automatically displays the wide picture on the entire screen and cuts off the portions that do not fit.
16:9	Select this if you connect a wide-screen TV or a TV with a wide mode function.

4:3 LETTER BOX



4:3 PAN SCAN



16:9



Note

Depending on the DVD, [4:3 LETTER BOX] may be selected automatically instead of [4:3 PAN SCAN] or vice versa.

SCREEN SAVER

Turns the screen saver on and off so that the screen saver image appears when you leave the system in pause or stop mode for 15 minutes, or when you playback a CD, a Super Audio CD, an MP3, or JPEG file (except during the slide show) for more than 15 minutes. The screen saver will help prevent your display device from becoming damaged (afterimage). Press \blacktriangleright to turn off the screen saver.

ON	Turns on the screen saver.
OFF	Turns off the screen saver.

BACKGROUND

Selects the background color or picture on the TV screen in stop mode or while playing a CD.

JACKET PICTURE	The jacket picture (still picture) appears in the background, but only if a jacket picture is already recorded on the disc (CD-EXTRA, etc.). If the disc does not contain a jacket picture, the [GRAPHICS 1] picture appears.
-----------------------	---

GRAPHICS 1-5	A preset picture stored in the system appears in the background.
---------------------	--

BLUE	The background color is blue.
-------------	-------------------------------

BLACK	The background color is black.
--------------	--------------------------------

COMPONENT OUT

This will change the type of signal output from the COMPONENT VIDEO OUT jacks on the system. See pages 94 and 95 for more information about the different types.

INTERLACE	Select this when you connect to a standard (interlace format) TV.
------------------	---

PROGRESSIVE	Select this when you have a TV that can accept progressive signals.
--------------------	---

To set to [PROGRESSIVE]

- 1 Select [COMPONENT OUT] in [SCREEN SETUP] using \uparrow/\downarrow , then press ENTER.

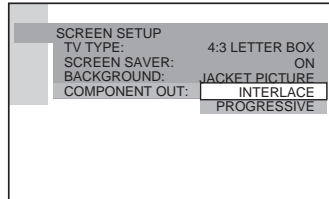

- 2 Select [PROGRESSIVE] using \uparrow/\downarrow , then press ENTER.

The display for confirming appears.

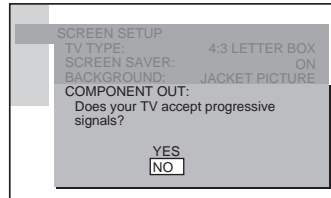

- 3 Select [YES] using \uparrow/\downarrow , then press ENTER.

The type of output signal changes to progressive format.

Notes

- If your TV accepts progressive signals, connect COMPONENT VIDEO OUT of the system to the TV using a component video cord (not supplied), and set progressive format.
- When [PROGRESSIVE] is selected in [SCREEN SETUP], no signal is output from the MONITOR OUT jacks.
- If you set [COMPONENT OUT] in [SCREEN SETUP] to [PROGRESSIVE] even though your TV cannot accept the signal in progressive format, picture noise may appear. In this case, return the setting to interlace format (page 25).
- The display for confirming does not appear when you select [INTERLACE].

Custom Settings

(CUSTOM SETUP)



Allows setting up Parental Control and other settings.

Select [CUSTOM SETUP] in the Setup Display. For details on using the display, see “Using the Setup Display” (page 77).

The default settings are underlined.

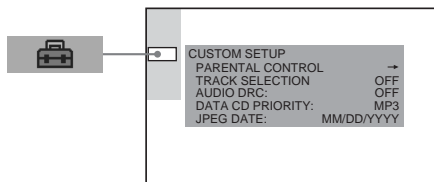

■ PARENTAL CONTROL → (DVD only)

Sets a password and playback limitation level for DVDs with playback limitation for children. For details, see “Limiting playback for children (Parental Control) (DVD only)” (page 64).

■ TRACK SELECTION (DVD only)

Gives the sound track having the highest number of channels priority when you play a DVD on which multiple audio formats (PCM, MPEG audio, DTS, or Dolby Digital format) are recorded.

<u>OFF</u>	No priority given.
<u>AUTO</u>	Priority given.

Notes

- When you set the item to [AUTO], the language may change. The [TRACK SELECTION] setting has higher priority than the [AUDIO] settings in [LANGUAGE SETUP] (page 78).
- If PCM, DTS, MPEG audio, and Dolby Digital sound tracks have the same number of channels, the system selects PCM, DTS, Dolby Digital, and MPEG audio sound tracks in this order.
- Depending on the DVD, the audio channel with priority may be predetermined. In this case, you cannot give priority to the DTS, Dolby Digital, or MPEG audio format by selecting [AUTO].

■ AUDIO DRC*

Narrows the DYNAMIC range of the sound track.

Useful for watching movies at low volume late at night.

* Dynamic Range Compression

OFF	No compression of DYNAMIC range.
ON	Reproduces the sound track with the kind of DYNAMIC range that the recording engineer intended.

Note

AUDIO DRC only applies to Dolby Digital sources.

■ DATA CD PRIORITY (MP3, JPEG only)

Set priority data you want to play, when you play a DATA CD (CD-ROM/CD-R/CD-RW) containing MP3 audio tracks and JPEG image files.

MP3	If an MP3 file exists on a disc, the system recognises the disc as an "MP3 Disc." If only JPEG files exist on the disc, the system recognises the disc as a "JPEG Disc."
------------	--

JPEG	If a JPEG file exists on the disc, the system recognises the disc as a "JPEG Disc." If only MP3 files exist on the disc, the system recognises the disc as an "MP3 Disc."
-------------	---

■ JPEG DATE

Change the date information order of a JPEG image in the Control Menu.

MM/DD/YYYY
YYYY/MM/DD
DD/MM/YYYY
YYYY/DD/MM

YYYY: Year
MM: Month
DD: Day

Settings for the Speakers

(SPEAKER SETUP)

To obtain the best possible surround sound, set for the size of the speakers you have connected and their distance from your listening position. Then use the test tone to adjust the level and the balance of the speakers to the same level.

Select [SPEAKER SETUP] in the Setup Display. For details, see "Using the Setup Display" (page 77).

The default settings are underlined.

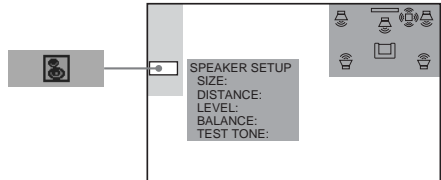

To return to the default setting when changing a setting

Select the item, then press CLEAR.

■ SIZE

If you do not connect center or surround speakers, or move the surround speakers, set the parameters for [CENTER] and [SURROUND] and specify the surround speaker position and height. Since the front speaker and subwoofer settings are fixed, you cannot change them.

If you connect the surround back speaker, set [SURROUND BACK] to [YES].

Position diagram

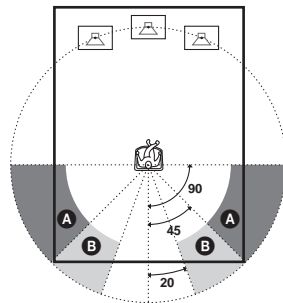

FRONT	<u>YES</u>
CENTER	<u>YES</u> : Normally select this. NONE: Select this if no center speaker is used.
SURROUND	<u>BEHIND</u> : Select this if surround speakers are located in section B . <u>SIDE</u> : Select this if surround speakers are located in section A . NONE: Select this if no surround speaker is used.
SURROUND BACK (appears except when you set [SURROUND] to [NONE] in the [SIZE] setting.)	<u>NONE</u> : Normally select this. YES: Select this if the surround back speaker is used.
SUBWOOFER	<u>YES</u>

Notes

- When you select an item, the sound cuts off for a moment.
- Depending on the settings of other speakers, subwoofer may be excessive.

■ DISTANCE

The default distance setting for the speakers in relation to the listening position is shown below. When you set the distance using the Quick Setup (page 27), the settings is automatically displayed.

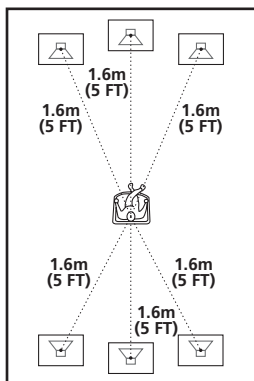

Be sure to change the value in the Setup Display when you move the speakers.

FRONT 1.6 m/5 ft*	Front speaker distance from the listening position can be set in 0.2 meter (1 ft) increments from 1.0 to 7.0 meters (3 to 23 ft).
CENTER 1.6 m/5 ft* (appears when you set [CENTER] to [YES] in the [SIZE] setting.)	Center speaker distance can be moved up to 1.6 meters (5 ft) closer to the listening position from the front speaker distance, in 0.2 meter (1 ft) increments.
SURROUND 1.6 m/5 ft* (appears except when you set [SURROUND] to [NONE] in the [SIZE] setting.)	Surround speaker distance can be moved up to 4.6 meters (15 ft) closer to the listening position from the front speaker distance, in 0.2 meter (1 ft) increments.
SURROUND BACK 1.6 m/5 ft (appears when you set [SURROUND BACK] to [YES] in the [SIZE] setting.)	Surround back speaker distance can be moved up to 4.6 meters (15 ft) closer to the listening position from the front speaker distance, in 0.2 meter (1 ft) increments.

* When you perform the Quick Setup (page 27), the default settings are changed.

Notes

- When you set the distance, the sound cuts off for a moment.
- If all front and surround speakers are not placed at an equal distance from your listening position, set the distance according to the closest speaker.
- Do not place the surround speakers farther away from your listening position than the front speakers.
- Depending on the input stream, the [DISTANCE] setting may not be effective.

■ LEVEL

You can vary the level of each speaker as follows. Be sure to set [TEST TONE] to [ON] for easy adjustment.

**CENTER
0 dB*** Adjusts the level of the center speaker (–6 dB to +6 dB, 1 dB increments).
(appears when you set [CENTER] to [YES] in the [SIZE] setting.)

**SURROUND
LEFT 0 dB*
SURROUND
RIGHT 0 dB*** Adjusts the level of the surround speakers (–6 dB to +6 dB, 1 dB increments).
(appears except when you set [SURROUND] to [NONE] in the [SIZE] setting.)

**SURROUND
BACK
0 dB** Adjusts the level of the surround back speaker (–10 dB to +10 dB, 1 dB increments).
(appears when you set [SURROUND BACK] to [YES] in the [SIZE] setting.)

**SUBWOOFER
+4 dB*** Adjusts the level of the subwoofer (–6 dB to +6 dB, 1 dB increments).

* When you perform the Quick Setup (page 27), the default settings are changed.

■ BALANCE

You can vary the balance of the left and right speakers as follows. Be sure to set [TEST TONE] to [ON] for easy adjustment.

**FRONT
(CENTER)** Adjusts the balance between the front left and right speakers.
The center position is shown as “---.” (You can adjust from the center 6 steps to left or right.)

To adjust the volume of all the speakers at one time

Use the VOLUME control on the system, or press VOL +/-.

■ TEST TONE

The speakers will emit a test tone to adjust [LEVEL] and [BALANCE].

OFF The test tone is not emitted from the speakers.

ON The test tone is emitted from both left and right speakers simultaneously while adjusting balance. When you select one of the [SPEAKER SETUP] items, the test tone is emitted from each speaker in sequence.

Adjusting the speaker balance and level by using the test tone

- 1 Press DVD SETUP in stop mode.**
The Setup Display appears.
- 2 Press \uparrow/\downarrow repeatedly to select [SPEAKER SETUP], then press ENTER or \rightarrow .**
- 3 Press \uparrow/\downarrow repeatedly to select [TEST TONE], then press ENTER or \rightarrow .**
- 4 Press \uparrow/\downarrow repeatedly to select [ON], then press ENTER.**
You will hear the test tone from each speaker in sequence.
- 5 From your listening position, adjust the value of [BALANCE] and [LEVEL] using $\leftarrow/\uparrow/\downarrow/\rightarrow$.**
When selecting [BALANCE], the test tone is emitted from both left and right speakers simultaneously.
When selecting [LEVEL], the test tone is emitted from only the speaker which you are adjusting.
- 6 Press ENTER when you have finished making adjustments.**
- 7 Press \uparrow/\downarrow repeatedly to select [TEST TONE], then press ENTER.**
- 8 Press \uparrow/\downarrow repeatedly to select [OFF], then press ENTER.**

Notes

- When you adjust the speaker settings, the sound cuts off for a moment.
- The surround back speaker level can be also adjusted on the amplifier that is connected to the surround back speaker.

Tip

To adjust the balance or the level without listening to the test tone, select [BALANCE] or [LEVEL] in step 3 and press ENTER. Then adjust the balance or level using \uparrow/\downarrow and press ENTER.

Setting the speakers by using the front panel display on the system

You can set the speakers by using the AMP menu that is displayed in the front panel display.

AMP menu list

SP SETUP

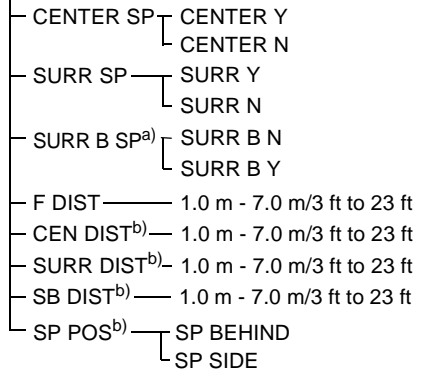

LEVEL



^{a)} This setting appears when you set "SURR SP" to "SURR Y" in "SP SETUP."

^{b)} This setting appears when you set the corresponding speaker to "Y" in "SP SETUP."

CUSTOMIZE

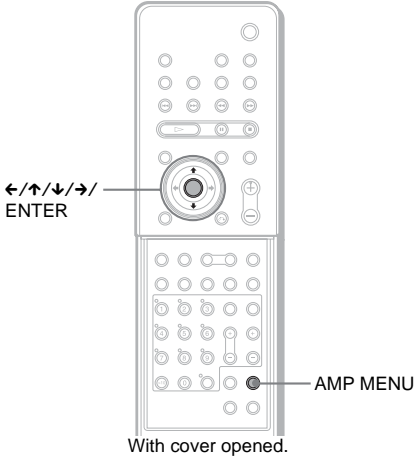
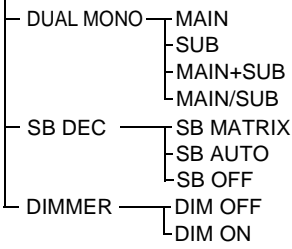

- 1** Press **AMP MENU**.
- 2** Press **↑/↓** repeatedly until the item you want to set appears in the front panel display.

■ SP SETUP

Sets the speaker size, distance, and place.

■ LEVEL

Sets the balance and level of the each speaker, and turns on/off the test tone.

- 3** Press **ENTER** or **→**.
- 4** Press **↑/↓** to select the desired item, then press **ENTER** or **→**.

To set the item, press **↑/↓**, then press **ENTER** or **AMP MENU**.

You can set the following items. The default settings are underlined.

■ SP SETUP

CENTER SP (center speaker) CENTER Y: Select this if you use a center speaker.
CENTER N: Select this if no center speaker is used.

SURR SP (surround speakers) SURR Y: Select this if you use surround speakers.
SURR N: Select this if no surround speaker is used.

SURR B SP^{a)} (surround back speaker) SURR B N: Select this if no surround back speaker is used.
SURR B Y: Select this if you use a surround back speaker.

F DIST (front distance) Front speaker distance from the listening position can be set in 0.2 meter (1 ft) increments from 1.0 to 7.0 meters (3 to 23 ft).
1.6m/5 ft^{b)}

CEN DIST^{c)} (center distance) Center speaker distance can be moved up to 1.6 meters (5 ft) closer to the listening position from the front speaker distance, in 0.2 meter (1 ft) increments.
1.6m/5 ft^{b)}

SURR DIST^{c)} (surround distance) Surround speaker distance can be moved up to 4.6 meters (15 ft) closer to the listening position from the front speaker distance, in 0.2 meter (1 ft) increments.
1.6m/5 ft^{b)}

SB DIST^{c)} (surround back distance) Surround back speaker distance can be moved up to 4.6 meters (15 ft) closer to the listening position from the front speaker distance, in 0.2 meter (1 ft) increments.
1.6m/5 ft^{b)}

SP POS^{c)} (surround speakers position) SP BEHIND: Select this if surround speakers are located in the back area of the listening position.
SP SIDE: Select this if surround speakers are located in the side area of the listening position.

a) This setting appears when you set "SURR SP" to "SURR Y" in "SP SETUP."
 b) When you perform the Quick Setup (page 27), the default settings are changed.
 c) This setting appears when you set the corresponding speaker to "Y" in "SP SETUP" (page 85).

continued

■ LEVEL

TEST TONE (test tone)	<u>T. TONE OFF</u> : The test tone is not emitted from the speakers. <u>T. TONE ON</u> : The test tone is emitted from both left and right speakers simultaneously while adjusting balance. When you select one of the “LEVEL” items, the test tone is emitted from each speaker in sequence.
F BALANCE (front balance) <u>0</u>	Adjusts the balance between the front left and right speakers. (You can adjust from the center 6 steps left (L6) or right (R6).)
CEN LEVEL^{b)} (center level) <u>0^{a)}</u>	Adjusts the level of the center speaker (–6 dB to +6 dB, 1 dB increments).
SL LEVEL^{b)} (surround left level) <u>0^{a)}</u>	Adjusts the left level of the surround speaker (–6 dB to +6 dB, 1 dB increments).
SR LEVEL^{b)} (surround right level) <u>0^{a)}</u>	Adjusts the right level of the surround speaker (–6 dB to +6 dB, 1 dB increments).
SB LEVEL^{b)} (surround back level) <u>0^{a)}</u>	Adjusts the level of the surround back speaker (–10 dB to +10 dB, 1 dB increments).
SW LEVEL (subwoofer level) <u>+4^{a)}</u>	Adjusts the level of the subwoofer (–6 dB to +6 dB, 1 dB increments).
AUDIO DRC (dynamic compression)	<u>DRC OFF</u> : No compression of DYNAMIC range. <u>DRC ON</u> : Reproduces the sound track with the kind of DYNAMIC range that the recording engineer intended.

a) When you perform the Quick Setup (page 27), the default settings are changed.

b) This setting appears when you set the corresponding speaker to “Y” in “SP.SETUP” (page 85).

■ CUSTOMIZE

DUAL MONO (dual mono)	<u>MAIN</u> <u>SUB</u> MAIN+SUB MAIN/SUB For details, see “Enjoying Multiplex Broadcast Sound (DUAL MONO)” on page 71.
SB DEC (surround back decoding)	<u>SB MATRIX</u> <u>SB AUTO</u> <u>SB OFF</u> For details, see “Selecting the Surround Back Decoding Mode” on page 57.
DIMMER (dimmer)	<u>DIM OFF</u> <u>DIM ON</u> For details, see “Changing the Brightness of the Front Panel Display” on page 75.

Quick Setup and Resetting the System

(SETUP)

Select [SETUP] in the setup display.
For details, see “Using the Setup Display”
(page 77).

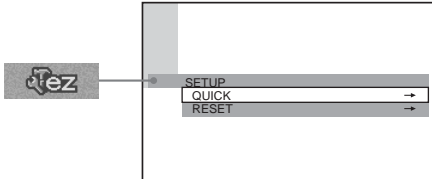

■ QUICK

Normally, when you turn the system on for the first time or after resetting the system, the guide message appears on the TV screen and you can perform the Quick Setup. If you cancelled the Quick Setup and you want to perform the Quick Setup again, operate on this screen. See “How to use the Quick Setup” on page 27.

Note

After performing the Quick Setup, the settings of following items are changed.

- [OSD], [DVD MENU], and [SUBTITLE] in [LANGUAGE SETUP]
- [DISTANCE] and [LEVEL] in [SPEAKER SETUP]
- [TV TYPE] in [SCREEN SETUP]

■ RESET

You can reset the system.

After you select [RESET] and press ENTER, select [YES] to reset the settings (it takes a few seconds to complete). Select [NO] and press ENTER to cancel. Do not press **I/C**, when resetting the system.

Notes

- When you select [RESET], all the settings return to the default.
- When you turn the system on after resetting, the guide message appears on the TV screen. To perform the Quick Setup (page 27), press ENTER, to return to normal screen, press CLEAR.

Additional Information

Troubleshooting

If you experience any of the following difficulties while using the system, use this troubleshooting guide to help remedy the problem before requesting repairs. Should any problem persist, consult your nearest Sony dealer.

Power

The power is not turned on.

- Check that the AC power cord (mains lead) is connected securely.

The STANDBY indicator flashes.

Immediately unplug the power cord and check the following items.

- Are the + and – speaker cords short-circuited?
- Are you using only the specified speakers?
- Is anything blocking the ventilation holes on the top of the system?
- Is the subwoofer connected incorrectly?

After checking the above items and fixing any problems, connect the power cord again and turn on the system. If the indicator still flashes, or if the cause of the problem cannot be found even after checking all the above items, consult your nearest Sony dealer.

Picture

There is no picture.

- The video connecting cords are not connected securely.
- The video connecting cords are damaged.
- The system is not connected to the correct TV input jack (page 23).
- The video input on the TV is not set so that you can view pictures from the system.
- You have set [COMPONENT OUT] in [SCREEN SETUP] to [PROGRESSIVE] even though your TV cannot accept the signal in progressive format. In this case, return the setting to interlace format (page 25).
- Even if your TV is compatible with progressive format (480p) signals, the image may be affected when you set [COMPONENT OUT] to [PROGRESSIVE]. In this case, set [COMPONENT OUT] to [INTERLACE] (page 79).

- When [PROGRESSIVE] is selected in [SCREEN SETUP], no signal is output from the MONITOR OUT or S VIDEO OUT jacks.

Picture noise appears.

- The disc is dirty or flawed.
- If the picture output from your system goes through your VCR to get to your TV, the copy-protection signal applied to some DVD programs could affect picture quality. If you still experience problems even when you connect your system directly to your TV, try connecting your system to your TV's S video input (page 23).

Even though you set the aspect ratio in [TV TYPE] of [SCREEN SETUP], the picture does not fill the screen.

- The aspect ratio on the disc is fixed.

Sound

There is no sound.

- The speaker cord is not connected securely.
- Press MUTING on the remote if "MUTING ON" is displayed in the front panel display.
- The system is in pause mode or in Slow-motion Play mode. Press ▷ to return to normal play mode.
- Fast forward or fast reverse is performed. Press ▷ to return to normal play mode.
- Check the speaker settings (pages 29, 81).

The left and right sounds are unbalanced or reversed.

- Check that the speakers and components are connected correctly and securely.
- Adjust the balance parameter in the [BALANCE] menu (page 83).

There is no sound from the subwoofer.

- Check the speaker connections and settings (pages 29, 81).
- Set the sound field to "AUTO FORMAT DIRECT AUTO" (page 53).

Severe hum or noise is heard.

- Check that the speakers and components are connected securely.
- Check that the connecting cords are away from a transformer or motor, and at least 3 meters away from your TV set or a fluorescent light.
- Move your TV away from the audio components.
- The plugs and jacks are dirty. Wipe them with a cloth slightly moistened with alcohol.
- Clean the disc.

The sound loses stereo effect when you play a VIDEO CD, a CD, or an MP3.

- Set [AUDIO] to [STEREO] in the Control Menu display (page 51).
- Make sure the system is connected appropriately.

The surround effect is difficult to hear when you are playing a Dolby Digital, DTS, or MPEG audio sound track.

- Make sure the sound field function is on (page 53).
- Check the speaker connections and settings (pages 29, 81).
- Depending on the DVD, the output signal may not be the entire 5.1 channel. It may be monaural or stereo even if the sound track is recorded in Dolby Digital or MPEG audio format.

The sound comes from the center speaker only.

- Depending on the disc, the sound may come from the center speaker only.

No sound is heard from the center speaker.

- Check the speaker connections and settings.
- Make sure the sound field function is on (page 53).
- Depending on the source, the effect of the center speaker may be less noticeable.

No sound or only a very low-level sound is heard from the surround speakers.

- Check the speaker connections and settings.
- Make sure the sound field function is on (page 53).
- Select a sound field containing the word "C. ST. EX" (page 55).
- Depending on the source, the effect of the surround speakers may be less noticeable.

Operation

Radio stations cannot be tuned in.

- Check that the antennas (aerials) are connected securely. Adjust the antennas (aerials) or connect an external antenna (aerial) if necessary.
- The signal strength of the stations is too weak (when tuning in with automatic tuning). Use direct tuning.
- No stations have been preset or the preset stations have been cleared (when tuning by scanning preset stations). Preset the stations (page 72).
- Press DISPLAY so that the frequency appears in the display.

The remote does not function.

- There are obstacles between the remote and the system.
- The distance between the remote and the system is too far.
- The remote is not pointed at the remote sensor on the system.
- The batteries in the remote are weak.

The disc does not play.

- There is no disc inserted.
- The disc is upside down.
Insert the disc with the playback side facing down on the disc tray.
- The disc is skewed in the system.
- The system cannot play CD-ROMs, etc. (page 8).
- The region code on the DVD does not match the system.
- Moisture has condensed inside the system.
Remove the disc and leave the system turned on for about half an hour (page 3).

The MP3 audio track cannot be played.

- The DATA CD is not recorded in an MP3 format that conforms to ISO9660 Level 1/ Level 2 or Joliet.
- The MP3 audio track does not have the extension ".MP3."
- The data is not formatted in MP3 even though it has the extension ".MP3."
- The system can only play MP3 (MPEG1 Audio Layer3) audio.
- Set [DATA CD PRIORITY] to [MP3] in the [CUSTOM SETUP] setting (page 81).
- Directory level is more than 8.
- The disc contains more than 99 albums (the maximum number of MP3 audio tracks that can be contained on an album is 250).

The title of the MP3 audio album or track is not correctly displayed.

- The system can only display alphabetical letters and numbers. Other characters are displayed as "".

The display for entering the password does not appear for Super Audio CD, even though Custom Parental Control is set.

- Custom Parental Control is set for different layers of a Super Audio CD.

The JPEG image file cannot be played.

- The DATA CD is not recorded in an JPEG format that conforms to ISO9660 Level 1/ Level 2 or Joliet.
- The JPEG image file does not have the extension “.JPG” or “.JPEG.”
- The data is not formatted in JPEG even though it has the extension “.JPG” or “.JPEG.”
- Image length or width is more than 4720 dots.
- Set [DATA CD PRIORITY] to [JPEG] in the [CUSTOM SETUP] setting (page 81).
- Directory level is more than 8.
- You cannot play the Progressive JPEG files.
- A JPEG image file with a high width to length ratio cannot be played.
- The disc contains more than 99 albums (the maximum number of JPEG image files that can be contained on an album is 250).

The title of the JPEG album or file is not correctly displayed.

- The system can only display alphabetical letters and numbers. Other characters are displayed as “ ”.

A disc does not start playing from the beginning.

- Program Play, Shuffle Play, or Repeat Play has been selected (pages 39, 41, 42).
- Resume Play has been selected.
During stop, press ■ on the system or the remote and then start playback (page 32).
- The title, DVD or PBC menu automatically appears on the TV screen.

The system starts playing the disc automatically.

- The DVD features an auto playback function.

Playback stops automatically.

- Some discs may contain an auto pause signal. While playing such a disc, the system stops playback at the auto pause signal.

The system turns off during DVD playback.

- If approximately one hour passes with DVD playback paused or with the DVD top menu or a DVD menu displayed during DVD playback, the system automatically turns off.

You cannot perform some functions such as Stop, Search, Slow-motion Play, Repeat Play, Shuffle Play, or Program Play.

- Depending on the disc, you may not be able to perform some of the operations above. See the operating manual that came with the disc.

Messages do not appear on the screen in the language you want.

- In the Setup Display, select the desired language for the on-screen display in [OSD] under [LANGUAGE SETUP] (page 78).

The language for the sound track cannot be changed.

- Multilingual tracks are not recorded on the DVD being played.
- The DVD prohibits changing the language for the sound track.

The subtitle language cannot be changed.

- Multilingual subtitles are not recorded on the DVD being played.
- The DVD prohibits changing the subtitles.

The subtitle cannot be turned off.

- The DVD prohibits turning off subtitles.

The angles cannot be changed.

- Multi-angles are not recorded on the DVD being played (page 60).
- The DVD prohibits changing the angles.

A disc cannot be ejected and “LOCKED” appears in the front panel display.

- Contact your Sony dealer or local authorized Sony service facility.

“C-32” appears in the front panel display.

- Turn the power off and then on again by pressing I/⏻ on the system.

“CANNOT LOCK” appears in the front panel display.

- Turn the power off and then on again by pressing I/⏻ on the system, then perform “On moving the system” (page 4). If “CANNOT LOCK” still appears in the front panel display, contact your Sony dealer or local authorized Sony service facility.

The system does not work normally.

- Disconnect the AC power cord (mains lead) from the wall outlet (mains), then reconnect after several minutes.

Specifications

AUDIO POWER SPECIFICATIONS POWER OUTPUT AND TOTAL HARMONIC DISTORTION:

With 4 ohm loads, both channels driven, from 20 – 20,000 Hz; rated 75 watts per channel minimum RMS power, with no more than 0.7 % total harmonic distortion. (from 250 milli watts to rated output)

Amplifier section (DAV-FR1)

Surround mode (reference)	Front: 110 W + 110 W (with SS-TS20)
music power output	Center*: 110 W (with SS-CT44)
	Surround*: 110 W + 110W (with SS-TS20)
	Subwoofer*: 100 W × 2 (with SS-WS12)

Amplifier section (DAV-FR8)

Surround mode (reference)	Front: 114 W + 114 W (with SS-TS21)
music power output	Center*: 114 W (with SS-CT33)
	Surround*: 114 W + 114W (with SS-TS20)
	Subwoofer*: 115 W × 2 (with SS-WS12)

Amplifier section (DAV-FR9)

Surround mode (reference)	Front: 114 W + 114 W (with SS-TS21)
music power output	Center*: 114 W (with SS-CT33)
	Surround*: 114 W + 114W (with SS-TS21)
	Subwoofer*: 115 W × 2 (with SS-WS12)

* Depending on the sound field settings and the source, there may be no sound output.

Inputs	VIDEO/SAT: Sensitivity: 250 mV/ 450 mV Impedance: 50 kilohms
Output	SURROUND BACK Voltage: 2V Impedance: 1 kilohms
Phones	Accepts low-and high-impedance headphones.

Super Audio CD/DVD system

Laser	Semiconductor laser (Super Audio CD/DVD: λ = 650 nm) (CD: λ = 780 nm) Emission duration: continuous
Signal format system	NTSC
Frequency response (at 2 CH STEREO mode)	DVD (PCM): 2 Hz to 22 kHz (± 1.0 dB) CD: 2 Hz to 20 kHz (± 1.0 dB)
Harmonic distortion	Less than 0.03 %

Tuner section

System	PLL quartz-locked digital synthesizer system
FM tuner section	
Tuning range	87.5 – 108.0 MHz (100 kHz step)
Antenna (aerial)	FM wire antenna (aerial)
Antenna (aerial) terminals	75 ohms, unbalanced
Intermediate frequency	10.7 MHz
AM tuner section	
Tuning range	531 – 1,710 kHz (with the interval set at 9 kHz) 530 – 1,710 kHz (with the interval set at 10 kHz)
Antenna (aerial)	AM loop antenna (aerial)
Intermediate frequency	450 kHz

Video section

Outputs	Video: 1 Vp-p 75 ohms\ S VIDEO: Y: 1 Vp-p 75 ohms C: 0.286 Vp-p 75 ohms COMPONENT: Y: 1 Vp-p 75 ohms P _B /C _B , P _R /C _R : 0.65 Vp-p 75 ohms
---------	---

Speakers (DAV-FR1)

Front/Surround

Speaker system	Bass reflex
Speaker unit	70 mm (2 7/8 inches) dia. cone type
Rated impedance	4 ohms
Dimensions (approx.)	90 × 221 × 75 mm (3 5/8 × 8 3/4 × 3 inches) (w/h/d)
Mass (approx.)	0.7 kg (1 lb 9 oz)

Center

Speaker system	Bass reflex
Speaker unit	70 mm (2 7/8 inches) dia. cone type
Rated impedance	4 ohms
Dimensions (approx.)	356 × 92 × 76 mm (14 1/8 × 3 5/8 × 3 inches) (w/h/d)
Mass (approx.)	0.9 kg (2 lb)

Subwoofer

Speaker system	Bass reflex
Speaker unit	160 mm (6 3/8 inches) dia. cone type × 2
Rated impedance	4 ohms
Dimensions (approx.)	201 × 369 × 448 mm (8 × 14 5/8 × 17 3/4 inches) (w/h/d)
Mass (approx.)	9.5 kg (21 lb)

Speakers (DAV-FR8)

Front

Speaker system	Two-way Bass reflex
Speaker unit	70 mm (2 7/8 inches) dia. cone type, 25 mm (1 inch) dia. balanced-dome-type tweeter
Rated impedance	4 ohms
Dimensions (approx.)	255 × 1112 × 255 mm (10 1/8 × 43 7/8 × 10 1/8 inches) (w/h/d)
Mass (approx.)	4.1 kg (9 lb 1 oz)

Center

Speaker system	Two-way Bass reflex
Speaker unit	70 mm (2 7/8 inches) dia. cone type, 25 mm (1 inch) dia. balanced-dome-type tweeter
Rated impedance	4 ohms
Dimensions (approx.)	356 × 92 × 76 mm (14 1/8 × 3 5/8 × 3 inches) (w/h/d)
Mass (approx.)	0.95 kg (2 lb 2 oz)

Surround

Speaker system	Bass reflex
Speaker unit	70 mm (2 7/8 inches) dia. cone type
Rated impedance	4 ohms
Dimensions (approx.)	90 × 221 × 75 mm (3 5/8 × 8 3/4 × 3 inches) (w/h/d)
Mass (approx.)	0.7 kg (1 lb 9 oz)

Subwoofer

Speaker system	Bass reflex
Speaker unit	160 mm (6 3/8 inches) dia. cone type × 2
Rated impedance	4 ohms
Dimensions (approx.)	201 × 369 × 448 mm (8 × 14 5/8 × 17 3/4 inches) (w/h/d)
Mass (approx.)	9.5 kg (21 lb)

Speakers (DAV-FR9)

Front/Surround

Speaker system	Two-way Bass reflex
Speaker unit	70 mm (2 7/8 inches) dia. cone type, 25 mm (1 inch) dia. balanced-dome-type tweeter
Rated impedance	4 ohms
Dimensions (approx.)	255 × 1112 × 255 mm (10 1/8 × 43 7/8 × 10 1/8 inches) (w/h/d)
Mass (approx.)	4.1 kg (9 lb 1 oz)

Center

Speaker system	Two-way Bass reflex
Speaker unit	70 mm (2 7/8 inches) dia. cone type, 25 mm (1 inch) dia. balanced-dome-type tweeter
Rated impedance	4 ohms
Dimensions (approx.)	356 × 92 × 76 mm (14 1/8 × 3 5/8 × 3 inches) (w/h/d)
Mass (approx.)	0.95 kg (2 lb 2 oz)

Subwoofer

Speaker system	Bass reflex
Speaker unit	160 mm (6 3/8 inches) dia. cone type × 2
Rated impedance	4 ohms
Dimensions (approx.)	201 × 369 × 448 mm (8 × 14 5/8 × 17 3/4 inches) (w/h/d)
Mass (approx.)	9.5 kg (21 lb)

General

Power requirements	120 V AC, 60 Hz
Power consumption	120 W
Dimensions (approx.)	430 × 70 × 398 mm (17 × 2 7/8 × 15 3/4 inches) (w/h/d) incl. projecting parts
Mass (approx.)	5.5 kg (12 lb 12 oz)
Supplied accessories	See page 13.

Design and specifications are subject to change without notice.

Glossary

Album

Section of a music piece or an image on a data CD containing MP3 audio tracks or JPEG files.

Chapter

Subdivision of a title on a DVD. A title is composed of several chapters.

Digital Cinema Sound (DCS)

This is the generic name of the surround sound produced by digital signal processing technology developed by Sony. Unlike previous surround sound fields mainly directed at the reproduction of music, Digital Cinema Sound is designed specifically for the enjoyment of movies.

Dolby Digital

This movie theater sound format is more advanced than Dolby Surround Pro Logic. In this format, the surround speakers output stereo sound with an expanded frequency range, and a subwoofer channel for deep bass is independently provided. This format is also called "5.1," with the subwoofer channel designated as the 0.1 channel (since it functions only when a deep bass effect is needed). All six channels in this format are recorded separately for superior channel separation. Furthermore, since all the signals are processed digitally, less signal degradation occurs.

Dolby Digital EX

An enhanced compatible format of Dolby Digital 5.1, developed by Dolby Laboratories and Lucasfilm THX, which adds an extra surround back channel, and can be used for 6.1(three surround speakers) channel playback, using matrix encoding.

Dolby Pro Logic II

Dolby Pro Logic II creates five full-bandwidth output channels from two-channel sources. This is done using an advanced, high-purity matrix surround decoder that extracts the spatial properties of the original recording without adding any new sounds or tonal colorations.

■ **Movie mode**

The Movie mode is for use with stereo television shows and all programs encoded in Dolby Surround. The result is enhanced sound field directionality that approaches the quality of discrete 5.1-channel sound.

■ **Music mode**

The Music mode is for use with any stereo music recordings, and provides a wide and deep sound space.

Dolby Surround Pro Logic

As one method of decoding Dolby Surround, Dolby Surround Pro Logic produces four channels from two-channel sound. Compared with the former Dolby Surround system, Dolby Surround Pro Logic reproduces left-to-right panning more naturally and localizes sounds more precisely. To take full advantage of Dolby Surround Pro Logic, you should have one pair of surround speakers and a center speaker. The surround speakers output monaural sound.

DTS

Digital audio compression technology developed by Digital Theater Systems, Inc. This technology conforms to 5.1-channel surround. This format comprises of stereo rear channels and a discrete subwoofer channel. DTS provides the same 5.1 discrete channels of high quality digital audio. The good channel separation is realized due to all channel data being recorded discretely and processed digitally.

DTS-ES

An enhanced compatible format of 5.1 channel, which adds an extra surround back channel. There are two formats: Discrete 6.1, which processes the surround back signal independently, and Matrix 6.1, which processes it along with the Surround (L/R) channels.

DVD

A disc that contains up to 8 hours of moving pictures even though its diameter is the same as a CD.

The data capacity of a single-layer and single-sided DVD, at 4.7 GB (Giga Byte), is 7 times that of a CD. Furthermore, the data capacity of a dual-layer and single-sided DVD is 8.5 GB, a single-layer and double-sided DVD 9.4 GB, and a dual-layer and double-sided DVD 17 GB.

The picture data uses the MPEG 2 format, one of a worldwide standard of digital compression technology. The picture data is compressed to about 1/40 of its original size. DVD also uses variable rate coding technology that processes allocated data according to the status of the picture.

The audio data is recorded in Dolby Digital as well as in PCM, allowing you to enjoy more realistic audio presence.

Furthermore, various advanced functions such as the multi-angle, multilingual, and Parental Control functions are provided with the DVD.

File

Section of a picture on a data CD containing JPEG image files.

Film based software, Video based software

DVDs can be classified as Film based or Video based software. Film based DVDs contain the same images (24 frames per second) that are shown at movie theaters. Video based DVDs, such as television dramas or sit-coms, displays images at 30 frames (or 60 fields) per second.

Index (Super Audio CD, CD)/Video Index (VIDEO CD)

A number that divides a track into sections to easily locate the point you want on a VIDEO CD, Super Audio CD, or CD. Depending on the disc, no indexes may be recorded.

Interlace format (Interlaced scanning)

The Interlace format is the NTSC standard method for displaying TV images at 30 frames per second. Each frame is scanned twice - alternately between the even numbered scanning lines and then odd numbered scanning lines, at 60 times per second.

Multi-angle function

Various angles of a scene, or viewpoints of the video camera are recorded on some DVDs.

Multilingual function

Several languages for the sound or subtitles in a picture are recorded on some DVDs.

Neo:6

Developed by Digital Theater Systems, Inc., applies a conventional 2-channel or Dolby Digital source signal to a high-precision, digital matrix decoder to achieve 6.1 channel surround playback.

CINEMA mode allows for more separation of channels to enhance the 6.1 channel effect, and is best suited for movies.

MUSIC mode allows the front L and R channels to go unprocessed for optimum stereo, with the addition of the surround components adding a special quality to the sound.

Parental Control

A function of the DVD to limit playback of the disc by the age of the users according to the limitation level in each country. The limitation varies from disc to disc; when it is activated, playback is completely prohibited, violent scenes are skipped or replaced with other scenes and so on.

Playback Control (PBC)

Signals encoded on VIDEO CDs (Version 2.0) to control playback.

By using menu screens recorded on VIDEO CDs with PBC functions, you can enjoy playing simple interactive programs, programs with search functions, and so on.

Progressive format (sequential scanning)

In contrast to the Interlace format, the progressive format can reproduce 60 frames per second by reproducing all scanning lines (525 lines for the NTSC system). The overall picture quality increases and still images, text and horizontal lines appear sharper. This format is compatible with the 525 progressive format.

Region Code

This system is used to protect copyrights. A region number is allocated on each DVD system or DVD disc according to the sales region. Each region code is shown on the system as well as on the disc packaging. The system can play the discs that match its region code. The system can also play discs with the "Globe" mark. Even when the region code is not shown on the DVD, the region limit may still be activated.

Scene

On a VIDEO CD with PBC (playback control) functions, the menu screens, moving pictures and still pictures are divided into sections called "scenes."

Super Audio CD

A Super Audio CD disc can reproduce sounds that are extremely faithful to the original sound by use of DSD (Direct Stream Digital) technology. This technology utilizes a sampling frequency of 2.8224 MHz, which is 64 times that of a conventional CD, and 1-bit quantization that enables the disc to hold 4 times the amount of information that a standard PCM format CD can hold. Super Audio CDs are divided into the following types.

- Super Audio CD (single layer disc)
This disc consists of a single HD layer*.
- * High density signal layer for the Super Audio CD

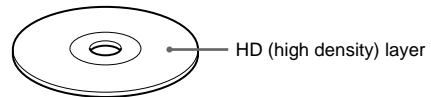

- Super Audio CD (dual layer disc)
This disc consists of dual HD layers and is capable of extended play over long periods. Also, as the dual layer disc consists of dual HD layers on one side only, you do not have to turn the disc over during playback.

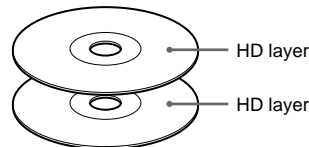

- Super Audio CD + CD (Hybrid disc)
This disc consists of an HD layer and a CD layer. Also, as the dual layers are on one side

only, you do not have to turn the disc over during playback. You can play this CD layer using a conventional CD player.

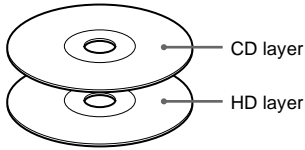

- 2 channel + Multi-channel Super Audio CD
This disc consists of a 2 channel playback area and a multi-channel playback area.

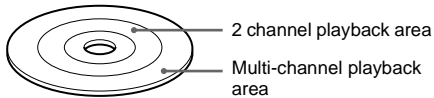

Title

The longest section of a picture or music feature on a DVD, movie, etc., in video software, or the entire album in audio software.

Track

Section of a picture or a music piece on a Super Audio CD, CD, VIDEO CD or MP3. An album is composed of several tracks (MP3 only).

VIDEO CD

A compact disc that contains moving pictures. The picture data uses the MPEG 1 format, one of a worldwide standard of digital compression technology. The picture data is compressed to about 1/140 of its original size. Consequently, a 12 cm VIDEO CD can contain up to 74 minutes of moving pictures.

VIDEO CDs also contain compact audio data. Sounds outside the range of human hearing are compressed while sounds we can hear are not compressed. VIDEO CDs can hold 6 times the audio information of conventional audio CDs. There are 2 versions of VIDEO CDs.

- Version 1.1: You can play only moving pictures and sounds.
- Version 2.0: You can play high-resolution still pictures and enjoy PBC functions.

This system conforms to both versions.

Index to Parts and Controls

For more information, refer to the pages indicated in parentheses.

Front Panel

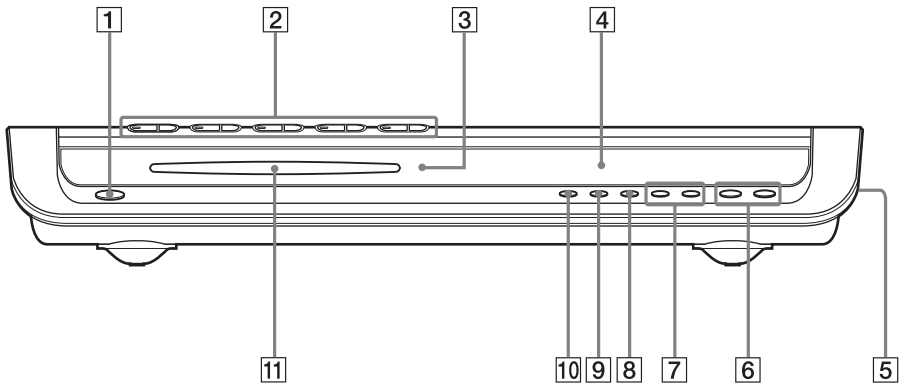

- 1 I/O (power) switch/STANDBY indicator (30)
- 2 DISC1-5 ▲ (eject)/indicators (30)
- 3 □ (remote sensor) (13)
- 4 Front panel display (98)
- 5 PHONES (on the side of the system) jack (30)

- 6 VOLUME +/- (30, 83)
- 7 ◀◀/▶▶ (31, 33)
- 8 ■ (stop) (31)
- 9 ▷|| (play/pause) (30)
- 10 FUNCTION (30, 70, 73)
- 11 Disc slot (30)

Front Panel Display

When playing back a DVD

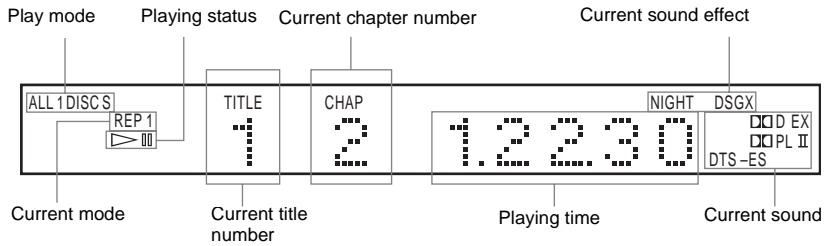

When playing back a Super Audio CD, CD, VIDEO CD (without PBC functions), or MP3

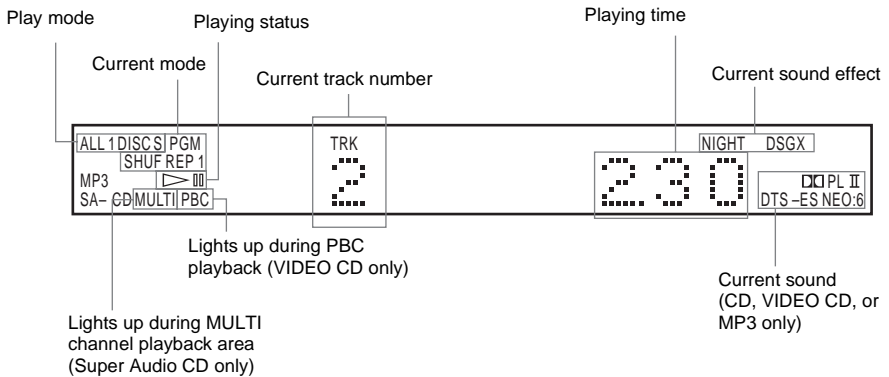

When listening to the radio

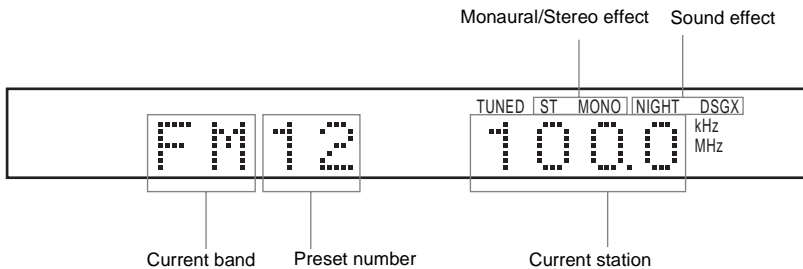

When playing back a JPEG file

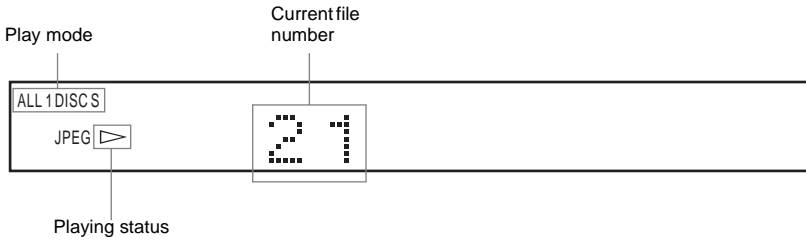

Rear Panel

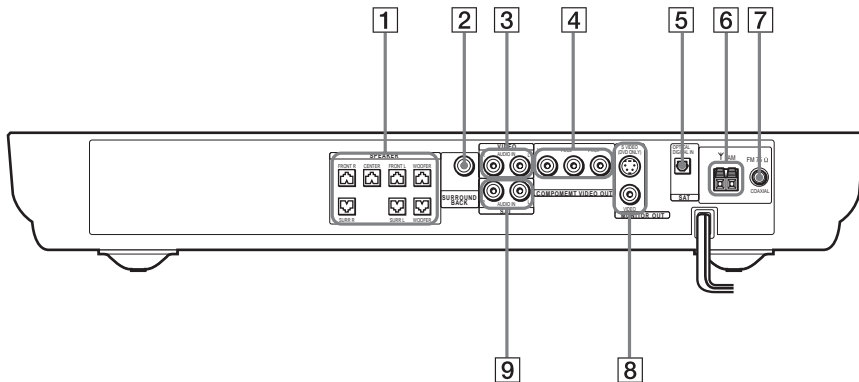

- | | |
|---|---|
| 1 SPEAKER jacks (15) | 6 AM terminals (21) |
| 2 SURROUND BACK jack (19) | 7 FM 75Ω COAXIAL jack (21) |
| 3 VIDEO AUDIO IN (L/R) jacks (23) | 8 MONITOR OUT (VIDEO/S VIDEO) jacks (23) |
| 4 COMPONENT VIDEO OUT jacks (23) | 9 SAT AUDIO IN (L/R) jacks (23) |
| 5 SAT OPTICAL DIGITAL IN jack (24) | |

Remote

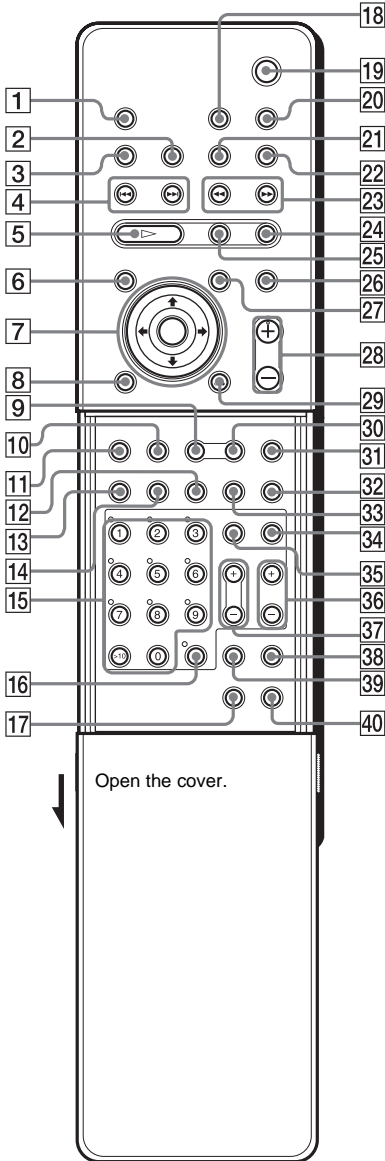

- 1 DISC SKIP (30, 31)
- 2 DISPLAY (46, 49, 73)
- 3 SLEEP (75)
- 4 ◀◀/▶▶, PRESET -/+ (31, 33, 73, 74)
- 5 ▷ (play) (30, 31, 32, 33, 37, 38, 39, 41, 41, 42, 43)
- 6 DVD TOP MENU/ALBUM- (33, 35, 36)
- 7 ◀/▶/↶/↷/ENTER (27, 33, 33, 35, 36, 38, 38, 39, 41, 42, 44, 51, 57, 60, 61, 62, 64, 71, 72, 74, 75, 77, 85)
- 8 DVD DISPLAY (35, 36, 38, 41, 42, 44, 49, 50, 51, 60, 61, 62)
- 9 AUTO FORMAT DIRECT (53, 54)
- 10 DSGX (59)
- 11 DVD SETUP (27, 64, 77)
- 12 SUBTITLE (61)
- 13 AUDIO (51)
- 14 ANGLE (60)
- 15 Number buttons (33, 33, 39, 44, 60, 62, 64, 67, 69)
- 16 ENTER
- 17 TUNER MENU (72, 74)
- 18 TV I/⏻ (on/standby) (67)
- 19 I/⏻ (standby) (27, 30, 72, 73)
- 20 SONY TV DIRECT (69)
- 21 TUNER/BAND (72, 73, 74)
- 22 FUNCTION (27, 30, 70, 73, 74)
- 23 ◀◀/▶▶/◀|▶ SLOW, TUNING -/+ (37, 43, 72, 73)
- 24 ■ (stop) (31, 32, 33, 62, 73)
- 25 || (pause) (31)
- 26 MUTING (31)
- 27 DVD MENU/ALBUM+ (33, 35, 36)
- 28 VOL +/- (31, 73)
- 29 ⏪ RETURN (27, 33, 35, 36, 38, 39, 44, 62, 64, 77)
- 30 MODE (54, 55)
- 31 NIGHT MODE (59)
- 32 PLAY MODE (38, 39, 41)
- 33 REPEAT (39, 42)
- 34 TV (67, 69)
- 35 TV/VIDEO (67, 69)
- 36 TV CH +/- (67, 69)
- 37 TV VOL +/- (67)
- 38 AMP MENU (57, 71, 75, 85)
- 39 CLEAR (27, 39, 44)
- 40 FM MODE (73)

Note

This remote control glows in the dark. However, before glowing, the remote must be exposed to light for awhile.

Language Code List

The language spellings conform to the ISO 639: 1988 (E/F) standard.

Code	Language	Code	Language	Code	Language
1027	Afar	1245	Inupiak	1489	Russian
1028	Abkhazian	1248	Indonesian	1491	Kinyarwanda
1032	Afrikaans	1253	Icelandic	1495	Sanskrit
1039	Amharic	1254	Italian	1498	Sindhi
1044	Arabic	1257	Hebrew	1501	Sangho
1045	Assamese	1261	Japanese	1502	Serbo-Croatian
1051	Aymara	1269	Yiddish	1503	Singhalese
1052	Azerbaijani	1283	Javanese	1505	Slovak
1053	Bashkir	1287	Georgian	1506	Slovenian
1057	Byelorussian	1297	Kazakh	1507	Samoa
1059	Bulgarian	1298	Greenlandic	1508	Shona
1060	Bihari	1299	Cambodian	1509	Somali
1061	Bislama	1300	Kannada	1511	Albanian
1066	Bengali; Bangla	1301	Korean	1512	Serbian
1067	Tibetan	1305	Kashmiri	1513	Siswati
1070	Breton	1307	Kurdish	1514	Sesotho
1079	Catalan	1311	Kirghiz	1515	Sundanese
1093	Corsican	1313	Latin	1516	Swedish
1097	Czech	1326	Lingala	1517	Swahili
1103	Welsh	1327	Laothian	1521	Tamil
1105	Danish	1332	Lithuanian	1525	Telugu
1109	German	1334	Latvian; Lettish	1527	Tajik
1130	Bhutani	1345	Malagasy	1528	Thai
1142	Greek	1347	Maori	1529	Tigrinya
1144	English	1349	Macedonian	1531	Turkmen
1145	Esperanto	1350	Malayalam	1532	Tagalog
1149	Spanish	1352	Mongolian	1534	Setswana
1150	Estonian	1353	Moldavian	1535	Tonga
1151	Basque	1356	Marathi	1538	Turkish
1157	Persian	1357	Malay	1539	Tsonga
1165	Finnish	1358	Maltese	1540	Tatar
1166	Fiji	1363	Burmese	1543	Twi
1171	Faroese	1365	Nauru	1557	Ukrainian
1174	French	1369	Nepali	1564	Urdu
1181	Frisian	1376	Dutch	1572	Uzbek
1183	Irish	1379	Norwegian	1581	Vietnamese
1186	Scots Gaelic	1393	Occitan	1587	Volapük
1194	Galician	1403	(Afan) Oromo	1613	Wolof
1196	Guarani	1408	Oriya	1632	Xhosa
1203	Gujarati	1417	Punjabi	1665	Yoruba
1209	Hausa	1428	Polish	1684	Chinese
1217	Hindi	1435	Pashto; Pushto	1697	Zulu
1226	Croatian	1436	Portuguese		
1229	Hungarian	1463	Quechua	1703	Not specified
1233	Armenian	1481	Rhaeto-Romance		
1235	Interlingua	1482	Kirundi		
1239	Interlingue	1483	Romanian		

DVD Setup Menu List

You can set the following items with the DVD Setup menu.

The order of the displayed items may be different from the actual display.

LANGUAGE SETUP

- OSD — (Selects the language you want to use from the displayed language list.)
- DVD MENU — (Selects the language you want to use from the displayed language list.)
- AUDIO — (Selects the language you want to use from the displayed language list.)
- SUBTITLE — (Selects the language you want to use from the displayed language list.)

SCREEN SETUP

- TV TYPE —
 - 4:3 LETTER BOX
 - 4:3 PAN SCAN
 - 16:9
- SCREEN SAVER —
 - ON
 - OFF
- BACKGROUND —
 - JACKET
 - PICTURE
 - GRAPHICS 1
 - GRAPHICS 2
 - GRAPHICS 3
 - GRAPHICS 4
 - GRAPHICS 5
 - BLUE
 - BLACK
- COMPONENT OUT —
 - INTERLACE
 - PROGRESSIVE
 - YES
 - NO

CUSTOM SETUP

- PARENTAL CONTROL —
 - LEVEL —
 - 8. OFF
 - 7. NC17
 - 6. R
 - 5.
 - 4. PG13
 - 3. PG
 - 2.
 - 1. G
 - STANDARD —
 - USA
 - OTHERS →
 - CHANGE PASSWORD
- TRACK SELECTION —
 - OFF
 - AUTO
- AUDIO DRC —
 - OFF
 - ON
- DATA CD PRIORITY —
 - MP3
 - JPEG
- JPEG DATE —
 - MM/DD/YYYY
 - YYYY/MM/DD
 - DD/MM/YYYY
 - YYYY/DD/MM

SPEAKER SETUP

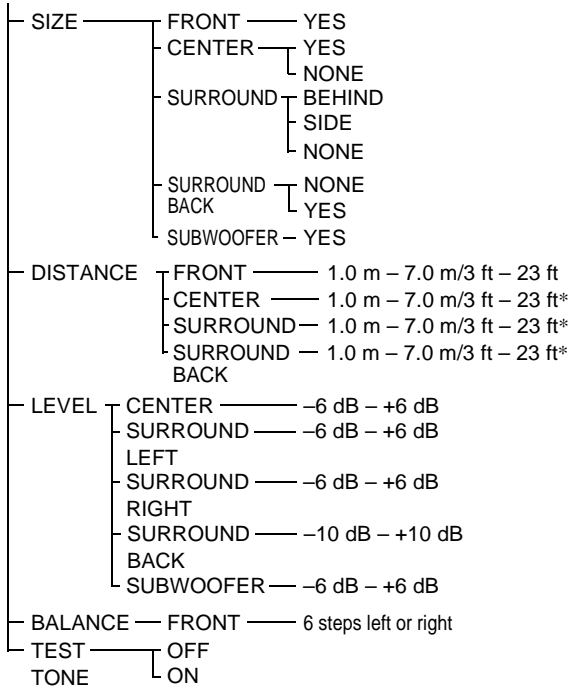

* The setting range changes depending on the front speaker setting (page 82).

SETUP

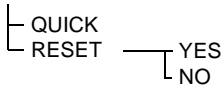

AMP Menu List

You can set the following items with AMP MENU on the remote.

SP SETUP

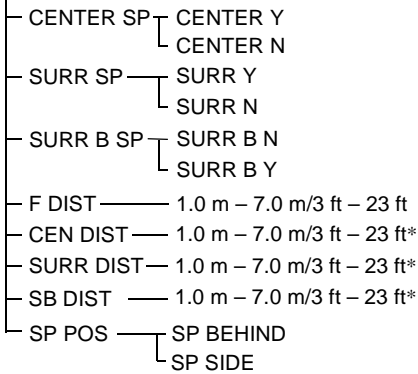

* The setting range changes depending on the front speaker setting (page 84).

CUSTOMIZE

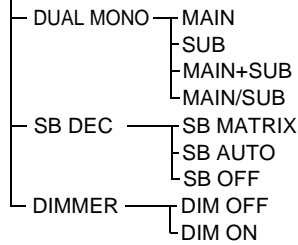

LEVEL

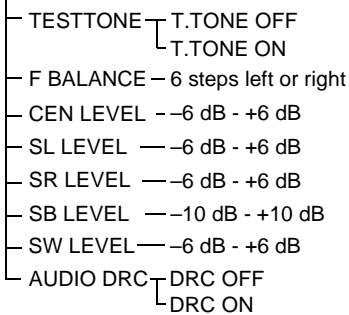

Index

Numerics

16:9 78
4:3 LETTER BOX 78
4:3 PAN SCAN 78

A

ALBUM 35, 44
Album 7, 93
ANGLE 60
Antenna (aerial) Hookups 21
AUDIO 51, 78
AUDIO DRC 81

B

BACKGROUND 79
BALANCE 83
Batteries 13

C

CHAPTER 45
Chapter 7, 93
COMPONENT OUT 79
Continuous play
 CD/VIDEO CD/Super Audio
 CD/DVD/MP3 30
Control Menu 11
CUSTOM PARENTAL
 CONTROL 62
CUSTOM SETUP 80

D

DATA CD PRIORITY 81
Digital Cinema Sound 93
DIMMER 75
DISC SKIP 30
DISPLAY 46
DISTANCE 82
Dolby Digital 93
Dolby Digital EX 93
Dolby Pro Logic II 93
Dolby Surround Pro Logic 94
DSGX 59
DTS 94
DTS-ES 94
DUAL MONO 71
DVD 94
DVD MENU 78

F

Fast forward 43
Fast reverse 43
File 7, 94
Front Panel 97
Front panel display 98

H

Handling discs 9

I

INDEX 45
Index 7, 94
INTERLACE 94

J

JPEG 36
JPEG DATE 81

L

LANGUAGE SETUP 78
LEVEL 83
Listening to the Radio 73

M

MP3 34
Multi-angle function 60, 95
Multilingual function 51, 95
MUTING 31

N

Neo:6 95
NIGHT MODE 59

O

On-screen display
 Control Menu display 11
OSD 78

P

PARENTAL CONTROL 64, 80,
 95
PBC Playback 33, 95
PLAY MODE 38, 39, 41
Preset Station 72
Program Play 39
PROGRESSIVE 95

R

Radio 73
Rear Panel 100
Region Code 8, 95
Remote 67, 101
REPEAT 42
Resume Play 32

S

S VIDEO 23
Scan 43
SCENE 11
Scene 7, 95
SCREEN SAVER 79
SCREEN SETUP 78
Setup Display 77
SHUFFLE 41
Shuffle Play 41
SIZE 81
SLEEP 75
Slide show 37
Slow-motion 43
Sound Field 53
SPEAKER SETUP 81
Speaker System Hookup 14
SUBTITLE 61, 78
Super Audio CD 95
Surround Back Decoding Mode
 57

T

TEST TONE 83
TIME SEARCH 44
TITLE 44
Title 7, 96
TRACK 44
Track 7, 35, 96
TRACK SELECTION 80
Troubleshooting 88
TV and Video Component
 Hookups 23
TV TYPE 78

U

Usable discs 7

V

VIDEO CD 96

Quick Reference for Remote Commander

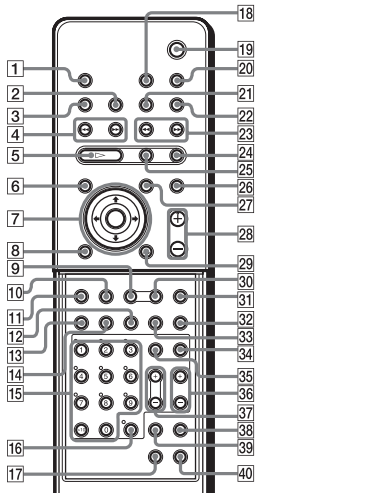

With cover opened.

Note

The remote control of the unit employs command signals in common with other Sony DVD products. Thus, depending on the button, other Sony DVD products may respond.

- 1** Selects a disc for playback.
- 2** Switches the item displayed on the front panel display.
- 3** Sets the system to turn off at a preset time.
- 4** **◀◀/▶▶**: Press to go to the next chapter or track or to go back to the previous chapter or track.
PRESET +/-: Scan all preset stations.
- 5** Plays a disc.
- 6** Displays the title menu on the TV screen.
MP3/JPEG: Selects albums.
- 7** Select and execute the items or settings.
- 8** Displays the Control Menu display on the TV screen to set or adjust the items.
- 9** Select the sound field.
- 10** Bass sound is effectively reinforced.
- 11** Displays the setup display on the TV screen to set or adjust the items.
- 12** Changes the subtitle.
- 13** Changes the sound.
- 14** Changes the angles when playing a DVD.
- 15** Select the items of settings. *TV: Select channel numbers.**
- 16** Executes the items or settings.
- 17** Press to store a preset station. Activates the name function.
- 18** Turns the TV on and off.
- 19** Turns on and off the power of the system.
- 20** Turns the SONY TV and the system on and changes the TV's input source.
- 21** Selects AM or FM band.
- 22** Selects the component you want to use.
- 23** **◀◀/▶▶** (SCAN): Locate a point while monitoring the picture while playing a disc.
◀/▶ SLOW: Play a disc in slow motion in the pause mode.
TUNING +/-: Scan all available radio stations.
- 24** Stops playing a disc.
- 25** Pauses playing a disc.
- 26** Mutes the sound.
- 27** Displays the DVD menu on the TV screen.
MP3/JPEG: Selects albums.
- 28** Adjust the SYSTEM volume.
- 29** Press to return to the previously selected screen, etc.
- 30** Select the sound field.
- 31** Makes sound clear at low volume.
- 32** Selects program or shuffle play mode.
- 33** Displays the repeat status.
- 34** Sets the remote to TV mode.
Normal mode: tuns off.
TV mode: tuns in red.
- 35** Changes the input mode of the TV.
- 36** Select the TV Channel.
- 37** Adjust the TV volume.
- 38** Sets the speaker parameter and changes the brightness of the front panel display by two steps.
- 39** Press to cancel the programmed track, etc.
- 40** Switches monaural or stereo of FM stereo reception.

* Depending on the TV manufacture, the following method also works. Press >10, then the number. (For example, for channel 25, press >10, then 2 and 5.)