

Video Cassette Recorder/ DVD Recorder

Operating Instructions

RDR-VX500

For customers in the U.S.A Owner's Record

The model and serial numbers are located at the rear of the unit. Record the serial number in the space provided below. Refer to them whenever you call upon your Sony dealer regarding this product.

Model No. RDR-VX500

Serial No. _____

For Customers in Canada

If this product is not working properly, please call 1-877-602-2008 for **Peace of Mind Warranty Replacement service.**

For other product related questions please contact our **Customer Information Service Centre** at 1-877-899-7669 or write to us at: Customer Information Service 115 Gordon Baker Road, Toronto, Ontario, M2H 3R6



WARNING

To prevent fire or shock hazard, do not expose the unit to rain or moisture.

To avoid electrical shock, do not open the cabinet. Refer servicing to qualified personnel only.

The AC power cord must be changed only at a qualified service shop only.

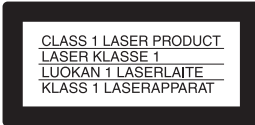

This appliance is classified as a CLASS 1 LASER product. The CLASS 1 LASER PRODUCT MARKING is located on the rear exterior.

CAUTION

The use of optical instruments with this product will increase eye hazard. As the laser beam used in this VCR-DVD recorder is harmful to eyes, do not attempt to disassemble the cabinet. Refer servicing to qualified personnel only.

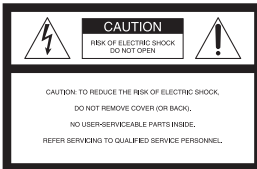

This symbol is intended to alert the user to the presence of uninsulated "dangerous voltage" within the product's enclosure that may be of sufficient magnitude to constitute a risk of electric shock to persons.



This symbol is intended to alert the user to the presence of important operating and maintenance (servicing) instructions in the literature accompanying the appliance.

CAUTION

TO PREVENT ELECTRIC SHOCK, MATCH WIDE BLADE OF PLUG TO WIDE SLOT, FULLY INSERT.

CAUTION

You are cautioned that any change or modifications not expressly approved in this manual could void your authority to operate this equipment.

Note

This equipment has been tested and found to comply with the limits for a Class B digital device, pursuant to Part 15 of the FCC Rules. These limits are designed to provide reasonable protection against harmful interference in a residential installation. This equipment generates, uses, and can radiate radio frequency energy and, if not installed and used in accordance with the instructions, may cause harmful interference to radio communications. However, there is no guarantee that interference will not occur in a particular installation. If this equipment does cause harmful interference to radio or television reception, which can be determined by turning the equipment off and on, the user is encouraged to try to correct the interference by one or more of the following measures:

- Reorient or relocate the receiving antenna.
- Increase the separation between the equipment and receiver.
- Connect the equipment into an outlet on a circuit different from that to which the receiver is connected.
- Consult the dealer or an experienced radio/TV technician for help.

VCR Plus+ and PlusCode are registered trademarks of Gemstar Development Corporation. The VCR Plus+ system is manufactured under license from Gemstar Development Corporation.

Precautions

On safety

Should any solid object or liquid fall into the cabinet, unplug the recorder and have it checked by qualified personnel before operating it any further.

On power sources

- Operate the recorder only on 120 V AC, 60 Hz.
- The recorder is not disconnected from the AC power source as long as it is connected to the wall outlet, even if the recorder itself has been turned off.
- If you are not going to use the recorder for a long time, be sure to disconnect the recorder from the wall outlet. To disconnect the AC power cord, grasp the plug itself; never pull the cord.

On placement

- Place the recorder in a location with adequate ventilation to prevent heat build-up in the recorder.
- If the recorder is brought directly from a cold to a warm location, moisture may condense inside the recorder and cause damage to the video head, tape, and the optical block. When you first install the recorder, or when you move it from a cold to a warm location, wait for about three hours before operating the recorder.
- Do not place the recorder on a soft surface such as a rug that might block the ventilation holes.
- Do not place the recorder in a confined space such as a bookshelf or similar unit.
- Do not place the recorder in a location near heat sources, or in a place subject to direct sunlight, excessive dust, or mechanical shock.
- Do not place the recorder in an inclined position. It is designed to be operated in a horizontal position only.

- Keep the recorder, discs, and cassettes away from equipment with strong magnets, such as microwave ovens, or large loudspeakers.
- Do not place heavy objects on the recorder.
- To prevent fire or shock hazard, do not place objects filled with liquids, such as vases, on the apparatus.

On recording

- Contents of the recording cannot be compensated for if the recording or playback is not made due to a malfunction of the recorder, disc, etc.
- Make trial recordings before making the actual recording.

Copyrights

- Television programs, films, video tapes, discs, and other materials may be copyrighted. Unauthorized recording of such material may be contrary to the provisions of the copyright laws. Also, use of this recorder with cable television transmission may require authorization from the cable television transmitter and/or program owner.
- This product incorporates copyright protection technology that is protected by U.S. patents and other intellectual property rights. Use of this copyright protection technology must be authorized by Macrovision, and is intended for home and other limited viewing uses only unless otherwise authorized by Macrovision. Reverse engineering or disassembly is prohibited.

Hookups and Settings _____

Basic Operation _____

DVD Recording _____

Playing Discs _____

VCR Recording _____

Playing VHS Tapes _____

DVD Editing _____

Dubbing (TAPE ↔ DVD) _____

DV Dubbing (DV → DVD) _____

Settings and Adjustments _____

Additional Information _____

Copy guard function

Since the recorder has a copy guard function, programs received through an external tuner (not supplied) may contain copy protection signals (copy guard function) and as such may not be recordable, depending on the type of signal.

IMPORTANT NOTICE

Caution: This recorder is capable of holding a still video image or on-screen display image on your television screen indefinitely. If you leave the still video image or on-screen display image displayed on your TV for an extended period of time you risk permanent damage to your television screen. Plasma display panels and projection televisions are especially susceptible to this.

If you have any questions or problems concerning your recorder, please consult your nearest Sony dealer.

IMPORTANT SAFETY INSTRUCTIONS

- 1 Read these instructions.
- 2 Keep these instructions.
- 3 Heed all warnings.
- 4 Follow all instructions.
- 5 Do not use this apparatus near water.
- 6 Clean only with dry cloth.
- 7 Do not block any ventilation openings. Install in accordance with the manufacturer's instructions.
- 8 Do not install near any heat sources such as radiators, heat registers, stoves, or other apparatus (including amplifiers) that produce heat.
- 9 Do not defeat the safety purpose of the polarized or grounding-type plug. A polarized plug has two blades with one wider than the other. A grounding type plug has two blades and a third grounding prong. The wide blade or the third prong are provided for your safety. If the provided plug does not fit into your outlet, consult an electrician for replacement of the obsolete outlet.











- 10 Protect the power cord from being walked on or pinched particularly at plugs, convenience receptacles, and the point where they exit from the apparatus.
- 11 Only use attachments/accessories specified by the manufacturer.
- 12 Use only with the cart, stand, tripod, bracket, or table specified by the manufacturer, or sold with the apparatus. When a cart is used, use caution when moving the cart/apparatus combination to avoid injury from tip-over.



- 13 Unplug this apparatus during lightning storms or when unused for long periods of time.
- 14 Refer all servicing to qualified service personnel. Servicing is required when the apparatus has been damaged in any way, such as power-supply cord or plug is damaged, liquid has been spilled or objects have fallen into the apparatus, the apparatus has been exposed to rain or moisture, does not operate normally, or has been dropped.

About this manual

- Instructions in this manual describe the controls on the remote. You can also use the controls on the recorder if they have the same or similar names as those on the remote.
- The on-screen display illustrations used in this manual may not match the graphics displayed on your TV screen.
- The explanations regarding discs created on this recorder. The explanations do not apply to discs that are created on other recorders and played back on this recorder.

Icon	Meaning
	Functions available for DVD+RWs
	Functions available for DVD-RWs in VR (Video Recording) mode
	Functions available for DVD-RWs in video mode
	Functions available for DVD+Rs
	Functions available for DVD-Rs
	Functions available for DVD VIDEOS
	Functions available for VIDEO CDs, Super VCDs or CD-Rs/CD-RWs in video CD format or Super VCD format
	Functions available for music CDs or CD-Rs/CD-RWs in music CD format
	Functions available for DATA CDs (CD-Rs/CD-RWs containing MP3* audio tracks or JPEG files)
	Functions available for VHS VIDEOS

* MP3 (MPEG1 Audio Layer 3) is a standard format defined by ISO/MPEG which compresses audio data.

Table of Contents

WARNING	2
Precautions	3
Ways to Use Your Video Cassette Recorder/DVD Recorder	8
Quick Guide to DVD Disc Types	10
Recordable and playable VHS tapes	14
<hr/>	
Hookups and Settings	15
Hooking Up the Recorder	15
Step 1: Unpacking	15
Step 2: Connecting the Antenna Cable	15
Step 3: Connecting to Your TV	18
Step 4: Connecting to Your AV/Amplifier (Receiver)	23
Step 5: Connecting the Power Cord	26
Step 6: Preparing the Remote	26
Step 7: Easy Setup	30
Setting Up the VCR Plus+® System	32
Connecting Another VCR or Similar Device	34
<hr/>	
Basic Operation	37
Playing a DVD Disc or VHS Tape	37
Recording a Program to a DVD Disc	38
Recording a Program to a VHS Tape	39
Using the On-Screen Menus	40
Using the Title List	42
Using the DVD Disc Setting Displays	43
Checking the Play Information and Playing Time	45
Changing the Name of a Recorded Program (Title Input)	46
<hr/>	
DVD Recording	47
Before Recording	47
DVD Recording without the Timer	48
DVD Timer Recording (Standard/VCR Plus+)	50
Recording from Connected Equipment with a Timer (Synchro Rec)	53
Checking/Changing/Canceling DVD Timer Settings (Timer List)	55
Recording from Connected Equipment without a Timer	56
<hr/>	
Playing Discs	57
Playing	57
Searching for a Title/Chapter/Track, etc.	62
Playing MP3 Audio Tracks	63
Playing JPEG Image Files	64

VCR Recording	67
Before Recording	67
VCR Recording without the Timer	67
VCR Timer Recording (Standard/VCR Plus+)	69
Recording from Connected Equipment with a Timer (Synchro Rec)	72
Checking/Changing/Canceling VCR Timer Settings (Timer List)	74
Recording from Connected Equipment without a Timer	75
<hr/>	
Playing VHS Tapes	76
Playing	76
Searching Using Various Functions	79
Selecting the sound during playback	80
<hr/>	
DVD Editing	81
Before Editing	81
Editing a Title	82
Creating a Playlist	84
Editing a Playlist	86
<hr/>	
Dubbing (TAPE ↔ DVD)	89
Dubbing from a Video to a DVD	89
Dubbing from a DVD to a Video	91
<hr/>	
DV Dubbing (DV → DVD)	93
Before DV Dubbing	93
Connecting a Digital Video Camera to the DV IN Jack	93
Dubbing from a DV Format Tape to a DVD	94
<hr/>	
Settings and Adjustments	96
Using the Setup Displays	96
Antenna Reception Setting (Tuner Preset)	97
Clock Setting (Clock Set)	99
Video Settings (Video)	100
Audio Settings (Audio)	102
Recording and VCR Settings (Features)	104
Language, Parental Control Settings/Factory Settings (Options)	105
Easy Setup (Resetting the Recorder)	107
<hr/>	
Additional Information	108
Troubleshooting	108
Notes About This Recorder	113
Specifications	114
About i.LINK	115
Guide to Parts and Controls	117
Glossary	122
DVD Audio/Subtitle Language	123
Index	124

Ways to Use Your Video Cassette Recorder/DVD Recorder

What is a Video Cassette Recorder/DVD Recorder?

- ➔ This is a DVD recorder with built-in VHS video deck. It allows recording to DVD+RWs, DVD+Rs, DVD-RWs, DVD-Rs, and VHS tapes. In addition, you can also enjoy playback and editing of DVD discs and VHS tapes.

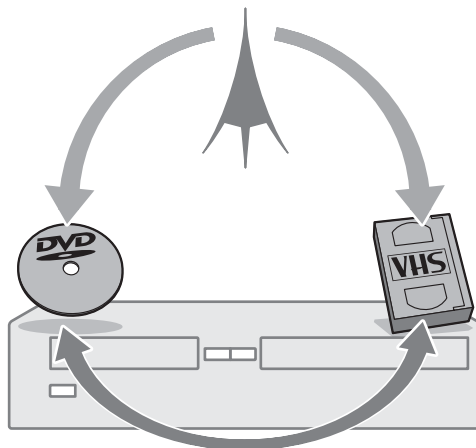

Operation restrictions

Current operation	Possible simultaneous operations			
	VHS		DVD	
	Playback	Recording	Playback	Recording
Playing a VHS tape	—	No	Yes ^{*1}	Yes ^{*1}
Recording on a VHS tape	No	—	Yes	Yes
Playing a DVD disc	Yes ^{*2}	Yes ^{*2}	—	No
Recording on a DVD disc	Yes	Yes	No	—

^{*1} When pressing DVD, VHS tape playback stops.

^{*2} When pressing VIDEO, DVD playback stops.

Quick access to recorded titles – Title List

- ➔ Display the Title List to see all of the titles on the disc, including the recording date, channel, recording mode, recording time and movie thumbnail image (page 42).

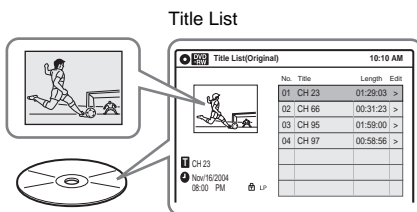

Creating your own program – Playlist

- ➔ Record a program on a DVD-RW (VR mode), then erase, move and add scenes at will to create your own, original program (page 84).

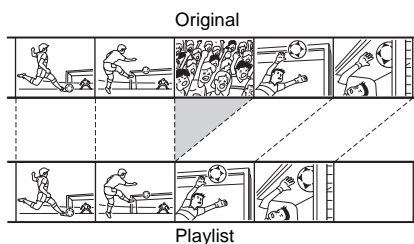

One touch button dubbing from VCR to DVD

- ➔ This recorder lets you dub from VHS tape to DVD and from DVD to VHS tape with a single deck (page 89).

* Note that when playing back and recording a DVD or VHS tape that includes a copy protect signal, the copy protect function will prevent normal recording.

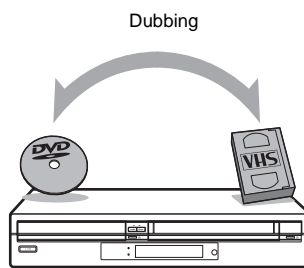

Simple dubbing of DV tapes – DV Edit



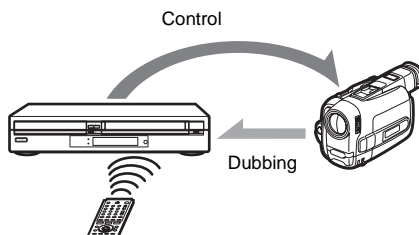





- ➔ Connect your digital video camera to the DV IN jack and simply dub the entire contents or just selected scenes to a DVD disc (page 93).



A list of recordable and playable DVD discs is on page 10.

Quick Guide to DVD Disc Types

Recordable and playable discs

Type		Disc Logo	Icon used in this manual	Formatting (new discs)	Compatibility with other DVD players (finalizing)
DVD+RW		 DVD+ReWritable		Automatically formatted	Playable on DVD+RW compatible players (automatically finalized)
DVD-RW	VR mode			Format in VR mode ^{*2} (page 43)	Playable only on VR mode compatible players (finalization unnecessary) (page 44)
	Video mode			Format in Video mode ^{*2} (page 43)	Playable on most DVD players (finalization necessary) (page 44)
DVD+R		 DVD+R		Automatically formatted	Playable on DVD+R compatible players (finalization necessary) (page 44)
DVD-R		 R R4.7		Automatically formatted	Playable on most DVD players (finalization necessary) (page 44)

Usable disc versions (as of June 2004)

- 4x-speed or slower DVD+RWs
- 2x-speed or slower DVD-RWs (Ver.1.1, Ver.1.1 with CPRM^{*1})
- 4x-speed or slower DVD-RWs (Ver.1.2, Ver.1.2 with CPRM)
- 8x-speed or slower DVD+Rs
- 8x-speed or slower DVD-Rs (Ver.2.0)

“DVD+RW,” “DVD-RW,” “DVD+R,” and “DVD-R,” are trademarks.

^{*1} CPRM (Content Protection for Recordable Media) is a coding technology that protects copyrights for images.

^{*2} Unused DVD-RWs are formatted in VR mode automatically.

^{*3} Erasing titles only frees up disc space if you erase the last title.

^{*4} Erasing titles does not free up disc space.

	Recording Features			Editing Features			
	Rewrite (page 48)	Auto Chapter (page 104)	Manual Chapter (page 84)	Change title name (page 82)	Erase title (page 82)	A-B Erase (page 83)	Playlist (page 84)
	Yes	Yes	Yes	Yes	Yes* ³	No	No
	Yes	Yes	Yes	Yes	Yes	Yes	Yes
	Yes	Yes	No	Yes	Yes* ³	No	No
	No	Yes	No	Yes	Yes* ⁴	No	No
	No	Yes	No	Yes	Yes* ⁴	No	No









Discs that cannot be recorded on

- DVD-RWs (Ver.1.0)
- DVD+RWs that are not 2.4x-speed compatible
- Double layer discs
- 8 cm discs

12 cm/8 cm discs

Operation	DVD+RW		DVD-RW				DVD+R		DVD-R	
			VR mode		Video mode					
	12 cm	8 cm	12 cm	8 cm	12 cm	8 cm	12 cm	8 cm	12 cm	8 cm
Playback	Yes	—	Yes	Yes	Yes	Yes	Yes	—	Yes	Yes
Recording	Yes	—	Yes	No	Yes	No	Yes	—	Yes	No

Playable discs

Type	Disc Logo	Icon used in this manual	Characteristics
DVD VIDEO			Discs such as movies that can be purchased or rented
VIDEO CD			VIDEO CDs or CD-Rs/CD-RWs in VIDEO CD/ Super VIDEO CD format (with PBC function)
CD			Music CDs or CD-Rs/CD-RWs in music CD format that can be purchased
DATA CD			CD-Rs/CD-RWs created on a PC or similar device in music format, or MP3 or JPEG format that conforms to ISO9660* Level 1/Level 2

* A logical format of files and folders on DATA-CDs, defined by ISO (International Standard Organization).

Discs that cannot be played

- CD-Rs/CD-RWs, other than those recorded in music CD format, MP3 or JPEG format, or Video CD format
- Data part of CD-Extras
- DVD-ROMs
- DVD Audio discs
- DVD-RAMs
- HD layer on Super Audio CDs

- DVD VIDEOS with a different region code (see page 13)
- A disc recorded in a color system other than NTSC, such as PAL or SECAM

Hint

This DVD recorder can play 8 cm CDs and 8 cm DVDs as well.

Note on playback operations of DVD VIDEOS/ VIDEO CDs

Some playback operations of DVD VIDEOS/ VIDEO CDs may be intentionally set by software producers. Since this recorder plays DVD VIDEOS/VIDEO CDs according to the disc contents the software producers designed, some playback features may not be available. Also, see the instructions supplied with the DVD VIDEOS/ VIDEO CDs.

Region code (DVD VIDEO only)

Your recorder has a region code printed on the rear of the unit and will only play DVD VIDEOS (playback only) labeled with identical region codes. This system is used to protect copyrights. DVD VIDEOS labeled  will also play on this recorder.

If you try to play any other DVD VIDEO, the message "Please check the Regional code of this disc." will appear on the TV screen. Depending on the DVD VIDEO, no region code indication may be labeled even though playing the DVD VIDEO is prohibited by area restrictions.

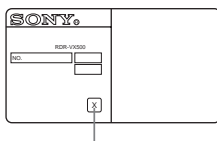

Region code

Music discs encoded with copyright protection technologies

This product is designed to playback discs that conform to the Compact Disc (CD) standard. Recently, various music discs encoded with copyright protection technologies are being marketed by some record companies. Please be aware that among those discs, there are some that do not conform to the CD standard and may not be playable by this product.

Notes

- Some DVD+RWs/DVD+Rs, DVD-RWs/DVD-Rs, or CD-RWs/CD-Rs cannot be played on this recorder due to the recording quality or physical condition of the disc, or the characteristics of the recording device and authoring software. The disc will not play if it has not been correctly finalized. For more information, see the operating instructions for the recording device.
- You cannot mix VR mode and Video mode on the same DVD-RW. To change the disc's format, reformat the disc (page 43). Note that the disc's contents will be erased after reformatting.
- You cannot shorten the time required for recording even with high-speed discs. Also, you cannot record on the disc if the disc is not 1x speed compatible.
- It is recommended that you use discs with "For Video" printed on their packaging.
- You cannot add new recordings to DVD-Rs or DVD-RWs (Video mode) that contain recordings made on other DVD equipment.
- In some cases, you may not be able to add new recordings to DVD+RWs that contain recordings made on other DVD equipment. If you do add a new recording, note that this recorder will rewrite the DVD menu.
- If the disc contains PC data unrecognizable by this recorder, the data may be erased.

Recordable and playable VHS tapes

This VCR uses the VHS system.

Recording

This VCR records using the VHS system.

Hint

If you do not want recorded contents to be erased, break off the erasure prevention tab. To record again on a tape that has had the erasure prevention tab removed, cover the hole with cellophane tape, etc.

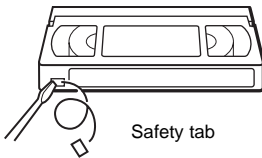

Notes

- This VCR cannot record using the S-VHS system.
- Tapes recorded in EP (3×) mode by this VCR cannot be played back on standard mode only VHS decks.
- Noise may appear in the image when tapes recorded in EP (3×) mode by this VCR are played back on other VHS decks with 3× mode.

Playback

The VCR automatically identifies the recording system and recording mode (SP (standard) or EP (3×)) of recorded tapes during playback.

Notes

- You cannot play back foreign video software that uses non-NTSC color TV systems (PAL, SECAM).
- When playing back tapes recorded using the S-VHS system, the playback image may be disturbed.

Hooking Up the Recorder

Follow steps 1 to 7 to hook up and adjust the settings of the recorder.

Notes

- Plug cords securely to prevent unwanted noise.
- Refer to the instructions supplied with the components to be connected.
- Be sure to disconnect the power cord of each component before connecting.

Step 1: Unpacking

Check that you have the following items:

- Audio/video cord
(pinplug × 3 ↔ pinplug × 3) (1)
- Antenna cable (1)
- Remote commander (remote) (1)
- Size AA (R6) batteries (2)

Step 2: Connecting the Antenna Cable

Select one of the following antenna hookups. Do not connect the power cord until you reach “Connecting the Power Cord” on page 26.

If you have	Hookup
Cable box or satellite receiver with a video/audio output	A (page 16)
Cable box with an antenna output only	B (page 17)
Cable without cable box, or antenna only (no cable TV)	C (page 17)

Note to CATV system installer (in USA)

This reminder is provided to call the CATV system installer’s attention to Article 820- 40 of the NEC that provides guidelines for proper grounding and, in particular, specifies that the cable ground shall be connected to the grounding system of the building, as close to the point of cable entry as practical.

Notes

- If your antenna is a flat cable (300-ohm twin lead cable), use an external antenna connector (not supplied) to connect the antenna to the recorder.
- If you have separate cables for VHF and UHF antennas, use a UHF/VHF band mixer (not supplied) to connect the antenna to the recorder.

A: Cable box or satellite receiver with a video/audio output

With this hookup, you can record any channel on the cable box or satellite receiver. Be sure that the satellite receiver or cable box is turned on.

To watch cable or satellite programs, you need to match the channel on the recorder (L1) to the input jack connected to the cable box or satellite receiver (LINE 1 IN).

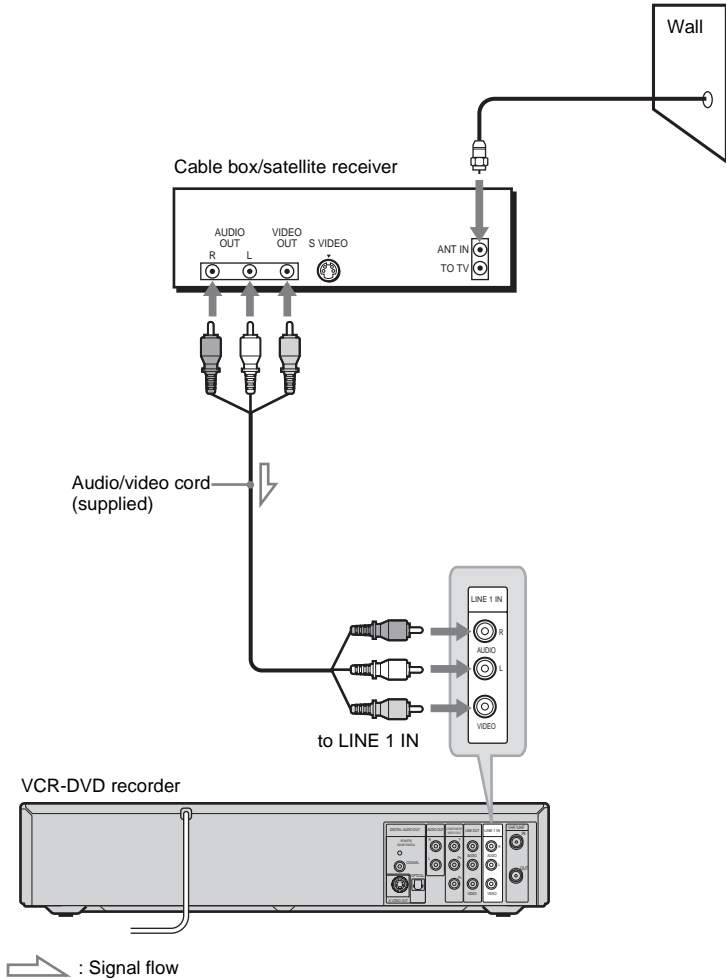

B: Cable box with an antenna output only

With this hookup, you can record any channel on the satellite receiver or cable box. Be sure that the satellite receiver or cable box is turned on.

To watch cable programs, you need to match the channel on the recorder (2ch, 3ch or 4ch) to the antenna output channel on the cable box (2ch, 3ch or 4ch).

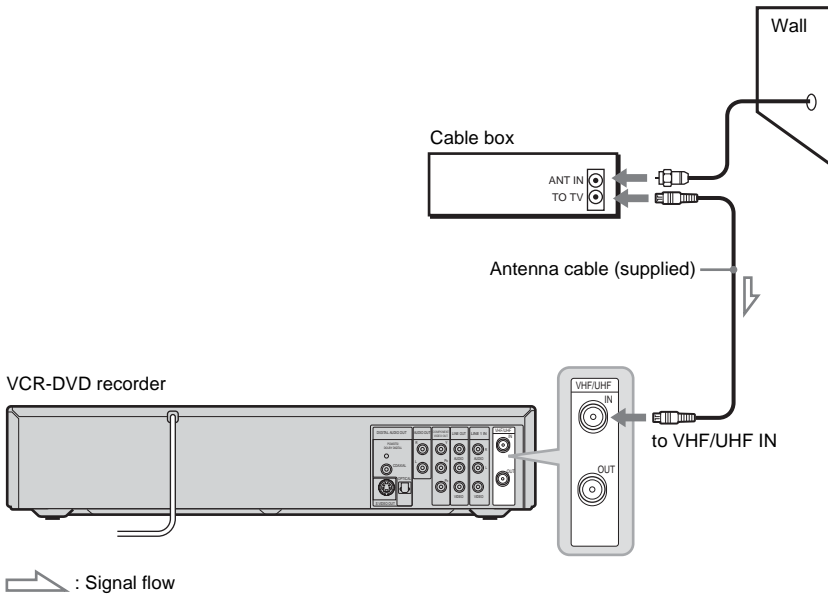

C: Cable without cable box, or antenna only (no cable TV)

Use this hookup if you watch cable channels without a cable box. Also use this hookup if you are using a VHF/UHF antenna or separate VHF and UHF antennas.

With this hookup, you can record any channel by selecting the channel on the recorder.

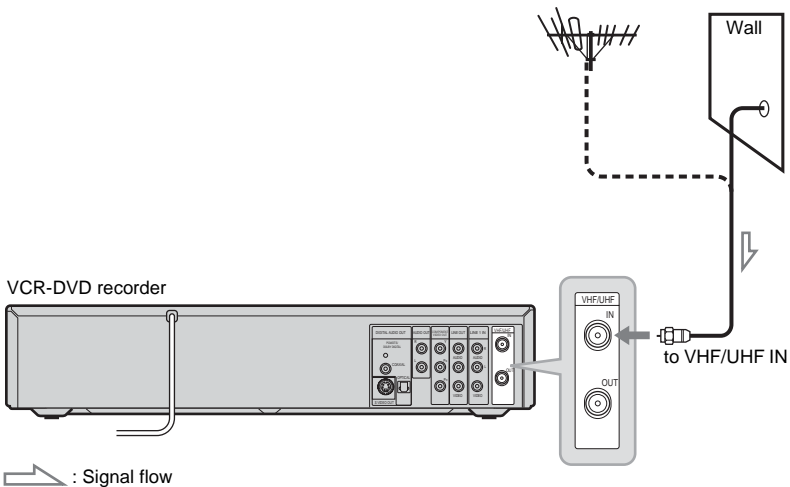

Step 3: Connecting to Your TV

Select one of the following patterns **A** or **B**, according to the input jack on your TV.

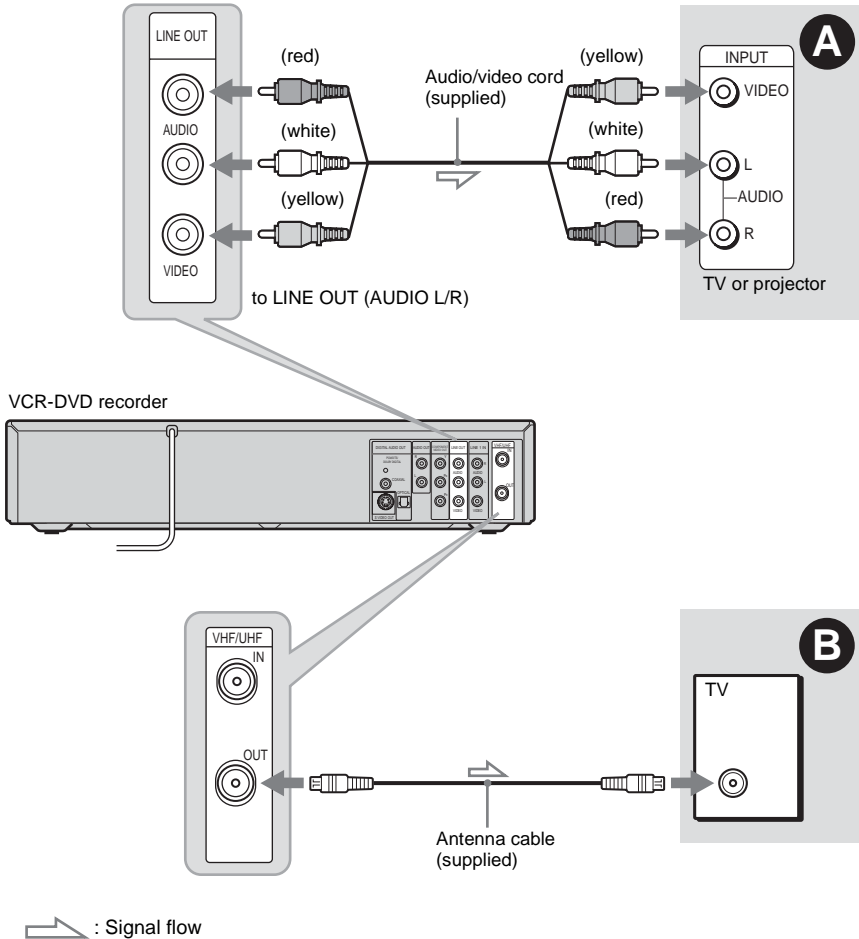

Note

Do not connect more than one type of video cord between the recorder and your TV at the same time.

A Connecting to audio/video input jacks

If your TV, monitor, projector, or other equipment has audio/video (A/V) input jacks, you will get better picture and sound if you connect the recorder using this connection.

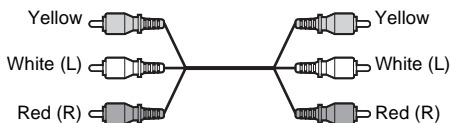

B Connecting to an antenna input jack

If your TV does not have audio/video (A/V) input jack, connect the recorder to a TV using an antenna cable.



Setting the RF Output channel

When connecting the recorder to the TV using only the antenna cable, you must set the RF Output channel in the “Tuner Preset” so that the TV can receive the correct signal from the recorder.

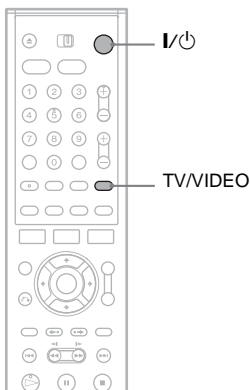

- 1 Press **I/Power** to turn on the recorder.
- 2 Press **TV/VIDEO** repeatedly until “TV” disappears from the front panel display.
- 3 Turn on your TV and set it to the channel 3. When using channel 4 to receive the recorder signal, see “3, 4 Ch Out” on page 98.

If your TV has an S video input jack

Connect an S video cord (not supplied). You will enjoy high quality images.

Make audio connections using the AUDIO OUT L/R jacks when you connect the recorder using this connection.

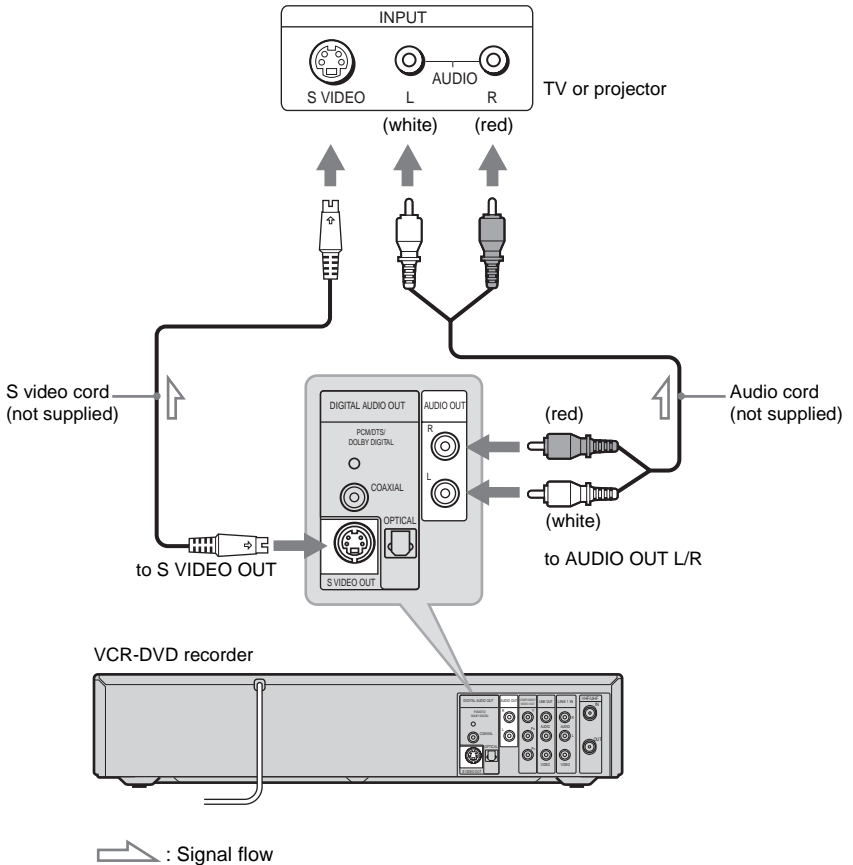

Notes

- Do not connect more than one type of video cord between the recorder and your TV at the same time.
- When recording a DVD, the DVD video signal is output to the S VIDEO OUT even if you switch the output to VIDEO.

If your TV has component video input jacks

Connect the COMPONENT VIDEO OUT jacks using a component video cord (not supplied) or three video cords (not supplied) of the same kind and length. You will enjoy accurate color reproduction and high quality images.

If your TV accepts progressive 480p format signals, you must use this connection and then set “Progressive” of “Video” to “On” in the “Setup” display (page 101). The PROGRESSIVE indicator lights up when the recorder outputs progressive signals.

Make audio connections using the AUDIO OUT L/R jacks when you connect the recorder using this connection.

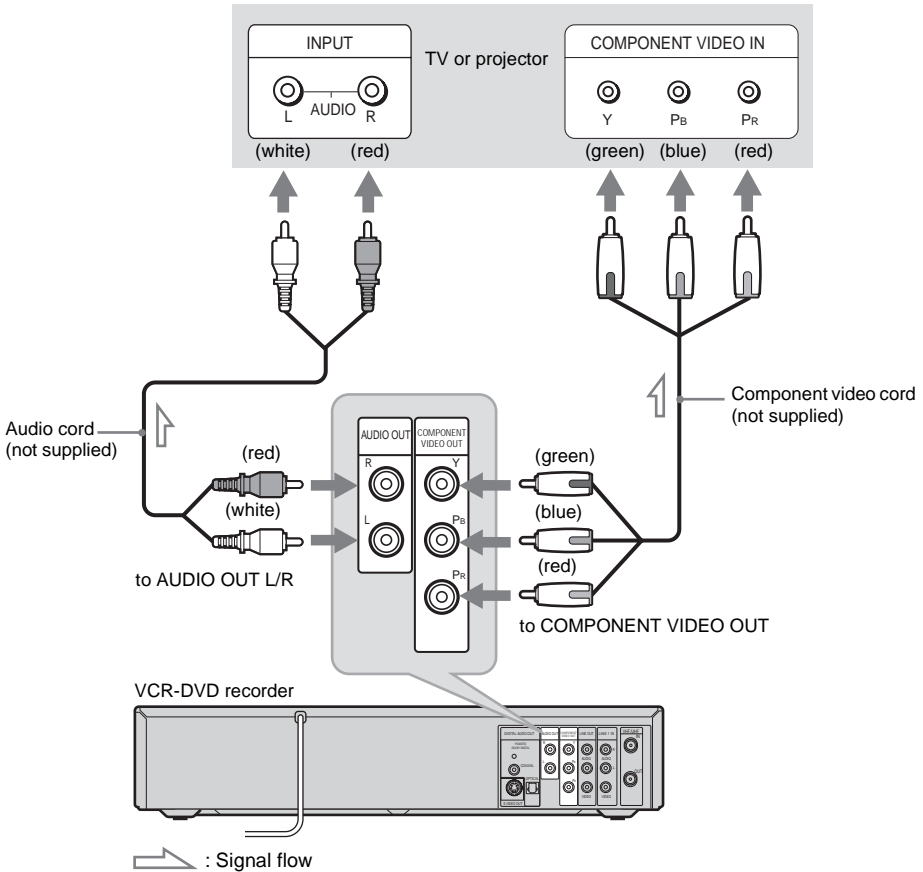

When playing “wide screen” images

Some recorded images may not fit your TV screen. To change the aspect ratio, see page 100.

Hint

Video signal can also be output from the COMPONENT VIDEO OUT jack when playing a VHS tape.

Notes

- Consumers should note that not all high definition television sets are fully compatible with this product and may cause artifacts to be displayed in the picture. In the case of 480 progressive scan picture problems, it is recommended that the user switch the connection to the 'standard definition' output. If there are questions regarding our TV set compatibility with this model 480p DVD recorder, please contact our customer service center.
- When recording a DVD, the DVD video signal is output to the COMPONENT VIDEO OUT even if you switch the output to VIDEO.

Step 4: Connecting to Your AV/Amplifier (Receiver)

Select one of the following patterns **A** or **B**, according to the input jack on your AV amplifier (receiver). This will enable you to listen to DVD audio tracks through your AV amplifier (receiver).

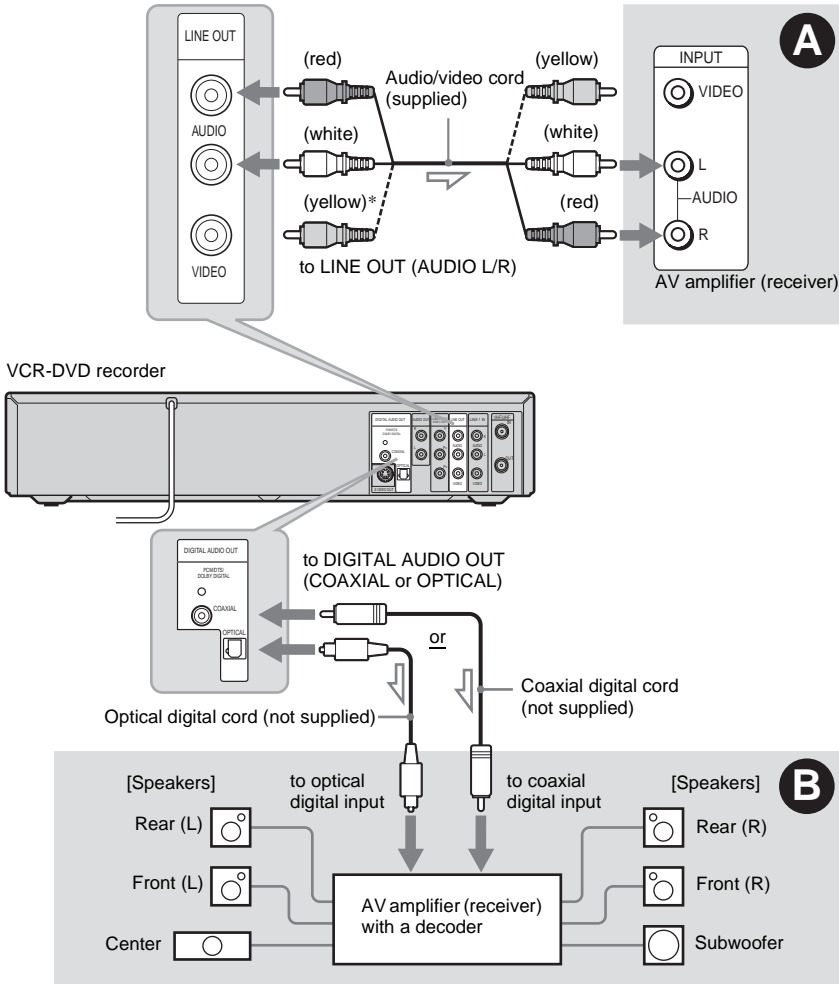

* The yellow plug is used for video signals (page 18).

Hints

- For correct speaker location, see the operating instructions supplied with the connected components.
- Digital audio signal can also be output when playing a VHS tape.

Notes

- Do not connect your TV's audio output jacks to the LINE IN (AUDIO L/R) jacks at the same time. This will cause unwanted noise to come from your TV's speakers.
- When recording a DVD, the DVD video signal is output to the DIGITAL AUDIO OUT even if you switch the output to VIDEO.

A Connecting to audio L/R input jacks

This connection will use your TV's or stereo amplifier's (receiver's) two speakers for sound. Connect using the audio/video cord (supplied).

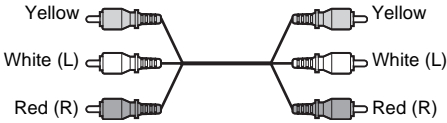

- Surround effect (page 60)
Surround1

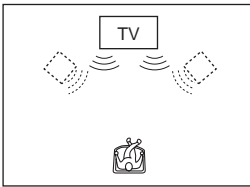

Surround2

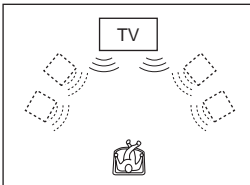

Surround3

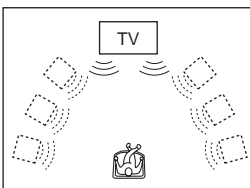

 : Virtual speaker

Note

Do not connect your TV's audio output jacks to the LINE IN (AUDIO L/R) jacks at the same time. This will cause unwanted noise to come from your TV's speakers.

B Connecting to a digital audio input jack

If your AV amplifier (receiver) has a Dolby*¹ Digital or DTS*² decoder and a digital input jack, use this connection.

Connect using a coaxial or optical digital cord (not supplied).

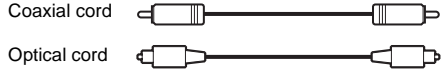

- Surround effect
Dolby Digital (5.1ch), DTS (5.1ch)

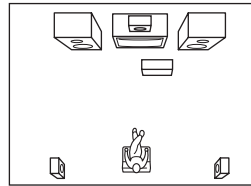

*¹ Manufactured under license from Dolby Laboratories. "Dolby," "Pro Logic," and the double-D symbol are trademarks of Dolby Laboratories.

*² "DTS" and "DTS Digital Out" are trademarks of Digital Theater Systems, Inc.

Notes

- After you have completed the connection, make the appropriate settings under "Audio Connection Setup" in Easy Setup (page 30). Otherwise, no sound or a loud noise will come from your speakers.
- The surround sound effects of this recorder cannot be used when you connect using a coaxial or optical digital cord.
- This recorder does not support Linear PCM playback with 2 channels or more.

Step 5: Connecting the Power Cord

Plug the recorder and TV power cords into an AC outlet. After you connect the power cord, **you must wait for a short while before operating the recorder.** You can operate the recorder only after the front panel display lights up and the recorder enters standby mode.

If you connect additional equipment to this recorder (page 34), be sure to connect the power cord only after all connections are complete.

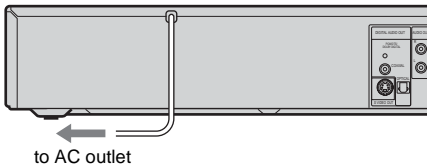

Step 6: Preparing the Remote

You can control the recorder using the supplied remote. Insert two size AA (R6) batteries by matching the ⊕ and ⊖ ends on the batteries to the markings inside the battery compartment. When using the remote, point it at the remote sensor  on the recorder.

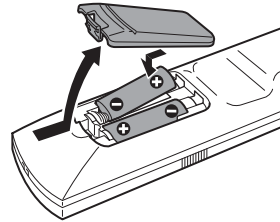

Notes

- If the supplied remote interferes your other Sony DVD Player/Video Cassette Recorder or Video Cassette Recorder/DVD Recorder, change the command mode number for this recorder (page 29).
- Use the batteries correctly to avoid possible leakage and corrosion. Do not touch the liquid with bare hands should leakage occur. Observe the following:
 - Do not use a new battery with an old battery, or batteries of different manufacturers.
 - Do not attempt to recharge the batteries.
 - If you do not intend to use the remote for an extended period of time, remove the batteries.
 - If battery leakage occurs, wipe out any liquid inside the battery compartment, and insert new batteries.
- Do not expose the remote sensor (marked  on the front panel) to strong light, such as direct sunlight or lighting apparatus. The recorder may not respond to the remote.
- With normal use, the batteries should last about three to six months.
- Do not leave the remote in an extremely hot or humid place.
- Do not drop any foreign object into the remote casing, particularly when replacing the batteries.

Controlling TVs with the remote

You can adjust the remote control's signal to control your TV.

If you connected the recorder to an AV amplifier (receiver), you can also use the supplied remote to control the AV amplifier's (receiver's) volume.

Notes

- Depending on the connected unit, you may not be able to control your TV or AV amplifier (receiver) with some or all of the buttons below.
- If you enter a new code number, the code number previously entered will be erased.
- When you replace the batteries of the remote, the code number may be reset to the default setting. Set the appropriate code number again.

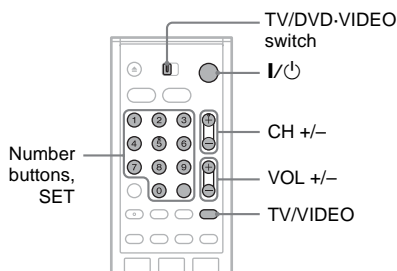

- 1 Slide the TV/DVD-VIDEO switch to TV.
- 2 Hold down I/⏻.
- 3 Enter your TV's manufacturer code (see below) using the number buttons.
- 4 Release I/⏻.

When the TV/DVD-VIDEO switch is set to TV, the remote performs the following:

Press	To
I/⏻	Turn your TV on or off
VOL +/-	Adjust the volume of your TV
CH +/-	Select the channel on your TV
TV/VIDEO	Switch your TV's input source
Number buttons and SET	Select the channel on your TV

Code numbers of controllable TVs

If more than one code number is listed, try entering them one at a time until you find the one that works with your TV.

Manufacturer	Code number
Sony	01 (default)
Akai	04
AOC	04
Centurion	12
Coronado	03
Curtis-Mathes	12, 14
Daewoo	04, 22
Daytron	03, 12
Fisher	11
General Electric	04, 06, 10
Hitachi	02, 03, 04
J.C.Penney	04, 10, 12
JVC	09
KMC	03
LG/Gold Star	03, 04, 17
Magnavox	03, 04, 08, 12, 21
Marantz	04, 13
MGA/Mitsubishi	04, 12, 13, 17
NEC	04, 12
Panasonic	06, 19
Philco	02, 03, 04, 08
Philips	08, 21
Pioneer	06, 16
Portland	03
Proscan	10
Quasar	06, 18
Radio Shack	05, 10, 14
RCA	04, 10
Sampo	12
Samsung	03, 04, 12, 20
Sanyo	11, 14
Scott	12
Sears	07, 10, 11
Sharp	03, 05, 18

Manufacturer	Code number
Sylvania	08, 12
Teknika	03, 08, 14
Toshiba	07, 18
Wards	03, 04, 12
Yorx	12
Zenith	14, 15

Controlling the volume of your AV amplifier (receiver) with the remote

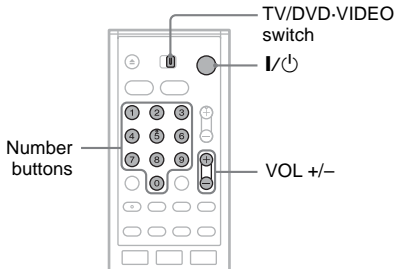

- 1 Slide the TV/DVD-VIDEO switch to DVD-VIDEO.
- 2 Hold down I/⏻, and enter the manufacturer code (see the table below) for your AV amplifier (receiver) using the number buttons.
- 3 Release I/⏻.

The VOL +/- buttons control the AV amplifier's volume.

If you want to control the TV's volume, slide the TV/DVD-VIDEO switch to TV.

Code numbers of controllable AV amplifiers (receivers)

If more than one code number is listed, try entering them one at a time until you find the one that works with your AV amplifier (receiver).

Manufacturer	Code number
Sony	78, 79, 80, 91
Denon	84, 85, 86
Kenwood	92, 93
Onkyo	81, 82, 83
Pioneer	99
Sansui	87
Technics	97, 98
Yamaha	94, 95, 96

Hint

If you want to control the TV's volume even when the TV/DVD-VIDEO switch is set to DVD-VIDEO, repeat the steps above and enter the code number 90 (default).

If you have a Sony DVD Player/Video Cassette Recorder or Video Cassette Recorder/DVD Recorder

If the supplied remote interferes with your other Sony DVD Player/Video Cassette Recorder or Video Cassette Recorder/DVD Recorder, set the command mode number for this recorder and the supplied remote to one that differs from the other Sony DVD Player/Video Cassette Recorder or Video Cassette Recorder/DVD Recorder. The default command mode setting for this recorder and the supplied remote is DVD COMBO3.

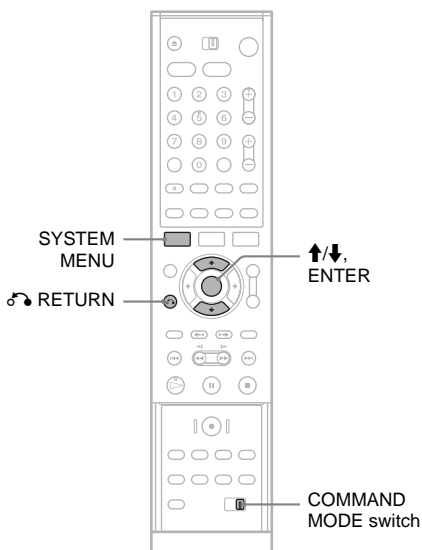

- 1 Press **SYSTEM MENU**.
The System Menu appears.
- 2 Select **"Setup,"** and press **ENTER**.

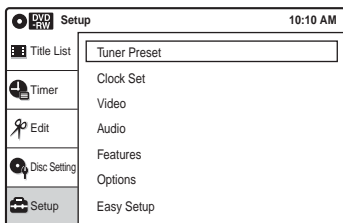

- 3 Select **"Options,"** and press **ENTER**.

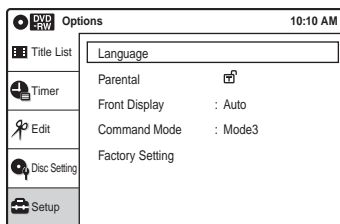

- 4 Select **"Command Mode,"** and press **ENTER**.

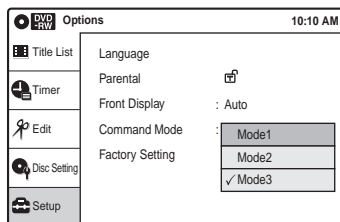

- 5 Select the command mode (**"Mode1,"** **"Mode2,"** or **"Mode3"**), and press **ENTER**.
- 6 Slide the **COMMAND MODE** switch on the remote so it matches the mode you selected above.

To return to the previous display
Press **RETURN**.

Step 7: Easy Setup

Follow the steps below to make the minimum number of basic adjustments for using the recorder. If you do not complete Easy Setup, it will appear each time you turn on your recorder. Settings are made in the following order.

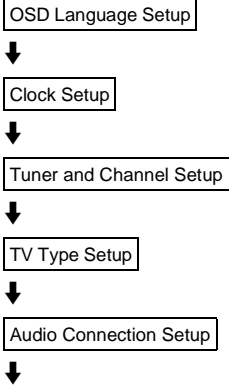

Finished!

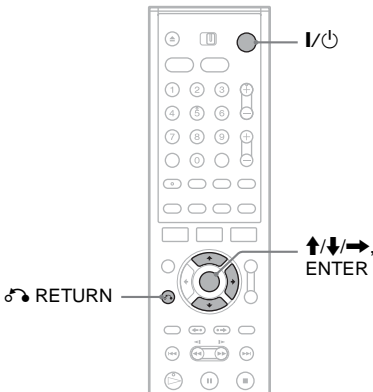

- 1 Turn on the TV.
- 2 Press I/Power.
The recorder turns on.
- 3 Switch the input selector on your TV so that the signal from the recorder appears on your TV screen.
When connecting the recorder to the TV using only the antenna cable, see “Setting the RF Output channel” on page 19.
“Initial setting necessary to operate the DVD recorder will be made. You can change them later using Setup.” appears.
 - If this message does not appear, select “Easy Setup” in the “Setup” display to run Easy Setup (page 107).
- 4 Press ENTER.
The setup display for selecting the language used in the on-screen display appears.

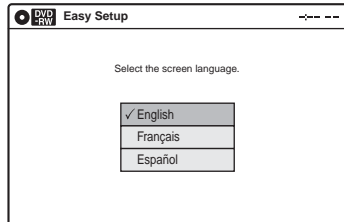

- 5 Select a language, and press ENTER.
The setup display for clock setting appears.

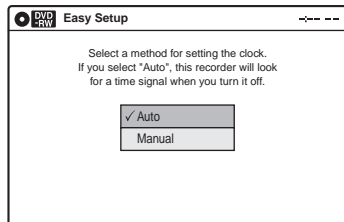

6 Select “Auto,” and press ENTER.

The recorder will automatically search for a channel that carries a time signal when you turn off the recorder after finishing Easy Setup.

- If broadcasters in your area are not yet sending time signals, select “Manual,” and press ENTER. Press \uparrow/\downarrow to set the month and press \rightarrow . Set the day, year, hour, minutes, and AM/PM in the same way. The day of the week is set automatically.

7 Select whether or not you have a cable connection.

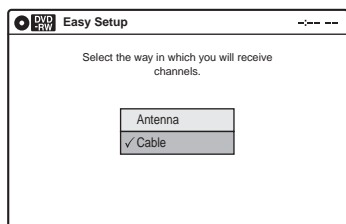

If you use an antenna only (no cable TV), select “Antenna.”

If you use a cable connection without a cable box, select “Cable.”

8 Press ENTER.

The Tuner Preset function automatically starts searching for all of the receivable channels and presets them.

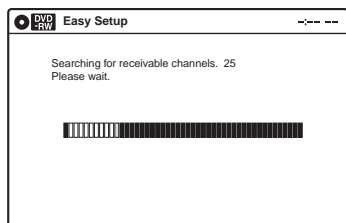

To set the channels manually, see page 98. After the Tuner Preset is finished, the setup display for selecting the aspect ratio of the connected TV appears.

9 Select the setting that matches your TV type.

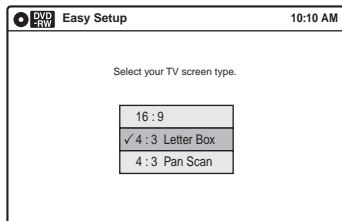

“4:3 Letter Box”: For standard TVs.

Displays “wide screen” pictures with bands on the upper and lower sections of the screen.

“4:3 Pan Scan”: For standard TVs.

Automatically displays “wide screen” pictures on the entire screen and cuts off the sections that do not fit.

“16:9”: For wide-screen TVs or standard TVs with a wide screen mode.

For details, see “Video Settings (Video)” on page 100.

10 Press ENTER.

The setup display for selecting the type of Dolby Digital signal appears.

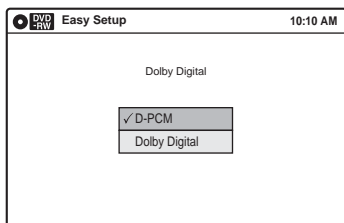

11 Select the type of Dolby Digital signal you want to send to your amplifier (receiver).

If your AV amplifier (receiver) has a Dolby Digital decoder, select “Dolby Digital.” Otherwise, select “D-PCM.”

12 Press ENTER.

The setup display for selecting the type of DTS signal appears.

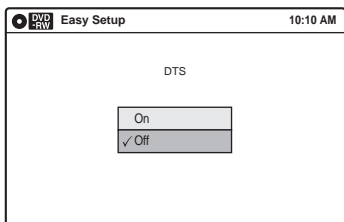

- 13** Select whether or not you want to send a DTS signal to your amplifier (receiver), and press ENTER.
If your AV amplifier (receiver) has a DTS decoder, select “On.” Otherwise, select “Off.”

- 14** Press ENTER when “Finish” appears.
Easy Setup is finished. All connections and setup operations are complete.

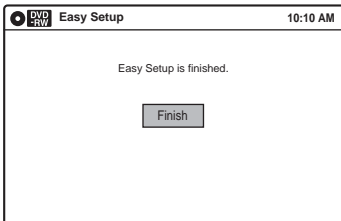

To return to the previous display

Press RETURN.

Hint

If you want to run Easy Setup again, select “Easy Setup” in the “Setup” display (page 107).

Note

To record TV programs using the timer, you must set the clock accurately.

Setting Up the VCR Plus+® System

Setting up your recorder involves coordinating the TV channel number (the number you turn to on your TV or recorder to watch a program) with the guide channel (the number that’s assigned to that channel in your TV program guide).

To find the guide channel numbers, look at the “Channel Line-up Chart” in the program guide for your area that features VCR PlusCode numbers. Use the Channel Line-up Chart to coordinate the guide channel number with the TV channel number. For example, if HBO is listed in the Channel Line-up Chart as channel 33, and the recorder receives HBO on channel 5, coordinate these numbers using the following procedure.

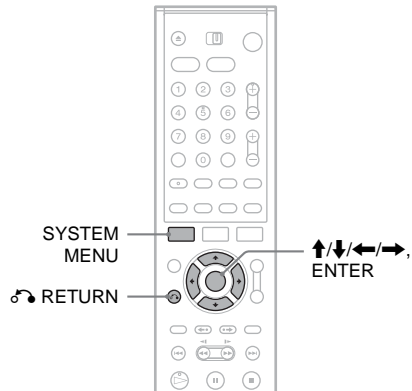

- 1** Press SYSTEM MENU while the recorder is stopped.

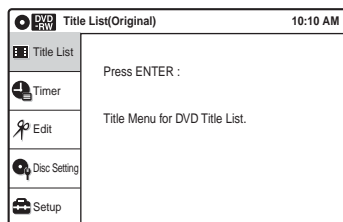

- 2 Select "Setup," and press ENTER.

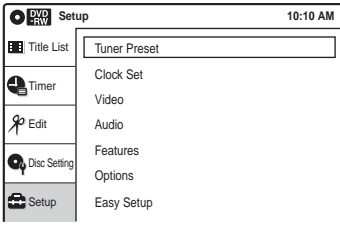

- 3 Select "Tuner Preset," and press ENTER.

- 4 Select "Guide Channel Setup," and press ENTER.

The upper row shows VCR Plus+ guide channels assigned in the program guide and the lower row shows TV channels or cable box or satellite receiver output channels.

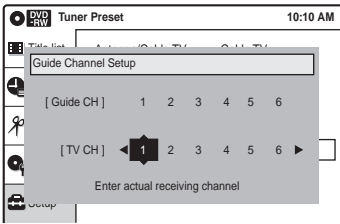

- 5 Select the channel number that does not match the guide channel using ←/→.

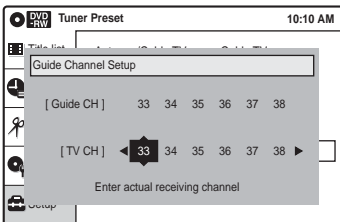

- 6 Enter the TV channel number using ↑/↓.

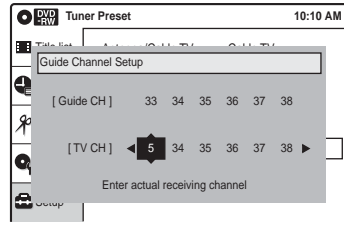

If you made Hookup A (page 16) or Hookup C (page 17) enter the actual channel number on your TV (and the recorder).

If you made Hookup B (page 17) enter the cable box output channel (Usually 2ch, 3ch, or 4ch). See the instructions supplied with your cable box to confirm the cable box's output channel.

- 7 Repeat steps 5 and 6 for each guide channel number that does not match the TV channel number.

- 8 Press SYSTEM MENU to exit the menu.

To return to the previous display
Press RETURN.

Connecting Another VCR or Similar Device

After disconnecting the recorder's power cord from an AC outlet, connect other VCR or similar recording device to the LINE IN jacks of this recorder.

See also the instruction manual supplied with the connected equipment.

To record on this recorder, see "Recording from Connected Equipment with a Timer (Synchro Rec)" on page 53 and page 72. Connect the equipment to the LINE 1 IN jacks of the recorder to record using the Synchro Rec function.

Connecting to the LINE 2 IN jacks on the front panel

Connect other VCR or similar device to the LINE 2 IN jacks of this recorder. If the equipment has an S video jack, you can use an S video cord instead of an audio/video cord.

You can connect a second DVD player and record DVDs.

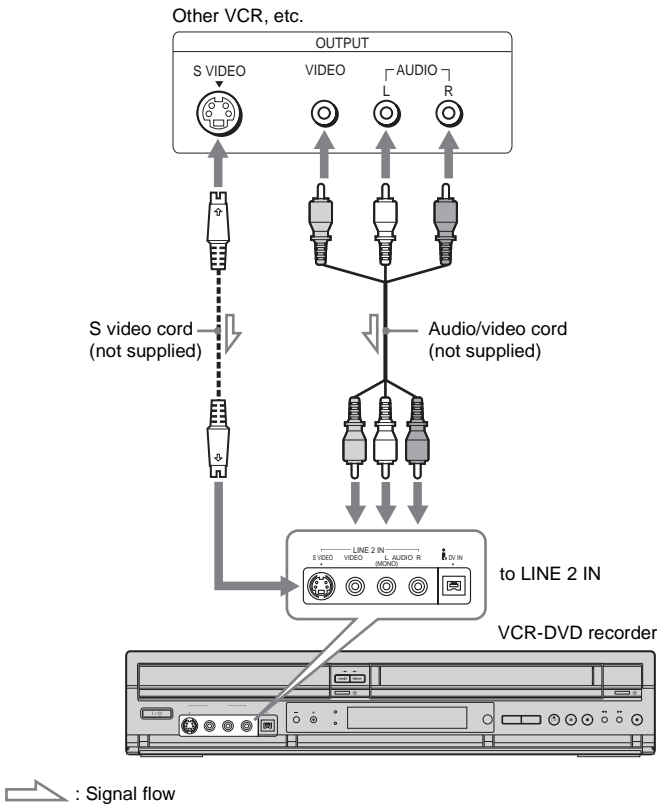

Note

You cannot record DVD video that contains a copy guard signal played back by another DVD player to a disc in this recorder.

Connecting to the LINE 1 IN jacks

You can connect a second VCR or similar device.

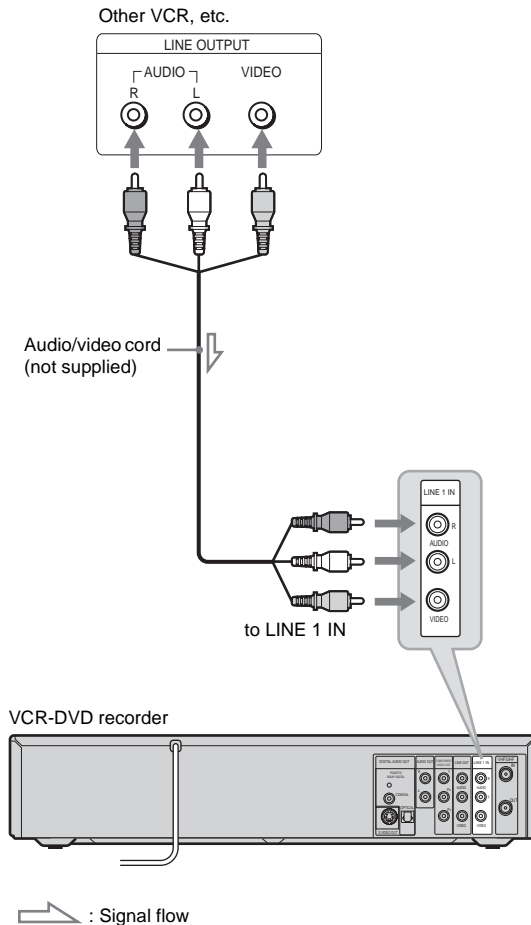

Hint

When the connected equipment outputs only monaural sound, use audio cables that distribute monaural sounds to left/right channels (not supplied).

Notes

- Do not connect the yellow LINE IN (VIDEO) jack when using an S video cord.
- Do not connect the output jack of this recorder to another equipment's input jack with the other equipment's output jack connected to the input jack of this recorder. Noise (feedback) may result.
- Pictures containing copy protection signals that prohibit any copying cannot be recorded.
- If you pass the recorder signals via the VCR, you may not receive a clear image on your TV screen.



Be sure to connect your VCR to the VCR-DVD recorder and your TV in the order shown below. To watch video tapes, watch the tapes through a second Line input on your TV.

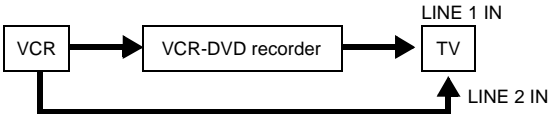

- If you disconnect the recorder's power cord, you will not be able to view the signals from the connected VCR.
- Do not connect more than one type of video cord between the recorder and your TV at the same time.

Playing a DVD Disc or VHS Tape

Playing a DVD disc

+RW -RWVR -RW_{Video} +R -R DVD

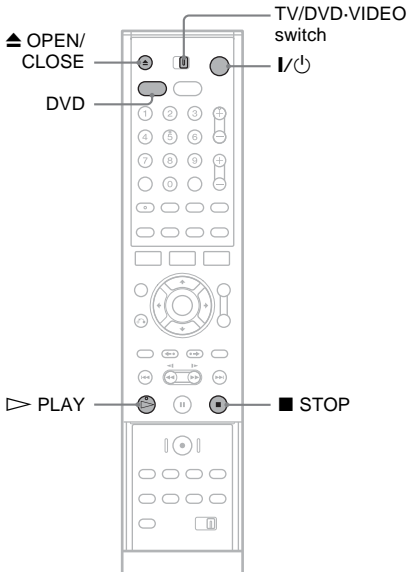

- 1 Turn on the TV.
- 2 Press I/⏻.
The recorder turns on.
- 3 Switch the input selector on your TV so that the signal from the recorder appears on the TV screen.
When connecting the recorder to the TV using only the antenna cable, see "Setting the RF Output channel" on page 19.
- 4 Slide the TV/DVD-VIDEO switch to DVD-VIDEO, then press DVD to control the DVD recorder.

- 5 Press ▲ OPEN/CLOSE, and place a disc on the disc tray.

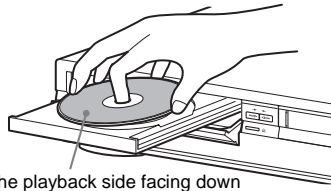

- 6 Press ▲ OPEN/CLOSE to close the disc tray.
Wait until "LOAD" disappears from the front panel display.
Playback starts automatically depending on the disc.

- 7 Press ▶ PLAY.

To stop playback

Press ■ STOP.

Playing a VHS tape

VHS

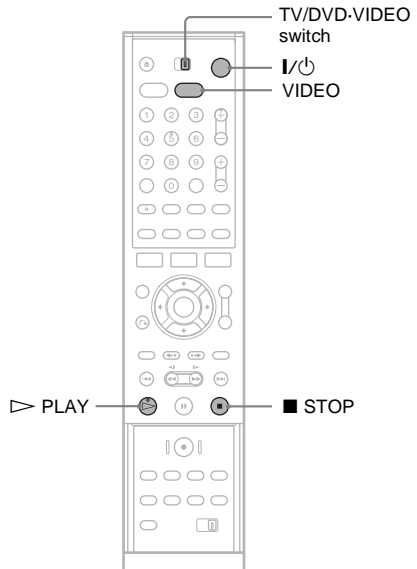

- 1 Turn on the TV.
- 2 Press I/⏻.
The recorder turns on.
- 3 Switch the input selector on your TV so that the signal from the recorder appears on the TV screen.

When connecting the recorder to the TV using only the antenna cable, see “Setting the RF Output channel” on page 19.

- 4 Slide the TV/DVD-VIDEO switch to DVD-VIDEO, then press VIDEO to control the VCR.

- 5 Insert a tape.
The VCR starts playing automatically if you insert a tape with its safety tab removed.

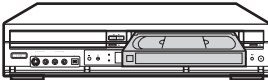

- 6 Press ▷ PLAY.

To stop playback
Press ■ STOP.

Recording a Program to a DVD Disc

+RW -RWVR -RW_{Video} +R -R

The following explains how to record a current TV program to a DVD disc.

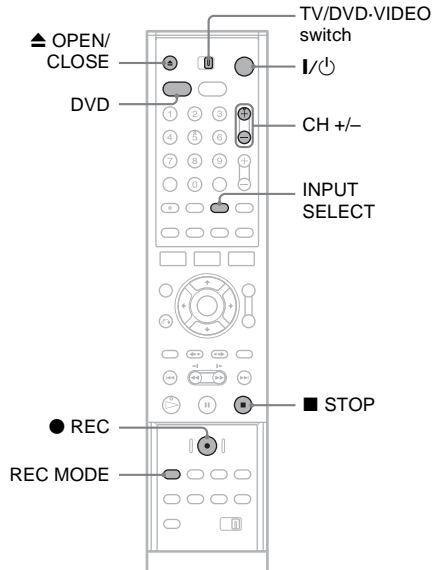

- 1 Turn on the TV.
- 2 Press I/⏻.
The recorder turns on.
- 3 Switch the input selector on your TV so that the signal from the recorder appears on the TV screen.
When connecting the recorder to the TV using only the antenna cable, see “Setting the RF Output channel” on page 19.
- 4 Slide the TV/DVD-VIDEO switch to DVD-VIDEO, then press DVD to control the DVD recorder.

- 5 Press **▲ OPEN/CLOSE**, and place a recordable disc on the disc tray.

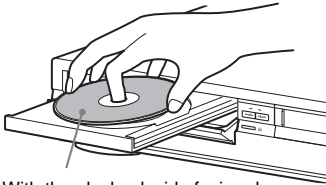

With the playback side facing down

- 6 Press **▲ OPEN/CLOSE** to close the disc tray.

Wait until "LOAD" disappears from the front panel display.

Unused DVD-RWs are formatted in VR mode automatically.

To format in Video mode, see page 43.

- 7 Press **CH +/-** or **INPUT SELECT** to select the channel or input source you want to record.

- 8 Press **REC MODE** repeatedly to select the recording mode.

Each time you press the button, the display changes on the TV screen as follows:

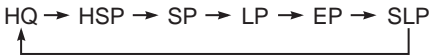

For more details about the recording mode, see page 47.

- 9 Press **● REC**.

"REC" appears in the front panel display and recording starts.

Recording continues until you stop the recording or the disc is full.

To stop recording

Press **■ STOP**.

Note that it may take a few seconds for the recorder to stop recording.

Hint

This recorder can record on various discs. Select the disc type according to your needs (page 10).

Recording a Program to a VHS Tape

VHS

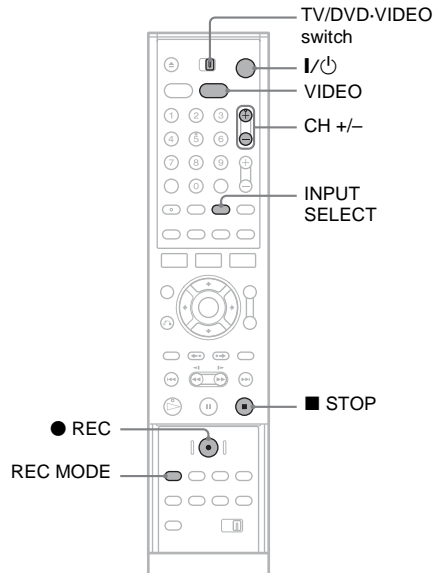

- 1 Turn on the TV.
- 2 Press **I/⏻**.
The recorder turns on.
- 3 Switch the input selector on your TV so that the signal from the recorder appears on the TV screen.
When connecting the recorder to the TV using only the antenna cable, see "Setting the RF Output channel" on page 19.
- 4 Slide the **TV/DVD-VIDEO** switch to **DVD-VIDEO**, then press **VIDEO** to control the VCR.
- 5 Insert a tape with its safety tab in place.

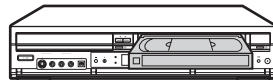

- 6 Press **CH +/-** or **INPUT SELECT** to select the channel or input source you want to record.

7 Press **REC MODE** repeatedly to select the tape speed, “**SP**” or “**EP**.”

“**EP**” (Extended Play) provides recording time three times as long as “**SP**” (Standard Play). However, “**SP**” produces better picture and audio quality.

8 Press **● REC**.

“**REC**” appears in the front panel display and recording starts.
Recording continues until you stop the recording or the tape reaches the end.

To stop recording

Press **■ STOP**.

Using the On-Screen Menus



This section introduces the System Menu, **TOOLS** menu, and sub-menu. By using these displays, you can perform most of the recorder’s operations.

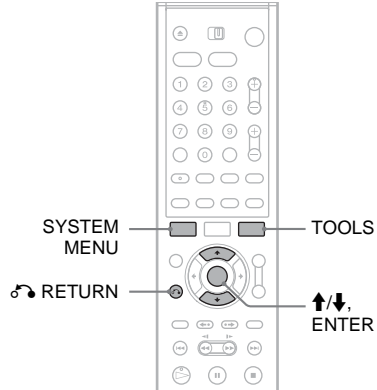

System Menu

The System Menu appears when you press **SYSTEM MENU**, and provides entries to all of the recorder’s main functions, such as timer recording and setup.

Select an option by pressing **↑/↓** and **ENTER**.

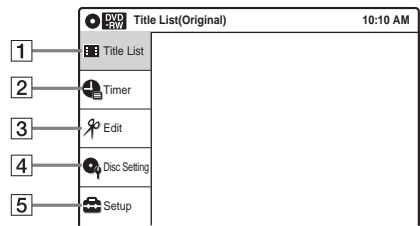

1 “**Title List**” (page 42):

Press **ENTER** to display the “**Title List**” menu, which shows recorded titles on the disc.

- 2 “Timer” (pages 50, 69):
Allows you to set a new timer recording setting.
You can also display the Timer List menu, which allows you to check, change, or cancel timer settings.
- 3 “Edit” (page 81):
Allows you to create and edit a Playlist (DVD-RW in VR mode only), record a DV format tape onto a disc, dub from a DVD disc to a VHS tape and dub from a VHS tape to a DVD disc.
- 4 “Disc Setting” (page 43):
Allows you to format or finalize a DVD.
- 5 “Setup” (page 96):
Turns on the “Setup” display, which allows you to set up the recorder to suit your preferences.

Selectable options

The options that can be selected differ according to the media.

In addition, the options that can be selected also differ according to the operating mode and the disc condition.

Example: When a disc or a VHS tape is in stop mode.

Type	Selectable options
+RW	[List Icon] [Stop Icon] [Erase Icon] [Protect Icon] [Title Name Icon]
-RWVR	[List Icon] [Stop Icon] [Erase Icon] [Protect Icon] [Title Name Icon]
-RWVideo	[List Icon] * [Stop Icon] [Erase Icon] [Protect Icon] [Title Name Icon]
-R	[List Icon] * [Stop Icon] [Erase Icon] [Protect Icon] *
+R	[List Icon] [Stop Icon] [Erase Icon] [Protect Icon]
DVD	[List Icon] [Stop Icon] [Erase Icon] [Protect Icon]
VCD	[List Icon] [Stop Icon] [Erase Icon] [Protect Icon]
CD	[List Icon] [Stop Icon] [Erase Icon] [Protect Icon]
DATA CD	[List Icon] [Stop Icon] [Erase Icon] [Protect Icon]
VHS	[List Icon] [Stop Icon] [Erase Icon] [Protect Icon]

* Unfinalized disc only

Notes

- The System Menu is not displayed when recording DVD and dubbing a VHS tape to a disc.
- When the System Menu is displayed, DVD and VIDEO buttons are not available.

Sub-menu

The sub-menu appears when you select an item from a list menu (e.g. a title from the Title List menu), and press ENTER. The sub-menu displays options applicable only to the selected item. The displayed options differ depending on the situation and disc type.

Select an option by pressing \uparrow/\downarrow and ENTER.

Example: The Title List menu

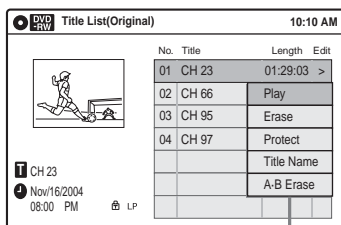

Options for the selected item

TOOLS

The TOOLS menu appears when you press TOOLS, and displays options. You can search for a title/chapter/track, check the playing and remaining time, or change audio and repeat settings. The displayed options differ depending on the media type.

Select the option by pressing \uparrow/\downarrow and ENTER.

Example: When you press TOOLS while a DVD-RW (VR mode) is playing.

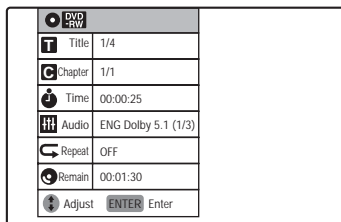

To return to the previous display

Press \leftarrow RETURN.

Note

The TOOLS menu may not be displayed during DVD recording.

Using the Title List

+RW -RWVR -RWvideo +R -R

The titles of programs recorded on a disc are displayed in the Title List.

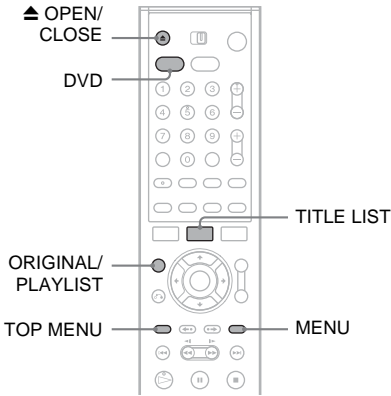

- 1 Press DVD to control the DVD recorder.
- 2 Press ▲ OPEN/CLOSE, and place a disc on the disc tray.

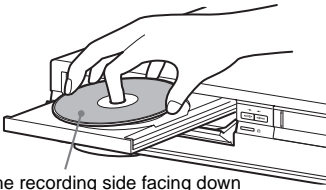

- 3 Press ▲ OPEN/CLOSE to close the disc tray.
Wait until “LOAD” disappears from the front panel display.
- 4 Press TITLE LIST.

Example: DVD-RW in VR mode

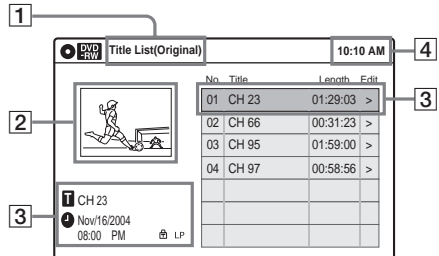

- 1 Title type (DVD-RW in VR mode only):
Displays the title type, “Title List(Original)” or “Playlist.”
- 2 Movie thumbnail image
- 3 Title information:
Displays the title number, title name, recording date, and recording mode.
“ ” indicates the protected title.
- 4 Clock

About the Title List for DVD-RWs (VR mode)

You can switch the Title List to show Original or Playlist.

While the Title List menu is turned on, press ORIGINAL/PLAYLIST repeatedly to select either “Title List(Original)” or “Playlist.”

For details, see “Edit options for DVD-RWs (VR mode)” on page 81.

To turn off the Title List

Press TITLE LIST.

Notes

- The Title List does not appear for DVD-RW (Video mode), DVD+R, or DVD-R that have been finalized. To view a title, press TOP MENU or MENU (page 57).
- The Title List may not appear for discs created on other DVD recorders.
- Letters that cannot be displayed are replaced with an “*.”
- When playback of the Title List movie thumbnail image for the selected title finishes, the thumbnail image display stops at the last image of the movie thumbnail image.

Using the DVD Disc Setting Displays

+RW **-RWVR** **-RWVideo** **+R** **-R**

With the “Disc Setting” display, you can perform operations such as formatting and finalizing (page 44).

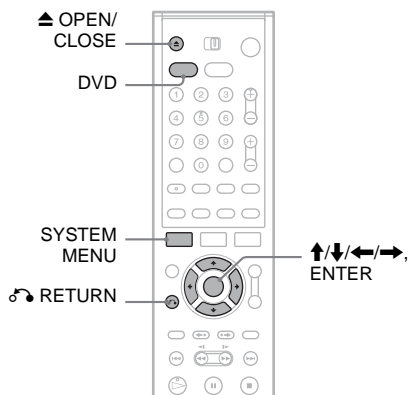

- 1 Press **DVD** to control the DVD recorder.
- 2 Press **▲ OPEN/CLOSE**, and place a disc on the disc tray.



With the recording side facing down

- 3 Press **▲ OPEN/CLOSE** to close the disc tray.
Wait until “LOAD” disappears from the front panel display.

- 4 Press **SYSTEM MENU** while the recorder is in stop mode.

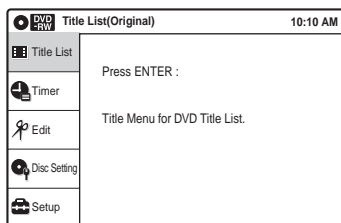

- 5 Select “Disc Setting,” and press **ENTER**.
The “Disc Setting” display appears.

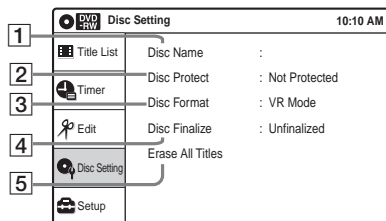

- 6 Select an option, and press **ENTER**.

- 1 “Disc Name”:
Labels a disc. Enter the disc name in the “Disc Name” display (page 46).
- 2 “Disc Protect” (DVD-RW in VR mode only):
Protects all titles on the disc. To cancel the protection, select “Not protected.”
- 3 “Disc Format” (DVD-RW/DVD+RW only):
Erases all contents of the disc to make a blank disc. For DVD-RWs, select a recording format (“VR Mode” or “Video Mode”) according to your needs.
- 4 “Disc Finalize”:
Finalizes a disc (page 44).
- 5 “Erase All Titles” (DVD-RW/DVD+RW only):
Erases all titles on the disc (except the protected titles).

To return to the previous display

Press **⏪ RETURN**.

🔔 Hints

- You can set protection for individual titles (page 82).
- By reformatting, you can change the recording format on DVD-RWs, or record again on DVD-RWs (Video mode) that have been finalized.

Note

You can enter up to 32 characters for a disc name. The disc name may not appear when the disc is played on other DVD equipment.

Finalizing a disc (preparing a disc for playback on other equipment)

+RW **-RWVR** **-RW_{video}** **+R** **-R**

Finalizing is necessary when you play discs recorded with this recorder on other DVD equipment.

When you finalize a DVD+RW, DVD-RW (Video mode), DVD+R, or DVD-R, a DVD menu will be automatically created, which can be displayed on other DVD equipment.

Before finalizing, check the differences between the disc types in the table below.

Differences between the disc types

+RW Discs are automatically finalized when stopped recording. If you want to record on it again, reformat the disc (page 43). However, after reformatting the disc, all recorded contents will be erased.

-RWVR Finalizing is unnecessary when playing a disc on VR format compatible equipment. Even if your other DVD equipment is VR format compatible, you may need to finalize the disc, especially if the recording time is short. After finalizing, you cannot edit or record on the disc. If you want to edit or record on it again, unfinalize or reformat the disc (page 43). However, after reformatting the disc, all recorded contents will be erased.

-RW_{video} Finalizing is necessary when playing on any equipment other than this recorder. After finalizing, you cannot edit or record on the disc. If you want to edit or record on it again, unfinalize or reformat the disc (page 43). However, after reformatting the disc, all recorded contents will be erased.

+R Finalizing is necessary when playing on any equipment other than this recorder.

-R After finalizing, you cannot edit or record on the disc.

1 Follow steps 1 to 6 of “Using the DVD Disc Setting Displays” on page 43 to select “Disc Finalize” in the “Disc Setting” display.

The display for confirmation appears.

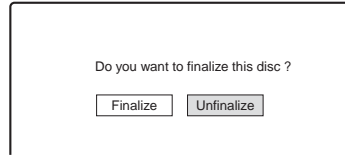

2 Select “Finalize,” and press ENTER.

The display for confirmation appears again.

3 Select “OK,” and press ENTER.

The recorder starts finalizing the disc.

To unfinalize a DVD-RW (VR mode)

If you cannot record or edit on a DVD-RW (VR mode) that has been finalized with other DVD equipment (a message appears), unfinalize the disc by selecting “Unfinalize” in step 2 above.

🔔 Hint

You can check whether the disc has been finalized or not. If you cannot select “Finalize” in step 2 above, the disc has already been finalized.

Notes

- Depending on the condition of the disc, recording, or the DVD equipment, discs may not play even if the discs are finalized.
- The recorder may not be able to finalize the disc if it was recorded on another recorder.

Checking the Play Information and Playing Time



You can check the playing time and remaining time of the current title, chapter, or track.

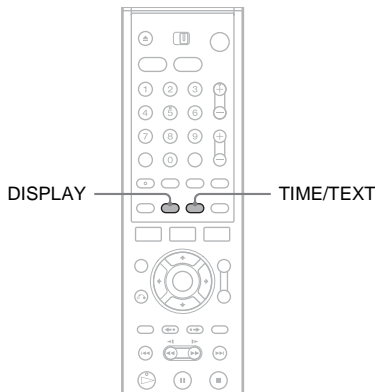

Press DISPLAY.

The information display appears.
The display disappears after a short time.

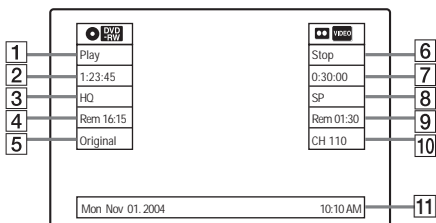

◆ DVD

- 1 Play mode
- 2 Playing time
- 3 Recording mode
- 4 Remaining time
- 5 Current channel*

* Title type (Original or Playlist) for DVD-RW in VR mode

◆ VHS

- 6 Play mode
- 7 Time counter
- 8 Recording mode
- 9 Remaining time
- 10 Current channel
- 11 Date and time

Note

The information display may not be displayed during DVD recording.

Checking the playing/remaining time

You can view the playing or time information displayed on the TV screen and the front panel display.

Press TIME/TEXT repeatedly.

The displays differ depending on the media type or playing status.

◆ Front panel display

Example: When playing a DVD

Playing time of the current title

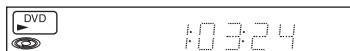

Current title number and current chapter number



Clock



Example: When playing a CD

Playing time of the current track

Current track number

Clock

Example: When playing a VHS tape

Playing time

Remaining time

Clock

Changing the Name of a Recorded Program (Title Input)

+RW -RWVR -RWvideo +R -R

You can label a title, disc, or program by entering characters. You can enter up to 32 characters for a title or disc name, but the actual number of characters displayed in the menus such as the Title List will vary. When the display for entering characters appears, follow the steps below.

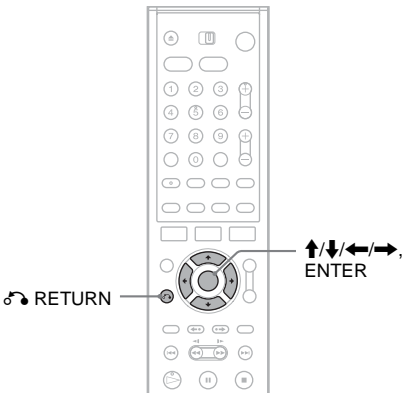

- 1 Select the character you want to enter using **↑/↓/←/→**, and press **ENTER**.
The selected character appears at the top of the display.

Example: Disc Name

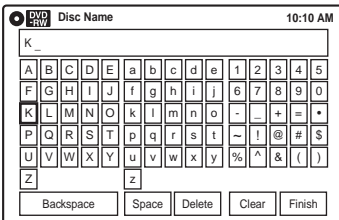

You can only enter characters and symbols that are displayed.

To insert a space, select “Space.”

- 2 Repeat step 1 to enter the remaining characters.

Input row

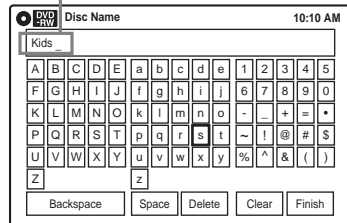

To erase a character, move the cursor to the right of the character at the input row. Select “Backspace” and press **ENTER**.

To erase the character at the position of the cursor, select “Delete” and press **ENTER**.

To insert a character, move the cursor to the right of the point where you want to insert the character. Select the character and press **ENTER**.

To erase all of the characters, select “Clear” and press **ENTER**.

- 3 Select “Finish,” and press **ENTER**.

To cancel the setting, press **RETURN**.

Before Recording

Before you start recording...

- This recorder can record on various discs. Select the disc type according to your needs (page 10).
- Check that the disc has enough available space for the recording (page 50). For DVD-RWs, you can free up disc space by erasing titles (page 82).

Hint

Timer recordings will start regardless of whether or not the recorder is turned on. You cannot turn off the recorder during a timer recording. The recorder automatically turns off after the timer recording finishes.

Notes

- This recorder records at x1 speed.
- This recorder shares a single tuner for both the DVD recorder and the VCR. You cannot record different programs to a DVD and a VHS tape at the same time.

Recording mode

Like the SP or EP recording mode of VCRs, this recorder has six different recording modes. Select a recording mode according to the time and picture quality you need. For example, if picture quality is your top priority, select the High Quality mode (HQ). If recording time is your priority, Super Long Play mode (SLP) can be a possible choice. Note that the recording time in the following table is an approximate guide. Press REC MODE repeatedly to switch the recording modes.

I want to record with the best possible picture quality, so I'll select HQ.



Recording mode	Recording time (minute)
HQ (High quality)	60
HSP ↑	90
SP (Standard mode)	120
LP ↓	180
EP ↓	240
SLP (Long duration)	360

Note

Situations below may cause slight inaccuracies with the recording time.

- Recording a program with poor reception, or a program or video source of low picture quality
- Recording on a disc that has already been edited
- Recording only a still picture or just sound

Recording a stereo/SAP program

The recorder can receive and record stereo/SAP programs.

Stereo programs

When a stereo program is received, the “STEREO” indicator lights up in the front panel display. If there is noise in the stereo program, press AUDIO repeatedly until the “MONO” indicator disappears from the TV screen. The sound will be recorded in monaural but with less noise.

SAP (Second Audio Program)

When a SAP (Second Audio Program) is received, the “SAP” indicator lights up in the front panel display. To record only SAP sound, set “Tuner Audio” of “Audio” to “SAP” in the “Setup” display (page 102).

Unrecordable pictures

Pictures with copy protection cannot be recorded on this recorder.

Copy control signals	Recordable discs
Copy-Free	<div style="display: flex; gap: 5px;"> +RW -RWVR -RW_{Video} </div> <div style="display: flex; gap: 5px; margin-top: 5px;"> +R -R </div>
Copy-Once	<div style="display: flex; gap: 5px;"> -RWVR </div> <p>Ver.1.1 with CPRM* Ver.1.2 with CPRM*</p>
Copy-Never	None

* The recorded disc can be played only on CPRM compatible equipment.
Recording stops when a copy guard signal is detected.

DVD Recording without the Timer

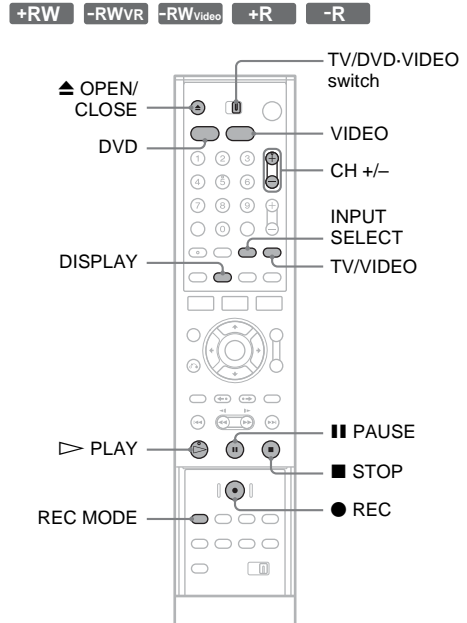

- 1 Press **DVD** to control the DVD recorder.
- 2 Press **▲ OPEN/CLOSE**, and place a recordable disc on the disc tray.



With the recording side facing down

- 3 Press **▲ OPEN/CLOSE** to close the disc tray.
Wait until "LOAD" disappears from the front panel display.
Unused DVD-RWs are formatted in VR mode automatically.
To format in Video mode, see page 43.
- 4 Press **CH +/-** or **INPUT SELECT** to select the channel or input source you want to record.

5 Press REC MODE repeatedly to select the recording mode.

Each time you press the button, the display changes on the TV screen as follows:

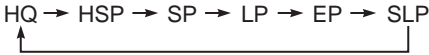

For more details about the recording mode, see page 47.

6 Press ● REC.

Recording starts.

Recording continues until you stop the recording or the disc is full.

To stop recording

Press ■ STOP.

Note that it may take a few seconds for the recorder to stop recording.

To pause recording

Press ■ PAUSE.

To restart recording, press ■ PAUSE again.

To watch another TV program while recording

- 1 Slide the TV/DVD-VIDEO switch to TV.
- 2 Press TV/VIDEO to switch to the TV's antenna input.
- 3 Select another channel on the TV.

To watch a VHS tape while recording

Press VIDEO to control the VCR, insert a tape, then press ▷ PLAY.

Recording using the Quick Timer (One-touch Timer Recording)

You can set the recorder to record in 30 minute increments.

1 Press DVD to control the DVD recorder.

2 Press ● REC repeatedly to set the duration.

Each press advances the time in 30 minute increments. The maximum duration is six hours.

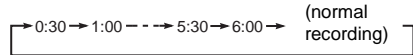

“OTR” (One-touch Timer Recording) and the remaining recording time are displayed in the front panel display while recording.

The time counter decreases minute by minute to 0:00, then the recorder stops recording (power turns off).

To cancel the Quick Timer

Press ● REC repeatedly until the counter appears in the front panel display. The recorder returns to normal recording mode.

To stop recording.

Press ■ STOP twice.

💡 Hint

If you do not want to watch TV while recording, you can turn off the TV. When using a cable box or satellite receiver, make sure to leave it on.

Notes

- After pressing ● REC, it may take a short while to start recording.
- You cannot change the recording mode while recording or during recording pause.
- If there is a power failure, the program you are recording may be erased.
- You cannot change the channel or input source of the recorder using CH +/- or INPUT SELECT while recording another TV program.

Checking the disc status while recording

You can check the recording information such as recording time or disc type.

Press **DISPLAY** during recording.

The recording information appears.

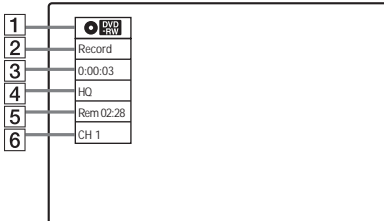

- 1 Disc type
- 2 Recording status
- 3 Recording time
- 4 Recording mode
- 5 Remaining recording time
- 6 Current channel

Press **DISPLAY** repeatedly to turn off the display.

Creating chapters in a title

The recorder will automatically divide a recording (a title) into chapters by inserting chapter marks at 5 or 15 minute intervals during recording. Select the interval, “5 Min” (default) or “15 Min” in “DVD Auto Chapter” of “Features” in the “Setup” display (page 104).

To cancel “DVD Auto Chapter” setting, select “Off.”

Hint

You can create chapters manually when playing DVD+RWs or DVD-RWs (VR mode). For details, see page 84.

DVD Timer Recording (Standard/VCR Plus+)

+RW **-RW/VR** **-RW_{video}** **+R** **-R**

You can set the timer for a total of 12 programs together with DVD Timer Recording and VCR Timer Recording, up to one month in advance. There are two methods to set the timer: the standard method and VCR Plus+ method.

- Standard: Set the date, time, and channel of the program manually.
- VCR Plus+: Enter the PlusCode number designated for each TV program (page 52).

Note

Do not operate your cable box or satellite receiver just before or during a timer recording. This may prevent the accurate recording of a program.

Setting the timer manually (Standard)

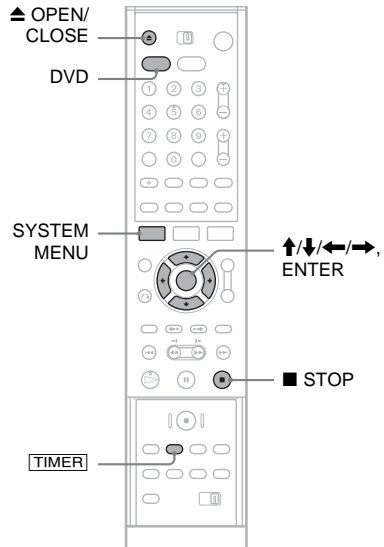

- 1 Press DVD to control the DVD recorder.
- 2 Press **▲ OPEN/CLOSE**, and place a recordable disc on the disc tray.

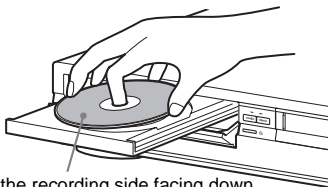

With the recording side facing down

- 3 Press **▲ OPEN/CLOSE** to close the disc tray.

Wait until “LOAD” disappears from the front panel display.

Unused DVD-RWs are formatted in VR mode automatically.

To format in Video mode, see page 43.

- 4 Press **TIMER**.

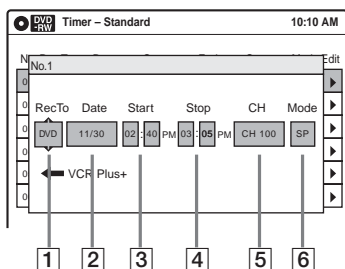

If the Timer programming (VCR Plus+) menu appears, press **←** to switch the display to “Standard.”

- 5 Select an item using **←/→** and adjust using **↑/↓**.

- 1 “RecTo”:
Select “DVD.”
- 2 “Date”:
Sets the date using **↑**.
To record the same program every day or the same day every week, press **↓**.
The item changes as follows:
Today **↔** Mon-Fri (Monday to Friday)
↔ Sun (every Sunday) **↔** Mon (every Monday) **↔** ... **↔** Sat (every Saturday)
↔ 1 month later **↔** ... **↔** Today
- 3 “Start”:
Sets the start time.
- 4 “Stop”:
Sets the stop time.

- 5 “CH”:
Selects the channel or input source.
- 6 “Mode”:
Selects the recording mode (page 47).
To use the Rec Mode Adjust function, select “Auto.” For details, see “To use the Rec Mode Adjust function” on page 52.

If you make a mistake, select the item and change the setting.

- 6 Press **ENTER**.

The Timer List menu (page 55) appears. The **⊖** indicator lights up in the front panel display, and the recorder is ready to start recording. If the **⊖** indicator flashes in the front panel display, check that a recordable disc is inserted and that there is enough disc space for the recording.

There is no need to turn off the recorder before the timer recording starts.

If the timer settings overlap, the message “These timer settings overlap.” appears. To confirm, change, or cancel timer recording, see “Checking/Changing/Canceling DVD Timer Settings (Timer List)” on page 55.

- 7 Press **SYSTEM MENU** to exit the menu.

To stop recording

Press **■ STOP** twice.

Note that it may take a few seconds for the recorder to stop recording.

If the timer settings overlap

The program that starts first has priority and the second program starts recording only after the first program has finished. If the programs start at the same time, the program listed first in the menu has priority.

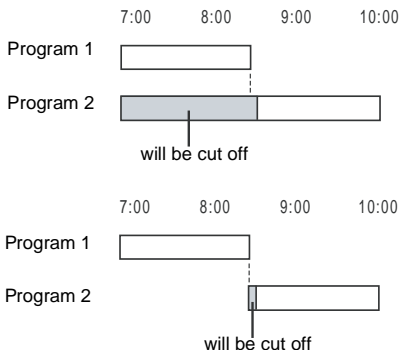

To confirm, change, or cancel timer recording See “Checking/Changing/Canceling DVD Timer Settings (Timer List)” on page 55.

To use the Rec Mode Adjust function

When you are recording a program in the Auto mode and there is not enough available disc space for the recording, the recorder automatically adjust the recording mode to enable the entire program to be recorded.

Hints

- You can play the recorded program by selecting the program title in the Title List menu.
- When the start time and the channel or input source to be recorded are the same but the “RecTo” setting differs, the program is recorded to both the DVD disc and the VHS tape.
- You can also display the Timer programming menu as follows:
 - 1 Press SYSTEM MENU.
 - The System Menu appears.
 - 2 Select “Timer,” and press ENTER.
 - 3 Select “Timer – Standard,” and press ENTER.

Notes

- To record a cable or satellite program, turn on the cable box or satellite receiver and select the program you want to record. Leave the cable box or satellite receiver turned on until the recorder finishes recording.
- Even if the timer is set, timer recordings cannot be made while recording a program that has priority.
- Before the timer recording starts, “TIMER REC” flashes in the front panel display.

Recording TV programs using the VCR Plus+ system

The VCR Plus+ system is a feature that simplifies setting the timer. Just enter the PlusCode number listed in the TV program guide. The date, time, and channel of that program are set automatically. Before you start, check that the TV and guide channels are correctly set in “Guide Channel Setup” of “Tuner Preset” in the “Setup” display (page 98).

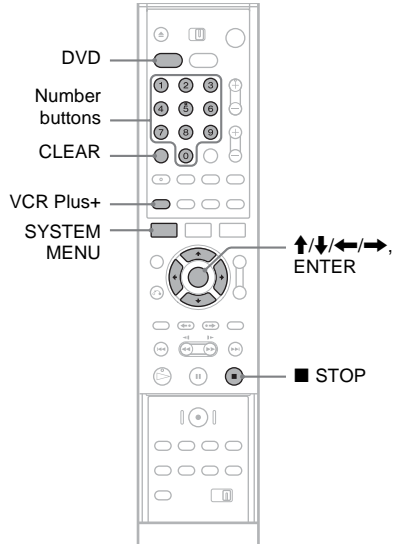

- 1 Press DVD to control the DVD recorder.
- 2 Insert a recordable disc.
- 3 Press VCR Plus+.

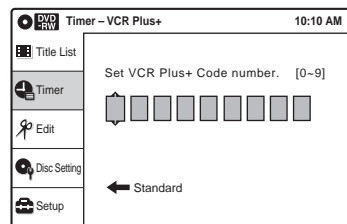

If the Timer programming (Standard) menu appears, press ← to switch the display to “VCR Plus+.”

4 Press **REC MODE** repeatedly to select the recording mode.

Each time you press the button, the display changes on the TV screen as follows:

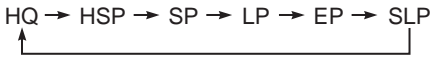

For more details about the recording mode, see page 47.

5 Press **SYSTEM MENU** while the recorder is in stop mode.

6 Select “Setup,” and press **ENTER**.

7 Select “Features,” and press **ENTER**.

The “Features” setup appears.

8 Select “Synchro Recording,” and press **ENTER**.

9 Select “to DVD,” and press **ENTER**.

10 Press **SYSTEM MENU** to exit the menu.

11 Set the timer on the connected equipment to the time of the program you want to record, and turn it off.

12 Press **SYNCHRO REC**.

The **SYNCHRO REC** indicator lights up on the front panel. The recorder is ready to start Synchro-Recording.

The recorder automatically starts recording when it receives an input signal from the connected equipment. The recorder stops recording when the connected equipment turns off.

To stop recording

Press **STOP** twice.

To cancel Synchro Rec function

Press **SYNCHRO REC**. The **SYNCHRO REC** indicator on the recorder turns off.

If you press **SYNCHRO REC** during Synchro-Recording, the Synchro-Recording stops, the **SYNCHRO REC** indicator turns off and the recorder’s power turns off.

Notes

- The recorder starts recording only after detecting the video signal from the connected equipment. The beginning of the program may not be recorded regardless of whether or not the recorder’s power is on or off.
- During Synchro-Recording, other operations such as normal recording cannot be done.
- To use the connected equipment while the recorder is standing by for Synchro-Recording, cancel Synchro-Recording by pressing **SYNCHRO REC**. Be sure to turn off the connected equipment and press **SYNCHRO REC** to reset Synchro-Recording before the timer recording starts.
- The Synchro Rec function does not work with some tuners. For details, see the tuner’s operating instructions.
- While the recorder is standing by for Synchro-Recording, the Auto Clock Set function (page 99) does not work.
- To use the Synchro Rec function, you must first set the recorder’s clock correctly.
- When the recorder’s power is on, the recorder enters the Synchro-Recording standby mode after a Synchro-Recording has finished.

If the timer settings of a Synchro-Recording and another timer recording overlap

Regardless of whether or not the program is a Synchro Rec program, the program that starts first has priority. The recorder switches to start recording the second program around 10 seconds after the first program has finished.

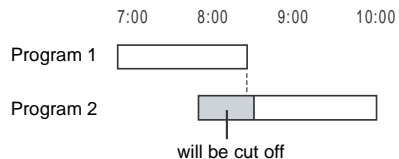

Checking/Changing/ Canceling DVD Timer Settings (Timer List)

+RW -RWvR -RWVideo +R -R

You can check, change, or cancel timer settings using the Timer List menu.

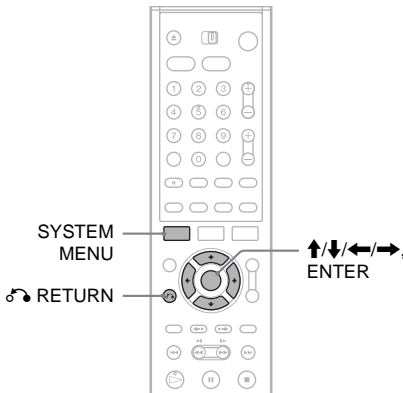

- 1 Press **SYSTEM MENU**.
The System Menu appears.
- 2 Select "Timer," and press **ENTER**.
- 3 Select "Timer List," and press **ENTER**.

No	RecTo	Date	Start	Stop	CH	Mode	Edit
01	DVD	11/17	09:00PM	10:00PM	CH8	LP	▶
02	DVD	11/28	09:15PM	09:45PM	CH1	LP	▶
03	---	--/--	--:--	--:--	----	---	▶
04	---	--/--	--:--	--:--	----	---	▶
05	---	--/--	--:--	--:--	----	---	▶
06	---	--/--	--:--	--:--	----	---	▶

Timer information displays the recording date, time, recording mode, etc.

- 4 Select the timer setting you want to check/change/cancel, and press **ENTER**.
The sub-menu appears.

No	RecTo	Date	Start	Stop	CH	Mode	Edit
01	DVD	11/17	09:00PM	10:00PM	CH8	LP	▶
02	DVD	11/28	09:15PM	09:45PM	CH1	LP	▶
03	---	--/--	--:--	--:--	----	---	▶
04	---	--/--	--:--	--:--	----	---	▶
05	---	--/--	--:--	--:--	----	---	▶
06	---	--/--	--:--	--:--	----	---	▶

- 5 Select one of the options, and press **ENTER**.
"Edit": Changes the timer setting. Select an item using **←/→** and adjust using **↑/↓**. Press **ENTER**.

No.1	RecTo	Date	Start	Stop	CH	Mode	Edit
01	DVD	11/17	09:15 PM	09:45 PM	CH1	LP	▶
02	---	--/--	--:--	--:--	----	---	▶
03	---	--/--	--:--	--:--	----	---	▶
04	---	--/--	--:--	--:--	----	---	▶
05	---	--/--	--:--	--:--	----	---	▶
06	---	--/--	--:--	--:--	----	---	▶

← VCR Plus+

"Del": Erases the timer setting. Press **ENTER**.

No.1	RecTo	Date	Start	Stop	CH	Mode	Edit
01	DVD	11/17	09:15 PM	09:45 PM	CH1	LP	▶
02	---	--/--	--:--	--:--	----	---	▶
03	---	--/--	--:--	--:--	----	---	▶
04	---	--/--	--:--	--:--	----	---	▶
05	---	--/--	--:--	--:--	----	---	▶
06	---	--/--	--:--	--:--	----	---	▶

Do you want to erase "No.01"?

OK Cancel

To turn off the Timer List
Press **RETURN**.

Note

Even if the timer is set, timer recordings cannot be made while recording a program that has priority.

Recording from Connected Equipment without a Timer

+RW -RWVR -RW_{video} +R -R

You can record from a connected VCR or similar device. To connect other VCR or similar device, see “Connecting Another VCR or Similar Device” on page 34.

Use the DV IN jack on the front panel if the equipment has a DV output jack (i.LINK jack).

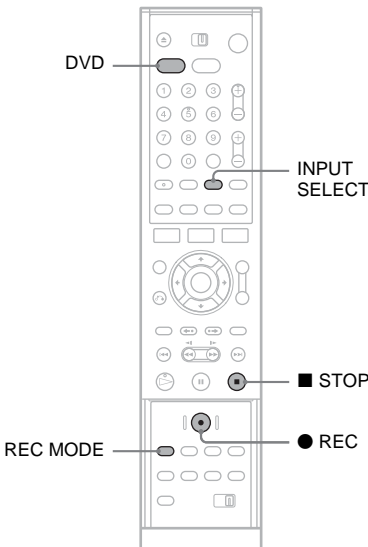

- 1 Press DVD to control the DVD recorder.
- 2 Insert a recordable disc.
- 3 Press INPUT SELECT to select an input source according to the connection you made.

The front panel display changes as follows:

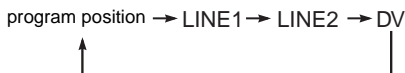

- 4 Press REC MODE repeatedly to select the recording mode.

Each time you press the button, the display changes on the TV screen as follows:

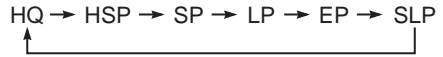

For more details about the recording mode, see page 47.

- 5 Select the line input audio.
Set “Line Audio Input” of “Audio” to “Stereo” or “Main/Sub” in the “Setup” display (page 103).
- 6 Insert the source tape into the connected equipment and set to playback pause.
- 7 At the same time, press ● REC on this recorder and the pause or play button on the connected equipment.
Recording starts.
To stop recording, press ■ STOP on this recorder.

If you connect a digital video camera with a DV IN jack

See “Dubbing from a DV Format Tape to a DVD” on page 94 for an explanation of how to record from the DV IN jack.

Notes

- When recording a video game image, the screen may not be clear.
- Any program that contains a Copy-Never copy guard signal cannot be recorded. The recorder automatically stops recording after a few seconds.

Playing Discs

Playing

+RW -RWVR -RWVideo +R -R DVD
VCD CD DATA CD

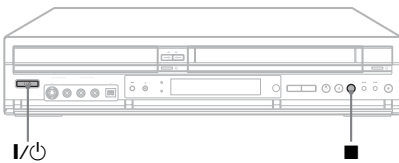
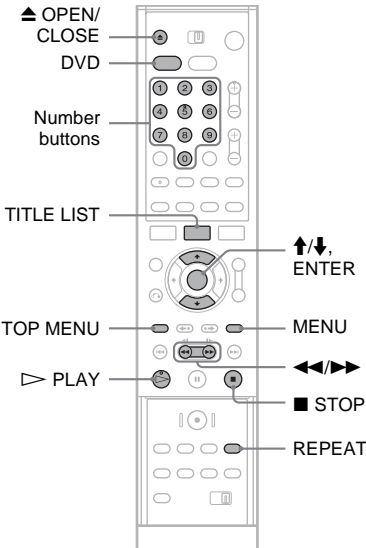

- 1 Press DVD to control the DVD recorder.
- 2 Press ▲ OPEN/CLOSE, and place a disc on the disc tray.



With the playback side facing down

- 3 Press ▲ OPEN/CLOSE to close the disc tray.

If you inserted a DVD VIDEO, VIDEO CD, CD, or DATA CD, press ▶ PLAY. Playback starts.

Playback starts automatically depending on the disc.

- 4 Press TITLE LIST.

For details about the Title List, see “Using the Title List” on page 42.

Example: DVD-RW (VR mode)

No.	Title	Length	Edit
01	CH 23	01:29:03	>
02	CH 66	00:31:23	>
03	CH 95	01:59:00	>
04	CH 97	00:58:56	>

Additional information shown:
DVD RW Title List(Original) 10:10 AM
CH 23
Nov/16/2004 08:00 PM LP

- 5 Select the title, and press ENTER.
The sub-menu appears.

- 6 Select “Play,” and press ENTER.

Playback starts from the selected title on the disc.

To use the DVD's Menu

When you play a DVD VIDEO, or a finalized DVD+RW, DVD-RW (Video mode), DVD+R, or DVD-R, you can display the disc's menu by pressing TOP MENU or MENU.

To play VIDEO CDs with PBC functions

PBC (Playback Control) allows you to play VIDEO CDs interactively using the menu on your TV screen.

When you start playing a VIDEO CD with PBC functions, the menu appears.

Select an item using the number buttons and press ENTER. Then follow the instructions in the menu (press ▶ PLAY when “Press SELECT” appears).

To cancel PBC Playback

Press MENU repeatedly until “Menu: Off” appears.

To stop playback

Press ■ STOP.

To resume playback from the point where you stopped the disc (Resume Play)

When you press \triangleright PLAY again after you stop the disc, the recorder resumes playback from the point where you pressed \blacksquare STOP.

To start from the beginning, press \blacksquare STOP twice, and press \triangleright PLAY.

The point where you stopped playing is cleared when:

- you open the disc tray.
- you play another title.
- you switch the Title List menu to Original or Playlist (DVD-RW in VR mode only).
- you edit the title after stopping playback.
- you turn off the recorder.
- you make a recording.

To repeat a specific portion (Repeat A-B Play) (DVD and VIDEO CD (with PBC function off) only)

- 1 During playback, press REPEAT.
- 2 Select “A” using \uparrow/\downarrow .
- 3 Press ENTER at the starting point (point A) of the portion to be played repeatedly. “A-” lights up.
- 4 Continue playing or press \lll/\ggg to locate the ending point (point B), then press ENTER. Repeat A-B Play starts.

To play restricted DVDs (Parental Control)

If you play a restricted DVD, the message “Your selection exceeds the rating limit for this player. Override the limit?” appears on your TV screen.

- 1 Select “OK” and press ENTER.
The display for entering your password appears.
- 2 Enter your four digit password using the number buttons.
The recorder starts playback.

To register or change the password, see “Parental (DVD VIDEO only)” on page 105.

To lock the recorder (Child Lock)

You can lock all of the buttons on the recorder so that the settings are not canceled by mistake.

When the recorder is turned on, hold down $\mathbb{I}/\text{⏻}$ on the recorder until “CHILD LOCK” appears in the front panel display. The recorder turns off and the ⊖ indicator remains lit if there is a timer setting. The recorder will not work except for timer recordings.

To unlock the recorder, hold down $\mathbb{I}/\text{⏻}$ on the recorder until “CHILD LOCK” disappears from the front panel display. The recorder is unlocked and turns on.

To stop timer recording while the recorder is locked, press \blacksquare twice. The recording stops and the recorder is unlocked.



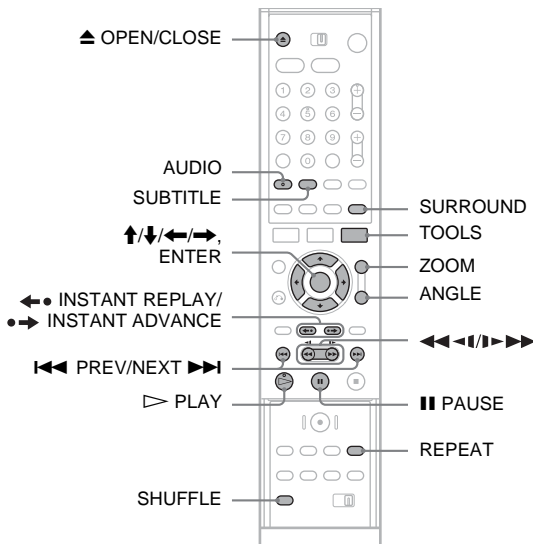

Notes

- When playing back a disc recorded by other equipment on this recorder, be sure to finalize the disc with the equipment used to record it.
- For details on the operation restrictions, see page 8.
- The recorder will be unlocked when:
 - You stop timer recording by pressing \blacksquare .
 - You insert a tape.
 - The AC power cord is disconnected or power supply stops.

Playback options



Buttons	Operations	Discs
▲ OPEN/CLOSE	Stops play and opens the disc tray.	All discs
AUDIO	<p>Selects one of the audio tracks recorded on the disc when pressed repeatedly.</p> <p>DVD Selects the audio source.</p> <p>VCD Selects stereo or monaural audio tracks.</p>	DVD VCD
SUBTITLE	Selects a subtitle language when pressed repeatedly.	DVD
ANGLE	<p>Selects an angle when pressed repeatedly.</p> <p>If various angles (multi-angles) for a scene are recorded on the disc, “” appears in the front panel display.</p>	DVD
ZOOM	<p>Zooms into a scene during playback or still mode when pressed repeatedly.</p> <p>Magnification changes as follows:</p> <p>normal magnification → ×2 → ×4 → normal magnification</p> <p>The zoom function may not work depending on the DVD.</p> <p>To zoom in a JPEG image, see page 65.</p>	DVD VCD

Buttons	Operations	Discs								
SURROUND	<p>Selects one of the effects when pressed repeatedly.</p> <p>“Off”: No surround effect</p> <p>“Surround1”: Creates one set of virtual surround speakers.</p> <p>“Surround2”: Creates two sets of virtual surround speakers.</p> <p>“Surround3”: Creates three sets of virtual surround speakers.</p> <p>Effective when you use two separate front speakers.</p>									
◀• INSTANT REPLAY/•→ INSTANT ADVANCE	<ul style="list-style-type: none"> Replays the scene/briefly fast forwards the scene when pressed in continuous play mode. Goes to the previous/next frame when pressed in pause mode. 									
◀◀ PREV/ NEXT ▶▶	<ul style="list-style-type: none"> Goes to the beginning of the current/next title/ chapter/scene/track and starts playback when pressed during playback. Goes to the beginning of the previous title/chapter/ scene/track when ◀◀ PREV is pressed within 3 seconds after starting a title/chapter/scene/track. 	All discs								
◀◀◀/▶▶▶ (fast reverse/fast forward)	<p>Fast reverses/fast forwards the disc when pressed during playback.</p> <p>Search speed changes as follows:</p> <table style="margin-left: auto; margin-right: auto;"> <tr> <td style="text-align: center;">fast reverse</td> <td style="text-align: center;">fast forward</td> </tr> <tr> <td style="text-align: center;">FR1 ←</td> <td style="text-align: center;">→ FF1</td> </tr> <tr> <td style="text-align: center;">FR2*1 ← ←</td> <td style="text-align: center;">→ → FF2*1</td> </tr> <tr> <td style="text-align: center;">FR3*2 ← ← ←</td> <td style="text-align: center;">→ → → FF3*2</td> </tr> </table>	fast reverse	fast forward	FR1 ←	→ FF1	FR2*1 ← ←	→ → FF2*1	FR3*2 ← ← ←	→ → → FF3*2	<p>All discs</p> <p>*1 FR2 and FF2 are not available for MP3.</p> <p>*2 FR3 and FF3 are only available for DVDs and VIDEO CDs.</p>
fast reverse	fast forward									
FR1 ←	→ FF1									
FR2*1 ← ←	→ → FF2*1									
FR3*2 ← ← ←	→ → → FF3*2									
◀◀◀/▶▶▶ (slow)	<p>Plays in slow motion when pressed in pause mode.</p> <p>The playback speed changes as follows:</p> <table style="margin-left: auto; margin-right: auto;"> <tr> <td style="text-align: center;">reverse slow motion</td> <td style="text-align: center;">forward slow motion</td> </tr> <tr> <td style="text-align: center;">◀◀3 ←</td> <td style="text-align: center;">→ 3▶▶</td> </tr> <tr> <td style="text-align: center;">◀◀2 ← ←</td> <td style="text-align: center;">→ → 2▶▶</td> </tr> <tr> <td style="text-align: center;">◀◀1 ← ← ←</td> <td style="text-align: center;">→ → → 1▶▶</td> </tr> </table>	reverse slow motion	forward slow motion	◀◀3 ←	→ 3▶▶	◀◀2 ← ←	→ → 2▶▶	◀◀1 ← ← ←	→ → → 1▶▶	 <p>* Playback direction only</p>
reverse slow motion	forward slow motion									
◀◀3 ←	→ 3▶▶									
◀◀2 ← ←	→ → 2▶▶									
◀◀1 ← ← ←	→ → → 1▶▶									
⏸ PAUSE	<p>Pauses playback.</p> <p>If you pause playback for more than 5 minutes, playback starts automatically.</p>	All discs								
SHUFFLE	<p>Plays in random order when pressed during playback.</p>	 <p>* with PBC function off</p>								

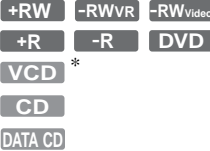
Buttons	Operations	Discs
REPEAT	<p>Selects the item to be repeated using ↑/↓.</p> <p>When playing a DVD</p> <ul style="list-style-type: none"> • Chapter: repeats the current chapter. • Title: repeats the current title on a disc. • A-B (Repeat A-B Play): repeats a specific portion (page 58). <p>When playing a VIDEO CD (with PBC function off)</p> <ul style="list-style-type: none"> • Track: repeats the current track. • Disc: repeats all of the tracks. • A-B (Repeat A-B Play): repeats a specific portion (page 58). <p>When playing a CD</p> <ul style="list-style-type: none"> • Track: repeats the current track. • Disc: repeats all of the tracks. <p>When playing a DATA CD (MP3 audio)</p> <ul style="list-style-type: none"> • File: repeats the current track. • Folder: repeats the current album. <p>To cancel Repeat Play, press REPEAT, and select "Off."</p>	 <p>* with PBC function off</p>

To resume normal playback, press **▷** PLAY.

To playback quickly with sound (Scan Audio) (DVD with Dolby Digital sound tracks only)

Set "Scan Audio" of "Audio" to "On" in the "Setup" display (page 103).

You can then play quickly with dialog or sound during FF1 fast-forward of a DVD disc with Dolby Digital sound tracks.

Hint

You can select the audio/subtitle settings and the angle using the TV screen. Press TOOLS during playback, select "Audio," "Subtitle," or "Angle" using **↑/↓**, then select the setting or angle using **←/→**. Then press ENTER.

Notes

- Shuffle play will stop when all the tracks are played back.
- You cannot repeat play in the following cases:
 - while in shuffle play
 - VIDEO CDs with PBC function on.
- When the playback signal does not contain a signal for the surround speakers, the surround effects will be difficult to hear.
- When you select one of the surround modes, turn off the surround settings of the connected TV or amplifier (receiver).
- Make sure that your listening position is between and at an equal distance from your speakers, and that the speakers are located in similar surroundings.

Notes on playing DTS sound tracks on a CD

When playing DTS-encoded CDs, excessive noise will be heard from the analog stereo jacks. To avoid possible damage to the audio system, the consumer should take proper precautions when the analog stereo jacks of the recorder are connected to an amplification system. To enjoy DTS Digital Surround™ playback, an external 5.1-channel decoder system must be connected to the digital jack of the recorder.

Notes on playing DVDs with a DTS sound track

DTS audio signals are output only through the DIGITAL AUDIO OUT (COAXIAL or OPTICAL) jack. When you play a DVD with DTS sound tracks, set "Digital Out" – "DTS" to "On" of "Audio" in the "Setup" display (page 102).

Searching for a Title/ Chapter/Track, etc.



You can search a DVD by title or chapter, and VIDEO CD by track or scene. As titles and tracks are assigned individual numbers on the disc, select the title or track by entering its number. You can also search for a scene using the time code.

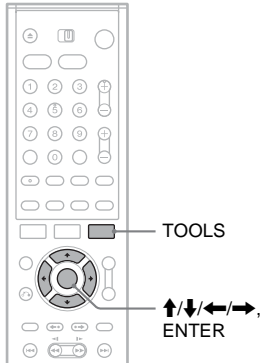

- 1 Press TOOLS during playback.**
The TOOLS menu appears.
- 2 Select a search method.**
“Title” (for DVDs)
“Chapter” (for DVDs)
“Track” (for VIDEO CDs with PBC function off)
“Time” (for DVDs/VIDEO CDs): Searches for a starting point by entering the time code.
- 3 Press \leftarrow/\rightarrow to select the number of the title, chapter, track, time code, etc., you want.**
For example: Time
To find a scene at 2 hours, 10 minutes, and 20 seconds, enter “21020.”
If you make a mistake, wait a bit until the display returns to the elapsed playing time display, then select another number.
- 4 Press ENTER.**
The recorder starts playback from the selected number.

Note
Depending on the disc, you cannot use the TOOLS menu to search for a title, chapter, track, or start from a point by entering the time code.

Setting and selecting a favorite scene (Bookmark)



You can have the recorder store specific portions of the disc in memory and play them immediately whenever you want (Bookmark). Up to 10 bookmarks per disc.

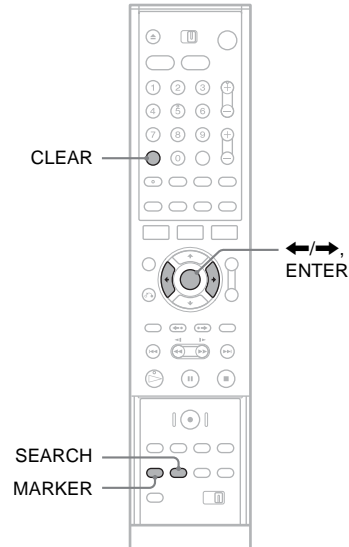

You can play back from the bookmarked scene. During playback, press SEARCH, and select the bookmark using \leftarrow/\rightarrow , then press ENTER.

To set a bookmark
During playback, press MARKER when you find a scene to be bookmarked.

To reset the bookmark
During playback, press SEARCH, and select the bookmark you want to reset using, then press \leftarrow/\rightarrow , then press CLEAR.

Note
When you eject the disc, the bookmark information is cleared.

Playing MP3 Audio Tracks

DATA CD

You can play MP3 audio tracks on DATA CDs (CD-Rs/CD-RWs).

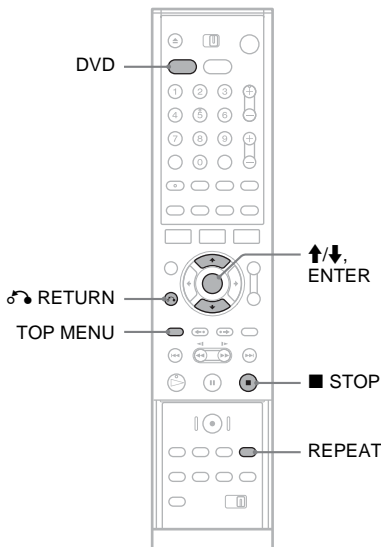

- 1 Press DVD to control the DVD recorder.
- 2 Place a DATA CD on the disc tray.
When you load a DATA CD which contains MP3 audio tracks and JPEG image files, the display for selecting a media type appears.

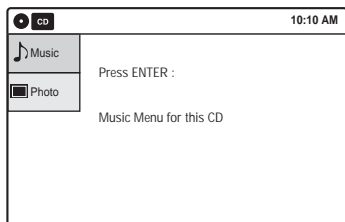

If you load a DATA CD which contains only MP3 audio files, the MP3 display appears. Then you can skip step 3.

- 3 Select "Music," then press ENTER.

- 4 Select the desired directory, then press ENTER.

- 5 Select the desired track, then press ENTER.

The selected track starts playing.
When a track or album is being played, the title is shown in a box.

To stop play

Press ■ STOP.

To play repeatedly

Press REPEAT repeatedly during playback.

Off: does not play repeatedly.

File: repeats the current track.

Folder: repeats the current album.

To return to the previous display

Press ⏪ RETURN.

To return to the display for selecting a media type

Press ■ STOP, then press TOP MENU.

About MP3 audio tracks

MP3 is audio compression technology that satisfies certain ISO/MPEG regulations.

You can play back DATA CDs (CD-Rs/CD-RWs) recorded in MP3 (MPEG1 Audio Layer 3) format. However, the discs must be recorded according to ISO9660 Level 1, Level 2 or Joliet format for the recorder to recognize the tracks. You can also play discs recorded in Multi Session.

See the instructions supplied with the CD-R/CD-RW drives and the recording software (not supplied) for details on the recording format.

Note on Multi Session discs

If MP3 audio tracks are recorded in the first session, the recorder will also play MP3 audio tracks in other sessions. If audio tracks in Music CD format are recorded in the first session, only the first session will be played back.

💡 Hints

- Since a disc with many trees takes longer to start playback, it is recommended that you create albums with no more than two trees.
- When playback of all the MP3 audio tracks within the album finishes, the recorder stops.

Notes

- The recorder may not be able to play some DATA CDs created in the Packet Write format.
- The recorder will play any data with the extension “.MP3,” even if they are not in MP3 format. Playing this data may generate a loud noise which could damage your speaker system.
- The recorder does not conform to audio tracks in MP3PRO format.
- The recorder can recognize up to 499 MP3 files within a single folder. The recorder may not recognize some discs depending on the recording device used for recording or the disc condition.
- The recorder can play MP3 audio tracks recorded in the following sampling frequencies: 32 kHz, 44.1 kHz, 48 kHz.
- ID3 tags cannot be displayed.
- Only alphabet and numbers can be used for album or track names. Anything else is displayed as an asterisk.

Playing JPEG Image Files

DATA CD

You can play JPEG image files on DATA CDs (CD-Rs/CD-RWs).

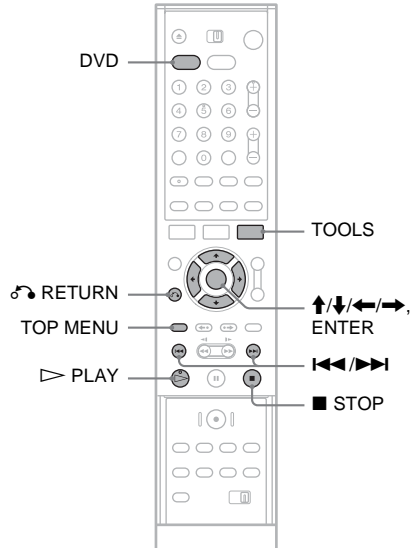

1 Press DVD to control the DVD recorder.

2 Place a DATA CD on the disc tray.

When you load a DATA CD which contains MP3 audio tracks and JPEG image files, the display for selecting a media type appears.

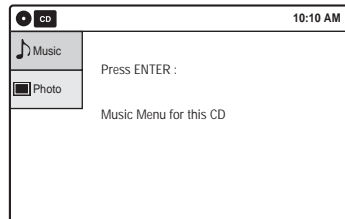

If you load a DATA CD which contains only JPEG files, the screen shown in step 3 appears. Skip to step 4.

3 Select "Photo," then press ENTER.

Directory information

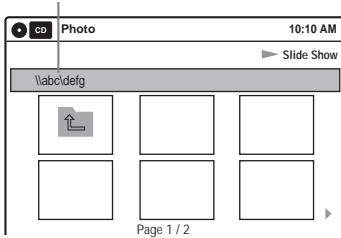

4 Press ◀◀/▶▶ to select the next/previous album page, then press ↑/↓/←/→ to select an image.

To display the selected image

- 1 Press ENTER.
The selected image is displayed over the entire screen.
- 2 To display the next/previous image, press ◀◀/▶▶.

To play the Slide show

- 1 Press ▷ PLAY.
You can also play the Slide show using the menu on the selected image.
For details, see "To enjoy the Slide show" on page 65.
- 2 Press ←/→ to select the desired playing speed on the "Slide Show Speed" menu, then press ENTER.
Slide show starts from the selected image.

To rotate the selected image

- 1 Press ↑/↓/←/→ to select an image in the "Index" display, then press ENTER.
- 2 Press ←/→ to select "🔄," then press ENTER.
Each time you press ENTER, the image turns clockwise by 90°.

To zoom in an image

- 1 Press ↑/↓/←/→ to select an image in the "Index" display, then press ENTER.
- 2 Press ←/→ to select "🔍," then press ENTER.
- 3 Press ENTER repeatedly to change the magnification. Each time you press ENTER, the magnification changes as shown below.
2× → 4× → 2× → normal magnification

To enjoy the Slide show

- 1 Press ↑/↓/←/→ to select an image in the "Index" display, then press ENTER.
- 2 Press ←/→ to select "📺," then press ENTER.
The "Slide Show Speed" menu appears.
"🔴": Slow
"🟡": Normal
"🟢": Fast
- 3 Press ←/→ to select the desired play speed, then press ENTER.
Slide show starts.

To turn on/off the menu in the single image display

Press TOOLS to turn off the menu.

To return to the previous display

Press ⏪ RETURN.

To return to the display for selecting a media type

Press ■ STOP, then press TOP MENU.

Notes

- Slide show can play in only one direction.
- You cannot rotate or zoom in the image during Slide show.
- If you select "🔄" in the rotated image display, the images in the "Index" display will not be rotated.

About JPEG image files

You can play JPEG image files on CD-Rs or CD-RWs. However, the discs must be recorded according to ISO9660 level 1 or level 2 for the player to recognize the files.

You can also play discs recorded in Multi Session. See the instructions of the CD-R/RW device or recording software (not supplied) for details on the recording format.

To play a Multi Session CD

This player can play Multi Session CDs when an JPEG image file is located in the first session. Any subsequent JPEG image files, recorded in the later sessions, can also be played back. When audio tracks and images in music CD format or video CD format are recorded in the first session, only the first session will be played back.

Hint

If you add numbers (01, 02, 03, etc.) to the front of the file names, the files will be played in that order.

Notes

- The system can play the extension “.JPG” or “.JPEG.”
- Some CD-Rs or CD-RWs cannot be played on this system depending on file format.
- If you add the extension “.JPG” or “.JPEG” to data not in JPEG format, “Can not Display” will appear.
- Depending on the disc or the size of image files, playback may take some time to start.
- The recorder can recognize up to 999 JPEG files within a single folder. The recorder may not recognize some discs depending on the recording device used for recording or the disc condition.
- Progressive and lossless compression JPEG image files are not supported.
- The image size that can be displayed is limited. You can display the following images;
width 32 – 7,680 pixels by height 32 – 8,192 pixels.

Before Recording

Before you start recording...

Check that the tape is longer than the recording time.

Hint

Timer recordings will start regardless of whether or not the recorder is turned on. You cannot turn off the recorder during a timer recording. The recorder automatically turns off after the timer recording finishes.

Note

This recorder shares a single tuner for both the DVD recorder and the VCR. You cannot record different programs to a DVD and a VHS tape at the same time.

Recording a stereo/SAP program

The recorder can receive and record stereo/SAP programs.

Stereo programs

When a stereo program is received, the “STEREO” indicator lights up in the front panel display. If there is noise in the stereo program, press AUDIO repeatedly until the “MONO” indicator disappears from the TV screen. The sound will be recorded in monaural but with less noise.

SAP (Second Audio Program)

When a SAP (Second Audio Program) is received, the “SAP” indicator lights up in the front panel display. To record only SAP sound, set “Tuner Audio” of “Audio” to “SAP” in the “Setup” display (page 102).

VCR Recording without the Timer

VHS

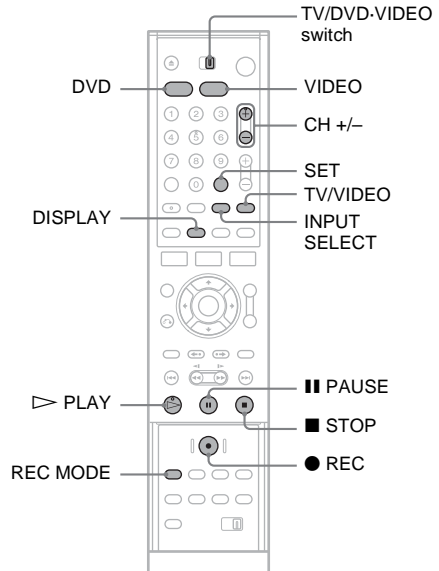

- 1 Press VIDEO to control the VCR.
- 2 Insert a tape with its safety tab in place.

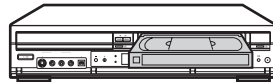

- 3 Press CH +/- or INPUT SELECT to select the channel or input source you want to record.
- 4 Press REC MODE repeatedly to select the tape speed, “SP” or “EP.”
“EP” (Extended Play) provides recording time three times as long as “SP” (Standard Play). However, “SP” produces better picture and audio quality.
- 5 Press ● REC.
“REC” appears in the front panel display and recording starts.

To stop recording

Press ■ STOP.

To pause recording

Press ■ PAUSE.

To restart recording, press ■ PAUSE again.

If you pause recording for more than 5 minutes, recording stops automatically.

To watch another TV program while recording

- 1 Slide the TV/DVD-VIDEO switch to TV.
- 2 Press TV/VIDEO to switch to the TV's antenna input.
- 3 Select another channel on the TV.

To watch a DVD while recording

Press DVD to control the DVD recorder, insert a disc, then press ▷ PLAY.

To save a recording

To prevent accidental erasure, break off the safety tab as illustrated. To record on the tape again, cover the tab hole with adhesive tape.

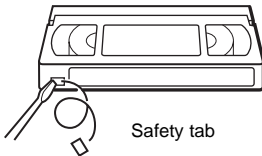

💡 Hints

- To select a channel, you can use the number buttons. Enter the channel number, and press SET.
- You can select a video source from the LINE 1 IN or LINE 2 IN jacks using the INPUT SELECT button.
- The display appears on the TV screen indicating information about the tape, but the information will not be recorded on the tape.
- If you do not want to watch TV while recording, you can turn off the TV. When using a cable box, make sure to leave it on.

Notes

- You cannot change the channel or input source of the recorder using CH +/- or INPUT SELECT while recording another TV program.
- If you insert a tape with its safety tab removed, the tape is ejected when you press ● REC.

Recording using the Quick Timer (One-touch Timer Recording)

You can set the recorder to record in 30 minute increments.

- 1 Press VIDEO to control the VCR.
- 2 Press ● REC repeatedly to set the duration.

Each press advances the time in 30 minute increments. The maximum duration is six hours.

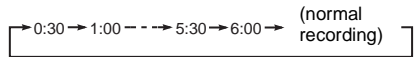

“OTR” (One-touch Timer Recording) and the remaining recording time are displayed in the front panel display while recording.

The time counter decreases minute by minute to 0:00, then the recorder stops recording (power turns off).

To cancel the Quick Timer

Press ● REC repeatedly until the counter appears in the front panel display. The recorder returns to normal recording mode.

To stop recording

Press ■ STOP twice.

💡 Hint

If you do not want to watch TV while recording, you can turn off the TV. When using a cable box or satellite receiver, make sure to leave it on.

Notes

- You cannot change the recording mode while recording.
- You cannot watch a TV program while recording another TV program.

Checking the remaining time

Press DISPLAY.

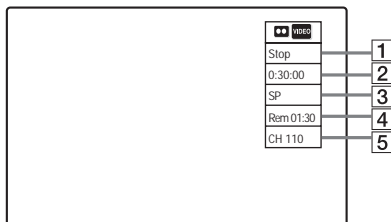

- 1 Play mode
- 2 Time counter
- 3 Recording mode
- 4 Remaining time
- 5 Current channel

To check the remaining time of a tape, set “VCR Function” – “Tape Length” of “Features” in the “Setup” display correctly (page 104).

Maximum recording time

Tape Length	SP	EP
T-120	2 hrs	6 hrs
T-160	2 hrs 40 mins	8 hrs
T-180	3 hrs	9 hrs

Notes

- The remaining tape length may not be indicated accurately for short tapes such as T-20 or T-30, or tapes recorded in LP mode.
- It may take up to one minute for the VCR to calculate and display the remaining tape length after you press DISPLAY.

VCR Timer Recording (Standard/VCR Plus+)

VHS

You can set the timer for a total of 12 programs together with DVD Timer Recording and VCR Timer Recording, up to one month in advance. There are two methods to set the timer: the standard method and VCR Plus+ method.

- Standard: Set the date, time, and channel of the program manually.
- VCR Plus+: Enter the PlusCode number designated for each TV program (page 71).

Note

Do not operate your cable box or satellite receiver just before or during a timer recording. This may prevent the accurate recording of a program.

Setting the timer manually (Standard)

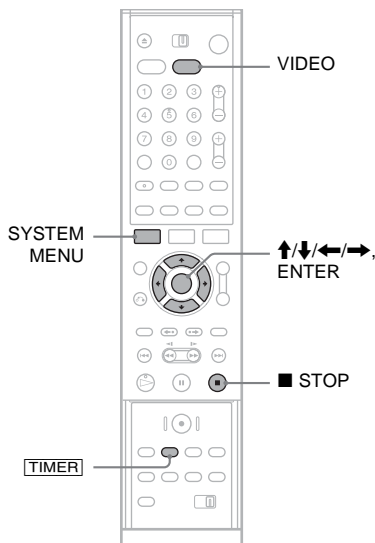

- 1 Press VIDEO to control the VCR.
- 2 Insert a tape with its safety tab in place.

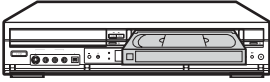

- 3 Press **TIMER**.

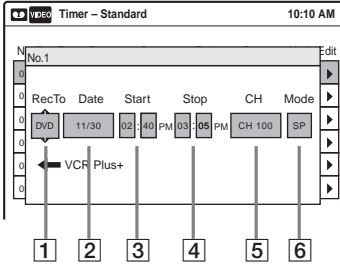

If the Timer programming (VCR Plus+) menu appears, press **←** to switch the display to "Standard."

- 4 Select an item using **←/→** and adjust using **↑/↓**.

- 1 "RecTo":
Select "VCR."
- 2 "Date":
Sets the date using **↑**.
To record the same program every day or the same day every week, press **↓**.
The item changes as follows:
Today **↔** Mon-Fri (Monday to Friday)
↔ Sun (every Sunday) **↔** Mon (every Monday) **↔** ... **↔** Sat (every Saturday)
↔ 1 month later **↔** ... **↔** Today
- 3 "Start":
Sets the start time.
- 4 "Stop":
Sets the stop time.
- 5 "CH":
Selects the channel or input source.

- 6 "Mode":
Selects the recording mode; "SP" or "EP." To use the Auto Tape Speed function, select "Auto." For details, see "To use the Auto Tape Speed function" on page 71.

If you make a mistake, select the item and change the setting.

- 5 Press **ENTER**.

The Timer List menu (page 74) appears. The **⊖** indicator lights up in the front panel display, and the recorder is ready to start recording. If the **⊖** indicator flashes in the front panel display, check that a tape with its safety tab in place is inserted. If the timer settings overlap, a message appears. To confirm, change, or cancel timer recording, see "Checking/Changing/Canceling VCR Timer Settings (Timer List)" on page 74.

- 6 Press **SYSTEM MENU** to exit the menu.

To stop recording

Press **■ STOP** twice.

If the timer settings overlap

The program that starts first has priority and the second program starts recording only after the first program has finished. If the programs start at the same time, the program listed first in the menu has priority.

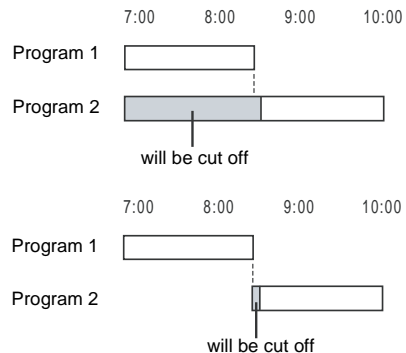

To confirm, change, or cancel timer recording

See "Checking/Changing/Canceling VCR Timer Settings (Timer List)" on page 74.

To use the Auto Tape Speed function

When you are recording a program in the Auto mode and the remaining tape becomes shorter than the recording time, the tape speed is automatically changed to EP mode. Note that some noise will appear on the picture when the tape speed is changed. If you want to keep the tape speed, select "SP." To operate this function, set "VCR Function" – "Tape Length" of "Features" in the "Setup" display correctly (page 104).

🔧 Hints

- When the start time and the channel or input source to be recorded are the same but the "RecTo" setting differs, the program is recorded to both the DVD disc and the VHS tape.
- You can also display the Timer programming menu as follows:
 - 1 Press SYSTEM MENU.
 - The System Menu appears.
 - 2 Select "Timer," and press ENTER.
 - 3 Select "Timer – Standard," and press ENTER.

Notes

- To record a cable or satellite program, turn on the cable box or satellite receiver and select the program you want to record. Leave the cable box or satellite receiver turned on until the recorder finishes recording.
- Even if the timer is set, timer recordings cannot be made while recording a program that has priority.
- You cannot record on a tape with its safety tab removed.
- Before the timer recording starts, "TIMER REC" flashes in the front panel display.

Recording TV programs using the VCR Plus+ system

The VCR Plus+ system is a feature that simplifies setting the timer. Just enter the PlusCode number listed in the TV program guide. The date, time, and channel of that program are set automatically. Before you start, check that the TV and guide channels are correctly set in "Guide Channel Setup" of "Tuner Preset" in the "Setup" display (page 98).

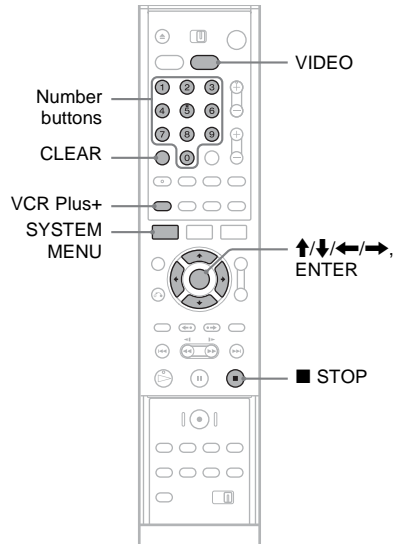

VCR Recording

- 1 Press VIDEO to control the VCR.
- 2 Insert a tape with its safety tab in place.
- 3 Press VCR Plus+.

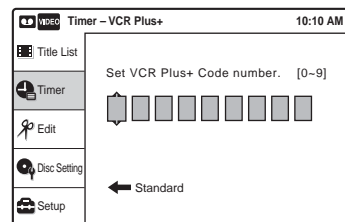

If the Timer programming (Standard) menu appears, press ← to switch the display to "VCR Plus+."

- 4** Press the number buttons to enter the PlusCode number.

If you make a mistake, press CLEAR and re-enter the correct number.

- 5** Press ENTER.

The date, start and stop times, channel, and recording mode appear.

The ⊖ indicator lights up in the front panel display, and the recorder is ready to start recording. If the ⊖ indicator flashes in the front panel display, check that a tape with its safety tab in place is inserted.

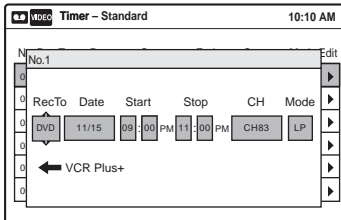

- 6** Select "RecTo" using ←/→ and select "VCR" using ↑/↓, and press ENTER.

If you want to change other settings, press ←/→ to select the item and press ↑/↓ to change the setting.

- 7** Press SYSTEM MENU to exit the menu.

To stop recording

Press ■ STOP twice.

If the timer settings overlap

See page 70.

To confirm, change, or cancel timer recording

See "Checking/Changing/Canceling VCR Timer Settings (Timer List)" on page 74.

🔔 Hint

You can also display the Timer programming menu as follows:

- 1 Press SYSTEM MENU.
- The System Menu appears.
- 2 Select "Timer," and press ENTER.
- 3 Select "Timer - VCR Plus+," and press ENTER.

Notes

- When the PlusCode number is incorrect, "Invalid code" appears on the TV screen.
- Before the timer recording starts, "TIMER REC" flashes in the front panel display.
- You cannot record on a tape with its safety tab removed.

Recording from Connected Equipment with a Timer (Synchro Rec)

VHS

You can set the recorder to automatically record programs from connected equipment that has a timer function (such as a satellite tuner). Connect the equipment to the LINE 1 IN jacks of the recorder (page 35).

When the connected equipment turns on, the recorder starts recording a program from the LINE 1 IN jacks.

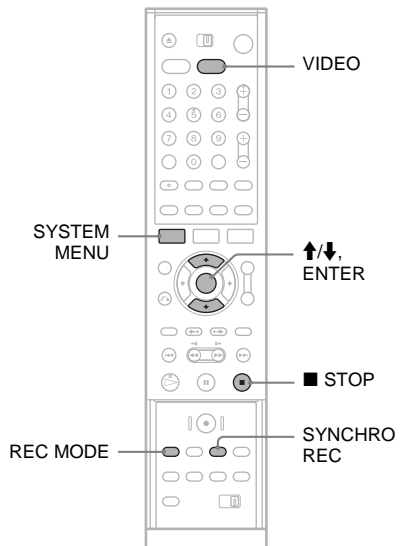

- 1 Press VIDEO to control the VCR.
- 2 Insert a tape with its safety tab in place.
- 3 Press REC MODE repeatedly to select the tape speed, "SP" or "EP."
"EP" (Extended Play) provides recording time three times as long as "SP" (Standard Play). However, "SP" produces better picture and audio quality.

- 4 Press **SYSTEM MENU** while the recorder is in stop mode.
- 5 Select "Setup," and press **ENTER**.
- 6 Select "Features," and press **ENTER**.
The "Features" setup appears.
- 7 Select "Synchro Recording," and press **ENTER**.
- 8 Select "to Video," and press **ENTER**.
- 9 Press **SYSTEM MENU** to exit the menu.
- 10 Set the timer on the connected equipment to the time of the program you want to record, and turn it off.
- 11 Press **SYNCHRO REC**.

The **SYNCHRO REC** indicator lights up on the front panel. The recorder is ready to start Synchro-Recording.

The recorder automatically starts recording when it receives an input signal from the connected equipment. The recorder stops recording when the connected equipment turns off.

To stop recording

Press **■ STOP** twice.

To cancel Synchro Rec function

Press **SYNCHRO REC**. The **SYNCHRO REC** indicator on the recorder turns off.

If you press **SYNCHRO REC** during Synchro-Recording, the Synchro-Recording stops, the **SYNCHRO REC** indicator turns off and the recorder's power turns off.

Notes

- The recorder starts recording only after detecting the video signal from the connected equipment. The beginning of the program may not be recorded regardless of whether or not the recorder's power is on or off.
- During Synchro-Recording, other operations such as normal recording cannot be done.
- To use the connected equipment while the recorder is standing by for Synchro-Recording, cancel Synchro-Recording by pressing **SYNCHRO REC**. Be sure to turn off the connected equipment and press **SYNCHRO REC** to reset Synchro-Recording before the timer recording starts.
- The Synchro Rec function does not work with some tuners. For details, see the tuner's operating instructions.
- While the recorder is standing by for Synchro-Recording, the Auto Clock Set function (page 99) does not work.
- To use the Synchro Rec function, you must first set the recorder's clock correctly.
- When the recorder's power is on, the recorder enters the Synchro-Recording standby mode after a Synchro-Recording has finished.
- You cannot record on a tape with its safety tab removed.

If the timer settings of a Synchro-Recording and another timer recording overlap

Regardless of whether or not the program is a Synchro Rec program, the program that starts first has priority and the second program starts recording only after the first program has finished.

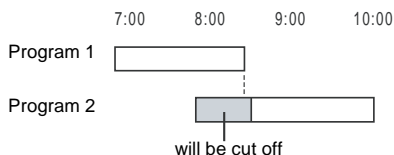

Checking/Changing/ Canceling VCR Timer Settings (Timer List)

VHS

You can check, change, or cancel timer settings using the Timer List menu.

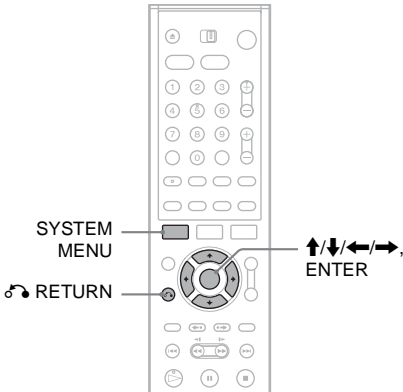

- 1 Press **SYSTEM MENU**.
The System Menu appears.
- 2 Select "Timer," and press **ENTER**.
- 3 Select "Timer List," and press **ENTER**.

No	RecTo	Date	Start	Stop	CH	Mode	Edit
01	VCR	11/17	09:00PM	10:00PM	CH8	LP	▶
02	VCR	11/28	09:15PM	09:45PM	CH1	LP	▶
03	---	--/--	--:--	--:--	----	---	▶
04	---	--/--	--:--	--:--	----	---	▶
05	---	--/--	--:--	--:--	----	---	▶
06	---	--/--	--:--	--:--	----	---	▶

Timer information displays the recording date, time, recording mode, etc.

- 4 Select the timer setting you want to check/change/cancel, and press **ENTER**.

The sub-menu appears.

No	RecTo	Date	Start	Stop	CH	Mode	Edit
01	VCR	11/17	09:00PM	10:00PM	CH8	LP	▶
02	VCR	11/28	09:15PM	09:45PM	CH1	LP	▶
03	---	--/--	--:--	--:--	----	---	▶
04	---	--/--	--:--	--:--	----	---	▶
05	---	--/--	--:--	--:--	----	---	▶
06	---	--/--	--:--	--:--	----	---	▶

- 5 Select one of the options, and press **ENTER**.

"Edit": Changes the timer setting. Select an item using **←/→** and adjust using **↑/↓**. Press **ENTER**.

No.	RecTo	Date	Start	Stop	CH	Mode	Edit
No.1	VCR	11/17	09:15 PM	09:45 PM	CH1	LP	▶
← VCR Plus+							

"Del": Erases the timer setting. Press **ENTER**.

No.	RecTo	Date	Start	Stop	CH	Mode	Edit
No.1	Do you want to erase "No.01"?						▶
<input type="button" value="OK"/> <input type="button" value="Cancel"/>							

To turn off the Timer List

Press **RETURN**.

Hint

While recording, you cannot modify the timer setting for the current recording.

Note

Even if the timer is set, timer recordings cannot be made while recording a program that has priority.

Recording from Connected Equipment without a Timer

VHS

You can record from a connected VCR or similar device. To connect other VCR or similar device, see “Connecting Another VCR or Similar Device” on page 34.

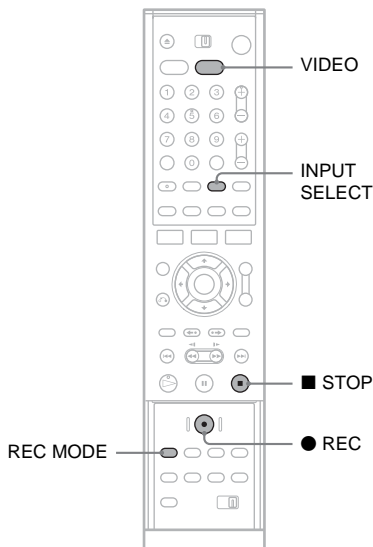

- 1 Press VIDEO to control the VCR.
- 2 Insert a tape with its safety tab in place.
- 3 Press INPUT SELECT to select an input source according to the connection you made.

The front panel display changes as follows:

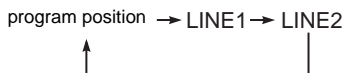

- 4 Press REC MODE repeatedly to select the tape speed, “SP” or “EP.”

“EP” (Extended Play) provides recording time three times as long as “SP” (Standard Play). However, “SP” produces better picture and audio quality.

- 5 Insert the source tape into the connected equipment and set to playback pause.

- 6 At the same time, press ● REC on this recorder and the pause or play button on the connected equipment.

Recording starts.

To stop recording, press ■ STOP on this recorder.

Notes

- When recording a video game image, the screen may not be clear.
- You cannot record on a tape with its safety tab removed.

Playing VHS Tapes

Playing

VHS

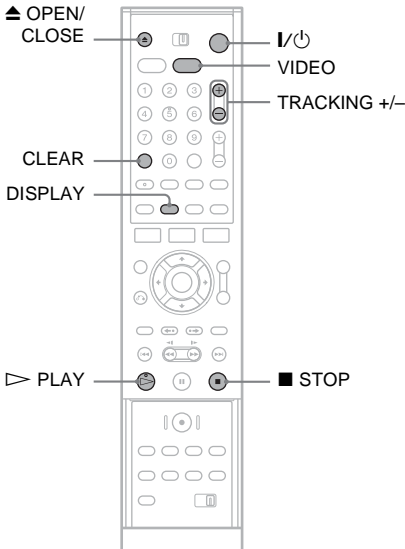

1 Press VIDEO to control the VCR.

2 Insert a tape.

The VCR starts playing automatically if you insert a tape with its safety tab removed.

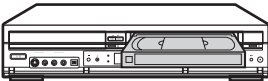

3 Press ▷ PLAY.

The display window shows the playback time. When the tape reaches the end, it will rewind automatically.

To stop playback

Press ■ STOP.

To eject the tape

Press ▲ OPEN/CLOSE.

To turn off the power while rewinding (Rewind Shut Off)

Press I/O while the tape is rewinding. The power will turn off but the tape will keep rewinding until it reaches the end.

To use the time counter

Press CLEAR at the point on the tape that you want to find later. The counter in the front panel display resets to "0:00:00." To search for the counter 0:00:00 point automatically, see "Searching for the counter 0:00:00 point" on page 79.

To display the counter on the TV screen, press DISPLAY.

Notes

- Tapes recorded in LP mode on other VCRs can be played back on this VCR but the picture quality cannot be guaranteed.
- The counter resets to "0:00:00" whenever a tape is reinserted.
- The counter stops counting when it comes to a portion with no recording.
- When 10 hours have passed, the counter in the front panel display returns to "0:00:00" and the count starts over again.
- When playback does not start even if you insert a tape with its safety tab removed, set "VCR Function" – "Auto Play" of "Features" to "On" in the "Setup" display (page 104).
- Stop disc playback while playing back a video.
- The VCR can also play S-VHS tapes. The VCR will automatically identify the type of tape inserted in the VCR (either VHS or S-VHS). When S-VHS tapes are played in the VCR, the enhanced resolution will not be visible on screen; there may also be picture distortion while playing the S-VHS tape in slow motion or while utilizing other special playback modes. The VCR will not record in S-VHS mode on an S-VHS tape.
- For details on the operation restrictions, see page 8.

Adjusting the picture (tracking)

Although the VCR automatically adjusts the tracking when playing a tape, distortion may occur if the recording is in poor condition. In this case, manually adjust the tracking.

Press TRACKING +/- to adjust the picture.

The tracking meter appears.

Press TRACKING +/- repeatedly until the distortion disappears.

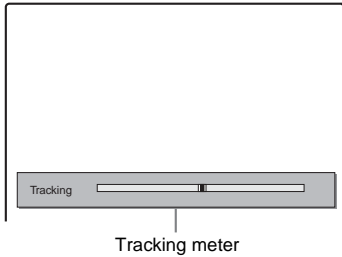





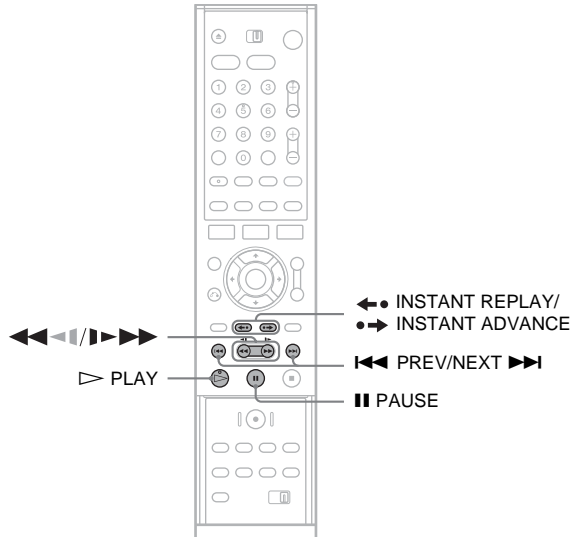

To resume automatic tracking adjustment

Press TRACKING + and TRACKING - at the same time.

Or, eject the tape and reinsert it.

Playback option



Buttons	Operations
 (fast reverse/fast forward)	<ul style="list-style-type: none"> • Fast reverses/fast forwards when pressed during stop. When you press and hold down the button during fast reverse/fast forward, you can view the picture. • Plays at high speed when briefly pressed during playback. When you press and hold down the button during playback, playing at high speed continues until you release the button.
 (slow)	Plays in slow motion when pressed in pause mode.
 INSTANT ADVANCE	<ul style="list-style-type: none"> • Plays frame by frame when pressed in pause mode. • Fast forwards the current scene for 30 seconds when pressed during playback.*1
 INSTANT REPLAY	Replays the previous scene when pressed during playback.*2
 PREV/ NEXT	Fast reverses/fast forwards when pressed during playback. Search speed changes as follows: -×7 ↔ -×5 ↔ -×3 ↔ STILL ↔ SLOW ↔ PLAY ↔ ×2 ↔ ×3 ↔ ×5 ↔ ×7
 PAUSE	Pauses playback. If you pause playback for more than 5 minutes, playback starts automatically.

*1 You can press  INSTANT ADVANCE up to 4 time. This allows you to fast forward up to 2 minutes in total.

*2 For 10 seconds in SP or LP mode/for 15 seconds in EP mode

To resume normal playback, press  PLAY.

Notes

- The sound is muted during playback at various speeds.
- The picture may show noise when playing at high speed in reverse.

Searching Using Various Functions

The VCR automatically marks the tape with an index signal at the point where each recording begins.

You can easily find a specific point using various search functions.

Note

You cannot use these search functions during DVD recording.

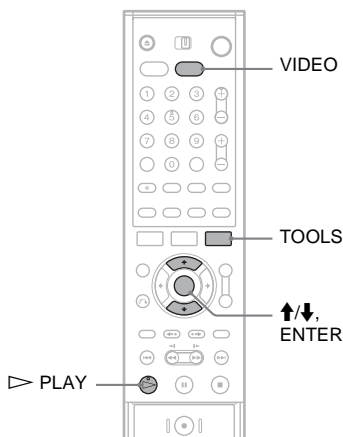

Searching for the counter 0:00:00 point

To mark a point on the tape that you want to find later, reset the tape counter to "0:00:00."

The VCR automatically fast-forwards or rewinds to the 0:00:00 point on the tape counter.

- 1 Press VIDEO to control the VCR.
- 2 Press TOOLS.
The TOOLS menu appears.

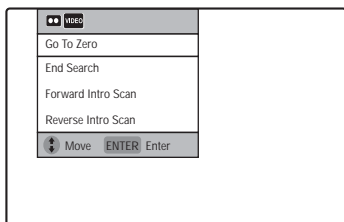

- 3 Select "Go To Zero," and press ENTER.

The VCR starts searching and automatically stops at the 0:00:00 point.

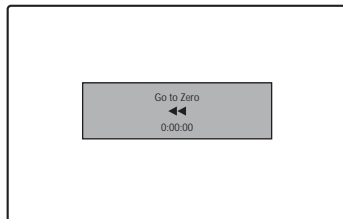

Searching for a blank space of the tape

The VCR automatically searches for the beginning of a blank space. You can easily find a point you can start recording from.

- 1 Press VIDEO to control the VCR.
- 2 Press TOOLS.
The TOOLS menu appears.

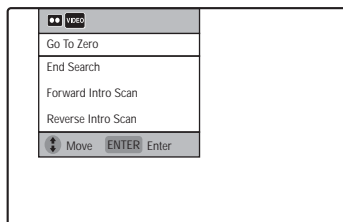

- 3 Select "End Search," and press ENTER.

The VCR starts searching and automatically stops at the beginning of a blank space. If no blank space is found, the VCR reaches the end.

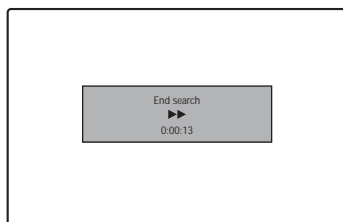

Note

The VCR may be unable to recognize the end of a blank space depending on the length of that blank space.

Searching using the index function (Scan and Play)

The VCR automatically marks the tape with an index signal at the point where each recording begins. Use these signals as references to find a specific recording.

- 1 Press VIDEO to control the VCR.
- 2 Press TOOLS.
The TOOLS menu appears.

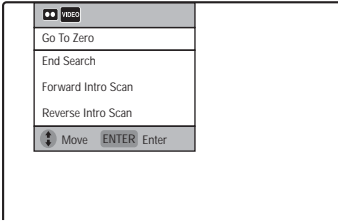

- 3 Select "Forward Intro Scan" to scan ahead, or "Reverse Intro Scan" to scan backwards.

The VCR searches and then plays back for about five seconds.

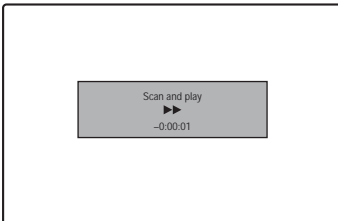

- 4 Press \triangleright PLAY to view that program.
If you do not press \triangleright PLAY, the VCR automatically searches for the next index mark, or until it reaches the end of the tape.

Note

Once in recording mode, if the VCR is put in pause and then released to start the recording, no index mark will be inserted. An index mark will be inserted if the channel is changed while VCR is put in pause.

Selecting the sound during playback

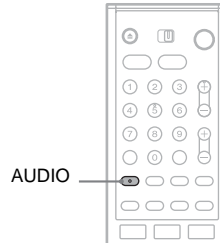

Press AUDIO repeatedly during playback.

To listen to	On-screen display	Front panel display
Stereo	Hi-Fi	STEREO
Left channel	Left	STEREO
Right channel	Right	STEREO
Monaural sound on the normal audio track	Mono	No indicator

How sound is recorded on a video tape

The VCR records sound onto two separate tracks. Hi-fi audio is recorded onto the main track along with the picture. Monaural sound is recorded onto the normal audio track along the edge of the tape.

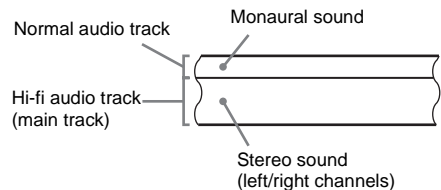

Notes

- To play a tape in stereo, you must use the A/V connections.
- When you play a tape recorded in monaural, the sound is heard in monaural regardless of the AUDIO setting.

Before Editing

This recorder offers various edit options for various disc types. Before you edit, check the disc type in the front panel display, and select the option available for your disc (page 10).

Note

You may lose the edited contents if you remove the disc or a timer recording starts while editing.

Edit options for DVD+RWs/DVD-RWs (Video mode)/DVD+Rs/DVD-Rs

+RW -RW_{video} +R -R

You can perform simple edits. Since Video mode titles are actual recordings on the disc, you cannot undo any edits you make. The edit functions available for Video mode titles are:

- Setting protection against erasure (page 82).
- Labeling a title (page 82).
- Erasing a title (page 82).

Notes

- Once the disc is finalized, you cannot edit or record on the disc (except for DVD+RWs).
- If a message appears and indicates that the disc's control information is full, erase unnecessary titles.

Edit options for DVD-RWs (VR mode)

-RWVR

You can enjoy advanced edit functions. First you have two options for a DVD-RW (VR mode): editing either the original recording (called the "original"), or the playback information created from the original (called a "Playlist"). Since each is different in nature and offers different merits, read the following and select the one that better suits your needs.

To edit original titles

Edits made to the original titles are final. If you plan to retain an unaltered original recording, create and edit a Playlist (see below). The edit functions available for original titles are:

- Labeling a title (page 82).
- Setting protection against erasure (page 82).
- Erasing a title (page 82).
- Erasing a section of a title (A-B Erase) (page 83).

To create and edit Playlist titles

A Playlist is a group of Playlist titles created from the original title for editing purposes. When you create a Playlist, only the control information necessary for playback, such as the playback order, is stored on the disc. Since the original titles are left unaltered, Playlist titles can be re-edited.

Example: You have recorded the final few matches of a soccer tournament on a DVD-RW (VR mode). You want to create a digest with the goal scenes and other highlights, but you also want to keep the original recording.

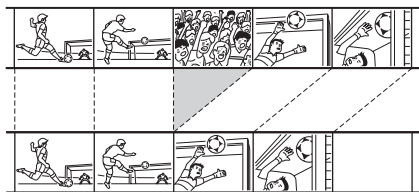

In this case, you can compile highlight scenes as a Playlist title. You can even rearrange the scene order within the Playlist title ("Creating a Playlist" on page 84).

The advanced edit functions available for Playlist titles are:

- Labeling a title (page 82).
- Erasing a title (page 82).
- Editing a Playlist scene (page 86).

Hint

You can display the disc's Playlist titles in the Title List (Playlist), or the original titles in the Title List (Original). To switch the two Title Lists, press TITLE LIST, and press ORIGINAL/PLAYLIST.

Notes

- You cannot protect Playlist titles.
- If a message appears and indicates that the disc's control information is full, erase unnecessary titles.

Editing a Title

+RW -RWVR -RWVideo +R -R

This section explains the basic edit functions. Note that editing is irreversible. To edit a DVD-RW (VR mode) without changing the original recordings, create a Playlist title (page 84).

Note

When editing a DVD+R, DVD-R, or DVD-RW (Video mode), finish all editing before finalizing the disc. You cannot edit a finalized disc.

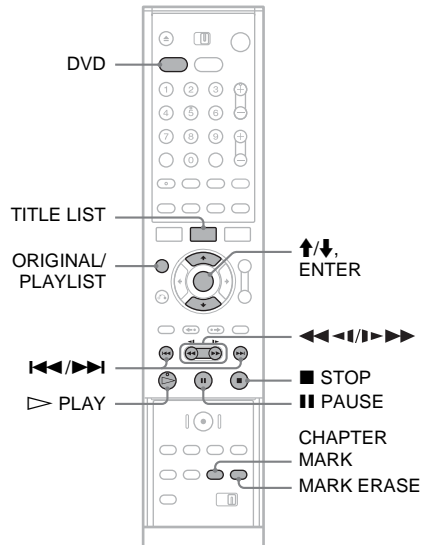

- 1 Press DVD to control the DVD recorder.
- 2 Press TITLE LIST.
When editing a DVD-RW in VR mode, press ORIGINAL/PLAYLIST to switch the "Title List(Original)," if necessary.
- 3 Select a title, and press ENTER.
The sub-menu appears.

- 4 Select an option, and press ENTER.**
 You can make the following edits to the title.
 “Erase”: Erases the selected title. Select “OK” when asked for confirmation.
 “Protect”: Protects the title. Select “On” when the Protection display appears. “On” appears next to the protected title. To cancel the protection, select “Off.”
 “Title Name”: Allows you to enter or re-enter a title name (page 46).
 “A-B Erase”: Erases a section of the title (see below).

Hint

You can label or re-label DVDs (page 43).

Note

You cannot protect Playlist titles.

Erasing a section of a title (A-B Erase)

-RW/VR

You can select a section (scene) in a title and erase it. Note that erasing scenes in a title cannot be undone.

- 1 Press DVD to control the DVD recorder.**
- 2 Press TITLE LIST.**
 Press ORIGINAL/PLAYLIST to switch the “Title List(Original),” if necessary.
- 3 Select a title, and press ENTER.**
 The sub-menu appears.
- 4 Select “A-B Erase,” and press ENTER.**
 The display for setting points A and B appears.
 “Start” is selected.

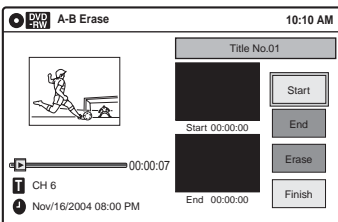

- 5 Press ENTER at the starting point of the portion to be erased (point A).**
 You can use ▷ PLAY, ◀◀◀◀/▶▶▶▶, ◀◀▶▶▶, ■ STOP and || PAUSE to find the point of the portion to be erased.
 “End” is selected.

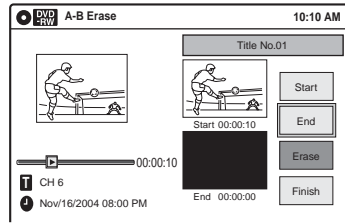

- 6 Press ENTER at the ending point of the portion to be erased (point B).**
 “Erase” is selected.
- 7 Select “Erase,” and press ENTER.**
 The display asks for confirmation.
- 8 Select “OK,” and press ENTER.**
 The scene is erased. To continue, repeat from step 5. To finish, select “Finish.”

Hint

A chapter mark is inserted after the scene was erased. The chapter mark divides the title into separate chapters on either side of the mark.

Notes

- Images or sound may be momentarily interrupted at the point where you erase a section of a title.
- Sections shorter than five seconds may not be erased.
- The start and end points of a title may be different from what you have set.
- The total playing time of the title does not change even if a scene was erased.

Creating chapters manually

+RW -RWVR

You can manually insert a chapter mark at any point you like during playback.

Press CHAPTER MARK at the point where you want to divide the title into chapters.

Each time you press the button, “Marking mark...” appears on the screen and the scenes before and after of the mark become separate chapters.

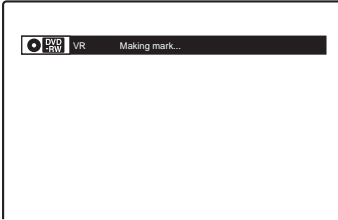

To erase chapter marks

You can combine two chapters by erasing the chapter mark during playback.

During playback, press MARK ERASE.

The current chapter combines with the previous chapter.

Note

If a message appears and indicates that no more chapter marks can be added, you may not be able to record or edit.

Creating a Playlist

-RWVR

You can add a section of the title to the Playlist title as one scene without changing the actual recordings. A Playlist title can contain up to 99 scenes.

For details, see “Edit options for DVD-RWs (VR mode)” on page 81.

Note

If you erase an original title used in a Playlist, that Playlist is also erased.

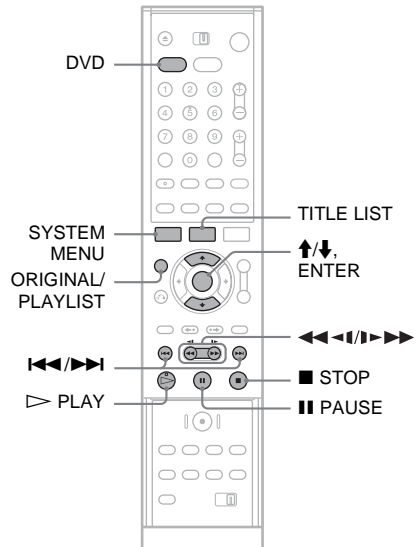

- 1 Press DVD to control the DVD recorder.
- 2 Press SYSTEM MENU while the recorder is stopped.

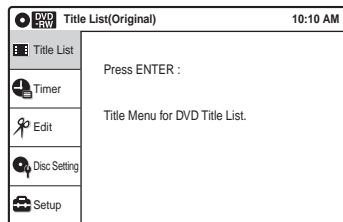

3 Select "Edit," and press ENTER.

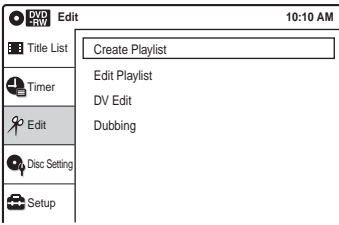

4 Select "Create Playlist," and press ENTER. "Start" is selected.

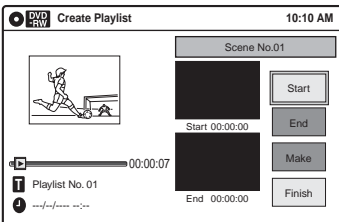

5 Press ENTER at the starting point. You can use ▷ PLAY, ◀◀◀/▶▶▶, ◀◀/▶▶, ■ STOP and || PAUSE to find the point. "End" is selected.

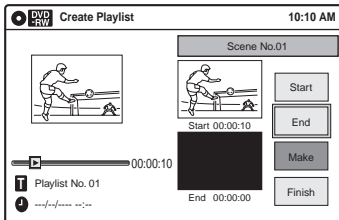

6 Press ENTER at the ending point. "Make" is selected. To reset the start or end point, select "Start" or "End" and repeat step 5 or 6.

7 Press ENTER. The selected section is captured as a scene. To continue, repeat the steps above.

8 When you finish capturing scenes, select "Finish" and press ENTER.

To play the Playlist title

- 1 Press TITLE LIST.
- 2 Press ORIGINAL/PLAYLIST to switch to the "Playlist."
- 3 Select a Playlist title, and press ENTER. The sub-menu appears.
- 4 Select "Play," and press ENTER.

💡 Hint

When a Playlist title is created, the start and end points will become chapter marks, and each scene will become a chapter.

Notes

- The picture may pause when the edited scene is played.
- The start and end points of a title may be different from what you have set.

Editing a Playlist

-RWVR

You can edit a scene of the Playlist titles.

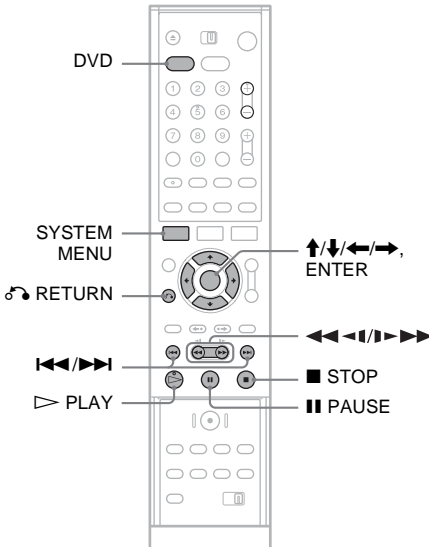

- 1 Press DVD to control the DVD recorder.
- 2 Press SYSTEM MENU while the recorder is stopped.

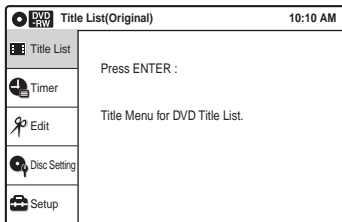

- 3 Select "Edit," and press ENTER.

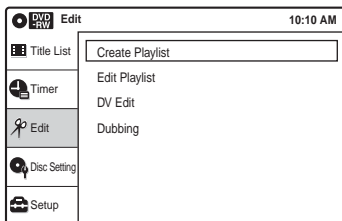

- 4 Select "Edit Playlist," and press ENTER.
The display for selecting Playlist titles appears.

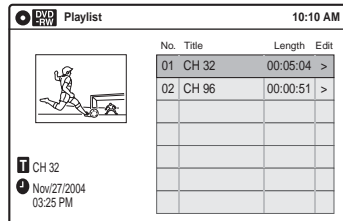

- 5 Select a Playlist title, and press ENTER.
The sub-menu appears.
- 6 Select an option, and press ENTER.
You can make the following edits to the title.
 - "Erase": Erases the selected Playlist title. Select "OK" when asked for confirmation.
 - "Title Name": Allows you to enter or re-enter a Playlist title name (page 46).
 - "Edit Scene": Allows you to re-edit without changing the actual recordings (see below).
 - "Title List": Switches to the "Title List(Original)."
- 7 Select "Edit Scene," and press ENTER.

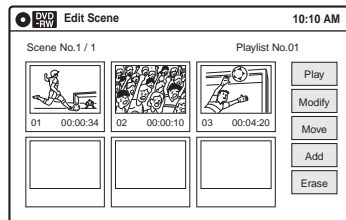

The Scene List menu appears with all of the selected scenes.

- "Modify": Allows you to change the start and end point of the selected scene. See "Modifying a scene (Modify)" on page 87.
- "Move": Changes the scene order. See "Moving a scene (Move)" on page 87.
- "Add": Allows you to add more scenes before the selected scene. See "Adding a scene (Add)" on page 88.
- "Erase": Erases the scene. The selection is canceled. See "Erasing a scene (Erase)" on page 88.

Modifying a scene (Modify)

-RWVR

You can change the start and end point of the selected scene.

- 1 After step 7 of "Editing a Playlist" on page 86, select a scene, and press ENTER.
- 2 Select "Modify," and press ENTER.
"Start" is selected.

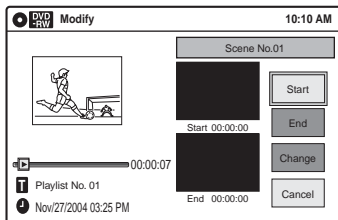

- 3 Press ENTER at the starting point.
You can use ▷ PLAY, ◀◀◀◀, ▶▶▶▶, ◀◀/▶▶, ■ STOP and || PAUSE to find the point.
"End" is selected.

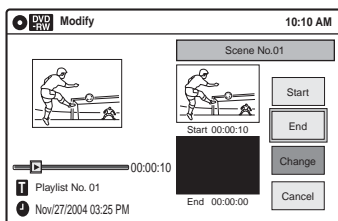

- 4 Press ENTER at the ending point.
"Change" is selected.
To reset the start or end point, select "Start" or "End" and repeat step 3 or 4.
- 5 Press ENTER.
The display returns to "Edit Scene" display.
The re-selected section is captured as a scene.
To modify other scenes, press ↶ RETURN, and repeat from step 1.

To cancel modifying

Select "Cancel," and press ENTER.

To turn off the display
Press SYSTEM MENU.

Note

The start and end point of a scene may be different from what you have set.

Moving a scene (Move)

-RWVR

You can change the scene order within the Playlist title.

- 1 After step 7 of "Editing a Playlist" on page 86, select a scene, and press ENTER.
- 2 Select "Move," and press ENTER.

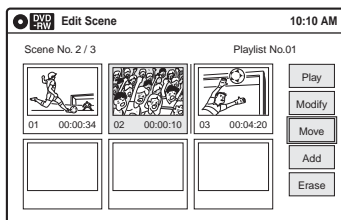

- 3 Select a new location using ◀/▶.
- 4 Press ENTER.
The selected scene moves to the new location.
To move other scenes press ↶ RETURN, and repeat from step 1.

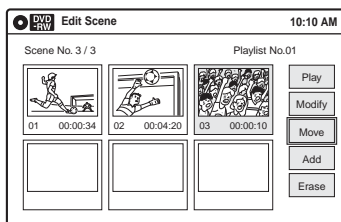

To turn off the display
Press SYSTEM MENU.

Adding a scene (Add)

-RWVR

You can add a scene before the selected scene.

- 1 After step 7 of “Editing a Playlist” on page 86, select a scene, and press ENTER.
- 2 Select “Add,” and press ENTER.
“Start” is selected.

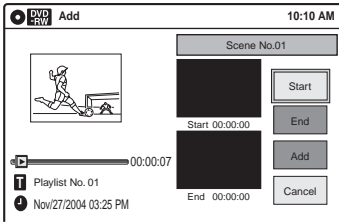

- 3 Press ENTER at the starting point.
You can use ▷ PLAY, ◀◀◀/▶▶▶, ◀◀/▶▶, ■ STOP and || PAUSE to find the point.
“End” is selected.

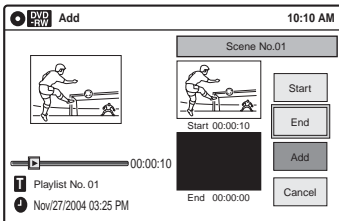

- 4 Press ENTER at the ending point.
“Add” is selected.
To reset the start or end point, select “Start” or “End” and repeat step 3 or 4.
- 5 Press ENTER.
The display returns to “Edit Scene” display.
The selected section is captured as a scene and added before the selected scene.
To add other scenes, press ↵ RETURN, and repeat from step 1.

To cancel adding

Select “Cancel,” and press ENTER.

To turn off the display

Press SYSTEM MENU.

Note

The start and end point of a scene may be different from what you have set.

Erasing a scene (Erase)

-RWVR

You can erase a selected scene.

- 1 After step 7 of “Editing a Playlist” on page 86, select a scene, and press ENTER.
- 2 Select “Erase,” and press ENTER.
The display asks for confirmation.
- 3 Select “OK,” and press ENTER.
The selected scene is erased.
To erase other scenes, press ↵ RETURN, and repeat from step 1.

To turn off the display

Press SYSTEM MENU.

Dubbing (TAPE ↔ DVD)

Dubbing from a Video to a DVD

+RW **-RWVR** **-RWVideo** **+R** **-R** **VHS**

You can record (dub) VHS tape video and audio to a disc. The audio switching and audio settings must be made for both the VHS tape and the disc.

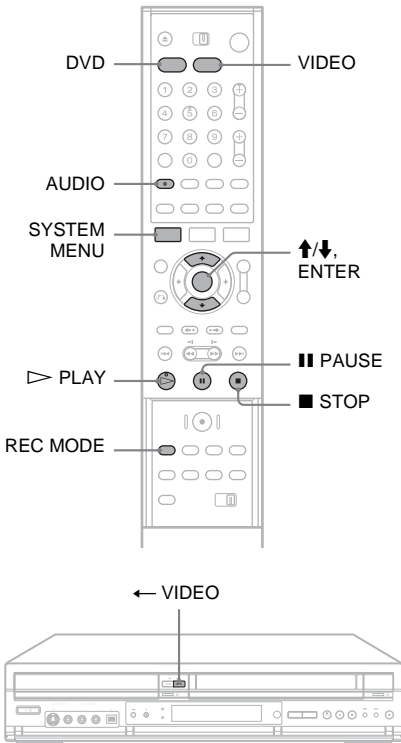

Using the ← VIDEO button on the recorder

- 1 Insert a recordable disc.
- 2 Insert a source tape.
- 3 Press ← VIDEO on the recorder. Dubbing starts.

Using the TV screen

- 1 Insert a recordable disc.
- 2 Insert a source tape.
- 3 Press DVD to control the DVD recorder.
- 4 Press SYSTEM MENU while the recorder is stopped.

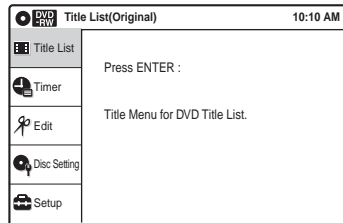

- 5 Select "Edit," and press ENTER.

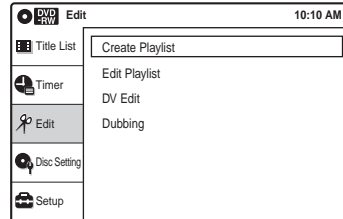

- 6 Select "Dubbing," and press ENTER.

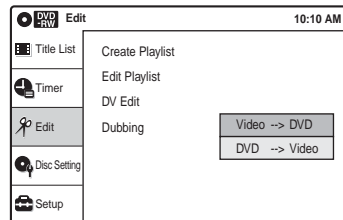

Dubbing (TAPE ↔ DVD)

7 Select "Video → DVD," and press ENTER.

The display for confirmation appears.

8 Select "OK," and press ENTER.

Dubbing starts.

To select the recording mode

Press DVD to control the DVD recorder, then press REC MODE repeatedly.

Each time you press the button, the display changes on the TV screen as follows:

HQ → HSP → SP → LP → EP → SLP
↑

For more details about the recording mode, see page 47.

To select the sound

- 1 After step 2 above, press VIDEO to control the VCR.
- 2 Press ▷ PLAY.
- 3 Press AUDIO repeatedly to select the sound you want.
For details, see page 80.
- 4 Press ■ PAUSE.
- 5 Follow the instructions above from step 3.

To stop dubbing

Press ■ STOP.

Note that it may take a few seconds for the recorder to stop dubbing.

To play discs recorded with this recorder on other DVD equipment

Finalize the disc. For details, see page 44.

💡 Hints

- A black screen is recorded at the end of the dubbed disc, but this is not a malfunction. When dubbing stops, there may be some time difference between the tape and the disc. In this case, a black (no signal) screen is recorded.
- You can switch the playback tape audio while dubbing.
- When dubbing a VHS tape to a disc, the VHS tape counter value may differ slightly from the DVD recording time.
- The audio output is the VHS playback audio.

Notes

- Dubbing is not possible in the following cases.
 - When a non-recordable DVD is set.
 - When using VHS software with copy guard functions.
- Dubbing stops in the following cases.
 - When the VHS tape is played back to the end and stops.
 - When the VHS deck or the DVD deck is stopped.
 - When the disc remaining time runs out.
- The System menu, TOOLS menu, and information display are not displayed during dubbing.
- Copyrights
 - Recordings made from VHS tapes and other copyrighted material are solely for individual enjoyment, and other unauthorized use is prohibited under copyright law.
 - Unauthorized editing of copyrighted material is prohibited under copyright law.

Dubbing from a DVD to a Video

+RW **-RWVR** **-RWVideo** **+R** **-R** **DVD**
VHS

You can record (dub) DVD video and audio to a VHS tape. However, note that when you record copy-protected software to a tape, the video may appear disrupted when you play back the tape.

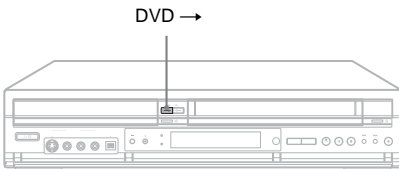
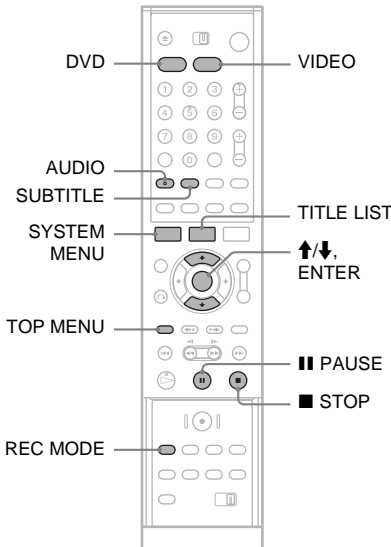

Using the DVD → button on the recorder

- 1 Insert a tape with its safety tab in place.
- 2 Insert a source disc.
- 3 Press DVD to control the DVD recorder.
- 4 Press TOP MENU or TITLE LIST, and select a title.
- 5 Start playing, and press ■ STOP or || PAUSE.
- 6 Press DVD → on the recorder. Dubbing starts.

Using the TV screen

- 1 Insert a tape with its safety tab in place.
- 2 Insert a source disc.
- 3 Press DVD to control the DVD recorder.
- 4 Press TOP MENU or TITLE LIST, and select a title.
- 5 Start playing, and press ■ STOP or || PAUSE.
- 6 Press SYSTEM MENU.

Dubbing (TAPE ↔ DVD)

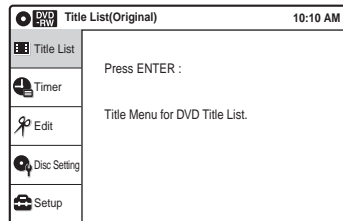

- 7 Select "Edit," and press ENTER.

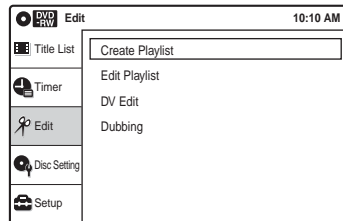

8 Select “Dubbing,” and press ENTER.

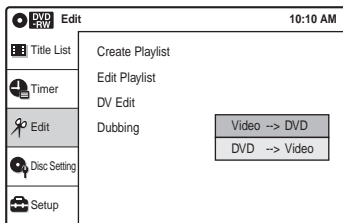

9 Select “DVD → Video,” and press ENTER.

The display for confirmation appears.

10 Select “OK,” and press ENTER.

Dubbing starts.

The disc’s menu may appear depending on the disc when playback of a disc finishes. In this case, press ■ STOP to stop dubbing, otherwise the disc’s menu is recorded until the tape reaches its end.

Notes

- Dubbing is not possible when “Video” of “Progressive” is set to “On” in the “Setup” display.
- Dubbing stops in the following cases.
 - When the DVD is played back to the end and stops.
 - When the DVD deck or the VHS deck is stopped.
 - When the tape remaining time runs out.
- The System menu, TOOLS menu, and information display are not displayed during dubbing.
- Copyrights
 - Recordings made from discs and other copyrighted material are solely for individual enjoyment, and other unauthorized use is prohibited under copyright law.
 - Unauthorized editing of copyrighted material is prohibited under copyright law.

To select the tape speed

Press VIDEO to control the VCR, then press REC MODE repeatedly to select “SP” or “EP.”

“EP” (Extended Play) provides recording time three times as long as “SP” (Standard Play).

However, “SP” produces better picture and audio quality.

To select the sound or language

After step 5 above, press AUDIO repeatedly to select the sound you want, or press SUBTITLE repeatedly to select the language you want. For details, see page 59.

To stop dubbing

Press ■ STOP.

Note that it may take a few seconds for the recorder to stop dubbing.

🔧 Hints

- You can switch the playback DVD audio while dubbing.
- The brightness of the playback video may differ from that during normal DVD playback.
- The DVD playback time may differ slightly from the VHS tape counter value.
- The audio being played back (main audio, sub audio, etc.) is the dubbed audio.

Before DV Dubbing

This section explains dubbing with a digital video camera via the DV IN jack on the front panel. If you want to dub by way of the LINE IN jacks, see “Recording from Connected Equipment with a Timer (Synchro Rec)” on page 53.

To record from the DV IN jack

The DV IN jack on this recorder conforms to the i.LINK standard. You can connect any other equipment that has an i.LINK (DV) jack, and record digital signals.

Follow the instructions in “Connecting a Digital Video Camera to the DV IN Jack,” and then move on to the section on dubbing. For more information about i.LINK, see “About i.LINK” on page 115.

Hint

If you plan to do additional editing on a disc after the initial dub, use the DV IN jack and record on a DVD-RW (VR mode).

Note

When selecting DV input, lines appear on the screen. This is not a malfunction. Connect a digital video camera and display an image. These lines disappear.

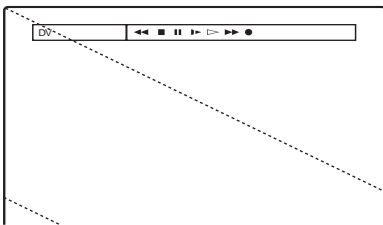

Connecting a Digital Video Camera to the DV IN Jack

You can connect a digital video camera to the DV IN jack on the recorder to record or edit from a DV format tape. Operation is straightforward because the recorder will fast forward and rewind the tape for you – you do not need to operate your digital video camera. Do the following to start using the “DV Edit” functions of this recorder.

See the instruction manual supplied with the digital video camera as well before connecting.

Notes

- The DV IN jack is for input only. It will not output signals.
- You cannot use the DV IN jack when:
 - your digital video camera does not work with this recorder. Connect the camera to the LINE IN jack and follow the instructions of “Recording from Connected Equipment without a Timer” on page 56.
 - the input signal is not in DVC-SD format. Do not connect a MICRO MV format digital video camera even if it has an i.LINK jack.
 - the images on the tape contain copy protection signals, which limit recording.

VCR-DVD recorder

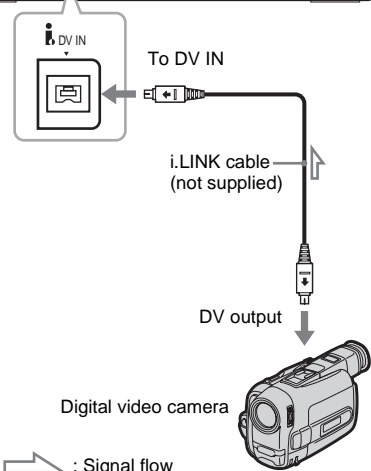
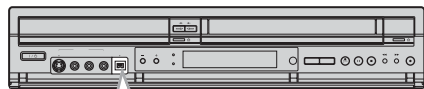

Dubbing from a DV Format Tape to a DVD

+RW -RWVR -RW_{video} +R -R

You can record a DV format tape onto a disc. The recorder controls the digital video camera. You can fast forward, rewind, play in slow motion, and stop the tape to select the scenes using the recorder's remote control.

◆How chapters are created

The recorder divides the title in either 5 or 15-minute intervals, according to the setting in "DVD Auto Chapter" in "Features" setup (page 104).

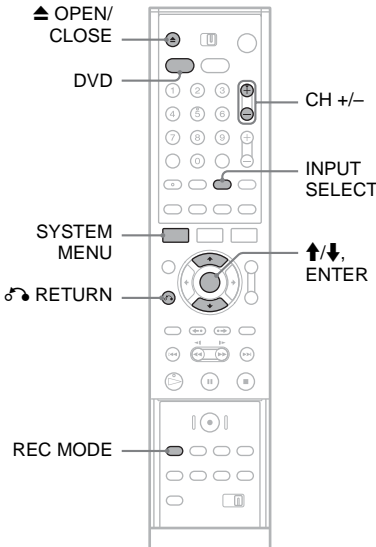

- 1 Press DVD to control the DVD recorder.
- 2 Press \blacktriangle OPEN/CLOSE, and place a recordable disc on the disc tray.



With the recording side facing down

- 3 Press \blacktriangle OPEN/CLOSE to close the disc tray.
Wait until "LOAD" disappears from the front panel display.
Unused DVD-RWs are formatted in VR mode automatically.
To format in Video mode, see page 43.

- 4 Insert the source DV format tape into your digital video camera.
For the recorder to record or edit, your digital video camera must be set to video playback mode.

- 5 Press INPUT SELECT repeatedly to select "DV."

- 6 Press REC MODE repeatedly to select the recording mode.

Each time you press the button, the display changes on the TV screen as follows:

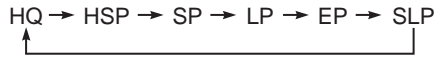

For more details about the recording mode, see page 47.

- 7 Press SYSTEM MENU while the recorder is stopped.

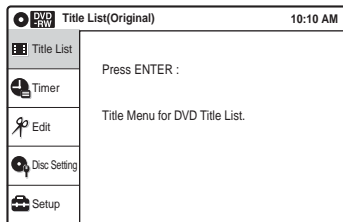

- 8 Select "Setup," and press ENTER.

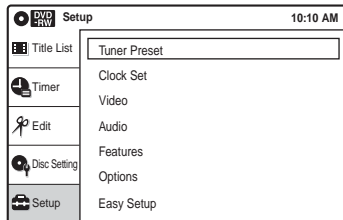

9 Select "Audio," and press ENTER.

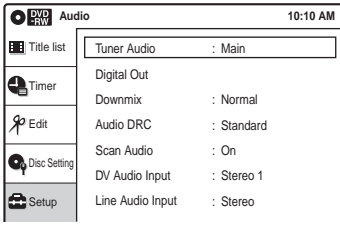

10 Select "DV Audio Input," and press ENTER.

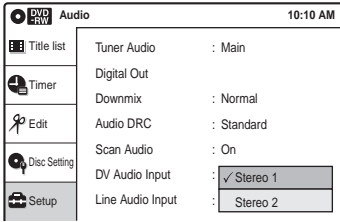

"Stereo 1": Records original sound only. Normally select this when dubbing a DV format tape.

"Stereo 2": Records additional audio only. Select "Stereo 2" if you have added a second audio channel when recording with your digital video camera.

11 Select "Stereo 1" or "Stereo 2," and press ENTER.

12 Press RETURN twice.

13 Select "Edit," and press ENTER.

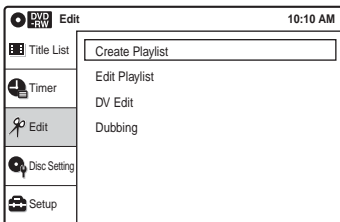

14 Select "DV Edit," and press ENTER.

The display for recording and "DV Tape Mode" appear.

If "DV Tape Mode" does not appear, check the connection to your digital video camera.

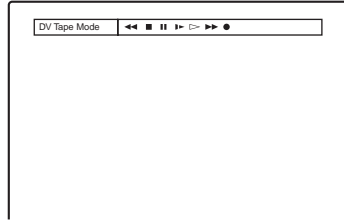

15 Select ● on the TV screen, and press ENTER.

Starts recording the tape contents.

You can use ◀◀, ■, ||, ▶▶, ▷, ▶▶▶, and ● on the TV screen to search the point you want to start recording.

To stop during recording

Select ■ on the TV screen, and press ENTER.

Note that it may take a few seconds for the recorder to stop recording.

To turn off the display for recording

Press INPUT SELECT or CH +/-.

Notes

- If you want to play the disc on other DVD equipment, finalize the disc (page 44).
- You cannot connect more than one piece of digital video equipment to the recorder.
- You cannot control the recorder using another device or another recorder of the same model.
- You cannot record date, time, or the contents of the cassette memory onto the disc.
- If you record from a DV format tape with a sound track that is recorded in multiple sampling frequencies (48 kHz, 44.1 kHz, or 32 kHz), no sound or an unnatural sound will be output when playing back the sampling frequency switch point on the disc.
- The recorded picture may be momentarily affected if the picture size of the source image changes, or if there is nothing recorded on the tape.
- Noise may occur when you switch the audio sampling mode (48 kHz/16 bits → 32 kHz/12 bits).

Settings and Adjustments

Using the Setup Displays

By using the setup displays, you can make various adjustments to items such as picture and sound, as well as select a language for the subtitles. The setup displays are used in the following way.

Note

Playback settings stored in the disc take priority over the setup display settings, and not all of the functions described may work.

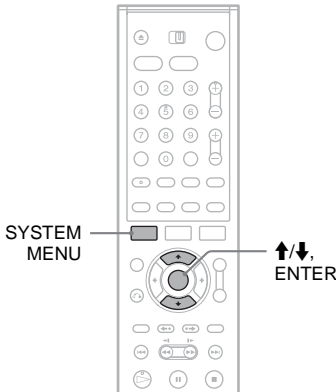

- 1 Press **SYSTEM MENU** while the recorder is in stop mode.

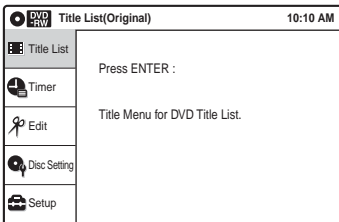

- 2 Select **"Setup,"** and press **ENTER**. The **"Setup"** display appears.

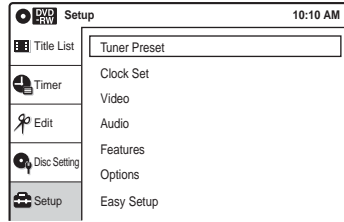

- 3 Select **"Tuner Preset," "Clock Set," "Video," "Audio," "Features," "Options," or "Easy Setup,"** and press **ENTER**. The selected setup display appears. Example: **"Video"** setup

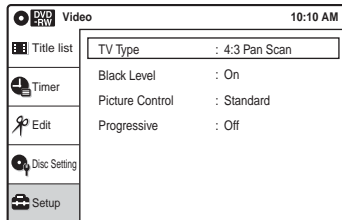

- 4 Select the item you want to set up, and press **ENTER**. Available options for the item appear. Example: **"TV Type"**

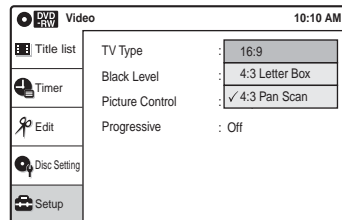

Some items display a dialog box that provides further detailed settings.

Example: The following dialog box appears when “Parental” in “Options” setup is selected.

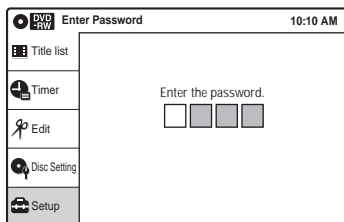

In this case, see “Parental” in “Language, Parental Control Settings/Factory Settings (Options)” on page 105.

5 Select an option, and press ENTER.

The currently selected option is displayed next to the setup item.

Example: when “16:9” is set.

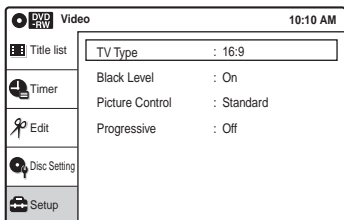

To turn off the display

Press SYSTEM MENU.

Antenna Reception Setting (Tuner Preset)

The “Tuner Preset” setup helps you to make tuner, setting for the recorder.

Select “Tuner Preset” in the “Setup” display. To use the display, see “Using the Setup Displays” on page 96.

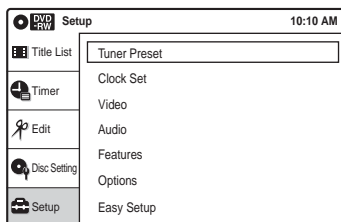

Note

You cannot presets channels for the connected cable box or satellite receiver.

Auto Preset

Automatically presets the receivable channels. The recorder can receive VHF channels 2 to 13, UHF channels 14 to 69, and unscrambled CATV channels 1 to 125. First, we recommend that you preset the receivable channels in your area using automatic presetting methods.

- 1 Follow steps 1 to 3 of “Using the Setup Displays” on page 96 to select “Tuner Preset” in the “Setup” display.
- 2 Select “Antenna/Cable,” and press ENTER.

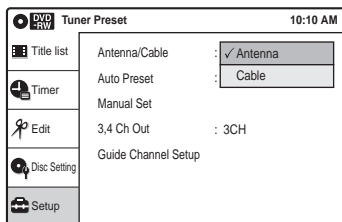

“Antenna”: Presets VHF and UHF channels.
“Cable”: Presets cable TV channels.

- 3 Select an option, and press ENTER.

- 4 Select “Auto Preset,” and press ENTER. All receivable channels are preset in numerical sequence.

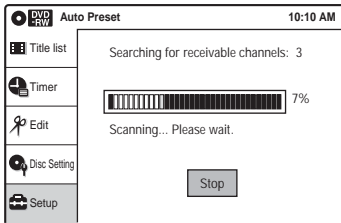

Manual Set

Presets or disables channels manually. If some channels could not be set using the Auto Preset or Easy Setup function, you can set them manually.

- 1 Follow steps 1 to 3 of “Using the Setup Displays” on page 96 to select “Tuner Preset” in the “Setup” display.
- 2 Select “Antenna/Cable,” and press ENTER.

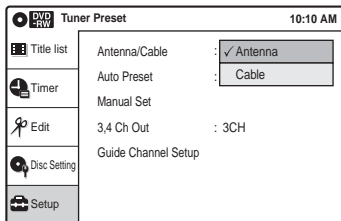

“Antenna”: Presets VHF and UHF channels.
 “Cable”: Presets cable TV channels.

- 3 Select an option, and press ENTER.
- 4 Select “Manual Set,” and press ENTER.
- 5 Select the channel you want to preset/disable using \uparrow/\downarrow or CH +/-, and press ENTER.

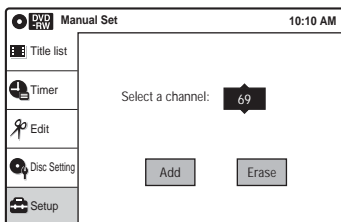

- 6 Select “Add” or “Erase” using \leftarrow/\rightarrow , and press ENTER.
- 7 To preset or disable another channel, repeat steps 5 and 6.

3, 4 Ch Out

Set the RF output channel so that the TV can receive the correct signal from the recorder. For details, see page 19.

- 1 Follow steps 1 to 3 of “Using the Setup Displays” on page 96 to select “Tuner Preset” in the “Setup” display.
- 2 Select “3, 4 Ch Out,” and press ENTER.

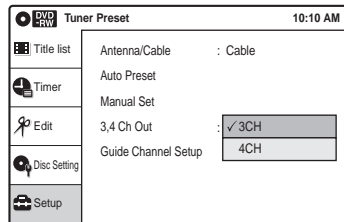

“3CH”: when using channel 3 to receive the recorder signal.

“4CH”: when using channel 4 to receive the recorder signal.

- 3 Select “3CH” or “4CH,” and press ENTER. The confirmation messages will be displayed for a while.

Guide Channel Setup

Sets up the guide channel number assigned to each channel.

You need to set this correctly to make timer recordings with the VCR Plus+ function. For details, see page 32.

Clock Setting (Clock Set)

The “Clock Set” setup helps you to make clock setting for the recorder.

Select “Clock Set” in the “Setup” display. To use the display, see “Using the Setup Displays” on page 96.

Auto (Auto Clock Set)

Turns on the Auto Clock Set function when a channel in your local area broadcasts a time signal.

- 1 Follow steps 1 to 3 of “Using the Setup Displays” on page 96 to select “Clock Set” in the “Setup” display.
- 2 Select “Auto,” and press ENTER.

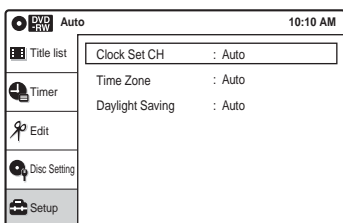

- 3 Select “Clock Set CH,” “Time Zone,” or “Daylight Saving” and press ENTER.
- 4 Adjust these settings by pressing \uparrow/\downarrow and ENTER.

◆ Clock Set CH

Select a channel that carries a time signal using \uparrow/\downarrow .

Use this option if you know of a channel that carries a time signal. Most PBS member stations broadcast a time signal. For the fastest response select your local PBS station. Leave the setting at “Auto” to have the recorder automatically search for a channel that carries a time signal.

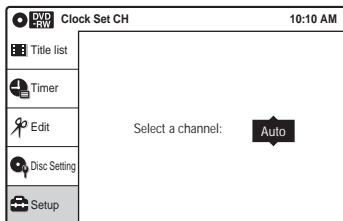

◆ Time Zone

Select the time zone for your area, or select “Auto” to have the recorder automatically set your time zone.

The options are:

Auto \leftrightarrow Atlantic \leftrightarrow Eastern \leftrightarrow Central
 \leftrightarrow Mountain \leftrightarrow Pacific \leftrightarrow Alaska \leftrightarrow
Hawaii \leftrightarrow Auto

◆ Daylight Saving

Select “On” or “Off” (standard time), or select “Auto” to have the recorder automatically set the daylight saving time.

Manual

If the Auto Clock Set function did not set the clock correctly for your local area, set the clock manually.

- 1 Follow steps 1 to 3 of “Using the Setup Displays” on page 96 to select “Clock Set” in the “Setup” display.
- 2 Select “Manual,” and press ENTER.

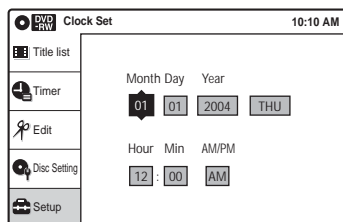

- 3 Press \uparrow/\downarrow to set the month, and press \rightarrow . Set the day, year, minutes, and AM/PM in sequence. Press \leftarrow/\rightarrow to select the item to be set, then press \uparrow/\downarrow to set the numbers. The day of the week is set automatically.
- 4 Press ENTER to start the clock.

💡 Hint

To change the numbers in step 3, press \leftarrow to return to the item to be changed, and select the numbers by pressing \uparrow/\downarrow .

Video Settings (Video)

Video settings will adjust items related to the image, such as size and color.

Choose the settings according to the type of TV, tuner, or decoder connected to the recorder.

1 Press **SYSTEM MENU** while the recorder is in stop mode.

2 Select **"Setup,"** and press **ENTER**.

3 Select **"Video,"** and press **ENTER**.

The "Video" setup appears with the following options. The default settings are underlined>.

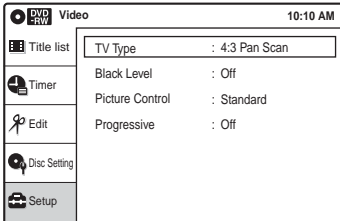

TV Type

Selects the aspect ratio of the connected TV (4:3 standard or wide).

16:9	Select this when connecting to a wide-screen TV or TV with a wide mode function.
4:3 Letter Box	Select this when connecting to a 4:3 screen TV. Displays a wide picture with bands on the upper and lower portions of the screen.
4:3 Pan Scan	Select this when connecting to a 4:3 screen TV. Automatically displays a wide picture on the entire screen and cuts off the portions that do not fit.

16:9



4:3 Letter Box



4:3 Pan Scan



Note

Depending on the disc, "4:3 Letter Box" may be selected automatically instead of "4:3 Pan Scan" or vice versa.

Black Level



Selects the black level (setup level) for the video signals output from the LINE OUT jacks (page 18).

This setting is not effective when the PROGRESSIVE indicator lights up in the front panel and the recorder outputs progressive signals.

<u>On</u>	Raises the standard black level. Select this when the picture appears too dark.
Off	Sets the black level of the output signal to the standard level. Normally, select this.

Picture control

You can adjust the video signal of the DVD or VIDEO CD (with PBC function off) from the player to obtain the picture quality you want. Select the setting that best suits the program you are watching.

Dynamic 1	Produces a bold dynamic picture by increasing the picture contrast and the color intensity.
Dynamic 2	Produces a more dynamic picture than Dynamic 1 by further increasing the picture contrast and the color intensity.
<u>Standard</u>	Off Displays a standard picture.
Cinema 1	White colors become brighter and black colors become richer, and the color contrast is increased.
Cinema 2	Enhances details in dark areas by increasing the black level.
Personal Adjust	Adjusts "Contrast," "Brightness," "Color," and "Hue" using  /  /  .

Hint

When you watch a movie, "Cinema 1" or "Cinema 2" is recommended.

Progressive

If your TV accepts progressive (480p) format signals, you will enjoy accurate color reproduction and high quality image.

- 1 Follow steps 1 to 3 of "Video Settings (Video)" on page 100.
- 2 Select "Progressive," and press ENTER.
- 3 Select "On," and press ENTER.
- 4 Follow the instructions appearing on the TV screen.
 - 1 Ensure your TV is (480p) Progressive Scan capable.
 - 2 Connect with Component Video Output jacks (red/green/blue connections). See "If your TV has component video input jacks" on page 21.
 - 3 Select [OK] to test your video signal.
 - 4 If video signal appears OK, video connection is complete.

- 5 Press ENTER.

The PROGRESSIVE indicator on the recorder lights up.

If picture is distorted, press  RETURN.
Check the connection (page 21).

Hint

The "Progressive" setting can be canceled by pressing  PAUSE on the recorder continuously for 5 seconds or more, or selecting "Off" in step 3.

Note

If you select progressive signal when you connect the recorder to a TV that cannot accept the signal in progressive format, the image quality will deteriorate. In this case, set "Progressive" to "Off."

Audio Settings (Audio)

The Audio setup allows you to adjust the sound according to the playback and connection conditions.

- 1 Press **SYSTEM MENU** while the recorder is in stop mode.
- 2 Select **"Setup,"** and press **ENTER**.
- 3 Select **"Audio,"** and press **ENTER**.
The "Audio" setup appears with the following options. The default settings are underlined>.

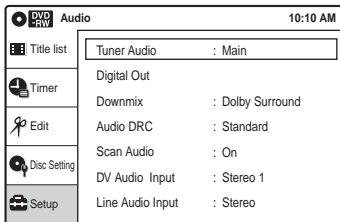

Tuner Audio

Selects the sound to be recorded.

<u>Main/Sub</u>	Records only the main sound.
SAP	Records only the SAP (Second Audio Program) sound.

Note

If no SAP sound is received, the main sound is recorded regardless of the setting.

Digital Out

The following setup items switch the method of outputting audio signals when you connect a component such as an amplifier (receiver) with a digital input jack.

For connection details, see "Connecting to Your AV/Amplifier (Receiver)" on page 23. Press **ENTER**, and select **"Dolby Digital"** or **"DTS."**

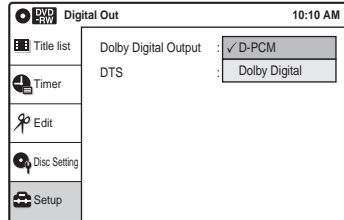

If you connect a component that does not accept the selected audio signal, a loud noise (or no sound) will come out from the speakers, and may affect your ears or cause speaker damage.

- **Dolby Digital Output (DVDs only)**
Selects the type of Dolby Digital signal.

<u>D-PCM</u>	Select this when the recorder is connected to an audio component lacking a built-in Dolby Digital decoder. You can select whether the signals conform to Dolby Surround (Pro Logic) or not by making adjustments to the "Downmix" item in "Audio" setup (page 103).
Dolby Digital	Select this when the recorder is connected to an audio component with a built-in Dolby Digital decoder.

- **DTS (DVD VIDEO only)**
Selects whether or not to output DTS signals.

On	Select this when the recorder is connected to an audio component with a built-in DTS decoder.
<u>Off</u>	Select this when the recorder is connected to an audio component without a built-in DTS decoder.

Downmix (DVDs only)

Switches the method for mixing down to two channels when you play a DVD which has rear sound elements (channels) or is recorded in Dolby Digital format. For details on the rear signal components, see “Checking the Play Information and Playing Time” on page 45. This function affects the output of the following jacks:

- LINE OUT (AUDIO L/R) jacks
- DIGITAL AUDIO OUT (OPTICAL or COAXIAL) jack when “Dolby Digital Output” is set to “D-PCM” (page 102).

<u>Dolby Surround</u>	Normally select this position. Multi-channel audio signals are output to two channels for enjoying surround sounds.
Normal	Multi-channel audio signals are downmixed to two channels for use with your stereo.

Audio DRC (Dynamic Range Control) (DVDs only)

Makes the sound clear when the volume is turned down when playing a DVD that conforms to “Audio DRC.” This affects the output from the following jacks:

- LINE OUT (AUDIO L/R) jacks
- DIGITAL AUDIO OUT (OPTICAL or COAXIAL) jack only when “Dolby Digital Output” is set to “D-PCM” (page 102).

<u>Standard</u>	Normally select this position.
TV Mode	Makes low sounds clear even if you turn the volume down.

Scan Audio

<u>On</u>	Outputs audio signal during FF1 fast-forward of a DVD disc with Dolby Digital sound tracks.
Off	No sound is output during FF1 fast-forward.

DV Audio Input

<u>Stereo 1</u>	Records original sound only. Normally select this when dubbing a DV format tape.
Stereo 2	Records additional audio only.

Note

Select “Stereo 2” if you have added a second audio channel when recording with your digital video camera.

Line Audio Input

When recording from equipment connected to the LINE 1 IN or LINE 2 IN jack to a DVD disc in this recorder, select line input audio.

<u>Stereo</u>	Records stereo sound only. Select this for discs other than DVD-RWs (VR mode).
Main/Sub	Records the two different sound tracks on DVD-RWs (VR mode). You can select either sound track when playing back the disc.

Recording and VCR Settings (Features)

The “Features” setup allows you to change the tape length, auto play and auto repeat settings.

- 1 Press **SYSTEM MENU** while the recorder is in stop mode.
- 2 Select “**Setup,**” and press **ENTER**.
- 3 Select “**Features,**” and press **ENTER**.
The “Features” setup appears with the following options. The default settings are underlined.

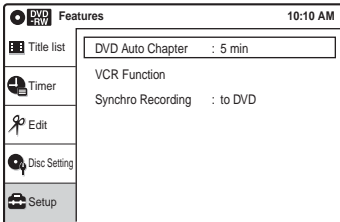

DVD Auto Chapter

Automatically divides a recording (a title) into chapters by inserting chapter markings at a specified interval. The markings are inserted while the recording is being made.

Off	No chapter mark is inserted.
<u>5 Min</u>	Inserts chapter marks at approximately 5 minute intervals.
15 Min	Inserts chapter marks at approximately 15 minute intervals.

Note

Depending upon the size of the recording being made, the actual interval may vary from the interval selected in “DVD Auto Chapter.” The selected interval should only be used as an approximation to create chapters.

VCR Function

Press **ENTER**, and select “Tape Length,” “Auto Play,” and “Auto Repeat.”

◆ Tape Length

<u>T-120</u>	When using a T-120 or shorter length tape.
T-160	When using a T-160 length tape.
T-180	When using a T-180 or longer length tape.

◆ Auto Play

<u>On</u>	To start playback automatically, when you insert a tape with its safety tab removed.
Off	To turn off Auto play. You need to press ▷ PLAY to start playback, even if you insert a tape with its safety tab removed.

◆ Auto Repeat

On	To play back a tape repeatedly. The VCR rewinds a tape to the beginning and restarts playback automatically.
<u>Off</u>	To turn off Auto repeat.

Synchro Recording

<u>to DVD</u>	Sets the recorder to record programs from connected equipment that has a timer function (such as a satellite tuner) to a DVD disc.
to Video	Sets the recorder to record programs from connected equipment that has a timer function (such as a satellite tuner) to a VHS tape.

Language, Parental Control Settings/Factory Settings (Options)

The “Options” setup allows you to set up other operational settings.

- 1 Press **SYSTEM MENU** while the recorder is in stop mode.
- 2 Select “Setup,” and press **ENTER**.
- 3 Select “Options,” and press **ENTER**.
The “Options” setup appears with the following options. The default settings are underlined>.

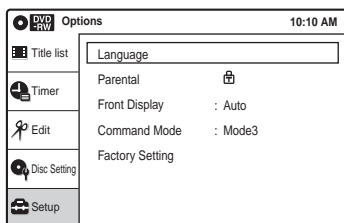

Language

◆ OSD (On-Screen Display)

Switches the display language on the screen.

◆ Disc Menu (DVD VIDEO only)

Switches the language for the DVD menu.

◆ Audio (DVD VIDEO only)

Switches the language of the sound track.

When you select “Original,” the language given priority in the disc is selected.

◆ Subtitle (DVD VIDEO only)

Switches the language of the subtitles recorded on the disc.

When you select “Auto,” the subtitle language changes according to the language you selected for the sound track.

Note

If you select a language in “Disc Menu,” “Subtitle,” or “Audio” that is not recorded on the DVD VIDEO, one of the recorded languages will be automatically selected.

Parental (DVD VIDEO only)

Playback of some DVD VIDEOS can be limited according to a predetermined level, such as the age of the users. Scenes may be blocked or replaced with different scenes.

- 1 After step 3 above, select “Parental,” and press **ENTER**.
 - If you have not entered a password, the display for registering a new password appears.
Enter a 4-digit password using the number buttons.

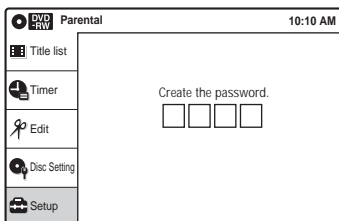

The display for confirming the password appears.

Re-enter the password.

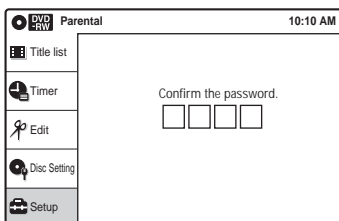

- When you have already registered a password, the display for entering the password appears.
Enter a 4-digit password using the number buttons.

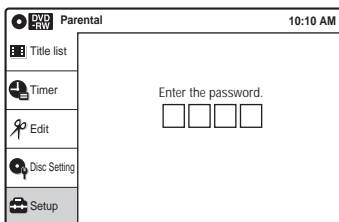

2 Select “Password,” and press ENTER. The selection items for “Password” are displayed.

3 Select “On,” and press ENTER.

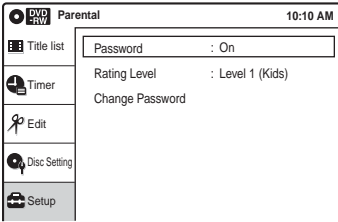

4 Select “Rating Level,” and press ENTER. The selection items for “Rating Level” are displayed.

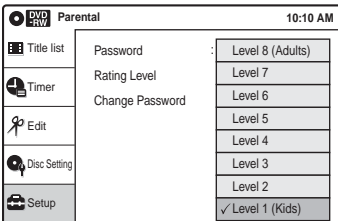

The lower the value, the stricter the limitation.

5 Select the level, and press ENTER. The Parental setting is complete.

- To cancel the Parental setting for the disc, set “Password” to “Off” in step 3.
- To change the password, select “Change Password” in step 5, and press ENTER. When the display for registering a password appears, enter a new four-digit password using the number buttons.

Notes

- If you forget your password, select “Factory Setting” of “Options” in the “Setup” display.
- When you play discs which do not have the Parental Control function, playback cannot be limited on this recorder.
- Depending on the disc, you may be asked to change the Parental Control level while playing the disc. In this case, enter your password, then change the level.

Front Display

Adjusts the lighting of the front panel display.

<u>Auto</u>	Adjusts automatically.
Bright	Bright lighting.
Dimmer	Low lighting. Turns off the lighting when the power is off.

Command Mode

Changes the command mode of the recorder if other DVD equipment is assigned the same command mode. Be sure to match the COMMAND MODE switch on the remote to the setting made here. For details, see “If you have a Sony DVD Player/Video Cassette Recorder or Video Cassette Recorder/DVD Recorder” on page 29.

Mode1	Select this if the default command mode conflicts with other DVD equipment.
Mode2	Select this if the default command mode conflicts with other DVD equipment.
<u>Mode3</u>	The default command mode of the recorder.

Factory Setting

Allows you to return the setup settings to their default settings. Note that all of your previous settings will be lost.

- 1 After step 3 above, select “Factory Setting,” and press ENTER.
- 2 Select “Start,” and press ENTER. The setup settings return to their default settings.
- 3 Press **I/⏻** to turn off the recorder, and press **I/⏻** again to turn it on. The “Easy Setup” display appears. Follow the instructions for Easy Setup (page 30) from step 5.

Easy Setup (Resetting the Recorder)

Select this to run the Easy Setup program.

- 1 Press SYSTEM MENU while the recorder is in stop mode.
- 2 Select "Setup," and press ENTER.
- 3 Select "Easy Setup," and press ENTER.



- 4 Select "Start," and press ENTER.
- 5 Follow the instructions for Easy Setup (page 30) from step 5.

Troubleshooting

If you experience any of the following difficulties while using the recorder, use this troubleshooting guide to help remedy the problem before requesting repairs. Should any problem persist, consult your nearest Sony dealer.

Power

The power does not turn on.

- ➔ Check that the AC power cord is connected securely.

Picture

There is no picture.

- ➔ Re-connect all connecting cords securely.
- ➔ The connecting cords are damaged.
- ➔ Check the connection to your TV (page 15).
- ➔ Switch the input selector on your TV (such as to "VCR") so that the signal from the recorder appears on the TV screen.

Picture noise appears.

- ➔ Check the connection to your TV (page 15) and switch the input selector on your TV so that the signal from the recorder appears on the TV screen.
- ➔ If the picture output signal from your recorder passes through your VCR to get to your TV, or if you are connected to a combination TV/VIDEO player, the copy-protection signal applied to some DVD programs could affect picture quality. If you still experience this problem even when you connect your recorder directly to your TV, try connecting your recorder to your TV's S VIDEO input.
- ➔ You have set the recorder to progressive format (the PROGRESSIVE indicator lights up) even though your TV cannot accept the progressive signal. In this case, set "Progressive" to "Off" in "Video" setup (page 101).
- ➔ Even if your TV is compatible with progressive format (480p) signals, the image may be affected when you set the recorder to progressive format. In this case, set "Progressive" to "Off" in "Video" setup (page 101).

TV program reception does not fill the screen.

- ➔ Set the channel manually in "Tuner Preset" setup (page 97).
- ➔ Select the correct source using the INPUT SELECT button, or select a channel of any TV program using the CH +/- buttons.

TV program pictures are distorted.

- ➔ Reorient the TV antenna.
- ➔ Adjust the picture (see the TV's instruction manual).
- ➔ Place the recorder and TV farther apart.
- ➔ Place the TV and any bunched antenna cables farther apart.
- ➔ The RF cable is connected to the VHF/UHF OUT jack on the recorder. Connect the cable to the VHF/UHF IN jack.

TV channels cannot be changed.

- ➔ The channel is disabled (page 98).
- ➔ A timer recording started, which changed the channels.

The picture from equipment connected to the recorder's input jack does not appear on the screen.

- ➔ If the equipment is connected to the LINE 1 IN jack, select "LINE1" in the front panel display by pressing INPUT SELECT.
If the equipment is connected to the LINE 2 IN jacks, select "LINE2" in the front panel display by pressing INPUT SELECT.

The playback picture or TV program from the equipment connected through the recorder is distorted.

- ➔ If the playback picture output from a DVD player, VCR, or tuner goes through your recorder before reaching your TV, the copy-protection signal applied to some programs could affect picture quality. Disconnect the playback equipment in question and connect it directly to your TV.

The picture does not fill the screen.

- ➔ Set "TV Type" in "Video" setup in accordance with the aspect ratio of your TV (page 100).

The picture does not fill the screen, even though the aspect ratio is set in “TV Type” in “Video” setup.

- ➔ The aspect ratio of the disc is fixed on your DVD.

Sound

There is no sound.

- ➔ Re-connect all connections securely.
- ➔ The connecting cord is damaged.
- ➔ The input source setting on the amplifier or the connection to the amplifier is incorrect.
- ➔ The recorder is in reverse play, fast-forward, slow motion, or pause mode.
- ➔ If the audio signal does not come through the DIGITAL AUDIO OUT (OPTICAL or COAXIAL) jacks, check the “Audio” setup settings (page 102).

Sound is noisy.

- ➔ When playing a CD with DTS sound tracks, noise will come from the LINE OUT (AUDIO L/R) jacks (page 61).

The sound volume is low

- ➔ The sound volume is low on some DVDs. The sound volume may improve if you set “Audio DRC” in “Audio” setup to “TV Mode” (page 103).

An alternate audio track cannot be recorded or played.

- ➔ Second Audio Program (SAP) is not available for all programs. The program you are recording does not have a second audio program.
- ➔ You have set “Tuner Audio” in “Audio” setup to “Main” (page 102). Select “SAP” to record alternate audio programs.
- ➔ If you have connected an AV amplifier to the DIGITAL AUDIO OUT (OPTICAL or COAXIAL) jack and want to change the audio track for a DVD-RW (VR mode) during playback, set “Dolby Digital” in “Audio” setup to “D-PCM” (page 102).

DVD Playback

The disc does not play.

- ➔ The disc is upside down. Insert the disc with the labeled side facing up.
- ➔ The disc is not correctly inserted.
- ➔ Moisture has condensed inside the recorder. Remove the disc and leave the recorder turned on for about half an hour until the moisture evaporates.
- ➔ If the disc was recorded on another recorder, the recorder cannot play the disc if it was not finalized (page 44).

The disc does not start playback from the beginning.

- ➔ Resume play was activated (page 58).
- ➔ You have inserted a disc whose Title menu or DVD menu automatically appears on the TV screen when it is first inserted. Use the menu to start playback.

The recorder starts playing the disc automatically.

- ➔ The DVD VIDEO features an auto playback function.

Playback stops automatically.

- ➔ If the disc has an auto pause signal, the recorder stops playback at the auto pause signal.

Some functions such as Stop, Search, or Slow-motion Play cannot be performed.

- ➔ Depending on the disc, you may not be able to do some of the operations above. See the instruction manual supplied with the disc.

The language for the sound track cannot be changed.

- ➔ Multilingual tracks are not recorded on the disc being played.
- ➔ The DVD VIDEO prohibits the changing of the language for the sound track.
- ➔ Try changing the language using the DVD VIDEO’s menu.

The subtitle language cannot be changed or turned off.

- ➔ Multilingual subtitles are not recorded on the DVD VIDEO.
- ➔ The DVD VIDEO prohibits changing of the subtitles.
- ➔ Try changing the subtitle using the DVD VIDEO's menu.
- ➔ The subtitles cannot be changed for the titles recorded on this recorder.

The angles cannot be changed.

- ➔ Multi-angles are not recorded on the DVD VIDEO being played.
- ➔ You are trying to change the angles when “” does not appear in the front panel display (page 59).
- ➔ The DVD VIDEO prohibits changing angles.
- ➔ Try changing the angle using the DVD VIDEO's menu.
- ➔ The angles cannot be changed for the titles recorded on this recorder.

The MP3 audio track cannot be played.

- ➔ The DATA CD is not recorded in the MP3 format that conforms to ISO9660 Level 1/Level 2.
- ➔ The MP3 audio track does not have the extension “.MP3.”
- ➔ The data is not formatted in MP3 even though it has the extension “.MP3.”
- ➔ The data is not MPEG1 Audio Layer 3 data.
- ➔ The player cannot play audio tracks in MP3PRO format.

The JPEG image file cannot be played.

- ➔ The DATA CD is not recorded in JPEG format that conforms to ISO9660 Level 1/Level 2.
- ➔ The JPEG image file does not have the extension “.JPG” or “.JPEG.”
- ➔ The data is not formatted in JPEG even though it has the extension “.JPG” or “.JPEG.”
- ➔ Length or width of the image is more than 4,720 dots.

The title of the MP3 audio album/ track or JPEG image album/file is not correctly displayed.

- ➔ The player can only display numbers and alphabet. Other characters are displayed as asterisks.

**DVD Recording/Timer recording/
Editing**

The channel cannot be changed from the channel you are recording.

- ➔ Set the TV's input source to “TV.”

Recording does not start immediately after you press .

- ➔ Operate the recorder only after “LOAD,” “FORMAT,” or “INF WRITE” disappears from the front panel display.

Nothing was recorded even though you set the timer setting correctly.

- ➔ There was a power failure during recording.
- ➔ Disconnect the AC power cord from the AC outlet, and connect it again.
- ➔ The program contains copy protection signals that restrict copying.
- ➔ The program that starts first has priority and the second program starts recording only after the first program has finished. If the programs start at the same time, the program listed first in the menu has priority (page 51).
- ➔ There is no DVD inside the recorder.
- ➔ There is not enough disc space for the recording.

Recording does not stop immediately after you press .

- ➔ It will take a few seconds for the recorder to input disc data before recording can stop.

Timer recording is not complete or did not start from the beginning.

- ➔ There was a power failure during recording. If the power recovers when there is a timer recording, the recorder resumes recording. The clock is automatically set by EDS, but it is reset during a power failure when the EDS signal cannot be received (page 99).
- ➔ The program that starts first has priority and the second program starts recording only after the first program has finished. If the programs start at the same time, the program listed first in the menu has priority (page 51).
- ➔ Disc space was not enough.

Contents previously recorded were erased.

- ➔ Data that has been recorded on a DVD with a PC will be erased from the disc when the disc is inserted.

VHS Playback

The playback picture does not appear on the TV screen.

- ➔ Make sure the TV is set to the channel for the VCR. If you are using a monitor, set it to video input.

The picture is not clear.

- ➔ Adjust the tracking with the TRACKING +/- buttons.
- ➔ The video heads are dirty (see page 113). Clean the video heads using a Sony video head cleaning cassette. If a Sony cleaning cassette is not available in your area, have the heads cleaned at your nearest Sony dealer (a standard service fee will be charged). Do not use a commercially available liquid type cleaning cassette, as it may damage the video heads.
- ➔ The video heads may have to be replaced. Consult your local Sony dealer for more information.

The picture rolls vertically during picture search.

- ➔ Adjust the vertical hold control on the TV or monitor.

The picture has no sound.

- ➔ The tape is defective.
- ➔ If you made A/V connections, check the audio cord connection.

VHS Recording

The channel cannot be changed from the channel you are recording.

- ➔ Set the TV's input source to "TV."

A TV program does not appear on the TV screen.

- ➔ Make sure the TV is set to the channel for the VCR. If you are using a monitor, set it to video input.
- ➔ Select the correct source with the CH +/- or INPUT SELECT buttons. Select a channel number when recording TV programs; select "LINE1" or "LINE2" when recording from other equipment.

TV reception is poor.

- ➔ Adjust the TV antenna.

The tape starts playing as soon as it is inserted.

- ➔ The safety tab has been removed. To record on this tape, cover the tab hole.

The tape is ejected when you press ● REC.

- ➔ Check that the safety tab has not been removed.

Nothing happens when you press ● REC.

- ➔ Make sure the tape is not at its end.

VHS Timer recording

The timer does not operate.

- ➔ Check that the clock is set.
- ➔ Make sure a tape has been inserted.
- ➔ Check that the safety tab has not been removed.
- ➔ Make sure the tape is not at its end.
- ➔ Make sure a program has been set for timer recording.
- ➔ Make sure your timer settings are past the current time.
- ➔ Check that the cable box is turned on.
- ➔ The clock stops if the VCR-DVD recorder is disconnected from the wall outlet for more than one minute. Reset the clock and timer.
- ➔ Turn the power off and unplug the AC power cord.
- ➔ The timer recording will not be activated if the recorder is on at the preset time.
- ➔ The program that starts first has priority and the second program starts recording only after the first program has finished. If the programs start at the same time, the program listed first in the menu has priority (page 70).

VHS Others

A tape cannot be inserted.

- ➔ Check that a tape is not already in the tape compartment.

Display

The clock has stopped.

- ➔ Set the clock again (page 99).

The indicator is flashing.

- ➔ The disc does not have enough space.
- ➔ Insert a recordable disc or a tape with its safety tab in place inside the recorder.

Remote control

The remote does not function.

- ➔ Batteries are weak.
- ➔ The remote is too far from the recorder.
- ➔ The remote's manufacturer code returned to the default setting when you replaced the batteries. Reset the code (page 26).
- ➔ Turn on the recorder.
- ➔ The remote is not pointed at the remote sensor on the recorder.
- ➔ Different command modes are set for the recorder and remote. Set the same command mode (page 29).
- ➔ Slide the TV/DVD·VIDEO switch to DVD·VIDEO (page 27).

Other Sony equipment responds to the remote.

- ➔ The same command mode is set for both the Sony DVD Player/Video Cassette Recorder or Video Cassette Recorder/DVD Recorder and recorder. Set a different command mode for the recorder (page 29).

Others

The recorder does not operate properly.

- ➔ Restart the recorder. Press down  on the recorder for more than ten seconds until "SONY DVD" appears in the front panel display.
- ➔ When static electricity, etc., causes the recorder to operate abnormally, turn off the recorder and wait until the clock appears in the front panel display. Then, unplug the recorder and after leaving it off for a while, plug it in again.

The disc tray does not open after you press OPEN/CLOSE.

- ➔ It may take a few seconds for the disc tray to open after you have recorded or edited a disc. This is because the recorder is adding disc data to the disc.

The disc tray does not open and "TRAY LOCKED" appears in the front panel display.

- ➔ Contact your Sony dealer or local authorized Sony service facility.

"CAN NOT RECORD BECAUSE OF HIGH TEMP." appears in the front panel display.

- ➔ Check that the vent on the rear of the recorder is not blocked. Then, turn off the recorder, wait until the clock appears in the front panel display, and disconnect the AC power cord. Leave the recorder off for a while, then re-connect the power cord, and press  on the recorder.

"CHILD LOCK" appears in the front panel display.

- ➔ The recorder is locked. Cancel the Child Lock (page 58).

Control by AV mouse is not possible.

- ➔ Some satellite receivers may not support AV mouse.

Notes About This Recorder

On operation

- If the recorder is brought directly from a cold to a warm location, or is placed in a very damp room, moisture may condense on the lenses inside the recorder. Should this occur, the recorder may not operate properly. In this case, remove the disc and leave the recorder turned on for about half an hour until the moisture evaporates.
- When you move the recorder, take out any discs. If you don't, the disc may be damaged.

On adjusting volume

Do not turn up the volume while listening to a section with very low level inputs or no audio signals. If you do, the speakers may be damaged when a peak level section is played.

On cleaning

Clean the cabinet, panel, and controls with a soft cloth slightly moistened with a mild detergent solution. Do not use any type of abrasive pad, scouring powder or solvent such as alcohol or benzene.

On cleaning discs

Do not use a commercially available cleaning disc. It may cause a malfunction.

Notes about the discs

- To keep the disc clean, handle the disc by its edge. Do not touch the surface. Dust, fingerprints, or scratches on the disc may cause it to malfunction.



- Do not expose the disc to direct sunlight or heat sources such as hot air ducts, or leave it in a car parked in direct sunlight as the temperature may rise considerably inside the car.
- After playing, store the disc in its case.
- Clean the disc with a cleaning cloth. Wipe the disc from the center out.



- Do not use solvents such as benzene, thinner, commercially available cleaners, or anti-static spray intended for vinyl LPs.
- Do not use the following discs.
 - A disc that has a non-standard shape (e.g., card, heart).
 - A disc with a label or sticker on it.
 - A disc that has cellophane tape or sticker adhesive on it.

On cleaning the VCR mechanism

Clean the cabinet, panel, and controls with a dry, soft cloth, or a soft cloth slightly moistened with a mild detergent solution. Do not use any type of solvent, such as alcohol or benzene.

Symptoms caused by contaminated video heads



Specifications

System

DVD recorder section

Laser

Semiconductor laser

Audio recording format

Dolby Digital

Video recording format

MPEG Video

VCR section

Format

VHS NTSC standard

Video recording system

Rotary head helical scanning FM system

Video heads

Double azimuth four heads

Video signal

NTSC color, EIA standards

Tape speed

SP: 33.35 mm/s ($1\frac{3}{8}$ inches/s)

EP: 11.12 mm/s ($\frac{7}{16}$ inches/s)

LP: 16.67 mm/s ($\frac{11}{16}$ inches/s),
playback only

Maximum recording/playback time

8 hrs. in EP mode (with T-160 tape)

Rewind time

Approx. 1 min (with T-120 tape)

Tuner section

Channel coverage

VHF 2 to 13

UHF 14 to 69

CATV A-8 to A-1, A to W, W+1 to W+84

Antenna

75-ohm antenna terminal for VHF/UHF

Timer section

Clock

Quartz locked

Timer indication

12-hour cycle

Timer setting

12 programs in total (max.)

Inputs and outputs

LINE 1 IN and LINE 2 IN

VIDEO IN, phono jack (1 each)

Input signal: 1 Vp-p, 75 ohms, unbalanced,
sync negative

AUDIO IN, phono jacks (2 each)

Input level: 327 mVrms

Input impedance: more than 47 kilohms

LINE 2 IN

S VIDEO, 4-pin, mini-DIN jack

Y: 1.0 Vp-p, unbalanced, sync negative

C: 0.286 Vp-p, load impedance 75 ohms

DV IN, 4-pin jack, i.LINK S100

LINE OUT

VIDEO OUT, phono jack (1)

Output signal: 1 Vp-p, 75 ohms,
unbalanced, sync negative

AUDIO OUT, phono jacks (2)

Standard output: 327 mVrms

Load impedance: 47 kilohms

Output impedance: less than 10 kilohms

DIGITAL AUDIO OUT

OPTICAL, Optical output jack

-18 dBm (wave length: 660 nm)

COAXIAL, phono jack

Output signal: 0.5 Vp-p, 75 ohms

COMPONENT VIDEO OUT (Y, Pb, Pr)

Phono jack

Y: 1.0 Vp-p/Pb, Pr: 0.7 Vp-p, 75 ohms

S VIDEO OUT

4-pin, mini-DIN jack

Y: 1.0 Vp-p, unbalanced, sync negative

C: 0.286 Vp-p, load impedance 75 ohms

General

Power requirements

120 V AC, 60 Hz

Power consumption

42 W

Power back-up

Back-up duration: 0 min

Operating temperature

5°C to 35°C (41°F to 95°F)

Storage temperature

-20°C to 60°C (-4°F to 140°F)

Operating humidity

25% to 80%

Dimensions including projecting parts and controls (w/h/d)

Approx. 430 × 85 × 334 mm

(Approx. 17 × 3.4 × 13¹/₄ inches)

Mass

Approx. 5.9 kg (Approx. 13.0 lbs)

Supplied accessories

Remote commander (remote) (1)

Size AA (R6) batteries (2)

Antenna cable (1)

Audio/video cord (1)

Design and specifications are subject to change without notice.

About i.LINK

The DV IN jack on this recorder is an i.LINK-compliant DV IN jack. This section describes the i.LINK standard and its features.

What is i.LINK?

i.LINK is a digital serial interface for handling digital video, digital audio and other data in two directions between equipment having the i.LINK jack, and for controlling other equipment.

i.LINK-compatible pieces of equipment can be connected by a single i.LINK cable. Possible applications are operations and data transactions with various digital AV equipment. When two or more i.LINK-compatible equipment are connected to this recorder in a daisy chain, operations and data transactions are possible with not only the equipment that this recorder is connected to but also with other devices via the directly connected equipment.

Note, however, that the method of operation sometimes varies according to the characteristics and specifications of the equipment to be connected, and that operations and data transactions are sometimes not possible on some connected equipment.

Note

Normally, only one piece of equipment can be connected to this recorder by the i.LINK cable (DV connecting cable). When connecting this recorder to i.LINK-compatible equipment having two or more i.LINK jacks (DV jacks), see the instruction manual of the equipment to be connected.

About the name "i.LINK"

i.LINK is a more familiar term for IEEE 1394 data transport bus proposed by SONY, and is a trademark approved by many corporations. IEEE 1394 is an international standard standardized by the Institute of Electrical and Electronics Engineers.

i.LINK baud rate

i.LINK's maximum baud rate varies according to the equipment. Three maximum baud rates are defined:

- S100 (approx. 100 Mbps*)
- S200 (approx. 200 Mbps)
- S400 (approx. 400 Mbps)

The baud rate is listed under "Specifications" in the instruction manual of each equipment. It is also indicated near the i.LINK jack on some equipment.

The maximum baud rate of equipment on which it is not indicated such as this unit is "S100."

When units are connected to equipment having a different maximum baud rate, the baud rate sometimes differs from the indicated baud rate.

* What is Mbps?

Mbps stands for megabits per second, or the amount of data that can be sent or received in one second. For example, a baud rate of 100 Mbps means that 100 megabits of data can be sent in one second.

i.LINK functions on this recorder

For details on how to dub when this recorder is connected to other video equipment having DV jacks, see page 93.

The DV jack on this recorder can only input DVC-SD signals. It cannot output signals. The DV jack will not accept MICRO MV signals from equipment such as a MICRO MV digital video camera with an i.LINK jack.

For further precautions, see the notes on page 93.

For details on precautions when connecting this recorder, also see the instruction manuals for the equipment to be connected.

Required i.LINK cable

Use the Sony i.LINK 4-pin-to-4-pin cable (during DV dubbing).

i.LINK and  are trademarks.

Guide to Parts and Controls

For more information, see the pages in parentheses.

Front panel

Buttons on the recorder have the same function as the buttons on the remote if they have the same or similar names.

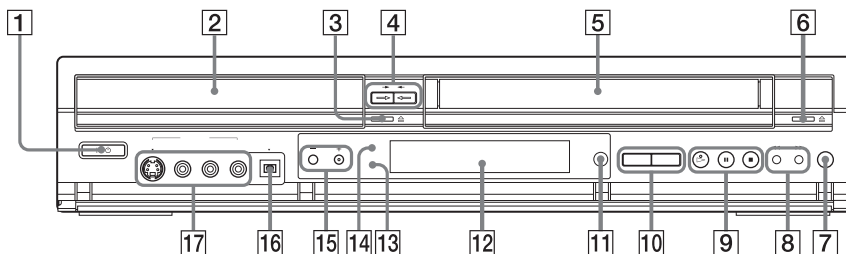

- | | |
|--|--|
| 1 I/⏻ (on/standby) button (30) | 10 SELECT DVD/VIDEO buttons (37) |
| 2 Disc tray (37, 48, 57) | 11 (remote sensor) (26) |
| 3 ≡ (open/close) button (37, 48, 57) | 12 Front panel display (45, 121) |
| 4 DVD → button (91)
← VIDEO button (89) | 13 SYNCHRO REC indicator (53, 72) |
| 5 Tape compartment (37, 67, 76) | 14 PROGRESSIVE indicator (21, 100) |
| 6 ≡ (eject) button (76) | 15 CHANNEL/TRACKING +/- buttons* (38, 39, 48, 67, 77) |
| 7 ● REC (record) button (38, 39, 48, 67) | 16 DV IN jack (93) |
| 8 ◀▶ (rewind/fast-forward) buttons (59, 78) | 17 LINE 2 IN (S VIDEO/VIDEO/AUDIO L/R) jacks (34) |
| 9 ▷ (play) button (37, 57, 76)* | |
| ▬ (pause) button (48, 59, 67, 78) | |
| ■ (stop) button (37, 48, 57, 67, 76, 89) | |

* ▷ and CHANNEL + buttons have a tactile dot. Use the tactile dot as a reference.

Remote for DVD

Buttons on the remote have the same function as the buttons on the recorder if they have the same or similar names. Buttons with an orange dot next to them can be used with your TV when the TV/DVD-VIDEO switch is set to TV.

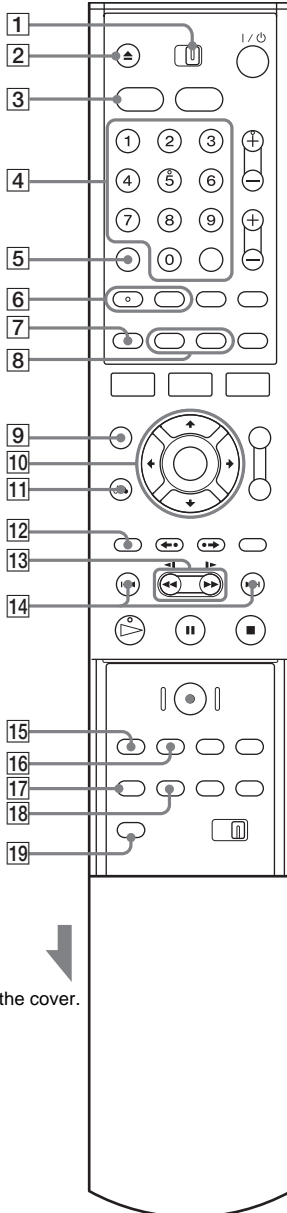

- 1 TV/DVD-VIDEO switch (27)
- 2 ▲ OPEN/CLOSE button (37, 48, 57, 94)
- 3 DVD button (37)
- 4 Number buttons (27, 52)*
SET button (27)
- 5 CLEAR button (52, 62)
- 6 AUDIO button (59)*
SUBTITLE button (59)
- 7 VCR Plus+ button (52)
- 8 DISPLAY button (45, 50)
TIME/TEXT button (45)
- 9 ORIGINAL/PLAYLIST button (42, 82)
- 10 ↑/↓/←/→/ENTER button (30)
- 11 ↻ RETURN button (30)
- 12 TOP MENU button (57)
- 13 ◀◀◀|▶▶▶ (search) buttons (59)
- 14 ◀◀◀ PREV (previous)/NEXT ▶▶▶ buttons (59)
- 15 REC MODE button (38, 48, 94)
- 16 [TIMER] button (50)
- 17 MARKER button (62)
- 18 SEARCH button (62)
- 19 SHUFFLE button (59)

* Number 5 and AUDIO buttons have a tactile dot. Use the tactile dot as a reference.

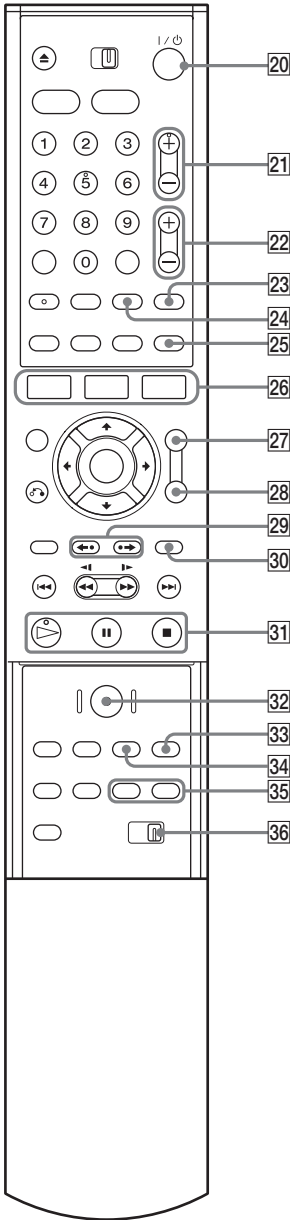

Slide the cover.

- 20 I/⏻ (on/standby) button (30)
- 21 CH +/- (channel) buttons* (38, 48)
- 22 VOL (volume) +/- buttons (27)
- 23 TV/VIDEO button (27)
- 24 INPUT SELECT button (38, 48, 94)
- 25 SURROUND button (59)
- 26 SYSTEM MENU button (40)
TITLE LIST button (42, 57, 82)
TOOLS button (41)
- 27 ZOOM button (59)
- 28 ANGLE button (59)
- 29 ◀▶ INSTANT REPLAY/▶▶ INSTANT
ADVANCE buttons (59)
- 30 MENU button (57)
- 31 ▷ PLAY button* (37, 57, 83)
▢ PAUSE button (48, 59, 83)
■ STOP button (37, 48, 57, 83, 89)
- 32 ● REC (record) button (38, 48)
- 33 REPEAT button (59)
- 34 SYNCHRO REC button (53)
- 35 CHAPTER MARK/ERASE buttons (84)
- 36 COMMAND MODE switch (DVD
COMBO 1, 2, 3) (29)

* CH + and ▷ PLAY buttons have a tactile dot. Use the tactile dot as a reference.

Remote for VIDEO

Buttons on the remote have the same function as the buttons on the recorder if they have the same or similar names. Buttons with an orange dot next to them can be used with your TV when the TV/DVD-VIDEO switch is set to TV.

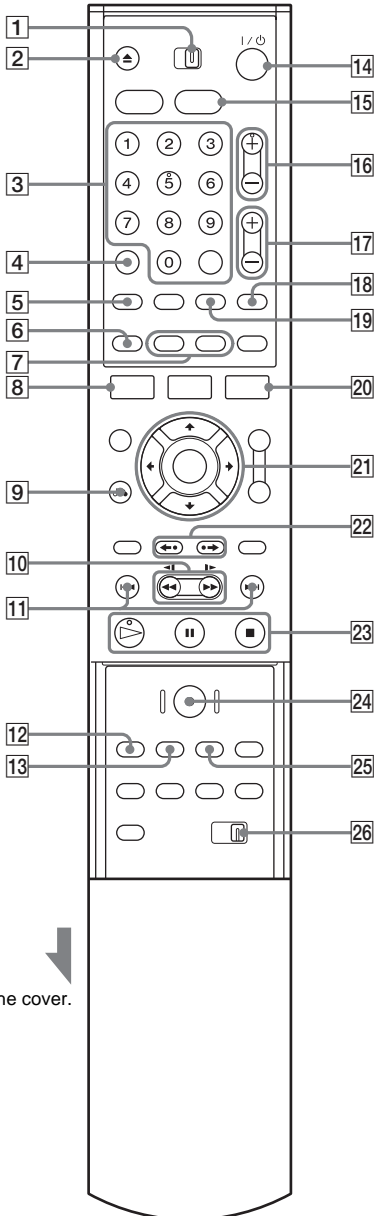

- 1 TV/DVD-VIDEO switch (27)
- 2 ▲ OPEN/CLOSE (eject) button (76)
- 3 Number buttons (27, 71)*
SET button (27, 67)
- 4 CLEAR button (71, 76)
- 5 AUDIO button (80)*
- 6 VCR Plus+ button (71)
- 7 DISPLAY button (45, 69, 76)
TIME/TEXT button (45)
- 8 SYSTEM MENU button (40)
- 9 ↻ RETURN button (30)
- 10 ◀◀◀◀◀◀ (search) buttons (78)
- 11 ◀◀◀◀ PREV (previous)/NEXT ▶▶▶▶ buttons (78)
- 12 REC MODE button (39, 67)
- 13 [TIMER] button (69)
- 14 I/⏻ (on/standby) button (30)
- 15 VIDEO button (37)
- 16 CH (channel)/TRACKING +/- buttons* (39, 67, 77)
- 17 VOL (volume) +/- buttons (27)
- 18 TV/VIDEO button (27)
- 19 INPUT SELECT button (39, 67)
- 20 TOOLS button (41)
- 21 ↑/↓/←/→/ENTER button (30)
- 22 ◀◀◀◀ INSTANT REPLAY/▶▶▶▶ INSTANT ADVANCE buttons (78)
- 23 ▷▶▶▶ PLAY button* (37, 76)
▢ PAUSE button (67, 78)
■ STOP button (37, 67, 76)
- 24 ● REC (record) button (39, 67)
- 25 SYNCHRO REC button (72)
- 26 COMMAND MODE switch (DVD COMBO 1, 2, 3) (29)

* Number 5, AUDIO, CH +, and ▷▶▶▶ PLAY buttons have a tactile dot. Use the tactile dot as a reference.

Front panel display

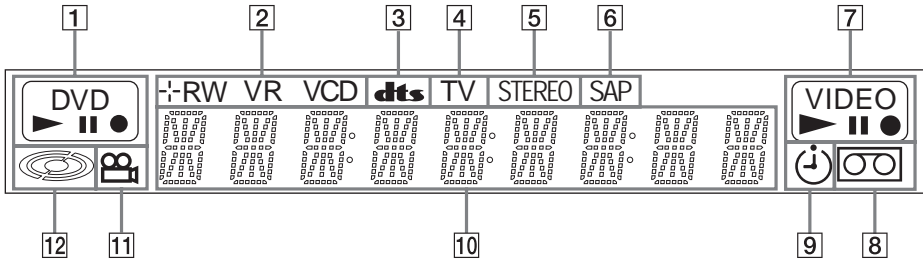

- | | |
|--|---|
| <p>1 DVD Playing/recording status</p> <p>2 Disc type*/recording format</p> <p>3 Audio signal indicators</p> <p>4 TV indicator</p> <p>5 STEREO indicator (47, 67)</p> <p>6 SAP (Second Audio Program) indicator (47)</p> <p>7 VIDEO Playing/recording status</p> | <p>8 Tape indicator</p> <p>9 Timer indicator</p> <p>10 Displays the following (45):</p> <ul style="list-style-type: none"> • Playing time/remaining time • Current title/chapter/track/index number • Recording time/recording mode • Clock • Channel <p>11  (angle) indicator (59)</p> <p>12 Disc indicator</p> |
|--|---|

Rear panel

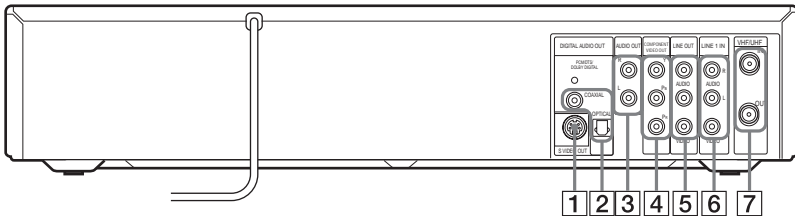

- | | |
|--|--|
| <p>1 S VIDEO OUT jack (20)</p> <p>2 DIGITAL AUDIO OUT (COAXIAL/OPTICAL) jacks (25)</p> <p>3 AUDIO OUT L/R jacks (25)</p> <p>4 COMPONENT VIDEO OUT (Y, P_B, P_R) jacks (21)</p> | <p>5 LINE OUT (AUDIO L/R/VIDEO) jacks (18, 23)</p> <p>6 LINE 1 IN (AUDIO L/R/VIDEO) jacks (35)</p> <p>7 VHF/UHF IN/OUT jacks (15)</p> |
|--|--|

Glossary

Chapter (page 62)

Sections of a picture or a music feature that are smaller than titles. A title is composed of several chapters. Depending on the disc, no chapters may be recorded.

Copy protection signals (page 48)

Copy restriction set by copyright owners, etc. These signals are included in some software or TV programs and restrict recording on this recorder.

Dolby Digital (page 102)

Digital audio compression technology developed by Dolby Laboratories. This technology conforms to multi-channel surround sound. The rear channel is stereo and there is a discrete subwoofer channel in this format. Dolby Digital provides the same discrete channels of high quality digital audio found in “Dolby Digital” theater surround sound systems. Good channel separation is realized because all of the channel data is recorded discretely, and little deterioration occurs because all channel data processing is digital.

DTS (page 102)

Digital audio compression technology by Digital Theater Systems, Inc. This technology conforms to multi-channel surround sound. The rear channel is stereo and there is a discrete subwoofer channel in this format. DTS provides the same discrete channels of high quality digital audio. Good channel separation is realized because all of the channel data is recorded discretely, and little deterioration occurs because all channel data processing is digital.

DVD+RW (page 10)

A DVD+RW (read “plus RW”) is a recordable and rewritable disc. DVD+RWs use a recording format that is comparable to the DVD VIDEO format.

DVD-RW (page 10)

A DVD-RW is a recordable and rewritable disc that is the same size as a DVD VIDEO. The DVD-RW has two different modes: VR mode and Video mode. DVDs created in Video mode have the same format as a DVD VIDEO, while discs created in VR (Video Recording) mode allow the contents to be programmed or edited.

DVD+R (page 10)

A DVD+R (read “plus R”) is a recordable disc that is the same size as a DVD VIDEO. Contents can be recorded only once to a DVD+R, and will have the same format as a DVD VIDEO.

DVD-R (page 10)

A DVD-R is a recordable disc that is the same size as a DVD VIDEO. Contents can be recorded only once to a DVD-R, and will have the same format as a DVD VIDEO.

DVD VIDEO (page 10)

A disc that contains up to eight hours of moving pictures on a disc the same diameter as a CD. The data capacity of a single-layer and single-sided DVD is 4.7 GB (Giga Byte), which is 7 times that of a CD. The data capacity of a double-layer and single-sided DVD is 8.5 GB, a single-layer and double-sided DVD is 9.4 GB, and double-layer and double-sided DVD is 17 GB. The picture data uses the MPEG 2 format, which is a worldwide standard of digital compression technology. The picture data is compressed to about 1/40 (average) of its original size. The DVD also uses a variable rate coding technology that changes the data to be allocated according to the status of the picture. Audio information is recorded in a multi-channel format, such as Dolby Digital, allowing you to enjoy a more real audio presence.

Furthermore, various advanced functions such as the multi-angle, multilingual, and Parental Control functions are provided on the DVD.

Interlace format (page 101)

Interlace format shows every other line of an image as a single “field” and is the standard method for displaying images on television. The even number field shows the even numbered lines of an image, and the odd numbered field shows the odd numbered lines of an image.

Original (page 81)

Titles actually recorded on a DVD-RW (VR mode). Erasing original titles frees up disc space.

Playlist (page 81)

Playback information created from the actual recordings on a DVD-RW (VR mode). A Playlist leaves the original titles as they are, and contains only the information needed to control playback. A Playlist title takes up very little disc space.

Progressive format (page 101)

Compared to the Interlace format that alternately shows every other line of an image (field) to create one frame, the Progressive format shows the entire image at once as a single frame. This means that while the Interlace format can show 30 frames/60 fields in one second, the Progressive format can show 60 frames in one second. The overall picture quality increases and still images, text, and horizontal lines appear sharper.

Title (page 62)

The longest section of a picture or music feature on a DVD, movie, etc., in video software, or the entire album in audio software.

Track (page 62)

Sections of a music feature on a CD (the length of a song).

DVD Audio/Subtitle Language

Abbreviation	Language
ARA	Arabic
BUL	Bulgarian
CHI	Chinese
CRO	Croatian
CZE	Czech
DAN	Danish
DEU	German
ENG	English
ESP	Spanish
FIN	Finish
FRA	French
GRE	Greek
HUN	Hungarian
IDN	Indonesian
IND	Hindi
ISL	Icelandic
ITA	Italian
IWR	Hebrew
JPN	Japanese
KOR	Korean
MAL	Malay
NLD	Dutch
NOR	Norwegian
POL	Polish
POR	Portuguese
RUS	Russian
SVE	Swedish
THA	Thai
TUR	Turkish
VIE	Vietnamese
ZAF	Afrikaans

Index

Words in quotations appear in the on-screen displays.

Numerics

16:9 31, 100
“3, 4 Ch Out” 19, 98
4:3 Letter Box 31, 100
4:3 Pan Scan 31, 100

A

“A-B Erase” 83
“Add” 86, 88
ANGLE 59
Antenna 17
AUDIO 59, 80
“Audio” 105
Audio cords 23
“Audio DRC” 103
Audio settings 102
Auto Clock Set 99
“Auto Play” 104
“Auto Preset” 97
“Auto Repeat” 104

B

Batteries 26
“Black Level” 100
Bookmark 62

C

Cable box 16, 17
Chapter 122
CHAPTER ERASE 84
CHAPTER MARK 84
Checking/changing/canceling timer settings (Timer List) 55, 74
Child Lock 58
Cleaning discs 113
Cleaning the video heads 111
CLEAR 53, 62, 72, 76
“Clock Set CH” 99
Clock Set settings 99

“Command Mode” 29, 106
COMPONENT VIDEO OUT 21

Connecting
 the antenna cable 15
 to your AV/amplifier (receiver) 23
 to your TV 18

Controlling TVs with the remote 27

Copy protection 48, 122
Copy-Free 48
Copy-Never 48
Copy-Once 48
Counter 76
CPRM 10
“Create Playlist” 85
Creating chapters 50, 84

D

“Daylight Saving” 99
“Del” 55, 74
“Digital Out” 102
“Disc Finalize” 44
“Disc Format” 43
“Disc Menu” 105
“Disc Name” 43
“Disc Protect” 43
Disc settings 43
Disc types 10
Display
 front panel display 121
 On-screen display 40
 Setup Display 96
Dolby Digital 31, 102, 122
“Downmix” 103
DTS 32, 61, 102, 122
“Dubbing” 89, 92
“DV Audio Input” 95, 103
“DV Edit” 95
“DVD Auto Chapter” 104
DVD Editing 81
DVD VIDEO 122
DVD+R 10
DVD+RW 122
DVD-R 122
DVD-RW 122

E

Easy Setup 107
“Edit” 55, 74
“Edit Playlist” 86
“Edit Scene” 86
Enter characters 46
EP mode 67
“Erase” 83, 86
“Erase All Titles” 43

F

“Factory Setting” 106
Fast forward 60, 78
Fast reverse 60, 78
Feature settings 104
Finalizing 44
Formatting 43
“Front Display” 106
Front panel 117
Front panel display 45, 121

G

“Guide Channel Setup” 33, 98

H

Handling discs 113

I

INPUT SELECT 48, 67, 94
INSTANT ADVANCE 60, 78
INSTANT REPLAY 60, 78
Interlace format 123

J

JPEG image files 64

L

“Language” 105
Language code 123
LINE 1 IN 35
LINE 2 IN 34
“Line Audio Input” 53, 56

- M**
Manual Clock Set 99
“Manual Set” 98
MARKER 62
MENU 57
Menu
 Top menu 57
“Modify” 86
“Move” 86
MP3 audio tracks 63
- N**
NEXT 60, 78
Number buttons 27, 53, 72
- O**
On-screen display
 Setup Display 96
 Sub-menu 41
 System Menu 40
 TOOLS menu 41
On-Screen Menus 40
Options settings 105
Original 42, 123
ORIGINAL/PLAYLIST 42, 82
“OSD” language 30, 105
- P**
“Parental” 105
Parental Control 58
Parts and controls 117
PAUSE 49, 60, 68, 78
PBC 57
“Picture control” 101
PLAY 57, 76
Play mode 45
Playable discs 12
Playback 57, 76
 MP3 audio tracks 63
 Repeat Play 61
 Resume Play 58
 Shuffle Play 60
 Slow-motion play 59
Playlist 42, 84, 123
Power cord 26
PREV 60, 78
“Progressive” 101
Progressive format 123
“Protect” 83
- Q**
Quick Timer 49, 68
- R**
Rear panel 121
REC 49, 67
REC MODE 49, 67
Recording 47, 67
 recordable discs 10
 recording format 10
 recording mode 47
 tape speed 67
 while watching another
 program 49, 68
Recording mode 47
Recording time 47, 50
Region code 13
Remaining time 69
Remote 26, 118
REPEAT 61
Repeat A-B Play 58
Resetting 107
Resume Play 58
Rotate 65
- S**
Safety tab 68
SAP (Second Audio Program) 47, 67
Satellite receiver 16
“Scan Audio” 61, 103
SEARCH 62
Searching
 for a blank space 79
 for “Chapter” 62
 for the counter 0 point 79
 for “Title” 62
 for “Track” 62
 Scan and Play 80
 Time Search 62
Setting the VCR Plus+ channels 32
Settings 96
Setup Display 96
SHUFFLE 60
Slide show 65
SP mode 67
Stereo programs 47, 67
STOP 49, 57, 68, 76
Sub-menu 41
SUBTITLE 59
“Subtitle” 105
SURROUND 60
SYNCHRO REC 54, 73
“Synchro Recording” 54, 73, 104
System Menu 40
- T**
“Tape Length” 104
Tape speed 67
“Time Zone” 99
TIME/TEXT 45
TIMER 51, 70
Timer List 55, 74
Timer recording 50, 69
 check/change/cancel 55, 74
 manual setting 50, 69
 VCR Plus+ system 52, 71
Title 123
TITLE LIST 42, 57, 82
Title List 42
“Title Name” 83, 86
TOOLS 41
TOP MENU 57
Track 123
TRACKING 77
Tracking adjustment 77
Troubleshooting 108
“Tuner Audio” 102
Tuner Preset 31
Tuner Preset settings 97
“TV Type” 100
TV/DVD-VIDEO 27
TV/VIDEO 49, 68

U

“Unfinalize” 44

Unrecordable pictures 48

V

“VCR Function” 104

VCR Plus+ 32, 52, 71

Video mode 10

Video settings 100

VR mode 10

Z

ZOOM 59

Zoom 65

