

SRP-X700P Manager User Control Panel

Operating Instructions (Control Software Manual Ver. 1.2)

Before using the software, please read this manual and the Operating Instructions of the Digital Powered Mixer thoroughly and retain it for future reference.

Note

The supplied CD-ROM includes Control Software Manual (English, Japanese, French, German, Spanish, Italian and Chinese versions).

SRP-X700P

SRP-X700P Manager Ver. 1.2
User Control Panel Ver. 1.1

Table of Contents

Features	3
Precautions	3
About This Manual	3
Installation	4
Installing the Dedicated USB Driver Software	4
Installing the SRP-X700P Manager	5
Installing the User Control Panel	5
Uninstalling	5
Section 1 SRP-X700P Manager	6
Names and Functions of Controls on Screen	6
Common operation section	6
Menu bar	6
Bottom menu bar	7
BLOCK Screen	8
INPUT Screen	9
INPUT OVERVIEW Screen	9
INPUT EQ Screen	11
ROUTING Screen	13
AUTOMATIC MIXER SETUP Screen	14
OUTPUT Screen	16
OUTPUT OVERVIEW Screen	16
OUTPUT EQ Screen	18
REMOTE Screen	19
USER DEFINE Screen	22
GROUP FADER Screen	28
SCENE Screen	29
Section 2 User Control Panel	30
Names and Functions of Controls on Screen	30
Troubleshooting	31

• Microsoft® and Windows® are registered trademarks of U.S. Microsoft Corporation in the U.S. and other countries.

Features

The CD-ROM supplied with the SRP-X700P contains two applications and the driver software.

By installing the software in a personal computer running Windows, you can set the parameters of the SRP-X700P and can perform from the PC the basic operations of the SRP-X700P. Similarly, you can also operate a Sony DVD, VCR or CD/MD that is connected to the SRP-X700P.

SRP-X700P Manager

The SRP-X700P Manager enables you to set all the functions of the SRP-X700P.

You can set all functions of the SRP-X700P including making various settings in accordance with the operating environment and peripheral equipment, can use of a maximum of 20 scene memories, can save the setup files, and so forth.

User Control Panel

From the User Control Panel, you can control the basic operations (sound volume adjustment, input selection and scene recall) of the SRP-X700P and also the basic operations (playback, stop, fast forward, rewind, etc.) of other Sony products (DVD, VCR, CD/MD) connected to the SRP-X700P, all from a personal computer.

- If your computer enters the System Standby or System Hibernate state while the SRP-X700P Digital Powered Mixer is connected and these software are in use, communication between them will be interrupted and the software must be started again.
- The specifications of this software are subject to change without notice due to improvement.
- The actual screens of the application software may appear differently from those printed in these Operating Instructions.

About This Manual

This manual describes operations of the SRP-X700P when it is used via a personal computer.

Section 1 describes how to set the parameters using the SRP-X700P Manager. Section 2 describes how to operate the SRP-X700P from the User Control Panel and Sony products connected to the SRP-X700P. Read this manual together with the Operating Instructions of the respective Sony products.

Precautions

- The recommended operating environment for using this software is as follows.

Operating systems:

- Microsoft® Windows® 98 Second Edition
- Microsoft® Windows® Millennium Edition
- Microsoft® Windows® 2000 Professional
- Microsoft® Windows® XP Professional *
- Microsoft® Windows® XP Home Edition *

Operation of this software when the OS has been upgraded is not guaranteed.

* Simple switching of desktop and user cannot be implemented.

CPU: Celeron 400 MHz or higher

Memory: 128 MB or more

Hard disk free space: 10 MB or more

- USB terminal should be equipped as standard.
- This software may not operate appropriately depending on the USB equipment and hub used simultaneously by your computer. Be sure to use the USB equipment and hub conforming to the USB 2.0 standard.
- Operation this software is not guaranteed in every personal computer, even if the recommended environment is satisfied.
- Use the USB cable conforming to USB 2.0 to connect to the SRP-X700P. If any cable other than the USB cable conforming to USB 2.0 is used, the software may not work properly.
- **When the FADER select of the SRP-X700P Manager is switched to ACTIVE for the first time, adjust the sound volume to the appropriate level by controlling the INPUT fader and the OUTPUT fader. (Refer to pages 10 and 17.) If the sound volume is not adjusted, the INPUT faders are all set to $-\infty$ automatically and the system enters the state in which no sound is output.**
- **While you are using the SRP-X700P Manager and the User Control Panel, your computer must not enter the System Standby or System Hibernate state. Therefore, be sure to select "Power Options" from the "Control Panel" and select "Never" in the System Standby tab and in the System Hibernate tab.**

Installation

The dedicated USB driver software is necessary to connect the SRP-X700P Manager and User Control Panel to the SRP-X700P.

Installing the Dedicated USB Driver Software

- The dedicated USB driver software is contained in the CD-ROM supplied with the SRP-X700P.
- Install the dedicated USB driver software by following the instructions shown on the screen. Some computer may reboot when the dedicated USB driver software is installed.

- ① Turn on the main power of the personal computer and start Windows.
- ② Insert the supplied CD-ROM into the CD-ROM drive of the personal computer.
- ③ Turn on the main power of the SRP-X700P. Connect the connector on the front or rear of the SRP-X700P to the USB connector of the personal computer using a USB cable.
- ④ The USB device of the SRP-X700P is recognized and the dialog box [This wizard searches for new drivers for:] appears. Click [Next >].
- ⑤ Select [Search for the best driver for your device. (Recommended).] and click [Next >]. (Fig. 1)

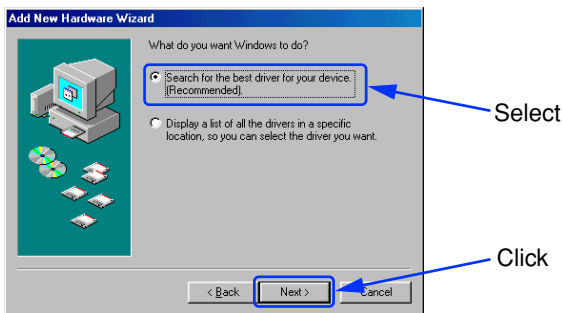

Fig. 1

- ⑥ Click on the check box [Specify a location:] and click [Browse...]. Specify [Driver] folder of the supplied CD-ROM and click [Next >]. (Fig. 2)

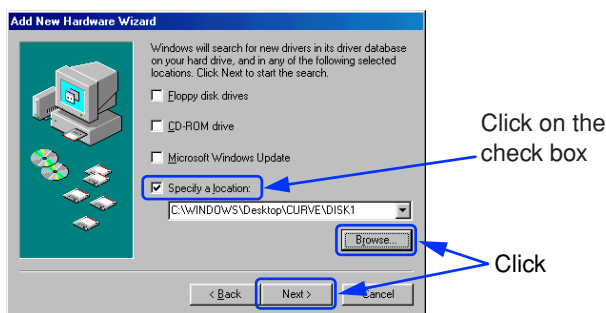

Fig. 2

- ⑦ When the screen [Windows driver file search for the device:] appears, click [Next >].
- ⑧ When the screen [Windows has finished installing the software that your new hardware device requires.] appears, click [Finish].
- ⑨ Because the USB port of the SRP-X700P is recognized as [Unknown Device], click [Next >].

- ⑩ Select [Search for the best driver for your device. (Recommended).] and click [Next >]. (Fig. 3)

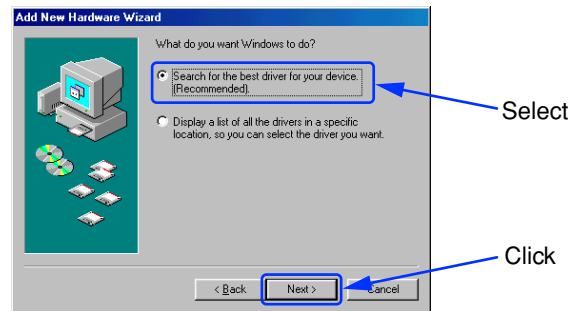

Fig. 3

- ⑪ Click on the check box [Specify a location:] and click [Browse...]. Specify [Driver] folder of the supplied CD-ROM and click [Next >]. (Fig. 4)

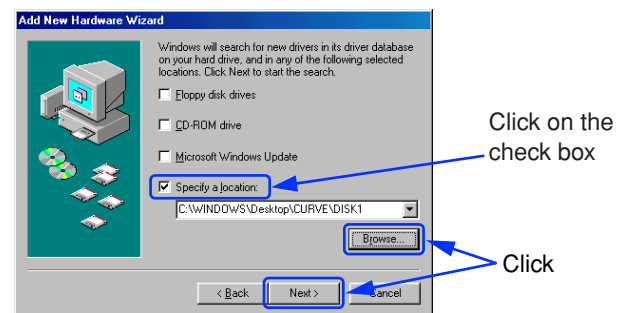

Fig. 4

- ⑫ When the screen [Windows driver file search for the device:] appears, click [Next >].
- ⑬ When the screen [Windows has finished installing the software that your new hardware device requires.] appears, click [Finish].

Installation of the dedicated USB driver software is now complete.

Installing the SRP-X700P Manager

- ① Insert the supplied CD-ROM into the CD-ROM drive of the personal computer.
Open the SRP-X700P Manager folder.
Double-click the Setup icon.
- ② The SRP-X700P Manager installation screen appears.
- ③ When the screen [Welcome to the SRP-X700P Manager installation program] appears, click OK.
- ④ When the screen [Begin the installation by clicking the button below] appears, click the Setup icon on the top left of the screen. (Fig. 1)

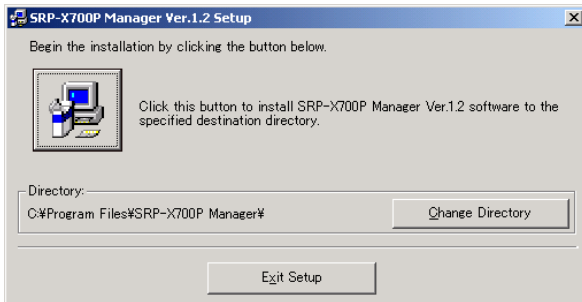

Fig. 1

The SRP-X700P Manager folder is created in C:\Program Files. To change the installation destination, click Change Directory on the bottom right of the screen.

- ⑤ When the screen [Setup will add items to the group shown in the Program Group box. You can enter a new group name or select one from the Existing Groups LIST] appears, click Continue on the bottom left of the screen.
- ⑥ When the screen [SRP-X700P Manager Setup was completed successfully] appears, click OK.

Installation of the SRP-X700P Manager is now complete.

Installing the User Control Panel

- ① Insert the supplied CD-ROM into the CD-ROM drive of the personal computer.
Open the User Control Panel folder.
Double-click the Setup icon.
- ② The User Control Panel installation screen appears.
- ③ When the screen [Welcome to the User Control Panel installation program] appears, click OK.
- ④ When the screen [Begin the installation by clicking the button below] appears, click the Setup icon on the top left of the screen. (Fig. 2)

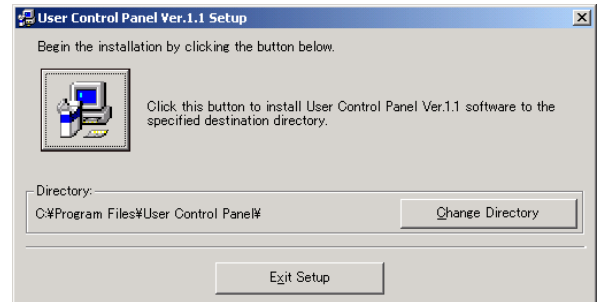

Fig. 2

The User Control Panel folder is created in C:\Program Files. To change the installation destination, click Change Directory on the bottom right of the screen.

- ⑤ When the screen [Setup will add items to the group shown in the Program Group box. You can enter a new group name or select one from the Existing Groups LIST] appears, click Continue on the bottom left of the screen.
- ⑥ When the screen [User Control Panel Setup was completed successfully] appears, click OK.

Installation of the User Control Panel is now completed.

Uninstalling

- ① Click the Start menu and select [Settings (S)]. Then click the [Control Panel] to open it.
- ② Double-click the [Add/Remove Programs] icon and select the application “SRP-X700P Manager” or “User Control Panel” and the driver software “SRP-X700P USB Driver” that you want to delete from the list of the [Install/Uninstall] tab.
- ③ Click [Add/Remove (R)...].

This completes the uninstallation.

Note

When using Microsoft® Windows® 2000 Professional, Microsoft® Windows® XP Professional or Microsoft® Windows® XP Home Edition, be sure to log on as the user having administrator authority, then perform the installation or uninstallation.

Section 1 SRP-X700P Manager

The SRP-X700P Manager enables you to set all parameters of the SRP-X700P.

Starting the SRP-X700P Manager

If the SRP-X700P Manager is started after connecting the SRP-X700P to the personal computer with a USB cable, the present setup of the SRP-X700P is read.

If the SRP-X700P Manager is started before connecting the SRP-X700P to the personal computer, the default setup of the SRP-X700P when shipped from the factory is read.

If the SRP-X700P Manager is started by double-clicking the existing setup file (*.x7p), the status stored in the existing setup file is sent to the SRP-X700P.

The screen images that are used in this manual are all default settings when shipped from the factory.

Names and Functions of Controls on Screen

Common operation section

The controls shown below appear on all the screens.

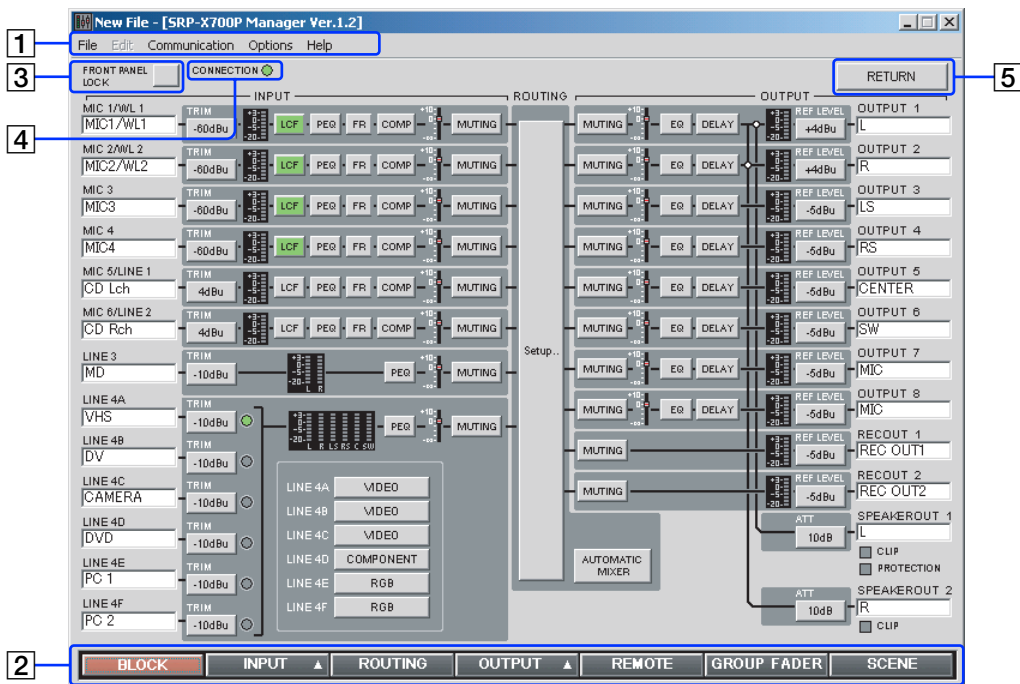

1 Menu bar

The titles of the menu are displayed. You can perform operations that are common to the basic settings and each setup screen.

File menu

This software allows you to save the parameters of up to 20 scenes and the information in a single setup file (*.x7p).

New: Creates a new setup file.

The new setup file contains the default settings when shipped from the factory.

Open: Opens an existing setup file.

Open Scene: Opens the specified scene number from the 20 scenes in the existing setup file.

- Specify a setup file. ①
- The information that is set in the specified setup file is displayed. ②
- Specify the scene number. ③
- The index of the specified scene number is displayed. ④
- Click the Open button. ⑤

Save: Saves the new data by overwriting the existing data.

Save As: Saves the data under a different name.

Exit: Exits the SRP-X700P Manager.

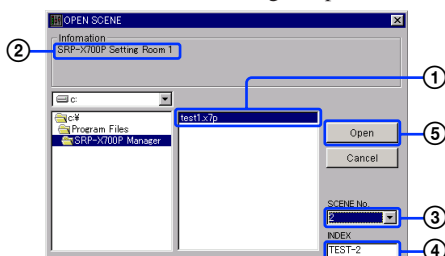

Edit menu (Displayed only on the INPUT and OUTPUT screens)

Copy: Copies the parameters.

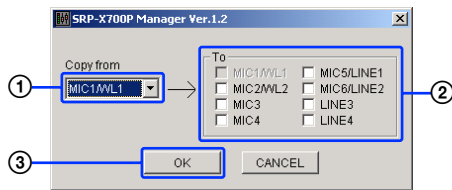

You can copy the parameters of the desired channel to the specified channel. Use this function when you want to use multiple channels with the same setup. However, you cannot copy the parameters of index, TRIM (INPUT), feedback reducer (INPUT) and REF LEVEL (OUTPUT).

- Select the copy source channel. ①
- Click the check box of the copy destination channel. ②
- Press OK. ③

Communication menu

- Disconnect: Disconnects communication with the SRP-X700P.
- Connect: You can select the connection method on the dialog box.
 - Download: Sends the parameters of the SRP-X700P to SRP-X700P Manager.
 - Upload: Sends the parameters that are set by using SRP-X700P Manager to the SRP-X700P.

Options menu

- Password Setting: You can set a password.

How to set a password

The [Password Setup] dialog box appears. Enter the password in the Password field. For confirmation, enter the same password again in the [Confirm password] field and click OK.

The password can be up to 8 alphanumeric characters.

Note

If you forget the password, you cannot start the system next time, so take a note of the password and keep it safely. If you forget the password, uninstall the SRP-X700P Manager and then reinstall it.

- Factory Preset: Resets all parameters to the default settings.

Note

Be careful that the system cannot be returned to your own settings after resetting it to the default settings.

Help menu

- About: You can confirm information about the version.

2 Bottom menu bar

You can select the setup screen for each parameter. For the INPUT and OUTPUT buttons, submenus are displayed.

3 FRONT PANEL LOCK button

You can lock the FRONT PANEL so that the buttons and faders on the SRP-X700P front panel are disabled to prevent accidental operation. When locked, the FRONT PANEL LOCK button lights in red, and the LOCK indicator on the front of the SRP-X700P also lights in red.

4 CONNECTION indicator

The CONNECTION indicator lights in green while communication with the SRP-X700P is in progress.

5 RETURN button

You can return to the previous screen that was selected immediately before.

Names and Functions of Controls on Screen

1.1 BLOCK Screen

The BLOCK screen displays the setup status and the signal level according to the internal blocks in the SRP-X700P. If you click a button, the screen jumps to the related setup screen. You can select ON/OFF and set parameters on each screen.

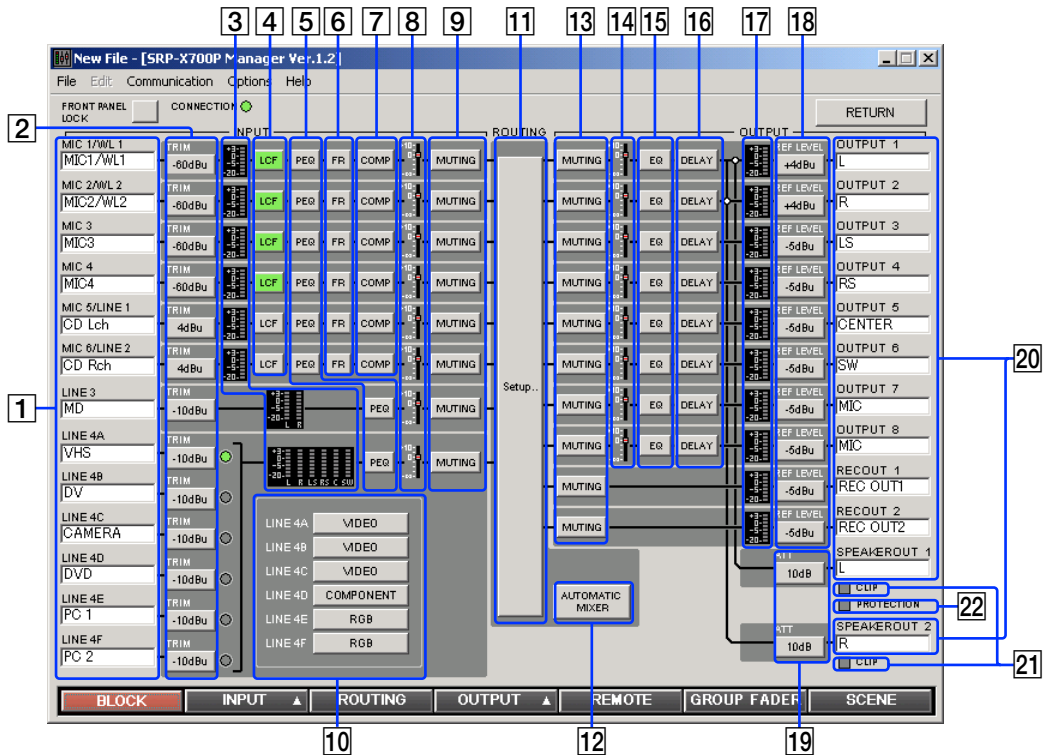

1 INPUT index

You can enter an index of each input channel. By entering the name of the connected equipment as the index, you can easily check the signal system when setting the parameters. You can enter up to 8 alphanumeric characters.

2 TRIM button

The reference level of each input channel that is set on the INPUT OVERVIEW screen appears on the TRIM buttons.

3 Input level meter

Displays the input signal level of each input channel.

4 LCF (Low-Cut Filter) button

When you turn on the LCF button, it lights in green.

5 PEQ (Parametric EQUALizer) button

When you turn on the PEQ button, it lights in green.

6 FR (Feedback Reducer) button

When you turn on the FR button, it lights in green.

7 COMP (Compressor) button

When you turn on the COMP button, it lights in green.

8 INPUT fader display

Displays the setup value of the INPUT fader.

9 INPUT MUTING button

The INPUT MUTING button lights in red when muted.

10 INPUT VIDEO TYPE display

Displays the video input signal format of 4A to 4F of LINE4.

11 Setup.. button

The screen jumps to the ROUTING screen when this button is pressed.

12 AUTOMATIC MIXER button

The AUTOMATIC MIXER button lights in green while the AUTOMATIC MIXER is in operation.

13 OUTPUT MUTING button

The OUTPUT MUTING button lights in red when muted.

14 OUTPUT fader display

Displays the setup value of the OUTPUT fader.

15 EQ (EQUALizer) button

When you turn on the EQ button, it lights in green.

16 DELAY button

When you turn on the DELAY button, it lights in green.

17 Output level meter

Displays the output signal level of each output channel.

18 REF LEVEL button

Displays the reference level of each output channel on the button that is set on the OUTPUT OVERVIEW screen.

19 ATT (ATTenuator) button

Displays the output ATT level to the internal power amplifier.

20 OUTPUT index

You can enter an index of each output channel. You can enter up to 8 alphanumeric characters.

21 CLIP indicator

The CLIP indicator lights in red when the internal power amplifier starts clipping. Adjust the output level using [24] ATT so that the CLIP indicator does not turn on frequently.

22 PROTECTION indicator

The PROTECTION indicator lights in red when the power amplifier protection circuit operates.

1.2 INPUT Screen

You can set parameters of the input block of the SRP-X700P from the INPUT screen.

1.2.1 INPUT OVERVIEW Screen

This screen corresponds to the input module of the audio mixer. This screen enables you to set the following.

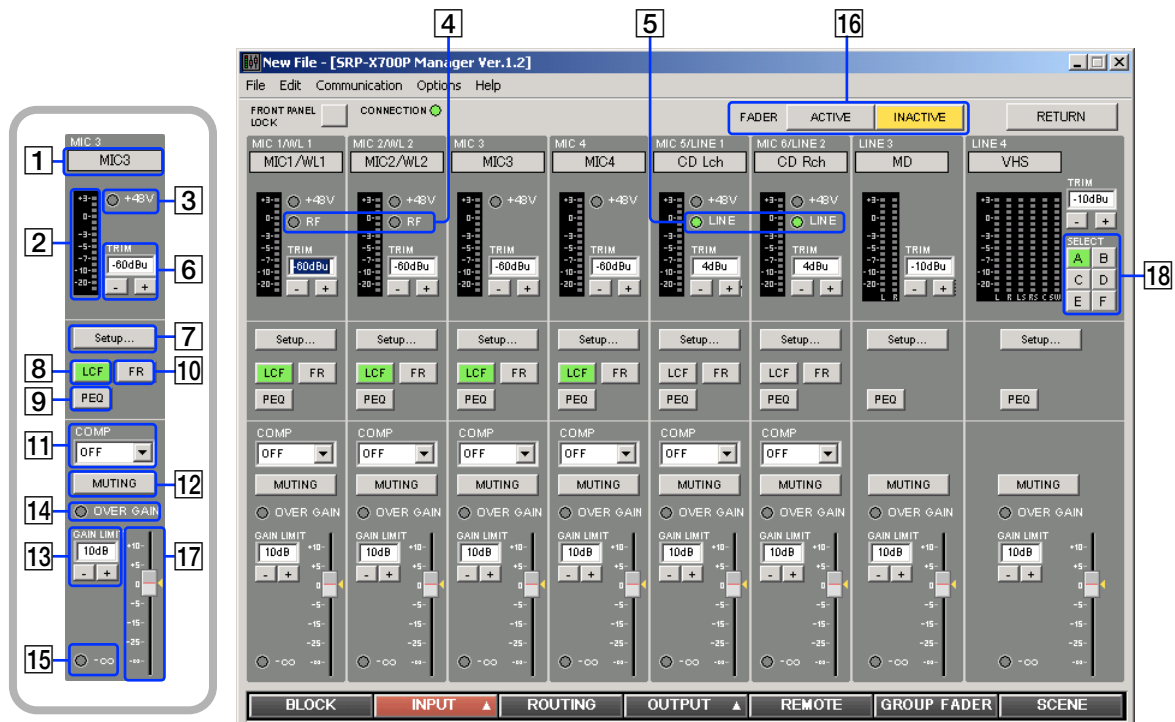

1 INPUT index

Displays the index that is input on the BLOCK screen.

2 INPUT level meter

Displays the input signal level after the TRIM adjustment is complete with the VU response.

3 +48 V indicator

The +48 V indicator lights in red when the +48 V button on the rear of the SRP-X700P is turned on.

4 RF indicator

The RF indicator lights in green when the wireless tuner unit installed in the SRP-X700P receives the RF signal. As long as this indicator is on, this system selects the wireless tuner signal.

5 LINE indicator

The LINE indicator lights in green when the MIC/LINE select button on the rear of the SRP-X700P is set to the LINE position.

6 TRIM controls

The TRIM controls enable you to adjust the reference input level of each input channel.

Each click of the $\boxed{+}$ or $\boxed{-}$ button increments or decrements the reference input level by 1 dB. The adjustment range of MIC1/WL1, MIC2/WL2, MIC3 and MIC4 is -60 dBu to -45 dBu. The adjustment range of LINE3 and LINE4 is -10 dBu to 0 dBu. The adjustment range of MIC5/LINE1 and MIC6/LINE2 is -60 dBu to -45 dBu when MIC is selected or -10 dBu to $+5$ dBu when LINE is selected. You can also enter numerical values directly.

It is recommended to adjust the TRIM controls so that 0 VU of the INPUT level meter lights often.

7 Setup... button

By clicking the Setup button, the display jumps to the INPUT EQ screen where you can set the low-cut filter, feedback reducer and parametric equalizer.

8 LCF (Low-Cut Filter) button

Each press of this button toggles the low-cut filter between on and off. This button lights in green when pressed on. The LCF removes low-frequency components such as blowing noise and makes the sound clear.

9 PEQ (Parametric Equalizer) button

Each press of this button toggles the parametric equalizer between on and off. This button lights in green when pressed on. To set the PEQ, click on the $\boxed{7}$ Setup... button.

10 FR (Feedback Reducer) button

Each press of this button toggles the feedback reducer that is set on the INPUT EQ screen between on and off. This button lights in green when pressed on. To set the FR, click on the $\boxed{7}$ Setup... button.

11 COMP (Compressor) setup box

This function compresses the dynamic range of the input signal that affects the unity sound volume. The compressor can be set in three steps of SOFT, MID or HARD. When the AUTOMATIC MIXER is turned ON, the compressor is set automatically and the manual COMP setup is disabled.

12 MUTING button

Pressing this button mutes the input signal of each channel. The MUTING button lights in red when muted.

Names and Functions of Controls on Screen

13 GAIN LIMIT and 14 OVER GAIN indicators

The sending level from input section is the sum of the 17 INPUT fader and the input fader of the SRP-X700P. If the SRP-X700P master volume is manipulated and the sound volume is remotely controlled via the REMOTE terminal using the GROUP FADER screen and REMOTE screen respectively, these setup values are also added to the sum.

You can set the upper limit of the sending level by the 13 GAIN LIMIT to prevent excessive output level using multiple volume controls. Each click of the + or - button increments or decrements the sending level by 1 dB in the range of +10 dB to -10 dB. You can enter numerical values directly on the screen.

If the sending level exceeds the GAIN LIMIT value, the actual sending level is limited to the GAIN LIMIT value and the 14 OVER GAIN indicator lights in red.

15 -∞ indicator

If there is no sending sound when muted or when the INPUT fader is at the -∞ level position, the -∞ indicator lights in yellow.

16 FADER select and 17 INPUT fader

The 17 INPUT fader has the two modes of ACTIVE and INACTIVE.

To switch the fader mode, click the 16 FADER select. The selected mode lights in yellow. The yellow marker displayed on the side of the fader indicates the fader position, which is the sum of the 17 INPUT fader setup and the SRP-X700P input fader setup.

When the sound volume of a specific input channel is to be set from the REMOTE screen and the GROUP FADER screen, the fader position determined by the SRP-X700P Master volume control and the remote control signal via the REMOTE terminal is indicated.

ACTIVE mode:

ACTIVE mode is used to adjust the reference sound volume by using SRP-X700P Manager.

You can adjust the 17 INPUT fader by dragging the fader portion.

The audio signal that has passed the INPUT fader on the INPUT OVERVIEW screen and the OUTPUT fader on the OUTPUT OVERVIEW screen, is output.

(The INPUT fader and the MASTER volume control of the SRP-X700P, and REMOTE1 to 6 of the GROUP FADER screen are bypassed. The sound volume of the output signal increases by 5 dB in the case of Fig. 1.)

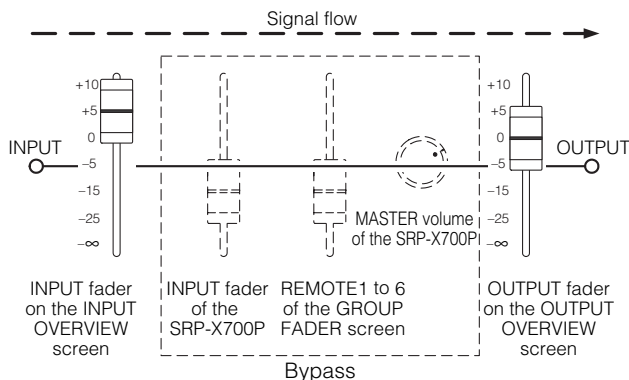

Fig. 1

INACTIVE mode:

INACTIVE mode is used to enable the INPUT fader and the MASTER volume control of the SRP-X700P, and REMOTE1 to 6 of the GROUP FADER screen.

The sound volume is shown by the yellow marker that is displayed on the side of the faders. The audio signal that has passed all faders is output.

You cannot adjust the 17 INPUT fader in INACTIVE mode. (The sound volume of the output signal decreases by 25 dB in the case of Fig. 2.)

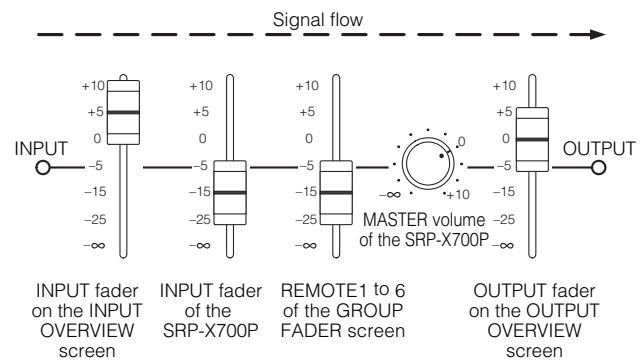

Fig. 2

Note

- When the FADER select of the SRP-X700P Manager is switched to ACTIVE for the first time after shipment from the factory, the INPUT faders are all set to -∞ automatically and the system is muted even if an attempt is made to increase the sound volume using the INPUT fader or the MASTER volume control of the SRP-X700P. Muting is set in order to prevent the system from generating a large sound abruptly when the FADER select is switched to ACTIVE in the event of sound volume adjustment for the first time. Entering muting is not a failure. Therefore, do not terminate the SRP-X700P Manager or do not disconnect the USB cable without adjusting the sound volume.
- A sudden large sound may occur when you switch to ACTIVE mode while the sound volume is reduced by either the fader, MASTER volume or from the REMOTE terminal. Before switching the mode, stop the connected equipments and check the direction of the microphones.
- The mode of the INPUT fader and the mode of the OUTPUT fader are interlocked and so are switched together.

18 LINE4 input select button

LINE4 has the six input channel terminals of A to F.

You can select an input channel from the six channels using this button. The selected button lights in green.

1.2.2 INPUT EQ Screen

You can set the low-cut filter, feedback reducer and parametric equalizer of the SRP-X700P input block from the INPUT EQ screen.

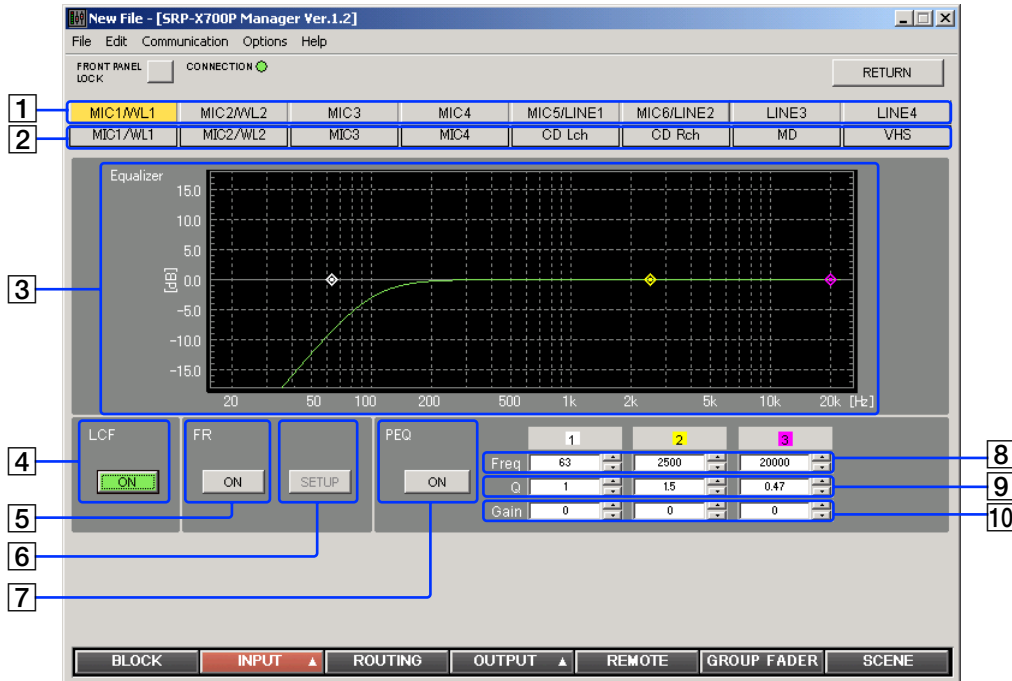

1 Channel select button

Selects the INPUT channel that you want to set.
The selected button lights in yellow.

2 INPUT index

Displays the index that is input on the BLOCK screen.

3 Frequency response graph

Displays the overall frequency response characteristics of the low-cut filter, parametric equalizer and feedback reducer.

Low-Cut Filter Block

4 LCF (Low-Cut Filter) button (100 Hz and -12 dB/oct)

Turns on and off the low-cut filter.
It lights in green when the LCF button is pressed ON.

Feedback Reducer Block

The feedback reducer suppress the positive acoustic feedback by detecting the frequency that causes howling in advance and by reducing the gain of the frequency.

5 FR (Feedback Reducer) button

Suppresses howling at the frequency that is detected when pressing the **6** Setup button.
It lights in green when the FR button is pressed ON.

6 SETUP button

Detect the howling point as follows.

- First, switch the FADER select to ACTIVE on the INPUT OVERVIEW screen or on the OUTPUT OVERVIEW screen.
- Adjust for the appropriate sound volume with the use of the TRIM controls and the INPUT fader on the INPUT OVERVIEW screen, and the REF LEVEL selection box and the OUTPUT fader on the OUTPUT OVERVIEW screen.
- Clicking the SETUP button displays the Channel Select dialog box.

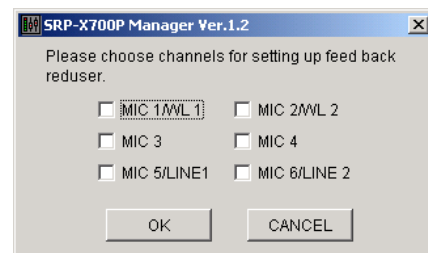

- Select the channel you want to detect.
- Pressing the OK button starts the detection.
- When the detection is complete, the feedback reducer is turned on.

Note

- Set the microphones in ordinary position before starting detection.
- The SETUP button of the Feedback Reducer function is invalid while the FADER select is in the INACTIVE mode.

Names and Functions of Controls on Screen

Parametric Equalizer Block

The MIC1/WL1, MIC2/WL2, MIC3, MIC4, MIC5/LINE1 and MIC6/LINE2 channels have a 3-band parametric equalizer, and the LINE3 and LINE4 channels have a 2-band parametric equalizer. Clicking the ▲ or ▼ button changes the following parameters of each band. You can also enter numerical values directly. You can change the center frequency and the GAIN by dragging the marker portion with the mouse. Q can be entered on the Q setup box. Right-clicking the marker portion returns the GAIN to 0 dB.

7 PEQ (Parametric Equalizer) button

Turns on and off the parametric equalizer. When the PEQ button is turned on, it lights in green.

8 Frequency setup box

Set the frequency in 1/3-octave steps in the ranges of 25 Hz to 100 Hz and 14 kHz to 20 kHz. Set it in 1/12-octave steps in the range of 100 Hz to 14 kHz.

9 Q setup box

Set Q in the range of 0.15 to 22.

10 GAIN setup box

Set GAIN in 0.5-dB steps in the range of -15 dB to +15 dB.

1.3 ROUTING Screen

On this screen, you can set to which output channel the input signal is to be output.

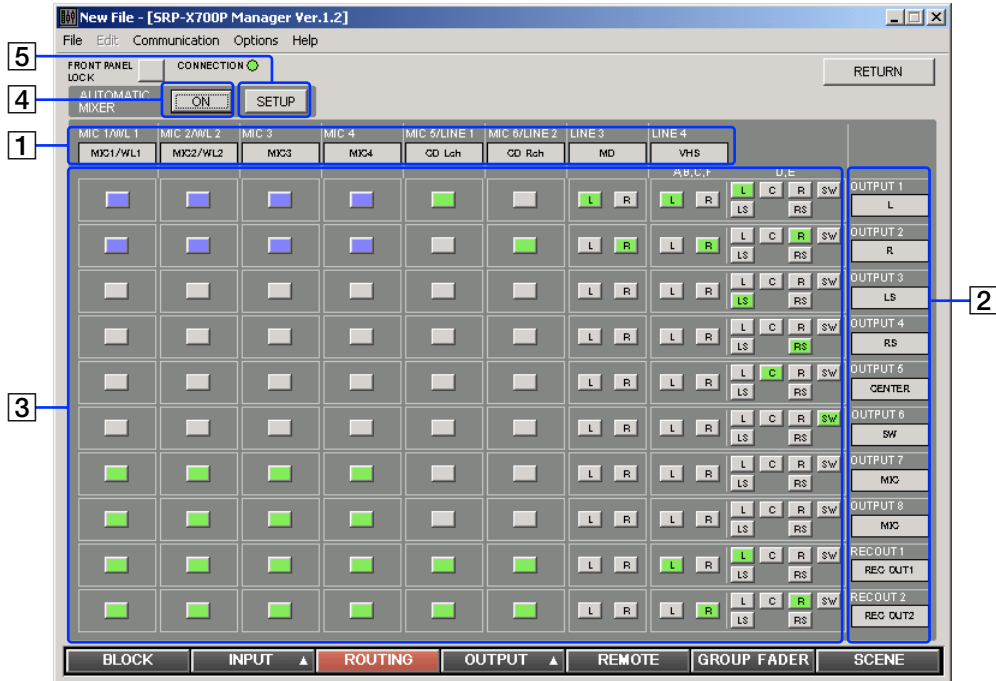

1 INPUT index

Displays the INPUT channel index that is entered on the BLOCK screen.

2 OUTPUT index

Displays the OUTPUT channel index that is entered on the BLOCK screen.

3 ASSIGN button

You can select the signal input and output path. Right-clicking the button displays the menu. You can select the desired sending level from -20 dB, -15 dB, -12 dB, -9 dB, -6 dB, -3 dB or 0 dB. The ASSIGN button lights in green when pressed ON at 0 dB. This button lights in blue purple when pressed ON at any level between -20 dB and -3 dB.

 Moving the pointer to the button displays the present output level.

AUTOMATIC MIXER Block

The AUTOMATIC MIXER block of the SRP-X700P consists of the input gate, input compressor, and output limiter. The AUTOMATIC MIXER block provides the automatic sound volume control function by NOM (Number of Open Microphones attenuated), the ONLY ONE function, and the LAST ON function. These functions are useful for keeping the sound volume constant, suppressing howling, and reducing background noise to obtain clear sound quality.

4 ON button

Turns on and off the AUTOMATIC MIXER.

It lights in green when pressed ON.

When it is pressed ON, the compressor on the INPUT screen is set at the same time.

5 SETUP button

Calls the AUTOMATIC MIXER SETUP screen on which you can make detailed settings of the AUTOMATIC MIXER.

Names and Functions of Controls on Screen

AUTOMATIC MIXER SETUP Screen

This screen is used to make detailed settings of the AUTOMATIC MIXER.



1 GATE OPEN indicator

Lights in green when the input gate is opened.

2 Compressor gate characteristics graph

Displays the characteristics of the compressor and gate for the microphone input.

You can control threshold and ratio of the compressor as well as the threshold of the gate by dragging the marker on the graph with the mouse.

The reference level is 0 dB.

3 Input channel select button

You can select the input channels for which the AUTOMATIC MIXER function is to be enabled.

The button of the selected channels lights in green.

4 NOM button

Turns on and off the NOM (Number of Open Microphones attenuated) function. It lights in green when pressed ON.

The NOM function suppresses howling by automatically reducing the microphone input level by 3 dB whenever the number of opened gates is double.

5 ONLY ONE button

Turns on and off the ONLY ONE function. It lights in green when pressed ON.

The ONLY ONE function restricts the number of microphones that can be used at a time to only one channel. It is enabled by opening the gate of only the channel that first feeds the input signal.

Note

If you set the hold time and the release time of the input gate to a longer time, the sound signals from other microphone inputs are muted until the gate of the microphone input that is opened by the ONLY ONE function, is closed.

Adjust the hold time and release time of the input gate to appropriate values.

6 LAST ON button

Turns on and off the LAST ON function. It lights in green when pressed ON.

The LAST ON function keeps open the gate of the microphone input channel that feeds the sound last of all.

7 Compressor setup

Sets the parameters of the input compressor.

Because the input compressor operates by detecting the sound signal after passing through the feedback reducer, operation of the input compression is not affected by the setting of the INPUT fader.

- **THRESHOLD** : Sets the threshold. The adjustment range is -60 to +20 dB in 1-dB steps.
- **RATIO** : Sets the ratio. The adjustment range is 1:1 to ∞:1 in 14 steps.
- **ATTACK** : Sets the attack time. The adjustment range is 0.1 to 1000 ms in 24 steps.
- **RELEASE** : Sets the release time. The adjustment range is 10 to 10000 ms in 18 steps.

8 Gate setup

Sets the parameters of the input gate.

Because the input gate operates by detecting the sound signal after passing through the input compressor, operation of the input gate is not affected by the setting of the INPUT fader.

- **THRESHOLD** : Sets the threshold. The adjustment range is -60 to 0 dB in 1-dB steps.
- **HOLD** : Sets the hold time. The adjustment range is 10 to 10000 ms in 18 steps.
- **RELEASE** : Sets the release time. The adjustment range is 10 to 10000 ms in 18 steps.

9 Limiter characteristics graph

Displays the characteristics of the output limiter.

You can control the threshold of the output limiter by dragging the marker on the graph with the mouse.

The reference level is 0 dB.

10 Output channel select button

You can select the output channel for which you want to enable the AUTOMATIC MIXER.

The button of the selected channel lights in green.

11 Limiter setup

Sets the parameters of the output limiter.

The output limiter operates by detecting the sound signal after passing through the delay circuit.

- **THRESHOLD** : Sets the threshold. The adjustment range is 0 to +20 dB in 1-dB steps.
- **ATTACK** : Sets the attack time. The adjustment range is 0.1 to 1000 ms in 24 steps.
- **RELEASE** : Sets the release time. The adjustment range is 10 to 10000 ms in 18 steps.

12 AUTOMATIC MIXER ON button

Turns on and off the AUTOMATIC MIXER.

It lights in green when pressed ON.

13 DEFAULT / EDIT select button

You can select either the default parameters or the parameters set for the user on this screen, for the AUTOMATIC MIXER.

The selected mode lights in yellow.

If you select DEFAULT, you cannot change each parameter.

14 EXIT button

Closes the AUTOMATIC MIXER SETUP screen and returns to the ROUTING screen.

Names and Functions of Controls on Screen

1.4 OUTPUT Screen

You can set the parameters of the output block of the SRP-X700P from the OUTPUT screen.

1.4.1 OUTPUT OVERVIEW Screen

This screen corresponds to the output module of the audio mixer. This screen enables you to set the following. The OUTPUT 1 through OUTPUT 8 correspond to the LINE OUTPUT 1 through LINE OUTPUT 8 of the main unit.

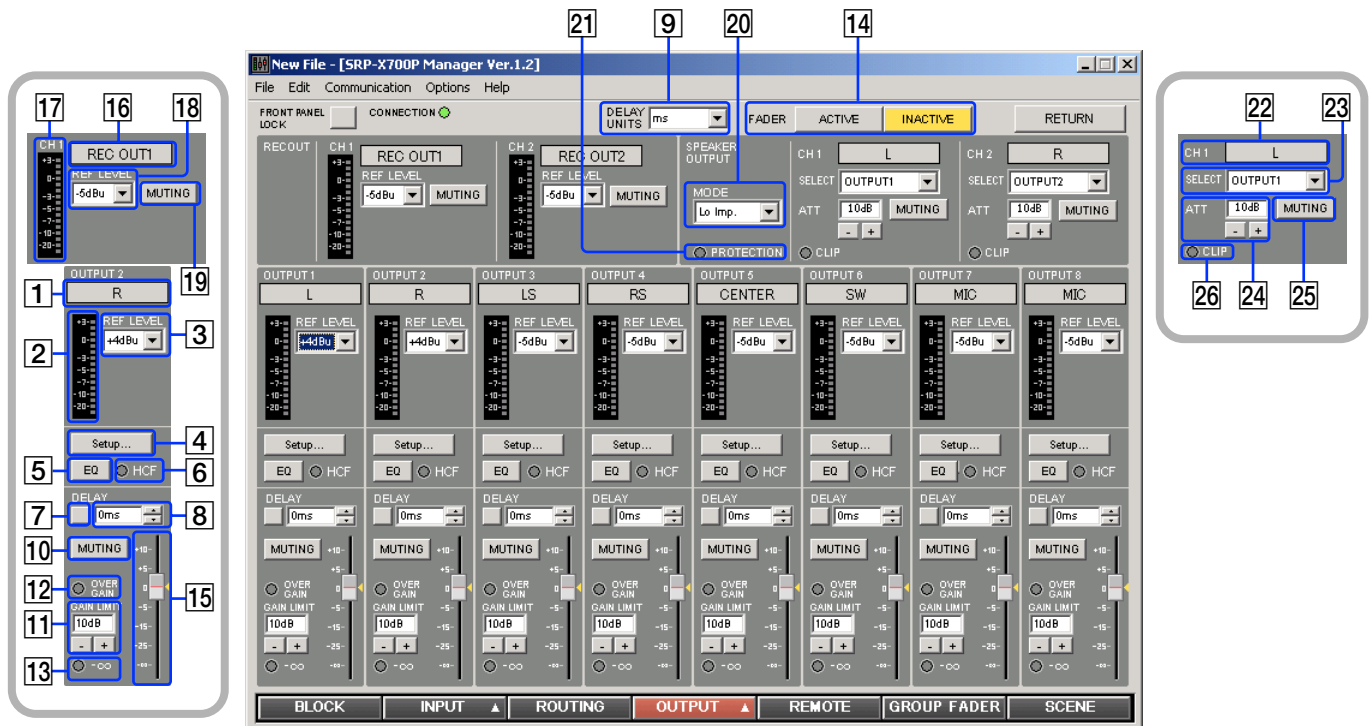

1 OUTPUT index

Displays the index that is input on the BLOCK screen.

2 OUTPUT level meter

Displays the output signal level by the VU response.

3 REF LEVEL selection box

You can set the reference output level for each output channel. You can set it to -10, -5, 0 or +4 dBu for OUTPUTs 1 and 2. You can set it to -10, -5 or 0 dBu for OUTPUTs 3 to 8.

4 Setup... button

By clicking the Setup button, the display jumps to the OUTPUT EQ screen where you can set the various equalization functions as shown below.

5 EQ (Equalizer) button

Turns on and off the equalizer.

The EQ (Equalizer) button lights in green when the EQ button is pressed ON.

6 HCF (High-cut Filter) indicator

The HCF indicator lights in green when the high-cut filter is pressed ON.

7 DELAY button

Turns on and off the delay function.

The DELAY button lights in green when the delay is pressed ON.

8 DELAY value setup box

You can set the delay time value from this setup box. Clicking the ▲ or ▼ button allows you to set the DELAY value in 2.9-ms steps in the range of 0ms to 150.8 ms. Alternatively, you can set DELAY in 1-m steps in the distance range of 0m

to 52 m, or in 3.33-ft steps in the range of 0 ft to 173.3 ft. You can also enter numerical values directly in the setup box. To switch the units, use the 9 DELAY UNITS setup box.

9 DELAY UNITS setup box

The DELAY UNITS setup box allows you to select the unit of the delay as shown below. Clicking the DELAY UNITS setup box indicates the units. Select the desired unit.

- In units of time: ms
- In units of distance: meter, feet

10 MUTING button

Mutes the output signals of the respective channels. The MUTING button lights in red when muted.

11 GAIN LIMIT and 12 OVER GAIN indicator

The output level of the output channel is the sum of the SRP-X700P master volume on the GROUP FADER screen and the remote control via the remote terminal on the REMOTE screen.

You can set the upper limit of the output level by the 11 GAIN LIMIT to prevent excessive output level caused by using multiple volume controls. Each click of the + or - button increments or decrements the output level by 1 dB in the range of +10 dB to -10 dB. You can enter numerical values directly on the screen.

If the output level exceeds the GAIN LIMIT value, the actual output level is limited to the GAIN LIMIT value and the 12 OVER GAIN indicator lights in red.

13 -∞ indicator

If there is no output sound when muted or when the OUTPUT fader is at the -∞ level position, the -∞ indicator lights in yellow.

14 FADER select and 15 OUTPUT fader

The 15 OUTPUT fader has the two modes of ACTIVE and INACTIVE.

To switch the fader mode, click the 14 FADER select. The selected mode lights in yellow. The yellow marker displayed on the side of the fader indicates the fader position that is the addition of the 15 OUTPUT fader setup.

When the sound volume of a specific input channel is to be set from the REMOTE screen and the GROUP FADER screen, the fader position determined by the SRP-X700P Master volume control and the remote control signal via the REMOTE terminal is indicated.

ACTIVE mode:

ACTIVE mode is used to adjust the reference sound volume by using SRP-X700P Manager. You can adjust the 15 OUTPUT fader by dragging the fader portion.

The audio signal that has passed the INPUT fader on the INPUT OVERVIEW screen and the OUTPUT fader on the OUTPUT OVERVIEW screen, is output.

(The INPUT fader and the MASTER volume control of the SRP-X700P, and REMOTE1 to 6 of the GROUP FADER screen are bypassed. The sound volume of the output signal increases by 5 dB in the case of Fig. 1. (Refer to page 10.))

INACTIVE mode:

INACTIVE mode is used to enable the INPUT fader and the MASTER volume control of the SRP-X700P, and REMOTE1 to 6 of the GROUP FADER screen.

The sound volume is shown by the yellow marker that is displayed on the side of the faders. The audio signal that has passed all faders is output.

You cannot adjust the 15 OUTPUT fader in INACTIVE mode. (The sound volume of the output signal decreases by 25 dB in the case of Fig. 2. (Refer to page 10.))

Note

- When the FADER select of the SRP-X700P Manager is switched to ACTIVE for the first time after shipment from the factory, the INPUT faders are all set to $-\infty$ automatically and the system is muted even if an attempt is made to increase the sound volume using the INPUT fader or the MASTER volume control of the SRP-X700P. Muting is set in order to prevent the system from generating a large sound abruptly when the FADER select is switched to ACTIVE in the event of sound volume adjustment for the first time. Entering muting is not a failure. Therefore, do not terminate the SRP-X700P Manager or do not disconnect the USB cable without adjusting the sound volume.
- A sudden large sound may occur when you switch to ACTIVE mode while the sound volume is reduced by either the fader, MASTER volume or from the REMOTE terminal. Before switching the mode, stop the connected equipments and check the direction of the microphones.
- The mode of the INPUT fader and the mode of the OUTPUT fader are interlocked and so are switched together.

16 REC OUT index

Displays the index that is entered on the BLOCK screen.

17 REC OUT level meter

Displays the output signal level using the VU response.

18 REC OUT REF LEVEL selection box

You can set the reference output level for every output channel on this selection box.

You can select -10 , -5 or 0 dBu as the REC OUT level.

19 REC OUT MUTING button

Mutes output signals of the respective channels. The REC OUT MUTING button lights in red when muted.

Power Amplifier Block

20 Operation mode setup box

Selects one of the following modes depending on the type of speaker to be connected.

Lo Imp.: A low impedance (4Ω to 16Ω) speaker is to be connected.

70 V LINE: A high impedance (32Ω to $10 \text{ k}\Omega$) speaker is to be connected.

In the case of 70 V LINE, the channel 1 setup becomes valid for the selectors and attenuators.

21 PROTECTION indicator

The PROTECTION indicator lights in red when the internal power amplifier protection circuit operates.

Note

When the PROTECTION indicator lights

The protection circuit operates (PROTECTION indicator lights) and the speaker and amplifier are protected from damage by decreasing or cutting the output signal in case of the following:

- If the temperature of the heat sink inside the amplifier exceeds the specified value.
The connected speaker impedance is too low.
Air intake and air exhaust holes (on the right and left sides of the SRP-X700P) are choked by dust.
- The SPEAKER terminal is short-circuited.
In such a case, turn the POWER switch to the OFF position and remove the cause of the fault before using the unit again.
- If DC voltage appears in the SPEAKER terminal due to failure.
Turn off the POWER switch and contact your Sony representative where you purchased the unit or contact your local Sony Sales office or Dealer.

22 SPEAKER OUTPUT index

Displays the index that is entered on the BLOCK screen.

23 SELECT setup box

Selects the input signal to the internal power amplifier. When the 70V LINE is selected, the channel 1 setup only is valid.

24 ATT

Adjusts the output level for the internal power amplifier. Clicking the $+$ or $-$ button increases or decreases the output level in the range of 0 dB to ∞ dB. When the 70 V LINE is selected, you can adjust channel 1 only. ATT is set at the 10 dB position for ordinary use.

25 SPEAKER OUTPUT MUTING button

Mutes the speaker output. The SPEAKER OUTPUT MUTING button lights in red when muted. When the 70V LINE is selected, the channel 1 only can be operated.

26 CLIP indicator

The CLIP indicator lights in red when the internal power amplifier clips. Adjust the output level using 24 ATT so that the CLIP indicator does not light frequently.

Names and Functions of Controls on Screen

1.4.2 OUTPUT EQ Screen

You can set the equalizer of the SRP-X700P output block from the OUTPUT EQ screen.

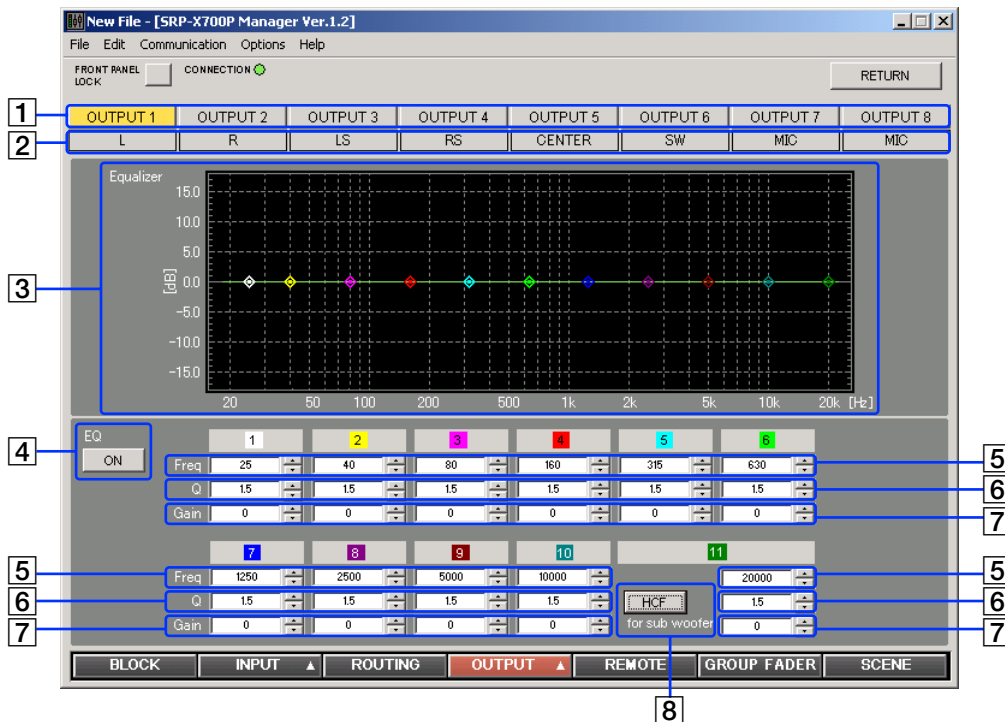

1 Channel select button

Selects the OUTPUT channel that you want to set. The selected button lights in yellow.



2 OUTPUT index

Displays the index that is entered on the BLOCK screen.

3 Frequency response graph

Displays the overall frequency response characteristics of the high-cut filter and parametric equalizer.

Equalizer Block

The OUTPUT 1 and OUTPUT 2 channels have an 11-band parametric equalizer. The OUTPUT 3 to OUTPUT 8 channels have a 4-band parametric equalizer. Clicking the  or  button changes the following parameters of each band. You can also enter numerical values directly. You can change the center frequency and the GAIN by dragging the marker with the mouse. Q can be entered on the Q setup box. Right-clicking the marker portion returns the GAIN to 0dB.

4 EQ (EQualizer) button

Turns on and off the equalizer. When the EQ button is turned on, it lights in green.

5 Frequency setup box

Set the frequency in 1/3-octave steps in the frequency ranges of 25 Hz to 100 Hz and 14 kHz to 20 kHz. Set it in 1/12-octave steps in the range of 100 Hz to 14 kHz.

6 Q setup box

Set Q in the range of 0.15 to 22.

7 GAIN setup box

Set GAIN in 0.5-dB steps in the range of -15 dB to +15 dB.

8 HCF (High-cut Filter) button

This button allows you to turn on and off the 90 Hz high-cut filter. Use the HCF function when you connect a sub woofer to an output as a loud speaker. When the HCF is turned on, it lights in green and the parametric equalizer band decreases by one. (Applications that play only 5.1 channel audio signals such as DVD, do not require the HCF.)

1.5 REMOTE Screen

You can establish various setups of the remote terminal from the REMOTE screen.

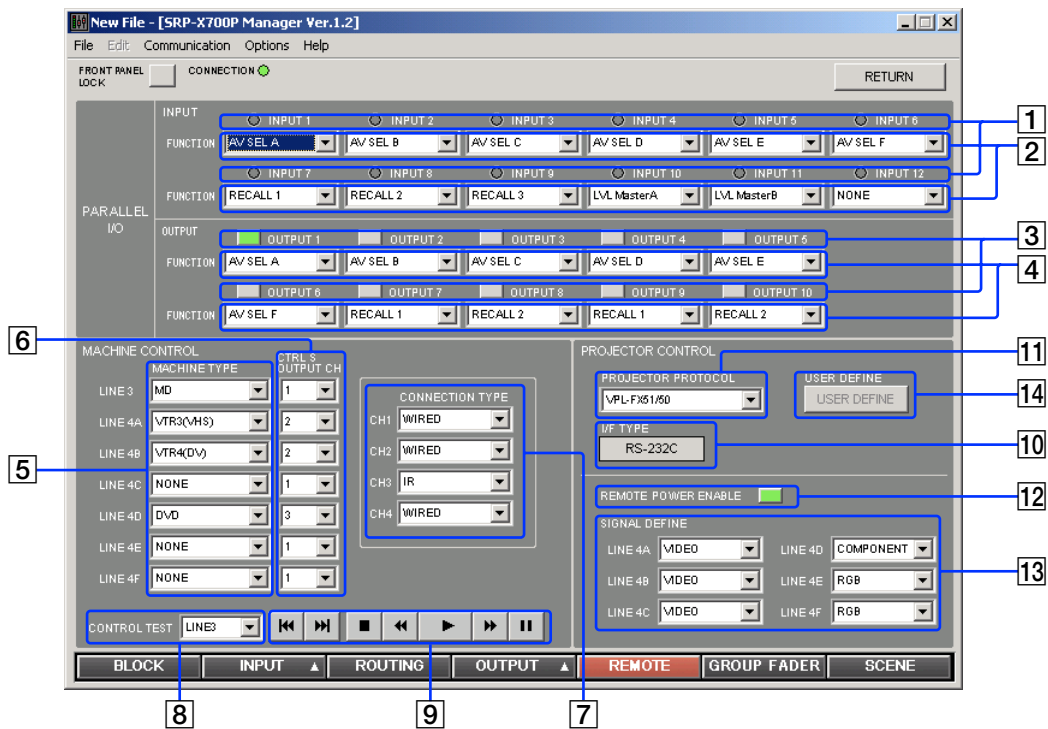

PARALLEL I/O Block

- 1 PARALLEL INPUT indicator**
Displays the status of the REMOTE PARALLEL terminal. The PARALLEL INPUT indicator lights in green when the input terminal is ON (0.8V or less). Refer to the Operating Instructions of the SRP-X700P for the specifications.
- 2 PARALLEL INPUT FUNCTION setup box**
You can set the functions of each input channel. For the setting procedure, refer to “PARALLEL I/O Parameter Setup” on the next page.
- 3 PARALLEL OUTPUT button**
Displays the status of the REMOTE PARALLEL terminal. The PARALLEL OUTPUT button lights in green when the output terminal is ON. Pressing this button enables you to perform the operation test of the equipment connected to the output terminal of REMOTE PARALLEL.
- 4 PARALLEL OUTPUT FUNCTION setup box**
You can set the functions of each output channel. For the setting procedure, refer to “Setting Parameters of PARALLEL I/O” on the next page.

MACHINE CONTROL Block

- You can establish various setups to control Sony products through the Control S output terminal. For details of the connection and other procedures, refer to “How to Control AV Equipment from the SRP-X700P” of the SRP-X700P Operating Instruction.
- 5 MACHINE TYPE setup box**
Selects the type of machines to be connected to LINE3, LINE4A to LINE4F. The machine types that can be controlled by Control S appear. Select the machine type for the machine to be connected.
 - 6 CTRL S OUTPUT CH setup box**
Selects the channel of the Control S output terminal to be connected to the machines of LINE3, LINE4A to LINE4F.
 - 7 CONNECTION TYPE setup box**
Selects the connection type for each channel of the **6** Control S output terminal.
 - Wired: To connect machines having the Control S input terminal
 - IR: To connect a supplied IR transmitter to control the Sony’s AV equipment without the Control S input terminal
 - 8 TEST machine selector box and 9 CONTROL buttons**
Select the terminal to which the machine to be tested is connected, from the **8** TEST machine selector box. Select the desired test command by pressing any of the **9** CONTROL buttons. You can send the PREV. (previous track), NEXT (next track), STOP (stop), REW. (rewind), PLAY (playback), F.F. (fast forward) or PAUSE (pause) commands.

Names and Functions of Controls on Screen

PROJECTOR CONTROL Block

You can establish various setups to control a projector, refer to “How to Control the Display from the SRP-X700P” of the SRP-X700P Operating Instruction.

10 I/F TYPE

The connection method that corresponds to the projector selected by 11 PROJECTOR PROTOCOL setup box, is displayed.

11 PROJECTOR PROTOCOL setup box

Selects a projector that is to be connected to the PROJECTOR CONTROL terminal.

When USER DEFINE is selected, the projector is controlled by the communication protocol set on the USER DEFINE screen.

Once the communication protocol for the projector has been set on the USER DEFINE screen, the projectors not supported by default can be connected.

When USER DEFINE is selected, 10 I/F TYPE is set in RS-232C.

 When USER DEFINE is selected and 14 USER DEFINE button is clicked, the communication protocol with projector can be set.

12 REMOTE POWER ENABLE button

You can interlock the power on/off control of the projector with the POWER button of the SRP-X700P. The REMOTE POWER ENABLE button lights in green when interlocked.

13 SIGNAL DEFINE setup box

Select the video signal format for each channel of the LINE 4 input, that is sent to projector.

- LINE4A to LINE4C: You can select VIDEO, S VIDEO or LAN.
- LINE4D to LINE4F: You can select RGB, COMPONENT or LAN.

When you select LAN, the LAN input connector of a projector is automatically selected.

Note

- When you connect a projector with the Control S, you cannot mix the RGB signal with the COMPONENT signal.
- When you select LAN, select an appropriate projector supporting LAN.

14 USER DEFINE button

Shows the USER DEFINE screen in the PROJECTOR PROTOCOL setup box, to set the communication protocol used when USER DEFINE is selected.

When index is set in the USER DEFINE screen, the index is displayed on the button.

Note

If USER DEFINE is not selected in the PROJECTOR PROTOCOL setup box, clicking is disabled.

Setting Parameters of PARALLEL I/O

Procedure for setting FUNCTION on the REMOTE screen

Example: The procedure for setting the LINE4 input to “A” when PARALLEL INPUT 1 is set to ON:

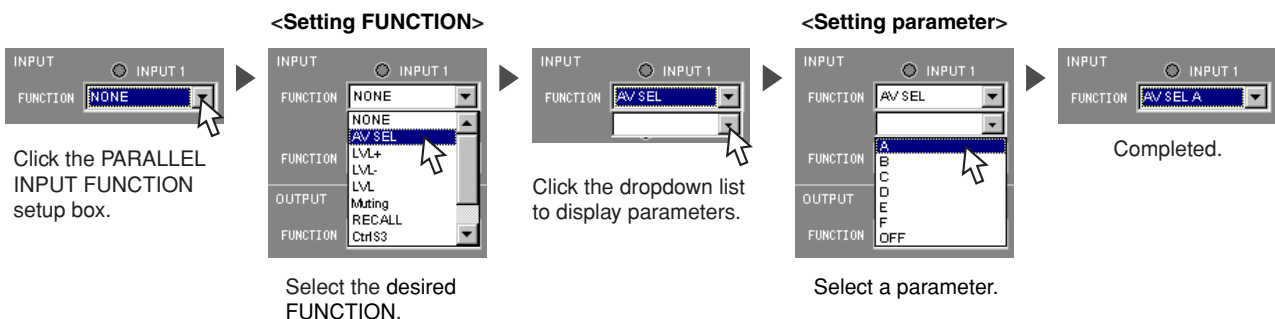

* For the contents of each item, perform the same step referring to the table shown on page 19.

Parameters in the PARALLEL INPUT FUNCTION setup box

Function	Parameter
NONE: Does not set any function.	_____
AV SEL: Selects the LINE4 input.	A: Selects A. to F: Selects F. OFF: Enters the off state.
LVL+: Increases the sound volume with an external switch. LVL-: Decreases the sound volume with an external switch. LVL: Adjusts the sound volume with an external sound volume controller. Muting: Performs muting.	Mic1: Selects Mic1. to Mic4: Selects Mic4. Mic5Line1: Selects Mic5/Line1. Mic6Line2: Selects Mic6/Line2. Line3: Selects Line3. Line4: Selects Line4. Out1: Selects output channel 1. to Out8: Selects output channel 8. MasterA: Selects Master A. MasterB: Selects Master B. Remote1: Selects Remote1. to Remote6: Selects Remote6.
RECALL: Recalls the desired scene No.	1: Recalls scene No. 1. to 20: Recalls scene No. 20.
LINE3 Control: Controls the device connected to LINE3. LINE4 Control: Controls the device connected to LINE4.	Play: Starts playback. Pause: Pauses or restarts playback or recording. Stop: Stops playback or recording. FF: Starts playback in fast forward. Rew: Starts playback in rewind. Rec: Starts recording. Next: Moves to the next track. Prev: Returns to the previous track. On: Turns on the power. Standby: Sets the power in the standby state.
PJ Power: Controls the projector power. (Turn on the projector power when the parallel input terminal is set to ON. Set the projector power to standby when the parallel input terminal is set to OFF.)	_____

Parameters in the PARALLEL OUTPUT FUNCTION setup box

Function	Parameter
NONE: Does not set any function.	_____
AV SEL: Outputs the tally signal when LINE4 input is selected.	A: Selects A. to F: Selects F. OFF: Selects off state.
--∞: Outputs the tally signal when the --∞ indicator lights. Over: Outputs the tally signal when the Over indicator lights.	Mic1: Selects Mic1. to Mic4: Selects Mic4. Mic5Line1: Selects Mic5/Line1. Mic6Line2: Selects Mic6/Line 2. Line3: Selects Line3. Line4: Selects Line4. Out1: Selects output channel 1. to Out8: Selects output channel 8. MasterA: Selects MasterA. MasterB: Selects MasterB.
RECALL: Outputs the tally signal when the desired scene No. is recalled.	1: Selects scene No. 1. to 20: Selects scene No. 20.
PJ Power: Outputs the tally signal when the projector power is controlled.	On: Selects the power on. Standby: Selects the standby state of the power.

Names and Functions of Controls on Screen

USER DEFINE Screen

Use this screen to set the communication protocol when USER DEFINE is selected in the PROJECTOR PROTOCOL setup box.

When USER DEFINE is selected, the projector is connected to the PROJECTOR CONTROL RS-232C terminal.

Once the communication protocol between the SRP-X700P and projector has been set, the projectors not supported by default can be connected.

Note

The above-described setup does not guarantee operation of all projectors.

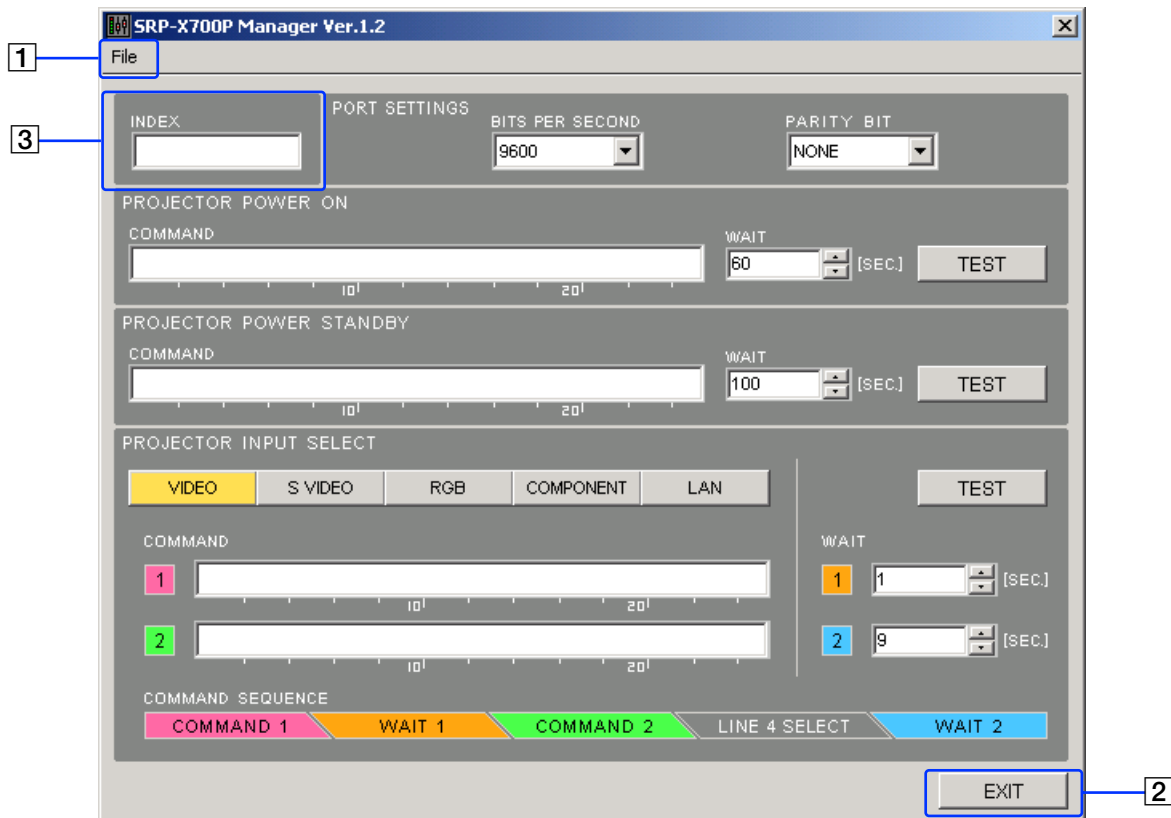

1 File menu

The setups that have been entered in the USER DEFINE screen can be saved and read to and from the setup file (*.pj7).
Open : Opens an already existing projector setup file.
Save : Overwrites and saves the projector setup file.
Save as : Saves the projector setup file as a different name which is to be specified.

Note

The screen setup that can be saved and read as the projector setup file, is the only USER DEFINE screen setup. The other screen setups cannot be saved nor read.
If you want to save and read all of the USER DEFINE screen setups and other screen setups, see the description of the File menu under the “Common operation section” on page 6.

2 EXIT button

Closes the USER DEFINE screen.

3 Index setup

Enters the projector index.
You can enter up to 8 alphanumeric characters.
The index set here is displayed on the USER DEFINE button of the REMOTE screen.

Port setup

Sets the communication conditions between the SRP-X700P and projectors.



4 BITS PER SECOND setup box

Sets the baud rate.

Select the desired speed to 9600, 19200, or 38400 bps depending on the baud rate of the projector.

5 PARITY BIT setup box

Sets the parity bit.

Select NONE, ODD, or EVEN depending on the communication data specifications of the projector.

PROJECTOR POWER ON setup

Sets the command to turn on the projector power and sets the wait time after the command has been sent.

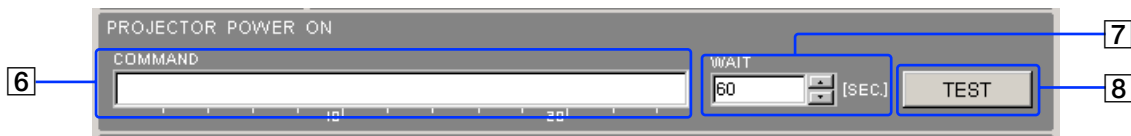

6 COMMAND setup box

Sets the command to be sent from the SRP-X700P to the projector to turn on the projector power.

Enter the command as a hexadecimal number using numbers 0 to 9 and letters A to F.

The maximum length of the command is 24 bytes.

7 WAIT setup box

The projector stops receiving any command after the power on until its operation has stabilized.

Therefore, enter the wait time before sending the next command after the power-on command has been sent from the SRP-X700P to the projector.

The wait time can be set in the range of 10 to 200 seconds in 10-second steps.

8 TEST button

Tests the PROJECTOR POWER ON command.

PROJECTOR POWER STANDBY setup

Sets the command to put the projector in the power standby state and sets the wait time after the command has been sent.

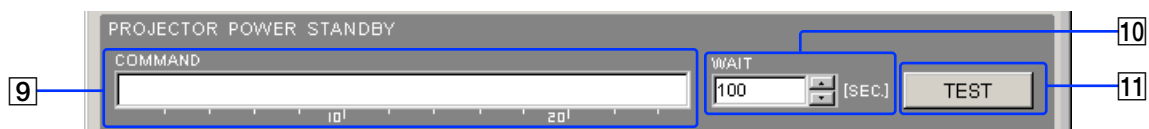

9 COMMAND setup box

Sets the command to be sent from the SRP-X700P to the projector to put the projector in the power standby state.

Enter the command as a hexadecimal number using numbers 0 to 9 and letters A to F.

The maximum length of the command is 24 bytes.

10 WAIT setup box

The projector stops receiving any command after it has entered the power standby state until the standby operation is complete.

Therefore, enter the wait time before sending the next command after the power-standby command has been sent from the SRP-X700P to the projector.

The wait time can be set in the range of 10 to 200 seconds in 10-second steps.

11 TEST button

Tests the PROJECTOR POWER STANDBY command.

Names and Functions of Controls on Screen

INPUT SELECT command setup

Sets the command to select the input terminal of the projector in accordance with the SRP-X700P LINE4 SELECT selection. It also sets the wait time after the command has been sent.

The SRP-X700P has built-in independent switchers for the respective video signal systems. When the video signal system of the channel that is selected by LINE4 SELECT is the VIDEO signal, the output video signal is sent to the VIDEO output terminal. When the selected channel is of the S VIDEO signal, it is output to the S VIDEO output terminal. When the selected channel is of either the RGB signal or the COMPONENT signal, it is output to the 5BNC terminal.

By this system, the SRP-X700P sends to the projector a command that selects the projector input depending on the signal system of the channel selected by LINE4 SELECT.

The INPUT SELECT command is set for the respective signal systems. A maximum of two commands can be set for a single signal system.

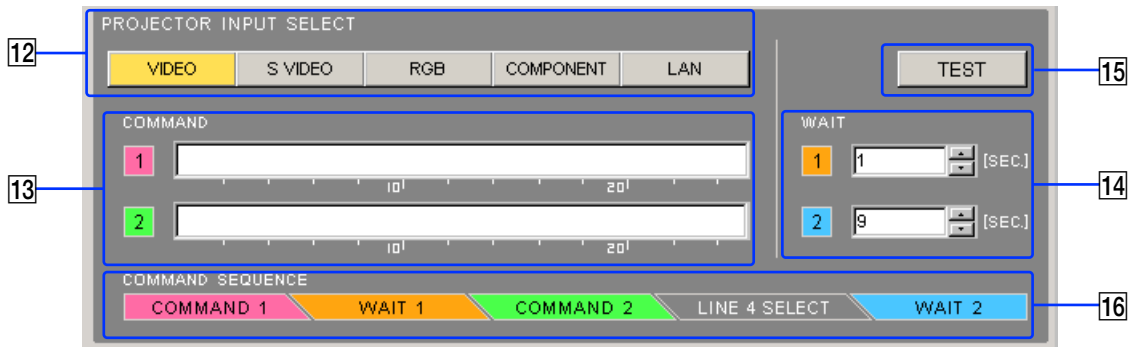

12 Signal system select button

Selects the video signal format to which the INPUT SELECT command will be set.

13 COMMAND setup box

Sets the command to be sent from the SRP-X700P to the projector to select an input to projector. Enter the command as a hexadecimal number using numbers 0 to 9 and letters A to F.

The maximum length of the command is 24 bytes.

When a projector model that allows the input to be selected by a single command is used, set the command in the COMMAND setup box1 only.

Some projector models that support multiple video signal formats with a single input channel, require two commands, the video signal format select command and the input terminal select command, in order to select the input.

For such projector models, set the video signal format select command in the COMMAND setup box1 and set the input terminal select command in the COMMAND setup box2.

The two commands will be sent from the SRP-X700P to the projector in the order of the command sequence as described later.

14 WAIT setup box

Some projector models do not accept commands for several seconds after the projector input signal has been switched while the input selection is being executed.

Therefore, the wait time before sending the next command after COMMAND1 has been sent from the SRP-X700P to the projector, can be set using the WAIT1 setup box. The wait time before sending the next command after COMMAND2 has been sent to switch LINE4 SELECT, from the SRP-X700P to the projector, can be set using the WAIT2 setup box.

The wait time can be set in the range of 1 to 20 seconds in 1-second steps.

The same setting applies to all signal systems.

15 TEST button

Tests the INPUT SELECT command.

16 Command sequence

The sequence of the SRP-X700P operations is indicated when the select channel of LINE4 SELECT has been modified.

The sequence of the SRP-X700P operations is as follows: Send COMMAND1 → Wait for the WAIT1 time → Send COMMAND2 → Select the channel of the SRP-X700P → Wait for the WAIT2 time.

Connectable projectors

Projectors meeting the following specifications can be connected.

- Equipped with RS-232C remote terminal
- The RS-232C remote terminal must support the following specifications.
 - Electrical characteristics : Conforming to RS-232C
 - Baud rate : 9600, 19200 or 38400 bps
 - Parity bit : None, odd or even
 - Data length : 8 bits
 - Stop bit : 1 bit
 - Flow control : None
- The RS-232C remote terminal can be used to turn on the power, turn off the power, and select the input terminal.

Video signal systems and limitations

This system has the following limitations depending on the video signal system used and on the operation method. The limitations are shown below.

• When component signal is used

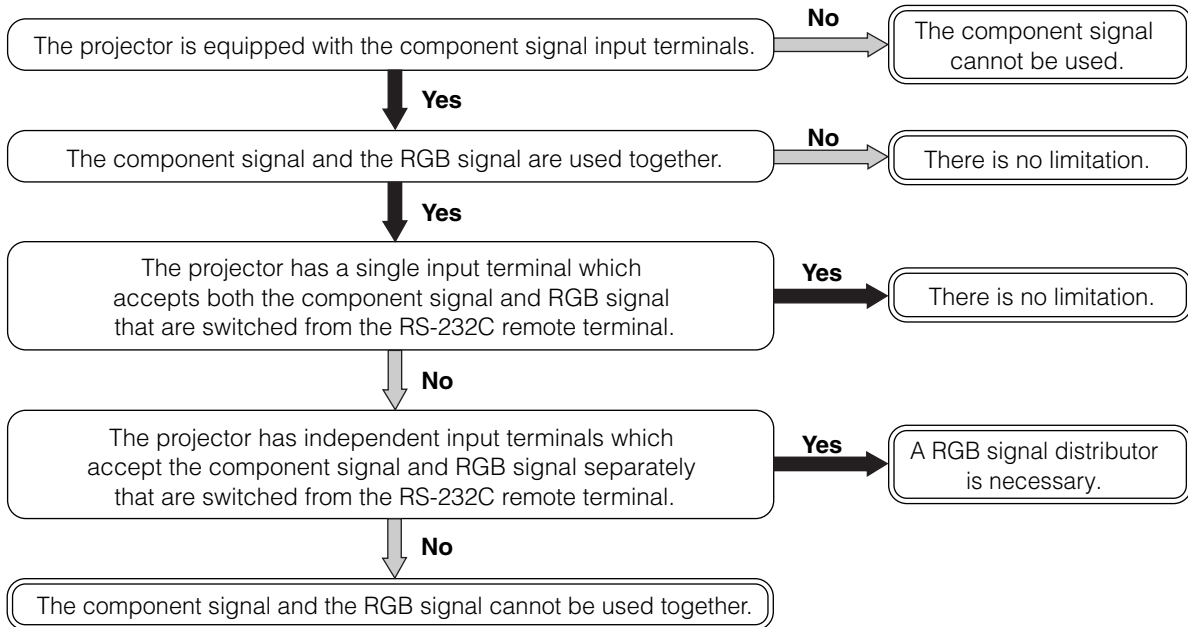

• When S VIDEO signal is used

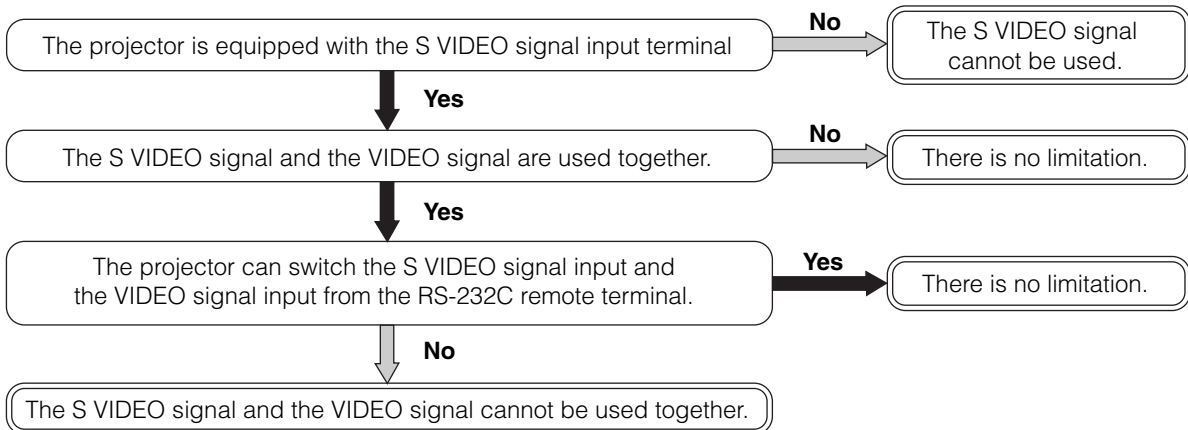

Names and Functions of Controls on Screen

Connection to projector

For details of the method of connecting to a projector, see “System example when operating the SRP-X700P with the default setting when shipped from the factory” of the SRP-X700P Operating Instructions.

When the RGB signal distributor to be connected to the projector, connect them as shown below.

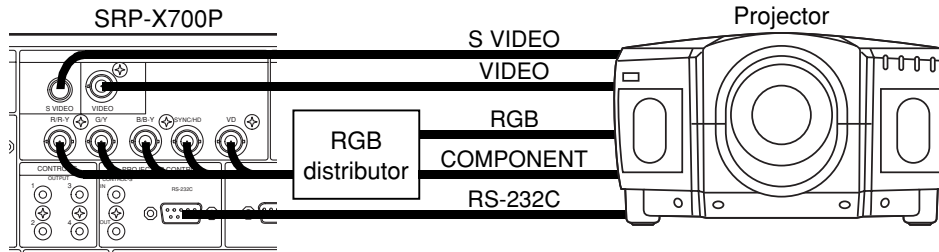

How to set the communication protocol

Set the communication protocol as follows.

1. Port setup

Set the BITS PER SECOND setup box and the PARITY BIT setup box in accordance with the specifications of the projector.

2. PROJECTOR POWER ON setup

- ① Enter the PROJECTOR POWER ON command of the projector, in the COMMAND setup box in which the PROJECTOR POWER ON setup should be entered.
- ② Set 60 seconds in the WAIT setup box. This will be finally adjusted during the operation check.

Note

If the commands that can be received by the projector are specified as ASCII code, convert the ASCII code to a hexadecimal number and enter it in the COMMAND setup box.

3. PROJECTOR POWER STANDBY setup

- ① Enter the PROJECTOR POWER STANDBY command of the projector, in the COMMAND setup box in which the PROJECTOR POWER STANDBY setup should be entered.
- ② Set 100 seconds in the WAIT setup box. This will be finally adjusted during the operation check.

4. INPUT SELECT command setup

- ① Select the respective signal formats using the signal format select button and enter the command in the COMMAND setup box as shown below.
 - When the projector input can be selected by sending a single command only, enter the INPUT SELECT command in COMMAND1 and leave COMMAND2 unset (blank).
 - When the two commands of both the signal system select command and the input terminal select command are required to select the input to the projector, enter the signal system select command in COMMAND1 and enter the input terminal select command in COMMAND2.

Setting example

When the signal systems of VIDEO, S VIDEO, COMPONENT and RGB are used, and when a single command is required for the VIDEO and S VIDEO input selection while both commands are required for the COMPONENT and RGB input signal selection, set as shown below.

Signal system	COMMAND1	COMMAND2
VIDEO	VIDEO input terminal select command	Unset (blank)
S VIDEO	S VIDEO input terminal select command	Unset (blank)
COMPONENT	COMPONENT signal select command	COMPONENT/RGB input terminal select command
RGB	RGB signal select command	COMPONENT/RGB input terminal select command
LAN	Unset (blank)	Unset (blank)

- ② Set WAIT1 to 1 second and set WAIT2 to 9 seconds in the WAIT setup box. This will be finally adjusted during the operation check.

5. Input select operation check using the TEST button

- ① Do not input any signal to LINE4 INPUT of the SRP-X700P. Select VIDEO using the signal format select button and press the TEST button in the INPUT SELECT command setup.
- ② Confirm that VIDEO is selected as the input signal to the projector.
- ③ Execute the same confirmation as in steps ① and ② for all signal systems.

If the input selection is not executed correctly, check for erroneous entry of the COMMAND1 and COMMAND2 commands in the port setup and in the INPUT SELECT command setup.

If the setup is confirmed to be correct, make the setup time of WAIT1 setup box longer in increments of a single step and confirm the operation. Select the time at which input signal can be correctly operated.

6. Operation check using the LINE4 SELECT button of the SRP-X700P

- ① Set up the SIGNAL DEFINE setup box on the REMOTE screen to a practical setup that can be actually used.
- ② Input signals to all channels of LINE4 INPUT of the SRP-X700P. Operate the LINE4 SELECT button and confirm that the video signal is displayed from the projector.
- ③ Operate the LINE4 SELECT button in all operation patterns of A → B, A → C, A → D, A → E, A → F..... F → A, F → B, F → C, F → D and F → E to confirm that the video signal is displayed from the projector.
- ④ Operate the LINE4 SELECT button several times randomly and confirm that the video signal of the button last pressed is displayed.
- ⑤ Repeat the operation check as stated in step ④ more than 10 times.

If the video signal is not displayed, check the setup of the SIGNAL DEFINE setup box on the REMOTE screen and check the setups of the projector itself.

If the setup is confirmed to be correct, adjust the setup time of the WAIT setup box as follows.

- ① Make the setup times of both WAIT1 and WAIT2 longer in increments of a single step and confirm the operation. Select the time at which the input signal can be correctly selected.
- ② Make the setup time of WAIT1 shorter in increments of a single step and confirm the operation. Select the time at which input signal can be correctly selected.
- ③ Make the setup time of WAIT2 shorter in increments of a single step and confirm the operation. Select the time at which input signal can be correctly selected.

 If you want to shorten the time before the video signal is displayed after operating the LINE4 SELECT button, set the WAIT1 and WAIT2 setup times to the shortest time first. Then perform “5. Input select operation check using the TEST button” and “6. Operation check using the LINE4 SELECT button of the SRP-X700P”.

7. PROJECTOR POWER ON operation check

- ① Press the LINE4 SELECT button “A” of the SRP-X700P and confirm that the projector displays the video output signal.
- ② Operate the input select switch of the projector so that the projector does not display the video output signal.
- ③ Operate the POWER switch of the projector so that the projector enters standby.
- ④ After confirming that the projector enters standby, press the TEST button of the PROJECTOR POWER ON setup.
- ⑤ Confirm that the projector power is turned on and the LINE4 INPUT A video signal is displayed.
- ⑥ Repeat the confirmation operations as in steps ① to ⑤ for the LINE4 INPUT B to F.

If the main power cannot be turned on, check whether the commands in the COMMAND setup box are correct.

If the video signal is not displayed, make the WAIT setup box of the PROJECTOR POWER ON setup longer in increments of a single step and confirm the operation. Set the WAIT setup box for normal operation.

 If you want to shorten the time before the video signal is displayed after turning on the projector, make the WAIT1 setup time shorter and set it for normal operation.

8. PROJECTOR POWER STANDBY operation check

- ① Press the TEST button of the PROJECTOR POWER STANDBY setup and confirm that the projector enters the power standby state.
- ② Press the TEST button of the PROJECTOR POWER ON setup to turn on the power of the projector.
- ③ Press the LINE4 SELECT button “A” of the SRP-X700P and confirm that the projector displays the video output signal.
- ④ About 3 seconds after pressing the TEST button of the PROJECTOR POWER ON setup, press the TEST button of the PROJECTOR POWER STANDBY setup.
- ⑤ Confirm that the projector starts the power standby operation.
- ⑥ After the WAIT time that is set in the projector power standby setting has elapsed, confirm that the projector power is turned on and the LINE4 INPUT A video signal is correctly displayed.

If the projector power cannot enter the standby state, check whether the commands in the COMMAND setup box are correct.

If the projector power cannot be turned on, make the WAIT setup box of the PROJECTOR POWER STANDBY setup longer in increments of a single step and confirm the operation. Select the time at which the projector power cannot be turned on correctly.

Names and Functions of Controls on Screen

1.6 GROUP FADER Screen

You can group several faders in order to move multiple internal faders from the Remote terminal or from the Master volume control of the SRP-X700P.

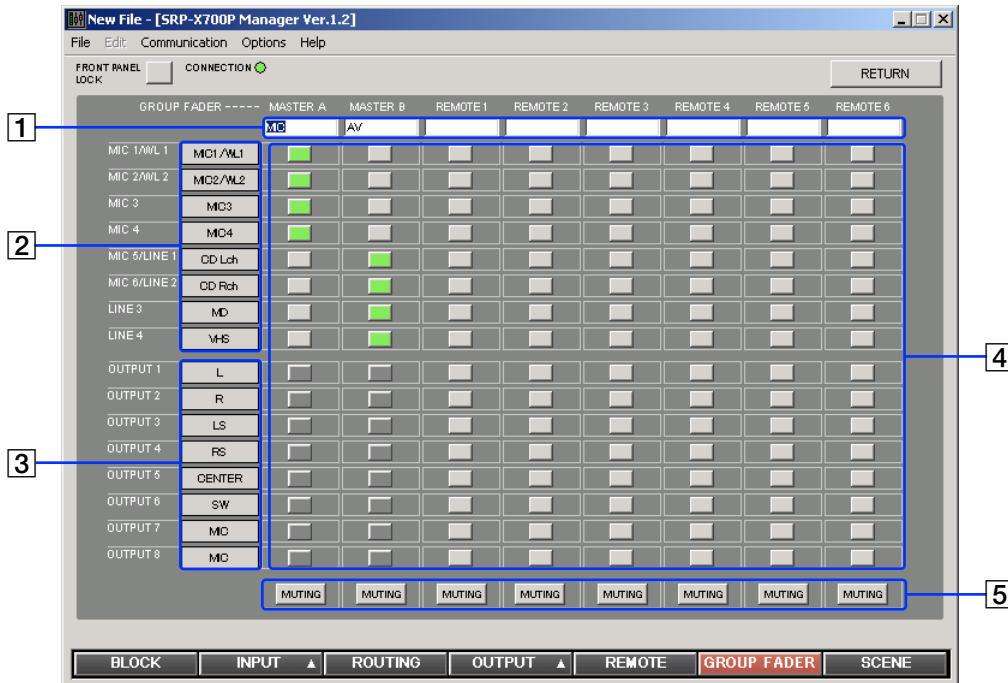

- 1 FADER GROUP index**
Enters the index of the FADER GROUP. You can enter up to 8 alphanumeric characters.
 - 2 INPUT index**
Displays the INPUT index that is entered on the BLOCK screen.
 - 3 OUTPUT index**
Displays the OUTPUT index that is entered on the BLOCK screen.
 - 4 FADER select button**
Selects the faders that you want to move at a time.
The selected buttons light in green.
- Note**
- Mixed use of the INPUT fader and OUTPUT fader in the same group is not possible.
- 5 MUTING button**
Mutes for every FADER GROUP.
The MUTING button lights in red when muted.

1.7 SCENE Screen

You can set scenes from this screen.

You can store the setups on each screen of INPUT, ROUTING, OUTPUT and GROUP FADER into the internal memory of the SRP-X700P or call them from the scene memory.

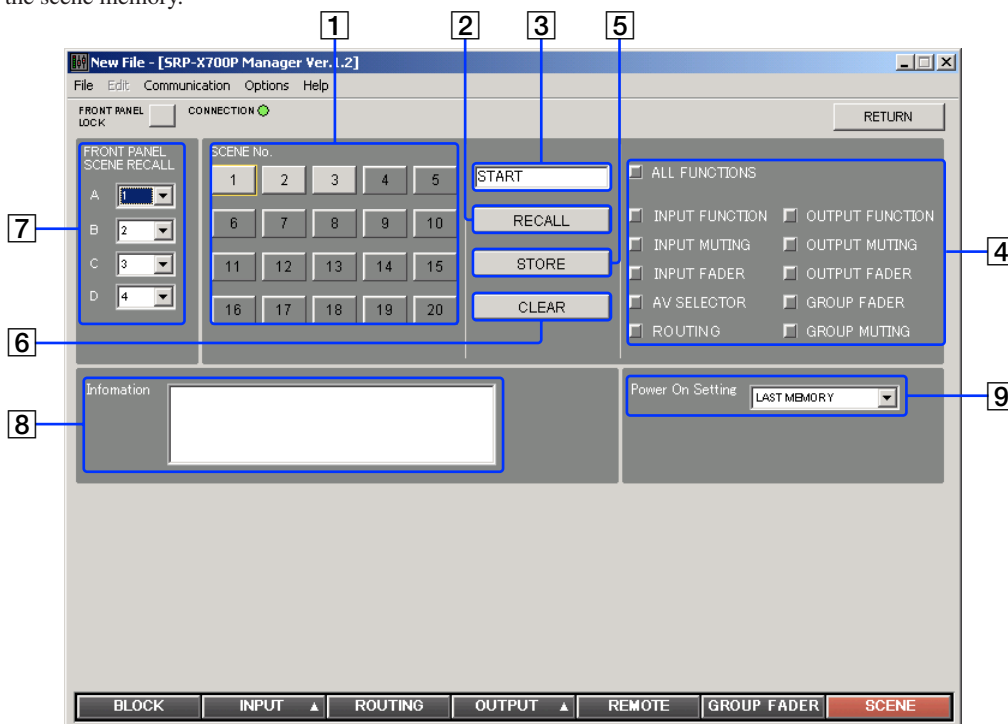

SCENE block

You can recall, store or clear the scenes.

To recall the scene that is set

- Select the scene No. that you want to recall, using the **1** SCENE No. button.
- Click the **2** RECALL button.

To memorize the parameter that is set

- Select the scene No. that you want to memorize, using the **1** SCENE No. button.
- Enter the **3** SCENE index. You can enter up to 8 alphanumeric characters.
- Select the function that you want to memorize, from the **4** FUNCTION area.

When recalling the scene, only the function that is selected here is recalled.

- **ALL FUNCTIONS button**

Select all functions.

- **INPUT FUNCTION button**

Memorizes all functions of the INPUT screen except the MUTING button, INPUT fader and LINE4 select button.

- **INPUT MUTING button**

Memorizes the MUTING button state of the INPUT screen.

- **INPUT FADER button**

Memorizes the INPUT FADER.

- **AV SELECTOR button**

Memorizes the LINE4 select button state.

- **ROUTING button**

Memorizes the ASSIGN button state of the ROUTING screen.

- **OUTPUT FUNCTION button**

Memorizes all functions of the OUTPUT screen except the MUTING button and OUTPUT fader button.

- **OUTPUT MUTING button**

Memorizes the MUTING button state of the OUTPUT screen.

- **OUTPUT FADER button**

Memorizes the OUTPUT fader.

- **GROUP MUTING button**

Memorizes the MUTING button state of the GROUP FADER screen.

- **GROUP FADER button**

Memorizes the fader selector button state of the GROUP FADER screen.

- Click the **5** STORE button.

Clearing the setup scene

- Select the scene No. that is to be cleared using the **1** SCENE No. button.
- Click the **6** CLEAR button.

7 FRONT PANEL SCENE RECALL

You can assign the scene numbers (1 to 20) to recall, using the SCENE RECALL buttons A to D on the front panel of the SRP-X700P.

8 Information

Enter a comment for the setup file. You can enter up to 128 alphanumeric characters.

9 Power On Setting setup box

You can select the setup of the SRP-X700P at the time of power-on. Clicking the Power On Setting setup box displays the dropdown list. Select the desired setup.

- **LAST MEMORY:** The setup immediately before the previous power-off is set.
- **DEFAULT:** The default setup when shipped from the factory is set.
- **SCENE No. 1:** Scene No. 1 is recalled.

Section 2 User Control Panel

The User Control Panel software enables you to operate the SRP-X700P more simply from a personal computer that you may use for presentations and other purposes.

Note

Start up the User Control Panel after connecting the SRP-X700P to the personal computer.
To connect the SRP-X700P to the personal computer, use a USB cable (TYPE-B).

Names and Functions of Controls on Screen



AV CONTROL block

You can select an input machine connected to LINE 4 and operate the remote control of the selected machine.

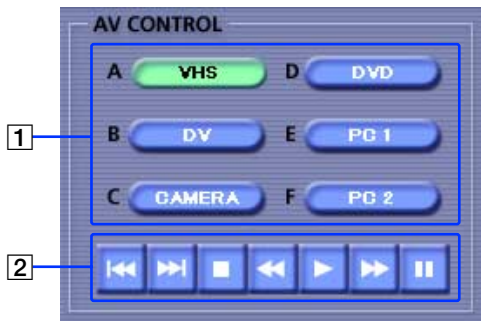

- 1 LINE4 input select button**
This button corresponds to LINE4 input select buttons A to F of the SRP-X700P.
The button indicates an index that is set in the SRP-X700P by the SRP-X700P Manager.
The selected button lights in green.
- 2 REMOTE CONTROL button**
You can remotely control the machine selected by the LINE4 input select button. If a machine that does not accept remote control signals is connected, remote control is disabled in the machine.
You can operate the functions PREV. (previous track), NEXT (next track), STOP (stop), REW. (rewind), PLAY (playback), F.F. (fast forward) and PAUSE (pause).

VOLUME control block

You can operate and mute the MASTER volume control of the SRP-X700P from a remote location.

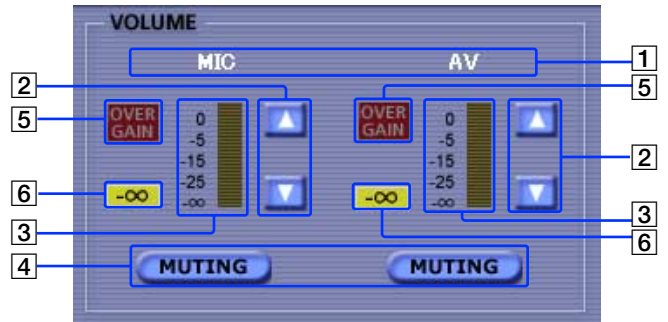

- 1 MASTER index**
Displays the indexes of the MASTER A and MASTER B that are set using the SRP-X700P Manager.
- 2 VOLUME button**
Adjusts the MASTER volume level. Clicking the ▲ or ▼ button increases or decreases the MASTER volume level. (The volume knob of the SRP-X700P does not move.) This button is disabled during muting.
- 3 Fader position indicator (MASTER A and MASTER B)**
Indicates the VOLUME control position.
- 4 MUTING button**
You can mute each MASTER channel. The VOLUME buttons lit in red are disabled during muting.
- 5 OVER GAIN indicator**
The OVER GAIN indicator lights in red when the MASTER fader is increased exceeding the GAIN LIMIT set by the SRP-X700P Manager. The sound volume does not increase even if the MASTER fader is increased exceeding the GAIN LIMIT value.
- 6 -∞ indicator**
The -∞ indicator lights in yellow if no sound is output during muting or when the INPUT fader is at the -∞ level position.

SCENE RECALL Block

You can recall the scene that was memorized before using the SRP-X700P Manager.

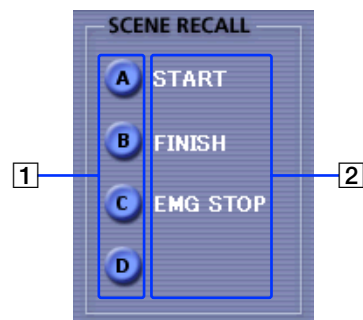

- 1 SCENE RECALL button**
This button corresponds to the SCENE RECALL buttons A to D on the front panel of the SRP-X700P. The selected SCENE button lights in green.
- 2 SCENE RECALL index**
Displays the index set by the SRP-X700P Manager.

Troubleshooting

Before contacting a Sony Sales office or Dealer, check the following again. If the trouble persists, contact your local Sony Sales office or Dealer.

Symptom	Cause/Remedy
Cannot operate the system from User Control Panel. Cannot operate the system using SRP-X700P Manager.	<ul style="list-style-type: none"> • USB cable is not connected. → Check the connection of the USB cable. • The dedicated USB driver software is not installed. → Install the dedicated USB driver software. (Refer to page 4.)
Index is not displayed when using User Control Panel.	<ul style="list-style-type: none"> • Index is not set. → Set up the index using SRP-X700P Manager. (Refer to pages 8, 28, and 29.)
Cannot operate FADER by remote control.	<ul style="list-style-type: none"> • FADER select is set to INACTIVE mode. → Set the FADER select to ACTIVE mode. (Refer to pages 10 and 17.) • The SRP-X700P is not connected. → Check the connection of the SRP-X700P. • There is an error in the GROUP FADER screen setup. → Check the GROUP FADER screen setup. (Refer to page 28.)
Cannot control the sound volume.	<ul style="list-style-type: none"> • Muting is on. → Cancel muting. (Refer to pages 9, 16, and 28.) • FRONT PANEL LOCK button remains in the ON position. → Set the FRONT PANEL LOCK button to the OFF position. (Refer to page 7.)
OVER GAIN indicator remains lit. Cannot increase the sound volume more than a certain level.	<ul style="list-style-type: none"> • An attempt is made to increase the sound volume exceeding the OVER GAIN setup value. → Decrease the fader. (Refer to pages 10 and 17.) → Set up the GAIN LIMIT again. (Refer to pages 10 and 16.)
No sound comes out.	<ul style="list-style-type: none"> • FADER is set in the $-\infty$ position. → Increase the FADER. (Refer to pages 10 and 17.) • Muting is on. → Cancel muting. (Refer to pages 9, 16, and 28.)
PROTECTION indicator is lit.	<ul style="list-style-type: none"> • Temperature of the heat sink inside the amplifier exceeds the specified value. → Turn off the main power and remove the cause of the temperature rise. • Impedance of the speaker connected is too low. → Turn off the main power and connect the SRP-X700P to another speaker having the proper impedance. • The speaker terminals are short-circuited. → Turn off the main power and remove the cause of the short-circuit.
Setup parameters change when power is turned off.	<ul style="list-style-type: none"> • The “Power-On Setting” is set to DEFAULT or SCENE No. 1. → Set the “Power-On Setting” to LAST MEMORY. Alternatively, store the parameter in SCENE No. 1 when the “Power-On Setting” is set to SCENE No. 1. (Refer to page 29.)
When setup file is opened, the error message “Invalid property value” appears on the REMOTE screen.	<ul style="list-style-type: none"> • The setup file that is saved by the SRP-X700P Manager version 1.1 and version 1.2 is going to be opened by the SRP-X700P Manager version 1.0. → Uninstall the SRP-X700P Manager version 1.0 and install the SRP-X700P Manager version 1.2. (Refer to page 5.)
The error message “Unable to connect to SRP-X700P. Please be sure of connection of USB cable and power status of apparatus” appears, and communication with the SRP-X700P cannot be established.	<ul style="list-style-type: none"> • The computer in which the SRP-X700P Manager version 1.0 is installed, is going to be connected to the SRP-X700P version 1.2. → Uninstall the SRP-X700P Manager version 1.0 and install the SRP-X700P Manager version 1.2. (Refer to page 5.)