



RRUBE2

Created for the Pro's, the RRUBE2 mixer case is made for the journey and built to hold strong in high stress situations. Designed to fit the Behringer UB1832FX Pro Mixer and UB2222FX mixer, the RRUBE2 features a heavy-duty removable, latchable cover with our No Pressure Design to protect your mixer controls and a unique low profile base design that allows you to access your mixers rear connection panel without removing your mixer from the case. Tougher than the pavement! That's the idea.

Rugged Road Ready Features

- * Double Anchor Industrial Rivets
- * Recessed, Industrial Grade Latches
- * Recessed, Spring Loaded Handles
- * Industrial Grade Rubber Feet
- * Premium Vinyl Laminated Plywood
- * Tongue and Groove Locking Fit
- * Low Profile Base Design
- * Road Ready Limited Lifetime Warranty

Shipping Dimensions (inch): 19.5 x 20.2 x 6.9

Shipping Weight (lbs): 15.8 lbs

Product Dimensions (inch): 19.1 x 19.8 x 6.3

Product Weight (lbs): 12.5 lbs

Shipping Dimensions (cm): 49.5 x 51.2 x 17.5

Shipping Weight (kg): 7.2 kg

Product Dimensions (cm): 48.5 x 50.2 x 16.0

Product Weight (kg): 5.7 kg

5/05

CASE FOR BEHRINGER UB1832FX-PRO AND UB2222FX- PRO MIXERS

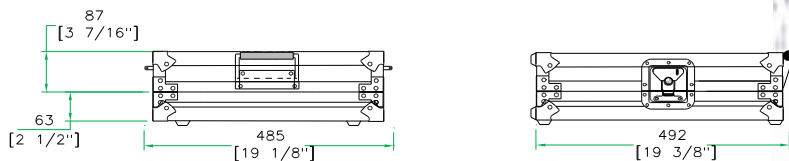

FRONT VIEW

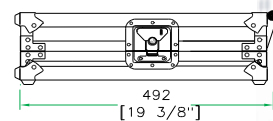

LEFT VIEW

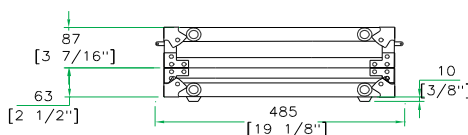

BACK VIEW

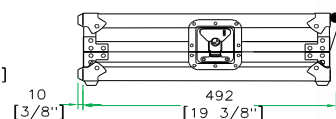

RIGHT VIEW

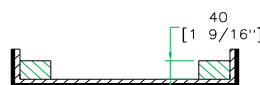

A-A VIEW

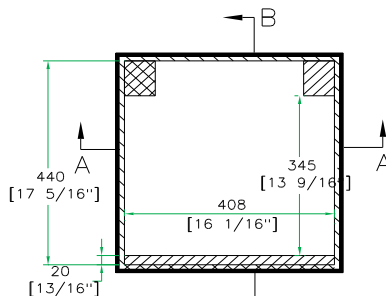

TOP VIEW OF COVER

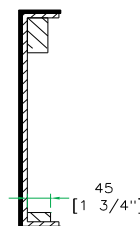

B-B VIEW

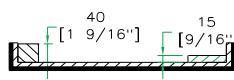

C-C VIEW

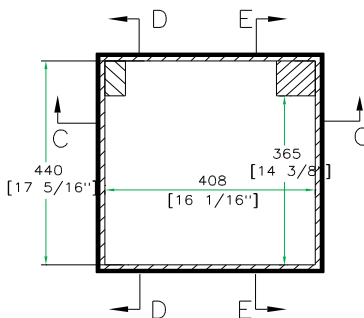

TOP VIEW OF BASE



D-D VIEW



E-E VIEW

www.roadreadycases.com

Road Ready Cases 18120 S. Broadway St. Unit B Gardena, Ca. 90248- 3536
 ph: 310 767 1772 fax: 310 767 1798