



RRM4UHW

Good construction doesn't go out of style. That's our MO and that's why we create cases that are done right. Designed with a 10U slanted top rack for convenient mixer/CD controller placement and a 4U vertical rack for amp or effect units, the RRM4UHW is built right. The RRM4UHW features an 18" mountable rack depth and 2 heavy-duty removable covers. To make a good thing even better we added a unique removable, rear hinged door for easy access to your gear. And to help you get moving we even included a pull out handle and low profile wheels. Now that's the ticket!

Rugged Road Ready Features

- * Beefy, Stackable Ball Corners
- * Double Anchor Industrial Rivets
- * Recessed, Industrial Grade Latches
- * Recessed, Spring Loaded Handles
- * Industrial Grade Rubber Feet
- * Premium 3/8" Vinyl Laminated Plywood
- * Tongue and Groove Locking Fit
- * Heavy Duty Rack Rails
- * Hinged Rear Door
- * Pull Out Handle and Low Profile Wheels
- * Mounting Hardware Included
- * ATA 300 Rating
- * Road Ready Limited Lifetime Warranty

10U Slant /4U Vertical Rack Case w/ Wheels & Handle

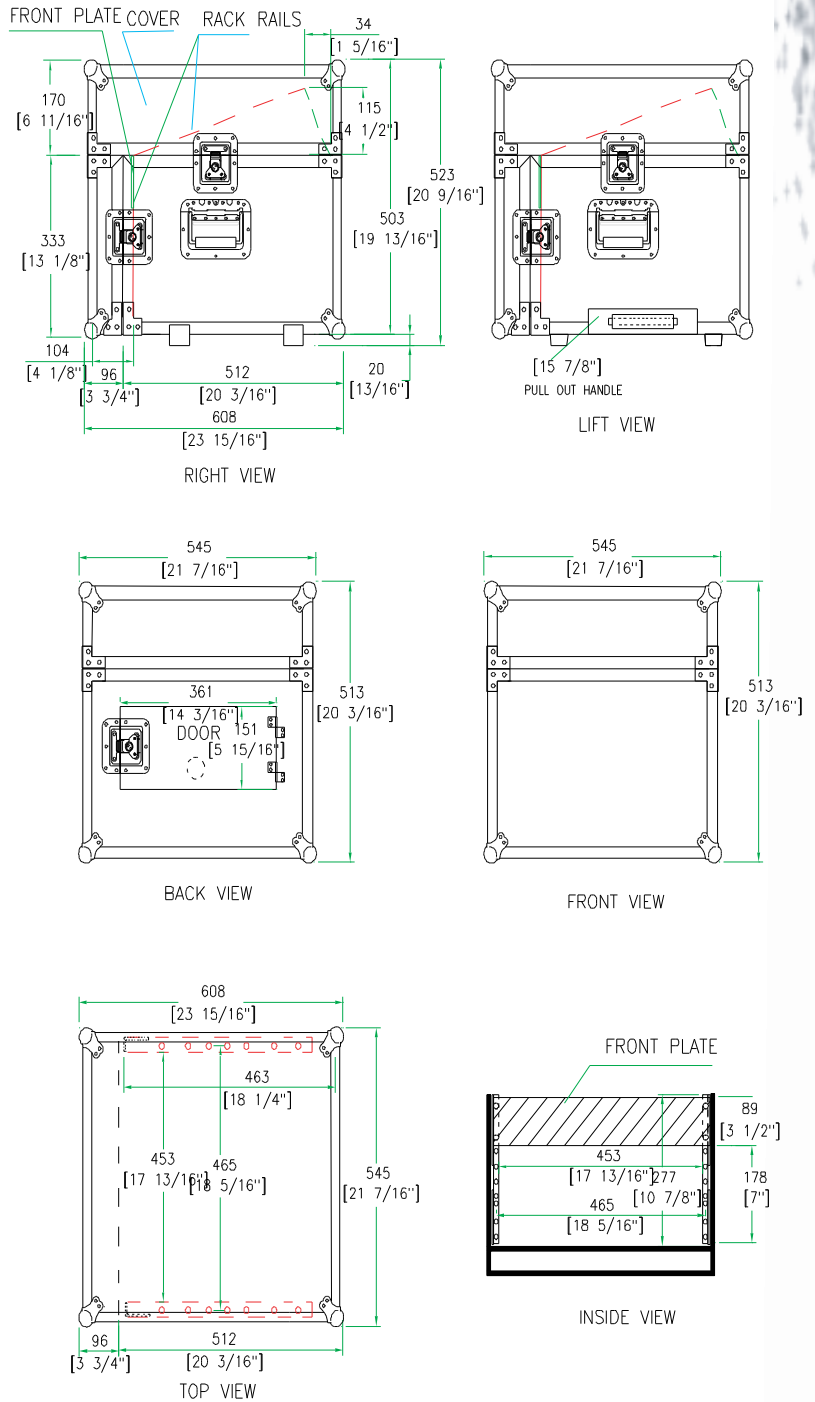

Need optional Road Ready Accessories to help outfit your Slant Rack? Check out our Road Ready Caster Kit (RRWAD), Rolling Base with Storage Drawer (RR6WD) and Road Ready Side Wings (RRMW)

www.roadreadycases.com

Road Ready Cases 18120 S. Broadway St. Unit B Gardena, Ca. 90248- 3536
 ph: 310 767 1772 fax: 310 767 1798