



RR2SRM450C

Designed for a roaring good time, the RR2SRM450C houses 2 Mackie SRM450 speakers in style and comfort. Built tough- the Road Ready way- the RR2SRM450C features a rugged caster to make getting in and out of your gig that much easier and faster!

Rugged Road Ready

Features

- * Beefy Ball Corners
- * Double Anchor Industrial Rivets
- * Recessed, Industrial Grade Latches
- * Recessed, Spring Loaded Handles
- * Premium 3/8" Vinyl Laminated Plywood
- * Tongue and Groove Locking Fit
- * Rugged 3 1/2" Caster
- * ATA 300 Rating
- * Road Ready Limited Lifetime Warranty

CASE FOR 2 MACKIE SRM450 SPEAKERS W/ CASTER

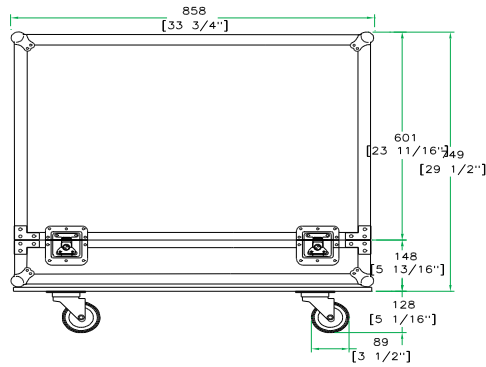

FRONT VIEW
BACK VIEW

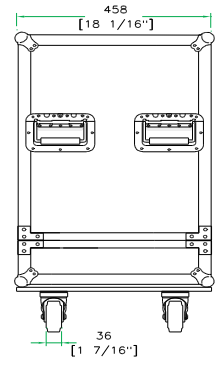

LEFT VIEW
RIGHT VIEW

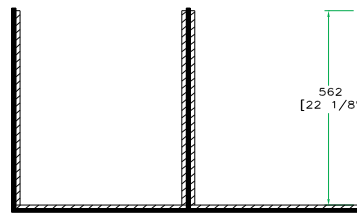

A-A VIEW

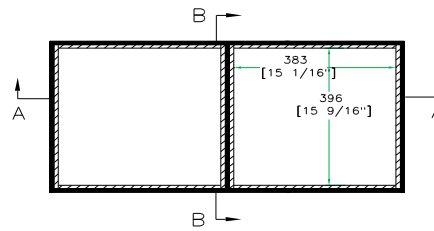

TOP VIEW OF COVER



B-B VIEW

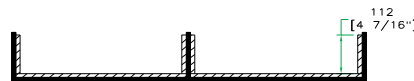

C-C VIEW

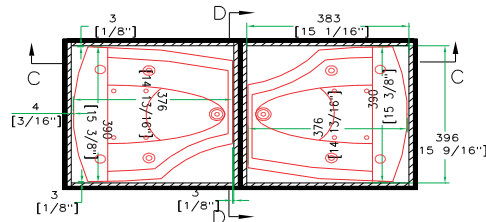

TOP VIEW OF BASE

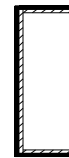

D-D VIEW

www.roadreadycases.com

Road Ready Cases 18120 S. Broadway St. Unit B Gardena, Ca. 90248- 3536
ph: 310 767 1772 fax: 310 767 1798