

Essentials

Retail Display Connectors and Wire



AC-L Adaptor Center Display

Model Number	Description	Suggested Resale
CC-L	Connector Center Display	\$303.04
AC-L	Adaptor Center Display	\$164.49

Packaged connectors for replacement of inventory for above displays.

CC-330F1PC	2-RCA jacks to 1-RCA plug	\$3.99
CC-330PJPC	2-RCA jacks to 1-1/4" phone plug	\$3.99
CC-336APC	Phone jack to RCA plug	\$3.49
CC-340PC	2-1/4" phone jacks to 1-1/4" phone plug	\$5.49
CC-341PC	2-stereo mini to 1-1/4" stereo phone plug	\$6.99
CC-342PC	1/4" stereo phone jack to stereo mini plug	\$2.99
CC-343PC	Stereo mini jack to 1/4" stereo phone plug	\$2.99
CC-344PC	2-stereo 1/4" phone jacks to 1-1/4" stereo plug	\$4.99
CC-345APC	RCA jack to 1/4" phone plug	\$2.49
CC-361APC	1/4" phone jack to 1/4" phone jack	\$4.49
CC-363PC	1/4" phone plug to 1/4" phone plug	\$4.49

CC-L Connector Center Display

Model Number	Description	Suggested Resale
CC-11 (2-pak)	2 conductor 1/4" phone jack	\$3.99
CC-151 PC	1/4" thick panel phone jack	\$7.99
CC-3502HD (2-pak)	RCA phone plug	\$3.49
CC-BF2P	2 conductor 1/4" phone plug	\$2.99
CC-BF3P	3 conductor 1/4" phone plug	\$4.99
CC-MDP (2-pak)	Dual banana jack 2 pack	\$4.99
CC-MF2P	2 conductor 1/4" phone plug large barrel	\$5.99
CC-NC3FDL-1	XLR 3 pin female receptacle	\$4.49
CC-NC3FX	XLR 3 pin male receptacle	\$4.49
CC-NC3MX	XLR 3 pin male receptacle	\$4.49
CC-RF2P	2 conductor 1/4" right angle phone plug	\$5.49
CC-RP S/W(9)	Rack panel screws and washers	\$2.49
CC-ACC-3-8	AC line cable 3 conductor	\$10.99

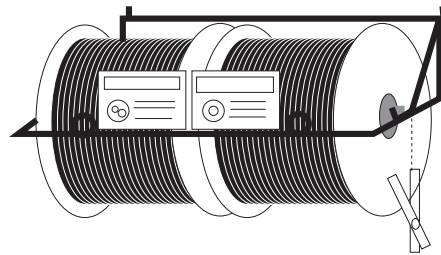

WC-L Wire Center Display

Model Number	Description	Suggested Resale per Spool
WC-AC1	Spool 500 ft. AC1	\$111.99
WC-224S	Spool 500 ft. 224S	\$198.49
WC-223B	Spool 500 ft. 223B	\$322.49
WC-120SX	Spool 350 ft. 120SX	\$176.49
WC120S1	Spool 500 ft. 120S1	\$180.49
WC120SM	Spool 500 ft. 120SM	\$162.99
WC2120SM	Spool 250 ft. 2120SM	\$186.49
WC10-2Z	Spool 250 ft. 10-2Z	\$508.86
WC-12-2	Spool 250 ft. 12-2	\$171.99
WC-14-2	Spool 350 ft. 14-2	\$177.99
WC-16-2	Spool 500 ft. 16-2	\$175.49
WC-Rack	Rack for two spools Includes wire stripper and Sign Cards	N/C

Essentials

Bulk Audio Cable

Model Number	No. of Conductors or Pairs	Wire Gauge AWG	Stranding/ Strand AWG	% of Shield Coverage	Shield Material Type	Outside Diameter (in.)	Outer Jacket Material	Suggested Resale Per Foot
--------------	----------------------------	----------------	-----------------------	----------------------	----------------------	------------------------	-----------------------	---------------------------

Music Mover™ Single Conductor Shielded Audio Cable for Musical Instruments, and Unbalanced Equipment Hookup and Patching.

120S1 Black	1	20	26/34	55	BC Serve	.240	PVC	\$0.33
120SM	1	20	26/34	70	BC Serve	.194	PVC	\$0.28
120SX	1	20	41/36	90	BC Serve	.280	PVC	\$0.45
2120SM	2	20	26/34	70	BC Serve	.200x.402	PVC	\$0.66

DynaMike™ Two Conductor Shielded Audio Cable for LO-Z Microphones and Balanced Line Instrument Connections.

223B	2	23	60/40	94	BC Braid	.240	PVC	\$0.62
224S Black	2	24	16/36	90	BC Serve	.235	PVC	\$0.37
224SM	2	24	16/36	80	BC Serve	.195	PVC	\$0.33

AmeriQuad™ Four Conductor Shielded Audio Cable with Kevlar™ Strength Member for LO-Z Microphones and Balanced Line Instrument Connections.

424BK	4	24	24/40	96	TC Braid	.240	PVC	\$0.91
-------	---	----	-------	----	----------	------	-----	--------

Two, Four and Eight Conductor Unshielded Audio Cable for Loudspeaker Interconnection.

16-2 Speaker	2	16	65/34	None	None	.260	PVC	\$0.33
14-2 Speaker	2	14	41/30	None	None	.325	PVC	\$0.45
13-8 Speaker	8	13	52/30	None	None	.590	PVC	\$2.09
12-2 Speaker	2	12	65/30	None	None	.375	PVC	\$0.66
11-4 Speaker	4	11	82/30	None	None	.570	PVC	\$2.05
10-2 Zip CLR	2	10	420/36	None	None	.245x.480	PVC	\$1.21

DataMaster™ Two and Four Conductor Shielded Cable for Data Transfer and MIDI.

224F Black	2	24	7/32	100	Foil	.211	PVC	\$0.37
424F	4	24	7/32	100	Foil	.211	PVC	\$0.37

Acculink™ Individually Shielded and Jacketed Multipair Audio Cable for Microphones and Line Level Interconnection for Studios and Broadcast.







AC 1	1	24	7/32	100	Foil	.134	PVC	\$0.20
AC 2	2	24	7/32	100	Foil	.205x.335	PVC	\$0.54
AC 4	4	24	7/32	100	Foil	.370	PVC	\$0.91
AC 8	8	24	7/32	100	Foil	.475	PVC	\$2.01
AC 16	16	24	7/32	100	Foil	.738	PVC	\$3.90
AC 26	26	24	7/32	100	Foil	.865	PVC	\$5.79
ACD 8 (Digital New)	8	24	7/32	100	Foil	.465	PVC	\$2.49







DuraLink™ Individually Shielded Audio Multipair for Microphone and Line Level Interconnection. Great for Portable and Permanent Use.

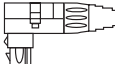





DLA 8	8	24	7/32	100	Foil	.415	PVC	\$1.38
DLA 12	12	24	7/32	100	Foil	.500	PVC	\$1.82
DLA 16	16	24	7/32	100	Foil	.570	PVC	\$2.40
DLA 20	20	24	7/32	100	Foil	.630	PVC	\$2.63
DLA 28	28	24	7/32	100	Foil	.730	PVC	\$4.05
DLA 32	32	24	7/32	100	Foil	.800	PVC	\$5.02
DLA 40	40	24	7/32	100	Foil	.860	PVC	\$6.38
DLA 48	48	24	7/32	100	Foil	.880	PVC	\$8.24
DLA 56	56	24	7/32	100	Foil	.950	PVC	\$9.73
DLA 67	67	24	7/32	100	Foil	1.020	PVC	\$11.68





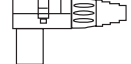

Bulk Parts

Neutrik XLR-type Connectors

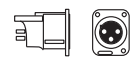
Female Cable Mount Solder Type	Model Number	# of Pins	Shell	Contacts	Locking Latch	Special Features	Sug. Resale
	NC3FX	3	N	S	Y		\$4.07
	NC3FX-B	3	BC	G	Y		\$6.23
	NC3FX-BAG	3	BC	S	Y		\$5.03
	NC3FX-HD	3	N	S	Y	HD,WT	\$11.84
	NC3FX-HD-B	3	BC	G	Y	HD,WT	\$13.35
	NC3FX-S	3	N	S	Y	SW	\$12.53
	NC3FX-S-B	3	BC	G	Y	SW	\$12.97
	NC4FX	4	N	S	Y		\$6.98
	NC4FX-B	4	BC	G	Y		\$8.85
	NC4FX-BAG	4	BC	S	Y		\$7.88
	NC5FX	5	N	S	Y		\$8.54
	NC5FX-B	5	BC	G	Y		\$10.55
	NC5FX-BAG	5	BC	S	Y		\$10.73
	NC6FX	6	N	S	Y		\$10.34
	NC6FX-B	6	BC	G	Y		\$12.30
	NC6FX-BAG	6	BC	S	Y		\$10.92
	NC6FX-S	6	N	S	Y		\$11.08
	NC7FX	7	N	S	Y		\$11.63
	NC3FRC	3	N	S	Y	RA	\$11.54
	NC3FRC-B	3	BC	G	Y	RA	\$12.83
	NC3FRC-BAG	3	BC	S	Y	RA	\$12.69
	NC4FRC	4	N	S	Y	RA	\$11.57
	NC4FRC-BAG	4	BC	S	Y	RA	\$11.31

Female Panel Mount Solder Type	Model Number	# of Pins	Shell	Contacts	Locking Latch	Special Features	Sug. Resale
	NC3FPP	3	P	S	Y		\$1.94
	NC3FDL-1	3	N	S	Y		\$3.69
	NC3FDL-1-B	3	BC	G	Y		\$5.42
	NC3FDL-1-BAG	3	BC	S	Y		\$5.12
	NC3FDL-1-O	3	N	S	N		\$3.89
	NC3FDL-1-O-BAG	3	BC	S	N		\$5.12
	NC4FDL-1	4	N	S	Y		\$8.30
	NC4FDL-1-B	4	BC	G	Y		\$8.93
	NC4FDL-1-BAG	4	BC	S	Y		\$8.10
	NC5FDL-1	5	N	S	Y		\$11.50
	NC5FDL-1-B	5	BC	G	Y		\$13.13
	NC5FDL-1-BAG	5	BC	S	Y		\$11.92
	NC6FDL-1	6	N	S	Y		\$16.28
	NC6FDL-1-BAG	6	BC	S	Y		\$18.68
	NC6FDS-L-1	6	N	S	Y		\$16.28
	NC7FDL-1*	7	N	S	Y		\$19.19





Male Cable Mount Solder Type	Model Number	# of Pins	Shell	Contacts	Locking Latch	Special Features	Sug. Resale
	NC3MX	3	N	S	N		\$3.77
	NC3MX-B	3	BC	G	N		\$5.72
	NC3MX-BAG	3	BC	S	N		\$3.79
	NC3MX-HD	3	SS	S	N	HD,WT	\$11.28
	NC3MX-HD-B	3	SS	G	N	HD,WT	\$12.60
	NC4MX	4	N	S	N		\$5.18
	NC4MX-B	4	BC	G	N		\$6.89
	NC4MX-BAG	4	BC	S	N		\$5.82
	NC5MX	5	N	S	N		\$6.59
	NC5MX-B	5	BC	G	N		\$7.94
	NC5MX-BAG	5	BC	S	N		\$7.28
	NC6MX	6	N	S	N		\$6.72
	NC6MX-B	6	BC	G	N		\$8.84
	NC6MX-BAG	6	BC	S	N		\$8.18
	NC6MX-S	6	N	S	N		\$6.59
	NC7MX	7	N	S	N		\$8.48
	NC3MRC	3	N	S	N	RA	\$11.03
	NC3MRC-B	3	BC	G	N	RA	\$11.63
	NC3MRC-BAG	3	BC	S	N	RA	\$11.09
	NC4MRC	4	N	S	N	RA	\$11.04
	NC4MRC-BAG	4	BC	S	N	RA	\$11.04

Male Panel Mount Solder Type	Model Number	# of Pins	Shell	Contacts	Locking Latch	Special Features	Sug. Resale
	NC3MPP	3	P	S	N		\$1.91
	NC3MDL-1	3	N	S	N		\$3.71
	NC3MDL-1-B	3	BC	G	N		\$5.33
	NC3MDL-1-BAG	3	BC	S	N		\$5.00
	NC4MDL-1	4	N	S	N		\$5.51
	NC4MDL-1-B	4	BC	G	N		\$6.09
	NC4MDL-1-BAG	4	BC	S	N		\$5.84
	NC5MDL-1	5	N	S	N		\$8.75
	NC5MDL-1-BAG	5	BC	S	N		\$8.87
	NC6MDL-1	6	N	S	N		\$11.09
	NC6MDL-1-BAG	6	BC	S	N		\$11.15
	NC6MDS-L-1*	6	N	S	N		\$10.67
	NC7MDL-1*	7	N	S	N		\$19.19



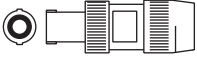
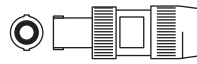



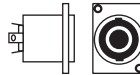
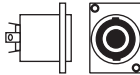
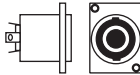
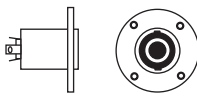
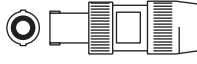
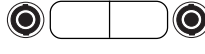
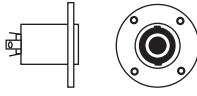
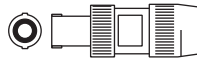

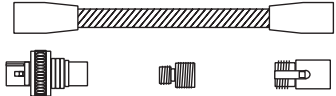
Neutrik Combo Jacks			
	NCJ6FI-S	3-pole XLR Female receptacle with 1/4" stereo jack without normalizing, with solder cups.	\$4.99
	NCJ9FI-S	3-pole XLR Female receptacle with 1/4" stereo jack with normalizing	\$4.99

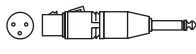
Bulk Parts

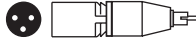
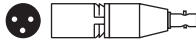
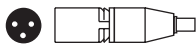
Neutrik Speakon Speaker Connectors

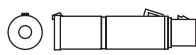
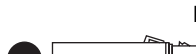
NEUTRIK Speakon Speaker Connectors		Model Number	Description	Sug. Resale
	NL2FC		Female, cable mount, 2-pin loudspeaker connector	\$4.66
	NL4FC		Female, cable mount, 4-pin loudspeaker connector	\$8.08
	NL4FX NL4FRX		New 4-pole Speakon New right angle 4-pole Speakon	\$6.45 \$8.64
	NL4MM		Coupler, male to male speakon, 4-pin	\$8.40
	NL4MMX LRX		New 4-pole Coupler Right angle kit for new Speakon	\$8.67 \$2.49
	NL2MP		Male, panel mount, 2-pin speakon	\$3.38
	NL4MP		Male, panel mount, 4-pin speakon	\$4.05
	NL4MP-ST		4-pole Speakon panel mount screw terminal, 60 ga. wire	\$4.65
	NL4MPR		Male, panel mount, 4-pin speakon, EP retrofit	\$4.63
	NL8FC		Female, cable mount, 8-pin loudspeaker connector	\$16.56
	NL8MM		Coupler, male to male speakon, 8-pin	\$29.01
	NL8MPR		Male, panel mount, 8-pin speakon, EP retrofit	\$11.76
	NA4LJ		Adapter, Female 4-pin Speakon to 1/4" phone plug. Wired circuit "1."	\$11.41





NEUTRIK GNS Modular Gooseneck Systems	
	No noise, stainless steel, non-reflective, matte black finish, modular gooseneck sets including: gooseneck (7", 14", or 20"), female XLR module with locking ring for securing microphones, 2 male thread adapters (M 17 x 1" - 3/8") and thread adapter (MX 17 x 1-5/8") female with cable outlet, through-hole and mounting facility to panels up to 7mm. Mates with ATLAS AD-1
(System) GNS-18	\$58.74
(System) GNS-36	\$71.34
(System) GNS-50	\$78.94
(Gooseneck Only) GN-18	\$19.80
(Gooseneck Only) GN-36	\$26.88
(Gooseneck Only) GN-50	\$49.92

"NA" Series Adapters		Model Number	Description	Sug. Resale
	NA2FBNC		XLR Female to BNC Female Unwired Locking Latch: Yes	\$17.24
	NA2FP		XLR Female to 1/4" Phone Unwired Locking Latch: Yes	\$11.80
	NA2FPMF		XLR Female to RCA Jack Unwired Locking Latch: Yes	\$10.85
	NA2FPMM		XLR Female to RCA Plug Unwired Locking Latch: Yes	\$27.76
	NA2MPMM		XLR Male to RCA Plug Unwired Locking Latch: No	\$27.76
	NA2MBNC		XLR Male to BNC Female Unwired Locking Latch: No	\$15.78
	NA2MPMF		XLR Male to RCA Jack Unwired Locking Latch: No	\$27.59
	** NA3FF/W		XLR Female to XLR Female Wired Locking Latch: Yes	\$15.56
	NA3FJ		XLR Female to 3-con. Phone Jack Unwired Locking Latch: Yes	\$13.52
	NA3FM		XLR Female to XLR Male Unwired Locking Latch: Yes	\$12.66
	NA3FP		XLR Female to 3-Cond. Phone Plug Unwired Locking Latch: Yes	\$12.60
	NA3MJ		XLR Male to Locking Phone Jack Unwired Locking Latch: Yes	\$12.88
	** NA3MM/W		XLR Male to XLR Male Wired Locking Latch: No	\$14.26
	NA3MP		XLR Male to 3-Cond. Phone Plug Unwired Locking Latch: No	\$12.21

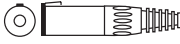
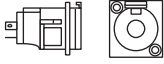

****Only the NA3FF/W and NA3MM/W are pre-wired for immediate shipment; the others may be wired on request.**

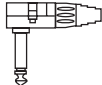

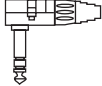
Bulk Parts

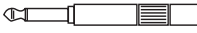
Neutrik 1/4" Connectors

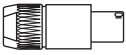
"NJ" and "NP" 1/4" Phone Jacks and Plugs		Model Number	# of Pins Shell	Contacts	Locking Latch	Special Features	Sug. Resale
	NJ3FC6	3 N S Y	1/4" Inline Jack				\$9.84
	NJ3FC6-BAG	3 BC S Y	1/4" Inline Jack				\$9.45
	NJ3FP6C	3 N S Y	1/4" Jack				\$7.12
	NJ3FP6C-BAG	3 BC S Y	1/4" Jack				\$8.98
	NP2C	2 N N N					\$5.04
	NP2C-BAG	2 BC N N					\$5.04
	NP2C-T10AA	2 N N N	TFMR				\$30.96
	NP2RC	2 N N N	RA				\$8.56
	NP3C	3 N N N					\$5.84
	NP3C-BAG	3 BC N N					\$5.99
	NP3RC	3 N N N	RA				\$10.16
	NP3RC-BAG	3 BC N N	RA				\$10.86

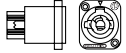
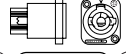
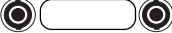

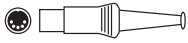

Neutrik Long Frame 1/4" Plugs (Military grade)		Model Number	# of Pins Shell	Contacts	Locking Latch	Sug. Resale
	NP3TB-B	3 BC N N				\$10.04
	NP3TB-R	3 Red N N				\$10.04



Neutrik Powercons			Sug. Resale
20 amp "Quick-lock," 3-pole, ULR recognized, AC Connectors			
	NAC3FCA	Cable, Power In, Blue	\$9.81
	NAC3FCB	Cable, Power Out, Gray	\$9.81
	NAC3MPA	Panel, Power In, Blue	\$5.04
	NAC3MPB	Panel, Power Out, Gray	\$5.04
	NAC3MM	Coupler for linking cables	\$19.86

5-Pin Din "MIDI" Connectors		Model Number	# of Contacts Shell	Contacts	Locking Latch	Special Features	Sug. Resale
	NYS322	5 N S N					\$1.81
	71432-151	5 N S N	RA				\$10.40
	NYS325	5 N S N					\$1.08
	MA-1	Coupler, 5-pin MIDI to 5-Pin MIDI					\$2.32

Re'an Patch Panels		Sug. Resale
		
Long Frame Military Grade, 48 pt., single space, Patch Panel		
LF48-1A	Red front	\$630.40
LF48-1D	Blue front	\$630.40
LF48-1O	Black front	\$630.40
LF48-1S	Silver front	\$630.40

Neutrik Patch Bay		Sug. Resale
		
NYS-SPP-L	Economy 48 pt. modular patch bay in one rack space	\$151.02

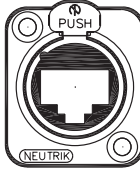

Pro Co Switches		Model Number	Description	Sug. Resale
	7707001	3PDT footswitch, push on/push off. 6A 125 VAC	\$9.95	
	110-63	On/off switch, SPST, toggle, 6A 125 VVAC	\$6.27	
	7101-MYZQE	SPDT short-bat mini-toggle, 5A 125 VAC	\$11.97	
	7201-MYZQE	Same As Above, DPDT	\$12.11	
	621-11221	Carling, SPDT rocker switch	\$3.51	
	621-12221	Carling, DPDT rocker switch	\$2.99	

Ethercon		Sug. Resale	
New ruggedized "D" and "A" style Neutrik panel connectors and XLR sized cable housings designed to protect the fragile latch and cover of standard JR45 connectors from breakage.			
	NE8FDV-YK	Ethercon Krone panel, IDC punch down	\$14.49
	N38FDV-Y110	Ethercon 100 ohm panel, IDC punch down	\$14.49
	NE8MC	Ethercon cable housing, nickel RJ45's not included	\$4.49
	NE8MC-B	Ethercon cable housing, black RJ45's not included	\$4.49

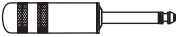
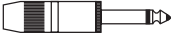

Bulk Parts

G&H Industries Audio Connectors

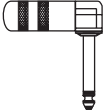
1/4" Big Foot 2-Cond. (T/S) Phone Plugs

Model Number	Diameter for Cable Entry	Finish	No. of Conductors	Barrel Finish Options	Plug Options	Sug. Resale
 BF2P	.300"	N	2	G Bl Br	G QP	\$2.99
 BF2PS	.400"	N	2	G Bl Br	G QP	\$4.03
 MF2P	.500"	N	2	G Bl Br	G QP	\$5.46
RMF2P	.500"	N	2	G Bl Br	G QP	\$12.85
 RF2P	.300"	N	2	G Bl Br	G QP	\$4.92
RF2PS	.400"	N	2	G Bl Br	G QP	\$12.06

1/4" Big Foot 3-Cond. (T/R/S) Phone Plugs

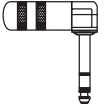
 BF3P	.300"	N	3	G Bl Br	G	\$4.38
BF3PS	.400"	N	3	G Bl Br	G	\$4.42
 MF3P	.500"	N	3	G Bl Br	G	\$4.99
RMF3P	.500"	N	3	G Bl Br	G	\$19.76
 RF3P	.300"	N	3	G Bl Br	G	\$6.25
RF3PS	.400"	N	3	G Bl Br	G	\$17.60

New

Field Pack	BF2PFP6	Field Pack (6)	\$17.98
	BF3PFP6	Field Pack (6)	\$28.98
Bulk Pack	BF3PBP50	Bulk Pack (50)	\$114.00
	BF3FBP50	Bulk Pack (50)	\$204.00

G&H The Boss™ Banana Plugs

Model Number	Body Color	Contact Finish Option	Sug. Resale
 BBN Black	Black	G	\$4.13
BBN Red	Red	G	\$4.13
BBN Brown	Brown	G	\$4.13
BBN Yellow	Yellow	G	\$4.13
BBN Orange	Orange	G	\$4.13
BBN Blue	Blue	G	\$4.13
BBN Green	Green	G	\$4.13

G&H Tiny Telephone (Bantam) Plugs





Model Number	Shell Finish	Tip Finish	Sug. Resale
 TT3P-B	Black	Nickel	\$8.38
TT3P-N	Nickel	Nickel	\$8.38
TT3P-R	Red	Nickel	\$8.38

BF3P T/R/S 1/4" Phone Plugs



- Easy to Strip; Easy to Solder; Easy to Assemble
- Only one strip length is needed
- Wire is easy to position in solder cups
- Ground can be crimped, soldered or both
- Extra set of "ears" for cable strain relief
- Built to last longer than the service life of the equipment it hooks up
- Least costly quality connector on the market



Amphenol Audio XLR Connectors





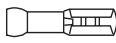

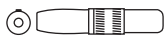
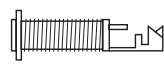
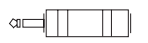
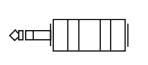

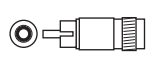
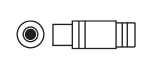
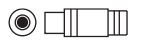
Model Number	Description	Sug. Resale
 AC3M	3-pin Male solder type, cable mount XLR	\$4.77
AC3MI	3-pin Male solderless IDC type, cable mount XLR	\$2.37
 AC3F	3-pin Female solder type, cable mount XLR	\$5.50
AC3FI	3-pin Female solderless IDC type, cable mount XLR	\$3.75
 AC3MDZ	3-pin Male solder type, "D" series, metal panel mount XLR	\$4.13
AC3MDPI	3-pin Male solderless IDC type, "D" series, plastic shell, panel mount XLR	\$2.05
 AC3FDZ	3-pin Female solder type, "D" series, metal panel mount XLR	\$5.31
AC3FDPIL	3-pin Female solderless IDC type, "D" series, plastic shell, panel mount XLR	\$2.47

Bulk Parts

Pro Co Connectors



Thomas & Betts		Model Number	Wire Range	Max. Ins.	Bolt Hole	Sug. Resale
Disconnects						
	FD187-14(25)	14	.250	NA		\$5.32
	FD187-10(25)	12	.250	NA		\$5.32
	PV22-6F(25)	18	.187	NA		\$5.32

Pro Co "PC" Series Connectors		Model Number	# of Pins Shell	Contacts	Locking Latch	Special Features	Sug. Resale
	121HD	2 N N N					\$3.22
	151PC	2 N N N					\$7.19
	780PC	2 N N N		3.5mm			\$1.73
	797PC	3 N N N		3.5mm			\$2.57
	3501FRPC	2 N N N		3.5mm			\$2.85
	3502PC	2 N N N		RCA			\$1.52
	3502HD	2 N N N		HD, RCA			\$1.99
	3503PC	2 N N N		FRCA			\$2.15

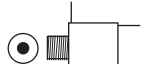
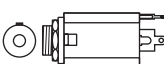
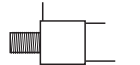
Switchcraft Parts Non-Cross-Referenced Parts		Model Number	# of Conductors Shell	Contacts	Locking Latch Type	Sug. Resale
	TA3FL	3 P S Y		TINI-QG		\$11.06
	TA3ML	3 P S N		TINI-QG		\$15.50
	35HDNN	3 N N N		LD		\$8.28
	L11	2 N N		1/4" Longframe		\$3.00
	L12B	3 N N		1/4" Longframe		\$4.12
	NL112B	3 P N N		1/4"		\$4.24
	L114B	3 P N N		1/4"		\$4.92
	131	3 N N N		1/4" (T/R/S)		\$14.96

Miscellaneous Jacks		Model Number	# of Pins Shell	Contacts	Locking Latch	Special Features	Sug. Resale
	27-655	3 P S N		3.5mm			\$1.17
	LS112B	3 P S N		1/4"			\$0.99
	LS142A	2 P S N		3.5mm			\$0.99

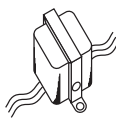
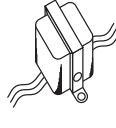
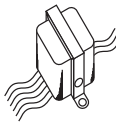

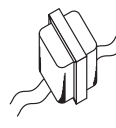
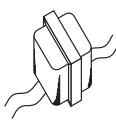
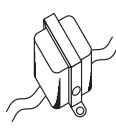

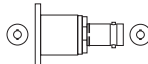
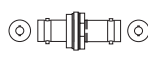
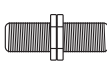

Pro Co Transformers



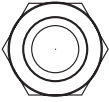

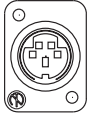

Pro Co Transformers		Model Number	Description	Sug. Resale
	DBT-1		Pro Co direct box transformer. 20kΩ/150Ω, dual electrostatic shields, open channel frame construction with mounting ears. 4" color coded leads.	\$42.90
	MBT-1		Pro Co microphone bridging transformer. 150Ω/150Ω, dual electrostatic shields, open channel frame construction with mounting ears. 10" color coded leads.	\$42.73
	MBT-2		Pro Co microphone bridging transformer. 150Ω/150Ω/150Ω, dual electrostatic shields, open channel frame construction with mounting ears. 10" color coded leads.	\$60.80
	LOT-1		Pro Co line output transformer. 600Ω/600Ω or 150Ω/600Ω, open channel frame construction with mounting ears. 8" color coded leads.	\$49.91
	LOT-M		Pro Co line output transformer 600Ω/600Ω, open channel frame, no mounting ears, 2" color coded leads. Same function as LOT-1, but smaller with less headroom.	\$32.76
	MMT-1		Pro Co microphone matching transformer. 150Ω/15kΩ, open channel frame construction, no mounting ears. 2" color coded leads. Used in 9144PC Lo- to Hi-Z Transformer assembly.	\$19.99
	CBT-1A		Pro Co direct box transformer. 20kΩ/150Ω, dual electrostatic shields, open channel frame construction with mounting ears. 4" color coded leads.	\$29.99

Canare, Neutrik & Amphenol Video Connectors		Model Number	Description	Sug. Resale
	Neutrik	NBB75DFI	"D" style Panel Mount	\$11.13
	Amphenol	AL-BNC-JJ-75	Feedthru BNC Connector	\$9.15
	Canare	BCJ-JRU	Recessed 75Ω	\$14.80
	Neutrik	NBB75FI	Feedthru BNC	\$12.12
	Amphenol	AL-BNC-JJA-75	Panel Mount Jack	\$8.09
	Canare	BCJ-JR	Bulkhead 75Ω	\$11.53
	Blonder-Tongue	GF8IC	"F" or "G" type feedthru panel mount connector	\$4.18

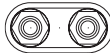
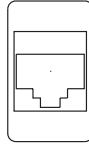
Bulk Parts

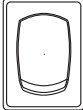
Pro Co Connectors









Misc. Cookbook Panel Connectors	Model Number	Caplain Nema Indicator	Description	Sug. Resale
	LS-142A	H-1	1/8" mini jack, 2-cond., closed ckt., iso washers	\$0.97
	27-655	H-2	3.5mm mini phone jack, 3-cond., open ckt., iso washers	\$1.17
	NYS325	I-1	DIN connector, Female, 5-cond. used for MIDI	\$1.08
	SVMD-4PB	I-2	4-Pin mini DIN panel mount, female solder	\$6.42
	SVMD-6PB	I-3	6-Pin mini DIN panel mount, female solder	\$7.06
	TCS-415P	I-4	4-Pin mini DIN panel mount, female feedthru	\$19.28
	TCS-615P	I-5	6-Pin mini DIN panel mount, female feedthru	\$30.42
	119-5F	J-1	EBY (KODAK) projector connector, Female	\$23.44
	119-5M5	J-2	EBY (KODAK) projector connector, Male	\$21.60
	3505F	K-1	RCA phono jack, audio/video, iso washers	\$4.31
	161-1004 White		Mouser Barrel, rear solder RCA, insulator color White	\$2.12
	161-1002 Red		Mouser Barrell, rear solder RCA, insulator color Red	\$2.12
	161-1005 Yellow		Mouser Barrell, rear solder RCA, insulator color Yellow	\$2.12
	16PJ052BLK		Mouser Barrell, rear solder RCA, insulator color Black	\$2.12
	RJ-RU White	K-5*	Canare flush-mount RCA, insulator color White	\$13.99
	RJ-RU Red	K-6*	Canare flush-mount RCA, insulator color Red	\$13.99
	RJ-RU Yellow	K-7*	Canare flush-mount RCA, insulator color Yelow	\$13.99

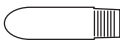





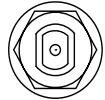

Misc. Cookbook Panel Connectors	Model Number	Caplain Nema Indicator	Description	Sug. Resale
	27-1085	K-3	RCA phono jack, feed thru	\$4.05
	UDBP	L-1	Universal dual binding post	\$9.72
	SE648A6-03	M-1	Modular receptacle, 6-Cond. IDC Type, standard "RJ-11"	\$12.84
	SE648A8-03	M-2	Modular receptacle, 8-Cond. IDC Type, standard "RJ-45"	\$15.99
	555050-1	M-3	Feedthrough RJ-11 phone jack	\$9.47
	SE648C8A5-03	M-4	CAT-5, 8-Cond. IDC Type, "RJ-45," Gov't standard	\$11.22
	SE648C8B5-03	M-5	CAT-5, 8-Cond. IDC Type, "RJ-45," WECO standard	\$16.00
	AMP555052-1	M-6	Feedthru, RJ-45, Cat 5 Jack	\$14.43
	CD-9240		RJ45 Feedthru	\$5.49
	10-23937		RJ45 Lats Feedthru	\$17.99
	621-12221	N-2	Rocker switch, DPDT, 5A 125 VAC	\$3.51
	629-GRS4023C-1300		Momentary rocker switch	\$5.43
	110-63	O-1	Toggle switch, SPST, toggle, 6A 125 VAC	\$6.27
	IL-250NBL3	O-2	Toggle switch, 4PDT, 15A 120 VAC	\$35.63
	CLB300G	O-3	24 volt green LED with flange	\$1.47
	CLB300R	O-4	24 volt red LED with flange	\$1.47
	7101-MYZQE	P-1	Mini-bat Toggle switch, SPDT, 5A 125 VAC	\$11.97
	AML21-CBA2AC	P-3	DPDT-Momentary, 2 amp.	\$3.13
	AML21-CBA2AD	P-4	DPDT-Alternate action, 2 amp.	\$39.03

(if no lens is ordered, switches are automatically shipped with a white (default) lens.)

Bulk Parts

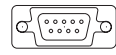
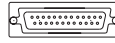

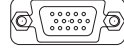
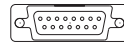
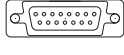
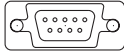

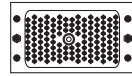

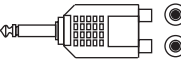
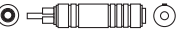
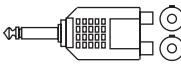
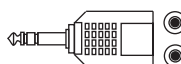

Pro Co Connectors (Cond.)

Misc. Cookbook Panel Connectors	Model Number	Captrain Nema Indicator Description	Sug. Resale
	AML86	PL-1 6V bulb for AML 21 (For use with P-3 and P-4 only)	\$1.58
	AML73	PL-2 12V bulb for AML 21 (For use with P-3 and P-4 only)	\$6.27
	AML85	PL-3 24V bulb for AML 21 (For use with P-3 and P-4 only)	\$1.87
	AML-C10W	PL-4 White lens for AML 21 (For use with P-3 and P-4 only)	\$3.79
	AML-C10Y	PL-5 Yellow lens for AML 21 (For use with P-3 and P-4 only)	\$3.79
	AML-C10R	PL-6 Red lens for AML 21 (For use with P-3 and P-4 only)	\$3.79
	AML-C10G	PL-7 Green lens for AML 21 (For use with P-3 and P-4 only)	\$3.79
	CH7562K4	P-12 DPDT-On/Off/On 15 amp toggle	\$30.23
	CH7565K6	P-13 DPDT-On/On 15 amp toggle	\$15.35
	CK7201P3YZQE	P-14 DPDT On/On flat toggle	\$25.20
	CK7203P3YZQE	P-15 DPDT On/Off/On flat toggle	\$21.60
	P2011U	P-17 Switchlock, DPDT, black nylon, 4a 125 VAC, 2 position	\$13.70
	81F1315	P-18 C&K latching, Y-series key-switch	\$43.67
	D4C0206N	P-19 Electroswitch 2pol/6pos or 1pol/12pos rotary switch	\$55.31
	BCJ-JR	Q-1 Canare BNC feedthru panel jack with IU-7/16 isolation gasket	\$11.54
	BCJ-R/1	Q-2 Canare BNC solder panel jack with IU-7/16 isolation gasket	\$10.48
	BCJ-JRU	R-1 Canare flush-mount isolated BNC feedthru	\$14.80
	BCJ-RU	R-2 Canare flush-mount isolated BNC solder	\$12.31

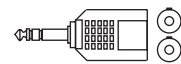
Misc. Cookbook Panel Connectors	Model Number	Captrain Nema Indicator Description	Sug. Resale
	GF81C	S-1 Blonder-Tongue "F" connector, feedthru, iso washers	\$4.18
	TCS-7649	S-2 4-Pin mini DIN panel mount, female	\$5.17
	PKD-10KLIN	T-1 10K mini pot. with knob .75" dia., 1-10 dial	\$31.23
	10LC2	T-2 Lowell Attenuator, 10 watt	\$48.39
	35LC2	T-3 Lowell Attenuator, 35 watt	\$57.49
	100LC2	T-6 Lowell Attenuator, 100 watt	\$65.11
	PKES-10K	T-5 10K linear pot. with knob .90" dia.	\$25.75
	DE-9F	Y-1 9 Contact, socket connector, solder type	\$1.49
	DB-25F	Y-2 25 Contact, socket connector, solder type	\$2.96
	DB-25M	Y-3 25 Contact, pin connector, solder type	\$1.52
	CD-9532HD	Y-4 15 Contact, Hi-density pin connector, feedthru type	\$7.38
	CD-9515HDS	Y-5 15 Contact, Hi-density pin connector, solder type	\$2.04
	DA-15S	Y-6 15 Contact, pin connector, solder type	\$6.42
	CD9530	Y-7 9 Contact, socket connector, feedthru type	\$4.85
	516-056-402	Z-1 EDAC, 56 Pin, female panel mount, less contacts	\$12.21
	516-090-402	Z-2 EDAC, 90 Pin, female panel mount, less contacts	\$14.31
	8016-120-607	Z-4 Helix, 120 Contact, female panel mount, less contacts	\$25.34

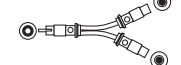
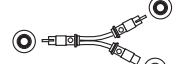
Bulk Parts

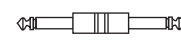
Pro Co Adapters

Pro Co "PC" Series Adapters		Model Number	Description	Sug. Resale
	330PJPC		Adapter, (2) RCA jacks to (1) 1/4" phone plug	\$2.99
	336APC		Adapter, Phone jack to RCA plug	\$2.57
	340PC		Adapter, (2) 1/4" phone jacks to (1) 1/4" mono plug	\$4.39
	341PC		Adapter, (2) stereo 3.5mm jacks to (1) 1/4" stereo plug	\$2.51
	342PC		Adapter, 1/4" stereo phone jack to stereo 3.5mm plug	\$2.15
	343PC		Adapter, stereo 3.5mm jack to 1/4" stereo phone plug	\$2.08
	344PC		Adapter, (2) stereo 1/4" phone jacks to (1) 1/4" stereo plug	\$1.99
	345APC		Adapter, RCA jack to 1/4" phone plug	\$1.66
	349APC		Coupler, RCA jack to RCA jack	\$2.29
	330F1PC		(2) RCA jacks to (1) RCA plug, 4" flexible cables	\$2.92
	330F2PC		Adapter, 1 RCA plug to 1 RCA jack and 1 RCA plug	\$2.64
	361APC		Coupler, 1/4" phone jack to 1/4" phone jack	\$3.69
	363PC		Coupler, 1/4" phone plug to 1/4" phone plug	\$1.99
	364APC		Adapter, 3.5mm jack to 1/4" phone plug	\$1.99

USB Panel Connectors		Model Number	Description	Sug. Resale
	ECJ504UA		USB A panel connector	\$20.99
	ECJ504UB		USB B panel connector	\$20.99
	ECJ504-UAB		USB A to B panel feedthru connector	\$20.99

Fiber Optic Panel Connectors		Model Number	Description	Sug. Resale
	502750-1		ST type	\$11.99
	504640-1		SC type	\$20.99

ConcertMASTER Connectors		Model Number	Description	Sug. Resale
CM54LF06			Line female with locking ring, 54 pins	\$135.10
CM150LF06			Line female with locking ring, 150 pins	\$152.20
CM201LF06			Line female with locking ring, 201 pins	\$215.00
CM54LM01			Line male without locking ring, 54 pins	\$137.52
CM150LM01			Line male without locking ring, 150 pins	\$155.78
CM201LM01			Line male without locking ring, 201 pins	\$190.00
CM54PF26			Panel female with locking ring, 54 pins	\$129.66
CM150PF26			Panel female with locking ring, 150 pins	\$133.66
CM201PF26			Panel female with locking ring, 201 pins	\$196.46
CM54PM02			Panel male without locking ring, 54 pins	\$58.34
CM150PM02			Panel male without locking ring, 150 pins	\$66.46
CM201PM02			Panel male without locking ring, 201 pins	\$100.66
CMC06-54			Metal protective cap for 06/26 versions, 54 pins	\$74.10
CMC06-85			Metal protective cap for 06/26 versions, 150 pins	\$92.20
CMC06-26-201			Metal protective cap for 06/26 versions, 201 pins	\$97.20
CMC01-02-54			Metal protective cap for 01/02 versions, 54 pins	\$50.82
CMC01-02-85			Metal protective cap for 01/02 versions, 150 pins	\$78.16
CMC01-02-201			Metal protective cap for 01/02 versions, 201 pins	\$78.16
GMC-16P-13			Male contacts for 54 pin version	\$1.42
GFC-16S-13			Female contacts for 54 pin version	\$2.40
GMC-18P			Male contacts for 150 pin version	\$1.12
GFC-18S			Female contacts for 150 pin version	\$2.34
GMC-20P			Male contacts for 201 pin version	\$1.16
GFC-20S			Female contacts for 201 pin version	\$2.36

Pro Co MASS Connectors		Model Number	Description	Sug. Resale
	CM176M		176-pin cable connector	\$598
	CM176P		176-pin panel connector	\$558

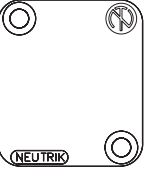
DBA and DBA/H		Model Number	Description	Sug. Resale
	DBA		Covers for Neutrik "D" style punchouts. DBA has no hole.	\$2.00
	DBA/H		Has a 3/8" hole to accommodate a 1/4" or RCA panel connector when required.	\$4.00