

Table of Contents

Taking a First Look	2
Intelligent Remote Control	2
Before You Start	4
Getting Started	6
Activating the Remote Control	6
Defining the Brands of Your Devices	7
Working with the Home Panel	13
Operating a Device	15
Adjusting the Settings	18
Getting the Maximum out of it	22
Introduction	22
Redefining Brands	24
Learning Commands	25
Labeling Elements	29
Adding and Moving	31
Deleting and Restoring	32
Recording Macros and Setting Timers	35
Using the Remote Control with Radio Frequency	39
ProntoPro Edit	44
Troubleshooting	46
General Problems	46
Programming Problems	47
Recharging Problems	48
FAQ	49
Maintaining the Remote Control	51
Important notices	51
Cleaning the Remote Control	51
Overview of Symbols	52
Specifications	55
Index	56

Taking a First Look

Intelligent Remote Control

The Intelligent Remote Control can be used for most devices that understand infrared (IR) remote control signals. Its easy-to-use touch screen with 256 colors and its intuitive interface makes it a perfect remote control for every user.

The Remote Control (RC) is completely customizable. In the memory of the Remote Control, RC codes are stored to activate different brands for all kinds of video and audio devices. The Remote Control is set up by default to operate with Philips or Marantz devices. When you have other brands, you simply define the brands of your devices when you use the Remote Control for the first time.

The Remote Control can also learn RC codes from existing remote controls. It is designed to add devices and functions, relabel buttons, record macros and set timers. With the ProntoPro Edit software you create your own control panels and define your personal look.

If you want to operate devices from a distance or from an adjacent room, you can use the Remote Control with radio frequency (RF) signals and an RF Extender.

The Appliance

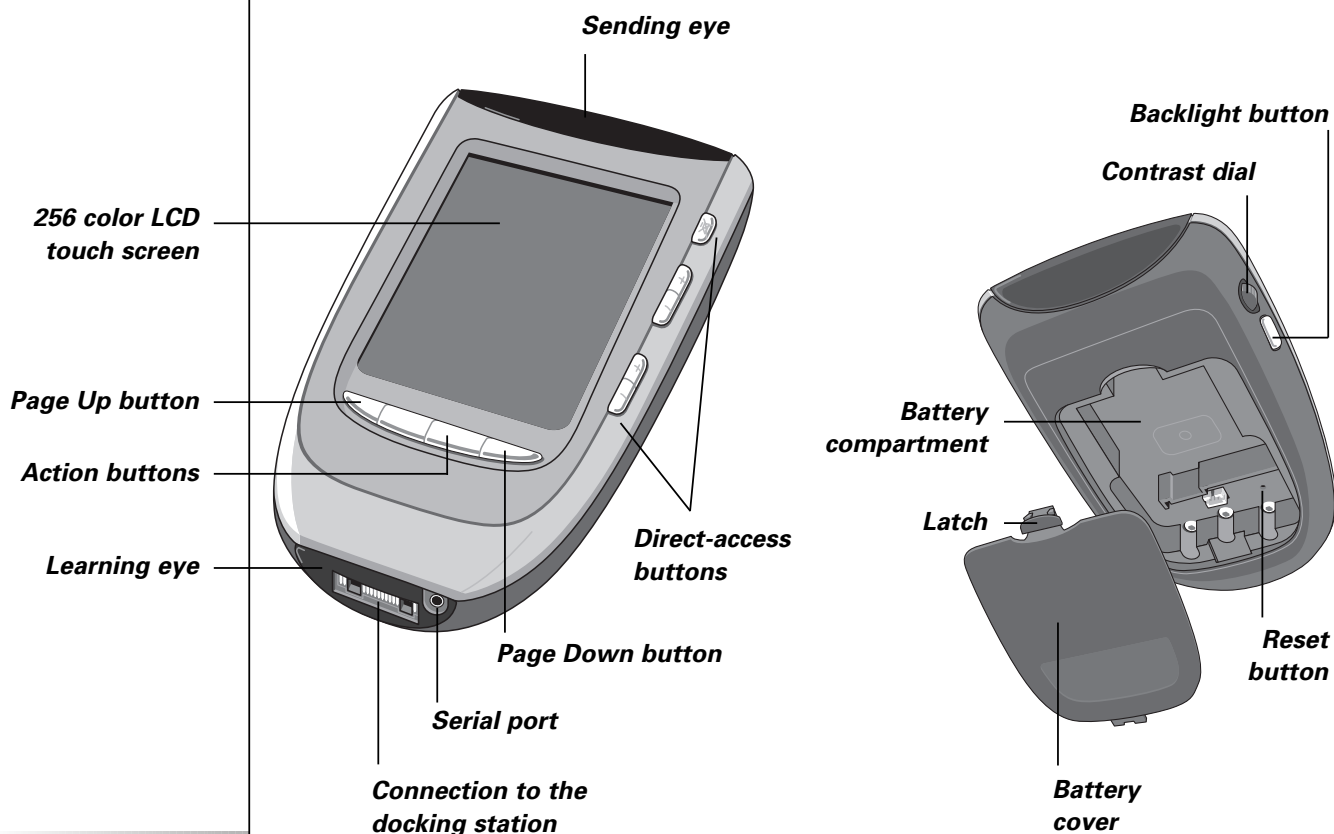

The Touch Screen

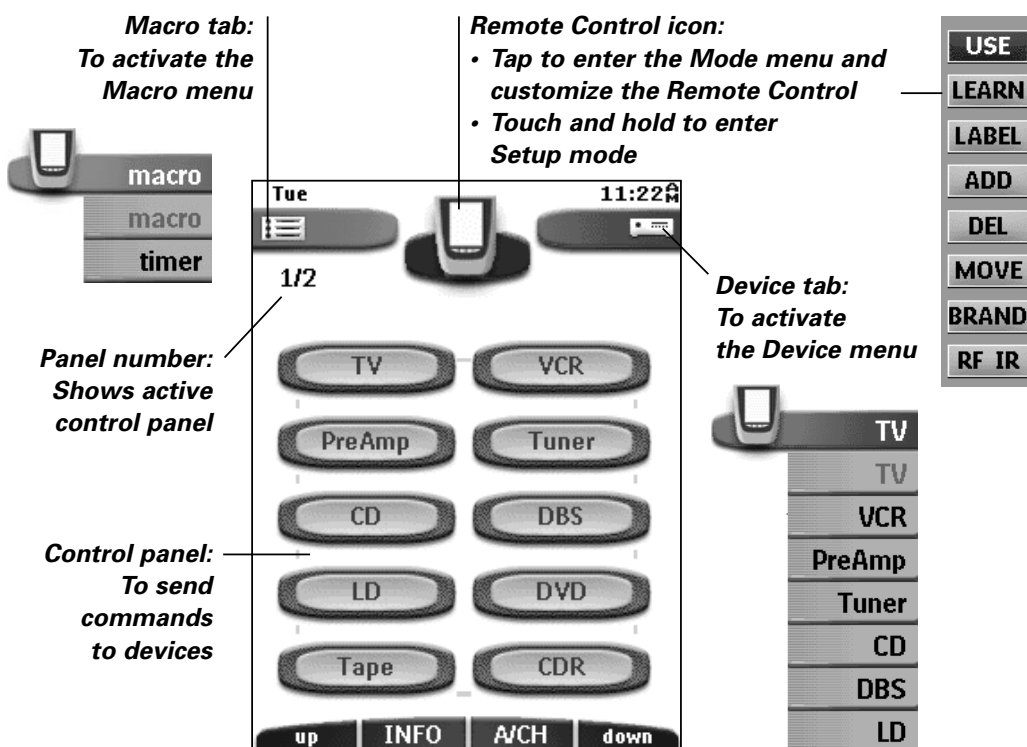

The Docking Station

The docking station is used:

- to charge the Remote Control;
- to connect your Remote Control to your computer.

The serial port on the docking station can be used as an alternative for the serial port on the Remote Control.

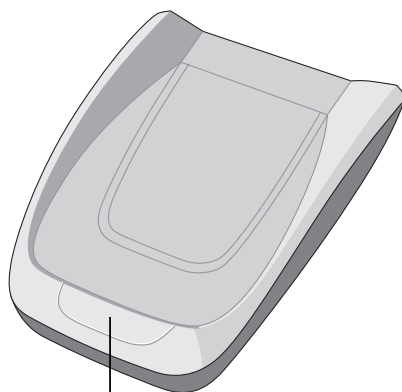

Charging LED

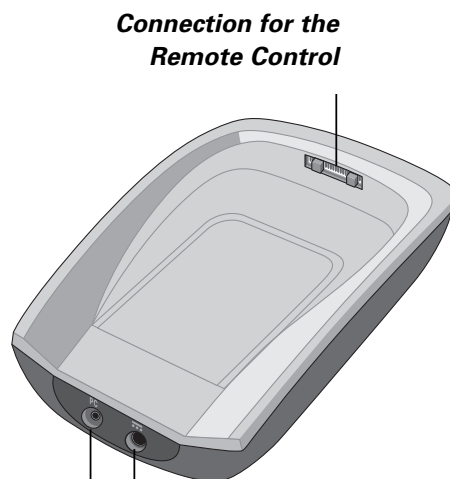

Serial port Adapter connector

Before You Start

When you use the Remote Control for the first time, you will have to:

- install the battery pack;
- place the Remote Control in the docking station and charge the Remote Control.

Warning Use the docking station only with the Philips **NiMH** rechargeable battery pack. We strongly advise you not to plug other appliances (like mobile phones, PDA's, ...) into the docking station. This causes damage to the connector and the appliance.

Installing the Battery Pack

- 1 Press the latch on the battery cover and remove the battery cover from the Remote Control.



- 2 Place the battery pack in the battery compartment.
- 3 Plug the cable of the battery pack in the connector as illustrated.

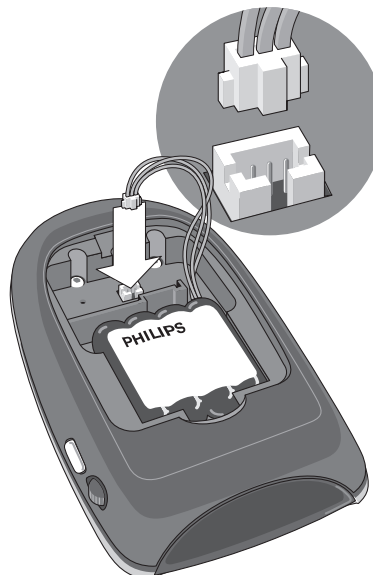

4 Place the battery cover back on.

Note Make sure the cable of the battery pack does not get stuck between the mould and the battery cover.

After a few seconds, the Remote Control starts up automatically and an Introduction screen appears. The Remote Control beeps twice to indicate that it has finished starting up.

Because the battery pack of the Remote Control is not fully pre-charged, you will have to charge it as described below.

Charging the Remote Control

For charging the Remote Control you use the docking station.

1 Plug the power adapter into a wall outlet and connect it to the docking station.

2 Place the Remote Control in the docking station.

Make sure you hold the Remote Control at an angle of 30° to 45° when you place it in the docking station.

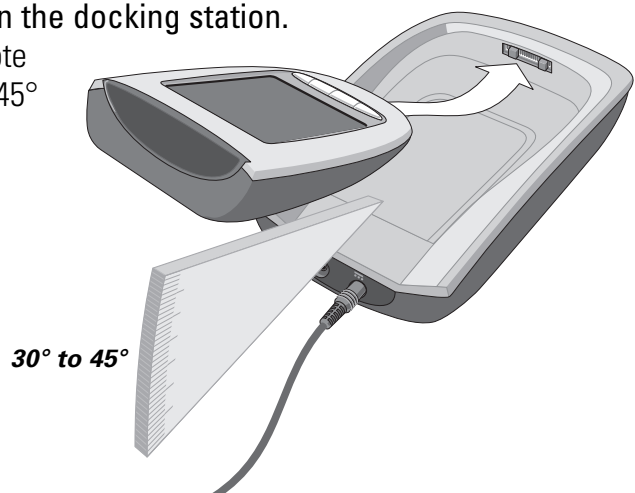

Charging starts immediately. The green charging LED on the front of the docking station indicates charging takes place. When the Remote Control is fully charged, the LED goes off.

Note Normal charging time is 2 to 3 hours, depending on the condition of the battery pack.

You can operate the Remote Control while it is being charged.

The battery pack does not have to be entirely empty before recharging.

You can place the Remote Control in the docking station at any time.

When the battery pack is running low, the Low Battery icon  flashes on the

Remote Control icon . Recharge the Remote Control as soon as possible to ensure perfect performance.

Note The Remote Control retains all settings when the battery pack has run out.

You will only have to set the clock. See "Adjusting the Settings" on page 18.

Activating the Remote Control

Turning on the Display and the Backlight

The Remote Control's display can be activated in three different ways:

- Tap the screen gently with your finger or a blunt, soft object like a pencil eraser.
The display is activated.
- Tilt the Remote Control more than 50 degrees as illustrated.
The display and the backlight of the direct-access buttons are activated.

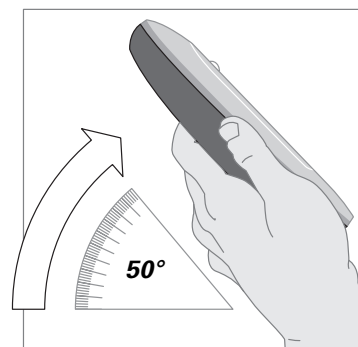

Note In the settings (p. 18) you can choose to deactivate the Pick Up sensor.

- Press the backlight button on the left side.
The display and the backlight of the direct-access buttons are activated.

When you turn on the display you see the Home panel. If another panel is displayed, tap the Home button .

Note If the screen stays black or becomes blank, adjust the contrast using the contrast dial on the left side.

The Remote Control has a switch-off feature: it automatically turns off to save power.

In the settings (p. 18) you can define the switch-off time for the touch screen.

Activating Modes

The Remote Control has different modes. In Use mode the Remote Control icon



is entirely visible. If a label (like **BRAND** or **LEARN**) covers the icon, see page 23 to switch your Remote Control to Use mode.

Defining the Brands of Your Devices

The Remote Control uses RC codes to activate devices. Because there are several brands using specific RC codes, you have to define the brands of your devices.

On the Home panel you find buttons for most common video and audio devices. When you select a device on the Home panel for the first time, you will notice that the Remote Control is set up by default to operate Philips or Marantz devices. For all devices other than Philips or Marantz, you will have to define the brand before you can operate them with the Remote Control.

- 1 Select a device on the Home panel.
The following screen appears.

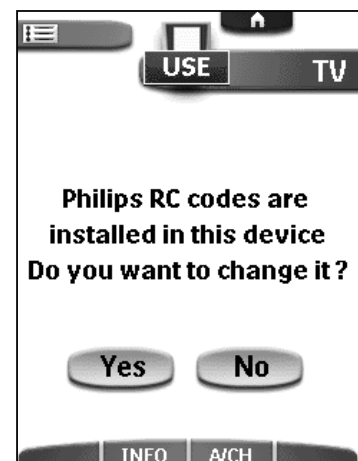

- 2 When the brand of your device is Philips or Marantz, click No.
The Remote Control switches to Use mode. To operate the device in Use mode, see p. 15.

-or-

When you want to adjust the Remote Control to operate with your brand, click Yes.

The Remote Control switches to Brand mode. Follow the instructions as described below.

There are three possible scenarios for defining brands:

- You can **select the brand and the code set** of your device.
- You can **select the brand** of your device and **search the code set**.
- You can **search the brand** of your device.

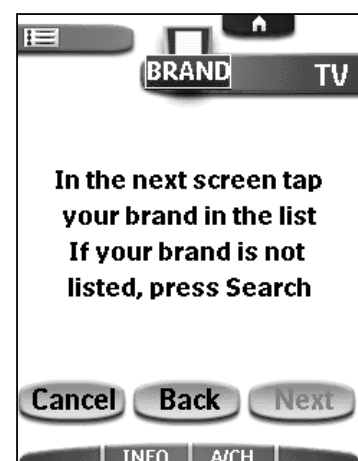

Selecting Brands and Code Sets

A list of brands and their corresponding RC codes are stored in the Remote Control's memory.

You have to select your brand from the list. Because not every device of a certain brand uses the same RC codes, you might also have to select a set of RC codes for your brand.

1 Tap Next.

A scrollable list of brands for the selected device and a "virtual auto-zooming" mini-keyboard appears.

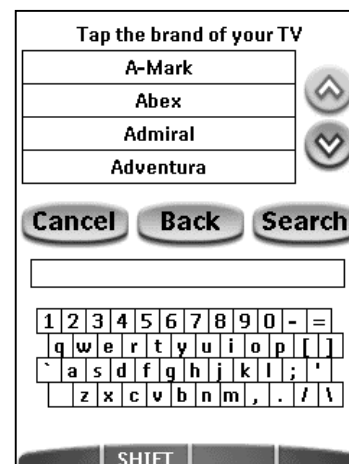

2 Navigate through the list of brands using the **scroll buttons** and to scroll up or down in the list of brands.

- By tapping the scroll buttons, you scroll through the brands one by one.
- By holding down the scroll buttons, the scrolling speed increases.

-or-

Navigate through the list of brands using the **mini-keyboard** to jump through the list of brands.

- To enter a character, tap the keyboard near the character you want to use. The keyboard is zoomed in, allowing you to tap exactly the character you need.

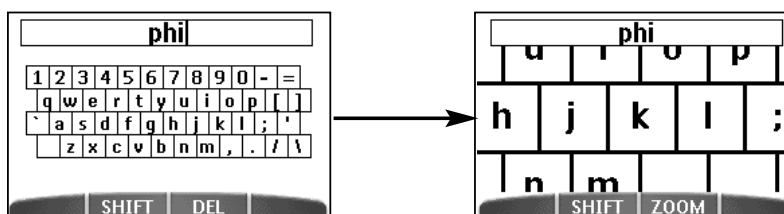

After you have tapped the character, the keyboard is zoomed out. Repeat this action for every character.

Note You can zoom out again without tapping a character by pressing the right action button (labeled Zoom).

- To delete a character, press the right action button (labeled *Del*).
- To enter a space, tap the lower left corner of the keyboard. When the keyboard is zoomed in, tap the empty key.

Every time you enter a character the list displays the brands that match the character(s). The Remote Control makes a pre-selection of the (first) matching brand. You only have to type as many characters as needed to display your brand.

Note When your brand is not displayed in the list of brands, you can use Search mode. See "Searching Brands and Code Sets" on p. 12.

3 Select your brand in the list.

The selected brand is highlighted.

The Search button switches into Next.

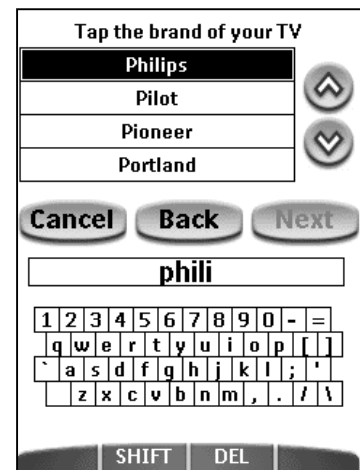

4 Tap Next.

When your brand uses only one set of RC codes, the Remote Control switches to Try mode. Continue with step 5.

When there are several code sets for your brand, a list of code sets for the selected brand appears.

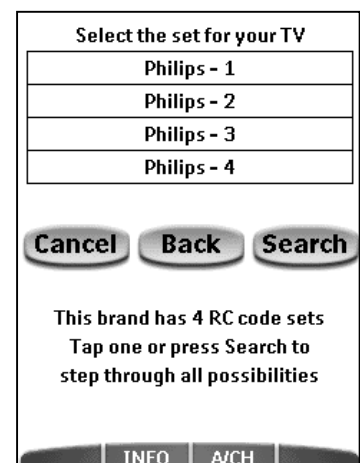

Getting Started

You can **select the code set** for your device:

Note The RC code sets are ranked. The first code set in the list is used for most devices of the selected brand.

- 1 **Select a code set from the list.**
The selected code set is highlighted.
The Search button switches to Next.

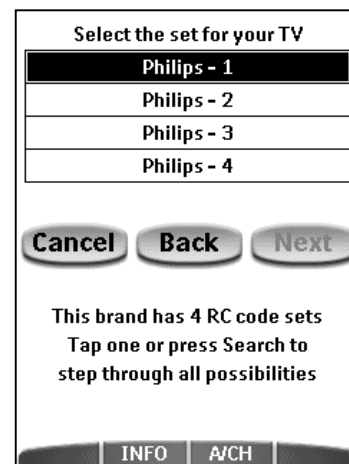

- 2 **Tap Next.**
The Remote Control switches to Try mode. Continue with step 5.

-or-

When you do not know which code set to select for your device, you can **search the code set** in Remote Control's memory:

- 1 **Tap Search.**
The Remote Control automatically searches through all available RC code sets to find the matching codes for your device.
- 2 **Tap Next to start sending appropriate commands for the selected device.**
The progress bar indicates how many of the available code sets have been tried out.

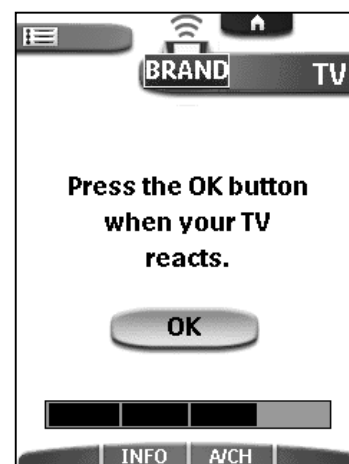

3 Tap OK when the device reacts.

The Remote Control switches to Try mode. Continue with step 5.

Note The name of the responding code set is displayed when you tap the OK button, so you know which code set to select from the list after you have tried out other code sets.



5 Tap Next.

The first control panel of selected device is displayed.

6 Try out the buttons on the different control panels and check if the device is responding to the RC codes the Remote Control is sending.

Note Even when the device is responding to the current code set, it is advised to try out other code sets. When your device responds to more than one code set, install the most suitable one.

7 When you are satisfied with the way the device is responding to the selected code set, tap Install.

-or-

When you are not satisfied with the selected code set, tap Back to select another code set.

When the RC codes for your device are installed, the Remote Control beeps and returns to Use mode. Your brand is now defined for the selected device.

8 Define all other devices on the Home panel you want to operate.

Getting Started

Searching Brands and Code Sets

When the brand of your device is not listed, the Remote Control can search through all available brands and code sets in its memory to find the matching code set for your device.

1 Tap Next.

The display shows a scrollable list of brands for the selected device and a “virtual auto-zooming” mini-keyboard.

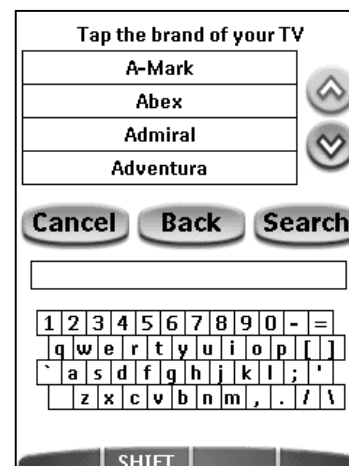

2 Tap Search.

The Remote Control automatically searches through all available brands and RC code sets to find the matching codes for your device.

3 Tap Next to start sending appropriate commands for the selected device.

The progress bar indicates how many of the available code sets have been tried out.

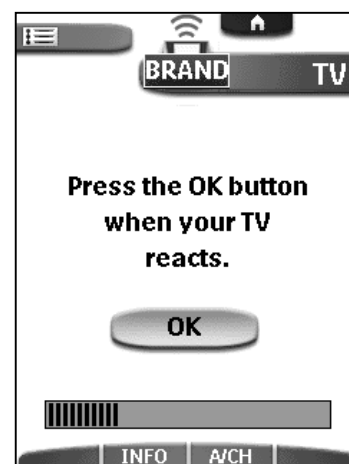

4 Tap OK when the device reacts.

The Remote Control switches to Try mode.



5 Tap Next.

The first control panel of selected device is displayed.

6 Try out the buttons on the different control panels and check if the device is responding to the RC codes the Remote Control is sending.

Note Even when the device is responding to the current code set, it is advised to try out other code sets. When your device responds to more than one code set, install the most suitable one.

7 When you are satisfied with the way the device is responding to the selected code set, tap Install.

-or-

When you are not satisfied with the selected code set, tap Back to continue the automatic search.

When the RC codes for your device are installed, the Remote Control beeps and returns to Use mode. Your brand is now defined for the selected device.

8 Define all other devices on the Home panel you want to operate.

Working with the Home Panel

On the Home panel you find buttons to activate the Device menu or the Macro menu and to select devices.

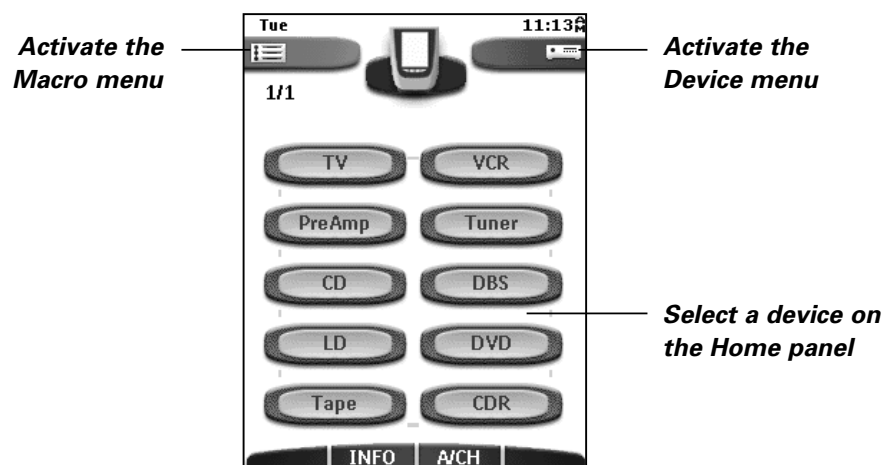

Note You can customize the Home panel by adding (see p. 31) or deleting devices (see p. 33).

Activating the Device Menu

Tap the Device tab icon  on the Home panel.

The Device menu is activated. The dynamic interface displays the Device menu on the right side of the touch screen.

Macro tab icon:
To activate the
Macro menu

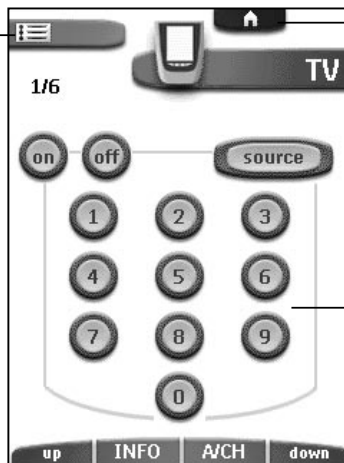

Home button:
To navigate to
the Home panel

Device control panel:
To operate the device

Go to page 15 and the following to learn how to work with the different devices.

Activating the Macro Menu

Tap the Macro tab icon  on the Home panel.

The Macro menu is activated. The dynamic interface displays the Macro menu on the right side of the touch screen.

Device tab icon:
To activate the
Device menu

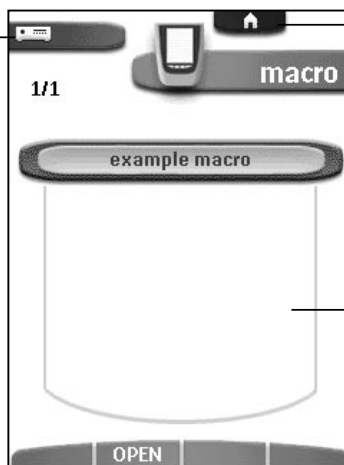

Home button:
To navigate to
the Home panel

Macro control panel:
To operate macros
and timers

Go to page 35 and the following to learn about macros and timers.

Selecting a Device on the Home Panel

- Tap one of the device you want to operate on the Home panel. The first control panel of the selected device appears.

Operating a Device

You select the device you want to operate via the Device menu.

You operate devices using four kinds of buttons:

- Touch screen buttons;
- Action buttons (below the touch screen);
- Page Up and Page Down buttons (below the touch screen);
- Direct-access buttons (to the right of the touch screen).

Selecting a Device via the Device menu

The Device menu allows you to easily switch to another device without having to return to the Home panel.

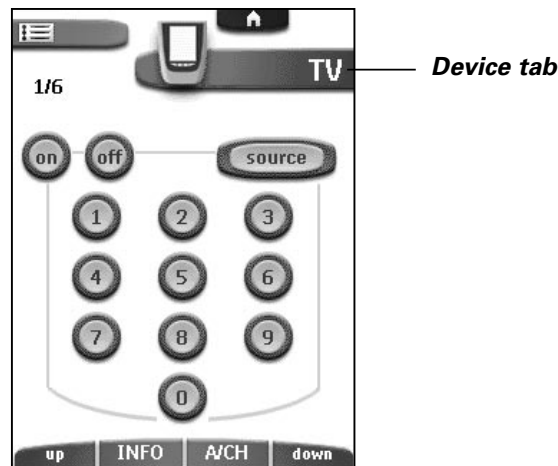

- 1 From within any device control panel, tap the Device tab  next to the Remote Control icon.

The Device menu appears. You can scroll through this menu using the Page Up and Page Down buttons below the touch screen.

Getting Started

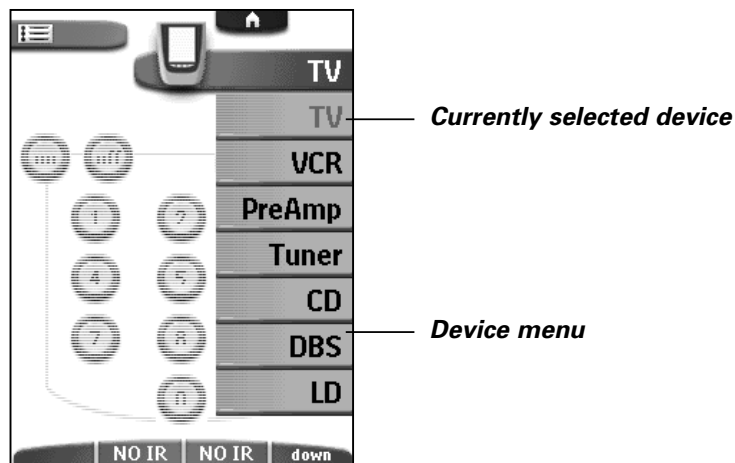

- 2 In the Device menu, tap the device you want to operate.
The control panel that was last accessed for this device appears.

Using Touch Screen Buttons

Sending commands

By tapping the touch screen buttons you send commands to the device you have selected. When you send a command, the Remote Control icon shows

transmitting signals .

The name of the active device is indicated on the Device tab.

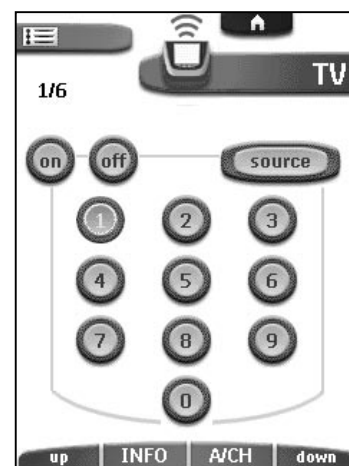

Selecting a device without affecting other devices

When you select a device that is programmed with a device action (see p. 27), the following happens:

- the Remote Control sends commands to the selected device to execute the device action;
- the control panel of the selected device is displayed.

Sometimes, sending device action commands can cause unwanted behavior of other devices.

Example

You have defined a device action for the VCR: when you select the VCR, the TV switches to channel number 10.

Now you want to keep watching channel 2 on the TV when you switch to the VCR for rewinding a tape.

To display the control panel of the selected device without sending device action commands, follow this procedure:

1 Tap the Device tab  next to the Remote Control icon to open the Device menu.

2 Press and hold one of the action buttons (labeled *NO IR*).

The Remote Control icon turns around , indicating that it will not send IR codes to the selected device so that none of your devices will be affected.

3 Tap the device you want to select.

The control panel of the new selected device appears and the Remote Control icon turns to its original position . You can now operate the new selected device without affecting the previously active device.

Using the Action Buttons

The action buttons change function depending on the device the Remote Control is operating. The current function is displayed on the touch screen right above the button. The function can either be an IR (infrared) command which is transmitted, system commands or a jump to a specific device page.

IR commands

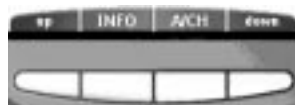

System commands

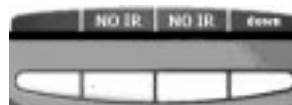

Using the Page Up and Page Down Buttons

Most devices have more than one control panel. You can scroll through these control panels using the Page Up and Page Down buttons below the touch screen. The panel number on the left of the touch screen indicates the active panel number and the total number of panels, for example 1/6.

When there are more items in the Device menu or the Macro menu than can be displayed, you can scroll through the menu with the Page Up and Page Down buttons.

The color of the action buttons and the Page Up/Page Down buttons indicates in which menu or panel you are working.

Note The Page Up and Page Down buttons are only displayed when necessary. If all items in the menu are displayed or if a device only has one panel, the buttons are inactive.
By holding down one of the scroll buttons, you go repeatedly through the control panels of a device in a loop.

Using the Direct-access Buttons

Mute, Channel and Volume can be operated at any time, even without turning on the touch screen.

Adjusting the Settings

Most of the Remote Control's features can be set to your own wishes.

- 1** Touch and hold the Remote Control icon for three seconds.
The Remote Control switches to Setup mode. The first setup panel appears.
- 2** Tap the button of the setting you want to adjust.
The button is activated.
- 3** Tap the button repeatedly to toggle between the different options for the selected setting.
-or-
Use the action buttons to adjust the setting.
- 4** Use the Page Up and Page Down buttons to display the second and third setup panel.

First setup panel

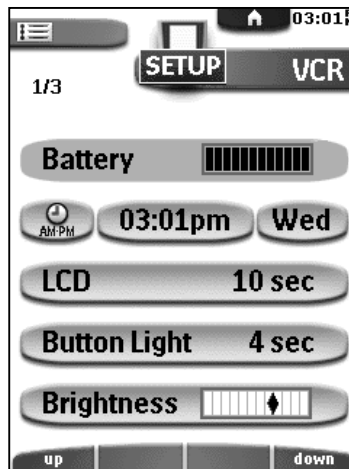

Setting	Function	Adjusting
	Shows the battery level.	
	Turns the clock display on or off and lets you set 12 or 24h time display.	Tap the clock repeatedly.
	Sets the clock.	Tap the time button and use the action buttons .
	Sets the day.	Tap the day button and use the action buttons .
	Sets how long the touch screen and the backlight of the touch screen stay on.	Tap the LCD button and use the action buttons .
	Sets how long the backlight of the buttons stays on.	Tap the Button Light button and use the action buttons .
	Adjusts the brightness of the touch screen in 4 levels. Level 3 is the default brightness level.	Tap the Brightness button and use the action buttons .

Note When you set the brightness level **above** the default level (3), battery life time will be reduced.
When you set the brightness level **below** the default level (3), battery life time will be prolonged.

Second setup panel

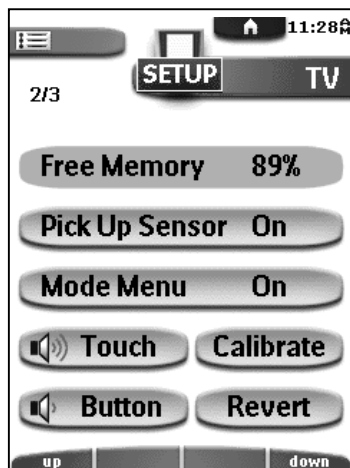

Setting	Function	Adjusting
Free Memory 89%	Indicates the amount of free memory that is available.	
Pick Up Sensor On	Turns on or off the option to activate the Remote Control by picking it up.	Tap the Pick Up Sensor button.
Mode Menu On	Hides or shows the Mode menu, activated with the Remote Control icon.	Tap the Mode Menu button.
Touch	Adjusts or turns off the touch screen beep.	Tap the Touch button repeatedly.
Button	Adjusts or turns off the button beep.	Tap the Button button repeatedly.
Calibrate	Calibrates the touch screen.	Tap the Calibrate button and follow the on-screen instructions.
Revert	Reverts the Remote Control to the factory default configuration.	Tap the Revert button and follow the on-screen instructions.

Note Activating the Pick Up sensor will turn on the Remote Control more often and will reduce the battery life time.

Third setup panel



This panel provides two buttons:

- Show Intro: to view the Intro animation;
- Specs: to display technical information about your Remote Control.

To exit Setup Mode

- Tap the Remote Control icon . The Remote Control switches to Use mode.

Note When you tap the Device tab, the Macro tab or the Home button from within the Setup panel, you exit Setup Mode and the Remote Control immediately switches to the selected menu or to the Home panel.

Getting the Maximum out of it

Introduction

What makes the Remote Control so powerful is the ability to extend its functionality in multiple ways like programming additional functions, adding supplementary devices, recording macros and changing the interface as it suits you best.

The Remote Control provides different modes. When you operate your devices, the Remote Control is in Use mode. For customizing the Remote Control (like learning buttons, recording macro's, adding devices, and so on) you have to switch to the appropriate mode.

Working with Modes

USE

For operating devices.

LEARN

For learning commands from other devices.

EDIT

For recording macros and setting timers.

LABEL

For labeling buttons and commands.

ADD

For adding new devices.and macros.

DEL

For deleting buttons, actions, devices and macros.

MOVE

For changing the order in a menu.

BRAND

For defining brands using the Remote Control's database.

RF IR

For configuring the Remote Control to operate devices with RF or IR signals.

Getting the Maximum out of it

Switching to another mode

- 1 Tap the Remote Control icon  at the top of the touch screen. The Mode menu appears.

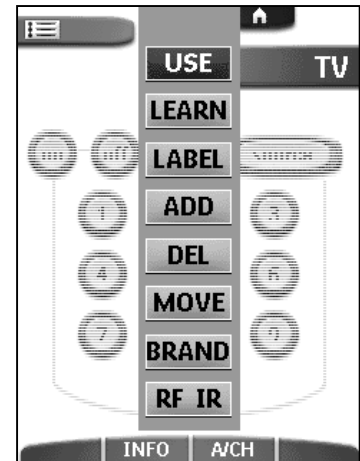

- 2 Tap the mode you want to use. The label of the active mode appears on the Remote Control icon . You can now work in the selected mode.

Disabling the Mode menu

To prevent accidental changes to the Remote Control interface and commands, you can disable the Mode menu.

- 1 Make sure the Remote Control is in Use mode.
- 2 Touch and hold the Remote Control icon for a few seconds. The Remote Control switches to Setup mode.
- 3 Scroll down to the second setup panel.
- 4 Tap the Mode Menu button. The label on the Mode Menu button changes to "Mode Menu Off".
- 5 Tap the Remote Control icon . The Remote Control switches to Use mode.

Note When you tap the Device tab or the Macro tab from within the Setup panel, you exit Setup Mode and the Remote Control immediately switches to the selected menu.

There is no visual feedback to indicate that the Mode menu is disabled. This means that the Mode menu will not appear when you tap the Remote Control icon. To enable the Mode menu again, return to Setup mode and turn the Mode Menu button back on.

Redefining Brands

If you replace an existing device with a new one, you might have to redefine the brand of the device. You can redefine brands by selecting or by searching.

- 1 Switch to Brand mode via the

Remote Control icon .
The Device menu appears.

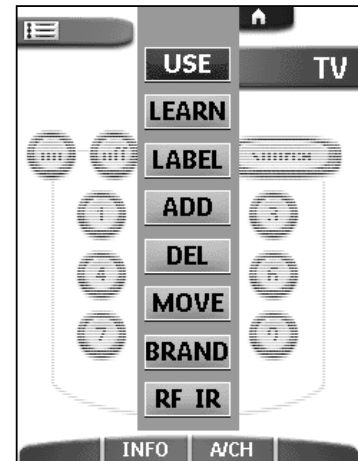

- 2 Select the device for which you want to redefine the brand.
- 3 Complete instructions 1 to 7 in "Selecting Brands and Code Sets" on page 8.

-or-

Complete instructions 1 to 7 in "Searching Brands and Code Sets" on page 12.

Learning Commands

You can program the Remote Control commands by transmitting infrared signals from your existing remote controls to the Remote Control's learning eye. To do this, place the Remote Control and the device's remote control on a flat surface, 100 to 200 mm (4 to 8 inches) apart.

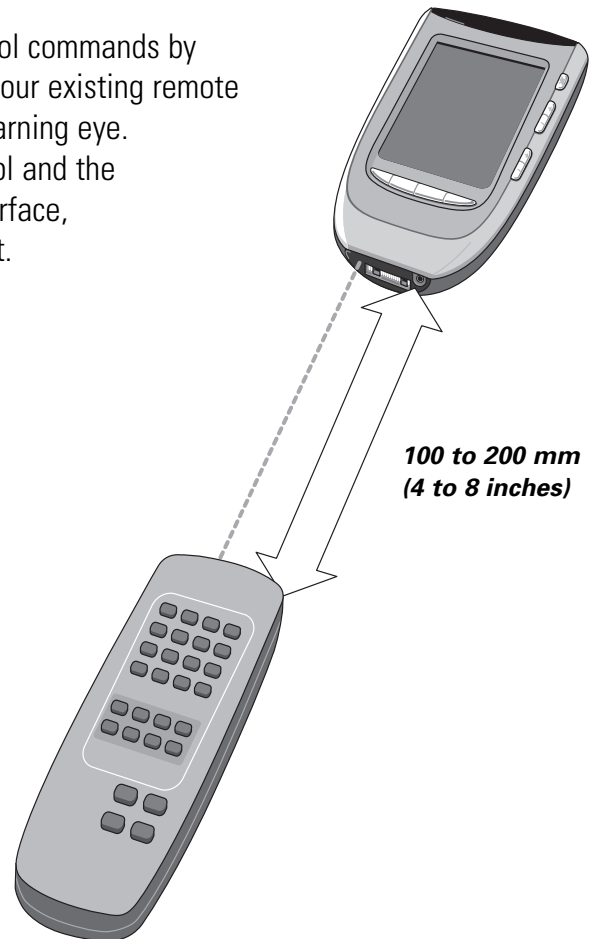

The following buttons can be programmed:

- control panel buttons;
- device actions;
- direct-access buttons and action buttons.

You cannot program the Page Up/Page Down buttons on the Remote Control directly. You have to program them via ProntoPro Edit.

You cannot program Home panel buttons directly. You have to program them via the Device menu (see p. 27).

The Remote Control also offers empty control panel buttons which you can program and label as existing buttons. They are only visible in Learn and Label mode and appear with label (intended for a specific function) or without label. You will also see previously deleted buttons: you can restore them by reprogramming them or you can reuse them for other commands.

Getting the Maximum out of it

Learning Control Panel Buttons

- 1 Navigate to the control panel button you want to program.
- 2 Switch to Learn mode via the Remote Control icon . Additional empty buttons and previously deleted buttons appear.
- 3 Point the device's original remote control to the Remote Control's learning eye as shown above.
- 4 Tap the Remote Control button you want to program.

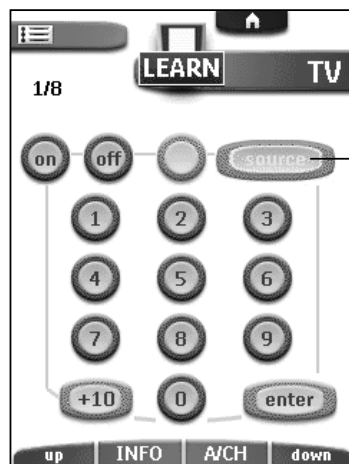

The button starts flashing

- 5 Press and hold the corresponding button on your device's original remote control.
If the Remote Control has learned the command successfully, OK flashes on the Remote Control icon.
If the Remote Control has not learned the command successfully, you hear a short buzz and FAIL appears on the Remote Control icon.
- 6 Program all other buttons you want and relabel them if necessary (see p. 29).
- 7 Return to Use mode via the Remote Control icon.

Learning Device Actions

A device action is a command that is assigned to a Device button on the Home panel or a device in the Device menu. The action is executed every time you select the device.

Note When you program a device action, RC codes are sent the moment you select the device. This might affect the operation of the active device. For selecting a device without sending RC codes and without affecting the active device, see page 16.

1 Make sure the Device tab is active.

The Device tab is active when the name of a device is displayed at the right side of the touch screen .

2 Switch to Learn mode via the Remote Control icon .

3 Point the device's original remote control to the Remote Control's learning eye as described above.

4 Tap the Device tab to open the Device menu.

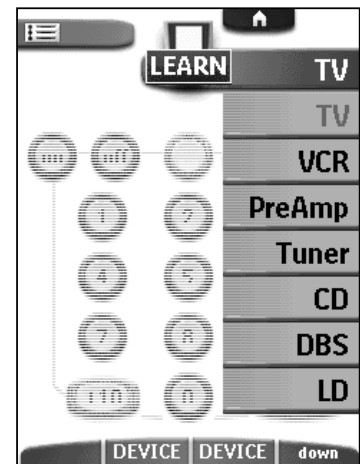

5 Touch and hold either the Remote Control's left or right action button (both labeled *Device*) and tap the device you want to program.

Even when you want to program a device action for the currently active device, you have to tap it in the Device menu.

The label *Device* starts flashing on the Remote Control icon.

6 Press and hold the button the Remote Control has to learn as device action on your device's original remote control.

The command for the device action is assigned to the Device button on the Home panel and in the Device menu.

If the Remote Control has learned the command successfully, OK flashes on the display.

If the Remote Control has not learned the command successfully, you hear a short buzz and FAIL appears on the Remote Control icon.

7 Program all other device actions you want and return to Use mode via the Remote Control icon.

Learning Direct-access and Action Buttons

Direct-access and action buttons can be programmed with a global function or with functions per device.

- Buttons with functions per device execute commands depending on the active device. For example, the left action button is the Play command when the VCR is active.
- Buttons with global functions always execute the same command, no matter what device is active.

Note Per device functions overrule global functions. For example, when you program the Volume buttons globally, but you assign a specific function to them with the tuner, the specific command will be executed when the tuner is the active device.

Learning a button per device

- 1 Switch to the device for which you want to program the button.
- 2 Complete instructions 2 to 7 in “Learning Control Panel Buttons” on page 26. Instead of tapping a button on the touch screen, press the direct-access button or the action button you want to program.
The label for the **direct-access button** you have pressed (e.g. *chan +*) starts flashing on the Remote Control icon.
The label above the **action button** you have pressed (e.g. *play*) starts flashing.

Learning a button globally

- 1 Tap the Home button .
- 2 Complete instructions 2 to 7 in “Learning Control Panel Buttons” on page 26. Instead of tapping a button on the touch screen, press the direct-access button or the action button you want to program.
The label for the **direct-access button** you have pressed (e.g. *chan +*) starts flashing on the Remote Control icon.
The label above the **action button** you have pressed (e.g. *play*) starts flashing.

Labeling Elements

The following elements can be labeled:

- control panel buttons, action buttons, macros and timers;
- devices, macro groups and timer groups.

Labeling Control Panel Buttons, Action Buttons, Macros and Timers

Note You cannot label Home panel buttons directly. You have to label them via the Device menu (see p. 30).

1 Navigate to the panel containing the button you want to label.

2 Switch to Label mode via the Remote Control icon .

3 Tap the button you want to label.

The display shows a “virtual auto-zooming” mini-keyboard. The button you want to label is displayed above the keyboard.

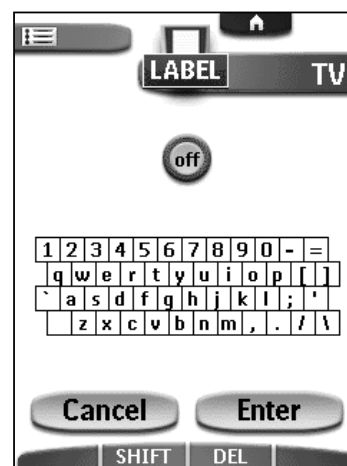

4 Edit the label.

- To delete a character, press the right action button (labeled *Del*).
- To display a keyboard with capital letters and symbols, press the left action button (labeled *Shift*) repeatedly.
- To enter a character or symbol, tap the keyboard near the character or symbol you want to use.
The keyboard is zoomed in, allowing you to tap exactly the character or symbol you need.

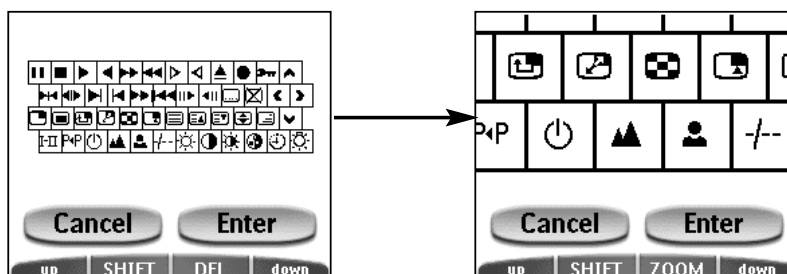

Getting the Maximum out of it

After you have tapped the character or symbol, the keyboard is zoomed out. Repeat this action for every character.

Note You can zoom out again without tapping a character or symbol by pressing the right action button (labeled Zoom).

- To enter a space, tap the lower left corner of the keyboard. When the keyboard is zoomed in, tap the empty key.

5 Tap Enter to save the changes and return to the panel you were.

-or-

Tap Cancel to return to the panel you were without saving changes.

6 Label all other elements you want and return to Use mode via the Remote Control icon.

Labeling Devices, Macro Groups and Timer Groups

1 Switch to Label mode via the Remote Control icon .

2 Tap the Device tab  to open the Device menu.

Touch and hold either the Remote Control's left or right action button (labeled *Device*) and tap the device you want to label.

Even when you want to label the currently active device, you have to tap it in the Device menu.

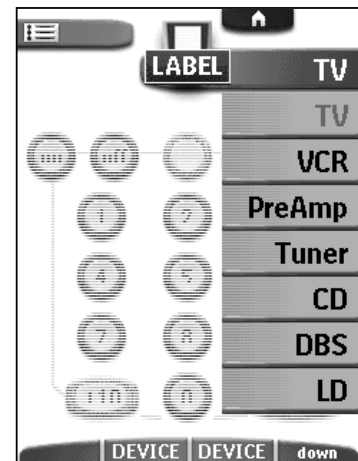

The display shows a “virtual auto-zooming” mini-keyboard. The button you want to label is displayed above the keyboard.

3 Complete instructions 4 to 6 in “Labeling Control Panel Buttons, Action Buttons, Macros and Timers” on page 29.

Adding and Moving

Adding Devices

If you have a device that is not provided in the Device menu, you can add it to the Remote Control.

You cannot add devices to the Home panel directly. You have to add them via the Device menu.

1 Make sure the Device tab is active.

The Device tab is active when the name of a device is displayed at the right side of the touch screen .

2 Switch to Add mode via the Remote Control icon .

The Remote Control displays the following choices:

- Create New Device: Choose this option to add a completely new device.
- Copy Existing Device: Choose this option to copy a device already provided in the Device menu (for example for a second television).
- Restore Deleted Device: Use this option to restore a device you have deleted.

3 Tap the device you want to add in the Device menu.

Note If the device you want to add is not provided, choose a similar one. You can customize it later.

The Remote Control gives you the possibility to add the new device with or without RC codes.

- Create with RC codes: Choose this option if you think the new device understands RC codes. The new device is added with operational buttons.
- Don't add RC codes: If you choose this option, the new device is added without operational buttons. You have to program them as explained in "Learning Control Panel Buttons" on page 26. You cannot define the device in Brand mode, because there are no RC codes available.

4 Tap the button of your choice.

The new device is automatically displayed in Use mode.

Moving Devices, Macro Groups or Timer Groups

You can change the order in the Device menu and the Macro menu. Changes you make in the Device menu are automatically updated on the Home panel.

1 Make sure the Device tab or Macro tab is active.

The Device tab or Macro tab is active when the name of a device, macro or timer is displayed at the right side of the touch screen.

Getting the Maximum out of it

- 2 Switch to Move mode via the Remote Control icon .
The Remote Control displays the Device menu or the Macro menu.
- 3 Tap the device or group you want to move.
The menu item is highlighted.
- 4 Use the action buttons to move the menu item up or down.
- 5 Tap Accept to save the changes.
You return to Use mode.

Deleting and Restoring

Deleting

You can delete the following elements:

- control panel buttons and actions associated with a direct-access or an action button;
- device actions;
- devices, macro groups and timer groups.

Home panel buttons cannot be deleted directly. You have to delete them via the Device menu (see p. 33).

Note Buttons that are programmed in Learn mode and deleted afterwards, will disappear from the control panel. When you redefine the device in Brand mode, those buttons will stay empty. You will have to reprogram them in Learn mode.

Deleting buttons or button actions

Note Touch screen labels cannot be deleted. You can only hide them by removing their label text: . (see "Labeling Elements" on page 29)

- 1 Switch to Delete mode via the Remote Control icon .
- 2 Tap the button you want to delete.
- 3 Tap Delete Button Action.
The result depends on the element you are deleting:
 - Control panel button: The button disappears from the display.
 - Action button command: The corresponding label disappears from the display.
 - Direct-access button: The button becomes inactive.

- 4 Delete all the buttons and button actions you want and return to Use mode via the Remote Control icon.

Deleting device actions

- 1 Switch to Delete mode via the Remote Control icon .
- 2 Tap the Device tab to open the Device menu.
When you open the Device menu, the left action button label changes into *Device* and the right action button label changes into *Action*.
- 3 Press and hold down the right action button (labeled *Action*).
- 4 Tap the device associated with the device action you want to delete.
- 5 Tap Delete Device Action.
The device action is deleted.
- 6 Delete all the device actions you want and return to Use mode via the Remote Control icon.

Deleting devices, macro groups or timer groups

- 1 Switch to Delete mode via the Remote Control icon .
- 2 Navigate to the device or group you want to delete.
If you have opened the Device menu, the left action button label changes into *Device* and the right action button label into *Action*.
If you have opened the Macro menu, the action button labels change into *Group*.
- 3 Press and hold down the left or right action button depending on what you are deleting:
 - left action button labeled *Device*: For deleting a device in the Device menu.
 - left or right action button labeled *Group*: For deleting a macro group or a timer group in the Macro menu.
- 4 Tap the device or group you want to delete.
- 5 Tap Delete Device, Delete Macro Group or Delete Timer Group.
The Device (and its associated Home panel button), the Macro Group (including its macros) or the Timer Group (including its settings) is deleted.
- 6 Delete all the devices, macro groups and timer groups you want and return to Use mode via the Remote Control icon.

Getting the Maximum out of it

Restoring

When you have deleted elements, they are no longer visible in Use mode but remain in the Remote Control's memory. This allows you to restore them.

- When you have deleted a button or a device action you can restore it in Learn mode.
- When you have deleted a device, a macro group or a timer group you can restore it in Add mode.

Actions associated with direct-access or action buttons cannot be restored. You have to reprogram them as explained in "Learning Direct-access and Action Buttons" on page 28.

Restoring buttons and button actions

- 1 Switch to Learn mode via the Remote Control icon .
The empty buttons become visible.
- 2 Complete instructions 3 to 7 in "Learning Control Panel Buttons" on page 26.
The button is restored.

Restoring device actions

- 1 Switch to Learn mode via the Remote Control icon .
- 2 Complete instructions 3 to 7 in "Learning Device Actions" on page 27.
The device item is restored.

Restoring devices, macro groups or timer groups

- 1 Make sure the Device tab or Macro tab is active.
The Device or Macro tab is active when the name of a device, macro or timer is displayed at the right side of the touch screen.
- 2 Switch to Add mode via the Remote Control icon .
- 3 Tap Restore Deleted Device or Restore Deleted Group.
The deleted devices, macro groups or timer groups become visible.
- 4 Tap the item you want to restore.
The item is restored and you return to Use mode.



Note Only the macro group or timer group itself is restored, not the macros or timers it contained. You will have to record the macros and set the timers again in Edit mode.

Recording Macros and Setting Timers

A macro allows you to send a sequence of IR commands using one single button. With a timer you can activate a device at the time you prefer. See page 37 to do this.

Note To record a macro or to set a timer, there must be at least one macro group or timer group in the Macro menu. To create these groups, see page 38.

Recording Macros

- 1 Tap the Macro tab icon  at the left side of the touch screen. The Device tab and the Macro tab change places. The Macro tab is active when the name of a macro is displayed at the right side of the touch screen.
- 2 Tap the Macro tab  next to the Remote Control icon. The Macro menu appears. You can scroll through this menu using the Page Up and Page Down buttons below the touch screen.
- 3 In the Macro menu select a macro group.

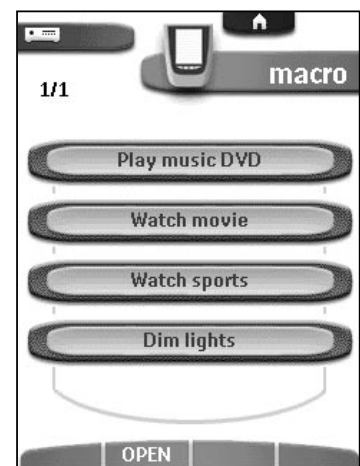

- 4 Switch to Edit mode via the Remote Control icon . Empty macro buttons appear in the macro control panel.
- 5 Tap the button you want to use for your macro.
- 6 Enter the sequence of commands you want to record. You can navigate to whatever control panel you want, just as you do in Use mode.

Getting the Maximum out of it

- 7 Tap the Macro tab icon again.
The contents of the macro appear. You can now play, edit or close the macro.
- 8 Press the left action button (labeled *Close*) to close the macro.
A confirmation screen appears where you can save or cancel the macro.
- 9 Tap Save and assign a label to the macro.
You return to Use mode and the macro is ready to be used.

There are two extra commands you can record in a macro:

Source switching

To record a device action containing a source switching command, open the Device menu, hold down the right action button (labeled *Action*) and tap the device you want to switch to.

Ending with a device control panel

To end a macro with displaying a device, open the Device menu, hold down the left action button (labeled *Device*) and tap the device you want.

Editing Macros





You can edit any macro you have recorded.

- 1 Open the macro group that contains the macro.
- 2 Switch to Edit mode via the Remote Control icon .
- 3 Tap the macro you want to edit.
The contents of the macro appear.





- 4 Edit the macro.
You can move or delete listed commands or you can record new commands.
You can also add **delays** to the macro (for example, to insert a short pause between turning on a device and sending commands to it allowing the device to warm up):

Getting the Maximum out of it

- 1 Tap Delay.
- 2 Tap  or  to decrease or increase the length of the delay.
- 3 Use the arrow buttons  and  to move the delay to the right place.
- 5 Press the left action button (labeled *Close*) to close the macro.
A confirmation screen appears where you can save or cancel the macro.
- 6 Tap Save.
You return to Use mode and the macro is ready to be used.

Setting Timers

To activate a device at the time you prefer, you can use the timer.

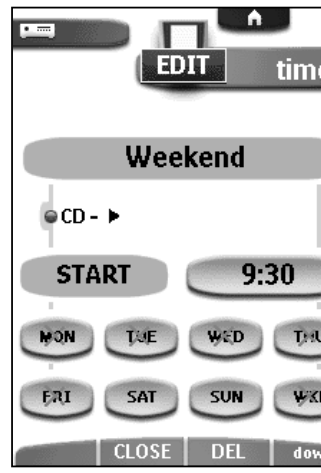
- 1 Tap the Macro tab .
The Macro menu appears.
- 2 In the Macro menu select a timer group.
- 3 Switch to Edit mode via the Remote Control icon .
Empty timer buttons appear in the timer control panel.
- 4 Tap the button you want to set a timer for.
The first timer control panel appears in which you can set the start time.

- 5 Enter the command the timer has to execute.
A timer can contain either a single command or a macro.
You can navigate to whatever control panel you want, just as you do in Use mode.
- 6 Tap the clock button and set the start time using the action buttons.

Getting the Maximum out of it

- 7 Tap one or more day buttons to select or deselect days for the timer.
You can choose to repeat the timer weekly.
- 8 Scroll down to display the second timer control panel in which you can set the stop time.
- 9 Enter the command the timer has to execute.
- 10 Tap the clock button and set the stop time using the action buttons.
- 11 Press the left action button (labeled *Close*) to close the timer.
A confirmation screen appears where you can save or cancel the timer.
- 12 Tap **Save**.
You return to Use mode and the timer is activated.

Note The timer only works when the Remote Control's sending eye is pointed towards the controlled device and no obstructions interfere the infrared signal.

When a timer command is executed, the Alarm icon  appears on the Remote Control icon.

Editing Timers

You can edit any timer you have set.

- 1 Open the timer group that contains the timer.
- 2 Switch to Edit mode via the Remote Control icon .
- 3 Tap the timer you want to edit.
The contents of the timer appear.
- 4 Edit the timer.
- 5 Press the left action button (labeled *Close*) to close the timer.
A confirmation screen appears where you can save or cancel the timer.
- 6 Tap **Save**.
The timer is edited.

Adding Macro Groups and Timer Groups

You can create as many macro groups or timer groups as you like. Each group can contain up to 25 macros or timers.

- 1 Open any macro or timer group.
 - 2 Switch to Add mode via the Remote Control icon .
- You can create a new group, copy an existing group or restore a previous deleted group.

- **Create New Group:** You add a new group in which you can record new macros or set new timers.
- **Copy Existing Group:** You copy a group and its macros or timers and use it for new macros or timers.
- **Restore Deleted Group:** You restore a deleted group and reuse the macros or timers.

3 Tap Create Macro Group or Create Timer Group.

A new macro group or timer group is added.

To add macros in a macro group, see “Recording Macros” on page 35.

To add timers in a timer group, see “Setting Timers” on page 37.

To organize macro groups or timers groups, see “Moving Devices, Macro Groups or Timer Group” on page 31.

Using the Remote Control with Radio Frequency

Warning To use the Remote Control with radio frequency (RF) you need an **RF Extender**, which is not included with the Remote Control.

By default, the Remote Control uses **infrared** (IR) signals to operate devices. This means that you have to point the Remote Control’s sending eye towards the device you’re operating. IR signals have an operating distance of 10 meters (33 feet).

You can choose to operate devices using **radio frequency** (RF) signals instead of IR signals. RF signals have an operating distance of approximately 20 meters (66 feet) in house and can, unlike IR signals, go through obstacles like furniture or walls.

The RF signals sent out by the Remote Control are picked up by the RF Extender. The RF Extender translates the RF signals in IR signals and sends the IR signals to the appropriate device.

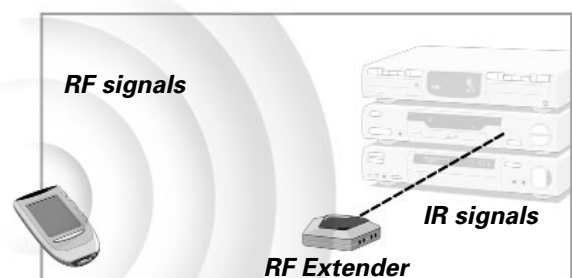
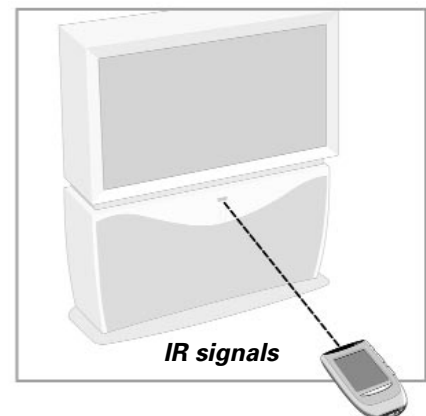

Getting the Maximum out of it

Therefore, the RF Extender has to be placed near the device you're operating with the RF Extender's sending eye pointed to the device.

Your devices will always receive IR signals either directly from the Remote Control or from the RF Extender.

Changing the Remote Control's RF IR Settings

All devices are set up by default to work with IR signals. To be able to operate one or more devices with RF signals, you have to change the Remote Control's RF IR settings for those devices.

1 Make sure the Device tab is active.

The Device tab is active when the name of a device is displayed at the right side of the touch screen .

2 Switch to RF IR mode via the Remote

Control icon .
The Device menu appears.

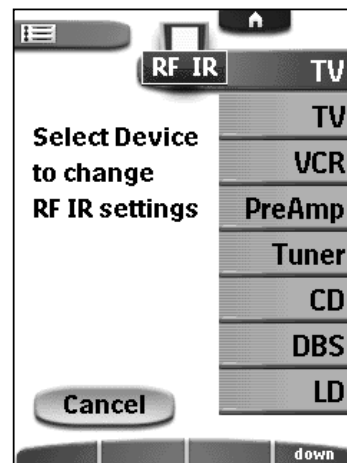

3 Select the device for which you want to change the RF IR settings.

The RF IR settings appear. The red label on the button  indicates that the selected device is currently operated with IR signals.

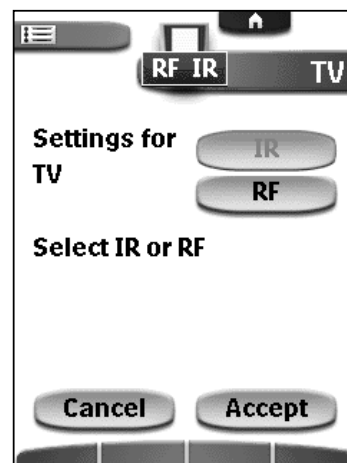

Getting the Maximum out of it

4 Tap .

The RF IR settings for the selected device are changed from IR to RF.

When you have only one RF Extender, you can accept the default settings for the Extender ID and the Channel. Continue with step 5.

-or-

When you have several RF Extenders to operate devices, you have to assign the correct Extender ID to the selected device. Follow the instructions as described in "Changing the Extender ID".

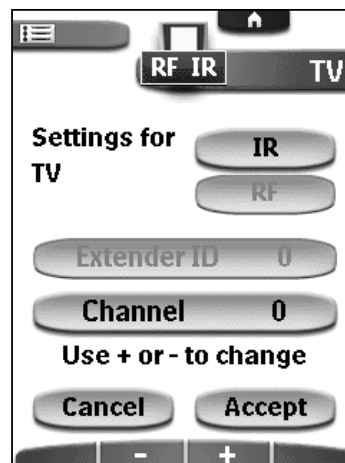

Note The ID on the RF Extender has to match the Extender ID on the Remote Control.

Changing the Extender ID

1 Make sure the button is active.

The button is active when the button label is red.

2 Press the action buttons to change the Extender ID.

The Remote Control offers 16 Extender ID's.

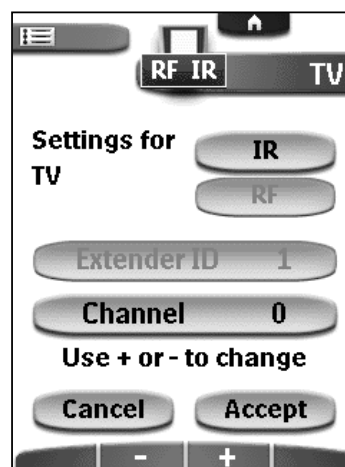

5 Tap Accept to save the RF IR settings for the selected device.

-or-

Tap Cancel to return without changing the RF IR settings for the selected device.

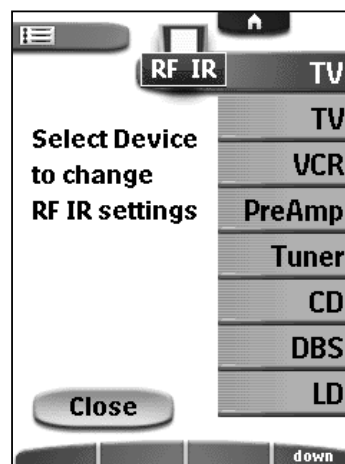

Getting the Maximum out of it

- 6 Repeat instructions 3 to 5 for all devices for which you want to change the RF IR settings.
- 7 Tap Close.
The Remote Control switches back to Use mode. The Remote Control is configured to operate the devices you have set with RF signals.
- 8 Try out the devices for which you just changed the RF IR settings.

Note It is possible that a device does not respond properly when operated with RF signals. This is mostly due to IR signals that cannot be properly transmitted as RF signals.
In that case, you have to reconfigure the Remote Control to operate the device with IR signals again.

Choosing Another Channel

When you notice RF interference, for instance from your neighbours, you have to choose another channel to operate your devices.

Note All devices you want to operate with RF signals use the same channel. If you choose another channel for one device, the Remote Control will automatically change the channel for all devices that work with RF signals.

- 1 Switch back to RF IR mode.
The Device menu appears.
- 2 Select a device that is set with RF signals.
The RF IR settings appear.

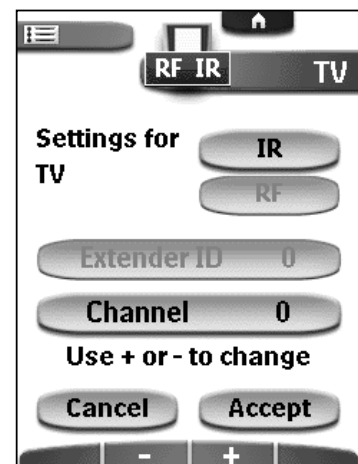

- 3 Tap **Channel 0**.
The button label turns red indicating that the button is active.

Getting the Maximum out of it

- 4 Press the action buttons **-** **+** to change the Channel.

The Remote Control offers 4 RF Channels.

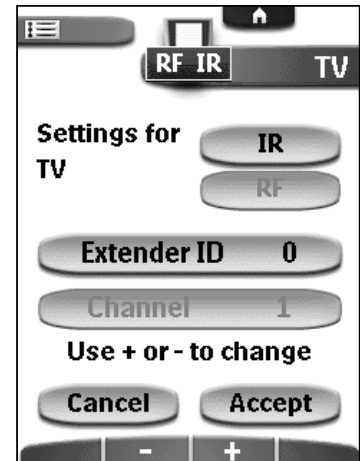

Note The Channel (CH) on the RF Extender has to match the Channel on the Remote Control.

- 5 Tap **Accept** to save the selected Channel for all devices that work with RF signals.

-or-

Tap **Cancel** to return without changing the Channel.

- 6 Tap **Close**.

The Remote Control switches back to Use mode. The Remote Control is configured to operate the devices you have set with RF signals through the selected Channel.

- 7 Try out all devices for which you just changed the Channel.

ProntoPro Edit

If you want to personalize your Remote Control even more beyond its standard programming features, ProntoPro Edit is the tool for you to use. ProntoPro Edit is the Remote Control's companion software that you find on the included CD-ROM. For more information, go to <http://www.pronto.philips.com>.

With ProntoPro Edit you can:

- upload and download new configurations to and from your Remote Control. You do this with the serial cable included with your Remote Control;
- 1** Plug one end of the serial cable in the serial port on your computer.
 - 2** Plug the other end of the serial cable in the serial port on the Remote Control or the serial port of the docking station.

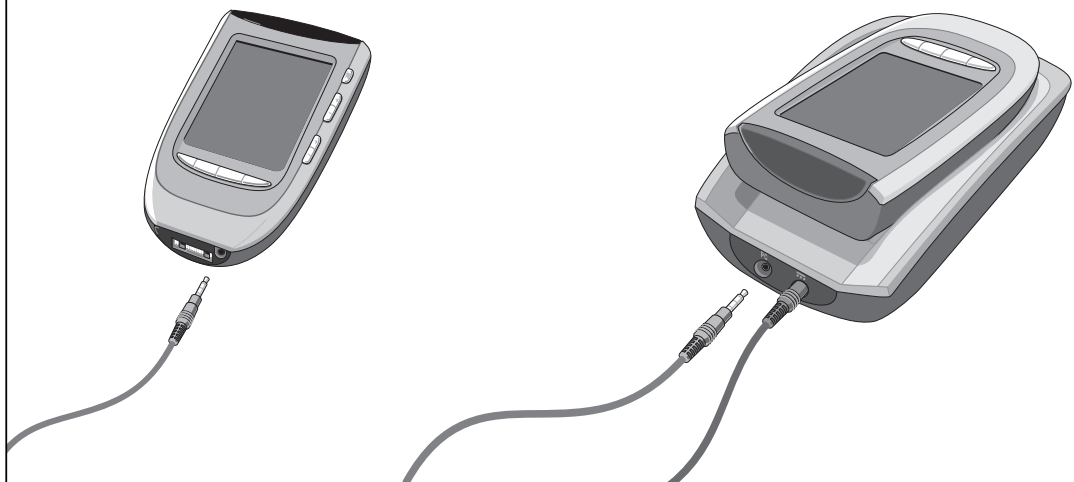

- add, delete, modify and move control panels, devices and commands anywhere on the touch screen;
- save, duplicate and share configuration files, codes or devices with other Remote Controls;
- preview new configuration files on ProntoPro Emulator;

Getting the Maximum out of it



In this way you can check how the Remote Control's interface will look like.

- import new graphics to create new buttons and designs;
- personalize configuration files to optimize the use of your Remote Control.

When you become familiar with ProntoPro Edit, you can achieve results like:

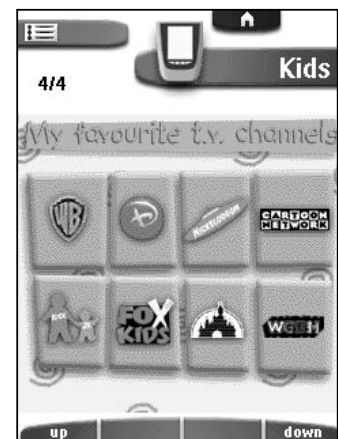
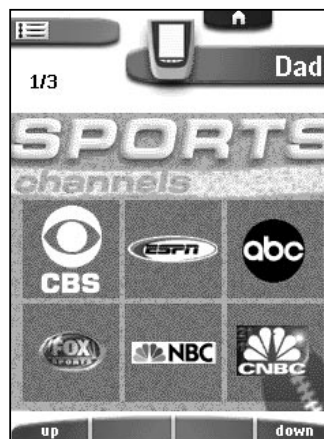

Minimum System Requirements

- PC
- Windows 95/98/ME, Windows NT 4.0/2000, Windows XP
- 16 MB of RAM
- 16 MB of free hard disk space
- Free serial port

General Problems

The display is black

- Tap the screen to make sure the Remote Control is turned on.
Tilt the Remote Control to make sure the Remote Control is turned on.
Press the Backlight button to make sure the Remote Control and the backlight are turned on.
See “Activating the Remote Control” on page 6.
- Adjust the contrast using the contrast dial on the left side of the Remote Control.
- Make sure the battery pack is properly installed.
See “Installing the Battery Pack” on page 4.
- Make sure the battery pack is charged sufficiently.
See “Charging the Remote Control” on page 5.

The display is too light or too dark

- Adjust the contrast dial on the left side.
- Adjust the brightness of the display in the Settings (see p. 18).

The Remote Control shuts off automatically

- This is a feature of the Remote Control to save power. You can change the time the Remote Control stays on in the Settings (see p. 18).

The touch screen buttons on the Remote Control do not respond properly

- Calibrate the touch screen (see p. 50).

Devices do not respond to commands from the Remote Control

- Make sure the Remote Control is in Use mode (see p. 22).
- Make sure the Remote Control’s sending eye is pointed towards the device you’re operating.
- Check if the Low Battery icon is flashing at the right top of the touch screen. If so, recharge the battery pack.
- Check if you have defined the correct brands for your devices.
- Check if the button you are trying to use is assigned properly via Brand mode (see p. 24) or via Learn mode (see p. 25).
- Check if your device understands Philips-Marantz RC codes. Normally you can find this in the documentation of your device.
- If you have set up your Remote Control to operate devices with RF signals:
 - Check in the RF IR mode if the devices you want to operate are set up properly (see p. 39).
 - Check if the Extender ID and the Channel on your Remote Control match the ID and the Channel (CH) on the RF Extender.
 - Make sure the RF Extender is placed near the devices you want to use with RF signals.
 - Change the Channel if you notice interferences from other RF channels (see p. 42).

- Be aware that more than one RF Extender is needed if you want to use RF signals for devices on different locations.
- Please refer to the documentation of the RF Extender for detailed information about using the RF Extender.

The Remote Control beeps 4 times after installing the battery pack

- Four beeps indicate an invalid software version. Use ProntoPro Edit to update the Remote Control's software (ProntoPro Edit > Tools > Update).

Programming Problems

Buttons are not sending the correct commands

- Check whether the button is learned globally or per device (see p. 28).
- Check if you have defined the correct brands for your devices.

Macros do not work

- Make sure the Remote Control's sending eye is pointed towards the device the entire time the macro is being executed.
- Insert delays to allow devices to start up properly (see p. 36).
- Check for inactive buttons in your macro.
- Check if you do not have reprogrammed the buttons. Macros do not store commands, they store buttons. If you reprogram a button, the macro executes the new command assigned to the button.

The TV goes blank or the input source changes

- The device action for the device you selected might be programmed to switch the input source. Operate the device without affecting the input source (see p. 16).

The Remote Control will not learn, label or delete commands

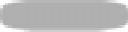
- If the label locked appears on the Remote Control icon, the device control panels have been locked to prevent unwanted changes. You cannot modify or delete commands for this device.
- Make sure your devices are positioned as shown on page 25. When the sending eye of your existing remote control is not pointed towards the learning eye of the Remote Control, the Remote Control might not receive the signals properly. Align the remote controls as correctly as possible. When the distance between your existing remote control and the Remote Control is too short or too long, the Remote Control might not receive the signals properly. Try out several distances between 100 and 200 mm (4 and 8 inches) to learn the commands.
- Avoid programming the Remote Control under bright fluorescent light: it might affect the infrared signals.
- Make sure the button you want to edit is not a touch screen label, because touch screen labels cannot be programmed. Touch screen labels are flat, buttons are three dimensional. 

The Remote Control will not switch modes

- When the battery pack is low the Remote Control prevents you from switching to customizing modes so that no customization can get lost. Recharge the battery pack (see p. 5).

The Remote Control is low on memory

- The Remote Control displays a message to clean up the memory. The Remote Control will do this by permanently removing devices and macro and timer groups you have deleted.

Warning *Cleaning up memory can take 30 minutes or longer. Never remove the battery pack during the clean-up process. This might damage the configuration file resulting in loss of your customized commands.*

The configuration file is corrupted

- When this very unlikely event occurs, you have to revert to the original configuration or use ProntoPro Edit to upload a new configuration file. All your customized commands devices and macros will be lost and you will have to reprogram your Remote Control.

Remote Control error messages

- If one of the following error messages occurs, please contact your dealer or the Philips customer service:
 - Can't open configuration file;
 - Configuration file error;
 - No configuration file found;
 - Invalid configuration file version.

Recharging Problems

The battery pack will not recharge

- Make sure the battery pack is properly installed in your Remote Control (see p. 4).

The indicator light flashes on the docking station

- Make sure the battery pack is properly installed in your Remote Control. See "Installing the Battery Pack" on page 4.
- Make sure the Remote Control lies placed properly in the docking station. You need to hold the Remote Control at an angle of 30 to 45° to plug it in the connector of the docking station. See "Charging the Remote Control" on page 5.
- Check if the connector in the docking station is clean and free of obstructions.

Can I program a button to execute more than one command?

With the Remote Control you can only create a macro to execute a sequence of commands (see p. 35). But you can program a button to execute more than one command with ProntoPro Edit.

How do I program source switching?

See "Learning Device Actions" on page 27.

How can I program, label or delete buttons on the Home panel?

You can do this via the Device menu. All changes you make to the devices in the Device menu are automatically updated on the Home panel.

Can I recharge the Remote Control any time I want?

Yes, you can. It is not necessary to use the Remote Control until the battery pack has ran out completely. The docking station is the most suitable place for the Remote Control when not in use.

How do I reset the Remote Control?

Under normal circumstances, you will never have to reset the Remote Control. However, on rare occasions, if the Remote Control's touch screen freezes or if you notice unusual behavior, you need to perform a reset to get the Remote Control running again. All saved programmed commands or macros are retained.

1 Slide the battery cover off the back of the Remote Control.

You will see the Reset button in the battery compartment.

2 Use an unfolded paperclip or a sharp pencil to carefully press the Reset button.

The Remote Control restarts and a Introduction screen appears.

The Remote Control beeps twice to indicate it is ready for use.

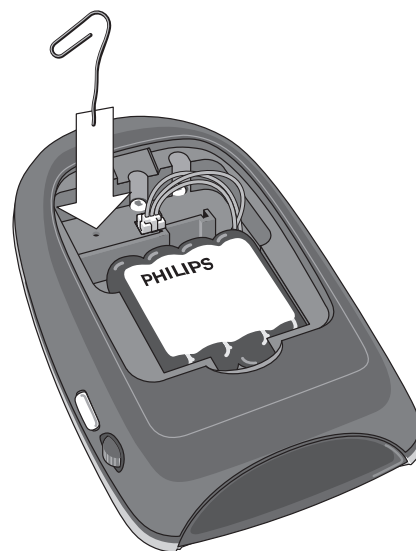
**How do I revert to the original configuration?**

Reverting to the original configuration restores the Remote Control's devices and commands to its state when you purchased it. This means that all programming is lost permanently. Normally, you never have to revert the Remote Control.

1 Touch and hold the Remote Control icon for a few seconds.

The first setup panel appears.

2 Scroll to the second setup panel.

3 Tap the Revert button.

4 Tap Revert to confirm the action.

How do I calibrate the touch screen?

The Remote Control is calibrated when it leaves the factory. It is possible you have to calibrate the touch screen:

- when the touch screen buttons do not respond properly.
Complete instructions 1 to 6 in “Calibrating the touch screen” described below.
- when the Remote Control displays a message to calibrate the touch screen.
Complete instructions 4 and 5 in “Calibrating the touch screen” described below.

Calibrating the touch screen

1 Touch and hold the Remote Control icon  for three seconds.
The Remote Control switches to Setup mode.

2 Scroll to the second setup panel.

3 Tap the Calibrate button .
The first instruction “Touch TOP LEFT corner” appears.

4 Tap as close as possible in the upper left corner using a blunt tip of a pencil.
The second instruction “Touch BUTTOM RIGHT corner” appears.

5 Tap as close as possible in the upper right corner using a blunt tip of a pencil.
The setup panel appears again.

6 Tap the Remote Control icon .
The Remote Control switches to Use mode.

Why does a device respond to some RF signals and not to others?

It is possible that a device does not respond properly when operated with RF signals. This is mostly due to IR signals that cannot be properly transmitted as RF signals.

In that case, you have to reconfigure the Remote Control to operate the device with IR signals again.

Maintaining the Remote Control

Important notices

Take care not to scratch the touch screen

Use your finger to tap the touch screen or use plastic-tipped pens intended for use with touch screen.

Never use an actual pen, pencil or other sharp object on the touch screen.

Protect the Remote Control from temperature extremes

Keep the Remote Control away from heaters and other heat sources.

The Remote Control is not waterproof

The Remote Control should not be exposed to rain or moisture.

Do not store or use the Remote Control in any location that is extremely damp or wet.

When you have spilled water on the Remote Control, you have to take out the battery pack and let the Remote Control dry for 48 hours before you replace the battery pack.

When you have spilled other liquids on the Remote Control, you can clean it with distilled water.

The touch screen of the Remote Control contains a glass element

Do not drop the Remote Control or subject it to any strong impact.

Cleaning the Remote Control





























Use a soft, damp cloth to clean the Remote Control.

If the touch screen of the Remote Control is spoiled, clean it with a soft cloth moistened with a diluted window-cleaning solution.



























Do not use a corrosive detergent or an abrasive sponge.

Avoid the use of abundant water.













Overview of Symbols

	Pause
	Stop
	Normal run; normal speed
	Normal run; normal speed
	Fast run; fast speed
	Fast run; fast speed
	Slow run; slow speed
	Slow run; slow speed
	Eject
	Recording, general
	Key
	Navigate
	Still mode
	Tape running direction
	Next track
	Previous track
	Fast forward to index
	Rewind to index
	Frame by frame, general
	Frame by frame, general
	Subtitle
	Cancel picture
	Picture-in-picture mode
	Menu
	Picture-in-picture shift
	Picture-in-picture swap
	Multi-picture display
	Picture-in-picture select
	Teletext mode

Overview of Symbols

	Page number up
	Page number down
	Page enlargement
	TV and text mixed
I-II	1st or 2nd language
P◀P	Last view; previous program
	Stand-by
	Zone focus: long distance
	Zone focus: very short distance
-/--	Single or multi-digit selection
	Brightness; brilliance
	Contrast
	Brightness/contrast
	Color saturation
	Lamp; lighting; illumination
	Split screen freeze / double screen freeze
	Split screen swap / double screen swap
	Split screen / double screen
	Movie expand
	Personal preference
	Picture-in-picture freeze
	Main index page
	Picture freeze
	Programmable timer; general
	Tracking
	Application assistance
	Actual time on screen
	EPG / Electronic Program Guide
	Video output

Overview of Symbols

	Read data from store
	Write data into store
	Page hold
	Sound muting
	Additional information on screen
	Viewing angle
	Spatial sound effect
	Television; video
	Sound; audio
	Surround sound
	Picture size adjustment
	Active control



Specifications

The specifications and design of this product are subject to change without notice.

<i>Hardware</i>	<i>High-resolution (320 x 240) liquid crystal display (LCD) with 256 color, contrast and brightness control</i> <i>Large touch screen</i> <i>Nine programmable direct-access buttons</i> <i>Backlighting for LCD and direct-access buttons</i> <i>Pick Up sensor</i> <i>Infrared sending and learning eyes</i> <i>3-wire (RS232) serial port connector</i>
<i>Software</i>	<i>Dynamic, animated interface with 256 colors</i> <i>Built-in Philips-Marantz RC codes</i> <i>Database with RC codes to operate different brands</i> <i>Editable macros (up to 255 commands per macro)</i> <i>Total number of devices and macros limited only by memory</i>
<i>Infrared (IR)</i>	<i>Operating distance of 10 meters (33 feet)</i> <i>Learning frequency up to 56 KHz</i> <i>Learning distance 50 mm (2 inch) up to 300 mm (1 foot)</i>
<i>Radio frequency (RF)</i>	<i>Operating distance of approximately 20 meters depending on the surrounding conditions</i> <i>Band: 418 MHz</i> <i>Bandwidth: +/- 100 kHz</i> <i>16 Extender ID's and 4 Channels</i>
<i>Memory</i>	<i>8 MB non-volatile flash memory (retains commands when battery pack is not present)</i> <i>512 K SRAM</i>
<i>Battery pack</i>	NiMH 4,8V rechargeable battery pack
<i>Power management</i>	<i>Power on by tapping the touch screen, by pressing the backlight button or by tilting</i> <i>Power off automatically</i>
<i>Dimensions</i>	141mm x 94mm x 33mm (5.6 inch x 3.7 inch x 1.3 inch)
<i>Operating temperature</i>	0°C to 50°C (32°F to 122°F)
<i>Accessories</i>	<i>Docking station and power adapter</i> <i>Battery pack</i> <i>RS232 cable for PC connection</i> <i>CD-ROM with ProntoPro Edit software</i>
<i>Accessories (not included)</i>	<i>RF Extender (RFX6000)</i>

Database information:
Designed by UEI Technology
Licensed under U.S. Patent 5,689,353
Portions " UEI 1999

A

- action buttons, 2, 17
 - deleting, 32
 - labeling, 29
 - learning globally, 28
 - learning per device, 28
 - restoring, 34
- activating the Remote Control, 6
- Add mode, 22, 31, 38
- adding
 - delays, 36
 - devices, 31
 - devices to the Home panel, 31
 - macro groups, 38
 - timer groups, 38
- adjusting the settings, 18

B

- backlight
 - switching off, 6
 - turning on, 6
- backlight button, 2, 6
- battery cover, 2, 4
- battery level, 19
- battery pack, 4
 - charging, 5
 - installing, 4
 - NiMH, 4
 - running low, 5
- battery setting, 19
- beep
 - buttons, 20
 - four beeps, 47
 - touch screen, 20
 - two beeps, 5
- Brand mode, 7, 22, 24
- brands
 - defining, 7
 - redefining, 24
 - searching, 12
 - selecting, 9
- brightness setting, 19
- button light setting, 19
- buttons
 - action, 2, 17
 - backlight, 2, 6

- direct-access, 2, 18
- Home, 6
- labeling, 29
- Page Up and Page Down, 2, 17
- reset, 2, 49
- touch screen, 16

C

- calibrating, 20
- changing
 - Extender ID, 41
 - RF IR settings, 40
- changing order. *See* Move mode
- Channel
 - on the Remote Control, 42
 - on the RF Extender, 42
- charging
 - charging LED, 3, 5
 - frequency, 5
 - Remote Control, 5
 - time, 5
- choosing another Channel, 42
- clock setting, 19
- code sets
 - searching, 10, 12
 - selecting, 10
- commands
 - learning, 25
 - sending, 16
 - sequence, 35
 - timing, 35
- configuration files
 - adding, 44
 - saving, 44
 - sharing, 44
- connection
 - adapter, 3, 5
 - docking station, 5
 - Remote Control, 2, 3, 5
- contrast dial, 2, 6
- control panel buttons
 - deleting, 32
 - labeling, 29
 - learning, 26
 - restoring, 34
- Copy Existing Device, 31

- Copy Existing Group, 39
- Create New Device, 31
- Create New Group, 39
- customizing. *See* ProntoPro Edit. *See* learning. *See* redefining brands
- D**
- day setting, 19
- defining brands
 - searching brands and code sets, 12
 - selecting brands and code sets, 8
 - selecting brands and searching code sets, 8
- delays, 36
- Delete mode, 22, 32
- deleting
 - buttons and button actions, 32
 - device actions, 33
 - devices, 33
 - macro groups, 33
 - timer groups, 33
 - touch screen labels, 32
- device actions
 - deleting, 33
 - learning, 27
 - restoring, 34
- Device menu, 15
 - selecting a device, 15
- Device tab, 15
 - icon, 14
- devices
 - adding, 31
 - deleting, 33
 - labeling, 30
 - moving, 31
 - operating, 15
 - restoring, 34
 - selecting, 15
- direct-access buttons, 2, 18
 - deleting, 32
 - learning globally, 28
 - learning per device, 28
 - restoring, 34
- disabling the Mode menu, 23
- display
 - cleaning, 51
 - switching off, 6
 - turning on, 6
- docking station, 3
 - charging, 5
 - connecting to PC, 44
 - loading, 44
- downloading new configurations, 44
- E**
- Edit mode, 22, 35, 37
- editing
 - macros, 36
 - timers, 38
- empty buttons, 25, 26
- empty macro buttons, 35
- empty timer buttons, 37
- Extender ID
 - on the Remote Control, 41
 - on the RF Extender, 41
- eye
 - for learning commands, 2, 25
 - for sending commands, 2, 16
- F**
- first time usage
 - activating, 6
 - defining brands, 7
- free memory, 20
- G**
- graphics, 45
- H**
- Home button, 6
- Home panel, 13
 - activating Device menu, 14
 - activating Macro menu, 14
 - selecting a device, 15
- I**
- importing graphics, 45
- infrared (IR), 39
- inserting delays, 36
- installing
 - RC codes, 11, 13
 - the battery pack, 4

intro, 21
IR signals, 39

K

keyboard
 character, 8, 29
 deleting a character, 9, 29
 space, 9, 30
 symbols, 29
 virtual auto-zooming, 8, 29
 zoom, 8, 29

L

Label mode, 22, 29
labeling
 buttons, 29
 devices, 30
LCD setting, 19
Learn mode, 22, 25
learning
 action buttons globally, 28
 action buttons per device, 28
 commands from existing remote controls, 25
 control panel buttons, 26
 device actions, 27
 direct-access buttons globally, 28
 direct-access buttons per device, 28
 empty buttons, 25
 eye, 2, 25
 Home panel buttons, 25
LED as charging indication, 5
list of brands
 navigating, 8
 scrolling, 8
Low Battery icon, 5

M

macro groups
 deleting, 33
 labeling, 30
 moving, 31
 restoring, 34
Macro menu, 35
Macro tab, 35

 icon, 14, 35
macros
 editing, 36
 labeling, 29
 organized into groups, 38
 recording, 35
memory, 8
menu
 Device, 15
 Macro, 35
 Mode, 23
mode, 6
 Add mode, 22, 31, 38
 Brand mode, 7, 22, 24
 Delete mode, 22, 32
 Edit mode, 22, 35, 37
 Label mode, 22, 29
 Learn mode, 22, 25
 Move mode, 22, 31
 RF IR mode, 22, 40
 Search mode, 10, 12
 Setup mode, 18
 switching between modes, 23
 Try mode, 11, 13
 Use mode, 22
Mode menu, 23
 disabling, 23
 setting, 20
Move mode, 22, 31
moving
 devices, 31
 macro groups, 31
 timer groups, 31

N

number of panel, 17

O

operating a device
 with IR, 15
 with RF, 39

P

Page Up/Page Down buttons, 2, 17
panel number, 17
Pick Up sensor, 6, 20

- power adapter, 5
- powering
 - charging the Remote Control, 5
 - installing the battery pack, 4
- ProntoPro Edit, 44
- ProntoPro Emulator, 44
- R**
- radio frequency (RF), 39
- RC codes
 - installing, 11, 13
 - responding, 11, 13
 - searching, 10, 12
 - selecting, 10
 - sending, 10, 12
- recharging. *See* charging
- recording
 - ending macro with device control panel, 36
 - macros, 35
 - source switching, 36
- redefining brands
 - searching brands and code sets, 24
 - selecting brands and code sets, 24
 - selecting brands and searching code sets, 24
- relabeling. *See* labeling
- Remote Control
 - appliance, 2
 - charging, 5
 - cleaning, 51
 - database, 8
 - docking station, 3
 - list of brands, 8, 12
 - list of code sets, 9
 - loading, 44
 - memory, 8
 - touch screen, 3
- Remote Control icon, 6
 - transmitting signals, 16
 - turned around, 17
- renaming. *See* labeling
- reset button, 2, 49
- resetting the Remote Control, 49
- responding RC codes, 11, 13
- Restore Deleted Device, 31
- Restore Deleted Group, 39
- restoring
 - buttons and button actions, 34
 - device actions, 34
 - devices, 34
 - macro groups, 34
 - timer groups, 34
- reverting, 20
- reverting the Remote Control, 49
- RF Extender, 39
 - Channel, 42
 - ID, 41
- RF IR mode, 22, 40
- RF IR settings, 40
 - Channel, 42
 - Extender ID, 41
 - IR, 41
 - RF, 41
- RF signals, 39
 - interference, 42
- S**
- scrolling
 - in a loop, 18
 - through control panels, 17
 - through menu items, 17
- Search mode, 10, 12
- searching
 - brands and code sets, 12
 - code sets, 10
- selecting
 - a device without affecting other devices, 16
 - brands, 9
 - code sets, 10
 - devices, 15
- sending
 - commands, 16
 - IR signals, 16, 39
 - no IR, 16
 - RC codes, 10, 12
 - RF signals, 39
- sending eye, 2
- serial cable, 44
- serial port
 - docking station, 3, 44

- Remote Control, 2, 44
- setting timers, 37
- settings
 - adjusting, 18
 - reverting, 49
- Setup mode, 18
- setup panel
 - first, 19
 - second, 20
 - third, 21
- signals
 - no IR, 17
- source switching, 36
- specifications, 21
- start time, 37
- stop time, 38
- switch off, 6
- switching
 - to another mode, 23
- switching off display, 6

T

- technical information, 21
- time display, 19
- timer
 - organized into groups, 38
- timer groups
 - deleting, 33
 - labeling, 30
 - moving, 31
 - restoring, 34
- timers
 - editing, 38
 - labeling, 29
 - setting, 37
 - starting, 37
 - stopping, 38
- touch screen, 2
 - beep, 20
 - buttons, 16

- touch screen labels, 32
- Try mode, 11, 13
- turning on
 - backlight, 6
 - display, 6

U

- uploading new configurations, 44
- Use mode, 22
- using the Remote Control with RF, 39

Z

- Zoom in and out (virtual keyboard), 8, 29