

PRODUCT SUPPORT INFORMATION

THE ORIGINAL OMNIMOUNT MOUNTING SYSTEM
AND RELATED ACCESSORIES.

**APPLICATIONS LIMITED ONLY
BY THE IMAGINATION.**

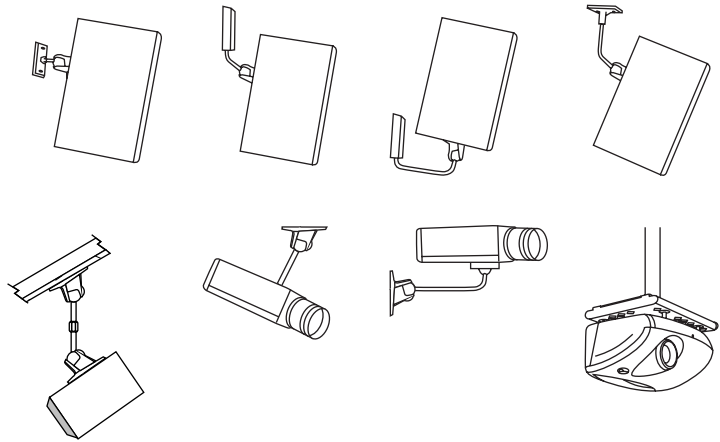

**SELECTION
DIMENSIONS
SPECIFICATIONS**

FIRST, SOME GENERAL THINGS FOR YOU TO KNOW . . .

...ABOUT THE OBJECT YOU'RE MOUNTING

"OmniMount Prepped" refers to objects that can be fitted directly to OmniMount products. These objects contain factory installed threaded inserts, engineered and designed by the manufacturer. The inserts are intended to provide safe support when the object is mounted. Many loudspeakers have them, as do most security cameras.

If no factory inserts have been provided, then it is you who will have to evaluate the strength of the object and the integrity of the materials it's made of. The construction of the object must be at least sturdy enough to support its own weight over time, especially at the point of attachment to the OmniMount assembly.

...AND WHAT YOU'RE MOUNTING ONTO

Careful evaluation must be made of the surfaces you will be mounting onto. Adequate strength, composition, and construction of these surfaces are obviously crucial to a safe and secure installation.

Specify and use the appropriate interfacing hardware. Select the right type, size and combination of fasteners to support the load safely. Consider carefully and plan for all installation conditions and variables. "How much does it weigh?" This is probably the first question that comes to mind when deciding to mount something on the wall or ceiling.

But mounting any object safely and properly also requires careful consideration of the object's overall size (height x width x depth), its center of gravity, distribution of load, and whether or not dynamic loading will be acting upon it.

STATIC/STATIONARY LOAD VS. ACTIVE/POTENTIAL DYNAMIC LOAD

An OmniMount assembly attached to a solid wall, where no external motion forces are at play, is an example of a static/stationary load installation.

An OmniMount assembly attached to a surface inside a moving vehicle subjects the mounted object to an active dynamic load situation. As an example of a potential dynamic load installation, consider a ball thrown astray in a sports venue and how it could impact a mounted object.

The best way to compensate for dynamic loading is to choose an OmniMount assembly capable of supporting greater weight than the object itself. This usually means choosing the same model, but with the next higher series number.

FOR PRODUCT SELECTION YOU'LL NEED TO KNOW THREE BASIC THINGS

1. The location of the mounting surfaces: That is, on the wall, ceiling, floor deck, or other place. And where, on the object itself, the OmniMount assembly will be secured – on the top, on the back, on the bottom, or on the side.

2. The weight of the object to be mounted: Use the weight chart inside as a guide.

3. The overall dimensions of the object: Height, width and depth. This information is required to choose accurately the OmniMount model that will best fit the object your mounting and best fit in the space available for it. The full sweep of the chart gives you dimension information for both the complete models and their component parts.

Combine good judgment with a common sense knowledge of the physical laws that affect balance and stability, and you'll choose the best OmniMount product to do the job.

ARCHITECTURAL AND ENGINEERING SPECIFICATIONS

Where "Universal Mounting Assemblies" are indicated in contract documents, they shall be "as manufactured by OmniMount Systems." Mounts shall have a carbon steel ballshaft with a polymer ball permanently bonded to one end. Clamp Assemblies and Mounting Plates shall be of aircraft grade aluminum alloy, with remaining structural components fabricated of cold-rolled steel. Fasteners used for assembly shall be of hardened steel – certain cosmetic parts shall be of injection molded plastic. Fastening hardware selected for mounting surfaces shall be of a proper size and type to support loads safely – as detailed in OmniMount Systems' product data and installation instructions. Fastening hardware shall be finished as necessary for environmental protection and to color-match mounting assemblies.

Snap-on Plastic Cover

Jam Nut

Locks the rotational position of the tube by tightening it against the top of the wall bracket.

Wall Mounting Fasteners

Wall Mounting Bracket

Formed from cold rolled steel.

Cover Interlock

Boss inside cover interlocks with notch in the wall bracket (four places).

Lock Nut

A nylon locking ring is formed into the top of the nut. When the threads penetrate this ring, the locking action prevents separation from the mounting plate.

Steel Tube

Able to rotate 360°.

Mounting Plate

Reinforced with four internal structural ribs and die cast from aluminum aircraft alloy. (Used with CA-MP and STMP models.)

Heavy Steel Shoulder Nut

Locks the rotational position. Objects mounted on model CA-MP create lateral forces that push against the tube. This special shoulder nut prevents these forces from transmitting to the tube threads.

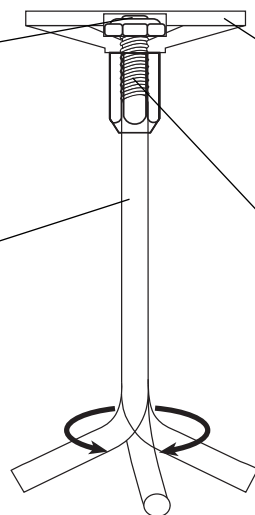
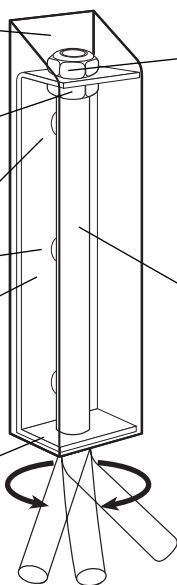

Although all the features indicated in this brochure are common to some models, other models incorporate only some of the features.

WHAT IT'S MADE OF AND HOW IT WORKS

Polymer Ball

This is the “heart” of the OmniMount System. A lot of research and development have gone into this proprietary compound. Extremely high tensile strength and unique compression-set are among its secrets.

Invisible Wiring Feature

All models allow you to conceal the wires internally through the entire assembly, further enhancing installation aesthetics.

Steel Capture Ring™

The ring is electro-welded to the tube at an eccentric angle. The ring and tube-end are then immersed in a thermally reactive chemical adhesive.

When molded, the ball is mechanically captured by the welded ring and bonded by the adhesive. This “triple positive lock” (thermal, chemical and mechanical) ensures that the ball cannot separate from the tube.

Screw Mounting Holes

(Four locations). Illustrated with screws in place.

Force Limiting Cap Nut™

A fixed number of threads is precisely cut into the cap nut. This limits the travel of the tension screw and helps prevent over-tightening of the clamp assembly.

Clamp Assembly

Made of die cast aluminum aircraft alloy, the assembly is comprised of the clamp plate and jaw.

Jaw

Movable part of the Clamp Assembly.

Clamp Plate

Stationary part of the Clamp Assembly. When the tension screw is tightened, the clamp plate and jaw compress around the ball, locking in the chosen angle of adjustment.

Steel Tube

High carbon, heavy wall.

Spherical Cavities

Designed into the clamp assembly, the cavities have internal “teeth” that bite into the ball during the tightening process. This helps hold the object at the chosen angle of adjustment.

Tension Bolt

Made of grade 8 hardened steel, this bolt and cap nut are recessed for a clean look.

The Fulcrum

A precise range of movement is designed into this pivot point: It allows the jaw to be opened just wide enough to remove – and later replace the ball during installation. It also distributes the substantial compressive forces generated when the mounted object is locked into position.

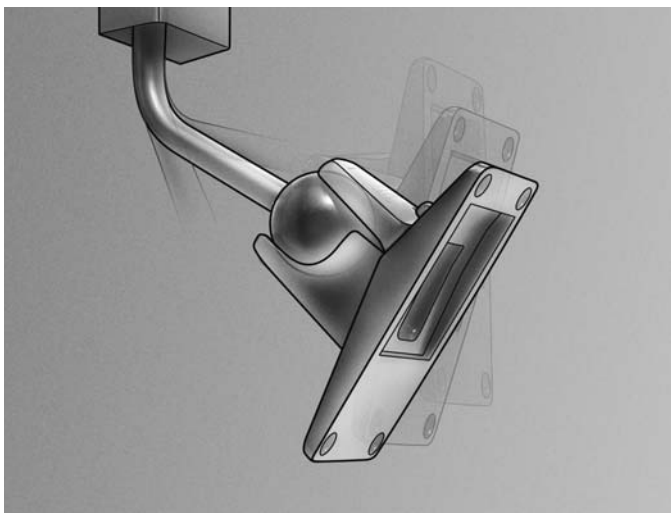

Omnidirectional adjustability, far beyond the usual pan and tilt. OmniMount assemblies allow infinite angles of adjustment. Most models are available in Black and Navajo White finishes.

FOR YOUR INFORMATION

OmniMount® Systems have been specified and installed both safely and productively for many years. With the extraordinarily varied applications and installation advantages of OmniMount products, it is important to become fully aware of the guidelines and specifications we have set forth here. The more familiar you become with OmniMount assemblies, the more time-saving uses you're likely to find for them.

The patented OmniMount Systems ball and clamp assembly works with a variety of ball shaft lengths and bend configurations, wall brackets, mounting plates, plumbing pipe, all-thread rod adapters and accessories – all in many sizes and load handling capabilities.

OmniMount products are carefully engineered and quality manufactured in the U.S.A. They are built to do their job efficiently for a long time.

OmniMount assemblies are of industrial quality, but they're not industrial looking. Functional design makes for special good looks, creating a clean, uncluttered installation. Specifying OmniMount products eliminates the need for welding or custom fabricating expensive brackets. And you'll no longer have to settle for unsightly and time-consuming “nuts and bolts” alternatives.

AUDIO BASICS AB1 AND AB2 COMPLETE

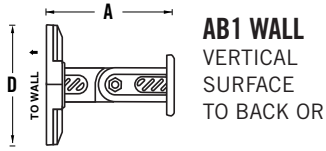

THE AB1 WILL SUPPORT UP TO 2.5 LBS. (1.1 KG)

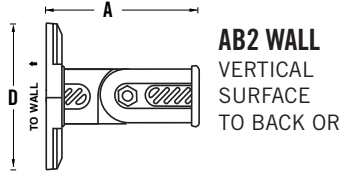

THE AB2 WILL SUPPORT UP TO 8 LBS. (3.6 KG)

	AB1	AB2
A	2 13/16" 73.0 mm	3 11/16" 94.0 mm
B	3 13/16" 98.0 mm	4 13/16" 122.0 mm
C	1 5/8" 43.0 mm	2 5/8" 58.0 mm
D	2 5/8" 65.0 mm	3 1/2" 90.0 mm

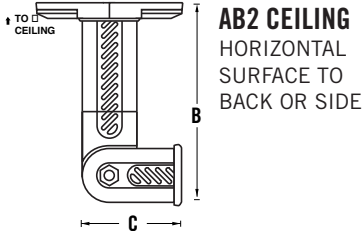
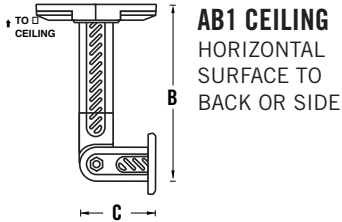

AUDIO BASICS WAS CONCEIVED AS THE PERFECT, FLEXIBLE MOUNTING SYSTEM FOR THE SMALL SPEAKERS TYPICAL OF SMALL TO MEDIUM ROOM INSTALLATIONS OF 5.1 SURROUND SOUND SYSTEMS. THE RESULTING AUDIO BASICS DESIGNS PROVIDE STRONG, RELIABLE, YET LOW-COST MOUNTING SOLUTIONS FOR WALL AND CEILING INSTALLATIONS OF **ALL** SMALL SPEAKERS, INCLUDING 5.1 SYSTEM FRONT, CENTER AND REAR CHANNEL INSTALLATIONS.

AUDIO BASICS INCLUDE THE NECESSARY HARDWARE* FOR VIRTUALLY ALL SPEAKER MOUNTING SITUATIONS. INCLUDING THREADED INSERTS**, KEYHOLE ADAPTERS, MOUNTING PLATES, AND DRILLING OF CABINETS, IF NECESSARY. — *ALLEN (HEX) WRENCH, SCREWS, "TOGGLER" BRAND ANCHORS, AND DRILL BIT. **AB1: 4MM AND 5MM, AB2: 5MM AND 1/4-20

SOME OMNIMOUNT PRODUCTS IN USE

WA
FROM
WALL TO
BACK OF
OBJECT

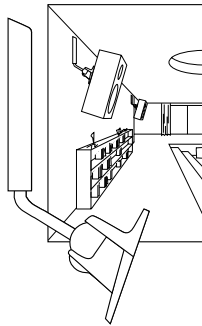

CA
FROM
CEILING
TO BACK
OF OBJECT

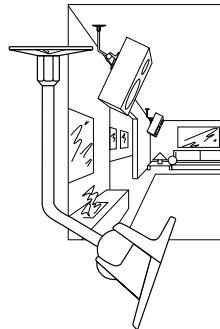

WB
FROM WALL
TO BOTTOM
OF OBJECT

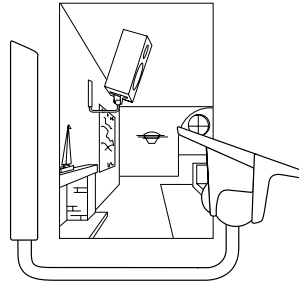

ST-MP
FROM WALL,
CEILING OR FLOOR
TO TOP, BACK,
BOTTOM OR SIDES
OF OBJECT

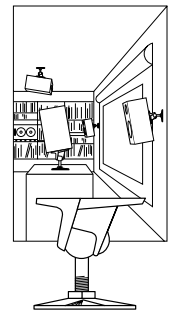

THE PLUMBING PIPE CONNECTION

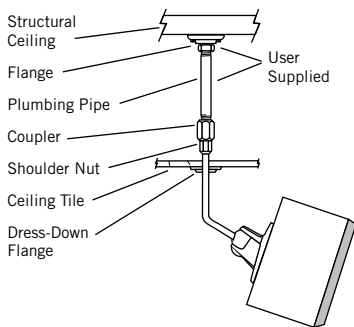

CA-PA

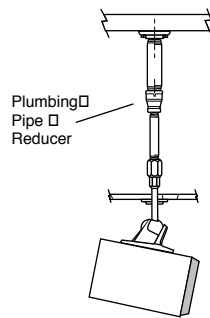

STX-PA

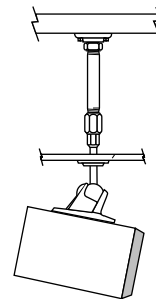

STX-PA

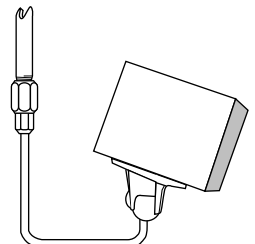

CB-PA

WEIGHT CHART

NEW MODEL	SUPPORTS	PREVIOUS MODEL
5.0 SERIES	UP TO 5 LBS. (2.2 KG.)	MSMK
10.0 SERIES	UP TO 10 LBS. (4.5 KG.)	25 SERIES
20.0 SERIES	UP TO 20 LBS. (8.9 KG.)	53 SERIES
20.5 SERIES	UP TO 20 LBS. (8.9 KG.)	50 SERIES
30.0 SERIES	UP TO 30 LBS. (13.4 KG.)	75 SERIES
60.0 SERIES	UP TO 60 LBS. (26.8 KG.)	100 SERIES
120.0 SERIES	UP TO 120 LBS. (53.5 KG.)	300 SERIES
240.0 SERIES	UP TO 240 LBS. (107.1 KG.)	500 SERIES

WALL

VERTICAL SURFACE TO BACK OR SIDE OF SPEAKER

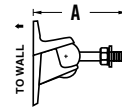

CEILING

HORIZONTAL SURFACE TO BACK OR SIDE OF SPEAKER



	5.0 SERIES	10.0 SERIES	20.0 SERIES
A	3 1/64" 76.2 mm	2 7/8" 73.0 mm	4" 101.6 mm
B	3 7/8" 98.4 mm	5" 127.0 mm	7 1/2" 190.5 mm

WA

WALL (VERTICAL SURFACE) TO BACK OR SIDE OF SPEAKER (VERTICAL SURFACE)

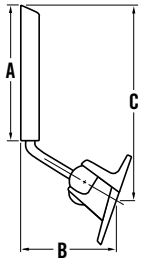

CA

CEILING (HORIZONTAL SURFACE) TO BACK OR SIDE OF SPEAKER (VERTICAL SURFACE)

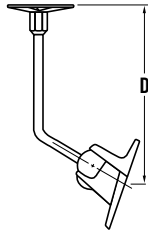

CA-PA

VERTICAL PIPE TO BACK OR SIDE OF SPEAKER (VERTICAL SURFACE)

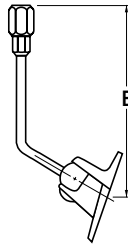

	20.5 SERIES	30.0 SERIES	60.0 SERIES	120.0 SERIES
A	6 1/4" 158.8 mm	6 1/4" 158.8 mm	9 1/4" 235.0 mm	12" 315.9 mm
B	4 5/8" 117.5 mm	5 3/8" 136.5 mm	6 7/8" 174.6 mm	9 1/2" 241.3 mm
C	9 1/2" 241.3 mm	10" 254.0 mm	14" 355.6 mm	19" 482.6 mm
D	9" 228.6 mm	10 1/4" 260.4 mm	13 1/8" 333.4 mm	18 1/4" 463.6 mm
E	10" 254.0 mm	11 1/4" 287.8 mm	14 3/8" 365.1 mm	19 1/2" 495.3 mm

WB

WALL (VERTICAL SURFACE) TO BOTTOM OR TOP OF SPEAKER (HORIZONTAL SURFACE) MAY BE USED INVERTED

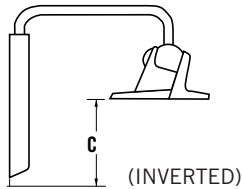
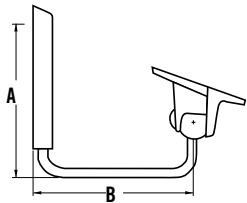

	20.5 SERIES	30.0 SERIES	60.0 SERIES	120.0 SERIES	240.0 SERIES
A	7 3/8" 187.3 mm	8 1/8" 206.4 mm	11" 279.4 mm	14 3/4" 347.7 mm	NA
B	7" 177.8 mm	9 3/4" 247.7 mm	10 3/4" 273.1 mm	15 3/8" 390.5 mm	14 1/2" 368.3 mm
C	3 1/8" 79.4 mm	3 1/8" 79.4 mm	4 7/8" 123.8 mm	6" 152.4 mm	NA

WBX

WB EXTENDED DISTANCE FROM WALL TO SPEAKER

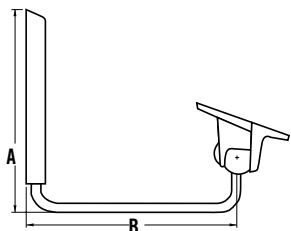

CBX-PA

VERTICAL PIPE TO TOP OR BOTTOM OF SPEAKER (HORIZONTAL SURFACE) EXTENDED DISTANCE FROM PIPE TO SPEAKER

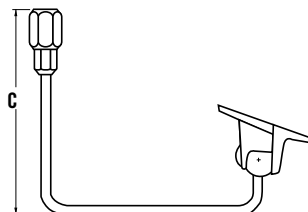

	10.0 SERIES	30.0 SERIES	60.0 SERIES	120.0 SERIES	240.0 SERIES
A	7 1/4" 184.2 mm	14" 355.6 mm	14" 355.6 mm	14 3/4" 347.7 mm	20 3/8" 517.5 mm
B	7 1/4" 184.2 mm	14 3/4" 374.7 mm	18" 457.2 mm	18 5/8" 473.1 mm	24" 609.6 mm
C	7 7/8" 200.0 mm	NA	NA	15 3/8" 390.5 mm	22" 558.8 mm

ST
WALL (VERTICAL SURFACE) TO BACK OR SIDE OF SPEAKER (VERTICAL SURFACE) OR CEILING/FLOOR (HORIZONTAL SURFACE) TO TOP OR BOTTOM OF SPEAKER (HORIZONTAL SURFACE)

ST-PA
ST WITH PIPE ADAPTER

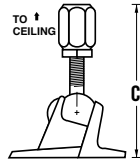

	10.0 SERIES	20.5 SERIES	30.0 SERIES	60.0 SERIES	120.0 SERIES	240.0 SERIES
A	3" 76.2 mm	3 7/8" 98.4 mm	4 5/8" 117.5 mm	6 1/8" 155.8 mm	7" 177.8 mm	11 1/4" 285.8 mm
B	2 7/8" 73.0 mm	3 7/8" 98.4 mm	4 1/2" 114.3 mm	6" 152.4 mm	7" 177.8 mm	10 3/8" 263.5 mm
C	NA	4 3/4" 120.7 mm	5 3/4" 146.1 mm	7 1/4" 184.2 mm	8 1/4" 209.6 mm	12" 304.8 mm
D	NA	1/2" 12.7 mm	1/2" 12.7 mm	1/2" 12.7 mm	3/4" 19.1 mm	1" 25.4 mm

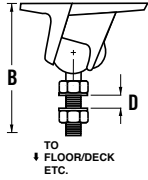

ST-MP
ST WITH MOUNTING PLATE

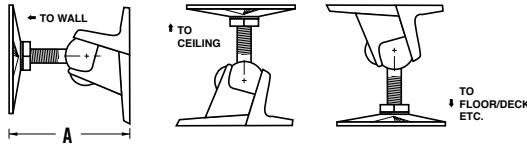

STX
ST EXTENDED LENGTH

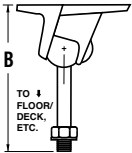

STX-PA
ST WITH PIPE ADAPTER

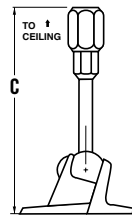

	10.0 SERIES	20.5 SERIES	30.0 SERIES	60.0 SERIES	120.0 SERIES	240.0 SERIES
A	4 1/8" 104.8 mm	6 5/8" 168.3 mm	7 1/8" 181.0 mm	9 1/2" 241.3 mm	12 1/2" 317.5 mm	16" 406.4 mm
B	4 1/8" 104.8 mm	6 1/2" 165.1 mm	7" 177.8 mm	9 3/8" 238.1 mm	12 1/2" 317.5 mm	15" 381 mm
C	4 3/4" 120.7 mm	7 1/2" 190.5 mm	8 1/4" 209.6 mm	10 1/2" 266.7 mm	13 3/4" 349.3 mm	16 7/8" 428.6 mm
D	1 3/16" 30.2 mm	1 3/4" 44.5 mm	2 1/16" 52.4 mm	2 5/8" 66.7 mm	3 7/16" 88.9 mm	4 1/4" 111.1 mm

STX-MP
ST WITH MOUNTING PLATE

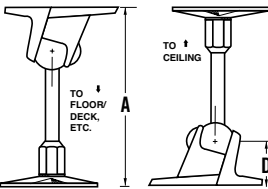

ADAPTERS, ACCESSORIES AND SPECIAL MODELS

C-CLAMPS

C-Clamp Adapter:
Provides a specialized solution for affixing OmniMount supported devices to a horizontal tubular structure, such as a truss or theatrical lighting grid.

10.0 Series

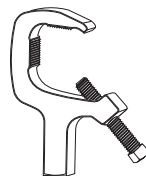

OmniMount ballshaft attaches here

20.0, 20.5, 30.0 Series

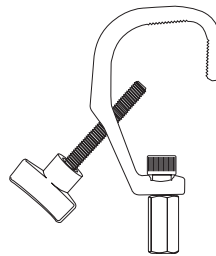

OmniMount ballshaft attaches here

60.0 Series

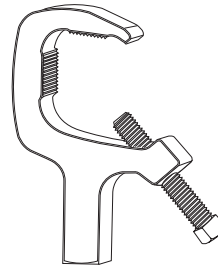

120.0 Series

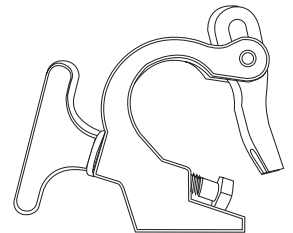

OmniMount ballshaft attaches here

NEW MODEL	UNIT	PREVIOUS MODEL NAME
10.0 C-CLAMP	EA	25 SERIES C-CLAMP
20.0 C-CLAMP	EA	53 SERIES C-CLAMP
20.5 C-CLAMP	EA	50 SERIES (RST/RWX)

NEW MODEL	UNIT	PREVIOUS MODEL NAME
30.0 C-CLAMP	EA	75 SERIES C-CLAMP
60.0 C-CLAMP	EA	100 SERIES C-CLAMP
120.0 C-CLAMP	EA	300 SERIES C-CLAMP

CLAMP ASSEMBLY

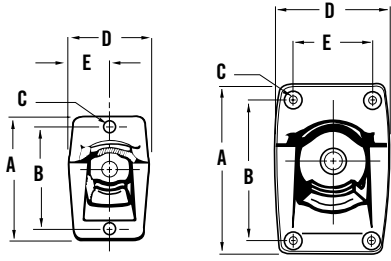

	10.0 SERIES 2 HOLE	20.0 SERIES 2 HOLE	20.5 SERIES 2 HOLE	30.0 SERIES 4 HOLE	60.0 SERIES 4 HOLE	120.0 SERIES 4 HOLE	240.0 SERIES 4 HOLE
A	2 13/16" 71.4 mm	3 5/8" 92.0 mm	3 5/8" 92.0 mm	4 7/8" 123.8 mm	6" 152.4 mm	8" 203.2 mm	10 3/4" 273.1 mm
B	2 3/8" 60.3 mm	3" 76.2 mm	3" 76.2 mm	4 1/4" 107.9 mm	5" 127.0 mm	6 7/8" 174.6 mm	9 1/2" 241.3 mm
C	1/4" 6.4 mm	1/4" 6.4 mm	1/4" 6.4 mm	1/4" 6.4 mm	5/16" 7.9 mm	3/8" 9.5 mm	1/2" 12.7 mm
D	1 5/8" 41.3 mm	2 3/16" 55.6 mm	2 3/16" 55.6 mm	2 15/16" 74.6 mm	4" 101.6 mm	5" 127.0 mm	7" 177.8 mm
E	13/16" 20.6 mm	1 3/32" 27.8 mm	1 3/32" 27.8 mm	2" 50.8 mm	2 3/4" 69.9 mm	3 1/2" 87.3 mm	5" 127.0 mm

WALL BRACKETS/COVERS

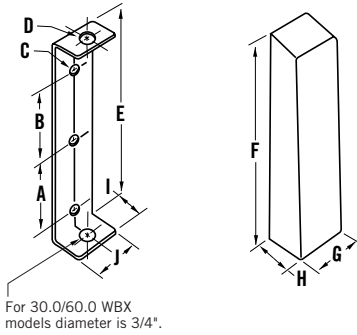

	20.5 - 30.0 SERIES	60.0 SERIES	120.0 SERIES
A	2 1/8" 53.9 mm	3 5/16" 84.1 mm	4 11/16" 119.1 mm
B	2" 50.8 mm	3" 76.2 mm	4 9/16" 115.9 mm
C	5/16" 7.9 mm	3/8" 9.5 mm	3/8" 9.5 mm
D	7/16"-1/2" 11.1 mm-12.7 mm	5/8" 15.9 mm	1" 25.4 mm
E	5 7/16" 138.1 mm	8 1/4" 209.6 mm	11 1/4" 285.8 mm
F	6 3/16" 157.2 mm	9 1/4" 235.0 mm	12 7/16" 315.9 mm
G	1 13/16" 46.0 mm	2 1/8" 54.0 mm	2 1/8" 54.0 mm
H	1 1/8" 28.6 mm	1 3/8" 34.9 mm	2 1/4" 57.2 mm
I	1 1/16" 27.0 mm	1 1/4" 31.8 mm	2 1/8" 54.0 mm
J	1 5/8" 41.3 mm	2" 50.8 mm	2" 50.8 mm

MOUNTING PLATES (MP) - CAST

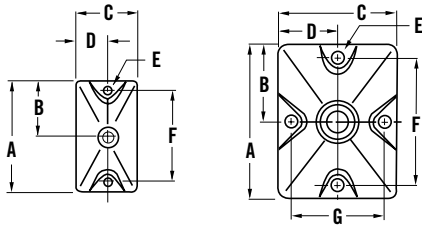

	10.0 SERIES 2 HOLE	20.5 SERIES 2 HOLE	30.0 - 60.0 SERIES 4 HOLE	120.0 SERIES 4 HOLE	240.0 SERIES*
A	2 7/8" 73.0 mm	3 3/16" 81.0 mm	4 1/4" 108.0 mm	6 7/8" 174.6 mm	12" 304.8 mm
B	1 7/16" 36.5 mm	1 19/32" 40.5 mm	2 1/8" 54.0 mm	3 7/16" 87.3 mm	NA
C	1 1/2" 38.1 mm	2 1/4" 57.2 mm	3 5/16" 84.1 mm	4 7/8" 123.8 mm	12" 304.8 mm
D	3/4" 19.1 mm	1 1/8" 28.6 mm	1 5/8" 41.3 mm	2 7/16" 61.9 mm	NA
E	1/4" 6.4 mm	1/4" 6.4 mm	5/16"-3/8" 7.9 mm-9.5 mm	3/8" 9.5 mm	NA
F	2 3/8" 60.3 mm	2 9/16" 65.1 mm	3 1/2" 88.9 mm	5 3/4" 146.1 mm	NA
G	NA	NA	2 5/8" 66.7 mm	4" 101.6 mm	NA

*Note: Mounting plate for 240.0 Series is designed differently from example shown. (Please call for details.)

MOUNTING PLATES (MP) - STAMPED

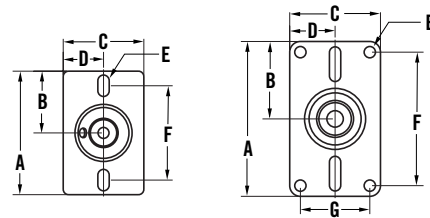

	10.0 SERIES 2 HOLE	20.0 SERIES 4 HOLE
A	2 7/8" 73.0 mm	3 5/8" 92.0 mm
B	1 7/16" 36.5 mm	1 13/16" 46.0 mm
C	1 7/8" 47.6 mm	2 1/8" 53.9 mm
D	15/16" 23.8 mm	1 1/16" 27.0 mm
E	1/4" X 1/2" 6.4 mm X 12.8 mm	1/4" 6.4 mm
F	2 3/16" 55.6 mm	3 1/8" 79.3 mm
G	NA	1 5/8" 41.3 mm

BALLSHAFT



All thread sizes U.N.F.

THREAD SPECIFICATIONS

5.0 SERIES	10.0 SERIES	20.0 SERIES	20.5 SERIES	30.0 SERIES	60.0 SERIES	120.0 SERIES	240.0 SERIES
4 mm – 5 mm	1/4" – 20	3/8" – 16	7/16" – 20	1/2" – 20	5/8" – 18	1" – 14	1 1/2" – 12

Exceptions and Variations
 10.0 WBX/CBX – 7/16" – 20
 30.0 WBX/CBX – 3/4" – 16
 60.0 WBX/CX – 3/4" – 16

SHAFT OUTSIDE/INSIDE DIAMETER

	5.0 SERIES	10.0 SERIES	20.0 SERIES	20.5 SERIES	30.0 SERIES	60.0 SERIES	120.0 SERIES	240.0 SERIES	SPECIAL
A	5 mm	1/4"	3/8"	7/16"	1/2"	5/8"	1"	1 1/2"	3/4"
B	NA	NA	NA	11/32"	13/32"	15/32"	27/32"	1 11/32"	5/8"

Exceptions and Variations
 10.0 WBX/CBX – 7/16"
 30.0 WBX/CBX – 3/4" – 1/2"
 60.0 WBX/CX – 3/4" – 1/2"

TA THREAD ADAPTERS

EXTENDS BALLSHAFT LENGTH USING ALL-THREAD ROD

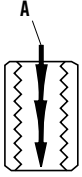

PA PIPE ADAPTERS

EXTENDS BALLSHAFT LENGTH USING STANDARD PIPE AVAILABLE AT HARDWARE OR PLUMBING SUPPLY STORES

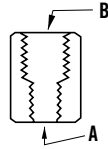

	10.0 SERIES	20.5 SERIES	30.0 SERIES	60.0 SERIES	120.0 SERIES	240.0 SERIES
A	1/4" – 20	7/16" – 20	1/2" – 20	5/8" – 18	1" – 14	1 1/2" – 12
B	NA	1/2"	3/4"	3/4"	1 1/2"	2"

Exceptions and Variations
 10.0 WBX/CBX – use 20.0 TA/20.0 PA adapters.
 PA adapters not available for 10.0 Series models.
 30.0 WBX/CBX and 60.0 WBX/CBX – require 3/4" – 16TA adapters.
 PA adapters are not available for these mounts.

VIBRATION ISOLATORS

Ceiling Vibrator Isolator:

Ideal for suspended ceiling installations, this double deflection isolator incorporates rubber components and isolating spring. It is typically fastened between two lengths of threaded rod. One length extends upward and is affixed to the structural ceiling. The other length extends downward, coupling to the OmniMount assembly.

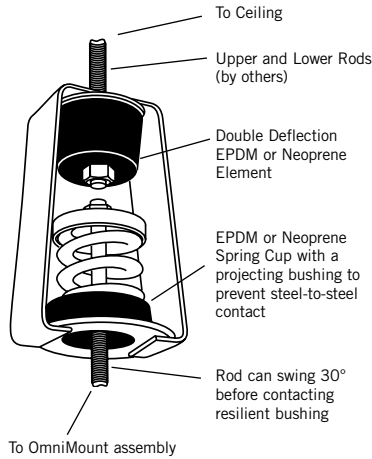

Wall Vibrator Isolator:

This type of isolator is installed between the mounting surface and the OmniMount assembly. It can be fastened to wall brackets, mounting plates and clamp assemblies.

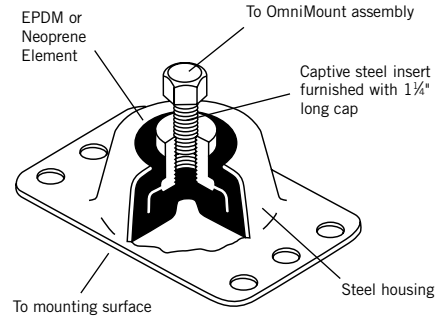

NEW MODEL	UNIT	PREVIOUS MODEL NAME
60.0 ISO-WALL	EA	ISO-100-W
60.0 ISO-CEILING	EA	ISO-100-C

STRUT MEMBER KIT

Strut Member (SM):

36" unistrut member – long enough to traverse three wall studs. Used for wider load distribution on wall surface. (Available in black only.)

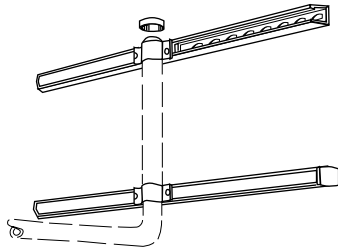

NEW MODEL	UNIT	PREVIOUS MODEL NAME
120.0 SM KIT	EA	SM KIT/300 SERIES
240.0 SM KIT	EA	SM KIT/500 SERIES
120.0 WA-SM*	EA	300 WA-SM*
120.0 WB-SM*	EA	300 WB-SM*
120.0 WBX-SM*	EA	300 WBX-SM*
240.0 WB-SM*	EA	500 WB-SM*
240.0 WBX-SM*	EA	500 WBX-SM*

*SM kit is included in the price of these models.

SPECIAL ADAPTERS:

- Microphone Stand:** 3/8"-27 female thread adapts 10.0 Series and 20.0 Series models only.
 - Tubular Tripod Stand:** Two sizes available – 1 1/2" diameter and 1 3/4" diameter. For use with models 60.0 ST and 60.0 STX only.
 - C-Clamp:** Adapter is for use with C-Clamps used for theatrical lighting fixtures. Must have either a 1/2"-13 stud or through-hole access for a 1/2" diameter bolt. Available for 60.0 Series models only.
 - T-Bar Ceiling Adapters:** For mounting objects on acoustic tile suspended ceilings.
- Many special accessories are available such as: Quick-Release Handles (10.0 and 20.0 Series only),

Pole Mount Adapters, Safety Cables, Vibration Isolators, Shelving Kits and Stud Member Kits that allow load distribution across three wall studs (120.0 and 240.0 Series only). Contact your OmniMount Systems Sales Representative directly for more information.

NOTE: On the following pages, for simplicity, some illustrations may not be to scale. Specifications are subject to change without prior notice. Contact factory directly to verify critical dimensions. Every effort has been made to provide accurate dimensions and specifications. OmniMount Systems, Inc. cannot be held responsible for any errors or omissions.



OmniMount Systems, Inc.

The Pointe at South Mountain
 8201 South 48th Street
 Phoenix, Arizona 85044-5355
 1-800-MOUNT-IT www.omnimount.com