

Installation Instructions

PMD.5 PRO - PMD1 PRO - PMD2 PRO: Universal Projector Mounts



Universal Mounting Grid
Superior Mounting Flexibility
Adjustable Ceiling Pipe Drop
User Friendly Adjustments

IMPORTANT: To utilize the PMD projector mount, the projector must have mounting lands (threaded inserts) on the base. Contact OmniMount if you have any questions regarding the proper installation of this projector mount system.

Questions? 1-800-MOUNT IT

Thank you for purchasing an OmniMount product.

Warranty: Limited Lifetime on manufacturing defects and workmanship.

Specifications are subject to change without prior notice.

Every effort has been made to provide accurate and error-free assembly and installation. OmniMount Systems disclaims liability for any difficulties arising from the interpretation of information contained in these instructions. If OmniMount products are used for purposes other than their original intent, OmniMount, its distributors and retailers shall not be held responsible or liable for injuries or property damage, direct, indirect, or consequential, which may arise from the inability to use this product safely, properly, and in the manner for which it has been designed and manufactured. Warranty does not apply to products which have been lost, damaged by misuse, abuse, or accident.

OmniMount Systems, Inc.
8201 South 48th Street • Phoenix, AZ 85044-5355
1-800-MOUNT-IT • www.omnimount.com

Models: PMD.5 — PMD1 — PMD2

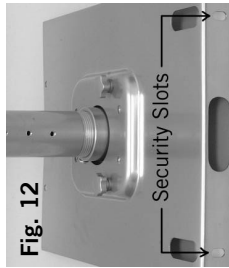
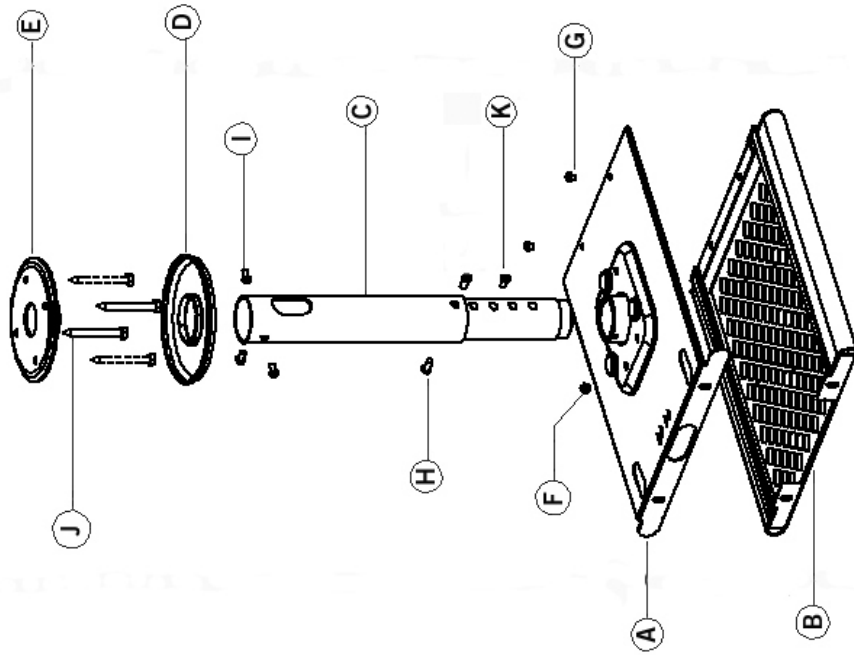

Fig. 12
Always secure projector plates by installing 3/8" screws (G) into holes on front edge of plates. Additional security can be provided by installing small padlocks through security slots at the rear of the projector plates. (Fig. 12)

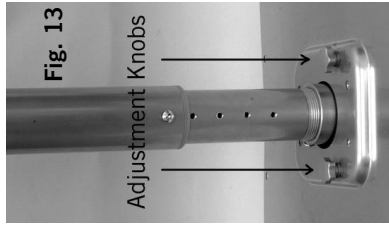

Fig. 13
Attach cables to the projector. Turn projector ON, and make pitch and keystone adjustments as per the projector manufacturers instructions. For additional pitch/tilt, use the three adjustment knobs on top of the PMD mount (Fig. 13).



Fig. 14
Wall Mounting with OmniMount PMD-WM

Install the OmniMount PMD-WM wall mount to the wall as per the instructions. (Fig. 14)



Separate top and bottom projector mounting plates (A&B), by sliding them apart. (Fig. 2)



Loosely thread top projector mounting plate (A) onto threaded portion of wall mount coupler. (Fig. 15 & 16)



Thread 1/4" hex head set screw (F) into side of pipe collar, on top projector mounting plate (A). (Fig. 17)
Note: If necessary, screw in tilt knob to gain access to the set screw hole.

Position top projector mounting plate into desired orientation (horizontal or vertical), and then tighten set screw (F).

Proceed to **Step 4** to complete the installation.

Part	Description	Qty.
	Mount Assembly Hardware	
A	Top Projector Plate	1
B	Bottom Projector Plate	1
C	Pipe Drop Assembly	1
D	Plastic Cover	1
E	Ceiling Plate	1
F	Hex Screw: 1/4" -20 X 1/4"	1
G	Screw: 1/4" -20 X 3/8"	2
H	Hex Screw: 1/4" -X 5/8"	4
I	Hex Screw: 1/4" -X 1/2"	6
J	Lag Bolt: 5/16" X 3"	4
K	Plastic Plugs	14
	Hex Wrench	1

Place a large washer (1) over mounting screw, and then insert screw through grid at marked location. (Fig. 8)



Fig. 8

Lift the projector mounting plate and place a second large washer (1) onto the end of the screw, followed by a metal spacer (2). Loosely thread (2-3 turns) screw assembly into the chosen threaded insert on the bottom of the projector. (Fig. 9)



Fig. 9

Repeat this procedure for the remaining threaded inserts. (Fig. 10)

Note: A 1" plastic spacer (3) is included for projectors with uneven mounting surfaces. Trim the plastic spacer to the required length, and install on appropriate mounting screw.

Once all mounting screws have been installed, square up the projector mounting plate, and then tighten the mounting screws securely.

Caution: Do not force or over tighten the mounting screws, or damage to the projector may occur.

Step 5

Slide the bottom projector mounting plate onto the previously installed top projector mounting plate. (Fig. 11)

Note: Make sure that the cables don't get pinched while sliding the plates together.



Fig. 11

Part	Projector Mounting Hardware	Qty.	Bag
1	Large Washer	8	(a)
2	Metal Spacer: 3/8"	4	(a)
3	Plastic Spacer: 1"	1	(b)
	PMD-5 /PMD-1		
4	Screw: 5mm x 25mm	4	(c)
	Screw: 6mm x 25mm		
5	Screw: 4mm x 25mm	4	(c)
	Screw: 5mm x 25mm		
6	Screw: 3mm x 25mm	4	(c)
	Screw: 4mm x 25mm		

Hardware Bags



Step 1

With an electronic stud finder, locate center of ceiling stud in desired mounting location. Unscrew ceiling plate (E) from Projector Mounting top plate (A). Use ceiling plate as a template, and mark mounting hole locations. Drill mounting holes to a depth of 3" using a 3/16" drill bit. Mount ceiling plate to stud with 5/16" lag bolts (J).

Step 2

Determine type of installation:

- Standard Ceiling Mount
- Extended Ceiling Mount
- Flush Mount
- Wall Mount

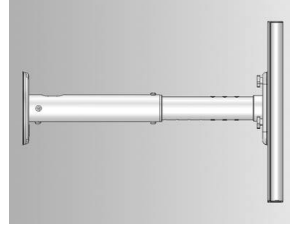

Standard Ceiling Mount

Press plastic cover (D) into place over ceiling plate. Attach pipe drop assembly (C) to ceiling plate with three 5/8" hex screws (H).

Note: Orient the cable management port on the pipe drop assembly so that it faces the projector cable drop.

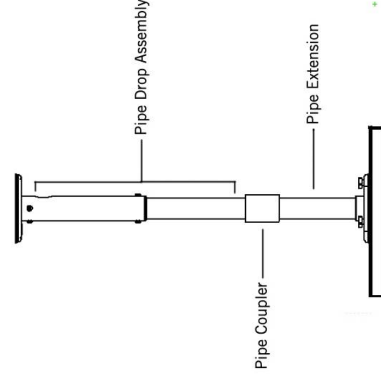

Extended Ceiling Mount

For installations that require a ceiling drop in excess of 18", standard 1 1/2" pipe may be used to extend the standard pipe drop assembly.

Pipe extension should be cut to the required additional length, threaded on both ends, and then attached to the standard pipe drop assembly with a pipe coupler (not supplied).

Note: Orient the cable management port on the pipe drop assembly so that it faces the projector cable drop.

Flush Ceiling Mount

Proceed to step 3.

Note: Plastic cover is not used for flush mount.



Wall Mount

With the addition of the OmniMount PMD-WM wall mount (sold separately); the PMD can be mounted to a wall instead of the ceiling. This is particularly useful for small conference/classrooms where a ceiling mount is impractical. For details, see section at end of manual, titled **Wall Mounting with OmniMount PMD-WM**.

Step 3

Gently pull the extension tube of the pipe drop assembly down to the required projector height. Rotate extension tube so that adjustment screw holes are visible through the support tube. (Fig. 1)

Secure the pipe position by installing 1/2" long hex screws (I) into adjustment screw holes. For a cleaner appearance, insert plastic plugs (K) into unused holes on extension tube.

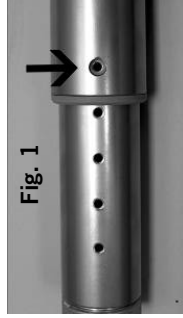

Fig. 1



Fig. 2

Separate top and bottom projector mounting plates (A&B), by sliding them apart. (Fig. 2)

Thread 1/4" hex head set screw (F) into side of pipe collar, on top projector mounting plate (A). (Fig. 3)

Note: If necessary, screw in tilt knob to gain access to the set screw hole.



Fig. 3



Fig. 4

Loosely thread top projector mounting plate (A) onto threaded portion of pipe drop.

Position top projector mounting plate into desired orientation (horizontal or vertical), and then tighten set screw (F). (Fig. 4)



Fig. 5

Thread cable bundle through cable management port at top of pipe assembly, down through the pipe assembly, and then out through the cable management port on the rear of the projector mounting plate. (Fig. 5) (Standard ceiling mount only) Be sure to leave enough cable to reach the mounted projector.

Flush Ceiling Mount

For flush ceiling mount, loosely thread top projector mounting plate directly onto threaded portion of ceiling plate.



Step 4

Determine required mounting screw size (4, 5 or 6 mm) for projector.

Note: Consult projector owners' manual for screw sizes and mounting holes.

Lay projector on table with mounting surface face up. Place grid section of bottom projector mounting plate onto top of projector in desired mounting orientation (horizontal or vertical). (Fig. 6)

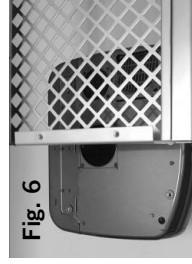

Fig. 6



Using a pencil or felt tipped pen, mark the locations of the projector's threaded inserts onto the grid for reference. (Fig. 7)

Fig. 7