



**MELANGE PLUS**  
**MEMORY LIGHTING CONTROLLER**

Software Revision 3.01

**OPERATION MANUAL**

**MELANGE PLUS**  
**MEMORY LIGHTING CONTROLLER**  
**OPERATION MANUAL**

Software Revision 3.01 Preliminary

Document Revised: 5/20/97

Copyright 1997

NSI CORPORATION

Wilsonville, OR

---

## Table of Contents

---

### Installation / Setup

---

Power Supply Requirements .....	5
Dimmer equipment connection .....	5
Monitor Connection .....	5
Configuration .....	5

### Overview

---

Front Panel .....	6
Rear Panel .....	7

### Quick Operation Guide

---

Power Switch .....	8
Grand Master Fader. ....	8
Lighting Level Entry. ....	8
Recording Lighting Cues. ....	9
Play back lighting cues .....	10
Edit lighting cues .....	10
Submaster pages .....	12
Submaster Chases .....	12
Submaster Cues. ....	13

### Detailed Operation Guide.

---

Lighting Level Entry. ....	14
Cue Recording .....	18
Cue Playback .....	21
Manual Crossfaders .....	23
Editing Cues Levels. ....	24
Blind Editing .....	24
Blind Cue Creation. ....	25
Editing cue parameters .....	26
Deleting Cues. ....	26
Copying cues. ....	26
Renumber Cues .....	27
Submasters .....	28
Submaster Pages. ....	29
Submaster Chases. ....	30
Recording Chases. ....	30
Submaster Cues. ....	31

Softpatch .....	32
-----------------	----

## Macros

---

Keyboard Macros .....	33
External Macros .....	34

## Input / Output

---

Overview .....	35
RS-232 port. ....	35
MIDI port .....	40
Printer Operation. ....	42

## ASCII Cues Implementation

---

Overview .....	44
----------------	----

## MIDI Implementation

---

MIDI Chart .....	46
MIDI cues .....	47

## Configuration

---

Memory Allocation .....	48
Console Configuration .....	48

## Audio Operation

---

Audio Sync .....	50
------------------	----

## Sample Printer Reports

---

Cue List .....	51
Cue Detail .....	52
Soft Patch List .....	53
Submaster Page Detail .....	54
Chase Detail .....	55
Macro Detail .....	56

## Additional Dimmer Protocols

---

AMX-192 .....	57
DMX-512 Input. ....	57

## Specifications

---

Console Specifications .....	58
------------------------------	----

## Service Information

---

Schematics .....	59
------------------	----

## Warranty

---

NSI Corporation Limited Warranty .....	60
--	----

# 1

## Installation / Setup

### Power Supply Requirements

The Melange lighting controller requires a source of 15 volts DC (500 ma) in order to operate satisfactorily. Use the power supply provided

### Dimmer equipment connection

Connecting the Melange lighting controller to NSI dimming equipment is very simple. You need only connect a single 3 conductor audio cable (standard microphone cable equipped with a 3-pin XLR type connector) to either of the jacks marked MICRO-PLEX on the rear apron of the console. It doesn't matter which jack is used, two jacks are provided for convenience. Connect the other end of the cable to the NSI dimming equipment. NSI's Micro-plex is capable of supporting 128 dimmer channels. If more channels are necessary for the particular installation, then the DMX-512 protocol must be used. See section on Dimmer Protocols for other protocols that may be supported.

Connection to DMX-512 dimming equipment is accomplished via the 5 pin connector located on the rear apron of the console. This connector adheres to the USITT standard on DMX-512 and will support 512 dimmer channels with one three wire cable. Since remote power is not provided on this connector, the power supply included with the console must be used.

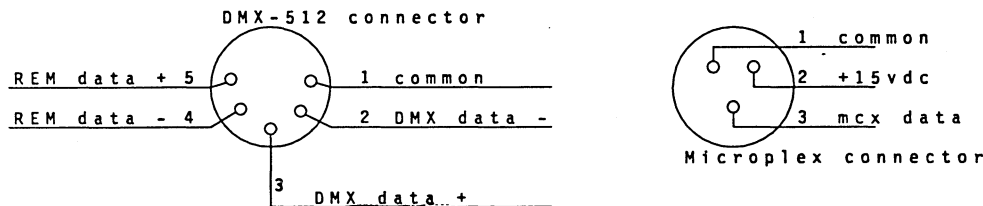

NOTE: REM data is for optional house lighting

### Monitor Connection

The Melange lighting controller is designed to be used with a standard VGA color monitor that includes a 15 pin type connection. A "composite video" type of connection will not work. In addition the monitor should have external adjustments for Height and Width to insure compatibility with the Melange.

Connect the 15 pin monitor connector to the jack marked VIDEO on the rear apron of the console. A suitable monitor may be provided with the Melange or is available from your dealer.

### Configuration

The Melange is a highly flexible memory console which can adapt to many installations. As it is shipped from the factory, the Melange is set for immediate usage at factory default settings. If this is the first time the console is being used, please refer to the section of this manual on CONFIGURATION for factory default settings and possible changes you may want to make.

001 002 003 004 005 006 007 008 009 010 011 012 013 014 015 016 017 018 019 020 021 022 023 024 025 026 027 028 029 030 031 032 033 034 035 036 037 038 039 040 041 042 043 044 045 046 047 048 049 050 051 052 053 054 055 056 057 058 059 060 061 062 063 064 065 066 067 068 069 070 071 072 073 074 075 076 077 078 079 080 081 082 083 084 085 086 087 088 089 090 091 092 093 094 095 096 097 098 099 100

## 2

## Overview

### Front Panel

1. *Submaster Controls* These 8 sliders may be assigned to control memory lighting or chase effect levels. Channels affected by each submaster will combine with the greatest level having precedence.
2. *Submaster Bump Buttons* These 8 buttons normally cause the associated submaster to go immediately full on. They also are used for submaster recording and assignment, and for chase rate control when a chase is assigned to a submaster.
3. *Submaster Load Button* This button is used for loading submasters with paged memory, changing pages, and assigning chases or cues to submasters. It is also used to activate the channel window function for adjusting lighting levels.
4. *Submaster Cancel button* This button is used for clearing any or all submasters, or deactivating the channel window feature.
5. *Toggle Submaster Button* This button is used for assigning a momentary or a toggle action to submaster bump buttons.
6. *Solo Submaster Button* This button is used to place submasters in a solo mode. Any light levels currently on will fade out as the submaster level is increased. This works with chases as well.
7. *A and B Crossfader Controls* These controls may be assigned to cues. Slider A is at maximum when fully up, while slider B is at maximum when fully down. Cue numbers automatically advance and reload as controls are moved up and down together permitting semi-automatic crossfading.

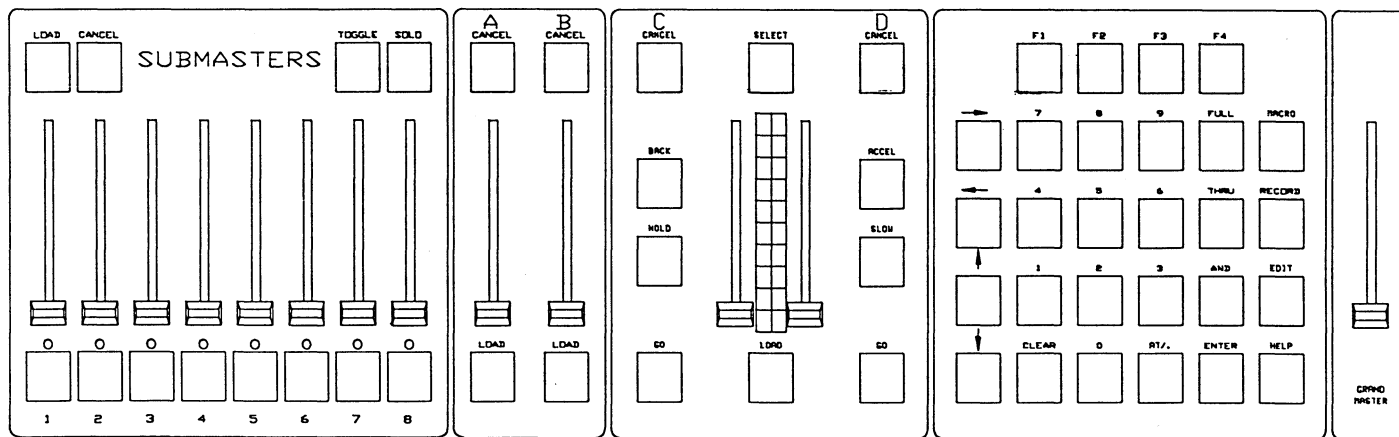

8. *A and B Crossfader Load Buttons* These buttons are used to load cue numbers into either the A or B crossfader.
9. *A and B Crossfader Cancel Buttons* These buttons are used to clear any cues loaded into the A or B crossfaders. These buttons must be held for 1 second to operate.
10. *Autofader Load Button* This button is used to load either autofader C or D. The fader chosen is indicated by the star in the Crossfader Status window.
11. *C and D Autofader Go Buttons* These buttons start the crossfade of the cue loaded into the C or D autofader respectively.
12. *C and D Autofader Cancel buttons* These buttons will clear any cues loaded into crossfader C or D. These buttons must be held for 1 second to operate.



- 13. *Autofader Select button* This button will select either C or D autofader for loading or display on the LED ladders. The star on the display indicates the selection.
- 14. *Autofader LED ladder* This display indicates the progress of the C or D autofader, whichever is selected.
- 15. *Accel and Slow buttons.* These buttons are used to increase, decrease or stop the speed of the C or D autofade in progress.
- 16. *Autofade Override* These sliders are used to take control of the current autofader selected.
- 17. *Hold Button* This button is used to stop the currently selected autofad.
- 18. *Back Button* This button is used to reverse the currently selected autofade.
- 19. *Cursor Control Buttons* These buttons control the cursor placement on the CRT display and serve as increment change keys for levels and other data.
- 20. *Function Keys* These keys change function as necessary. The name of the current functions for each key appears at the bottom of the display.

---

## Rear Panel

- 1. *Power Switch* Used to turn console power off and on.
- 2. *Optional I/O* An option for an AMX-192 4 pin connector output or DMX-512 **Input** may be installed here. Other options may be available, contact your NSI Dealer for details.
- 2. *DMX-512 connector* USITT standard 5 pin connector for output of DMX-512 multiplex to dimmers.
- 3. *External Macro Inputs* This connector allows access to eight of the console's macros.
- 4. *Micro-plex connectors* These are 3 pin "XLR" type microphone connectors which transmit NSI micro-plex to NSI dimmers.
- 5. *MIDI in/out/thru connectors* These connectors allow for connection of the Melange to the many types of MIDI products.
- 6. *Printer port* This is a 25 pin parallel type of printer port connector.
- 7. *Audio input* This RCA type phono jack accepts audio levels from 100mv to 10volts.

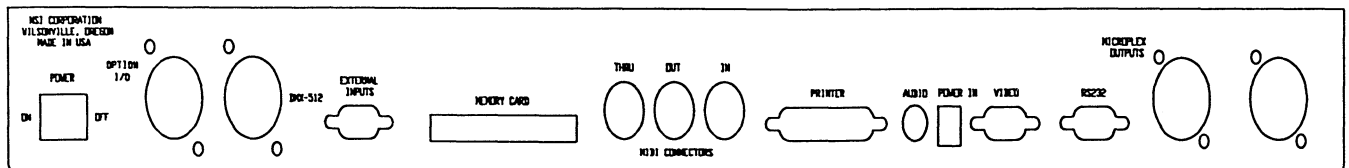

- 8. *Video Output* This must be connected to a "VGA" type color monitor.
- 9. *Power Input* This input must be connected to the Power Supply supplied with the console.
- 10. *RS-232 connector* This connector will connect to a mouse, trackball, or a computer.

### 3

## Quick Operation Guide

**NOTE:** Some of the more advanced features of the Melange are passed over on purpose in this section in order to give the operator a quick lesson in basic operation.

### Power Switch

#### Submaster Status Window

#### Channel Level Display

The Melange lighting controller has a power switch located on the rear apron of the unit. When first turned on, the Melange will automatically perform a quick self test. The front panel LEDs will light momentarily and the console will beep twice indicating a successful

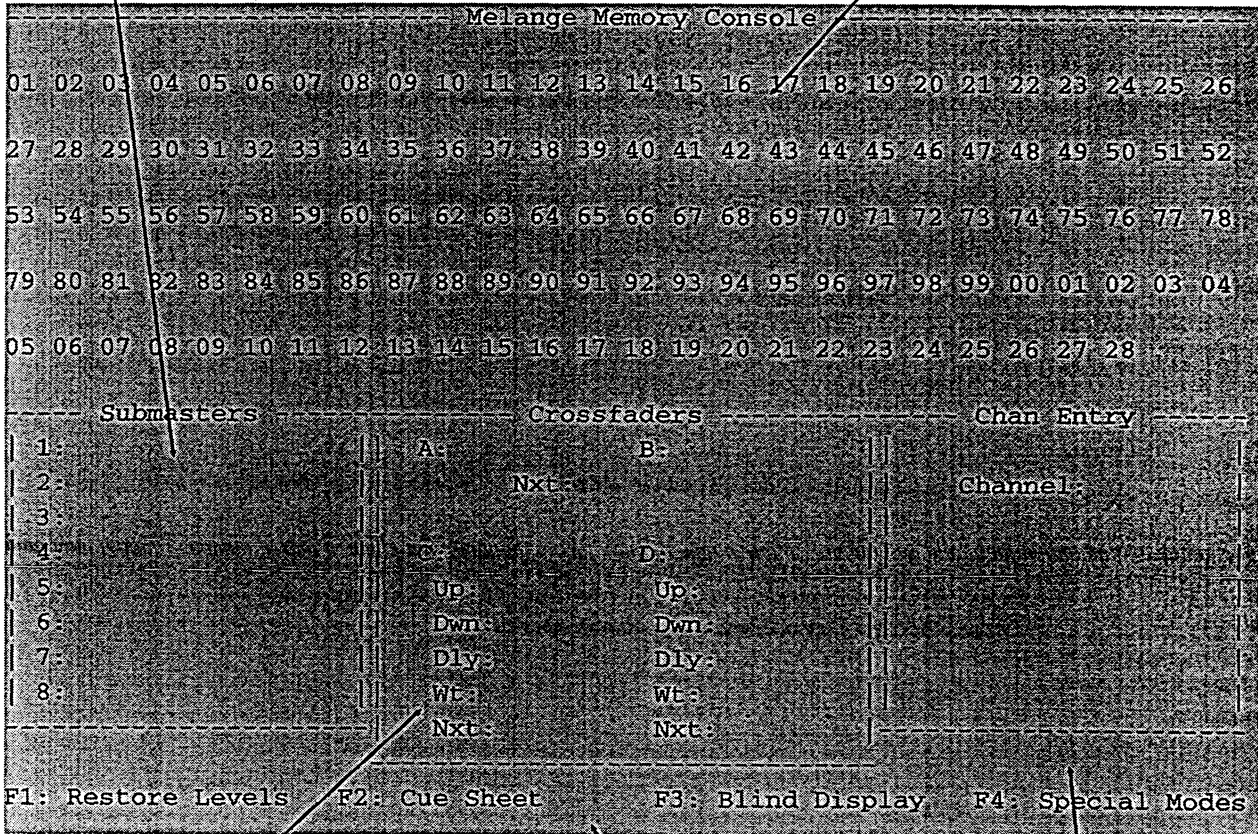

will appear for a few moments. The main display will now show on the screen.

### Grand Mast

#### Crossfader Status Window

#### Data Entry Window

er Fader.

#### Function Key Labels

The Grand Master Fader controls all output to stage and lighting levels displayed on the screen. For this reason it is recommended to make sure the Grand master is at maximum whenever lighting levels are being recorded or modified.

The letters "GM" will show red at the upper right hand corner of the CRT display whenever the Grand Master is set below maximum.

### Lighting Level Entry.

In order to record lighting levels into the Melange's memory, the operator must become astute at entering lighting levels into the console as required. One way to enter the lighting levels is directly with the keypad using channel level equations:

- With the data entry line prompting for "channel" enter the starting channel number desired.
- To indicate a continuous block of channels to be set to the same level, press the THRU key followed by the last channel number of the block.
- To indicate another channel or block of channels to be set to the same level, press the AND key followed by the next channel number.
- To enter the intensity of the selected channels, press the AT key followed by the desired intensity in percent (00 to 99, two digits), or if the intensity is to be 100% press the FULL key.
- Intensity level may be adjusted at this point by using the UP ARROW or DOWN ARROW keys, or by pressing CLEAR and entering a new number.
- To end the equation, press the enter key and continue entering channel level equations.

→ **EXAMPLE: To set channels 1 through 20 and 28 at 8%:**  
→ **Enter 1 and press the THRU key.**  
→ **Enter 20 and press the AND key.**  
→ **Enter 28 and press the AT key.**  
→ **Enter 8 and press the ENTER key.**

With the GRAND MASTER set at maximum, the intensity levels entered will appear on stage for inspection.

**NOTE: Several features have been incorporated in order to make it easy to manipulate many different channel levels. For more detailed information see Lighting Level Entry under Detailed Operation in the next section.**

*Editing Cue  
Times*

To edit or modify cue times, follow these steps.

1. Press the Edit button, then select the F1: EDIT TIMES function key.
2. Enter the cue number to modify and press enter.
3. Enter new times and hit ENTER or just hit return to accept old value as each time is displayed.
4. Press the F2: SAVE function key to save changes.

→ *EXAMPLE: Modify fade time of cue 20 to 10 seconds.*

→ *Press EDIT button.*

→ *Press the F1: EDIT TIMES function key.*

→ *Enter 20 on the keypad and press ENTER*

→ *Console prompts for up time, enter 10, press ENTER.*

→ *Console prompts for down time, enter 10, press ENTER.*

→ *Console prompts for delay time, press ENTER.*

→ *Press F2: Save to save changes*

## Play back lighting cues

To playback lighting cues follow these steps.

1. Press the LOAD button.  
The monitor will now highlight the "Nxt" position under the C crossfader display.
2. Enter the desired cue number.  
The first cue number in your sequence of cues is entered here.
3. Press the GO button.  
The GO button located on the front panel under the "C" auto fader controls will cause the desired cue to be executed. The lighting levels programmed into the cue will fade in at the preset fade rate and the next cue in sequence will appear in the "nxt" position on the monitor.
4. Execute following cues.  
Press the GO button to execute following cues as necessary.  
→ *EXAMPLE: Playback cue 20 and following cues.*  
→ *Press the AUTOFADER LOAD button.*  
→ *Enter 20 and press the ENTER key.*  
→ *Press the GO button under autofader C.*  
→ *When ready for next cue, press the GO button again.*

## Edit lighting cues

To edit or modify lighting cue levels, follow these steps.

1. Load and playback the lighting cue desired and make lighting level changes as necessary, or create a new set of lighting levels. Since all stage levels as displayed on the screen will be recorded into the modified cue, make sure that all other lighting levels such as submasters are set to minimum and the GRAND MASTER is set to full.
2. Press the EDIT button, then select the F2: EDIT LEVELS key. The console will now prompt for a cue number.
3. Enter the cue number to modify, then press the ENTER key.
4. Press F2: SAVE when done to save the new levels into memory.  
→ *EXAMPLE : Edit levels of cue 20.*  
→ *Set Grand Master at full and all submasters at minimum.*  
→ *Press the AUTOFADER LOAD button.*  
→ *Enter 20 then press ENTER.*  
→ *Press the GO button under autofader C.*  
→ *Wait for fade to stop.*  
→ *Enter new light levels.*  
→ *Press Edit button.*  
→ *Press the F2: EDIT LEVELS function key.*  
→ *Enter 20 and press ENTER.*  
→ *Press the F2: SAVE function key.*

9. Press F4: CANCEL when done.

**To load chases into submasters.**

1. Press SUBMASTER LOAD button.
2. Press the Submaster bump button of the submaster desired.
3. Press the F1: LOAD CHASE function key.
4. Key in the desired chase number and press Enter. Only the number of chases set at initial memory configuration will be available.
5. Tap the bump button of the selected submaster at the rate desired to set the chase rate.
6. Increase the selected submaster level to playback the chase.

---

## Submaster Cues.

Lighting levels from previously recorded lighting cues may be loaded into individual submasters directly without affecting levels recorded into paged memory.

**To Load a Submaster with a cue.**

1. Press the Submaster Load button.
2. Select the desired submaster by tapping the respective bump button.
3. Using the keypad, enter the cue number desired and press enter. The console will clear the line and beep twice if the cue does not exist.
4. Press ENTER when done.
5. Operate the submaster to playback the cue selected.

---

## Submaster pages

Submasters may be used to store and recall lighting levels directly from paged memory, to recall lighting levels previously stored in a cue, or to store and recall chase effects.

Lighting levels may be stored into a submaster "page". A page consists of lighting levels for all eight submasters. A console may have several pages available if so configured. The number of submaster pages available may have also been set to zero during memory set-up, making paged submasters inaccessible.

### To Record submaster lighting levels into paged memory.

1. Set desired lighting levels as discussed at beginning of this chapter.
2. Press RECORD button.
3. Press F1:PAGE NUM to select submaster page number if necessary.
4. Press Submaster Bump button of desired submaster to store lighting levels into submaster's paged memory.

### To Load submasters from paged memory.

1. Press SUBMASTER LOAD button.
2. The next sequential page number will automatically be displayed at the bottom of the submaster window, Key in the desired page number, if different then the page displayed at the bottom of the submaster window, and press Enter to load the submaster page. Only submasters not loaded with chases or cues will be affected. Submasters that are set above minimum will not be affected until submaster control is set to minimum.
4. Operating submaster controls will cause lighting levels programmed to increase proportionately.

---

## Submaster Chases

Chase sequences may be recorded into memory and then loaded into submasters or cues for playback. This section will discuss how to record chases and how to access chases with submasters.

**NOTE: The availability of the chase feature and size of the chase memory depends on the configuration of the memory during set-up.**

### To Record Chase into memory.

1. Press the RECORD button.
1. Press the F2: RECORD CHASE function key.
2. Select the chase number to record using the F3: CHASE NUM function key. As many as 0 to 99 chases may be available depending on the memory configuration.
3. Notice the highlighted window that appeared below channels 1 - 8 on the CRT screen. Also notice by using the four cursor keys, you can position the window under any channels on the screen.
4. Use the cursor keys to position the window under the desired channels for the first step of the chase.
5. Using the submaster bump buttons to toggle the respective channels above the window on and off, select the channels to be on for the first step of the chase. Move the window as necessary with the cursor keys to select all channels desired. Only these captured channels will be recorded, regardless of other levels on the display.
7. Press the F1: RECORD STEP function key to record this step into memory. The step number will automatically advance.
8. Repeat from (5) above until all steps of the chase are programmed. As many as 1 to 256 steps may be available per chase, depending on memory configuration at set-up.

### *Cursor Keys*

The cursor keys allow any channel levels to be easily adjusted up or down individually or as a group.

To use the cursor keys, enter the desired channel or group of channels as described previously.

- When the console is prompting with "AT", the operator may enter a level and then adjust it using the UP ARROW or DOWN ARROW cursor keys.
- Each press of an UP or DOWN arrow key will result in a 1% change in brightness. Holding down these keys will cause a continuous change until released.
- Existing levels for any single channel, or groups of channels with the same or different intensities, may be adjusted at anytime by entering channel numbers and using the UP ARROW or DOWN ARROW cursor keys.

→ *EXAMPLE: To adjust channel 12 up 4%.*

→ *Enter 12 at the "Channel:" prompt.*

→ *Press the UP ARROW key 4 times and press ENTER to complete.*

- If a group of channels with different levels is specified, then all channels involved will move up or down by 1 percent relative to each other every time an UP or DOWN ARROW button is pressed.

→ *EXAMPLE: To adjust channels 1 through 5 and 12 through 15 up 5%.*

→ *Enter 1 at the "Channel:" prompt and press THRU.*

→ *Enter 5 at the "Thru:" prompt and press AND.*

→ *Enter 12 at the "And" prompt and press THRU.*

→ *Enter 15 at the "Thru" prompt.*

→ *Press the UP ARROW key 5 times and press ENTER to complete.*

### *Channel Window Entry.*

The Channel Window is a fast way to enter or adjust individual channel levels using the submaster sliders. The Channel Window is a highlighted area of the screen representing up to eight submaster sliders. The size of the window will vary according to how many submasters are loaded (cues, pages, etc.). The window will start with Submaster #1 and expand to the right until a loaded submaster is encountered. The window will not appear if Submaster #1 is loaded.

This window can be moved over any sequential channels anywhere on the screen using the four cursor keys. The leftmost submaster slider (number 1) affects the leftmost part of the window and so forth. Whenever the submaster slider level, as appears in the submaster area of the display, matches the associated channel level, the submaster captures the channel and takes control of the level.

The Channel Window can then be moved with the cursor keys at any point to adjust other channels. Once the window is moved, the slider releases control of the channel but the new level set remains.

Like other forms of channel level entry, the channel becomes "captured" and the level is frozen and unaffected by cue play back and other operations until all channels are restored. Individual captured channels may be restored by pressing the associated submaster bump button while the Channel Window is active.

Since the window size will vary according to assignments of the associated submasters, it may be a good idea to reserve Submaster #1 or #2 for this purpose only, while entering channels, so as not to conflict when these submasters are used for other purposes.



## 4

## Detailed Operation Guide.

### Lighting Level Entry.

As mentioned in the preceding Quick Operation Guide, the key to utilizing the full potential of the Melange Lighting Controller is learning to quickly enter lighting levels. Several means of doing this are provided on this console, such as using the key pad to make direct entry, using the cursor keys, using the submaster channel window, and by using an optional mouse or trackball. All of these methods will be discussed in detail below.

#### *Captured Channels*

During all forms of channel level entry, the channel being adjusted becomes "captured" and the level is frozen and unaffected by cue play back and other operations until all channels are restored. Press the F1: Restore Levels key to restore all captured channels.

#### *Direct Keyboard entry.*

The keyboard consists of 10 numbered keys 0 through 9, and keys marked FULL, THRU, AND, ENTER, CLEAR and AT. The console is prompting for direct channel entry whenever the entry window of the display shows "Chan Entry" and the prompt "Channel:" appears with a flashing line. This is the normal operating mode of the console.

The operator has the option of specifying single channels or a group of channels using the following keys.

- With the data entry line prompting for "channel" enter the starting channel number desired. Numbers from 1 to 128 or the maximum channel configured are valid. Other entry will be refused.
- To indicate a continuous block of channels to be set to the same level, press the THRU key followed by the last channel number of the block.
- To indicate another channel or block of channels to be set to the same level, press the AND key followed by the next channel number.
- To enter the intensity of the selected channels, press the AT or ENTER key followed by the desired intensity in percent (00 to 99, two digits), or if the intensity is to be 100% just press the FULL key (The FULL key does not require AT before). The channels selected will immediately become "captured" and will be forced to the level entered. The cursor keys may be used for adjustment.

→ *EXAMPLE: To set channels 1 through 20 and 28 at 8%:*

→ *Enter 1 and press the THRU key.*

→ *Enter 20 and press the AND key.*

→ *Enter 28 and press the AT key.*

→ *Enter 8 and press the ENTER key.*

- If an error is made, press the CLEAR key to erase the entry, or press it a second time to start over.
- To start a new equation just enter the next starting channel number after entering the last level or press enter to return to the channel prompt. Pressing AT after pressing Enter and before entering new channels will return to the previous equation.
- Press F1: RESTORE LEVELS to clear the entire display of any entered channels and completely release the arrow keys.

With the GRAND MASTER set at maximum, the intensity levels entered will appear on stage for inspection.

*Mouse or  
Trackball entry.*

If configured properly, the Melange may be connected to a mouse or trackball type of pointing device to make channel level entry very convenient. This also allows grouping and scaling of any channel which is always active.

- When a pointing device is connected, a highlighted block will appear over one of the channel levels. The movement of the mouse or trackball will cause the block to move to different channels. Operating rules of the pointing device are as follows.
- Any channel the pointer block has highlighted, may be adjusted by holding down the mouse or trackball's left button and moving the device up or down until the desired level is achieved. Release the button to move the block to another channel.
- A channel may be selected to be grouped for adjustment by pressing the right button of the pointing device.
- A series of channels may also be selected for grouping by holding down the left button of the pointing device while moving it over other sequential channels, releasing the button when done.
- Adjust the levels of a group by holding down the left button the same as for one channel.
- Levels of a group will scale themselves as they change, so the lowest levels will appear to change slower than the higher levels.
- To release a grouping, press the right button twice quickly (double click).
- Captured channels may be restored, as grouped or individually, by double clicking the mouse left button.

→ *EXAMPLE: Use a mouse to adjust level of channel 13.*

→ *Move the pointer box over channel 13.*

→ *Hold down the left button of the mouse.*

→ *Move the mouse up or down to adjust the level.*

→ *Release the button when done.*

→ *EXAMPLE: Use a mouse to scale channels 1 through 10 and 20 upward.*

→ *Move the pointer box over channel 1.*

→ *Hold down the mouse right button and move the box to channel 10.*

→ *Release the right button and move the mouse to channel 20*

→ *Click the mouse right button once.*

→ *Hold down the mouse left button.*

→ *Move the mouse up or down to scale the grouping.*

→ *Release the button when done.*

→ *Double click the mouse right button to release the grouping.*

**To Load the Channel Window.**

1. Press the Submaster LOAD button.
2. Select F1: Channel Window button.
3. Move the highlighted window to the desired channel.
4. Move the associated submaster slider to match the current channel level.
5. Adjust the channel level to new setting.
6. Repeat from step 3 until all channel levels are adjusted.

**To Cancel the Channel Window.**

1. Press the Submaster CANCEL button.
2. Select the F1: Channel Window key.

→ *Example: Set levels on channels 10 and 44.*

→ *Press the Submaster LOAD button.*

→ *Press the F1: Channel Window key.*

→ *Move the Channel Window with the RIGHT ARROW cursor key until the left most portion of the window is under channel 10.*

→ *Move submaster slider #1 to minimum.*

→ *Raise submaster slider #1 until the level of channel 10 changes.*

→ *Adjust channel 10 to desired setting.*

→ *Press the DOWN ARROW cursor key once.*

→ *Press the RIGHT ARROW cursor key until the left most portion of the window is under channel 44.*

→ *Adjust submaster slider following the example for channel 10.*

→ *Press the Submaster CANCEL button.*

→ *Press the F1: Channel Window key.*

The Channel Window may be left active constantly if desired. The cursor keys will not operate to increase or decrease levels while the Channel Window is active.

- Cue nesting* Since the Melange will allow cue nesting to three deep, a wait time less than the uptime of the cue will cause the linked cue to execute while the previous cue is still fading. A wait time of 0 will cause the linked cue to execute at the exact same instant. This feature can be very useful for creating multi-part cues.
- If more than 3 cues are executed at the same time on the same crossfader, the first cues will be aborted. When a cue is aborted, the channel level fading is suspended. The next cue will start the new fade from where the previous one left off. The last cue executed will always have precedence when it comes to channel levels.
- Chase Number* A chase is a programmed sequence of lights that continually repeats itself. An example of a chase is the lights that flash around a marquee. The Melange can be configured to allow up to 99 chases to be stored in its memory. A chase number can be programmed into a cue so that the chase will automatically execute when the cue is executed.
- A chase number from 1 to 99 may be entered into the cue. Once a chase number is entered, the programmed chase selected will start executing for viewing at the last entered or default chase rate. The chase will stop execution when the cue recording is complete.
- Consecutive cues with the same chase number will continue the same chase without interruption. A chase number of 0 is the same as no chase. If a chase number is not entered the console will not prompt for a chase rate.
- Chase Rate* The chase rate is the speed at which the chasing lights sequence. The chase rate is specified in beats per minute. Only certain chase rates may be programmed into a cue. The last entered or default chase rate will be displayed and the UP and DOWN arrow keys are used for selecting other available chase rates.
- Macro Number* Any of the keystroke macros that can be programmed into the Melange can be executed by a cue when specifying one of the programmed macros in the recorded cue. This is a very powerful feature because any cue can then cause various other operations to happen automatically, such as, reloading memory, changing submaster assignments or pages, or minor changes to softpatch. Macro execution will start after the downfade delay. For more information on macros; see the section on MACROS.

**To Record a Lighting Cue follow these steps.**

1. Enter lighting levels.
2. Press the RECORD button.  
The data entry line will indicate cue recording and will prompt now for a cue number.
3. Enter the cue number or press F3 to get the next whole cue number in sequence.  
Cues may be numbered from .1 to 999.9 in .1 increments. Since cues execute sequentially, entering a number which is in between two existing cues will cause the new cue to be inserted between the two cues. It is a good idea to number cues by fives to allow inserting new cues when needed. Press ENTER when done.  
If the cue already exists, the console will beep twice and prompt for a new cue number.
4. Enter the upfade time.  
Time may be entered from 0 to 99 minutes, 59.9 seconds in .1 second increments. To enter time in minutes, enter the value followed by pressing the F1 key (labeled "minutes" at the bottom of the monitor screen). Press ENTER when done.
5. Enter the downfade time.  
Normally, the downfade time is the same as the upfade time and you only have to press the ENTER key to use the same value and continue to the next step. Else, enter the downfade time in the same manner as the upfade. Press ENTER when done.

## Cue Recording

Lighting cues are a collection of lighting levels with pre-programmed fade times that may be stored in the Melange's internal non-volatile memory for later sequential play back. Each cue may be set to be activated manually by an operator or cues may be linked to provide automatic sequencing after a pre-programmed wait time, stopping whenever necessary for an operator to re-synchronize the event.

The Melange is capable of recording the following information into memory cues:

- Up to 128 channel levels.
- Upfade time in 1/10th seconds to 99 minutes, 59.9 seconds.
- Downfade time in 1/10th seconds to 99 minutes, 59.9 seconds.
- Downfade delay time in 1/10th seconds to 99 minutes, 59.9 seconds.
- Next cue number to automatically link to.
- Chase number to automatically activate.
- Chase rate from 1 to 600 beats per minute.
- Macro to automatically activate.

Each of these items is now discussed in depth:

### Channel Levels

All levels that are currently on the CRT display screen are recorded into memory at the instant the cue recording is completed. The number of channels a cue may contain may be configured during the set-up procedure. The less channels each cue contains allows for more actual cues. Levels for cue recording may be set by channel level entry, operation of submasters, by a previous cue, or by any other operation which results in changing channel levels that appear on the CRT display.

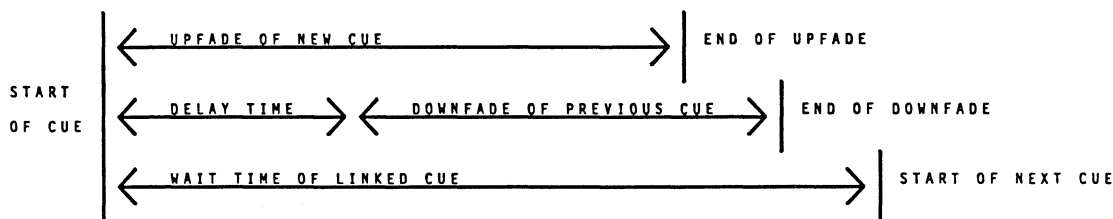

### Upfade time

The upfade time is how long it will take the cue to fade in from the start to the finish of the fade (see figure). Time may be entered directly in seconds from 0 to 99.9. To enter time in minutes, enter it first, followed by pressing the F1: Minutes key. The remaining amount of time in seconds may then be entered.

### Downfade time

The downfade time is the time it will take the previous cue to fade out from the start of the downfade to the finish (see figure). If there was no previous cue, or the previous cue contained levels that were less than all levels of the new cue, the down fade will have no apparent effect. To perform a standard dipless crossfade, the downfade time must be the same as the upfade time. The downfade is entered in the same manner as the upfade.

### Delay Time

The delay time is the time from the start of the cue to the start of the downfade (see figure). For standard dipless crossfades this is set to 0 seconds.

### Linked Cue

**Following are extended cue parameters:**

The Linked cue is the next cue to be automatically activated after a preset wait time. Cues may be linked back to an earlier cue in order to create a loop. Since the Melange will normally load the next cue in sequential order when using the GO button, it is not necessary to specify a cue number to link to in normal operation. If a non-existent cue number is specified, the console will find the next higher cue number on playback. If no cue number is specified, the console will not prompt for a wait time since it is not applicable.

### Wait time

The wait time is the time from the start of the cue to the start of the next linked cue. This time is entered in the same manner as the upfade time.

## Cue Playback

Once memory cues are recorded into the Melange's non-volatile memory, the operator may select various ways to playback the cues. The most common way is to use the autofaders, which make cue playback semi-automatic and as simple as touching the GO button. If more manual control is desired, then the manual crossfaders or the submasters may be selected.

### *Autofaders*

The Melange has two independent automatic crossfaders in which to use. These are the autofaders C and D. Each of these autofaders have individual GO and CANCEL buttons. One LOAD button is shared by the autofaders as well as a LED ladder display. The autofaders also share the HOLD, BACK, ACCEL, and SLOW buttons. The SELECT button determines which autofader is affected.

Both autofaders can be used simultaneously and lighting levels will combine with greatest level having precedence. Both autofaders allow full use of the linking, chasing, and macro capability of each cue.

### *SELECT button*

The SELECT button is used to determine which autofader is to be loaded. Operation of the SELECT button will cause a star to appear next to the letter of the autofader on the CRT display. The star will alternate between C and D autofader as the button is pressed. The C crossfader is the default crossfader when the SELECT button is not used.

### *LOAD button*

The LOAD button is used to load a particular cue into the **selected** autofader for execution at the next press of the respective GO button. When the LOAD button is pressed, the "Nxt" area of the selected submaster will be highlighted. The operator should then enter the cue number desired using the keypad and then press ENTER, or GO to immediately execute the cue entered.

If the cue number does not exist or is invalid, the console will beep twice and the "Nxt" area of the autofader will stay highlighted. The operator may then enter a valid cue number.

The loading operation may be aborted by pressing the LOAD button again or by pressing the CANCEL button of the selected autofader.

### *GO buttons*

The GO buttons are used to execute the cue number that is displayed at the "Nxt" area of the associated autofader. As soon as a GO button is pressed, the upfade of the new cue will start, the timers will start to run, and the following cue number will appear at the "Nxt" area. Linked cues will start the wait timer and will force execution of the new cue when the timer reaches 0.

If a Go button is pressed prior to completion of the current cue the current cue will then abort and the next cue will start executing.

### *Cue nesting*

If the same GO button is pressed prior the completion of a cue, or a linked cue with a wait time of less than the fade time is executed, the next cue will execute while the previous cue is still fading. The Melange can allow cue nesting of up to 3 deep. The first cue will abort if an attempt is made to execute more than 3 cues at once on the same autofader. The last cue executed will always have precedence when it comes to channel levels.

### *HOLD button*

Pressing the HOLD button will cause the selected autofader to suspend any fade in progress and the displayed cue number will flash. Pressing the GO button will cause a suspended autofade to resume.

### *BACK button*

Pressing the BACK button while an autofade is in progress, or after an autofade has been completed, will reverse the autofade and levels affected will fade back to the levels of the previous cue. A press of the HOLD button will halt this operation, while the GO button will cause the fade to resume in a forward direction.

The BACK button will affect the direction of the fade of the current cue only on the selected autofader. If no cue has been executed, the BACK button will have no affect.

6. Enter delay time.  
Normally this is set to 0 for a dipless crossfade. Enter the appropriate value in minutes and seconds, then press the ENTER key.
7. If the cue will contain no links, chases, or macros, go directly to step 11. Otherwise select the F3: Extensions function key to enter additional information.
8. Enter cue to link to.  
Normally, the Melange will automatically load the next cue in numerical sequence as each cue is executed and then wait for a press of the GO button. Simply press ENTER here for normal operation.  
  
However, it may be desired to have a cue automatically execute after a preset wait time. Entering a cue number here will cause this cue number to be loaded and automatically executed instead of the next numerical cue. If this is desired, then enter the cue number and press ENTER. The console will now prompt for a wait time. Enter the wait time in minutes and seconds and then press ENTER.
9. The console will now prompt for a chase number. Enter a valid chase number or nothing and press ENTER. If a chase is selected, it will start executing at the default or last selected chase rate. The current rate will be displayed in the Record Cue window. Select an alternate chase rate by using the UP or DOWN arrow keys.
10. Enter the macro number desired. If no macro is required, simply enter nothing. Press enter when done.
11. Save to memory.  
The cue may be saved in two ways. To simply save the cue to memory press the F2: Save function key.

**Tracking the cue will cause all captured channels to be tracked to the next cue in sequence or next linked cue. Tracking will continue for each channel until a change in level from the first cue tracked is detected. Be sure that you understand the use of this feature before you use it indiscriminately. Press F1: Track and Save to change all proceeding cue levels. Answer YES or NO to the "Are You Sure" prompt, then wait a few moments for the "Tracking" message to disappear from the screen.**

To cancel input and start again, press F4.

- *EXAMPLE: To record lighting levels as cue number 20 with a 5 second fade:*
- *Press the RECORD button.*
- *Enter 20 and press the ENTER key.*
- *Enter 5 for the up time and press ENTER.*
- *Press Enter for the down time to default.*
- *Press Enter for the delay time.*
- *Press the F3: SAVE function key to complete recording.*

---

## Manual Crossfaders

The manual crossfaders A and B allow full manual control over cue crossfading. The A crossfader is at maximum at its fully up position, while the B crossfader is at its maximum at its fully down position. This allows both faders to be operated simultaneously and perform a fade in of one cue while another cue is faded out.

Once a cue is loaded into the manual crossfaders, proceeding sequential cues will automatically be loaded after both faders are moved from one end to the other. If the cue contains a link, the linked cue will be loaded following the crossfade, but the wait time will be ignored. Also all delay, chase, and macro information in the cue is ignored during a manual crossfade.

Holding down the CANCEL button above each manual crossfader will cause the crossfaders to be cleared of any cues **after one second**. This delay is for security so to avoid accidental cancels. The CANCEL button will also cancel any inadvertent press of the respective crossfader LOAD button.

**To load and operate the manual crossfaders follow these steps.**

1. Make sure both A and B crossfaders are together at either the fully up or fully down position.
2. Press the LOAD button of the crossfader that represents a minimum setting (down for A, up for B).
3. Enter the desired cue number. The console will clear the line and beep twice if the cue number is invalid or non-existent.
4. Slowly move both crossfades together from one end to the other.
5. To crossfade following cues, move the crossfaders again from one end to the other.

→ *EXAMPLE: To load cue 10 and manually crossfade it and the cue that follows.*

→ *Move both A and B crossfaders fully down.*

→ *Press the LOAD button under crossfader A.*

→ *Enter 10 and press the ENTER button.*

→ *Move both crossfaders slowly to the fully up position.*

→ *Now move both crossfaders slowly to the fully down position.*



<i>CANCEL buttons</i>	These buttons are used to cancel the respective C or D autofaders and release all channel levels affected. <b>The CANCEL buttons must be held down for 1 second before they will have any affect.</b> This delay is for security so to avoid accidental cancels.
<i>FAST button</i>	This button will cause the currently selected autofade to increase in speed, making the fade time shorter. Each tap of the button will result in an incremental increase in speed. Holding the FAST button down will cause the cue fade speed to continuously increase. The fade time indicated on the display will reflect the change in speed as it relates to the overall fade time. The FAST button only has affect while a fade is in progress.
<i>SLOW button</i>	This button will cause the currently selected autofade to decrease in speed, making the fade time longer. Each tap of the button will result in an incremental decrease in speed. Holding the SLOW button down will cause the cue fade speed to continuously decrease. The fade time indicated on the display will reflect the change in speed as it relates to the overall fade time. The SLOW button only has affect while a fade is in progress.

**To playback a cue with the autofaders, follow these steps:**

1. Press the SELECT button until the desired autofader displays a star.
2. Press the autofader LOAD button.
3. Enter the desired cue number.
4. Press the respective GO button.
5. Press the GO button again to execute any following cues.

- *EXAMPLE: Playback cue 10 and the cue that follows.*
- *Press the SELECT button, if necessary, to select the C autofader.*
- *Press the autofader LOAD button.*
- *Enter 20 and press the ENTER key.*
- *Press the GO button under autofader C.*
- *When ready for next cue, press the GO button again.*

- *EXAMPLE: Edit levels of cue number 1 in Blind Mode.*
- *Press the Function Key labeled "Blind Mode".*
- *Enter the cue number and press ENTER.*
- *Modify lighting levels as necessary.*
- *Press the F3: Record then the F2: Save function key.*
- *Press the CANCEL function key.*

---

## Blind Cue Creation.

A cue may be created in the blind by following these steps.

1. Press the function key labeled: Blind Mode.
2. Enter the number of a new cue. The cue must not already exist or the console will assume that you want to edit the cue.
3. Enter or adjust channel levels as desired.
4. Press the F3: Record function key to start cue recording dialogue.
5. Enter cue parameters as outlined in the section on Cue Recording.
6. Press the F2: Save function key, or if tracking is desired, press the F1: Track and Save function key.

Tracking the cue will cause all captured channels to be tracked to the next cue in sequence or next linked cue. Tracking will continue for each channel until a change in level from the first cue tracked is detected. Be sure that you understand the use of this feature before you use it indiscriminately. Press F1: Track and Save to change all proceeding cue levels. Answer YES or NO to the "Are You Sure" prompt, then wait a few moments for the "Tracking" message to disappear from the screen.

7. Press the CANCEL function to exit Blind Mode.

- *EXAMPLE: Create cue number 2.2*
- *Press the Function key labeled "Blind Mode".*
- *Enter 2.2 and press enter (it is assumed that 2.2 does not exist).*
- *Enter levels for cue 2.2.*
- *Press the F3: Record function key.*
- *Enter Upfade time of 5 seconds and press ENTER.*
- *Press ENTER for default downfade time.*
- *Press ENTER for no delay.*
- *Press the F2: Save function key to save cue in memory.*
- *Press the CANCEL function key.*

## Editing Cues Levels.

Cues May be edited live or in the blind.

To edit cue levels live, the desired cue is first brought up on the screen using the autofaders, manual crossfaders, or submasters. The levels are modified using any of the channel level entry provisions and then the cue is saved to memory using the EDIT button.

To edit a cue live follow these steps:

1. Bring up the cue in an manual crossfader, or submaster and modify lighting levels as necessary. The channel window and mouse are especially convenient here.
2. Press the EDIT button and select the F2: Edit Levels function key.
4. Enter the Cue number to receive the new lighting levels and press ENTER.
5. Press the F2: Save function key, or if tracking is desired, press the F1: Track and Save function key.

Tracking the cue will cause all captured channels to be tracked to the next cue in sequence or next linked cue. Tracking will continue for each channel until a change in level from the edited cue is detected. Be sure that you understand the use of this feature before you use it indiscriminately. Press F1: Track and Save to change all preceding cue levels. Answer YES or NO to the "Are You Sure" prompt, then wait a few moments for the "Tracking" message to disappear from the screen.

→ *EXAMPLE: Edit levels of cue number 1.*

→ *Load cue number one in A crossfader and bring to full.*

→ *Wait for fade to finish, then modify lighting levels as necessary.*

→ *Press the EDIT button.*

→ *Press the F2: Edit Levels function key.*

→ *Enter the cue number and press ENTER.*

→ *Press the F2: Save function key.*

---

## Blind Editing

Cue levels edited in the Blind will not be displayed on stage while editing. The Blind mode is also useful for reviewing cue levels and for creating new cues.

To Edit existing cue levels in the Blind Mode, follow these steps.

1. Press the Function Key labeled "Blind Mode".
2. Enter the cue number to edit and press ENTER. If the cue does not exist the data entry line will display "NEW BLIND". Press Cancel and start over, unless creating a new cue is desired.
3. The cue levels will be displayed on the screen. Adjust channel levels as necessary.
4. Press the F3: Record function key.
5. Press the F2: Save function key, or if tracking is desired, press the F1: Track and Save function key.

Tracking the cue will cause the console to change all channel levels in preceding sequential cues that have the same levels. Be sure that you understand the use of this feature before you use it indiscriminately. Pressing the F1: Track and Save function key will change all preceding cue levels.

6. Press CANCEL to exit the Blind Mode.

6. Repeat from step 4 for additional copying or press the CANCEL function key.

- *EXAMPLE: Copy cue 2.2 to cue 1.*
- *Press the EDIT Button.*
- *Press the F3: More function key.*
- *Press the F3: Delete Cue function key.*
- *Enter 2.2 and press enter.*
- *Enter 1 and press enter.*
- *Press the CANCEL function key.*

---

## Renumber Cues

The cue number of any cue, and therefore it's order, may be changed by following these steps:

1. Press the EDIT button.
2. Press the F3: More function key.
3. Press the F1: Renumber Cue function key.
4. Enter the cue number to renumber and press ENTER.
5. Enter a new cue number for this cue and press ENTER.
6. Repeat from step 4 for additional renumberings or press the CANCEL function key.

- *EXAMPLE: Renumber cue 2.2 to cue 3.*
- *Press the EDIT Button.*
- *Press the F3: More function key.*
- *Press the F1: Renumber Cue function key.*
- *Enter 2.2 and press enter.*
- *Enter 3 and press enter.*
- *Press the CANCEL function key.*

## Editing cue parameters

Any of the cue parameters, such as Upfade Time, may be modified by following these steps.

1. Press the EDIT button and press the F1: Edit Times function key.
3. Enter the cue number to modify and press ENTER.
4. Enter the new cue parameters as outlined in the section on Cue Recording. To accept old values, just press ENTER.
5. Press the F2: Save function key.

→ *EXAMPLE: Change upfade time of cue 2.2.*

→ *Press the EDIT button.*

→ *Press the F1: Edit Times function key.*

→ *Enter 2.2 and press ENTER.*

→ *Enter 8 for new upfade time of 8 seconds and press enter.*

→ *Press ENTER twice to not change downfade and delay time.*

→ *Press the F2: Save function key.*

## Deleting Cues.

An entire cue may be deleted by following these steps:

1. Press the EDIT button.
2. Press the F3: More function key.
3. Press the F2: Delete Cue function key.
4. Enter the cue number to delete and press ENTER.
5. Repeat step 4 for additional deletions or press the CANCEL function key.

→ *EXAMPLE: Delete cue 1.*

→ *Press the EDIT Button.*

→ *Press the F3: More function key.*

→ *Press the F2: Delete Cue function key.*

→ *Enter 1 and press enter.*

→ *Press the CANCEL function key.*

## Copying cues.

Complete cues may be copied to new cue number by following these steps:

1. Press the EDIT button.
2. Press the F3: More function key.
3. Press the F3: Copy Cue function key.
4. Enter the cue number to copy from and press ENTER.
5. Enter a new cue number to copy to and press ENTER.

The proceeding sections will discuss in depth, the operation of the page, chase, and cue submaster functions. The channel level entry is covered in the previous section on Channel Entry Window.

---

## Submaster Pages.

In order to use Submaster Pages, the console must have been configured at initial setup for at least one page of submasters. All pages of memory are non-volatile and the entire page memory may be stored off to an external device. See Setup

### **To Load all unassigned submasters from paged memory.**

1. Press SUBMASTER LOAD button.
2. The next sequential page number will automatically be displayed at the bottom of the submaster window, Key in the desired page number, if different then the page displayed at the bottom of the submaster window, and press Enter to load the submaster page.. Only submasters not loaded with chases or cues will be affected.

Submasters with levels that are set above minimum will not be affected until the respective submaster level is set to minimum. These submasters will show a flashing "pg" (page) number until the submaster level is brought to minimum. All other submasters affected will show the new page number. Operating the submaster controls will cause lighting levels programmed to increase proportionately (of course a scene must have been recorded in the selected submaster page).

To change submaster pages, repeat the above steps but select a different submaster page number (the console must be configured for more than one page).

*Recording  
Submaster  
pages.*

### **To record a scene into submaster page, follow these steps:**

1. Set desired lighting levels using any combination of cues, submasters, or any of the various means of entering and adjusting channel levels as discussed at beginning of this chapter. It is important to understand that whatever is on the stage display, will be recorded.
2. Press RECORD button.
3. Press F1:PAGE NUM to select submaster page number if necessary.
4. Press bump button of desired submaster to store lighting levels into page memory.

*Cancel  
Submasters  
Pages.*

### **To Cancel any submaster page either load (or assign) it with another function, or follow these steps to clear the submaster:**

1. Press the CANCEL button above the submasters.
2. Press the bump button of desired submaster to clear. Any functions assigned to that submaster will immediately go out. Pressing F2:ALL SUBMASTERS will cancel all the submasters.

## Submasters

The eight Submasters of the Melange memory console are very flexible and serve many purposes. Any of the following functions can be intermixed among any or all of the submasters.

- They can be used as paged submasters with up to 99 pages of memory. It is quick and easy to store any lighting scene into a submaster and control that scene by simple operation of the respective Submaster control. This is ideal for situations where either the whole show or just part of the show needs to be run manually with submasters.
- They can be used as chase level and rate controls, where any of the 99 available chases may be assigned to any submaster. The Submaster slider controls the level of a particular chase, while the bump button acts as a rate "tap" control. All eight submasters may be simultaneously chasing with different chases at different rates.
- They can be used as cue submasters, where any previously recorded cue may be assigned to a submaster. The Submaster slider control the level of a cue, while the bump button will cause that particular cue to bump to full intensity.
- The submasters may also be used to directly enter channel levels into the Melange. This allows extremely easy adjustment and blending of channel intensities for cue and page recording.

### *Submaster Bumps*

The button under each submaster will normally cause the page or cue assigned to that submaster to go to full momentarily. When a chase is assigned to a submaster, the bump buttons instead act as a chase rate control and will not affect level. The bump buttons are also used for various loading, programming, and clearing operations and will not affect levels during these operations.

### *Submaster Toggle.*

Any of the Submasters may be programmed to "toggle" on and off with the bump buttons instead of momentarily "bumping" to full intensity. This may be used with the page, and cue functions as well as the Solo Mode.

#### **To program a Submaster to toggle follow these steps:**

1. Press the TOGGLE button above the submasters.
2. Press the bump button of the desired submaster. A "TOGGLE" will appear on the display by the respective submaster, indicating the toggle mode.

Pressing the bump button of the submaster will now cause the page or cue to go to 100%. Pressing the bump button a second time will cause the function to return to the level of the Submaster slider.

To return a submaster bump button to the momentary mode; repeat the above steps.

#### **To clear all Submaster toggle modes:**

1. Press the Submaster CLEAR button.
2. Press the F3: Clear All Toggles function key.

### *Submaster Solo*

The Submasters have the capability to Solo. When a submaster is in the Solo Mode, increasing the level of the submaster will result in a proportional decrease of all other levels, with the exception of Captured Channels.

This allows for a particular scene or chase to be quickly and smoothly executed while remaining lights are faded out, without changing the other operations of the console.

#### **To place a submaster in the Solo Mode:**

1. Press the SOLO button above the submasters.
2. Press the bump button below the desired submaster. A highlighted "SOLO" will appear in the submaster display area indicating the submaster Solo Mode.

**CAUTION: If a submaster is left in the solo mode with the submaster level near maximum or the bump button locked on; the console will have no output and may appear inoperative.**

9. Press F4: CANCEL when done.

- *EXAMPLE: Record a 1-2-3-4 as chase number 1.*
- *Press the RECORD button.*
- *Press the F2: Record Chase function key.*
- *Make sure function key marked "Chase Num" shows 1.*
- *Chase programming channel window should appear under channels 1 - 8.*
- *Press bump button under Submaster 1.*
- *Press the F1: Record Step function key.*
- *Press bump button under Submaster 2.*
- *Press the F1: Record Step function key.*
- *Press bump button under Submaster 3.*
- *Press the F1: Record Step function key.*
- *Press bump button under Submaster 4.*
- *Press the F1: Record Step function key.*
- *Press the F4: Cancel function key.*

---

## Submaster Cues.

Any of the submasters may be assigned to previously recorded cues. The submaster will then contain only the level information of a particular cue. Time, chases, links, and macros will have no effect. The cue may be loaded and executed in the manual or automatic crossfaders even though it is assigned to a submaster.

### **To Load a Submaster with a cue.**

1. Press the Submaster Load button.
2. Select the desired submaster by tapping the respective bump button.
3. Using the keypad, enter the cue number desired and press enter. If the console clears the line and beeps twice, this means that the cue does not exist.
4. Press F4: CANCEL when done.



## Submaster Chases.

The Melange has the ability to assign any chase from the chase memory to any or all of the submasters. Chases are then available at any time for play back by simply raising the submaster level. This also allows for multiple chases running at the same time with different levels and different chase rates.

The submaster's bump button operates as a chase rate "tap" control and will cause the chase rate to mimic the speed of the last two taps of the button. Chases assigned to submaster #8 will automatically revert to audio synchronization whenever audio is present.

**NOTE: The chase feature will not operate if memory was configured for 0 chases.**

**To load chases into submasters.**

1. Press SUBMASTER LOAD button.
2. Press the Submaster bump button of the submaster desired.
3. Press the F1: LOAD CHASE function key to assign the chase to the submaster.
4. Key in the desired chase number and press Enter. Only the number of chases set at initial memory configuration will be available. The same chase may be assigned to several submasters at different rates and levels.
5. Tap the bump button of the selected submaster at the rate desired to set the chase rate.

Increase the selected submaster level to playback the chase. Of course the chase must have been previously recorded in memory.

*Cancel  
Submaster  
Chase.*

To Cancel any submaster chase, either load (or assign) it with another function, or follow these steps to clear the submaster:

1. Press the CANCEL button above the submasters.
2. Press the bump button of desired submaster to clear. Any functions assigned to that submaster will immediately go out.

---

## Recording Chases.

**NOTE: The availability of the chase feature and size of the chase memory depends on the configuration of the memory during set-up.**

**To Record Chase into memory.**

1. Move all submasters to minimum and press the RECORD button.
2. Press the F2: RECORD CHASE function key.
3. Select the chase number to record using the F3: CHASE NUM function key. As many as 0 to 99 chases may be available depending on the memory configuration.
4. Notice the highlighted window that appeared below channels 1 - 8 on the CRT screen. Also notice by using the four cursor keys, you can position the window under any channels on the screen.
5. Use the cursor keys to position the window under the desired channels for the first step of the chase.
6. Using the submaster bump buttons to toggle the respective channels above the window on and off, select the channels to be on for the first step of the chase. Move the window as necessary with the cursor keys to select all channels desired.
7. Press the F1: RECORD STEP function key to record this step into memory. The step number will automatically advance.
8. Repeat from (5) above until all steps of the chase are programmed. As many as 1 to 250 steps may be available per chase, depending on memory configuration at set-up.

## 5

## Macros

### Keyboard Macros

A Macro is collection of keystrokes that can be executed by the press of just two keys. Macro's are extremely useful for doing complex operations. Some possible examples are:

- All submasters could be loaded or reloaded with new levels.
- All autofaders, manual faders, submasters, etc. could be cleared (essentially, a Blackout).
- All channels could be brought to full.
- Both autofaders could be loaded and the console prepared for the start of a show.

Any of these examples could be executed with just two keystrokes by recording all the keystrokes necessary in a macro.

Eight of the macros may be executed (or "fired") externally by 8 different contact closures. This gives the Melange many remote control possibilities, since the user may define the actual operations that will occur when a switch is closed.

Cues may also cause any of the 22 macros to "fire". Automatic submaster and manual crossfade reloads are only some of the possibilities.

#### *Valid Macro Keys*

These keys may be used to store macros:

- Numeric keypad keys 0 - 9
- Submaster bump buttons 1 -8 (maps to external macro pins)
- Functions keys 1 - 4

Only the submaster bump button macros can be fired externally.

#### *Erasing all Macros*

**NOTE: To erase all existing macros, follow these steps.**

1. Press the F4: Special Modes function key.
2. Press the F2: Configuration function key.
3. Press the F1: Set Options function key.
4. Press the F3: Init Macros function key.

#### *Recording Macros*

**NOTE: If this is the first time macros are to be recorded in the Melange, it is recommended to erase all macros first to allow for best memory usage.**

**To Record a Macro, follow these steps:**

1. Make sure the console is in an operating mode from where the macro is expected to be used. Since the macro is only a recording of keystrokes, it must always be "fired" from a known starting point. **NOTE: The Function keys will be immediately reset to the main menu when a macro is first selected or recorded.**
2. Press the Macro button.
3. Press the Record button.
4. Press a valid macro key to store the keystrokes to.
5. Carefully press the keys to be recorded in the macro. If a mistake is made, press the Macro button and start over at step 1.
6. After the last key is recorded, press the Macro button again and the console will start storing the macro in non-volatile memory.

## Softpatch

Softpatching gives the user the ability to patch control channels to dimmers from the control console. Furthermore, patches can be done proportionally. For example, lets say that channel 1 is patched to dimmers 1 and 2. Dimmer 1 is patched at 100% and dimmer 2 at 80%. This means that dimmer 1 will follow channel 1's level, but dimmer 2 will be scaled at 80% of channel 1.

To make softpatch modifications, you must first bring up the softpatch display using the function key sequence "Special Modes", "Configuration" and "Set Softpatch". The display will begin with channel 1 at top. The cursor keys can be used to scroll the display up and down.

### *Patch Channel*

The channel to be patched is entered using the data entry keys and displayed after "Patch Chan:" in the Data Entry window. Once the channel is entered using the Enter key, the display will adjust so that channel is at the top of the display. Then enter the dimmers to be patched at the desired percentage using the Data Entry, THRU, AND, ENTER, AT, and FULL.

### *Clear Channel*

To clear an individual channel of the patch press the "Clear Channel" function key. The Data Entry window will then prompt for the channel to be entered. Press enter to clear the channel.

### *Default Patch*

To quickly set up a one to one patch, press the "Set-up" function key, followed by the "Default Patch" function key.

### *Clear Patch*

The patch may be totally cleared by pressing the "Set-up" function key followed by the "Clear Patch" function key. NOTE: There will be no output when patch is cleared.

### *Stage*

This Function Key will immediately cause any the last channels patched to be brought to full on stage.

## 6

## Input / Output

---

### Overview

The Melange memory lighting controller has the capability to offload and reload cues, submaster pages, patches, macros and chases to several different storage devices. This gives the Melange greater flexibility and added security.

If a redundant backup console is absolutely required, you can easily transfer data from a storage device to a new unit in case of emergency.

The user has the choice of using the follow storage devices:

- Xmodem via the RS-232 port, which can be used with any computer and communications software to store data to disks for greatest security.
- Ascii Cues via the RS-232 port, which allows the user to create or edit cues on a word processor, which gives the user the greatest flexibility.
- MIDI Port, which supports System Exclusive data dumps to a MIDI disk or Sequencer.
- Printer, for creating a hardcopy of selective portions of memory.

Each of these is discussed below.

---

### RS-232 port.

The RS-232 port is a 9 pin type of connector which matches the type used on most personal computers. See the diagram for pinout and typical connection to personal computers.

For both Xmodem (binary) transfer and ASCII Cues type of transfer, the computer must be running a standard "communications" software (the same type used to communicate with other computers over modems). Software such as Procomm or Crosstalk is ideal for this purpose. The computer software needs to be configured to match the RS-232 parameters of the console as follows:

- 4800 baud, 8 data bits, 1 stop bit, no parity, hardware and xoff handshaking.

**The following instructions pertaining to RS-232 file transfer assumes the user has read the instructions that came with the computer software and understands it's operation.**

#### *Xmodem File Transfer.*

The Melange has the ability to selectively transfer memory data to and from personal computer disk files. The transfer protocol that has been chosen for this operation is called "Xmodem". The Xmodem protocol is the most popular among communications software and has the advantage of error detection. Once a file transfer is initiated, the computer software and the Melange will communicate with each other and start transferring 128 byte blocks of data from one to the other. If the receiver encounters an error, it will request that the data be re-transmitted.

Each computer disk file may contain one of the following types of data:

- Selected memory cues.
- All submaster pages.
- All chases.
- All dimmer softpatch.
- All macros.

The storage process may take a few seconds because the macro memory is variable length and other macros may have to be reshuffled. A message will appear on the upper left hand corner of the display while the macro is being stored.

A "Macro Memory Full" message will be displayed if the memory is full and cannot hold any more keystrokes. Some Macros will have to be deleted or the Macro memory will have to be erased and the above steps repeated.

*Deleting a Macro.*

To delete a macro and free the memory being used by it, follow these steps:

1. Press the Macro button.
2. Press the Record button.
3. Press the macro key to delete.
4. Press the Macro button again to delete the macro from memory.

*Macro Firing.*

To Fire a Macro (playback the recorded keystrokes), follow these steps:

1. Make sure the console is in the operating mode from where the macro was recorded. Since the macro is only a recording of keystrokes, it must always be "fired" from a known starting point.
2. Press the Macro button.
3. Press a valid macro key to fire the macro

---

**External  
Macros**

Macros recorded in submaster bump buttons 1 - 8 may be fired externally. If a contact is made between pin 1 and any of the pins 2 - 9 of the macro connector on the back of the console apron, the macro corresponding to the diagram below will fire. The macro will fire at the instant the contact is closed and will not fire again until the contact is opened and closed again.

Only one macro will execute at a time. In the case of multiple contact closures; the lower numbered macro will fire first, followed by the higher numbered macro after the previous one is completed.

*Turnkey Operation.*

If any contacts are closed when the console powers up, the macro or macros will fire after the console has initialized. This is very useful for making the console "Turnkey" or automatic.

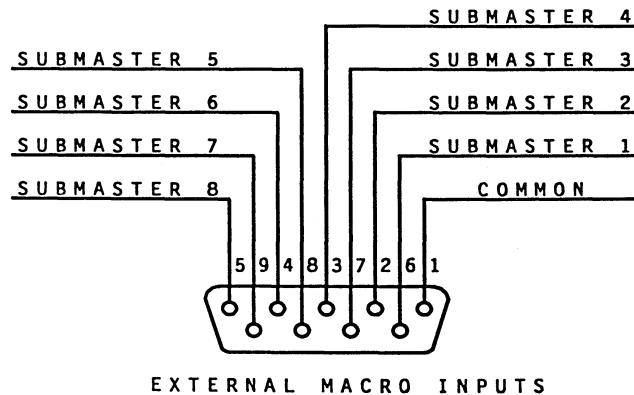

*Uploading  
form computer.*

Data from a computer file will overwrite all data already programmed in the console for a particular data item with the exception of cues. Only cues with the same number will be overwritten and new cues will be added, unless the user clears the console cue memory by selecting the "Yes" function key when the console prompts "Clear all console cues first?". This prompt will appear whenever cues are to be loaded from the computer file, and you must answer this question within a few seconds to avoid the computer stopping the transfer.

In order to load memory data from the coputer the user must follow these steps.

1. Connect the Melange to the computer as per diagram.
2. Set up the communications software to transmit (upload) xmodem file transfer. The computer will request the name of the file.
3. Select the Function Key labeled "Special Modes" then select the function key labeled "Input Output".
4. Now select "RS-232 port from the menu displayed.
5. Select #2: "Load Memory from RS232" from the RS232 Menu, followed by pressing the function key labeled "Execute". The Melange will start waiting for the computer to transmit the file. Command the computer to start the file transfer, if you have not done so already.
6. The console will immediately start the data transfer unless the file contains cues or the memory configuration has changed. The console will momentarily halt the data transfer and prompt the user. Since communications have been interrupted, the user must respond to the prompts within a few seconds, else the computer will perceive this as a breakdown in the transmission and will abort. If this happens the user must press "Cancel" and start over.

When the console is done, the menu will be displayed. The function key labeled "Cancel" will restore the console to normal operation.

→ *EXAMPLE: Clear console cues and reload with cues from computer file.*

→ *Load the computer's communications software and start an Xmodem file transmit.*

→ *Press Function key labeled "Special Functions".*

→ *Press Function key labeled "Input Output".*

→ *Press 3 for "RS-232 port.*

→ *Press 2 to load data.*

→ *Press "Execute".*

→ *Wait for Clear all cues prompt.*

→ *Press "Yes".*

→ *Wait for transfer to complete.*

→ *Press "Cancel" to return to normal operation.*

*ASCII Cue File  
Transfer.*

The Melange has the ability convert cue memory data to and from a simple "English" format known as ASCII. This gives the operator the ability to write or edit cues in a simple format when away from the console. The ASCII type of format is universally accepted in the computer industry and most word processors or text editors will support it. The operator may initially start writing cues on the word processor or may create cues on the Melange and transfer them to the computer for later editing.

A "communication" or similar program may be required to do an ascii transfer to and from the computer's RS-232 port. The Melange will handle the complete conversion of the memory cue data back and forth to ASCII internally.

Whenever data is saved to a computer via Xmodem, critical parameters such as number of dimmers, channels, pages, chases, and chase steps are stored in the file. The information is only displayed during loading if the console memory configuration has been altered since the particular data was saved to the computer. Data will be altered (truncated or filled) in order to fit a new memory configuration.

Some results of memory configuration changes are listed below.

- If the console has more channels, dimmers, chases, pages, or steps than the computer file; extra console data items will be filled with 0 levels. In the case of chases; programmed chases will remain intact.
- If console has less channels, dimmers, chases, pages, or steps than the computer file; extra computer file data items will be truncated (left off).

**It is very important that the user consider the repercussions of changing memory configurations and reloading console memory. See section on Memory Configuration for more information.**

*Downloading  
to computer*

In order to save memory data to the computer the user must follow these steps.

1. Connect the Melange to the computer as per diagram.
2. Set up communications software to receive (download) xmodem file transfer. The computer will request a name for the file.
3. Select the Function Key labeled "Special Modes" then select the function key labeled "Input Output".
4. Now select "RS-232 port" from the menu displayed
5. Select #1: "Save Memory to port" from the RS-232 Menu, and press the function key labeled "Execute".
6. Now select the number of the type of data that you wish to store from the menu displayed. If cues are selected then the console will prompt for cue range. The console will then immediately start the data transfer. Command the computer to start receiving data, if you haven't already. The computer should be displaying the progress of the transfer without any errors.
7. When the console is done, the data item menu will be displayed. The function key labeled "Cancel" will restore the console to normal operation.

→ *EXAMPLE: Save all memory cues to a disk file.*

→ *Load the computer's communications software and start an Xmodem file receive.*

→ *Press Function key labeled "Special Functions".*

→ *Press Function key labeled "Input Output".*

→ *Press 4 for "RS-232 port."*

→ *Press 1 to save all cues.*

→ *Press "Execute".*

→ *Wait for transfer to complete.*

→ *Press "Cancel" to return to normal operation.*

- *EXAMPLE: Transfer all memory cues to ASCII cue disk file for later editing on a word processor.*
- *Load the computer's communications software and start an ASCII text file receive.*
- *Press Function key labeled "Special Functions".*
- *Press Function key labeled "Input Output".*
- *Press 4 for "RS-232 port."*
- *Press 3 to dump ASCII cues.*
- *Press "Execute".*
- *Wait for transfer to complete.*

*Transferring  
ASCII Cues  
from computer .*

Only ASCII cues with the same number will be overwritten and new cues will be added, unless the user clears the console cue memory by selecting the Erase all Cues operation as outlined in the Section on CONFIGURATION.

**NOTE: It is important that the "software handshaking" feature be enabled on the communications software. The Melange will transmit a "CTL S" character to temporarily stop data transmission while it is processing a cue. This is called "ctl S / ctl Q software handshaking" and it is available on most every communications software programs**

In order to transfer ASCII cues from the computer, the user must follow these steps.

1. Connect the Melange to the computer as per diagram.
2. Set up the communications software to transmit (upload) an ASCII text file. The computer will request the name of the file.
3. Select the Function Key labeled "Special Modes" then select the function key labeled "Input Output".
4. Now select "RS-232 port" from the menu displayed.
5. Select #4: "Load Ascii from port" from the RS-232 menu, followed by pressing the function key labeled "Execute". The Melange will start waiting for the computer to transmit the file. Command the computer to start the file transfer, if you have not done so already.
6. The console will immediately start the data transfer and the full parameters of each cue will be displayed as each is received.

When the computer indicates that the file transfer is done, press the function key labeled "Cancel" to restore the console to normal operation.



The actual format specification and rules for writing and editing cues appears in another section in the back of this manual.

*Transfer to  
computer .*

The following instructions pertaining to RS-232 file transfer assume the user has read the instructions that came with the computer software and understands it's operation.

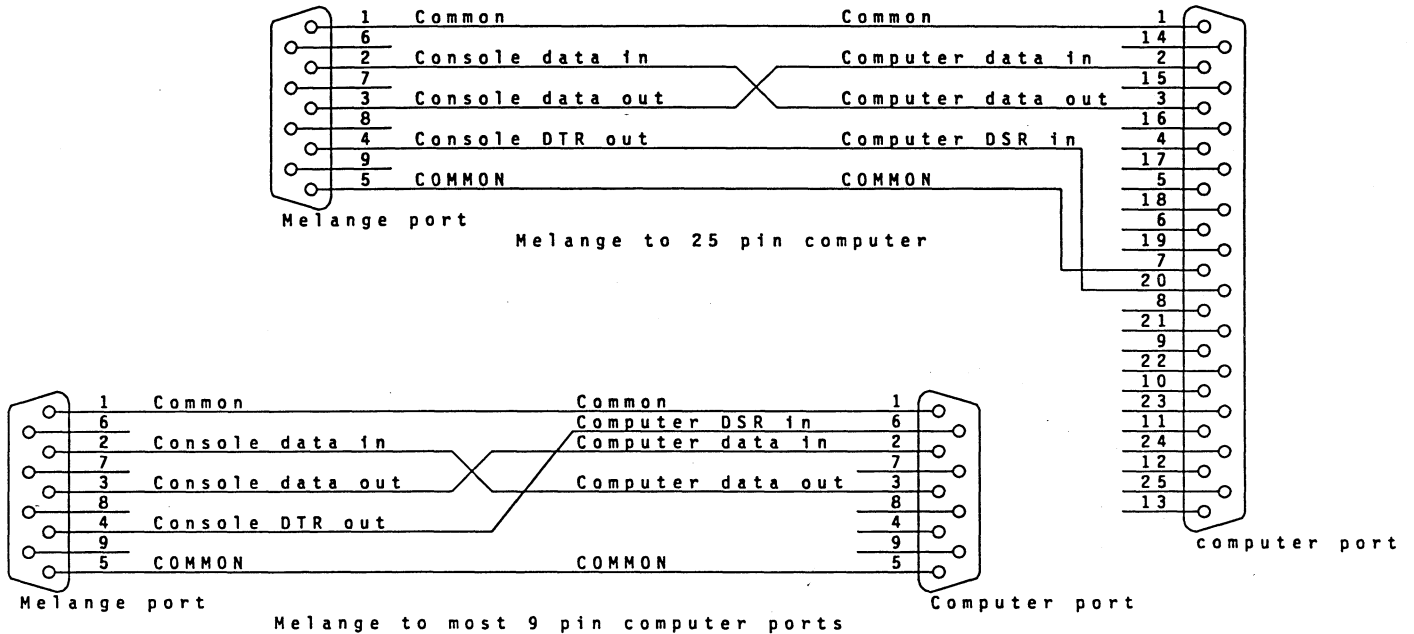

NOTE: pins 2,3 and / or 4,6 may swap in some systems

In order to transfer ASCII cues to the computer for editing, the user must follow these steps.

1. Connect the Melange to the computer as per diagram. (Cables may be available from your Dealer or any computer supply, ask for a "Lap Link cable")
2. Set up communications software to receive (download) an ASCII text file transfer. The computer will request a name for the file.
3. Select the Function Key labeled "Special Modes" then select the function key labeled "Input / Output".
4. Now select "RS-232 port" from the menu displayed. Command the computer to start receiving data, if you haven't already.
5. Select #3: "Dump ASCII Cues to port" from the RS-232 Menu, and press the function key labeled "Execute".
6. The console will immediately start the data transfer.
7. When the transfer is done, the console will return to normal operation.

Some results of memory configuration changes are listed below.

- If the console has more channels, dimmers, chases, pages, or steps than the data file; extra console data items will be filled with 0 levels. In the case of chases; programmed chases will remain intact.
- If the console has less channels, dimmers, chases, pages, or steps than the MIDI data file; extra file data items will be truncated (left off).

**NOTE: It is very important that the user consider the repercussions of changing memory configurations and reloading console memory. See section on Memory Configuration for more information.**

*Storing  
Memory to  
MIDI.*

In order to save memory data to the MIDI device, the user must follow these steps.

1. Connect the Melange to the MIDI device.
2. Set up the MIDI device to receive a MIDI System Exclusive data dump.
3. Select the Function Key labeled "Special Modes" then select the function key labeled "Input / Output".
4. Now select Item #2 "MIDI port" from the menu displayed.
5. Select #1: "Save Memory to port" from the MIDI Menu, and press the function key labeled "Execute".
6. Now select the number of the type of data that you wish to store from the menu displayed. If cues are selected then the console will prompt for cue range. The console will then immediately start the data transfer. Command the MIDI device to start receiving data, if you haven't already.
7. When the console is done, the data item menu will be displayed. The function key labeled "Cancel" will restore the console to normal operation.

→ *EXAMPLE: Save all memory cues to a MIDI disk.*

→ *Configure the MIDI disk to receive a data dump and store it to a disk file as per the device's instructions.*

→ *Press Function key labeled "Special Functions".*

→ *Press Function key labeled "Input Output".*

→ *Press 2 for "MIDI port."*

→ *Press 1 to save all cues.*

→ *Press "Execute".*

→ *Wait for transfer to complete.*

→ *Press "Cancel" to return to normal operation.*

*Receiving  
Memory from  
MIDI*

**NOTE: The Melange will accept all memory data when receiving MIDI data transfers regardless of whether the memory configuration has been changed since the memory was stored to the MIDI device.**

- *EXAMPLE: Clear console cues and reload with cues from a computer file.*
- *Erase all memory cues as outlined under CONFIGURATION in this manual.*
- *Load the computer's communications software and start an ASCII text file transmit.*
- *Press Function key labeled "Special Functions".*
- *Press Function key labeled "Input Output".*
- *Press 3 for "RS-232 port.*
- *Press 4 to load data.*
- *Press "Execute".*
- *Wait for the transfer to complete.*
- *Press "Cancel" to return to normal operation.*

## MIDI port

"MIDI" is an acronym for the Musical Instrument Digital Interface. This is the established standard for the system which interconnects musical instruments and other production equipment. MIDI is most commonly used for synchronizing many pieces of equipment and for storing digital data for later retrieval.

### *Sequencer*

A device called a sequencer is used to record events that occur within a piece of equipment. These events may be the pressing of a key on a synthesizer, the tap on a drum machine, the operation of a tape machine, or the cue execution of a lighting controller. The sequencer can store information from many devices and can playback the information simultaneously in synchronization with other events.

The Melange transmits a short stream of data out of the MIDI OUT port whenever either GO button is pressed on the console. The format of the data is called a SYSTEM EXCLUSIVE and contains information about the cue number and the crossfader used. This information is recorded to a sequencer, and when it is played back, the console will repeat the same cue number. The format of this SYSTEM EXCLUSIVE command is shown in the MIDI Implementation chart in the back of this manual.

### *MIDI disk*

The Melange can transfer memory data to many MIDI devices for storage and later retrieval. Most sequencers can be utilized for this purpose, but a device called a MIDI DISK is the most appropriate for memory data storage. These devices are less expensive than sequencers and the operation is more keyed towards storing large amounts of memory data. The Melange sends memory data out of the MIDI port as a SYSTEM EXCLUSIVE. The format of which is shown on the MIDI Implementation Chart in the back of this manual.

### *MIDI memory data transfer*

**NOTE: The following instructions pertaining to MIDI file transfer assume the user has read the instructions that came with the MIDI storage unit and understands it's operation.**

To transfer memory data to and from appropriate MIDI devices, connect MIDI cables from the MIDI OUT of the console to the MIDI IN port of the device. Connect the MIDI OUT of the device to the MIDI IN of the console.

Each MIDI data file may contain one of the following types of data:

- Selected memory cues.
- All submaster pages.
- All chases.
- All dimmer softpatch.

Whenever data is saved to a MIDI device, critical parameters such as number of dimmers, channels, pages, chases, and chase steps are stored in the data file. This information is NOT displayed during loading and all data will be altered (truncated or filled) in order to fit a new memory configuration.

4. Select one of the Reports from the Printer Menu, and the report will immediately start printing. The report item selected will remain highlighted while the console is sending data to the printer.
5. When the printing is done, the report menu will return to normal. The function key labeled "Cancel" will restore the console to normal operation, or select another report.

→ *EXAMPLE: Print a Cue Sheet.*  
→ *Press Function key labeled "Special Functions".*  
→ *Press Function key labeled "Input Output".*  
→ *Press 3 for Printer port.*  
→ *Press 1 to print Cue List.*  
→ *Wait for printing to complete.*  
→ *Press "Cancel" to return to normal operation.*

The Melange is ready to receive MIDI data transfers whenever the console is in its normal operating mode and none of the Special Modes are active (such as input/output, configuration, softpatching or recording modes). For the most part, the operator has to do nothing to initiate a MIDI data transfer, but start the MIDI device sending the information. The console will receive MIDI data dumps "transparently", meaning that cues may be running and no noticeable change will be apparent in console operation.

To be sure the console is in its normal operating mode and ready to receive MIDI data; be sure that the F1 function key is displaying "F1: Restore Levels". If it is not, then press the function key marked "Cancel" until the function key display is correct.

As MIDI data is received, the console will display the progress of the data transfer in the upper left hand corner of the display screen. When a transfer is completed, the console will display "MIDI Completed".

The console will replace all cues with the same number but it will add new cues to memory. This may result in the memory being filled up, at which point the Melange will continue to receive the MIDI data, but will not save extra cues to memory.

- *EXAMPLE: Receive MIDI data transfer (data dump) from a MIDI disk.*
- *Make sure that the console is in the normal operating mode and the F1 function key is displaying "F1: Restore Levels".*
- *Start the MIDI data dump from the MIDI disk.*
- *Watch the upper left corner of the console display to monitor progress.*
- *When the display shows "MIDI Completed" then console operation may be resumed.*

---

## Printer Operation.

The Melange may be connected to a printer for hard copy output of cues, patches, macros, chases, and submaster pages. Any display screen may be printed also at any time. Examples of the different types of printouts appears in the back of this manual.

The Melange must be connected to one of the printers listed in the specifications section of this manual. This printer must be connected with a cable designed for connection to 25 pin parallel printer ports (the same type used on IBM PC compatible).

*Screen Printing* To obtain a printout of any display screen at any time follow these steps:

1. Console must be displaying the screen desired.
2. Press the MACRO button.
3. Press the RIGHT ARROW button and the printer will immediately start printing.

- *EXAMPLE: Print blind mode display screen.*
- *Enter Blind mode and select cue number.*
- *When ready, press the Macro button.*
- *Ready printer, and press the RIGHT ARROW button.*

*Report Printing.* In order to print one of the available reports, the user must follow these steps.

1. Make sure the Melange is connected to the printer.
2. Select the Function Key labeled "Special Modes" then select the function key labeled "Input Output".
3. Now select Item #3 "Printer" from the menu displayed.

**LINK** This keyword specifies a link to another cue. This keyword is followed by a space and then the cue number in the range of ".1" to "999.9". The decimal point is not necessary if no decimal is specified. If the cue number specified does not exist in the melange at the time the cue is executed; then the cue after the specified cue in numerical order will be linked. If the LINK keyword is not specified; then no link will be performed, and the WAIT keyword will be ignored.

EXAMPLE: LINK 100

**WAIT** This keyword specifies the time delay before the execution of a linked cue. This keyword must be followed by a space and the time in the range of "0" to "9:59.9". Minutes are optional but must be followed by a colon. In the absence of minutes, seconds may be specified up to "999.9". The decimal point is not necessary if no decimal is specified. If the WAIT keyword is not specified in a cue definition then a automatic link will not be performed, and the GO button must be pressed to execute the cue specified.

EXAMPLE: WAIT 1.1

**CHANNEL** This keyword is used to specify the channel levels (in percent) of each non-zero channel of the cue. This keyword must be followed by a space and the channel levels in the format of "channel,level". As many channel/level pairs may be included on a line as will fit. Each channel/level pair must be separated by a space. Each additional line specifying channel levels must also begin with the keyword. Full level is represented by "100", "FF", or "FL". Any channel not specified will be zero.

EXAMPLE: CHANNELS 1,50 20,25 21,25 22,100

**\$CUECHS** This keyword is used to specify the number of the chase to be activated when the cue is executed. This keyword must be followed by a chase number from "1" to "99". If the chase number does not exist in the Melange's memory at the time of execution, then the cue chase will have no effect. The \$CUECHS key must appear in proceeding cues if the cue chase is to be continued. If the \$CUECHS keyword is omitted, then any existing cue chase will be canceled.

EXAMPLE: \$CUECHS 1

**\$CUEBPM** This keyword is used to specify the rate at which a chase will sequence. This keyword must be followed by a number in the range of "0" to "600" beats per minute. If zero is specified, then the chase will only sequence manually. This keyword will be ignored if the \$CUECHS keyword does not appear in the same cue.

EXAMPLE: \$CUEBPM 60

**\$CUEMAC** This keyword is used to specify the macro number to be fired by the cue at the time it is executed. This keyword must be followed by a space and a designator of a macro key from the following list:

- "0" - "9": Keypad numerical buttons.
- "S1" - "S8": Submaster bump buttons.
- "F1" - "F4": Function keys.

If the keyword is omitted, then no macro will be fired.

*Keywords not supported.*

The following keywords are accepted by the Melange, but have no effect on cue memory.

**MANUFACTURER, CONSOLE, VERSION, UPWAIT, PATCH**

## 7

# ASCII Cues Implementation

### Overview

Following are the rules for editing ASCII Cues as implemented on the Melange, software revision 1.10:

**NOTE: For information on transferring ASCII Cues to your computer or word processor; see section on INPUT / OUTPUT.**

**NOTE: If you use a word processor for editing ASCII Cues you must set WORD WRAP OFF and the margin should be set to 80 characters per line. DO NOT use any "special" features; such as BOLD or UNDERLINING.**

#### *Format*

Each line of an ASCII Cues file must begin with a keyword. Keywords may be up to eight characters and may only consist of letters A - Z, numbers, or the "\$" character.

Keywords cannot be shortened, but any number of spaces or tabs may be inserted before the keyword.

The maximum length of each line is 80 characters (including spaces).

Each line must be terminated with a CR or CR/LF (carriage return/line feed or "hard return").

The file may be as big as the word processor or editor may allow.

The file should end with a \$END keyword to make sure the Melange records the last cue received.

#### *Keywords Supported.*

The following is a list of keywords supported by the Melange:

**CUE** This keyword must start the description of each cue. This keyword is followed by a space and then the cue number in the range of ".1" to "999.9". The decimal point is not necessary if no decimal is specified.

EXAMPLE: CUE 238.5

**UP** This keyword specifies the fade up time of the new cue. This keyword must be followed by a space and the time in the range of "0" to "9:59.9". Minutes are optional but must be followed by a colon. In the absence of minutes, seconds may be specified up to "999.9". The decimal point is not necessary if no decimal is specified. If the UP keyword is not specified in a cue definition then either "0" or the UP value of the previous cue will be used.

EXAMPLE: UP 10.5

**DOWN** This keyword specifies the fade down time of the previous cue. This keyword must be followed by a space and the time in the range of "0" to "9:59.9". Minutes are optional but must be followed by a colon. In the absence of minutes, seconds may be specified up to "999.9". The decimal point is not necessary if no decimal is specified. If the DOWN keyword is not specified in a cue definition then either "0" or the DOWN value of the previous cue will be used.

EXAMPLE: DOWN 1:30

**DELAY** This keyword specifies the time delay before the downfade of the previous cue. This keyword must be followed by a space and the time in the range of "0" to "9:59.9". Minutes are optional but must be followed by a colon. In the absence of minutes, seconds may be specified up to "999.9". The decimal point is not necessary if no decimal is specified. If the DELAY keyword is not specified in a cue definition then either "0" or the DELAY value of the previous cue will be used.

EXAMPLE: DELAY 30

---

## MIDI cues

MIDI can be used to control the Melange's cuing. Each time a GO button is pressed on the Melange, a system exclusive packet is transmitted. This packet contains the cue number and autofader identifier. The message can be recorded on a MIDI sequencing device in real time and played back to the Melange for synchronization with a MIDI sequence.

The message consists of a System Exclusive header (\$F0), followed by NSI's System Exclusive ID number (\$00 \$00 \$3E). Next, the autofader identifier is sent (\$00=Fader C, \$01=Fader D), followed by the cue number in ASCII characters. Finally, an End of System Exclusive is sent (\$F7).

**Following is an example of cue 210.5 being activated from autofader C:**

\$F0 \$00 \$00 \$3E \$00 \$32 \$31 \$30 \$35 \$F7



# 8 MIDI Implementation

## MIDI Chart

Melange MIDI Implementation Chart Release 1.10

Function		Transmitted	Recognized	Remarks
Basic Channel	Default Channel	X	X	
Mode	Default Messages Altered	X	X	
Note Number	True Voice	X	X	
Velocity	Note ON Note OFF	X	X	
After Touch	Key's Ch's	X	X	
Pitch Bender		X	X	
Control Change		X	X	
Program Change		X	X	
System Exclusive		0	0	
System Common	:Song Pos :Song Sel :Tune	X	X	
System Real Time	:Clock :Commands	X	X	
Aux Messages	:Local ON/OFF :All Notes OFF :Active Sense :Reset	X	X	

Mode 1:OMNI ON, POLY    Mode 2:OMNI ON, MONO  
Mode 3:OMNI OFF, POLY    Mode 4:OMNI OFF, MONO

0 = YES    X = NO

SPECIAL MASTER CODE: 4700

Remove this page if security is required

## 9

## Configuration

### Memory Allocation

The Melange's memory is designed to be tailored to your needs. Memory can be allocated to channels, dimmers, chases, submaster pages and cues. The number of channels greatly affects the amount of memory needed for storage.

The Melange can be configured from 16 to 128 channels in 16 channel increments. In this way, if only 64 channels are needed, the console can be configured for 64 channels, leaving more memory free other uses. In the same way, the number of dimmers needed affects the size of the patch memory, so that if the full 512 dimmers are not needed, some of the patch memory can be reserved for other uses. If chases are to be used during an event, the number needed and the maximum length for all can be configured. The number of submaster pages can also be configured. Each time a change is made to memory function, the total number of cues available is displayed.

**NOTE: Memory allocations can only be altered after a system clear.**

To initiate a clear turn the console off. Hold the four function keys down and turn the console back on. At this point an access code is requested. The default code shipped from the factory is 1-1-1-1. This can be altered under the Set Parameters display. Once the proper code is entered, the console will clear out all memory except macros and house lighting settings and reconfigure to factory settings. Following the clear, the Memory Allocations table will be displayed for alterations. Use the number keys to choose the memory function and the up/down arrows to make changes. Once the memory is properly configured, the cancel key is pressed and normal operation is resumed. From this point on the memory allocations can only be viewed until another system clear is initiated.

### Console Configuration

Console configurations can be viewed or modified in the Console Configurations display. The display is accessed using the "Special Mode", "Configuration", "Set Options", "Set Parameters" function key sequence.

An access code is required to enter the display. The factory default is 1-1-1-1. The display will show the items to be changed and their current settings. Select the item using the data entry keys. Use the up/down cursor keys to make modifications.

<i>MPX Mode</i>	The multiplex mode can be set for Micro-plex DMX-512 or AMX-192.
<i>Preheat</i>	The minimum output level can be set between 0% and 25%
<i>Printer</i>	Printer type Epson compatible or HP laser compatible
<i>Chime</i>	The console warning chime can be turned on or off.
<i>MIDI</i>	The console device number is for future use. This configuration is also used to activate the DMX 512 INPUT option, if installed.
<i>Mouse type</i>	Set this to 0 for no mouse, 1 for three button mouse, 2 for two button mouse.
<i>Lock Mode</i>	If the lock mode is turned on, any console function that alters memory, such as Record, will be locked out.
<i>Access Code</i>	The user may change the access code for entering this display and clearing memory. Once the configuration has been selected using the data entry keys, changes are made to each digit using the up/down cursor keys and the modified digit is determined using the right/left cursor keys. <b>Caution should be used when changing this number since its knowledge is necessary for any future changes made to console configurations.</b>

**NOTE: A SPECIAL MASTER CODE IS PROVIDED ON THE NEXT PAGE. Remove this page if you want security.**

# 11 Sample Printer Reports

## Cue List

Cue Number	Up	Down	Delay	Link	Wait	Chase	Rate	Macro
1.0	00:05.0	00:05.0	00:00.0		00:00.0	01	050	
1.1	00:19.8	00:19.8	00:00.0	2.7	00:25.0	01	050	
2.7	00:06.2	00:06.2	00:00.0		00:00.0	00	000	
3.2	00:15.8	00:15.8	00:00.0		00:00.0	00	000	
4.1	00:10.2	00:10.2	00:00.0		00:00.0	00	000	F1
5.2	00:01.0	00:19.8	00:00.0		00:00.0	00	000	
6.8	00:03.6	00:16.0	00:00.0		00:00.0	00	000	
7.0	00:15.8	00:15.8	00:00.0		00:00.0	00	000	SUB1
8.5	00:06.6	00:25.8	00:00.0		00:00.0	00	000	
9.3	00:06.7	00:06.7	00:00.0		00:00.0	00	000	
10.7	00:23.3	00:03.6	00:00.0		00:00.0	00	000	
11.7	00:20.5	00:20.5	00:00.0		00:00.0	00	000	
12.3	00:00.2	00:00.2	00:00.0		00:00.0	00	000	
13.5	00:26.1	00:26.1	00:00.0		00:00.0	00	000	
14.4	00:14.3	00:14.3	00:00.0		00:00.0	00	000	
15.4	00:00.0	00:00.0	00:00.0		00:00.0	00	000	
16.1	00:03.3	00:03.3	00:00.0		00:00.0	00	000	
17.5	00:01.9	00:01.9	00:00.0		00:00.0	00	000	
18.4	00:20.4	00:06.2	00:00.0		00:00.0	00	000	
19.8	00:05.4	00:05.4	00:00.0		00:00.0	00	000	
20.5	00:08.7	00:08.7	00:00.0		00:00.0	00	000	0
21.5	00:21.2	00:19.4	00:00.0		00:00.0	00	000	
22.4	00:00.2	00:00.2	00:00.0		00:00.0	00	000	
23.5	00:18.0	00:29.4	00:00.0		00:00.0	00	000	
24.2	00:04.2	00:02.5	00:00.0		00:00.0	00	000	
25.6	00:03.9	00:03.9	00:00.0		00:00.0	00	000	
26.4	00:17.6	00:17.6	00:00.0		00:00.0	00	000	
27.6	00:25.3	00:25.3	00:00.0		00:00.0	00	000	
28.1	00:16.6	00:16.6	00:00.0		00:00.0	00	000	
29.4	00:08.7	00:08.7	00:00.0		00:00.0	00	000	
30.9	00:27.8	00:27.8	00:00.0		00:00.0	00	000	
31.5	00:25.5	00:25.5	00:00.0		00:00.0	00	000	
32.2	00:27.1	00:27.1	00:00.0		00:00.0	00	000	
33.4	00:04.3	00:04.3	00:00.0		00:00.0	00	000	
34.8	00:05.0	00:05.0	00:00.0		00:00.0	00	000	
35.5	00:15.6	00:06.3	00:00.0		00:00.0	00	000	
36.2	00:26.8	00:26.8	00:00.0		00:00.0	00	000	
37.4	00:05.6	00:05.6	00:00.0		00:00.0	00	000	
38.1	00:10.4	00:10.4	00:00.0		00:00.0	00	000	
39.6	00:09.8	00:09.8	00:00.0		00:00.0	00	000	
40.1	00:18.3	00:18.3	00:00.0		00:00.0	00	000	

## 10

## Audio Operation

---

### Audio Sync

The Melange can use an audio signal to sync a chase running in submaster #8.

To utilize Audio Sync: Connect a line level audio signal to the Audio Input jack on the back of the console. The Melange contains it's own internal automatic gain control and it will adjust the signal to provide proper synchronization.

Whenever an audio source is detected, a chase in submaster #8 will automatically sync to it. If no audio source is present, the chase works as normal using the submaster's bump button to produce the rate.

In some cases the audio signal may not contain enough low frequency "beat" information to produce the desired results.

---

## Soft Patch List

### Proportional Patch

Channel 01: 01-03>FL  
Channel 02: 04>FL 05>85  
Channel 03: 06>FL  
Channel 04: 07>FL  
Channel 05: 08>95 09-11>FL  
Channel 06: 12>FL  
Channel 07: 13>95 14>FL  
Channel 08: 15>FL  
Channel 09: 16>FL  
Channel 10: 17-18>FL  
Channel 11: 19>FL  
Channel 12: 2075 21-22>FL  
Channel 13: 23-26>FL 129>FL  
Channel 14: 27>FL  
Channel 15: 28>FL 129>50  
Channel 16: 29>FL  
Channel 17: 30-32>FL 33>75  
Channel 18: 34>95 130-133>FL  
Channel 19: 35>FL  
Channel 20: 36>FL  
Channel 21: 37>FL  
Channel 22: 38>FL  
Channel 23: 39>FL 134>FL  
Channel 24: 40>FL  
Channel 25: 41>FL  
Channel 26: 42>FL 135>85  
Channel 27: 43>FL 136-140>FL  
Channel 28: 44>FL  
Channel 29: 45>FL 46>95  
Channel 30: 47>FL  
Channel 31:  
Channel 32:  
Channel 33:  
Channel 34:  
Channel 35:  
Channel 36:  
Channel 37:  
Channel 38:  
Channel 39:  
Channel 40:  
Channel 41:  
Channel 42:  
Channel 43:  
Channel 44:  
Channel 45:  
Channel 46:

Cue Detail

Cue Number	Up	Down	Delay	Link	Wait	Chase	Rate	Macro
1.1	00:19.8	00:19.8	00:00.0	2.7	00:25.0	01	050	

01 02 03 04 05 06 07 08 09 10 11 12 13 14 15 16 17 18 19 20 21 22 23 24 25 26  
79 07 49 45 10 95 70 53 97 32 95 93 53 56 67 70 74 66 45 33 15 73 54 42 05 76

27 28 29 30 31 32 33 34 35 36 37 38 39 40 41 42 43 44 45 46 47 48 49 50 51 52  
51 56 74 66 23 46 12 48 05 36 57 99 29 65 93 37 89 79 94 32 41 42

53 54 55 56 57 58 59 60 61 62 63 64 65 66 67 68 69 70 71 72 73 74 75 76 77 78

79 80 81 82 83 84 85 86 87 88 89 90 91 92 93 94 95 96 97 98 99 00 01 02 03 04

05 06 07 08 09 10 11 12 13 14 15 16 17 18 19 20 21 22 23 24 25 26 27 28

Cue Number	Up	Down	Delay	Link	Wait	Chase	Rate	Macro
2.7	00:06.2	00:06.2	00:00.0		00:00.0	00	000	

01 02 03 04 05 06 07 08 09 10 11 12 13 14 15 16 17 18 19 20 21 22 23 24 25 26  
68 71 93 26 51 47 13 48 60 17 32 24 56 81 12 07 16 71 52 93 61 55 71 43 10

27 28 29 30 31 32 33 34 35 36 37 38 39 40 41 42 43 44 45 46 47 48 49 50 51 52  
34 83 91 45 19 82 57 84 11 98 58 61 69 85 38 22 06 35 27 58 10 17

53 54 55 56 57 58 59 60 61 62 63 64 65 66 67 68 69 70 71 72 73 74 75 76 77 78

79 80 81 82 83 84 85 86 87 88 89 90 91 92 93 94 95 96 97 98 99 00 01 02 03 04

05 06 07 08 09 10 11 12 13 14 15 16 17 18 19 20 21 22 23 24 25 26 27 28

---

## Chase Detail

### Chase 01

Step 01: 01 03 06  
Step 02: 69 70 71 121 125 126  
Step 03: 11 14 38 42 91  
Step 04: 06 31 63 64 65 91 117  
Step 05: 08 31 55 57 72 73 76  
Step 06: 45 46 48 74 75 79 101  
Step 07: 24 26 31 78 79 82  
Step 08: 91 93 117 120  
Step 09: 57 58 109 113 117  
Step 10: 46 47 48 53 54 61  
Step 11: 123 124 125 126  
Step 12: 123 124 125 126  
Step 13: 46 48 50  
Step 14: 123 125 126

### Chase 02

Step 01: 01 03 05 07  
Step 02: 02 04 06 08  
Step 03: 03 05 07 09  
Step 04: 04 06 08 10  
Step 05: 05 07 09 11  
Step 06: 06 08 10 12  
Step 07: 07 09 11 13  
Step 08: 08 10 12 14  
Step 09: 09 11 13 15  
Step 10: 10 12 14 16  
Step 11: 11 13 15 17  
Step 12: 12 14 16 18  
Step 13: 13 15 17 19  
Step 14: 14 16 18 20  
Step 15: 15 17 19 21  
Step 16: 16 18 20 22  
Step 17: 17 19 21 23  
Step 18: 18 20 22 24  
Step 19: 19 21 23 25  
Step 20: 20 22 24 26



# Submaster Page Detail

## Submaster Page Number 1

### Submaster 1

01	02	03	04	05	06	07	08	09	10	11	12	13	14	15	16	17	18	19	20	21	22	23	24	25	26
	54				34						46														
27	28	29	30	31	32	33	34	35	36	37	38	39	40	41	42	43	44	45	46	47	48	49	50	51	52
			46	78			FL	67										FL							
53	54	55	56	57	58	59	60	61	62	63	64	65	66	67	68	69	70	71	72	73	74	75	76	77	78
					98																				
79	80	81	82	83	84	85	86	87	88	89	90	91	92	93	94	95	96	97	98	99	00	01	02	03	04
										82			95												
05	06	07	08	09	10	11	12	13	14	15	16	17	18	19	20	21	22	23	24	25	26	27	28		
							81														72				

### Submaster 2

01	02	03	04	05	06	07	08	09	10	11	12	13	14	15	16	17	18	19	20	21	22	23	24	25	26
					89						FL									62					
27	28	29	30	31	32	33	34	35	36	37	38	39	40	41	42	43	44	45	46	47	48	49	50	51	52
53	54	55	56	57	58	59	60	61	62	63	64	65	66	67	68	69	70	71	72	73	74	75	76	77	78
													50						48			59			
79	80	81	82	83	84	85	86	87	88	89	90	91	92	93	94	95	96	97	98	99	00	01	02	03	04
									81				99												
05	06	07	08	09	10	11	12	13	14	15	16	17	18	19	20	21	22	23	24	25	26	27	28		
																49			62			56			

## 12

## Additional Dimmer Protocols

---

### AMX-192

A 4-pin XLR connector and harness that Matches the USITT standard for AMX-192 is available from NSI. Ask your NSI Dealer to order part number OPT-00192-0.

NOTE: DMX and MICROPLEX will not function simultaneously with AMX 192

---

### DMX-512 Input.

An option is available which will allow another NSI or other control console, which can output DMX-512, to be connected to the Melange as a control input. With this configuration, you can use the other console to compose cues and provide more "real-time" control. Any Softpatch built into the other console will patch to the Melange's 128 control channels. Contact your NSI dealer for details.

---

## Macro Detail

Macro 0: F4, F1, 1, 2, F1, 1, F1, F1, F4

Macro 1: F4, F2, F2, 1, 0, ENTER, 1, 2, AT/.,  
FULL, F4

Macro 2: SUB8, SUB6, SUB4, SUB2, SUB1, SUB3,  
SUB5, SUB7

Macro 3: LOAD SUBS, SUB1, 1, AT/., 1, ENTER,  
LOAD SUBS, SUB2, 2, AT/., 7, ENTER

Macro 4:

Macro 5: LOAD SUBS, SUB7, F1

Macro 6: LOAD A, 1, AT/., 1, ENTER, LOAD B, 2,  
AT/., 7, ENTER

Macro 7: LOAD AUTOS, 3, AT/., 2, GO C

Macro 8: SELECT, SELECT, LOAD AUTOS, 4, AT/.,  
1, ENTER

Macro 9: TOGGLE, SUB1, TOGGLE, SUB2, TOGGLE,  
SUB3, TOGGLE, SUB4, TOGGLE, SUB5, TOGGLE, SUB6, TOGGLE, SUB7, TOGGLE,  
SUB8

Macro SUB1:

Macro SUB2:

Macro SUB3:

Macro SUB4:

Macro SUB5:

Macro SUB6:

Macro SUB7:

Macro SUB8:

Macro F1:

# 14

## Service Information

---

### Schematics

# 13

## Specifications

---

### Console Specifications

Cue Capacity	999, 16 channel cues. 400, 128 channel cues.
Maximum Channels	128
Maximum Dimmers	512, DMX 512 interface 128, Microplex interface 192, AMX-192 interface
Maximum Fade Time	99 minutes, 59.9 seconds
Maximum Submaster Pages	99
Maximum Chases	99
Maximum Chase steps	250
Softpatch	Proportional
Softpatch Capacity	8 channels for each dimmer
Macros	22
Non-volatile Memory size	64K
Non-volatile Memory Type	EEPROM (10 year retention)
DC power required	13.5 - 18 volts DC, 250ma.
Video Interface	15 pin std VGA Color.
Printer Interface	25 pin parallel
Audio Interface	RCA phono jack
Audio Sensitivity	100mv to 10volts RMS
Dimensions	3" x 24" x 12"
Weight	12 lbs.



