



I/F 501

INTERFACE UNIT

INSTALLATION AND OPERATION GUIDE

Software Revision 1.05, Version A

INTRODUCTION

The I/F 501 interface unit allows a variety of communication protocols used in NSI and other industrial equipment to be translated between one another. In addition the I/F 501 can serve as an independent, programmable lighting controller. The I/F 501 also serves as the interface between NSI's Luma-net network and a personal computer.

SPECIFICATIONS:

Microplex Input (I/O)	3 pin XLR male
Microplex Output (I/O)	3 pin XLR female
DMX 512 Input	5 pin XLR male (USITT spec)
DMX 512 Output	5 pin XLR female (USITT spec)
AMX 192 Output (optional, replaces 512)	4 pin XLR female (USITT spec)
RS-232 I/O	9 pin 'D' connector
MIDI input / Analog input	5 pin din 180 degree connector
Luma-net I/O	Modular style telephone connector
Power requirements	+15VDC 200ma (power supply included)

IMPORTANT

Although many different connectors are present on this unit, in most configurations, one or more of the connectors may serve no function. It is important that the installer verify that the required inputs and outputs operated in the mode required for the application. Please read the appropriate application sheets in this manual carefully before installing.

Front Panel

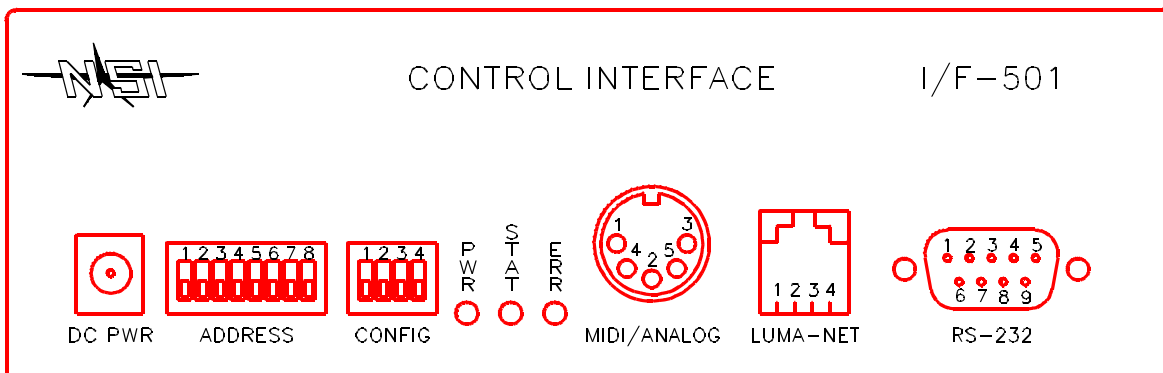

- 1 DC Power input - Connect 15VDC (+ tip, - ring) 250ma here. (Supplied with unit.)
- 2 Address - Controls translation of addresses (and other special functions). See individual applications details.
- 3 Config - Determines the operating mode of the unit.
- 4 PWR - Indicates presence of +15VDC
- 5 STAT - Usually indicates presence of input signal.
- 6 ERR - Indicates an input signal error.
- 7 MIDI/ANALOG - Midi input or analog input depending on application.
- 8 LUMA-NET I/O - Connects to a Luma-net network.
- 9 RS-232 - Connects to a personal computer.

Rear Panel

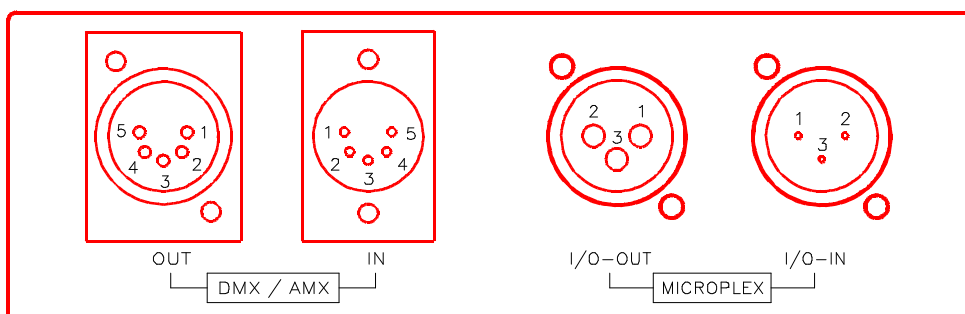

- 1 MICROPLEX IN - Input Microplex here. Also may serve as pass- through I/O in some applications.
- 2 MICROPLEX OUT - Output Microplex here. Also may serve as pass-through I/O in some applications.
- 3 DMX 512 IN - Input DMX 512 here.
- 4 DMX 512 (AMX 192) OUT - Output DMX 512 here (or optionally AMX 192).

JUMPER LOCATIONS

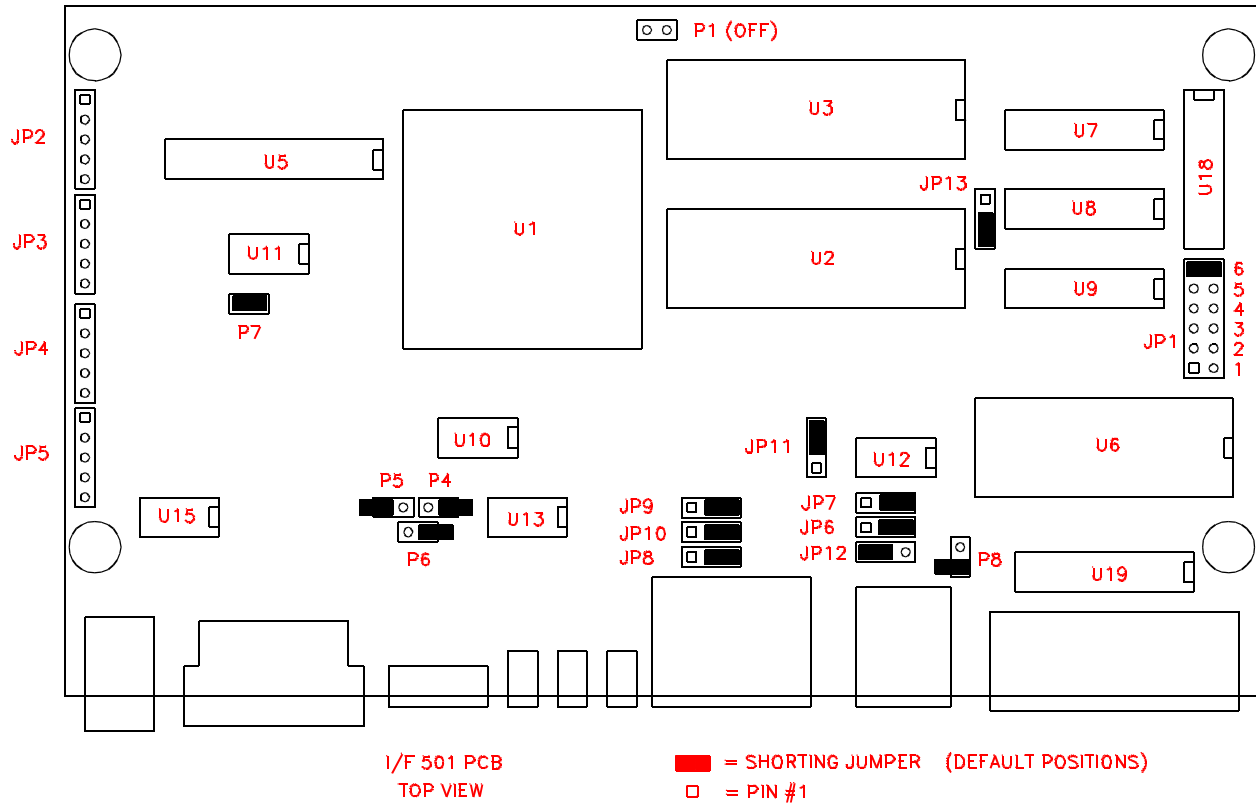

PCB locations of jumpers / internal connectors

I/F 501 JUMPER CHANGE QUICK REFERENCE CHART

INPUT -> OUTPUT	CONFIG SWITCH d-down u-up 1234	P4 P5	P7	JP1	JP6 JP7	JP8 JP9	JP10	JP11	JP12	DMX OUT CONN
DEFAULT SETTINGS	dddd	OFF	ON	6	2-3	2-3	2-3	2-3	1-2	JP4
MPX -> DMX	dddd									
MPX -> AMX	uddd		OFF							JP3
DMX -> MPX	dudd	ON								
MIDI -> MPX/DMX	uudd			2		1-2	1-2		2-3	
MIDI -> AMX	ddud		OFF	2		1-2	1-2		2-3	JP3
RS-232 -> MPX/DMX	udud				1-2					
RS-232 -> AMX	duud		OFF		1-2					JP3
LUMANET/MPX/DMX -> MPX	uuud	ON		2						
LUMANET/MPX -> DMX	dddu			2						
LUMANET/MPX -> AMX	uddu		OFF	2						JP3
MPX/DMX/ANALOG -> MPX/DMX	dudu									
MPX/DMX/ANALOG -> AMX	uudu		OFF							JP3
AUTO-CHASE -> MPX	dduu									
RS-232 AUTO-CUEING -> MPX/DMX	uduu				1-2			1-2		
IF-501 (AS 404CP) -> LUMANET	duuu				1-2			1-2		
RS-232 -> LUMANET	uuuu				1-2			1-2		

Set to default settings, then change as indicated for specific mode.

MPX = N.S.I. Microplex

JP13 = 2-3

DMX = DMX-512

MIDI = Musical Instrument Digital Interface

P6 = OFF (no termination)

AMX = AMX-192

or ON to terminate DMX lines

RS-232 = RS-232C Serial data protocol

LUMANET = N.S.I. Lumanet architectural protocol

P8 = OFF (no termination)

ANALOG = 0 - 10 VDC continuous voltage control

or ON to terminate Lumanet lines

IF-501 = N.S.I. protocol translator / controller

404CP = N.S.I. architectural control panel

PINOUTS

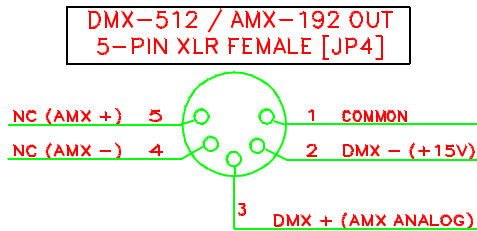
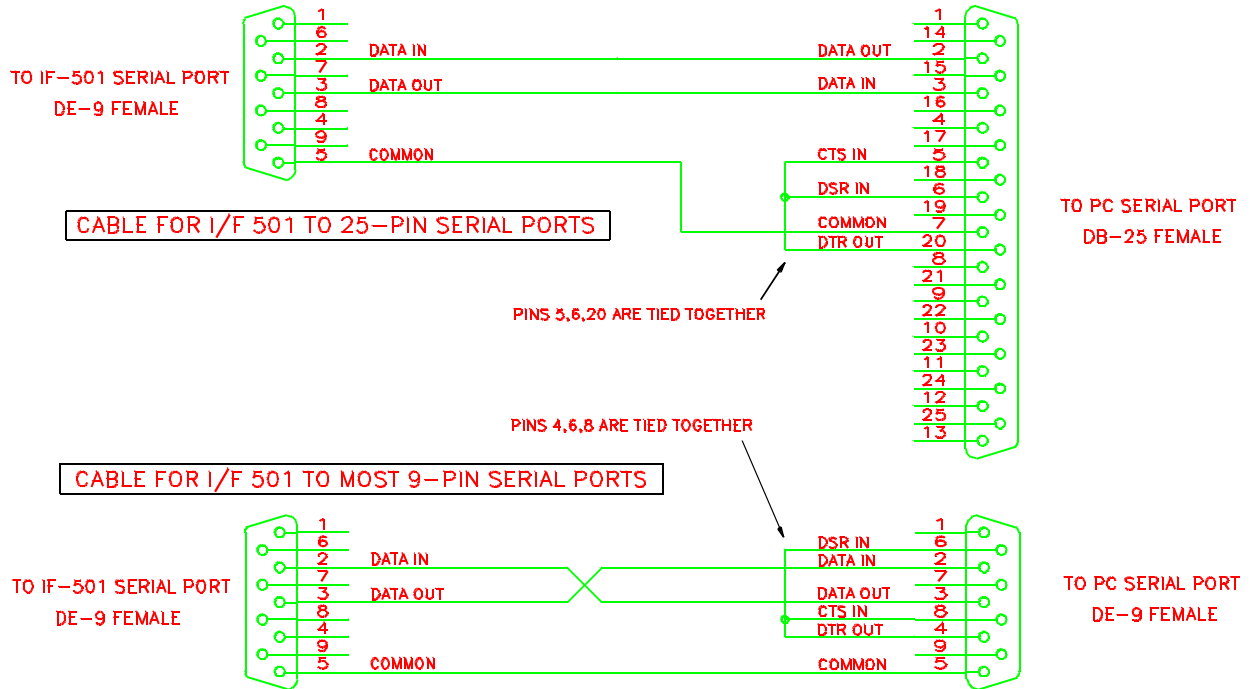

PLEASE NOTE THAT () INDICATES AMX-192 MODE
CAUTION +15V ON PIN-2 IN AMX-192 MODE

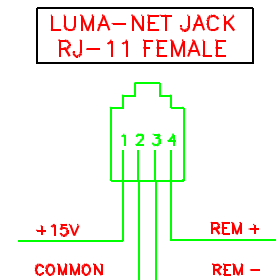
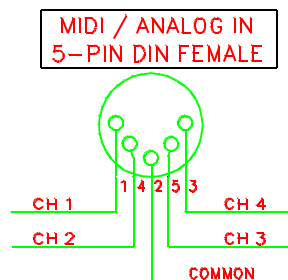
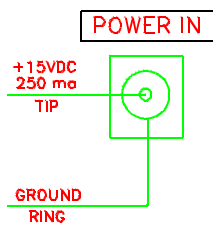
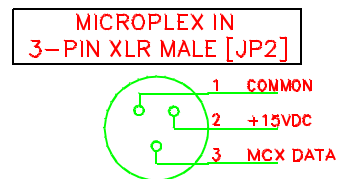
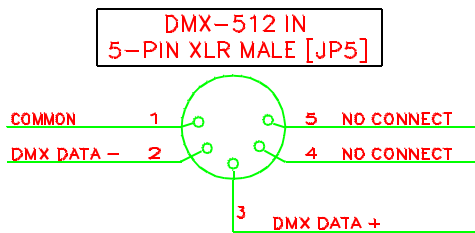
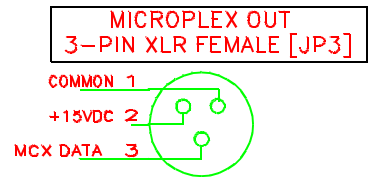

Pinouts of the various connectors

MICROPLEX TO AMX 192

In this application, Microplex is converted to AMX-192. The 5 pin XLR may be replaced with a 4 pin XLR (USITT) if desired.

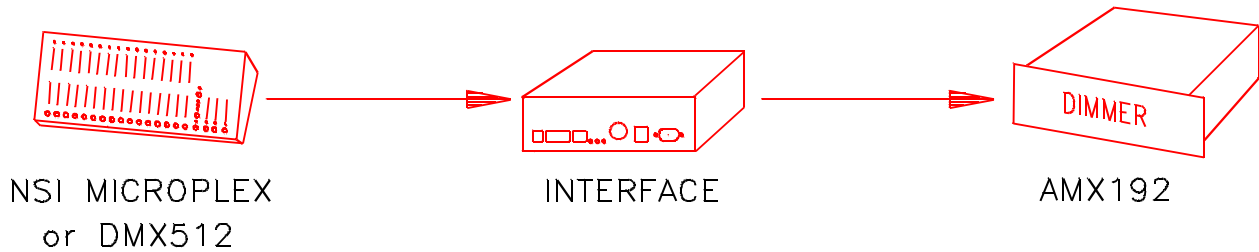

JUMPER LOCATIONS

P4 & 5 OPEN	P7 OPEN	JP6 & 7 N/A	JP8 & 9 N/A	JP10 2-3	JP11 2-3	JP12 N/A	JP13 2-3
P6 N/A		P8 N/A		JP1 N/A		DMX OUT CABLE JP3	

DIPSWITCH POSITIONS

C1 UP	C2 DN	C3 DN	C4 DN	ADDRESS 1 - 7 N/A	A8 DN:64
----------	----------	----------	----------	----------------------	-------------

CONNECTOR	OPERATION
Microplex IN	Input Microplex
Microplex OUT	Not Used
DMX IN	Not used
*DMX out	Output AMX 192 (64 or 128 channels)
MIDI / Analog	Not used
Luma-net	Not Used
RS-232	Not Used

Microplex is converted channel to channel so address is not used.

AMX output is sent as either 64 or 128 channels, depending on the setting of switch A8.

*IMPORTANT - Move AMX output connector jumper from JP4 to JP3.

MIDI TO AMX-192

In this application, MIDI is converted to AMX 192.

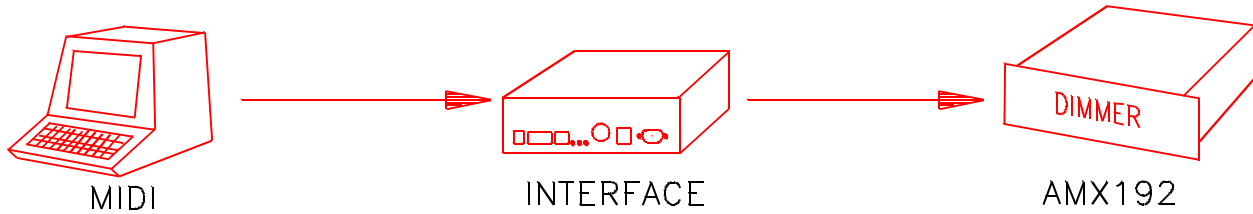

JUMPER LOCATIONS

P4 & 5	P7	JP6 & 7	JP8 & 9	JP10	JP11	JP12	JP13
OPEN	OPEN	N/A	1-2	1-2	2-3	2-3	2-3
P6		P8		JP1		DMX OUT CABLE	
N/A		N/A		POSITION 2		JP3	

DIPSWITCH POSITIONS

C1	C2	C3	C4	ADDRESS 1 - 7	A8
DN	DN	UP	DN	A1-4 SELECTS MIDI CHAN, A5 UP SETS IGNORE NTOFF	DN:64

CONNECTOR	OPERATION
Microplex IN	Not used
Microplex OUT	Not Used
DMX IN	Not used
*DMX out	Output AMX 192 (64 or 128 ch)
MIDI / Analog	MIDI Input
Luma-net	Not Used
RS-232	Not Used

MIDI Channel 1 - 16 can be selected with switch A1-4 (see chart at end).

Velocity of MIDI Note On messages set respective dimmer levels. C0 = dimmer channel 1.

Note Off (or Note On = 0) will turn off channel unless A5 is in the up position.

AMX output is sent as either 64 or 128 channels, depending on the setting of switch A8.

***IMPORTANT - Move AMX output connector jumper from JP4 to JP3.**

RS-232 to MICROPLEX and DMX 512

In this application, a computer may send simple ASCII commands to operate individual dimmer channels.

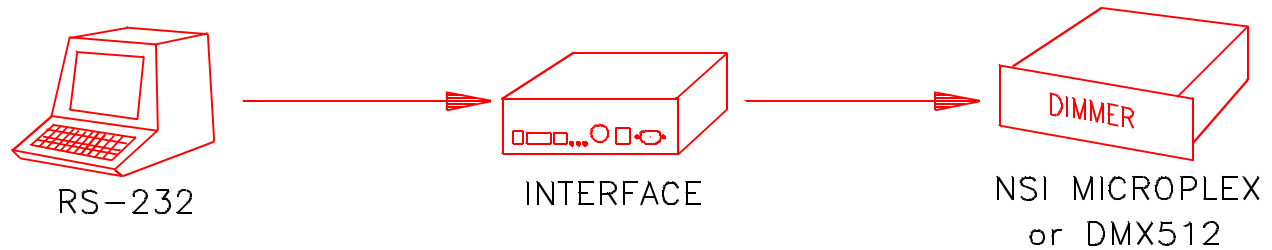

JUMPER LOCATIONS

P4 & 5	P7	JP6 & 7	JP8 & 9	JP10	JP11	JP12	JP13
OPEN	CLOSED	1-2	N/A	2-3	2-3	1-2	2-3
P6		P8		JP1		DMX OUT CABLE	
N/A		N/A		POS 5 OR 6 (BELOW)		JP4	

DIPSWITCH POSITIONS

C1	C2	C3	C4	ADDRESS 1 - 7	A8
UP	DN	UP	DN	N/A	DN:64

CONNECTOR	OPERATION
Microplex IN	Not Used
Microplex OUT	Output Microplex (64 or 128)
DMX IN	Not used
DMX out	Output DMX 512 (64 or 128)
MIDI / Analog	Not used
Luma-net	Not Used
RS-232	RS-232 Input

Baudrate is either 9600 (JP1 - 6) or 2400 (JP1 - 5) with 8 data bits, 1 stop bit, no parity

Dimmer channels 1 to 100 can be controlled with these simple ASCII commands:

ASCII characters supported: F D G R - @ + : . 0-9

Fxx:xx.x (FADERATE, x=fade time in minutes : seconds . tenths),

Dccc-ccc@xxx (DIMMER LEVEL, c=channel number, -=to, +=and, x= level)

G (EXECUTE) R (RESET or BLACKOUT)

Carriage return after each command. Max fade time is 50 minutes.

DMX and Microplex output is sent as either 64 or 128 channels, depending on the setting of switch A8.

RS-232 TO AMX 192

In this application, a personal computer may send ascii commands to operate individual dimmer channels.

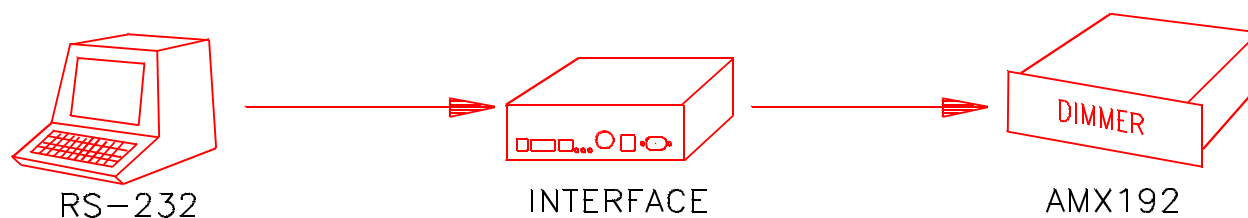

JUMPER LOCATIONS

P4 & 5	P7	JP6 & 7	JP8 & 9	JP10	JP11	JP12	JP13
OPEN	OPEN	1-2	N/A	2-3	2-3	1-2	2-3
P6		P8		JP1		DMX OUT CABLE	
N/A		N/A		POS 5 OR 6 (BELOW)		JP3	

DIPSWITCH POSITIONS

C1	C2	C3	C4	ADDRESS 1 - 7	A8
DN	UP	UP	DN	N/A	DN:64

CONNECTOR	OPERATION
Microplex IN	Not Used
Microplex OUT	Not Used
DMX IN	Not used
*DMX out	Output AMX 192 (64 or 128)
MIDI / Analog	Not used
Luma-net	Not Used
RS-232	Input RS-232

Baudrate is either 9600 (JP1 - 6) or 2400 (JP1 - 5) with 8 data bits, 1 stop bit, no parity

Dimmer channels 1 to 100 can be controlled with these simple ASCII commands:

ASCII characters supported: F D G R - @ + : . 0-9

Fxx:xx.x (FADERATE, x=fade time in minutes : seconds . tenths),

Dccc-ccc@xxx (DIMMER LEVEL, c=channel number, -=to, +=and, x= level)

G (EXECUTE) R (RESET or BLACKOUT)

Carriage return after each command. Max fade time is 50 minutes.

Max fade time is 50 minutes.

AMX output is sent as either 64 or 128 channels, depending on the setting of switch A8.

*IMPORTANT - Move AMX output connector jumper from JP4 to JP3.

LUMA-NET to MICROPLEX

In this application, Microplex or DMX is mixed with LUMA-NET and transmitted as Microplex.

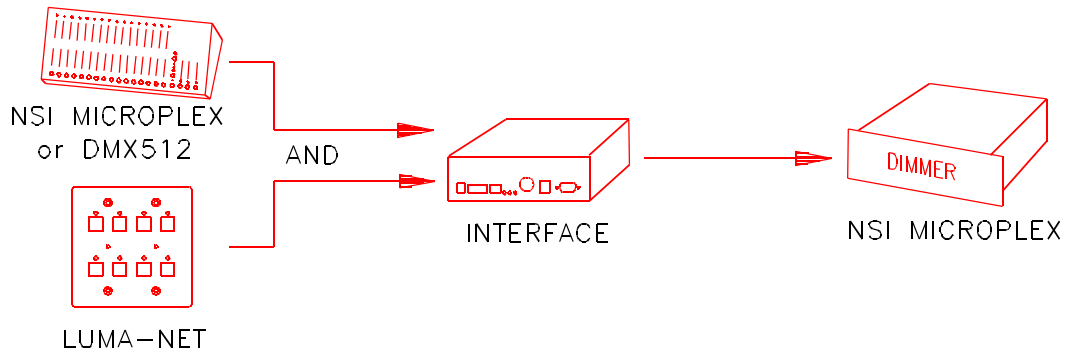

JUMPER LOCATIONS

P4 & 5	P7	JP6 & 7	JP8 & 9	JP10	JP11	JP12	JP13
CLOSED	CLOSED	2-3	N/A	2-3	2-3	1-2	2-3
P6		P8		JP1		DMX OUT CABLE	
*CLOSE TO TERM DMX		CLOSE TO TERM LUMA		POSITION 2		JP4	

DIPSWITCH POSITIONS

C1	C2	C3	C4	ADDRESS 1 - 7	A8
UP	UP	UP	DN	STARTING ADDR OF LUMA-NET IN 16 INCREMENT	DN:64

CONNECTOR	OPERATION
Microplex IN	Input Microplex
Microplex OUT	Retransmitting Microplex (64 or 128)
DMX IN	Input DMX 512
DMX out	Pass through DMX-512
MIDI / Analog	Not used
Luma-net	Luma-net network
RS-232	Not Used

Allows 128 channels of Luma-net to be merged with microplex in a "last action takes precedence" fashion.

Terminate DMX or Luma-net by closing jumper P6 or P8 only if last device on line.

*DMX should only be terminated internally if IF501 will be always last unit at end of DMX line. A better way to terminate is to connect 120ohm resistor to a female DMX cable end (pins 2-3) and plug it into the pass-through of the last unit on the DMX line.

See operator's manual of Luma-net device for additional information.

Microplex output is sent as either 64 or 128 channels, depending on the setting of switch A8.

LUMA-NET to DMX-512

In this application, Microplex or DMX is mixed with LUMA-NET and transmitted as DMX 512.

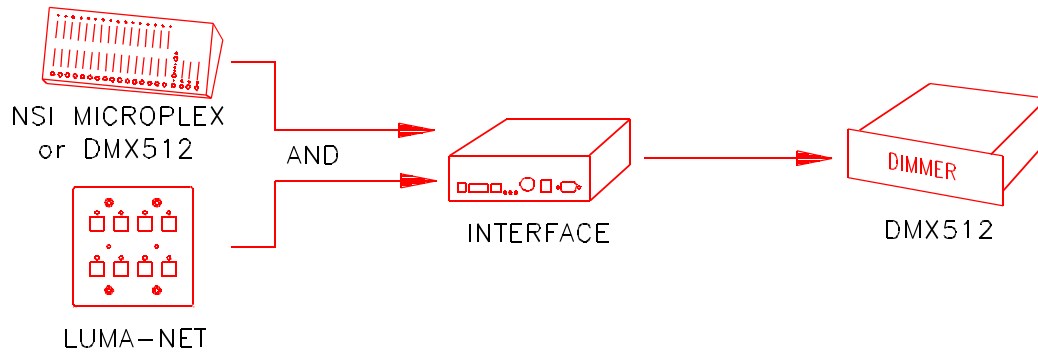

JUMPER LOCATIONS

P4 & 5 OPEN	P7 N/A	JP6 & 7 2-3	JP8 & 9 N/A	JP10 2-3	JP11 2-3	JP12 1-2	JP13 2-3
P6 CLOSE		P8 CLOSE TO TERM LUMA		JP1 POSITION 2		DMX OUT CABLE JP4	

DIPSWITCH POSITIONS

C1 DN	C2 DN	C3 DN	C4 UP	ADDRESS 1 - 7 STARTING ADDR OF LUMA-NET IN 16 INCREMENT	A8
----------	----------	----------	----------	--	----

CONNECTOR	OPERATION
Microplex IN	Input Microplex
Microplex OUT	Not Used
DMX IN	Input DMX 512
DMX out	Output new DMX-512
MIDI / Analog	Not used
Luma-net	Luma-net network
RS-232	Not Used

Allows 128 channels of Luma-net to be merged with DMX 512 in a "last action takes precedence" fashion.

Terminate Luma-net by closing jumper P8 only if last device on line.

Input of IF 501 is always last device at end of source DMX line.

See operator's manual of Luma-net device for additional information.

DMX output is sent as either 64 or 128 channels, depending on the setting of switch A8.

LUMA-NET to AMX - 192

In this application, Microplex or DMX is mixed with LUMA-NET and transmitted as AMX-192.

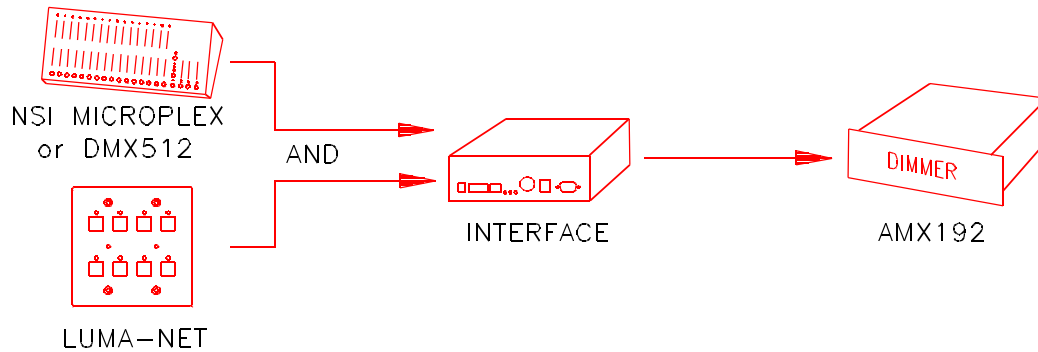

JUMPER LOCATIONS

P4 & 5	P7	JP6 & 7	JP8 & 9	JP10	JP11	JP12	JP13
OPEN	OPEN	2-3	N/A	2-3	2-3	1-2	2-3
P6		P8		JP1		DMX OUT CABLE	
CLOSE		CLS TO TERM LUMA		POS 2		JP3	

DIPSWITCH POSITIONS

C1	C2	C3	C4	ADDRESS 1 - 7	A8
UP	DN	DN	UP	STARTING ADDR OF LUMA-NET IN 16 INCREMENT	DN:64

CONNECTOR	OPERATION
Microplex IN	Input Microplex
Microplex OUT	Not Used
DMX IN	Input DMX 512
*DMX out	Output AMX-192
MIDI / Analog	Not used
Luma-net	Luma-net network
RS-232	Not Used

Allows up to 128 channels of Luma-net to be merged with DMX or Microplex and output as AMX 192 in a "last action takes precedence" fashion.

Terminate Luma-net by closing jumper P8 only if last device on line.

IF 501 is always last device at end of DMX line.

See operator's manual of Luma-net device for additional information.

AMX output is sent as either 64 or 128 channels, depending on the setting of switch A8.

*IMPORTANT - Move AMX output connector jumper from JP4 to JP3.

ANALOG TO / MERGED WITH DMX 512 and MICROPLEX

In this application, 0 to 10VDC is converted to Microplex or and DMX 512..

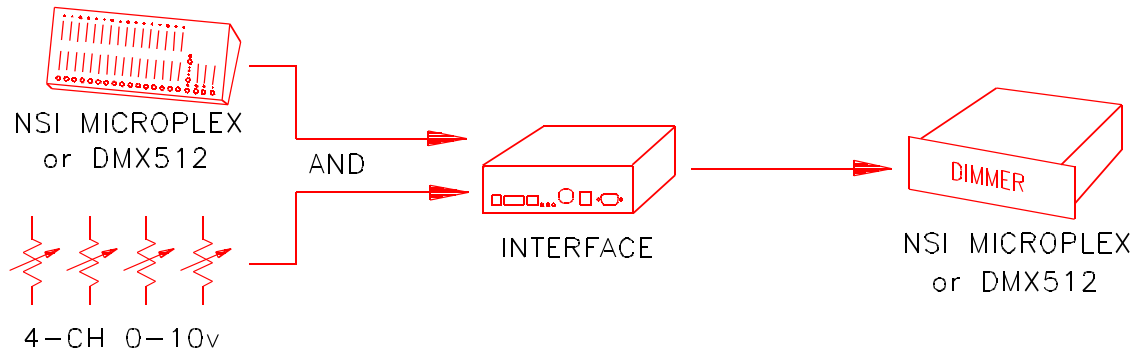

JUMPER LOCATIONS

P4 & 5	P7	JP6 & 7	JP8 & 9	JP10	JP11	JP12	JP13
OPEN	CLOSED	N/A	2-3	2-3	2-3	N/A	2-3
P6		P8		JP1		DMX OUT CABLE	
*CLOSE TO TERM DMX		N/A		N/A		JP4	

DIPSWITCH POSITIONS

C1	C2	C3	C4	ADDRESS 1 - 7	A8
DN	UP	DN	UP	STARTING ADDR OF ANALOG CHAN 1 BY 1 INCREMENT	DN:64

CONNECTOR	OPERATION
Microplex IN	Input Microplex
Microplex OUT	Output Microplex (64 or 128)
DMX IN	Input DMX 512
DMX out	Output new DMX 512
MIDI / Analog	0-10VDC input
Luma-net	Not Used
RS-232	Not Used

Four analog 0-10V channels are merged with DMX-512 or Microplex and output as DMX-512 and Microplex.

Channel number of first analog channel is determined by A1-7.

DMX and Microplex output is sent as either 64 or 128 channels, depending on the setting of switch A8.

*Close P6 if inputting DMX. IF 501 is always last device at end of DMX line.

ANALOG TO AMX-192

In this application, 0 - 10VDC is converted to AMX 192.

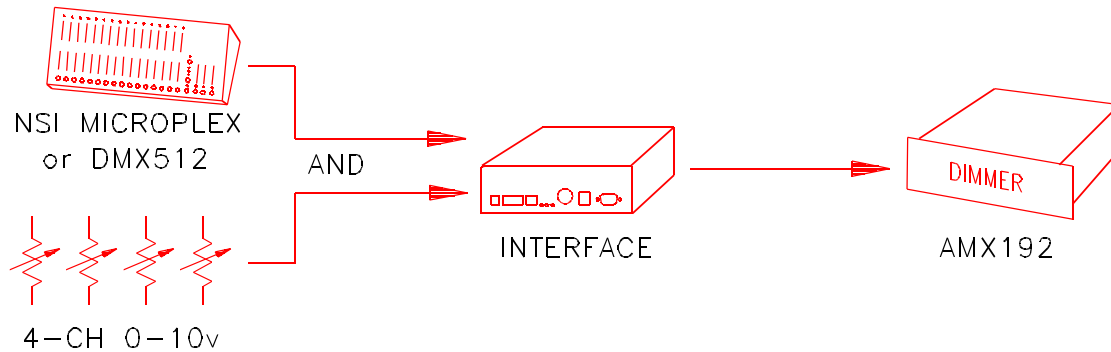

JUMPER LOCATIONS

P4 & 5	P7	JP6 & 7	JP8 & 9	JP10	JP11	JP12	JP13
OPEN	OPEN	N/A	2-3	2-3	2-3	N/A	2-3
P6		P8		JP1		DMX OUT CABLE	
*CLOSE TO TERM DMX		N/A		N/A		JP3	

DIPSWITCH POSITIONS

C1	C2	C3	C4	ADDRESS 1 - 7	A8
UP	UP	DN	UP	STARTING ADDR OF ANALOG CHAN 1 BY 1 INCREMENT	

CONNECTOR	OPERATION
Microplex IN	Input Microplex
Microplex OUT	Not Used
DMX IN	Input DMX 512
**DMX out	Output AMX 192
MIDI / Analog	0-10VDC input
Luma-net	Not Used
RS-232	Not Used

Four analog 0-10V channels are merged with DMX-512 or Microplex and output as AMX-192.

Channel number of first analog channel is determined by A1-7.

AMX output is sent as either 64 or 128 channels, depending on the setting of switch A8.

*Close P6 if inputting DMX. IF 501 is always last device at end of DMX line.

**IMPORTANT - Move AMX output connector jumper from JP4 to JP3.

AUTOCHASE TO MICROPLEX AND DMX 512.

In this application, the unit serves as a stand alone chaser.

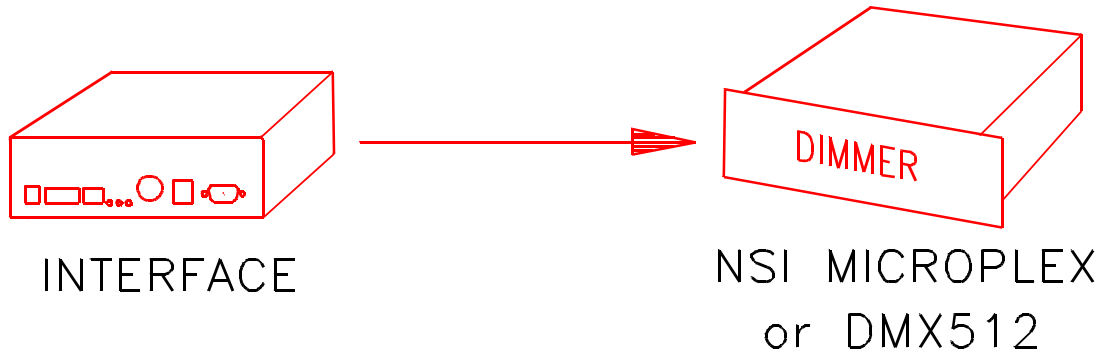

JUMPER LOCATIONS

P4 & 5 N/A	P7 CLOSED	JP6 & 7 N/A	JP8 & 9 N/A	JP10 2-3	JP11 2-3	JP12 N/A	JP13 2-3
P6 N/A		P8 N/A		JP1 N/A		DMX OUT CABLE JP4	

DIPSWITCH POSITIONS

C1 DN	C2 DN	C3 UP	C4 UP	ADDRESS 1 - 7 SETS CHASE PATTERN AND SPEED	A8 DN:64
----------	----------	----------	----------	---	-------------

CONNECTOR	OPERATION
Microplex IN	Not Used
Microplex OUT	Output Microplex (64 or 128)
DMX IN	Not Used
DMX out	Output DMX 512 (64 or 128)
MIDI / Analog	Not Used
Luma-net	Not Used
RS-232	Not Used

See chase speed and pattern chart at then end of the guide for settings of A1-7.

DMX and Microplex output is sent as either 64 or 128 channels, depending on the setting of switch A8.

RS-232 AUTO-CUEING TO MICROPLEX AND DMX.

In this application, the unit serves as a stand alone programmable memory lighting controller with precise timed crossfading. Optionally contact closures serve for manual control.

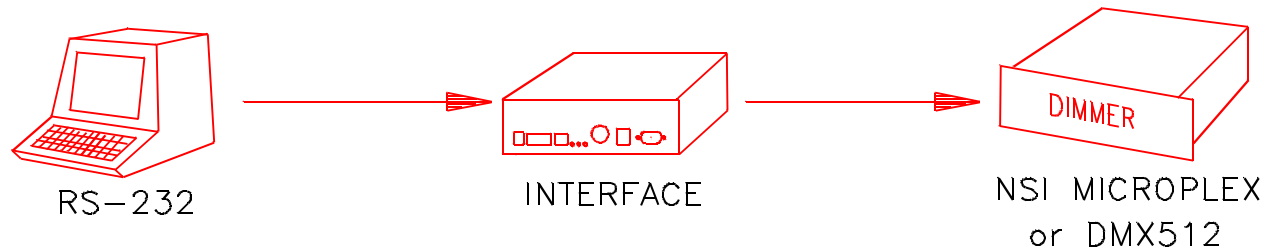

JUMPER LOCATIONS

P4 & 5	P7	JP6 & 7	JP8 & 9	JP10	JP11	JP12	JP13
N/A	CLOSED	1-2	2-3	2-3	1-2	1-2	2-3
P6		P8		JP1		DMX OUT CABLE	
N/A		N/A		SETS BAUD RATE		JP4	

DIPSWITCH POSITIONS

C1	C2	C3	C4	ADDRESS 1 - 7	A8
UP	DN	UP	UP	N/A	N/A

CONNECTOR	OPERATION
Microplex IN	Not Used
Microplex OUT	Output Microplex (16 channels)
DMX IN	Not Used
DMX out	Output DMX 512 (16 channels)
MIDI / Analog	Contact Closures
Luma-net	Not Used
RS-232	Personal Computer or Melange (for programming).

Use analog input for optional contact closures:
 1-2 STOP NOW, 4-2 STOP AT END OF CHAIN, 5-2 REWIND AND B/O, 3-2 STOP AT END OF CUE.

Only the first 16 channels are sent. 20 ASCII cues max. can be down loaded via the RS-232 port of a PC or Melange.

Cue numbers are ignored, cues execute in the order they are down loaded.

Baudrate = 9600 baud (JP1 pos 6) or 2400 baud (JP1 pos 5), 8 bits, no parity, 1 stop bit, DTR-DSR handshake.

See chart at end of guide for ASCII CUE systax accepted.

LUMA-NET 404CP EMULATION WITH EXTERNAL CONTACTS.

In this application, the unit serves as a 404CP panel with external contact closures.

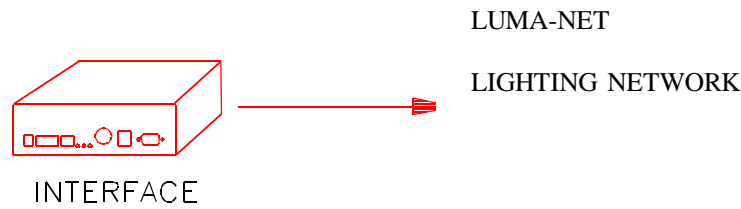

JUMPER LOCATIONS

P4 & 5	P7	JP6 & 7	JP8 & 9	JP10	JP11	JP12	JP13
OPEN	N/A	1-2	2-3	2-3	1-2	N/A	2-3
P6		P8		JP1		DMX OUT CABLE	
N/A		CLS TO TERM LUMA		N/A		JP4	

DIPSWITCH POSITIONS

C1	C2	C3	C4	ADDRESS 1 - 8
DN	UP	UP	UP	LUMANET NETWORK ID

CONNECTOR	OPERATION
Microplex IN	Not Used
Microplex OUT	Not Used
DMX IN	Not Used
DMX out	Not Used
MIDI / Analog	Contact Closures
Luma-net	Luma-net Network
RS-232	Not Used

Use analog input for contact closures:
 1-2 SCENE 1, 4-2 SCENE 2, 5-2 SCENE 3, SCENE 4.

Must be programmed from Luma-net PC Software and in conjunction with another IF 501.

IF-501 must has a different Network ID number than any other device (including other 501's).

See 404CP operator's guide for details on operation.

Caution Lumanet IF cable must be connected pin 1 to pin 1, pin 2 to pin 2, ect. Do not use a standard telephone cable to connect units unless polarization is confirmed.

LUMA-NET SOFTWARE INTERFACE.

This application is for use with the Luma-net Computer Software. This unit serves as the interface between the computer and the network.

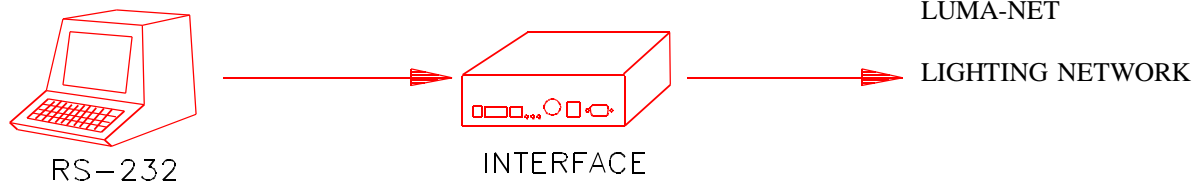

JUMPER LOCATIONS

P4 & 5 OPEN	P7 N/A	JP6 & 7 1-2	JP8 & 9 N/A	JP10 2-3	JP11 1-2	JP12 1-2	JP13 2-3
P6 N/A		P8 CLS TO TERM LUMA		JP1 BAUD RATE		DMX OUT CABLE JP4	

DIPSWITCH POSITIONS

C1 UP	C2 UP	C3 UP	C4 UP	ADDRESS 1 - 8
				NETWORK ID

CONNECTOR	OPERATION
Microplex IN	Not Used
Microplex OUT	Not Used
DMX IN	Not Used
DMX out	Not Used
MIDI / Analog	Not Used
Luma-net	Luma-net Network
RS-232	Personal Computer

Baudrate = 9600 baud (JP1 pos 6) or 2400 baud (JP1 pos 5), 8 bits, no parity, 1 stop bit, DTR-DSR handshake.

See Luma-net Software Operation Guide for more information.

Caution: Lumanet cable must be connected pin 1 to pin 1, pin 2 to pin 2, ect. Do not use a standard telephone cable to connect units unless polarization is confirmed.

Lumanet Channel number codes / dipswitch settings.

Multiply channel listed by increment required. Subtract one for Luma-net network ID no.

0 - switch down, 1 - switch up.

Lumanet Channel	Dipswitch 1234567	Lumanet Channel	Dipswitch 1234567	Lumanet Channel	Dipswitch 1234567	Lumanet Channel	Dipswitch 1234567
1	000000	33	000010	65	000001	97	000011
2	100000	34	100010	66	100001	98	100011
3	010000	35	010010	67	010001	99	010011
4	110000	36	110010	68	110001	100	110011
5	001000	37	001010	69	001001	101	001011
6	101000	38	101010	70	101001	102	101011
7	011000	39	011010	71	011001	103	011011
8	111000	40	111010	72	111001	104	111011
9	000100	41	000110	73	000101	105	000111
10	100100	42	100110	74	100101	106	100111
11	010100	43	010110	75	010101	107	010111
12	110100	44	110110	76	110101	108	110111
13	001100	45	001110	77	001101	109	001111
14	101100	46	101110	78	101101	110	101111
15	011100	47	011110	79	011101	111	011111
16	111100	48	111110	80	111101	112	111111
17	000010	49	000011	81	000010	113	000011
18	100010	50	100011	82	100010	114	100011
19	010010	51	010011	83	010010	115	010011
20	110010	52	110011	84	110010	116	110011
21	001010	53	001011	85	001010	117	001011
22	101010	54	101011	86	101010	118	101011
23	011010	55	011011	87	011010	119	011011
24	111010	56	111011	88	111010	120	111011
25	000110	57	000111	89	000110	121	000111
26	100110	58	100111	90	100110	122	100111
27	010110	59	010111	91	010110	123	010111
28	110110	60	110111	92	110110	124	110111
29	001110	61	001111	93	001110	125	001111
30	101110	62	101111	94	101110	126	101111
31	011110	63	011111	95	011110	127	011111
32	111110	64	111111	96	111110	128	111111

DMX 512 Channel number codes / dipswitch settings.

0 - switch down, 1 - switch up

1st DMX Channel	Dipswitch 1234567	1st DMX Channel	Dipswitch 1234567	1st DMX Channel	Dipswitch 1234567	1st DMX Channel	Dipswitch 1234567
1	000000	129	0001000	257	0000100	385	0001100
17	100000	145	1001000	273	1000100	401	1001100
33	010000	161	0101000	289	0100100	417	0101100
49	110000	177	1101000	305	1100100	433	1101100
65	001000	193	0011000	321	0010100	449	0011100
81	101000	209	1011000	337	1010100	465	1011100
97	011000	225	0111000	353	0110100	481	0111100
113	111000	241	1111000	369	1110100	497	1111100

ASCII Cues Implementation

Overview

Following are the rules for editing ASCII Cues as implemented on the IF501, software revision 1.00:

If you use a word processor for editing ASCII Cues you must set WORD WRAP OFF and the margin should be set to 80 characters per line. DO NOT use any "special" features; such as BOLD or UNDERLINING.

Format

Each line of an ASCII Cues file must begin with a keyword. Keywords may be up to eight characters and may only consist of letters A - Z, numbers, or the "\$" character.

Keywords cannot be shortened, but any number of spaces or tabs may be inserted before the keyword.

The maximum length of each line is 80 characters (including spaces).

Each line must be terminated with a CR or CR/LF (carriage return/line feed or "hard return").

The file may be as big as the word processor or editor may allow.

The file should end with a \$END keyword to make sure the IF501 records the last cue received.

Keywords Supported.

CUE

This keyword must start the description of each cue. This keyword is followed by a space and then the cue number in the range of ".1" to "999.9". The decimal point is not necessary if no decimal is specified.

Note: The Cue number is meaningless to the IF501 since it always executes cues in sequence received.

EXAMPLE: CUE 238.5

UP

This keyword specifies the fade up time of the new cue. This keyword must be followed by a space and the time in the range of "0" to "9:59.9". Minutes are optional but must be followed by a colon. In the absence of minutes, seconds may be specified up to "999.9". The decimal point is not necessary if no decimal is specified. If the UP keyword is not specified in a cue definition then either "0" or the UP value of the previous cue will be used.

EXAMPLE: UP 10.5

DOWN

This keyword specifies the fade down time of the previous cue. This keyword must be followed by a space and the time in the range of "0" to "9:59.9". Minutes are optional but must be followed by a colon. In the absence of minutes, seconds may be specified up to "999.9". The decimal point is not necessary if no decimal is specified. If the DOWN keyword is not specified in a cue definition then either "0" or the DOWN value of the previous cue will be used.

EXAMPLE: DOWN 1:30

DELAY

This keyword specifies the time delay before the downfade of the previous cue. This keyword must be followed by a space and the time in the range of "0" to "9:59.9". Minutes are optional but must be followed by a colon. In the absence of minutes, seconds may be specified up to "999.9". The decimal point is not necessary if no decimal is specified. If the DELAY keyword is not specified in a cue definition then either "0" or the DELAY value of the previous cue will be used.

EXAMPLE: DELAY 30

WAIT

This keyword specifies the time delay before the execution of a linked cue. This keyword must be followed by a space and the time in the range of "0" to "9:59.9". Minutes are optional but must be followed by a colon. In the absence of minutes, seconds may be specified up to "999.9". The decimal point is not necessary if no decimal is specified. If the WAIT keyword is not specified in a cue definition then a automatic link will not be performed, and the GO button must be pressed to execute the cue specified.

EXAMPLE: WAIT 1.1

CHANNEL

This keyword is used to specify the channel levels (in percent) of each non-zero channel of the cue. This keyword must be followed by a space and the channel levels in the format of "channel,level". As many channel/level pairs may be included on a line as will fit. Each channel/level pair must be separated by a space. Each additional line specifying channel levels must also begin with the keyword. Full level is represented by "100", "FF", or "FL". Any channel not specified will be zero.

EXAMPLE: CHANNELS 1,50 20,25 21,25 22,100

WARRANTY

NSI Corporation Limited Warranty

NSI Corporation warrants new electronics products to be free from defective materials and workmanship for a period of one (1) year from the date of purchase to the original owner when purchased from an authorized NSI dealer.

The purchaser is responsible for completing and mailing to NSI, within 15 days of purchase, the warranty registration card enclosed with each product. NSI products that have been subject to accident, alteration, abuse, or defacing of the serial number are not covered by this warranty. The normal wear and tear of items such as knobs, jacks, and switches are not covered under this warranty.

If your NSI product requires service during the warranty period, NSI will repair or replace, at its option, defective materials provided you have identified yourself as the original owner of the product to NSI or any authorized NSI dealer. Transportation charges to and from an authorized dealer or the NSI factory for repair shall be the responsibility of the owner. All products returned to NSI must have factory authorization for return prior to shipping.

NSI Corporation is not liable for any incidental or consequential damages resulting from defect or failure other than repairs of the NSI product subject to the terms of this warranty. This warranty gives you specific legal rights, and you may have other rights which vary from state to state. This warranty is expressly in lieu of all other agreements and warranties expressed or implied except as may be otherwise required by law.