

MiniMAC Profile / Wash



**Martin**

The MiniMAC Profile and MiniMAC Wash are ultracompact, automated moving head luminaires in contemporarily designed housings, ideal for a wide variety of unique lighting applications.

The MiniMAC Profile is a flexible profile spot offering advanced pattern illumination capabilities for colorful projection of images and textures. The MiniMAC Wash is an all-purpose Fresnel color changer useful in indoor atmosphere and mood generation. Extremely versatile lighting tools, both luminaires successfully combine high light output with small fixture size.

Stylish looks combine with a powerful optical system to make the MiniMACs perfect for all types of applications from retail boutiques to restaurants to discotheques.

**Pattern Wheel MiniMAC Profile**



A motorized pattern wheel houses 7 easily replaceable glass and metal gobo patterns and rotates bi-directionally at various speeds.

**Lamp**

The HTI 150M lamp (included) provides 2000 hours of lamp life. For a lamp with increased output, an optional HTI 150 lamp is available.



**Color Wheel**



A motorized color wheel houses 12 dichroic colors plus white. It is possible to fade or snap between colors and continuous rotation of the color wheel is possible.

**Shutter**

The shutter allows for ultra fast strobe effects and can be used as a low resolution dimmer for in/out fades.

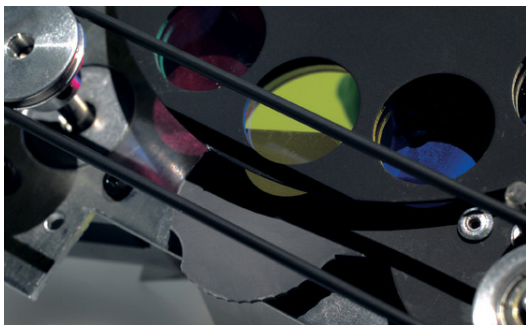

### Optics MiniMAC Profile



The hard-edged light of the MiniMAC Profile emits a total luminous flux of 1950 lumens with multiple spread angle options possible.

### Optics MiniMAC Wash

The soft-edged light of the MiniMAC Wash emits a total luminous flux of 2500 lumens. The standard 40° beam angle can be easily changed to 23° by removal of a single lens.



### LED Display



A 3-digit LED readout allows the user to customize settings for easy programming. Error messages are easily understood, lamp and fixture usage is displayed and the display flips for easy reading in any position.



### Twin Flightcase

A functional twin flightcase is available for both the MiniMAC Wash and Profile. Fixtures can be stored with the clamp mounted on the fixture for fast and easy rigging.



### Clamps



A strong Omega adaptor (included) accepts both the G-clamp and Half-coupler.

### Service Friendly



Modular construction makes components easily accessible for simple maintenance. The compact shell parts are easy to remove.

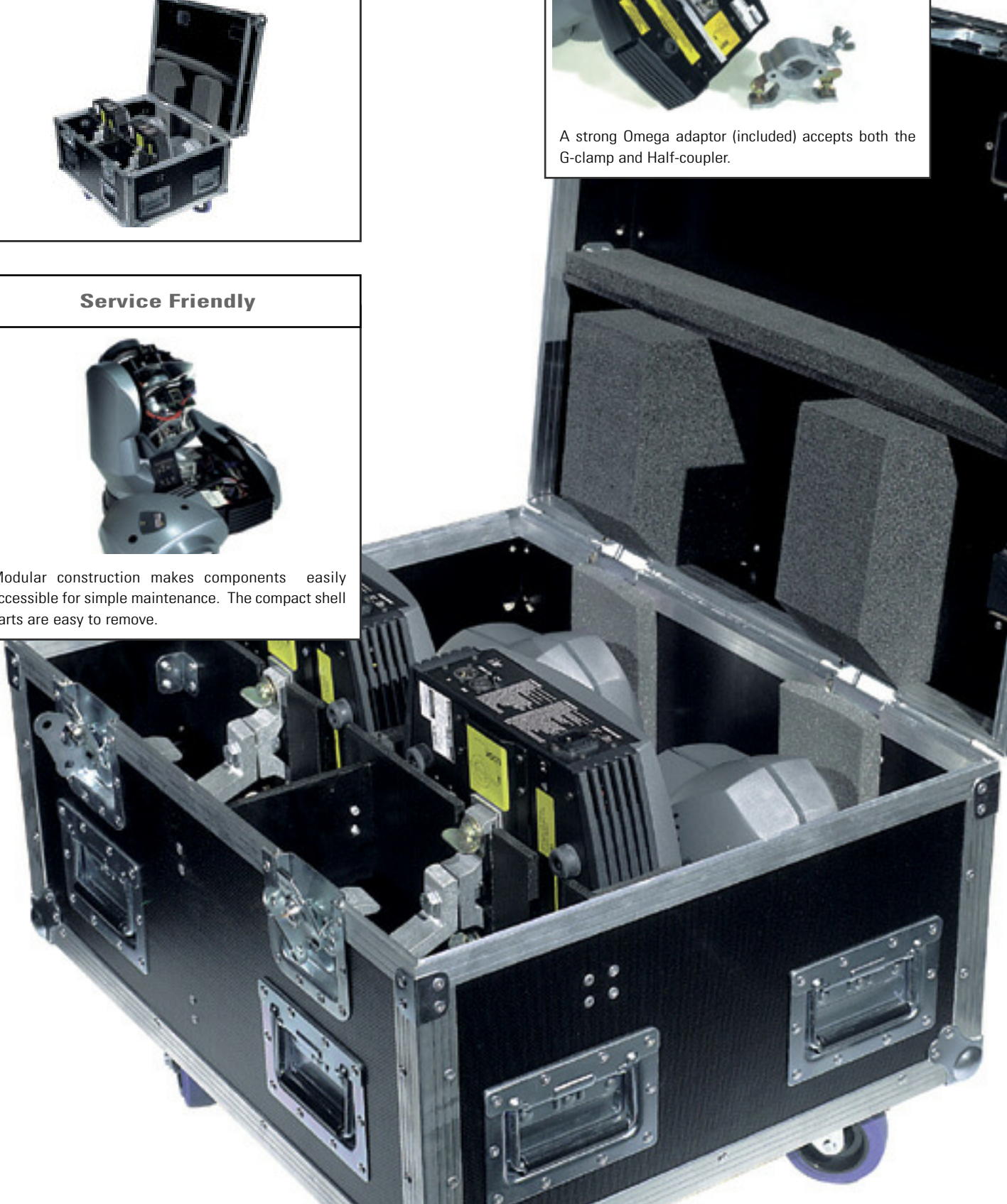

**Pan and Tilt**

The lumination head has a radius of 540° horizontal pan and 270° vertical tilt and works in all possible orientations.

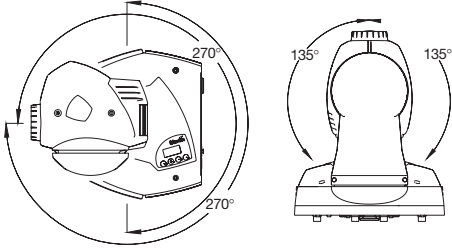

**Dimensions:**

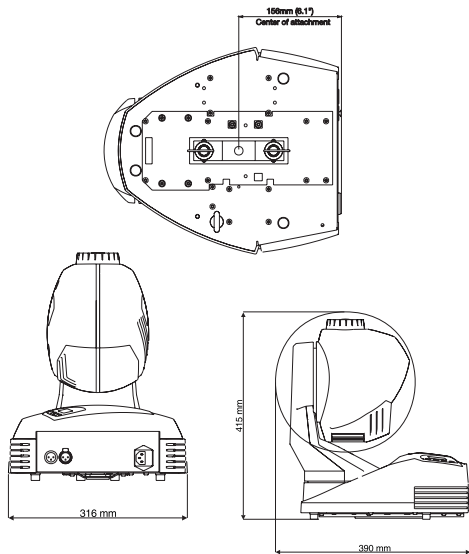

**MiniMAC Profile - Standard 16.7° lens**

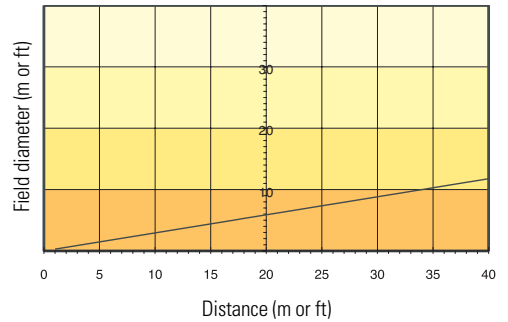
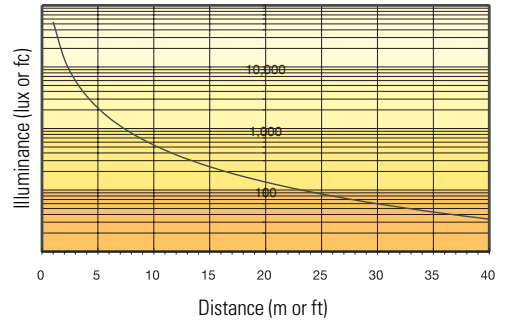
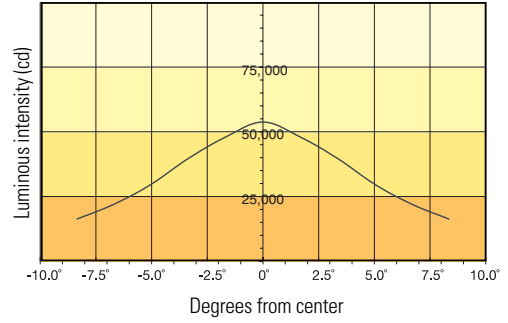

Illuminance (lux or fc): ..... 53,754 cd/distance<sup>2</sup> (m or ft)  
 Diameter: ..... 0.29 x distance  
 Beam angle: ..... 16.7°  
 Measurement conditions: ..... 230 V, 50 Hz; no effects applied  
 Measurement source: ..... Martin Metal Halide 150

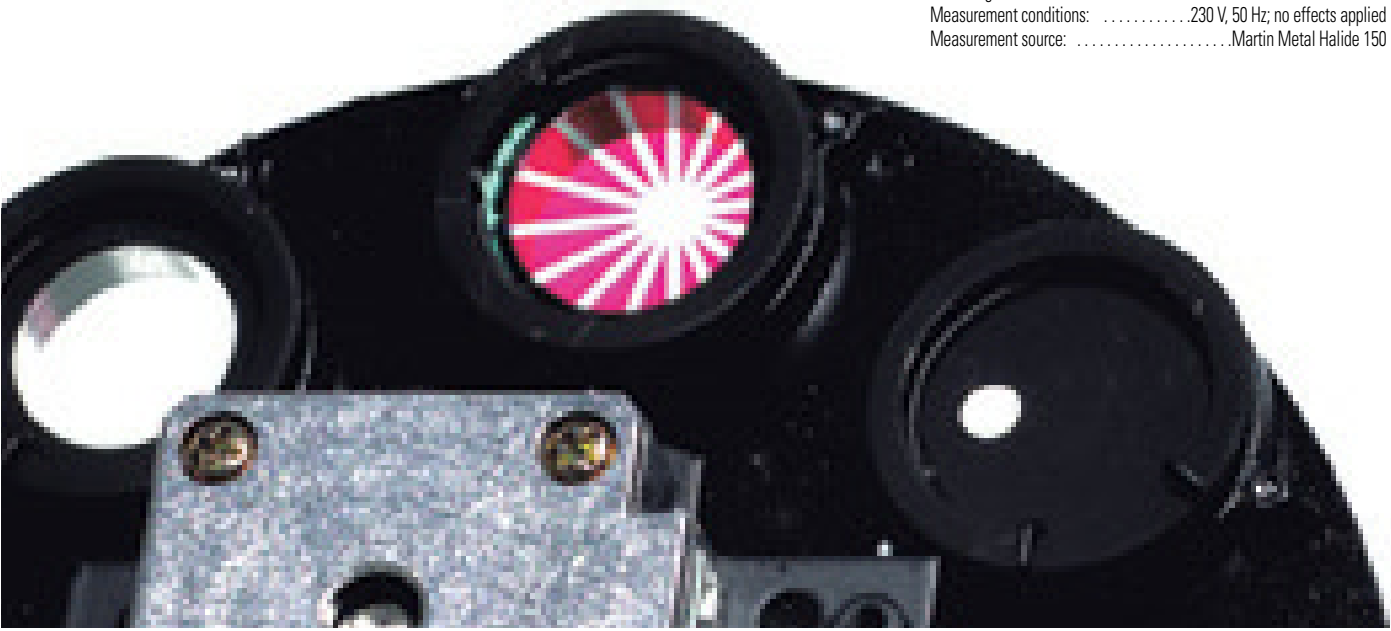

**MiniMAC Wash Standard 40.1° lens**

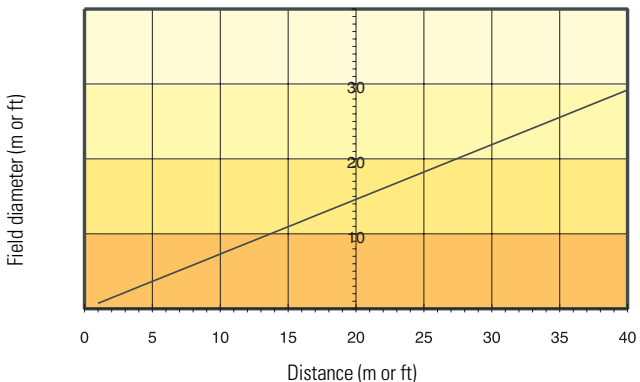
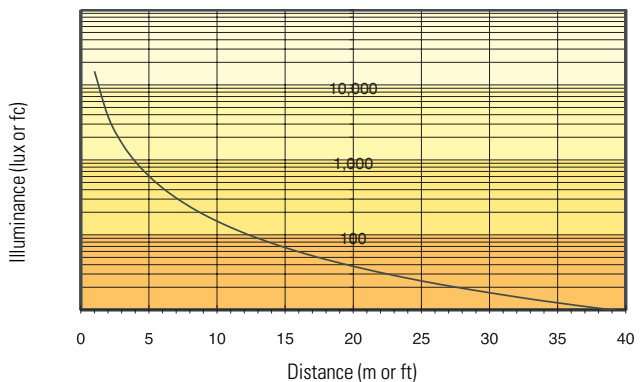
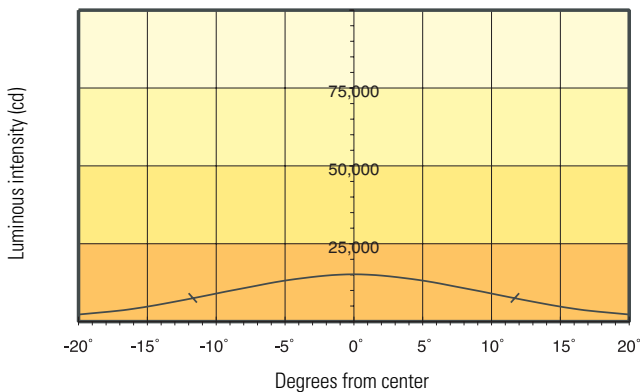

Illuminance (lux or fc): ..... 15,203 cd/distance<sup>2</sup> (m or ft)  
 Diameter: ..... 0.73 x distance  
 Field angle: ..... 40.1°  
 Measurement conditions: ..... 230 V, 50 Hz; no effects applied  
 Measurement source: ..... Martin Metal Halide 150

**MiniMAC Wash Optional lens 23.5°**

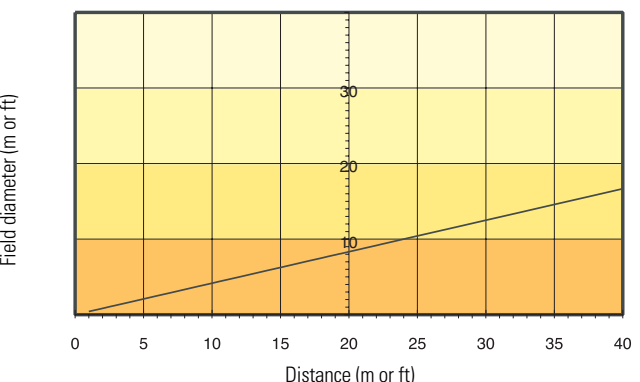
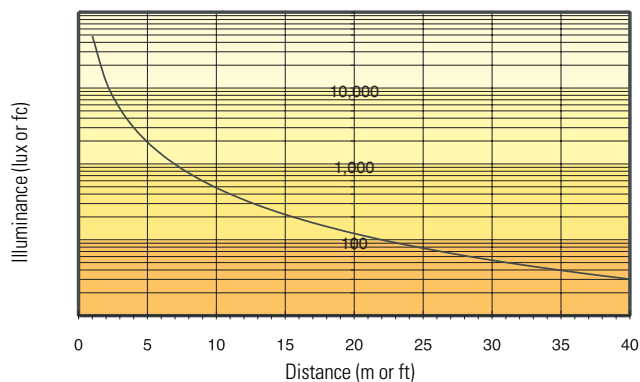
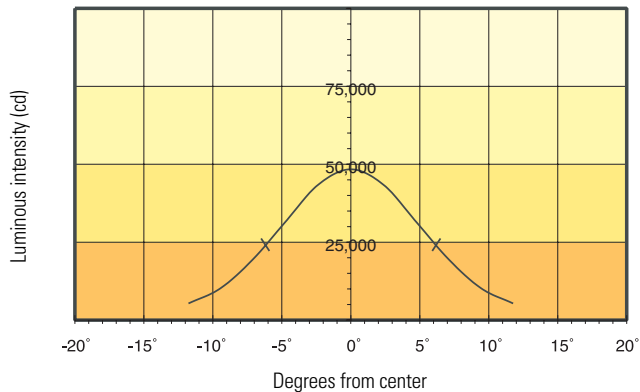

Illuminance (lux or fc): ..... 48,384 cd/distance<sup>2</sup> (m or ft)  
 Diameter: ..... 0.42 x distance  
 Field angle: ..... 23.5°  
 Measurement conditions: ..... 230 V, 50 Hz; no effects applied  
 Measurement source: ..... Martin Metal Halide 150

## Specifications MiniMAC Profile

### Description

The MiniMAC Profile is an automated moving-head spotlight that provides 12 dichroic color filters, 7 interchangeable rotating gobos, high-speed mechanical shutter, 540° of pan by 270° of tilt, 17° beam angle with manually adjustable focus, 3-digit LED control panel, and switch-selectable power supply settings. It uses a 150 Watt discharge source and may be operated with DMX controllers, the Martin MC-1 remote control, and as a stand-alone unit with programmable 7-scene sequence, random action, and master/ slave capability.

### Physical

- Length: 390 mm (15.4 in)
- Width: 316 mm (12.4 in)
- Height: 415 mm (16.3 in)
- Weight: 11.8 kg (26.0 lbs)

### Source

- Lamp: 150 W discharge
- Approved models: Martin Metal Halide, Osram HTI
- Base: GY 9.5
- Control: remote switchable

### Performance

- Light output: 1950 lumens

### Gobos

- Outside diameter: 22.5 mm + 0/- 0.3 mm (0.886 in +0/- 0.012 in)
- Maximum image diameter: 17.0 mm (0.669 in)
- Maximum thickness: 1.1 mm (0.043 in)

### Thermal

- Maximum ambient temperature (Ta): 40° C (104° F)
- Maximum surface temperature: 60° C (140° F)
- Total heat dissipation: 700 Btu/hr

### Control and programming

- Control options: DMX-512, MC-1, stand-alone, master/slave
- Stand-alone triggers: music, internal timer
- Stand-alone programs: automatic and programmable 7-scene sequence
- Receiver: RS-485
- Setting and addressing: 3-digit LED control panel, remote w/ uploader
- Firmware update: serial upload (MUF)
- DMX speed control: tracking and/or vector
- DMX channels: 6 - 10
- Pan/tilt resolution: 8- and 16-bit
- Data I/O: locking 3-pin XLR, pin 1 shield, pin 2 cold (-), pin 3 hot (+)

### AC Supply

- AC input: 3-pin IEC male socket
- Power supply options: 100/120/210/230/250 V, 50/60 Hz (switch-selectable)

### Maximum power and current

Option	Watts	Amps
100 V	220 W	2.7 A
120 V	210 W	2.0 A
210 V	200 W	1.3 A
230 V	200 W	1.1 A
250 V	210 W	1.0 A

### Design standards

- EU EMC: EN 50 081-1, EN 50 082-1
- EU safety: EN 60598-1, EN 60598-2-17
- Canadian safety: CSA C22.2 No. 166
- US safety: ANSI/UL 1573

### Electromechanical effects

- Color wheel: 12 colors + open, continuous rotation
- Gobo wheel: 7 interchangeable rotating gobos + open
- Shutter: variable strobe up to 11.4 Hz
- Pan: 540° in 0.013° steps
- Tilt: 270° in 0.007° steps

### Construction

- Housing: UV-resistant fiber-reinforced composite
- Finish: integral black color or polyurethane coating
- Available colors: black, white, titanium
- Protection factor: IP 20

### Installation

- Mounting points: 1 pair of 1/4-turn locks for clamp bracket
- Orientation: any
- Minimum distance to combustible materials: 0.3 m (12 in)
- Minimum distance to illuminated surfaces: 0.3 m (12 in)
- Minimum clearance around fan and air vents: 0.1 m (4 in)
- Minimum center-to-center installation distance: 316 mm (12.4 in)

### Ordering information

- MiniMAC Profile, in cardboard, black: P/N 90230000
- MiniMAC Profile, in cardboard, white: P/N 90230030
- MiniMAC Profile, in cardboard, titanium: P/N 90230032

### Included items

- Lamp: Martin Metal Halide 150, P/N 97010107
- Mains cable: 3 m, 3-pin IEC, P/N 11501013
- Data cable: 5 m, black, 3-pin XLR, P/N 11820008
- Clamp attachment bracket: P/N 56600016
- Safety cable eye bolt: P/N 08131901
- User manual: P/N 35000084

### Accessories

- G-clamp: P/N 91602003
- Half-coupler clamp: P/N 91602005
- 2-unit flight case: P/N 91510007

### Specification General

The luminaire is an automated moving head profile spotlight employing a 150 Watt discharge lamp as the light source. The luminaire is the Martin MiniMAC Profile.

### Mechanical effects

The luminaire provides one wheel with 12 fixed dichroic glass color filters and an open position. The color wheel rotates continuously and is positionable between filters. The luminaire provides one wheel with seven holders for insertable gobos and an open position. The gobo holders rotates continuously at variable speeds and accommodates gobos 22.5 mm (0.886 in) in diameter and up to 1.1 mm (0.043 in.) thick. The luminaire provides a manually adjustable focus lens that focuses gobo patterns at distances of 2 meters (6.5 ft.) to infinity. The luminaire provides a mechanical shutter to open and close the light output. The shutter provides variable speed strobe effects at up to 11 flashes per second. The head of the luminaire rotates 289° on the tilt axis. It can be mounted on a single arm that rotates 540° on the pan axis.

### Control

The luminaire responds to command signals from USITT DMX512 compatible control devices and the Martin MC-1 remote control unit. For serial data transfer, one 3-pole male and one 3-pole female XLR socket is provided. The luminaire provides an automatic stand-alone mode with user-definable pan and tilt range, and a programmable stand-alone mode with up to seven sequential scenes. The automatic stand-alone mode is sound-activated or self-activated at user option. All user-selected software settings are adjustable via an onboard control panel with LED display or via a remote control unit. Firmware updates are installable from a remote location via a serial upload.

### Performance

The luminaire emits a luminous flux of 1950 lumens in a 17° focused beam when fitted with a new lamp.

### Housing

The exterior of the luminaire is constructed of high temperature UV-resistant fiberglass-reinforced nylon. The housing provides a protection factor of IP 20. The exterior shell color is black (titanium) (white).

### Installation

The luminaire operates in any orientation. It is furnished with a bracket to which a mounting clamp may be bolted. The bracket attaches to the base with quarter-turn fasteners. When installed above floor level, secondary attachment is fastened to the base of the luminaire.

### Electrical

The luminaire provides switch-selectable settings for operation on 50 and 60 Hz supplies at 100, 120, 210, 230, and 250 volts. It is fitted with a three-prong male IEC socket for connection to AC power. The luminaire is electrically grounded. The luminaire conforms to CE safety standards EN 60598-1 and EN 60598-2-17, and to CE electromagnetic compatibility standards EN 50 081-1 and EN 50 082-1. The luminaire is cETL certified for compliance with CSA standard C22.2 No. 166, and ETL certified for compliance with ANSI/UL standard 1573. (Certification pending.)

### Environmental

The luminaire must be located in a dry area in which the ambient temperature does not exceed 40° C (104° F).

### Physical

Size: 390 x 316 x 415 mm (15.4 x 12.4 x 16.3 in.) Weight: 11.8 kg (26.0 lbs)

## Specifications MiniMAC Wash

### Description

The MiniMAC Wash is an automated moving-head Fresnel washlight that provides 12 dichroic color filters, high-speed mechanical shutter, 540° of pan by 270° of tilt, user selectable 23° or 40° soft-edged beams, 3-digit LED control panel, and switch-selectable power supply settings. It uses a 150 Watt discharge source and may be operated with DMX controllers, the Martin MC-1 remote control, and as a stand-alone unit with programmable 7-scene sequence, random action, and master/ slave capability.

### Physical

- Length: 390 mm (15.4 in)
- Width: 316 mm (12.4 in)
- Height: 415 mm (16.3 in)
- Weight: 11.6 kg (25.5 lbs)

### Source

- Lamp: 150 W discharge
- Approved models: Martin Metal Halide, Osram HTI
- Base: GY 9.5
- Control: remote switchable

### Performance

- Light output: 2600 lumens

### Thermal

- Maximum ambient temperature (Ta): 40° C (104° F)
- Maximum surface temperature: 60° C (140° F)
- Total heat dissipation: 700 Btu/hr

### Control and programming

- Control options: DMX-512, MC-1, stand-alone, master/slave
- Stand-alone triggers: music, internal timer
- Stand-alone programs: automatic and programmable 7-scene sequence
- Receiver: RS-485
- Setting and addressing: 3-digit LED control panel, remote w/ uploader
- Firmware update: serial upload (MUF)
- DMX speed control: tracking and/or vector
- DMX channels: 4 - 8
- Pan/tilt resolution: 8- and 16-bit
- Data I/O: locking 3-pin XLR, pin 1 shield, pin 2 cold (-), pin 3 hot (+)

### AC Supply

- AC input: 3-pin IEC male socket
- Power supply options: 100/120/210/230/250 V, 50/60 Hz

### Maximum power and current

Option	Watts	Amps
100 V:	220 W,	2.7 A
120 V:	210 W,	2.0 A
210 V:	200 W,	1.3 A
230 V:	200 W,	1.1 A
250 V:	210 W,	1.0 A

### Design standards

- Canadian safety: CSA C22.2 No. 166
- EU EMC: EN 50 081-1, EN 50 082-1
- EU safety: EN 60598-1, EN 60598-2-17
- US safety: ANSI/UL 1573

### Electromechanical effects

- Color wheel: 12 colors + open, continuous rotation
- Shutter: variable strobe up to 11.4 Hz
- Pan: 540° in 0.013° steps
- Tilt: 270° in 0.007° steps

### Construction

- Housing: UV-resistant fiber-reinforced composite
- Finish: integral black color or polyurethane coating
- Available colors: black, white, titanium
- Protection factor: IP 20

### Installation

- Mounting points: 1 pair of 1/4-turn locks for clamp bracket
- Orientation: any
- Minimum distance to combustible materials: 0.3 m (12 in)
- Minimum distance to illuminated surfaces: 0.3 m (12 in)
- Minimum clearance around fan and air vents: 0.1 m (4 in)
- Minimum center-to-center installation distance: 316 mm (12.4 in)

### Ordering information

- MiniMAC Wash, in cardboard, black: P/N 90230400
- MiniMAC Wash, in cardboard, white: P/N 90230430
- MiniMAC Wash, in cardboard, titanium: P/N 90230432

### Included items

- Lamp: Martin Metal Halide 150, P/N 97010107
- Mains cable: 3 m, 3-pin IEC, P/N 11501013
- Data cable: 5 m, black, 3-pin XLR, P/N 11820008
- Clamp attachment bracket: P/N 56600016
- Safety cable eye bolt: P/N 08131901
- User manual: P/N 35000084

### Accessories

- G-clamp: P/N 91602003
- Half-coupler clamp: P/N 91602005
- 2-unit flight case: P/N 91510007

### Specification

#### General

The luminaire is an automated moving head Fresnel washlight employing a 150 watt discharge lamp as the light source. The luminaire is the Martin MiniMAC Wash.

#### Mechanical effects

The luminaire provides one wheel with 12 fixed dichroic glass color filters and an open position. The color wheel rotates continuously and is positionable between filters. The luminaire provides a mechanical shutter to open and close the light output. The shutter provides variable speed strobe effects at up to 11 flashes per second. The head of the luminaire rotates 289° on the tilt axis. It is mounted on a single arm that rotates 540° on the pan axis.

#### Control

The luminaire responds to command signals from USITT DMX512 compatible control devices and the Martin MC-1 remote control unit. For serial data transfer, one 3-pole male and one 3-pole female XLR socket is provided. The luminaire provides an automatic stand-alone mode with user-definable pan and tilt range, and a programmable stand-alone mode with up to seven sequential scenes. The automatic stand-alone mode is sound-activated or self-activated at user option. All user-selected software settings are adjustable via an onboard control panel with LED display or via a remote control unit. Firmware updates are installable from a remote location via a serial upload.

#### Performance

The luminaire emits a luminous flux of 2600 lumens in a 40° soft-edged field when fitted with a new lamp.

#### Housing

The exterior of the luminaire is constructed of high temperature UV-resistant fiberglass-reinforced nylon. The housing provides a protection factor of IP 20. The exterior shell color is black (titanium) (white).

#### Installation

The luminaire operates in any orientation. It is furnished with a bracket to which a mounting clamp may be bolted. The bracket attaches to the base with quarter-turn fasteners. When installed above floor level, secondary attachment is fastened to the base of the luminaire.

### Electrical

The luminaire provides switch-selectable settings for operation on 50 and 60 Hz supplies at 100, 120, 210, 230, and 250 volts. It is fitted with a three-prong male IEC socket for connection to AC power. The luminaire is electrically grounded. The luminaire conforms to CE safety standards EN 60598-1 and EN 60598-2-17, and to CE electromagnetic compatibility standards EN 50 081-1 and EN 50 082-1. The luminaire is cETL certified for compliance with CSA standard C22.2 No. 166, and ETL certified for compliance with ANSI/UL standard 1573. (Certification pending.)

### Environmental

The luminaire must be located in a dry area in which the ambient temperature does not exceed 40° C (104° F).

### Physical

Size: 390 x 316 x 415 mm (15.4 x 12.4 x 16.3 in.) Weight: 11.6 kg (25.5 lbs)

