

MAC 300

Martin

The MAC 300 is an automated moving head washlight luminaire with an elegant contemporary design, a compact version of the successful MAC 600.

This flexible atmosphere generator produces a wide variety of colors and effects and is used wherever dynamic color wash is important - both indoor and out.

The MAC 300 fits discreetly in a ceiling or truss yet it is powerful enough to cut through even high ambient light levels. The MAC 300 has proven to be well suited to a wide range of lighting applications.

Preprogrammed Macros



Preprogrammed macro sequences, for example a dimmer or strobe pulse, can be called up for automatic and quick programming.

CMY plus Color Wheel



A CMY color mixing system provides nearly unlimited color choices. A separate 6 slot plus open color wheel offers additional color possibilities. All slots are replaceable and split colors are possible. CTC and UV filters are also included.

Narrow and Wide Beam Angles

A simple change of the front lens makes narrow and wide beam angles possible. The standard 18° lens produces a focus range of 18°-35°. The 59° diffuser lens creates a focus range of 59°-67°.



Dimmer and Shutter

A full range dimmer and fast 14 Hz shutter for strobe effect are standard.

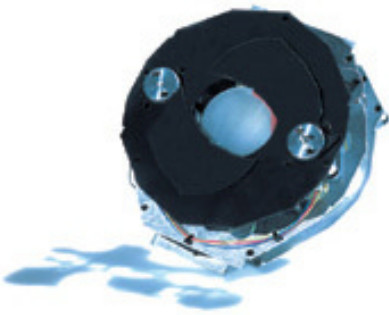

Lamp

The MAC 300 employs a 250 Watt discharge lamp producing a luminous flux of 4800 lumens. The integrated sidelight protector controls beam projection at the point of emergence by preventing unwanted light spill.



Zoom Effect

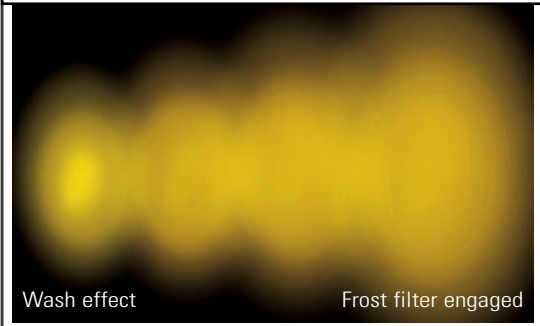

Zoom effect possibilities are provided by a variable frost filter. Smooth continuous transition from a standard wash to zoom effect creates the same zoom possibilities as conventional 1 and 2k Watt lights.

LED Display



A 4-digit LED readout allows the user to customize settings for easy programming. Error messages are easily understood, lamp and fixture usage is displayed and the readout flips for easy reading in any position.

Service Friendly

The compact shell is easily detached. Modular construction makes components easily accessible and a snap to remove. Maintenance is simple.

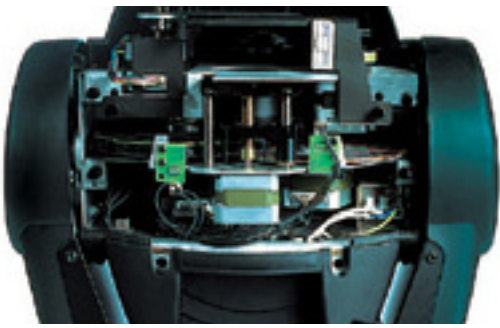

Clamps

Two separate Omega adapters and two different clamp types are available for easy rigging.



Pan and Tilt

The lumination head of the MAC 300 pans 540° with a tilt of 265° at two different P/T speeds and works in all possible orientations.

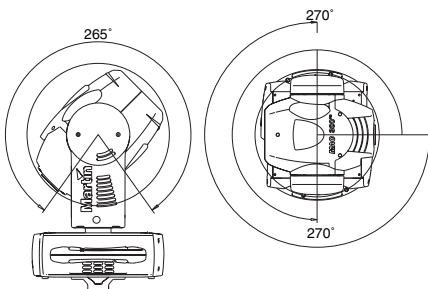

Elevations

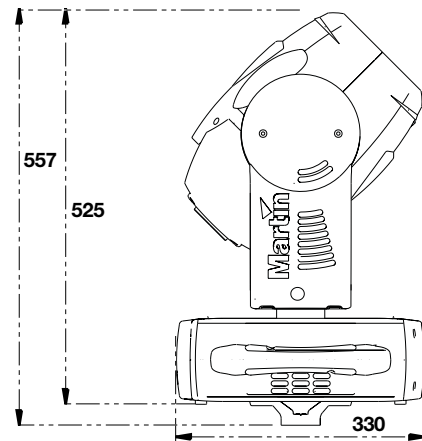
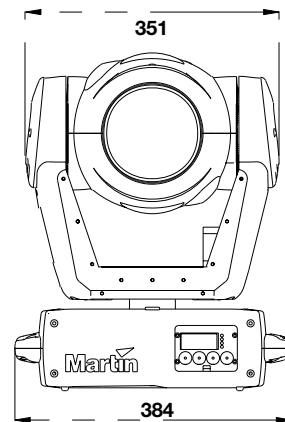

Rigging

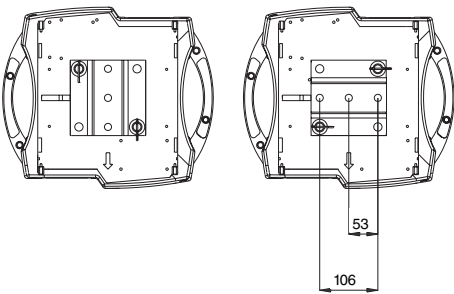

Dedicated anchoring points, safety wire attachment point, quarter-turn fastening system and mid-pan-range locator make for trouble free rigging.

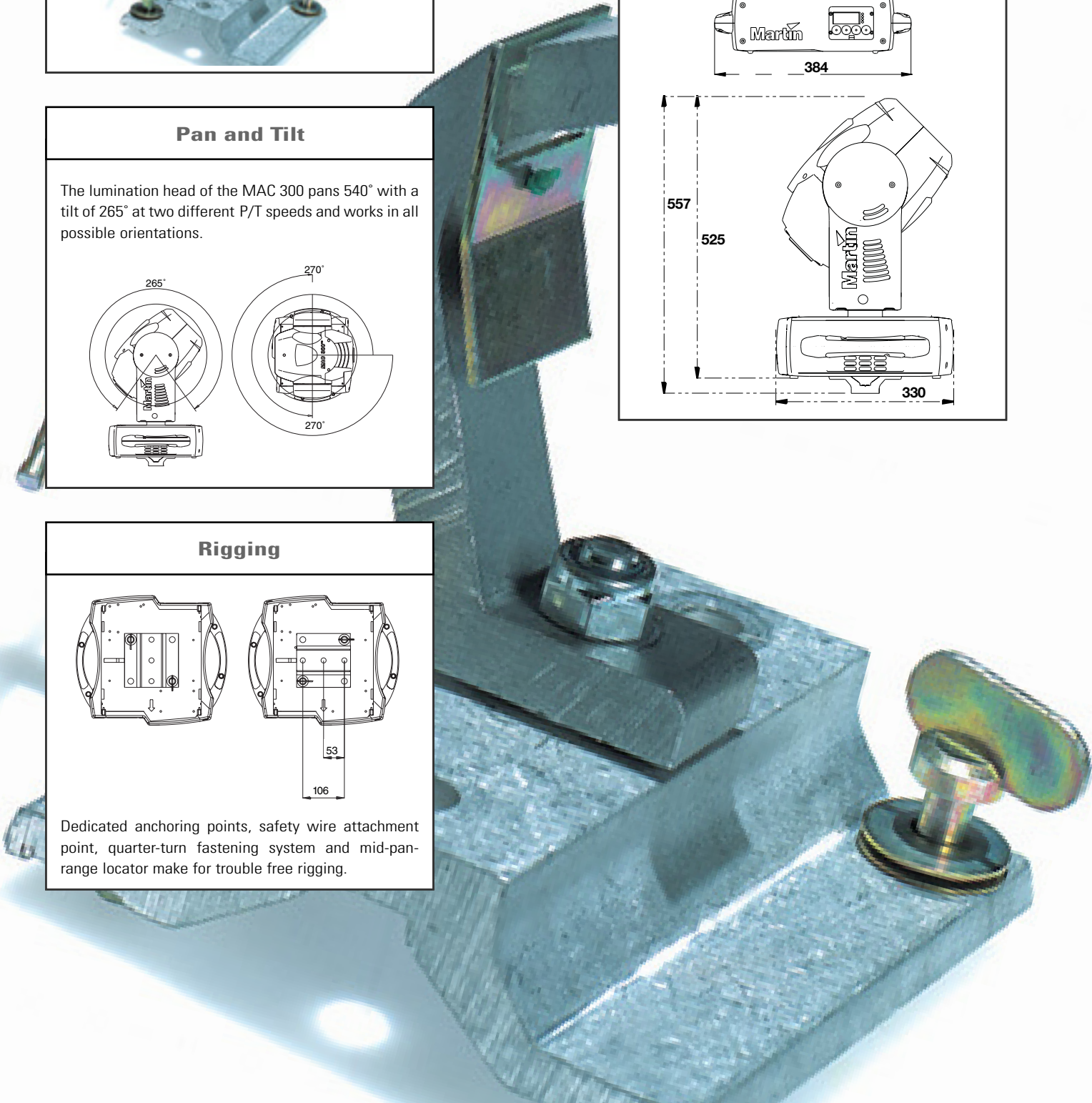

Standard 18° Lens

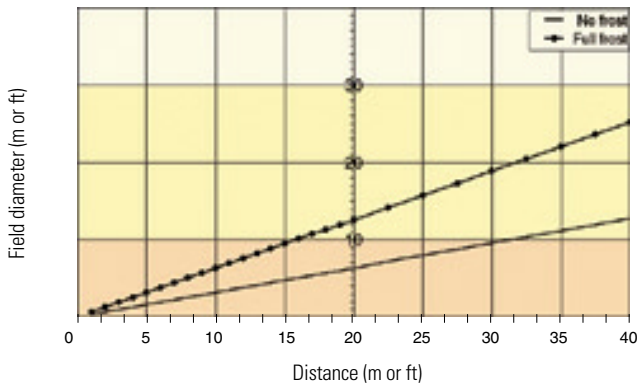
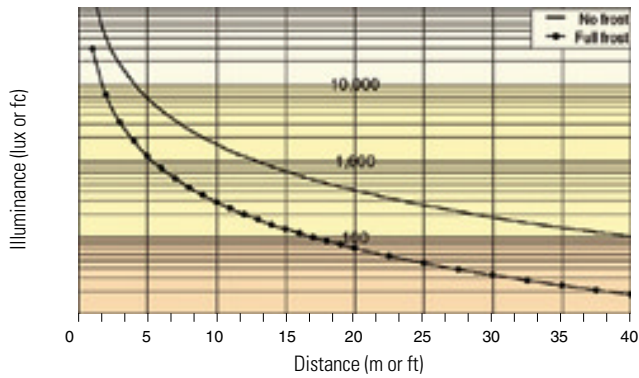
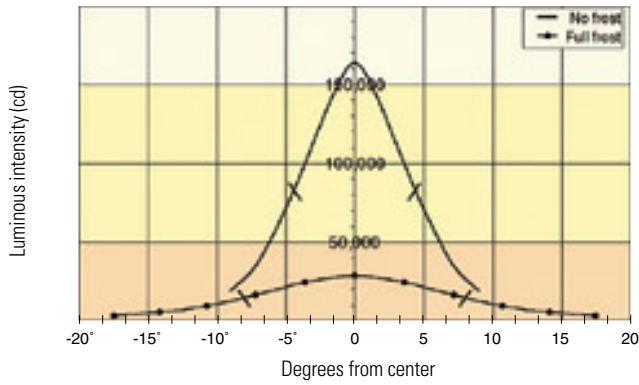

Illuminance (lux or fc): 163,721 cd / distance² (m or ft)
 Illuminance with full frost (lux or fc): 28,820 cd / distance² (m or ft)
 Field diameter: 0.32 x distance
 Field diameter with full frost: 0.63 x distance
 Field angle: 18°
 Field angle with full frost: 35°
 Measurement conditions: 230 V, 50 Hz; no color or effects applied
 Measurement source: Philips MSD 250/2, new

Optional wide angle diffuser

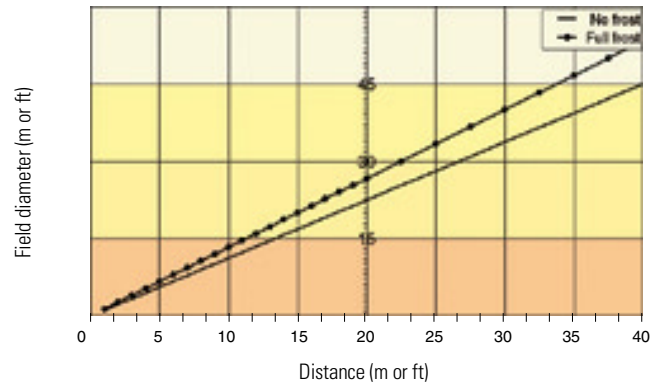
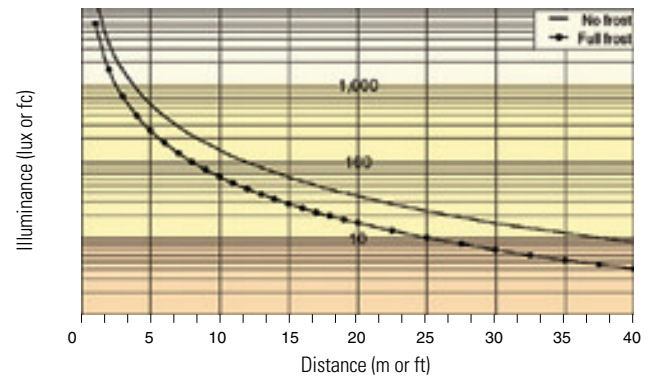
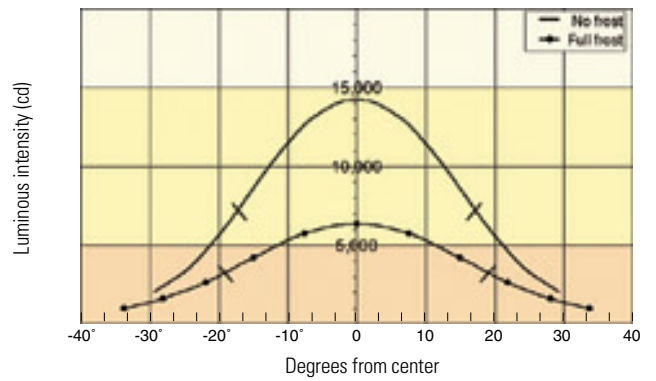

Illuminance (lux or fc): 14,258 cd / distance² (m or ft)
 Illuminance with full frost (lux or fc): 6356 cd / distance² (m or ft)
 Field diameter: 1.12 x distance
 Field diameter with full frost: 1.33 x distance
 Field angle: 59°
 Field angle with full frost: 67°
 Measurement conditions: 230 V, 50 Hz; no color or effects applied
 Measurement source: Philips MSD 250/2, new

Specifications

Description

The MAC 300 is an automated yoke-mounted Fresnel washlight employing a 250 Watt discharge lamp. It provides cyan, magenta, and yellow (CMY) color mixing, separate color wheel with 6 replaceable dichroic filters, variable zoom effect, strobe effects up to 14 Hz, full-range dimming, and accurate 16-bit movement. Efficient optics, attractive design, modular construction and numerous other features make the MAC 300 well suited for any lighting application calling for color mixing and a soft-edged beam in a 250 Watt fixture.

Physical

- Length: 330 mm (13.0 in)
- Width: 384 mm (15.1 in)
- Height (head at tilt limit): 536 mm (21.1 in)
- Weight: 19.9 kg (43.9 lb.)

Source

- Lamp: 200 or 250 W discharge
- Base: GY 9.5
- Approved models: Philips MSD 250/2, Osram HSD 250
- Control: automatic and/or remote on/off

Performance

- Light output: (new MSD 250/2, no effects applied): 4800 lumens

Thermal

- Maximum ambient temperature (Ta): 40° C (104° F)
- Maximum lamp-socket temperature: 150° C (302° F)
- Maximum shell surface temperature: 90° C (194° F)
- Total heat dissipation: 1126 Btu/hr

Control and programming

- Data pinout: pin 1 shield, pin 2 cold (-), pin 3 hot (+)
- Receiver: Opto-isolated RS-485
- Setting and addressing via: LED control panel, MP-2 Uploader
- Protocols: USITT DMX-512 (1990), Martin RS-485
- Movement control: tracking and/or vector
- DMX Channels: 9 - 13
- Data input: locking 3-pin XLR male socket
- Data output: locking 3-pin XLR female socket

AC Supply

- AC input: 3-pin IEC male socket
- Wiring options: 100/120/210/230/250 V, 50/60 Hz
- Maximum power and current: 330 W, 3.1 A @ 120 V; 330 W, 1.6 A @ 230 V

Design standards

- Canadian safety: CSA C22.2 NO 166
- EU EMC: EN 50 081-1, EN 50 082-1
- EU safety: EN60598-1, EN 60598-2-17
- US safety: ANSI/UL 1573

Electromechanical effects

- Cyan filter: 0 - 100%
- Magenta filter: 0 - 100%
- Yellow filter: 0 - 100%
- Color wheel: 6 colors + open and split positions
- Dimmer: 0 - 100%
- Shutter: 0 - 14 flashes per second
- Zoom diffuser: 0° - 17°
- Pan: 540° in 0.013° steps
- Tilt: 265° in 0.007° steps

Construction

- Housing: UV-resistant fiber-reinforced composite
- Finish: black, integral color
- Protection factor: IP20

Installation

- Mounting points: 2 pairs of 1/4-turn locks, offset 90°
- Orientation: any
- Minimum installation distance, center-to-center: 368 mm (14.5 in)
- Minimum distance to combustible materials: 0.4 m (16 in)
- Minimum distance to illuminated surfaces: 0.4 m (16 in)

Ordering information

- MAC 300 in cardboard: 90225400
- MAC 300, flight case: 90225401

Included items

- Omega bracket, MAC 250/300, 1/4-turn: 91602000
- XLR cable, 5 m, black, 3-pin: 11820008
- Mains cable, 3 m, IEC 3-pin: 11501013
- User manual: 35000075

Accessories

- Flight case, 4 x MAC 250/300: 91510005
- Flight case, 2 x MAC 250/300: 91510004
- MP-2 Uploader: 90758420
- G-clamp: 91602003
- Half-coupler clamp: 91602005
- Wide angle diffuser lens kit: 91610016
- Color filters: 38 available, please refer to user manual
- Outdoor Protection Dome: 90525010
- The Martin Wife: 91611038
- The Martin King Dome

Specification

General

The luminaire is an automated yoke-mounted washlight with a subtractive cyan, magenta, and yellow color mixing system, six-position color wheel, full-range dimmer, and variable field angle. It employs a 250 Watt discharge lamp as the light source.

Mechanical effects

The luminaire provides subtractive cyan, magenta, and yellow color mixing plus a wheel with six positions for interchangeable dichroic glass filters. Output intensity is regulated from 0 to 100% in 256 steps by a mechanical dimmer / shutter that opens and closes at speeds up to 14 flashes per second. The moving yoke pans 540° and the head tilts 265°.

The diameter of the luminaire's light beam is adjustable through a range of 18° to 35° through the application of a variable diffuser. (Optional) The luminaire is supplied with a wide-angle diffuser lens that provides adjustable beam angles from 59° to 67°. The position of all mechanical effects excluding the dimmer and frost filter is monitored by a position feedback system capable of automatically returning the effects to programmed values.

Control

The luminaire responds to command signals conforming to either the USITT DMX512 (1990) standard or the Martin RS485 standard. All user-selected software settings are adjustable via an onboard control panel with LED display or via data cabling in conjunction with a remote control unit. The luminaire has two locking 3-pole XLR connectors for serial data transfer.

Performance

When fitted with a new MSD 250/2 discharge lamp, and with no colors or frost applied, the luminaire emits a total luminous flux of 4765 lumens in a beam 18° wide, where the outside edge of the beam is defined as the circle having one-tenth the intensity of the beam's midpoint.

Housing

The exterior of the luminaire is constructed of high-temperature UV-resistant fiberglass-reinforced nylon with integral black color. The housing provides a protection factor of IP 20.

Installation

The luminaire operates in any orientation. It is supplied with a bracket to which mounting clamps may be bolted. The bracket attaches to the base with quarter-turn fasteners such that the luminaire may be installed at any increment of 90° in a plane parallel to the structure. When installed above floor level, a secondary attachment is fastened to an attachment point in the luminaire's base.

Electrical

The luminaire operates, within a tolerance of five percent, on 50 and 60 Hz supplies at 100, 120, 210, 230, and 250 volts. It is fitted with a three-prong male IEC socket for connection to AC power. The luminaire must be electrically grounded.

The luminaire conforms with CE safety standards EN 60598-1 and EN 60598-2-17, and with CE electromagnetic compatibility standards EN 50 081-1 and EN 50 082-1. Units intended for use in North America are cETL certified for compliance with CSA standard C22.2 No. 166, and ETL certified for compliance with ANSI/UL standard 1573. (Certification pending.)

Environmental

The luminaire must be located in a dry area in which the ambient temperature does not exceed 40° C (104° F).

Physical

Size (head at tilt limit): 384 x 330 x 536 mm (13.0 x 15.1 x 21.1 in.)
Weight: 19.9 kg (43.9 lb.)

For a MAC 300 specification quote, see the Service and Support page on the Martin website: www.martin.dk

Martin