

**Kramer Electronics, Ltd.**

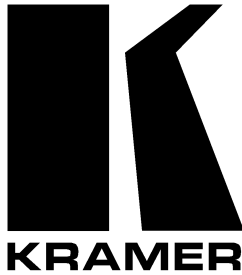

# **USER MANUAL**

**Model:**

**VS-1616V**

*16x16 Video Matrix Switcher*

## Contents

<b>1</b>	<b>Introduction</b>	<b>1</b>
<b>2</b>	<b>Getting Started</b>	<b>1</b>
<b>3</b>	<b>Overview</b>	<b>2</b>
<b>4</b>	<b>Summary of how to Operate a Single Machine</b>	<b>3</b>
<b>5</b>	<b>Your Video Matrix Switcher</b>	<b>4</b>
<b>6</b>	<b>Installing the Video Matrix Switcher</b>	<b>7</b>
6.1	Configuring a Stand Alone Switcher	7
6.1.1	Configuring a single VS-1616V Unit (16x16 CV) for Composite Video	8
6.1.2	Configuring a single VS-1616V Unit (8x8 Y/C Switcher) for s-Video	8
6.1.3	Configuring a single VS-1616V Unit (5x5) YUV/RGB Switcher	8
6.1.4	Configuring a single VS-1616V Unit (4x4) RGBS Switcher	9
6.2	Assembling a Multi-channel Video Switcher	9
6.2.1	Configuring a 16x16 Y/C Switcher (2 Units)	10
6.2.2	Configuring a 16x16 YUV/RGB Switcher (3 Units)	10
6.2.3	Configuring a 16x16 RGBS Switcher (4 Units)	11
6.3	Assembling an Expanded Matrix Switcher	12
6.3.1	Assembling a 32x16 Switcher	12
6.3.2	Assembling a 32x32 Switcher	13
6.4	Assembling a System of Interconnected Switchers	15
6.5	Dipswitch Settings	17
6.5.1	Setting the MACHINE #	17
6.5.2	Setting the MACHINE ADDRESS #	18
6.5.3	Understanding the SYSTEM Mode	18
6.5.4	Understanding the SLAVE Mode	19
6.6	Connecting a Control Interface	19
6.6.1	Connecting the RS-232 Control Interface	20
6.6.1.1	Connecting 2 VS-1616V Units using a Null-modem Adapter	21
6.6.1.2	Connecting 2 VS-1616V Units without using a Null-modem Adapter	21
6.6.1.3	PC DB9 COM Port Connection to a VS-1616V Unit with a Null-modem Adapter	21
6.6.1.4	PC DB9 COM Port Connection to a VS-1616V Unit with no Null-modem Adapter	22
6.6.1.5	PC DB25 COM Port Connection to a VS-1616V Unit with a Null-modem Adapter	22
6.6.1.6	PC DB25 COM Port Connection to a VS-1616V Unit with no Null-modem Adapter	22
6.6.2	Connecting the RS-485 Control Interface	23
6.7	Configuring the Sync	26
6.8	Connecting the KEYBOARD EXTENSION	26
<b>7</b>	<b>Operating Your Video Matrix Switcher</b>	<b>27</b>
7.1	Startup Display	27
7.2	Using the Front Panel Buttons	28
7.2.1	Confirming Settings	28
7.2.1.1	Toggling between the AT ONCE and CONFIRM Modes	29
7.2.2	Switching	29

7.2.2.1	Switching one Input to one Output	29
7.2.2.2	Switching several Inputs to several Outputs	30
7.2.2.3	Switching one Input to all Outputs	31
7.2.3	Clearing	32
7.2.3.1	Clearing an Output	32
7.2.3.2	Clearing several Outputs	33
7.2.3.3	Clearing all Outputs	34
7.2.4	Storing and Recalling Setups	35
7.2.4.1	Storing Setups	35
7.2.4.2	Recalling Setups	35
<b>8</b>	<b>MENU Commands Sequence</b>	<b>36</b>
8.1	Locking and Unlocking the Front Panel	38
8.2	Choosing the Follow-System or Breakaway-From-System Mode	39
8.3	Choosing the Video Format Setting	40
8.4	Setting the MACHINE ADDRESS	41
8.4.1	Changing the MACHINE ADDRESS from stand alone to a large matrix	42
8.4.2	Changing the MACHINE ADDRESS from a large matrix to stand alone	43
8.4.3	Changing the MACHINE ADDRESS from a large matrix setting to a large matrix setting with a different MACHINE ADDRESS	44
8.5	Choosing the SWITCHING METHOD Setting	46
8.5.1	Understanding the SWITCHING METHOD Settings	46
8.5.2	Configuring a SWITCHING METHOD	47
8.6	Choosing the extended Keyboard Setting	48
8.7	Setting the STORE/RECALL KEYBOARD Mode	48
8.8	Choosing what to INDICATE	49
8.9	Choosing the COMMUNICATION Setting	50
8.10	Setting the IR REMOTE Control	51
8.11	Choosing the AUTO STORE Current SETUP	52
8.12	Identifying the MACHINE	52
8.13	Choosing the initial RESET	53
<b>9</b>	<b>Flash Memory Upgrade</b>	<b>54</b>
9.1	Connecting the PC to the RS-232 Port	54
9.2	Upgrading Firmware	54
<b>10</b>	<b>Technical Specifications</b>	<b>57</b>
<b>11</b>	<b>Communication Protocol</b>	<b>57</b>

## Figures

Figure 1: Dipswitch Setup on a Single Machine	3
Figure 2: VS-1616V 16x16 Video Matrix Switcher	5
Figure 3: Configuring the VS-1616V for Composite Video (CV)	8
Figure 4: Configuring the VS-1616V for s-Video (Y/C)	8
Figure 5: Configuring the VS-1616V for YUV (RGB)	9
Figure 6: Configuring the VS-1616V for RGBS	9
Figure 7: Configuring a 16x16 YUV (RGB) Switcher with 3 VS-1616V Switchers	11
Figure 8: MACHINE ADDRESS # Designation	12
Figure 9: Connecting the 32x16 Switcher	13
Figure 10: Connecting the 32x32 Switcher	15
Figure 11: Assembling a System of Interconnected Switchers	16
Figure 12: Rear Panel Dipswitches	17
Figure 13: Connecting a PC to 4 VS-1616V Units	20
Figure 14: Connecting a PC (with a 25-pin connector) without a Null-modem Adapter	22
Figure 15: RS-485 Connector PINOUT	23
Figure 16: Connecting the RS-485 Connectors between 2 VS-1616V Units	24
Figure 17: An RS-485 Control Interface Setup	25
Figure 18: Keyboard Extension (EXT. KEYS) Connector	27
Figure 19: Default Startup Status Display Sequence	28
Figure 20: Sequence of MENU Commands	37
Figure 21: Choosing the MTX (SYNC from Matrix) Setting	47
Figure 22: Choosing what to INDICATE	49
Figure 23: Machine Identification	53

## Tables

Table 1: Quick Reference Operating Guide for a Single Machine	4
Table 2: Front Panel VS-1616V 16x16 Video Matrix Switcher Features	6
Table 3: Rear Panel VS-1616V 16x16 Video Matrix Switcher Features	6
Table 4: Stand Alone Switcher Configuration for CV, Y/C, YUV (RGB) and RGBS	7
Table 5: Multi-channel VS-1616V Configuration for CV, Y/C, YUV (RGB) and RGBS	10
Table 6: Dipswitch Definitions	17
Table 7: Machine # Dipswitch Settings	18
Table 8: Summary of Basic IR-1 Setups	51
Table 9: Summary of Basic IR-1 Operations	51
Table 10: Technical Specifications of the VS-1616V Video Matrix Switcher	57
Table 11: Hex Table for the VS-1616V Video Matrix Switcher	58

## 1 Introduction

Dedication by Kramer Electronics since 1981, to the development and manufacture of high quality video/audio equipment, makes the Kramer line an integral part of the finest production and presentation facilities in the world. In recent years, Kramer has redesigned and upgraded most of the line, making the best even better! The Kramer line of professional video/audio electronics is one of the most versatile and complete available, and is a true leader in terms of quality, workmanship, price/performance ratio and innovation.

In addition to our high quality switchers and matrices, we also offer excellent distribution amplifiers, remote controllers, processors, interfaces and computer-related products.

Congratulations on purchasing your Kramer **VS-1616V** *16x16 Video Matrix Switcher*.

This product is ideal for the following typical applications:

- Professional display systems requiring video signal routing
- Broadcast, presentation and production facilities
- Rental/staging applications
- Monitoring in large duplication systems

The package includes the following items:

- **VS-1616V** *16x16 Video Matrix Switcher*
- Power cord
- Windows 95/98/2000/NT™ Kramer control software
- Null-modem adapter
- This user manual<sup>1</sup>
- Kramer concise product catalog/CD

## 2 Getting Started

We recommend that you:

- Unpack the equipment carefully and save the original box and packaging materials for possible future shipment
- Review the contents of this user manual

---

<sup>1</sup> Download up-to-date Kramer user manuals from the Internet at this URL: <http://www.kramerelectronics.com/manuals.html>

### 3 Overview

The Kramer **VS-1616V** is a high performance 16x16 vertical interval matrix switcher for composite video signals on BNC connectors. In addition to its typical 16x16 operation, the **VS-1616V** can be configured as follows:

- 8x8 for s-Video (Y/C)
- 5x5 for YUV or RGB (with the sync on the Green signal - RG<sub>S</sub>B)
- 4x4 for RGSB signals

A main advantage of the **VS-1616V** is that it forms part of the series of 16x16 matrix switchers that includes, but is not limited to, **VS-1616A** (a 16x16 analog balanced stereo audio matrix switcher), **VS-1616VD** (a 16x16 digital video matrix switcher), **VS-1616AD** (a 16x16 digital audio matrix switcher), and **VS-1616RS** (an RS-422 control signal matrix switcher).

In particular, the **VS-1616V**:

- Produces glitch-free transitions, when sources share a common reference sync<sup>1</sup>
- Offers excellent video performance, which ensures that it remains transparent in almost any video application

In addition the **VS-1616V**:

- May be used as a single unit, or expanded to up to 96 x 96 inputs/outputs
- Can be configured into a Kramer multi-signal switcher system including digital and analog video, digital and analog audio, and RS-422 control switchers
- When integrated in a system, all units switch in true audio-follow-video mode
- Recalls up to 15 (or more<sup>2</sup>) configuration setups via the non-volatile memory and provides for an unlimited quantity of setups when using the Kramer control software on your PC
- Includes a user-friendly LCD display (making operation even easier)
- With its FLASH memory, lets you upgrade to the latest Kramer firmware version via Internet download
- Comes with a choice of protocol format: hexadecimal or ASCII

---

<sup>1</sup> As it switches during the vertical interval

<sup>2</sup> Depending on the firmware version

Control the **VS-1616V**:

- Using the front panel buttons
- Remotely, by RS-485 or RS-232 serial commands transmitted by a touch screen system, PC, or other serial controller
- Remotely, from the Kramer **IR-1** Infra-Red Remote Control Transmitter
- Via external dry-contact push buttons

To achieve the best performance:

- Connect only good quality connection cables, thus avoiding interference, deterioration in signal quality due to poor matching, and elevated noise levels (often associated with low quality cables)
- Avoid interference from neighboring electrical appliances that may adversely influence signal quality and position your Kramer **VS-1616V** in a location free from moisture and away from excessive sunlight and dust

## 4 Summary of how to Operate a Single Machine

By default, the **VS-1616V** is setup for use as a single machine.

This means that it is:

- A 16x16 composite video switcher
- Switched during the vertical interval of the external reference

In particular, be sure that the dipswitches are set as Figure 1 illustrates (see section 6.5 for further details):

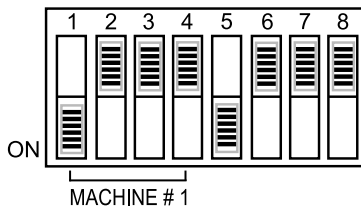

*Figure 1: Dipswitch Setup on a Single Machine*

To operate a single machine, see Table 1.

*Table 1: Quick Reference Operating Guide for a Single Machine*

<b>To perform this command:</b>	<b>Press:</b>
Connect an input with an output	OUT #; IN #
Reset a specific output	OUT #; OFF
Reset all outputs	ALL; OFF
Connect all outputs to a specific input	ALL; IN #
Store a setup	STO; OUT #; TAKE
Recall a setup	RCL; OUT #; TAKE
Lock front panel	MENU; TAKE
Unlock front panel	TAKE; TAKE
Change default setup	Press the Menu button several times until you reach the appropriate Menu setup command and follow the instructions

## 5 Your Video Matrix Switcher

Figure 2 illustrates the front and rear panels of the **VS-1616V**. Tables 1 and 2 define the front and rear panels of the **VS-1616V**, respectively.



## Your Video Matrix Switcher

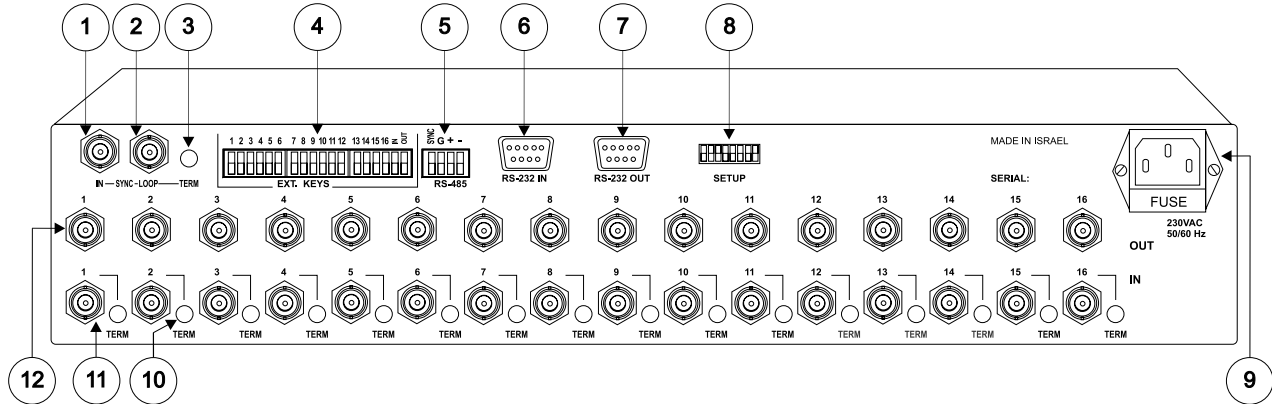
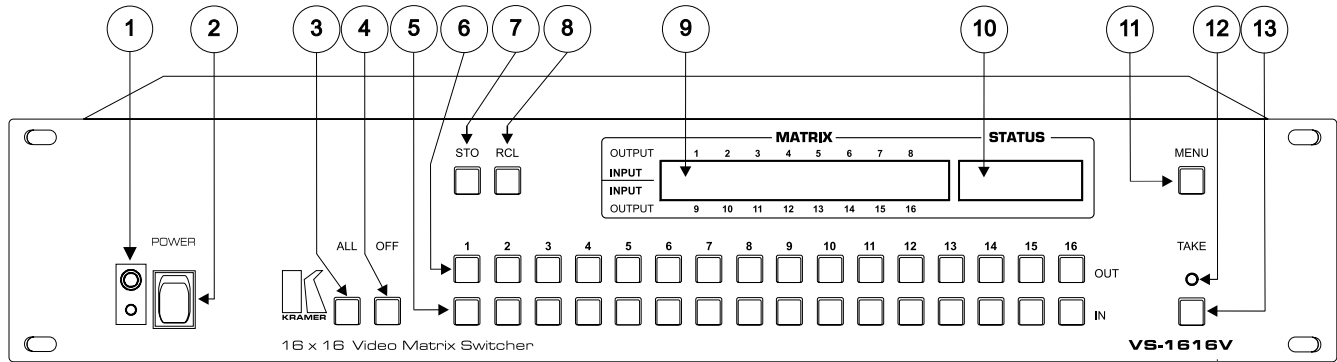

Figure 2: VS-1616V 16x16 Video Matrix Switcher

*Table 2: Front Panel VS-1616V 16x16 Video Matrix Switcher Features*

#	Feature	Function
1	IR Receiver	The red LED is illuminated when receiving signals from the Kramer Infra-red remote control transmitter
2	Power Switch	Illuminated switch supplying power to the unit
3	ALL Button	Pressing ALL followed by an INPUT button, connects that input to all outputs
4	OFF Button	An OFF-OUT combination disconnects that output from the inputs; an OFF-ALL combination disconnects all the outputs
5	IN Buttons	Select the input to switch to the output
6	OUT Buttons	Select the output to which the input is switched
7	STO Button	Stores the current setting in the non-volatile memory
8	RCL Button	Recalls a setup from the non-volatile memory
9	LCD MATRIX Display <sup>1</sup>	Displays the selected input(s) switched to the output(s) (above or below the corresponding OUTPUT label) and user interface messages
10	LCD STATUS Display <sup>1</sup>	Displays the matrix status
11	MENU Button	Selects the programming commands to setup the switcher
12	TAKE LED	Shows the current TAKE button mode aiding the completion of actions
13	TAKE Button	Used to confirm and complete setup and switching

*Table 3: Rear Panel VS-1616V 16x16 Video Matrix Switcher Features*

#	Feature	Function	
1	SYNC IN	IN BNC Connector	Connects to the external video sync source
2		LOOP BNC Connector	Connects to the SYNC IN connector on the next unit
3	TERM SYNC Button	Press to terminate at 75 Ω or release for looping <sup>2</sup>	
4	EXT. (extension) KEYS Terminal Block Connectors	Connects to an external keyboard (remote unit)	
5	RS-485 Detachable Terminal Block Port	Pins # 1 and # 2 are for vertical sync and Ground connection, and Pins # 3 and # 4 are for RS 485	
6	RS-232 IN DB 9F Port	Connects to the PC or the Remote Controller <sup>3</sup>	
7	RS-232 OUT DB 9M Port	Connects to the RS-232 IN DB 9F port of the next unit in the daisy-chain connection	
8	SETUP Dipswitches	Dipswitches for setup of the unit	
9	Power Connector with Fuse	AC connector enabling power supply to the unit	
10	TERM IN Buttons	Press to terminate at 75 Ω or release for looping <sup>4</sup>	
11	IN BNC Connectors	Connect to the video sources	
12	OUT BNC Connectors	Connect to the video acceptors	

1 In sections 7.2.4 and 8, the word “Displays” refers to the LCD MATRIX and STATUS Displays

2 Push in to terminate the sync line. Push out when the sync line extends to another unit

3 If the unit is not the first unit in the line, connects to the RS-232 OUT DB 9F port of the previous unit in the line

4 Push in to terminate the input. Push out when the input extends to another unit (the last unit in the chain must be terminated when looping)

## 6 Installing the Video Matrix Switcher

To install the **VS-1616V**, connect the following<sup>1</sup> to the rear panel, as required:

- Power cord
- Video input and output cables
- Control Interface cables between switcher units, or PC (or other controller), as section 6.6 describes
- Set the dipswitches, as section 6.5 describes
- Set the system variables using the MENU function, as section 8 describes

Using the **VS-1616V** unit and/or other 16x16 matrix switchers in the series<sup>2</sup>, you can assemble the following kinds of systems:

- A stand alone switcher (see section 6.1)
- A multi-channel video switcher (see section 6.2)
- An expanded matrix switcher (see section 6.3)
- A system of interconnected switchers (see section 6.4)

### 6.1 Configuring a Stand Alone Switcher

Configure your **VS-1616V** unit as a stand alone switcher for:

- Composite video (CV) (see section 6.1.1)
- s-Video (Y/C) (see section 6.1.2)
- YUV (RGB) (see section 6.1.3)
- RGBS (see section 6.1.4)

Table 4 defines the number of inputs and outputs for each signal configuration:

*Table 4: Stand Alone Switcher Configuration for CV, Y/C, YUV (RGB) and RGBS*

Configuration	Number of Inputs and Outputs on a Stand Alone Unit
Composite	16x16
s-Video (Y/C)	8x8
YUV / RGB	5x5
RGBS	4x4

<sup>1</sup> Switch OFF the power on each device before connecting it to your VS-1616V

<sup>2</sup> Including the VS-1616A (a 16x16 analog balanced stereo audio matrix switcher), the VS-1616VD (a 16x16 digital video matrix switcher), the VS-1616AD (a 16x16 digital audio matrix switcher), and the VS-1616RS (an RS-422 control signal matrix switcher)

### 6.1.1 Configuring a single VS-1616V Unit (16x16 CV) for Composite Video

By default, a single VS-1616V unit is configured for composite video with 16 inputs and 16 outputs, as Figure 3 illustrates:

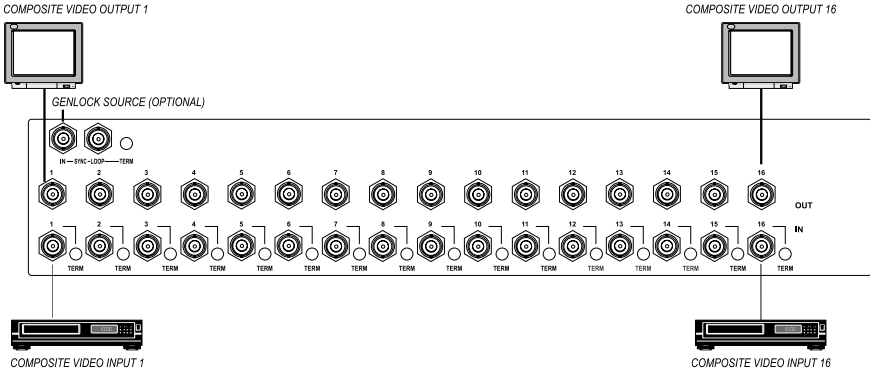

Figure 3: Configuring the VS-1616V for Composite Video (CV)

### 6.1.2 Configuring a single VS-1616V Unit (8x8 Y/C Switcher) for s-Video

Configure a single VS-1616V switcher as an 8x8 video matrix switcher (with 8 inputs and 8 outputs) for s-Video (Y/C) by grouping the inputs and outputs into pairs, as Figure 4 illustrates:

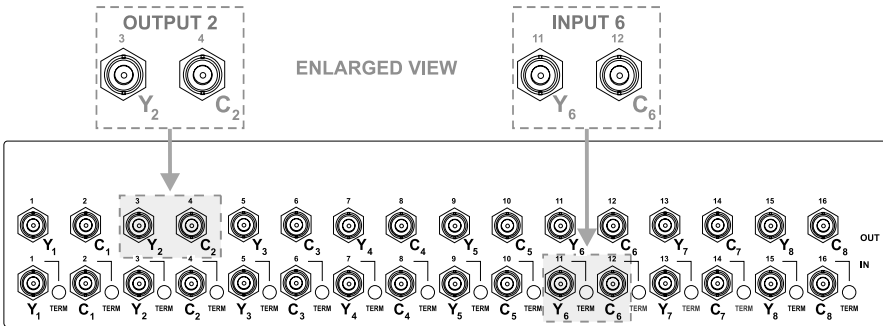

Figure 4: Configuring the VS-1616V for s-Video (Y/C)

### 6.1.3 Configuring a single VS-1616V Unit (5x5) YUV/RGB Switcher

Configure a single VS-1616V switcher as a 5x5 video matrix switcher for YUV (or RGB) by grouping the inputs and outputs<sup>1</sup> into sets of 3, as Figure 5

<sup>1</sup> Input 16 and output 16 are not used

illustrates. The YUV channel is also appropriate for RG<sub>s</sub>B. In this case, connect G<sub>s</sub> for Y, R for V and B for U.

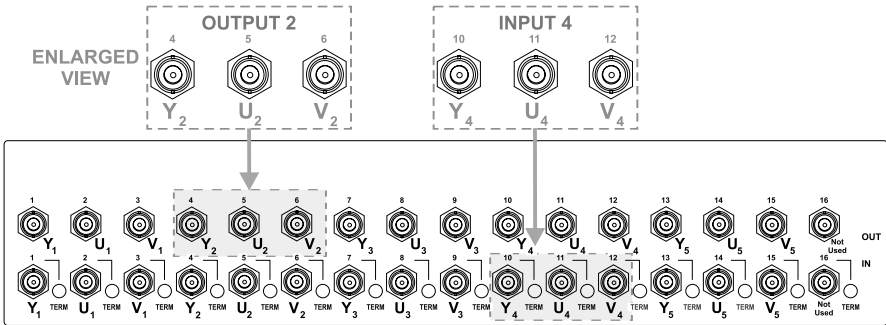

Figure 5: Configuring the VS-1616V for YUV (RGB)

### 6.1.4 Configuring a single VS-1616V Unit (4x4) RGBS Switcher

Configure a single VS-1616V switcher as a 4x4 video matrix switcher for RGBS by grouping the inputs and outputs into sets of 4, as Figure 6 illustrates:

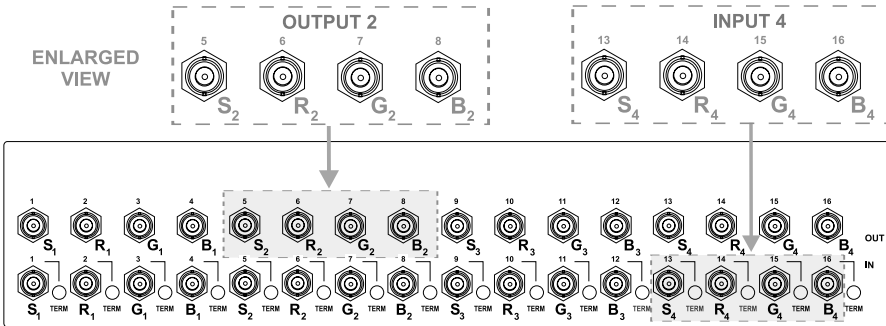

Figure 6: Configuring the VS-1616V for RGBS

## 6.2 Assembling a Multi-channel Video Switcher

Configure VS-1616V units as a 16x16 multi-channel video switcher for:

- s-Video (Y/C) (see section 6.2.1)
- YUV (RGB) (see section 6.2.2)
- RGBS (see section 6.2.3)

Use several VS-1616V units to expand the system, as Table 5 defines. For example, for composite configuration a single VS-1616V unit provides 16

inputs and 16 outputs. However, for s-Video (Y/C) configuration you need 2 **VS-1616V** units to provide 16 inputs and 16 outputs.

In a multi-channel video switcher configuration, only one unit is the Master (with DIP 6 OFF). The other units are Slaves (with DIP 6 ON).

The front panel of each Slave unit is always locked and the *MATRIX* and *STATUS* LCD Displays do not illuminate. The Slave units follow the Master. The Master unit operates in the regular way<sup>1</sup>, leading the Slaves in the background.

To activate a multi-channel video switcher so that each unit is in the same state from the outset, do not turn on the power on the Slave units after the Master unit.

Table 5: Multi-channel VS-1616V Configuration for CV, Y/C, YUV (RGB) and RGBS

Configuration	Number of VS-1616V Units required to make up a 16x16 Switcher
Composite	1
s-Video (Y/C)	2
YUV / RGB	3
RGBS	4

### 6.2.1 Configuring a 16x16 Y/C Switcher (2 Units)

Configure a 16x16 video matrix switcher for s-Video (Y/C) by combining 2 **VS-1616V** switchers. Connect as in Figure 7, substituting the C unit for the U unit and ignoring the V unit. Set the dipswitches as Figure 7 illustrates. Connect the communication line via the RS-232 or RS-485 control interface as section 6.6 describes.

### 6.2.2 Configuring a 16x16 YUV/RGB Switcher (3 Units)

Configure a 16x16 video matrix switcher for YUV by combining<sup>2</sup> 3 **VS-1616V** switchers, as Figure 7 illustrates:

---

<sup>1</sup> The front panel is not locked and the MATRIX and STATUS LCD Displays illuminate

<sup>2</sup> For a description of how to connect the RS-485 connectors between the VS-1616V switchers, refer to section 6.6.2

## Installing the Video Matrix Switcher

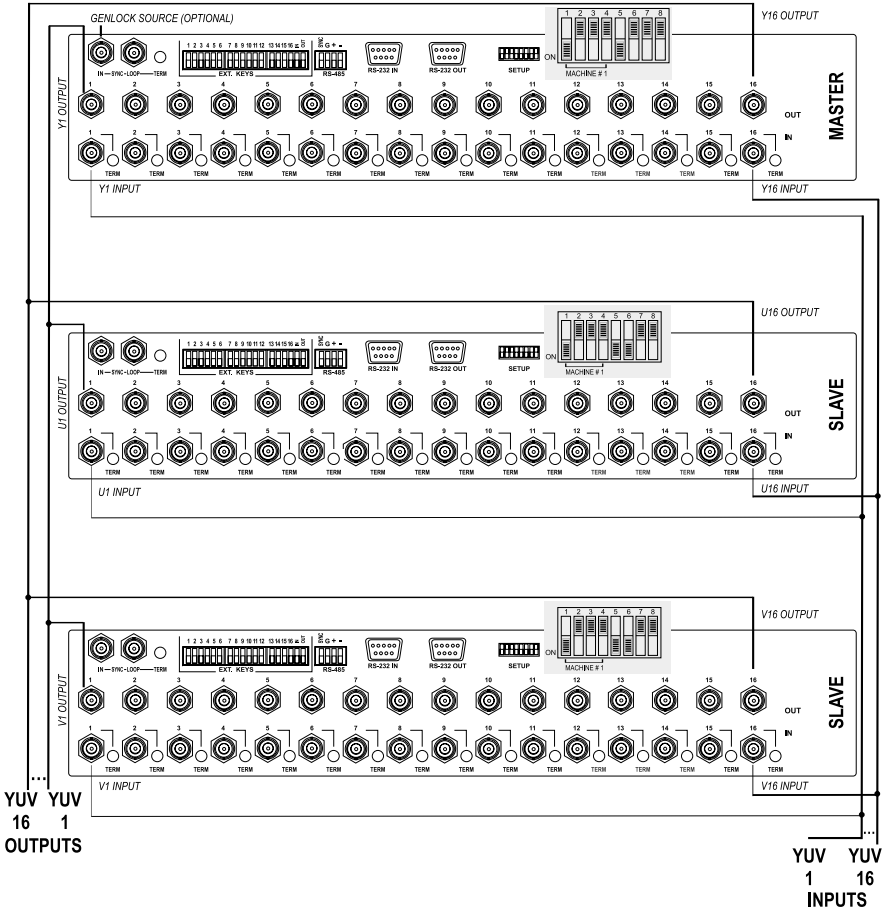

Figure 7: Configuring a 16x16 YUV (RGB) Switcher with 3 VS-1616V Switchers

### 6.2.3 Configuring a 16x16 RGBS Switcher (4 Units)

Configure 4 VS-1616V switchers as a 16x16 video matrix switcher for RGBS, in a similar way to how Figure 7 in section 6.2.2 illustrates combining 3 VS-1616V switchers for YUV (RGB).

### 6.3 Assembling an Expanded Matrix Switcher

You can expand the number of inputs and outputs using several **VS-1616V** units<sup>1</sup>. Set the **MACHINE ADDRESS #** (see section 6.5.2) on each **VS-1616V** unit to define which inputs and outputs are configured to that particular unit when expanding, as the chart in Figure 8 illustrates.

For example, to connect a 48x64 switcher (48 inputs and 64 outputs), you would configure using **MACHINE ADDRESS #** 1, 2, 3, 4; 7, 8, 9, 10; 13, 14, 15 and 16. You can only choose a rectangular<sup>2</sup> configuration from the chart in Figure 8.

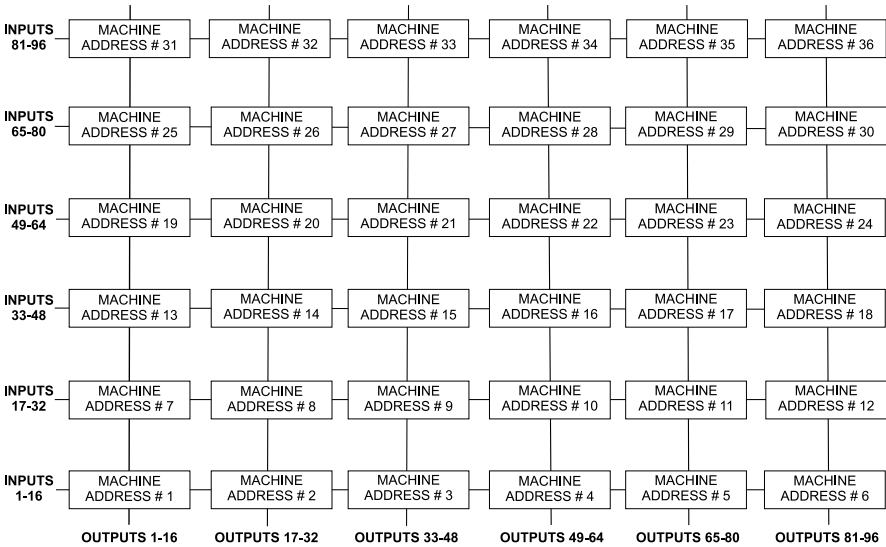

Figure 8: MACHINE ADDRESS # Designation

#### 6.3.1 Assembling a 32x16 Switcher

As can be seen in Figure 8, a 32x16 switcher consists of 2 **VS-1616V** units (**MACHINE ADDRESS #** 1 and **MACHINE ADDRESS #** 7). To assemble, as Figure 9 illustrates:

1. Set the **same** **MACHINE #**<sup>3</sup> (see section 6.5.1) on both **VS-1616V** units.

1 For example, a 32x32 switcher and a 32x16 switcher. In fact, you can connect up to 36 units to form a switcher with 96 inputs and 96 outputs

2 For example, like this:  but not like this: 

3 For a single group, this is usually set to # 1, as in the example in Figure 9



2. Set the MACHINE ADDRESS # on one **VS-1616V** unit to 1 and on the other **VS-1616V** unit to 7 (refer to Figure 8).
3. **Set DIP 6 OFF** on both **VS-1616V** units.
4. Using T-connectors, connect OUTPUTS 1 to 16 on both **VS-1616V** units. OUTPUTS 1 to 16 become the SYSTEM OUTPUTS 1 to 16, while the inputs on the MACHINE ADDRESS # 1 are system inputs 1 to 16, and the inputs on the MACHINE ADDRESS # 7 are system inputs 17 to 32. The 2 **VS-1616V** units form a 32x16 switcher.

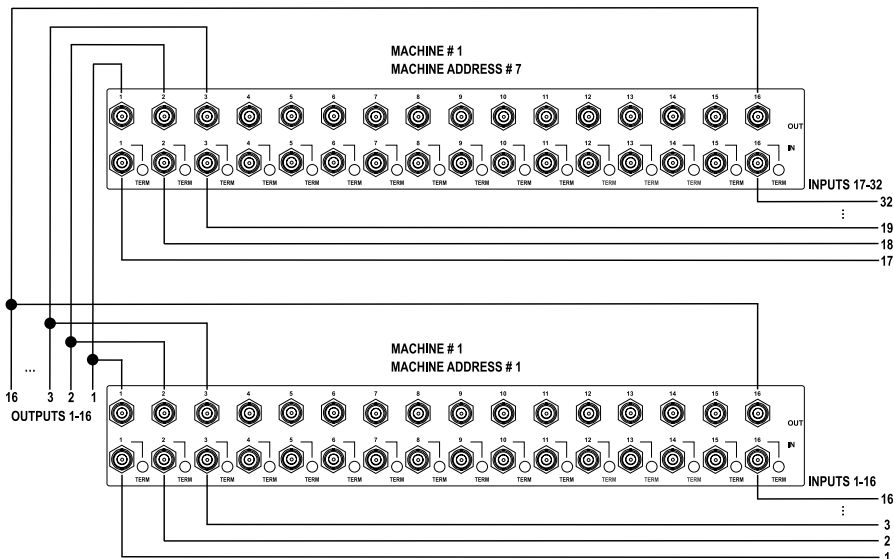

Figure 9: Connecting the 32x16 Switcher

### 6.3.2 Assembling a 32x32 Switcher

As can be seen in Figure 8, a 32x32 switcher consists of 4 **VS-1616V** units (MACHINE ADDRESS # 1, MACHINE ADDRESS # 2, MACHINE ADDRESS # 7 and MACHINE ADDRESS # 8). To assemble, as Figure 10 illustrates:

1. Set the **same** MACHINE #<sup>1</sup> on all the 4 **VS-1616V** units.
2. Set the MACHINE ADDRESS # to 1, 2, 7 and 8 on each of the 4 units, respectively (refer to Figure 8).

<sup>1</sup> Set to # 1 in most cases. In the example in Figure 10, the MACHINE # is set to # 2

3. **Set DIP 6 OFF** on each of the 4 **VS-1616V** units.
4. Using T-connectors, connect INPUTS 1 to 16 on the **VS-1616V** unit designated as MACHINE ADDRESS # 2 with INPUTS 1 to 16 on the **VS-1616V** unit designated as MACHINE ADDRESS # 1. Terminate the INPUTS on MACHINE ADDRESS # 2 to 75  $\Omega$  (push in the *TERM* button<sup>1</sup> next to the INPUT BNCs) and put the inputs in MACHINE ADDRESS # 1 into Hi-Z state (release the *TERM* buttons next to the INPUT BNCs).  
INPUTS 1 to 16 become the SYSTEM INPUTS 1 to 16.
5. Using T-connectors, connect INPUTS 17 to 32 on the **VS-1616V** unit designated as MACHINE ADDRESS # 8 with INPUTS 17 to 32 on the **VS-1616V** unit designated as MACHINE ADDRESS # 7. Terminate the INPUTS on MACHINE ADDRESS # 8 to 75  $\Omega$  (push in the *TERM* button next to the INPUT BNCs) and put the inputs in MACHINE ADDRESS # 7 into Hi-Z state (release the *TERM* buttons next to the INPUT BNCs).  
INPUTS 17 to 32 become the SYSTEM INPUTS 17 to 32.
6. Using T-connectors, connect OUTPUTS 1 to 16 on the **VS-1616V** unit designated as MACHINE ADDRESS # 7 with OUTPUTS 1 to 16 on the **VS-1616V** unit designated as MACHINE ADDRESS # 1.  
OUTPUTS 1 to 16 become the SYSTEM OUTPUTS 1 to 16.
7. Using T-connectors, connect OUTPUTS 17 to 32 on the **VS-1616V** unit designated as MACHINE ADDRESS # 8 with OUTPUTS 17 to 32 on the **VS-1616V** unit designated as MACHINE ADDRESS # 2.  
OUTPUTS 17 to 32 become the SYSTEM OUTPUTS 17 to 32.  
The 4 **VS-1616V** units form a 32x32 switcher.

---

<sup>1</sup> Item 10 on the rear panel in Figure 2

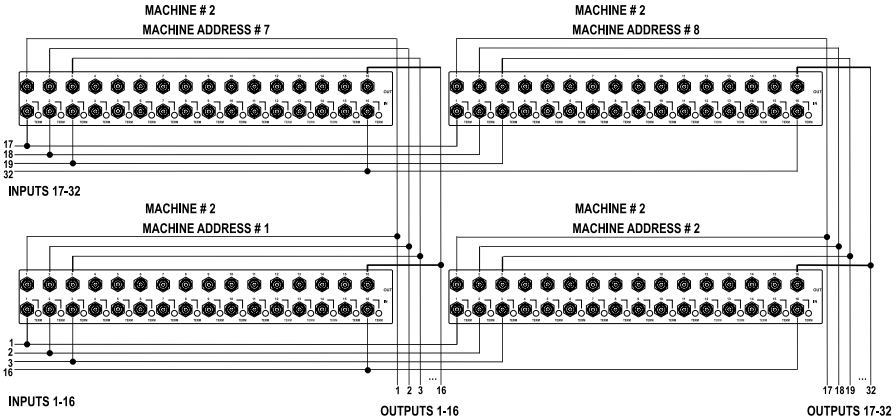

Figure 10: Connecting the 32x32 Switcher

## 6.4 Assembling a System of Interconnected Switchers

A major advantage of the **VS-1616V** is that it belongs to the series of 16x16 matrix switchers and, as such, can interconnect with other switchers in the series. This series includes, but is not limited to, **VS-1616A** (a 16x16 analog balanced stereo audio matrix switcher), **VS-1616VD** (a 16x16 digital video matrix switcher), **VS-1616AD** (a 16x16 digital audio matrix switcher), and **VS-1616RS** (an RS-422 control signal matrix switcher).

The block diagram in Figure 11 illustrates how to assemble an interconnected varied-format 16x16 series switcher that consists of a 32x32 composite video matrix switcher, a 32x16 digital video matrix switcher, a 32x32 balanced stereo audio matrix switcher, and a 16x16 digital audio matrix switcher.

Note that each group of switchers has a unique **MACHINE #** that is shared by all members of the group. In Figure 11, the 32x32 composite video matrix switcher is **MACHINE # 1**, the 32x16 digital video matrix switcher is **MACHINE # 2** and so on. Control of the system is via the **MACHINE #'s**.

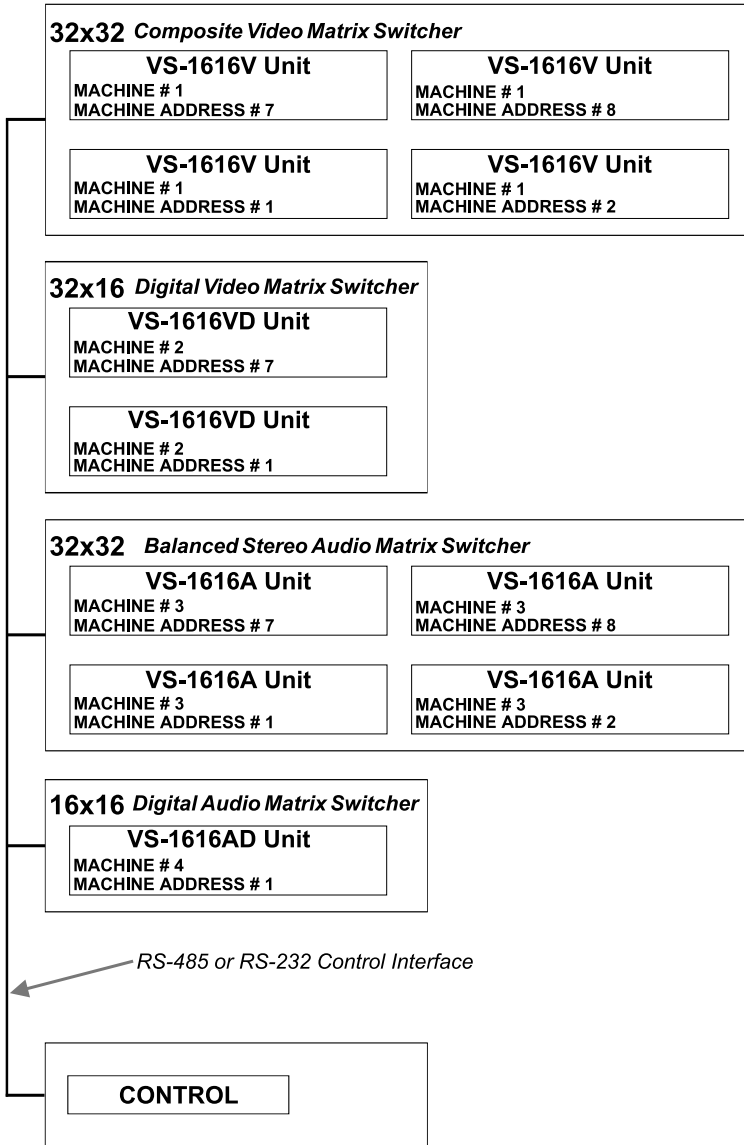

Figure 11: Assembling a System of Interconnected Switchers

Refer to section 6.5 for details of how to set the dipswitches, and to section 6.6 for details of how to control this group of interconnected varied-format 16x16 series switchers, and other configurations.

## 6.5 Dipswitch Settings

Configure the **VS-1616V** by setting the 8 dipswitches as Figure 12 and Table 6 define:

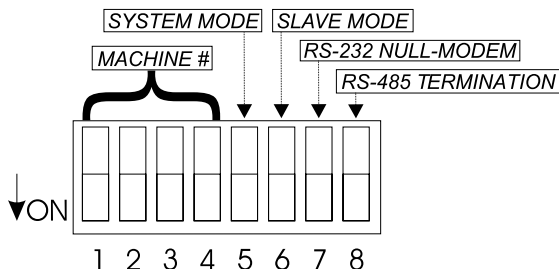

Figure 12: Rear Panel Dipswitches

Table 6: Dipswitch Definitions

Dipswitch #	Function:
1-4	Set the MACHINE # (see Table 7 in section 6.5.1)
5	Enables (ON) or disables (OFF) the <i>Follow-SYSTEM</i> mode
6	Enables (ON) or disables (OFF) the <i>SLAVE</i> mode in a multi-channel configuration
7	Disables use of a null modem adapter <sup>1</sup> with RS-232 OFF = RS-232 connection via a null modem adapter ON = RS-232 connection without a null modem adapter
8	RS-485 termination for first and last machine = ON (RS-485 line terminates with 110Ω); for others = OFF (RS-485 line is open)

### 6.5.1 Setting the MACHINE #

To control a unit via RS-232 or RS-485, each unit has to be identified via its unique MACHINE #. In an extended matrix configuration, in addition to the MACHINE #, each unit is identified via its MACHINE ADDRESS #.

Set the MACHINE #<sup>2</sup> on a **VS-1616V** unit according to Table 7.

A valid MACHINE # is from 1 to 15.

<sup>1</sup> See section 6.6.1

<sup>2</sup> When using a single unit, set the unit to MACHINE # 1

Table 7: Machine # Dipswitch Settings

MACHINE #	DIPSWITCH			
	1	2	3	4
1	ON	OFF	OFF	OFF
2	OFF	ON	OFF	OFF
3	ON	ON	OFF	OFF
4	OFF	OFF	ON	OFF
5	ON	OFF	ON	OFF
6	OFF	ON	ON	OFF
7	ON	ON	ON	OFF
8	OFF	OFF	OFF	ON
9	ON	OFF	OFF	ON
10	OFF	ON	OFF	ON
11	ON	ON	OFF	ON
12	OFF	OFF	ON	ON
13	ON	OFF	ON	ON
14	OFF	ON	ON	ON
15	ON	ON	ON	ON

### 6.5.2 Setting the MACHINE ADDRESS #

The MACHINE ADDRESS # is determined via the MACHINE ADDRESS Menu command, as section 8.4 describes. The MACHINE ADDRESS # defines which inputs and outputs are configured to that particular unit when expanding, as the chart in Figure 8 illustrates.

A valid MACHINE ADDRESS # is from 1 to 36.

### 6.5.3 Understanding the SYSTEM Mode

DIP 5 defines whether the **VS-1616V** unit communicates with other switchers via a common control line.

You can set **DIP 5 OFF** to disable the *Follow-SYSTEM* mode in the following applications:

- Stand alone switcher applications<sup>1</sup>
- A multi-channel video switcher application<sup>2</sup>
- An expanded matrix switcher application<sup>3</sup>

You **must set DIP 5 ON** to enable the *Follow-SYSTEM* mode in an interconnected varied-format switcher application<sup>4</sup>

---

<sup>1</sup> See section 6.1

<sup>2</sup> See section 6.2

<sup>3</sup> See section 6.3

<sup>4</sup> See section 6.4

Refer to section 8.2 for a description of the MENU's *Follow-SYSTEM* and *Breakaway-from- SYSTEM* modes.

### 6.5.4 Understanding the SLAVE Mode

The SLAVE mode is only used for the multi-channel video switcher configuration<sup>1</sup>, for example, when using 3 **VS-1616V** units to form a YUV switcher, as Figure 7 illustrates.

One unit is used as the Master, and the other 2 units are Slaves. The Slaves always follow the Master. In the example illustrated in Figure 7, the first **VS-1616V** unit is the Master (with DIP 6 set OFF disabling the Slave mode) and the second and third **VS-1616V** units are Slaves (with DIP 6 set ON enabling the Slave mode).

On both Slave **VS-1616V** units, the MATRIX and STATUS Displays do not illuminate and the STATUS Display shows the following message:

#### **Keyboard LOCKED**

However, the STATUS Display on each Slave **VS-1616V** unit dynamically shows<sup>2</sup> all changes made from the Master **VS-1616V** unit.

Front panel control is via the Master **VS-1616V** unit, on which the front panel buttons are unlocked and both the MATRIX and STATUS Displays illuminate.

## 6.6 Connecting a Control Interface

Connect a control interface (RS-232 or RS-485) unless operating a **VS-1616V** as a stand alone unit without any control device (that is, with control from the front panel or IR port, and not via a remote controller or a PC).

The control interface must be identical on each switcher in the series of 16x16 matrix switchers; either RS-232 or RS-485. One control interface suffices. Do not use both RS-232 and RS-485 control interfaces in the same configuration. For example, in an interconnected varied-format 16x16 switcher application<sup>3</sup>, if the switcher that connects to the PC connects via the RS-232 control interface, each switcher must interconnect via the RS-232 control interface and not via the RS-485 control interface.

Choose the RS-232 control interface, for a range of about 25 meters used for a point-to-point connection.

---

<sup>1</sup> See section 6.2

<sup>2</sup> Albeit with an LCD Display that does not illuminate

<sup>3</sup> See section 6.4

Choose the RS-485 control interface, to operate the switcher from an extended distance of up to 1000 meters.

### 6.6.1 Connecting the RS-232 Control Interface

Connect several switchers (from the series of 16x16 matrix switchers) and the control unit in an RS-232 daisy chain arrangement, with or without using a Null-modem adapter, as Figure 13 illustrates.

The RS-232 daisy chain switcher arrangement is transparent. This lets you arrange the switchers (from the series of 16x16 matrix switchers) according to your requirements, and not according to a fixed sequence dependent on the MACHINE # and/or MACHINE ADDRESS #.

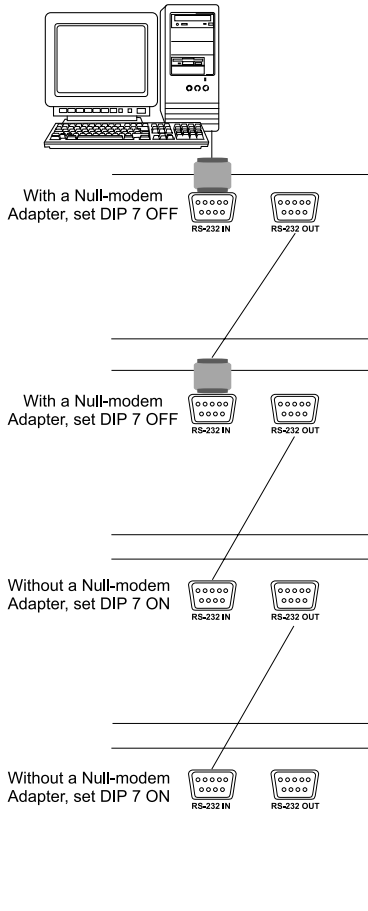

Figure 13: Connecting a PC to 4 VS-1616V Units



You can connect any of the following:

- 2 **VS-1616V** units, using a Null-modem adapter (see section 6.6.1.1) or without using a Null-modem adapter (see section 6.6.1.2)
- The PC's DB9 COM port to a **VS-1616V** unit with a Null-modem adapter (see section 6.6.1.3) or without a Null-modem adapter (see section 6.6.1.4)
- The PC's DB25 COM port to a **VS-1616V** unit with a Null-modem adapter (see section 6.6.1.5) or without a Null-modem adapter (see section 6.6.1.6)

#### 6.6.1.1 Connecting 2 VS-1616V Units using a Null-modem Adapter

To connect 2 **VS-1616V** units, **using a Null-modem adapter** provided with the machine (default):

1. Connect a flat cable<sup>1</sup> between the RS-232 OUT DB9 port on the first **VS-1616V** unit and the Null-modem adapter that attaches to the RS-232 IN DB9 port on the second **VS-1616V** unit.
2. On the second **VS-1616V** unit, set **DIP 7 OFF** (enabling Null-modem adapter use).

#### 6.6.1.2 Connecting 2 VS-1616V Units without using a Null-modem Adapter

To connect 2 **VS-1616V** units, **without using a Null-modem adapter**:

1. Connect a flat cable<sup>1</sup> between the RS-232 OUT DB9 port on the first **VS-1616V** unit and the RS-232 IN DB9 port on the second **VS-1616V** unit.
2. On the second **VS-1616V** unit, set **DIP 7 ON** (disabling Null-modem adapter use<sup>2</sup>).

#### 6.6.1.3 PC DB9 COM Port Connection to a VS-1616V Unit with a Null-modem Adapter

To connect the PC's DB9 COM port to a **VS-1616V** unit, **using a Null-modem adapter**:

1. Connect a flat cable<sup>1</sup> between the PC's DB9 COM port and the Null-modem adapter that attaches to the RS-232 IN DB9 port on the **VS-1616V** unit.
2. Set **DIP 7 OFF** (enabling Null-modem adapter use<sup>2</sup>) on the **VS-1616V** unit.

---

<sup>1</sup> Straight one-to-one uncrossed connections with at least the 3 wires pins # 2, # 3 and # 5

<sup>2</sup> See section 6.5

### 6.6.1.4 PC DB9 COM Port Connection to a VS-1616V Unit with no Null-modem Adapter

To connect the PC's DB9 COM port to a **VS-1616V** unit, **without using a Null-modem adapter**:

1. Connect a flat cable<sup>1</sup> between the PC's DB9 COM port and the RS-232 IN DB9 port on the **VS-1616V** unit.
2. **Set DIP 7 ON** (disabling Null-modem adapter use<sup>2</sup>) on the **VS-1616V** unit.

### 6.6.1.5 PC DB25 COM Port Connection to a VS-1616V Unit with a Null-modem Adapter

To connect the PC's DB25 COM port to a **VS-1616V** unit, **using a Null-modem adapter**:

1. Connect a flat cable<sup>1</sup> between the PC's DB25 COM port and the Null-modem adapter that attaches to the RS-232 IN DB9 port on the first **VS-1616V** unit.
2. **Set DIP 7 OFF** (enabling Null-modem adapter use<sup>2</sup>) on the **VS-1616V** unit.

### 6.6.1.6 PC DB25 COM Port Connection to a VS-1616V Unit with no Null-modem Adapter

To connect the PC's DB25 COM port to a **VS-1616V** unit, **without using a Null-modem adapter**:

1. Connect the PC's DB25 COM port to the RS-232 IN DB9 port on the **VS-1616V** unit, as Figure 14 illustrates:

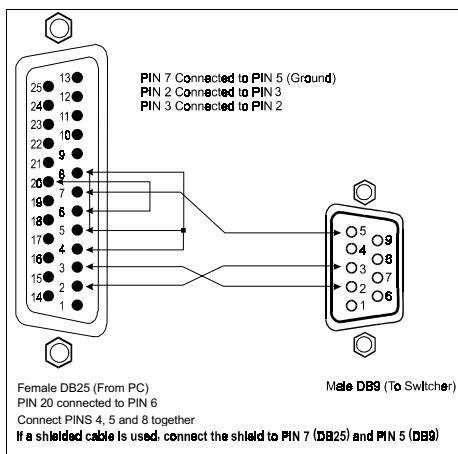

Figure 14: Connecting a PC (with a 25-pin connector) without a Null-modem Adapter

1 Straight one-to-one uncrossed connections with at least the 3 wires pins # 2, # 3 and # 5

2 See section 6.5

2. **Set DIP 7 ON** (disabling Null-modem adapter use<sup>1</sup>) on the **VS-1616V** unit.

### 6.6.2 Connecting the RS-485 Control Interface

Figure 15 defines the RS-485 connector PINOUT for external RS-485 control. The RS-485 connector is also used (if required) for vertical sync:

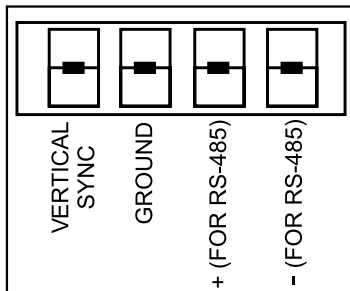

*Figure 15: RS-485 Connector PINOUT*

To connect an RS-485 connector on one **VS-1616V** unit to an RS-485 connector on one or more other switchers (from the series of 16x16 matrix switchers), as Figure 16 illustrates:

1. Connect the “+” PIN on the first **VS-1616V** unit to the “+” PIN on the second **VS-1616V** unit or other unit
2. Connect the “-” PIN on the first **VS-1616V** unit to the “-” PIN on the second **VS-1616V** unit or other unit
3. If shielded cable is used for an RS-485 connection, connect the shield to the Ground PIN.

For details about how to configure the vertical sync (if required), refer to section 6.7 and Figure 21 in section 8.5.1.

<sup>1</sup> See section 6.5

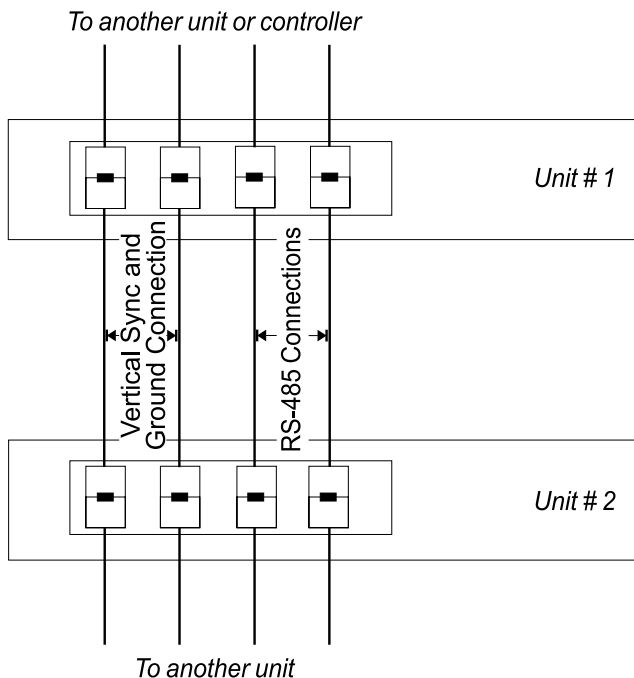

Figure 16: Connecting the RS-485 Connectors between 2 VS-1616V Units

Figure 17 illustrates the RS-485 line that connects:

- Between each **VS-1616V** unit
- To the PC via a Kramer Tools **VP-43xl Interface Converter** (connect the PC's DB 9 COM port to the "RS-232 in" DB9F port on the **VP-43xl**. Next, connect the RS-485 port on the **VP-43xl** to the RS-485 ports on the **VS-1616V** units)

# Installing the Video Matrix Switcher

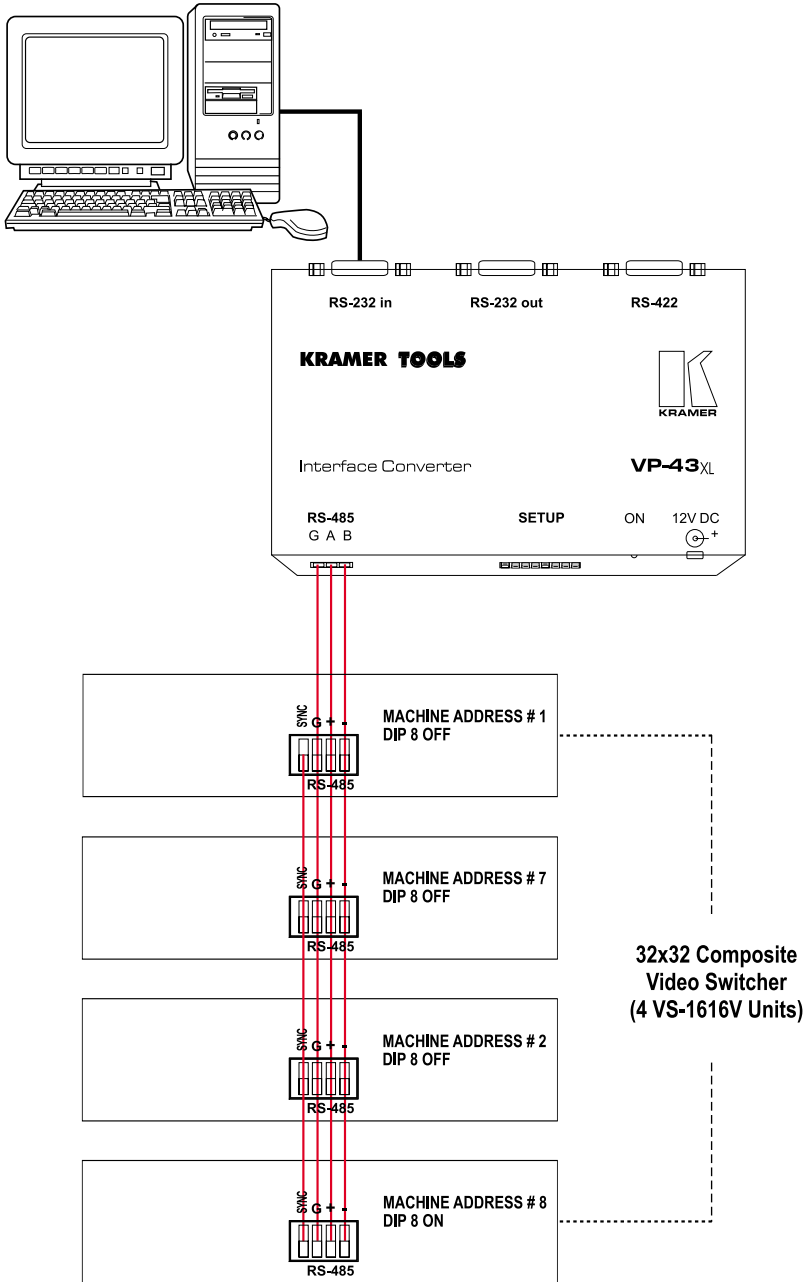

Figure 17: An RS-485 Control Interface Setup

## 6.7 Configuring the Sync

On the **VS-1616V**, you can select one of the following, as the sync input:

- EXTERNAL (“sync in” BNC connector)
- INPUT # 1 BNC connector
- MTX (Sync from Matrix) RS-485 Terminal Block connector, when using multiple machines<sup>1</sup>

Configure the sync via the SWITCHING METHOD Menu command setting<sup>2</sup>. When setting up multiple machines (for example, a 48x64 switcher) or a 16x16 YUV switcher, linking a common sync to all the machines may be necessary to facilitate simultaneous vertical interval switching.

Usually, the easiest method is to choose the sync source from the first machine (for example, the Y unit in a 16x16 YUV switcher configuration, as section 6.2.2 describes) and then connect all the terminal block connectors, as Figure 7 illustrates.

In this case, set the first machine to select the sync source from the external sync connector or from the INPUT # 1 connector. This sync is now available to the other machines via the RS-485 terminal block connector, as Figure 15 and Figure 16 illustrate. Select the MTX sync on the other machines that receive that sync.

## 6.8 Connecting the KEYBOARD EXTENSION

Connecting dry contact-closure switches to the Keyboard Extension (*EXT. KEYS*) connector enables you to route an input to an output by remote control from a distance of up to 1000 meters. These IN and OUT keys are expandable<sup>3</sup>. Figure 18 illustrates how to connect the Keyboard Extension (*EXT. KEYS*):

---

<sup>1</sup> Refer to section 8.5.1

<sup>2</sup> Refer to section 8.5

<sup>3</sup> Add an unlimited number of push buttons to the existing keys (in parallel) by attaching one end of the push button to the corresponding number and the other end to the IN or OUT

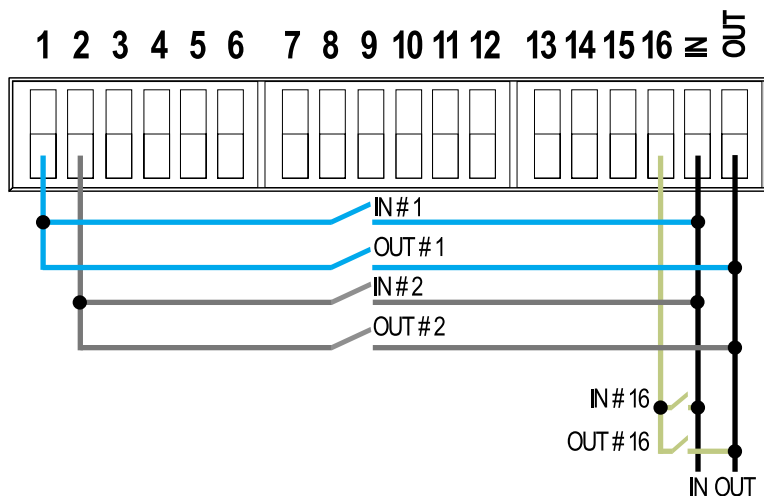

Figure 18: Keyboard Extension (EXT. KEYS) Connector

To use the Keyboard Extension, activate the extended KEYBOARD setting Menu command, as section 8.6 describes.

## 7 Operating Your Video Matrix Switcher

Operate your **VS-1616V** via:

- The front panel buttons (as this section describes)
- RS-232 or RS-485 serial commands transmitted by a touch screen system, PC<sup>1</sup>, or other serial controller
- The Kramer **IR-1** Infra-Red Remote Control Transmitter
- Dry contact-closure switches connected to the Keyboard Extension

### 7.1 Startup Display

After switching on the power, the *MATRIX* and *STATUS*<sup>2</sup> displays show the following screens in sequence:

1 For instructions on using Kramer Windows 95/98/NT™ Control Software, refer to the separate user manual (included on the CD-ROM in .pdf format), *Kramer Control Software*

2 Version 1.5 is shown in the Status Display as an example; text in the Matrix Display may vary (according to machine settings)

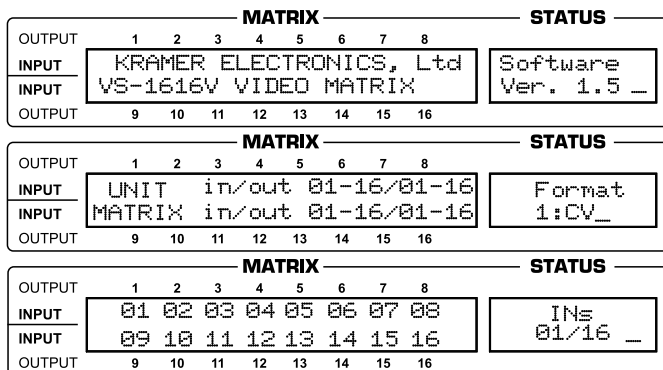

Figure 19: Default Startup Status Display Sequence

## 7.2 Using the Front Panel Buttons

You can switch (see section 7.2.2) and clear (see section 7.2.3):

- One input to one output
- Several inputs to several outputs
- One input to all outputs

### 7.2.1 Confirming Settings

Choose to work in the *AT ONCE* mode or the *CONFIRM* mode:

In the *AT ONCE* (default<sup>1</sup>) mode:

- Actions require no user confirmation
- Execution is immediate
- No protection is offered against changing an action in error

In the *CONFIRM* mode<sup>2</sup>:

- You have an optional method to help avoid making a mistake
- Every action requires user confirmation
- Execution is delayed<sup>3</sup> until the user confirms the action
- Protection is offered to prevent erroneous switching
- You can key-in several actions and then confirm them by pressing the TAKE button once, to simultaneously switch several monitors

<sup>1</sup> For all actions except storing/recalling setups

<sup>2</sup> The CONFIRM mode is the default for storing/recalling setups (see section 8.7)

<sup>3</sup> Failure to press the TAKE button within 30 seconds to one minute (the Timeout) will abort the action



### 7.2.1.1 Toggling between the AT ONCE and CONFIRM Modes

To toggle between the AT ONCE (default) mode and the CONFIRM mode, press the TAKE button.

In CONFIRM mode: Actions require user confirmation and the TAKE LED lights.

In AT ONCE mode: Actions do not require user confirmation and the TAKE LED does not light.

When the TAKE LED blinks:

- You cannot toggle between the AT ONCE and CONFIRM modes
- You can execute the previous action, by pressing the TAKE button
- You can cancel the previous action, by pressing a non-relevant button (for example, the MENU button)

### 7.2.2 Switching

You can switch:

- One input to one output (see section 7.2.2.1)
- Several inputs to several outputs (see section 7.2.2.2)
- One input to all outputs (see section 7.2.2.3)

#### 7.2.2.1 Switching one Input to one Output

Pressing an OUT-IN combination when your **VS-1616V** operates in the AT ONCE mode implements the switch immediately.

To switch one input to one output (AT ONCE mode):

1. Press the appropriate OUT button.  
The MATRIX Display shows the 2 blinking digits, representing the present input number connected to that specific output<sup>1</sup>. If the present output is clear, the 2 blinking digits *00* appear in the MATRIX Display. The STATUS Display shows the message:

**out # x**

Where x is the output number

2. Press the appropriate IN button.  
The output switches to the input and the MATRIX Display shows the Input # instead of the blinking digits.  
The STATUS Display momentarily shows the message:

---

<sup>1</sup> For example, pressing OUT button 9 shows the blinking digits 01 if input 1 was previously routed to OUT 9

**out # x**  
**from in # y**

Where x is the output number and y is the input number

Pressing an OUT-IN combination when your **VS-1616V** operates in the CONFIRM mode (and the TAKE LED is lit), requires user confirmation.

To switch one input to one output (CONFIRM mode):

1. Repeat step 1 above.
2. Press the appropriate IN button.  
The MATRIX Display shows the 2 blinking digits, representing the input number and the TAKE LED blinks.  
The STATUS Display shows<sup>1</sup> the message:

**out # x**  
**from in # y**

Where x is the output number and y is the input number

3. Press the TAKE button to confirm the action.  
The output switches to the input and the TAKE LED lights.

#### **7.2.2.2 Switching several Inputs to several Outputs**

In the *AT ONCE* mode, you need to execute each OUT-IN combination separately (see section 7.2.2.1). When switching many inputs to many outputs it is recommended to toggle to the CONFIRM mode.

In the CONFIRM mode you can key-in several actions and then confirm them by pressing the TAKE button once (simultaneously switching several inputs to several outputs).

To switch several inputs to several outputs in the CONFIRM mode (the TAKE LED is lit), do the following:

1. Press the appropriate OUT button.  
The MATRIX Display shows the 2 blinking digits, representing the previous input number for that specific output<sup>2</sup>. If the previous input is clear, the 2 blinking digits 00 appear in the MATRIX Display.  
The STATUS Display shows the message:

**out # x**

Where x is the output number

---

<sup>1</sup> Continuously, within the limit of the timeout (approximately 30 seconds to one minute)

<sup>2</sup> For example, pressing OUT button 9 shows the blinking digits 01 if input 1 was previously routed to OUT 9

2. Press the appropriate IN button.  
The MATRIX Display shows the 2 blinking digits, representing the input number and the TAKE LED blinks.  
The STATUS Display shows<sup>1</sup> the message:

**out # x  
from in # y**

Where x is the output number and y is the input number

3. Press the second appropriate OUT button, repeating step 1 above.
4. Press the appropriate<sup>2</sup> IN button, repeating step 2 above.
5. Continue with this OUT-IN button sequence, pressing the appropriate OUT and IN buttons, as required. You can also combine an OUT-OFF or OFF-OUT combination with this sequence.
6. After completing the sequence, press the TAKE button to confirm the actions.  
The inputs switch to the respective outputs, as the MATRIX Display shows (no digits blink) and the TAKE LED lights.

#### 7.2.2.3 Switching one Input to all Outputs

To switch one input to all the outputs (in the AT ONCE mode):

1. Press the ALL button.  
The MATRIX Display shows all the sets of 2 blinking digits (each representing the present input number for that respective output) blinking simultaneously.  
The STATUS Display shows the message:

**all OUTs**

2. Press the appropriate IN button.  
This input switches to all the outputs and the MATRIX Display shows the identical non-blinking 2 digits (representing that input number).

To switch one input to all the outputs (in the CONFIRM mode, (the TAKE LED is lit)):

1. Repeat steps 1 and 2 above.  
The TAKE LED blinks.

---

<sup>1</sup> Continuously, within the limit of the timeout (approximately 30 seconds to one minute)

<sup>2</sup> That corresponds with the second OUT button

2. Press the TAKE button to confirm the action.  
The selected input switches to all the outputs and the TAKE LED lights.  
The MATRIX Display shows the identical 2 non-blinking digits (representing that input number) for all outputs.

### 7.2.3 Clearing<sup>1</sup>

You can clear (delete):

- One output (see section 7.2.3.1)
- Several outputs (see section 7.2.3.2)
- All outputs (see section 7.2.3.3)

#### 7.2.3.1 Clearing an Output

To clear an output (in the AT ONCE mode):

1. Press the appropriate OUT button.  
The MATRIX Display shows the 2 blinking digits, representing the present input number for that specific output<sup>2</sup>. If the present input is clear, the 2 blinking digits 00 appear in the MATRIX Display.  
The STATUS Display shows the message:

**out # x**

Where x is the output number

2. Press the OFF button<sup>3</sup>.  
The input is cleared and the MATRIX Display does not show any Input # in its place.  
The STATUS Display momentarily shows the message:

**out # x  
reset**

Where x is the output number

To clear an output (in the CONFIRM mode (the TAKE LED is lit)):

1. Repeat step 1 above.
2. Press the OFF button<sup>3</sup>.  
The MATRIX Display shows the 2 blinking digits 00 instead of the

---

<sup>1</sup> "Clearing" means disconnecting the output from any of the inputs, and leaving it disconnected

<sup>2</sup> For example, pressing OUT button 9 shows the blinking digits 01 if input 1 was previously routed to OUT 9

<sup>3</sup> You can press the OFF button first, and then an OUT button (the order is irrelevant)

previous 2 blinking digits and the TAKE LED blinks.  
The STATUS Display shows<sup>1</sup> the message:

**out # x**  
**reset**

Where x is the output number

3. Press the TAKE button to confirm the action.  
The input is cleared and the TAKE LED lights. The MATRIX Display does not show any Input # in its place.

### 7.2.3.2 Clearing several Outputs

To clear several outputs (in the AT ONCE mode):

1. Press the appropriate OUT button.  
The MATRIX Display shows the 2 blinking digits, representing the present input number for that specific output<sup>2</sup>. If the present output is clear, the 2 blinking digits 00 appear in the MATRIX Display.  
The STATUS Display shows the message:

**out # x**

Where x is the output number

2. Press the OFF button.  
The output is cleared and the MATRIX Display does not show any Input # in its place.  
The STATUS Display momentarily shows the message:

**out # x**  
**reset**

Where x is the output number

To clear several outputs (in the CONFIRM mode (the TAKE LED is lit)):

1. Repeat step 1 above.
2. Press the OFF button.  
The MATRIX Display shows the 2 blinking digits 00 instead of the previous 2 blinking digits and the TAKE LED blinks.  
The STATUS Display shows<sup>1</sup> the message:

**out # x**  
**reset**

---

<sup>1</sup> Continuously, within the limit of the timeout (approximately 30 seconds to one minute)

<sup>2</sup> For example, pressing OUT button 9 shows the blinking digits 01 if input 1 was previously routed to OUT 9

Where x is the output number

3. Press the second appropriate OUT button, by repeating step 1 above.
4. Repeat step 2 above.
5. Continue with this OUT-OFF button sequence, pressing the appropriate OUT buttons and the OFF, as required.

The MATRIX Display shows the sets of 2 blinking digits, representing the present input number for each specific output.

6. After completing the sequence, press the TAKE button to confirm the actions.  
The inputs are cleared and the TAKE LED lights. The MATRIX Display does not show any Input # in its place.

### 7.2.3.3 Clearing all Outputs

To clear all outputs (in the AT ONCE mode):

1. Press the ALL button.  
The MATRIX Display shows all the sets of 2 blinking digits (each representing the present input number connected to that respective output) blinking simultaneously.  
The STATUS Display shows the message:

**all OUTs**

2. Press the OFF button<sup>1</sup>.  
All the outputs are cleared and the MATRIX Display momentarily shows the message:

**Reset ALL connections  
!!!!**

To switch one input to all the outputs (in the CONFIRM mode (the TAKE LED is lit)):

1. Repeat step 1 above.
2. Press the OFF button<sup>1</sup>.  
The TAKE LED blinks and the MATRIX Display shows the message:

**Reset ALL ?  
Press TAKE to execute**

3. Press the TAKE button to confirm.  
All the outputs are cleared and the TAKE LED lights.

---

<sup>1</sup> You can press the OFF button first, and then the ALL button (the order is irrelevant)

## 7.2.4 Storing and Recalling Setups

You can store up to 15 settings in the non-volatile memory with the ability to recall each of those settings.

### 7.2.4.1 Storing Setups

To store a setting, do the following:

1. Press the STO button.  
The Displays show the messages:

<b>Enter SETUP number</b>	<b>Store</b>
<b>use OUTkey 1-15</b>	<b># x</b>

Where x is the OUT button

2. Press an OUT button.  
The TAKE LED blinks and the Displays show the messages:

<b>STORE this SETUP ?</b>	<b>Store</b>
<b>YES -&gt; TAKE</b>	<b># x</b>

3. Press the TAKE button.  
The memory stores the setup and the MATRIX Display shows the message:

**Setup # x stored**

Note, saving a setup to an already allocated setup #, prompts the message in the MATRIX Display:

**Setup already exists**  
**Press TAKE to overwrite**

Pressing the TAKE button replaces the stored setup with the current setup. Alternatively, press a different OUT button to change the setup #.

### 7.2.4.2 Recalling Setups

To recall a setting, do the following:

1. Press the RCL button.  
The Displays show the messages:

<b>Enter SETUP number</b>	<b>RECALL</b>
<b>use OUTkey 1-15</b>	<b># x</b>

Where x is the OUT button

2. Press the appropriate OUT button.  
The memory recalls the setup. The MATRIX Display shows the blinking setup and the TAKE LED blinks. The STATUS Display shows the message:

**SETUP # y**  
**Load ?**

Where y is the OUT button

3. Preview the setup to decide whether to implement it. If not, you can scan the other setups, by pressing different OUT buttons. To stop previewing the setups, press a non-relevant button, for example, an IN button.
4. Press the TAKE button.  
The specific setup is implemented.

If trying to recall an empty setup<sup>1</sup>, the MATRIX Display would show a message saying that that particular setup is empty and would return you to step 1 above.

## **8 MENU Commands Sequence**

You can press the MENU button up to 13 times in straight sequence to scan the range of commands.

---

<sup>1</sup> That is, a setup # for which no setup is actually stored



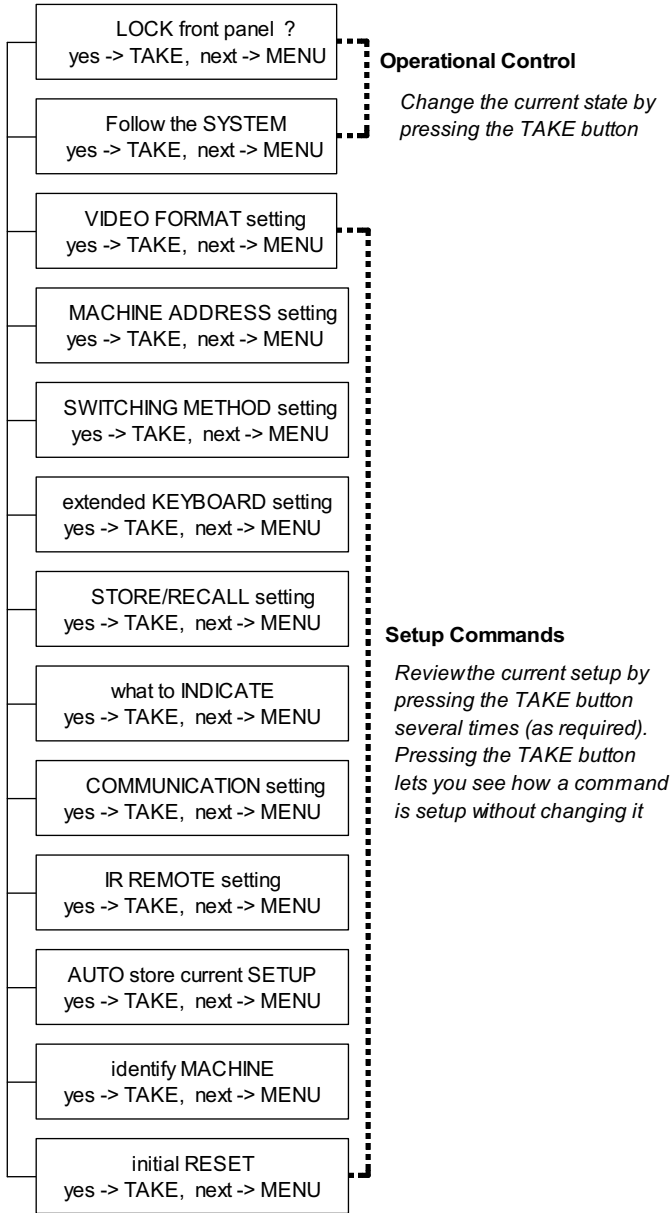

Figure 20: Sequence of MENU Commands

You can stop changing a setup at any time by pressing any IN button.

## 8.1 Locking and Unlocking the Front Panel

To prevent changing the settings accidentally or tampering with the unit via the front panel buttons, lock<sup>1</sup> your **VS-1616V**. Unlocking releases the protection mechanism.

To lock the **VS-1616V**:

1. Press the MENU button once.  
The MATRIX Display shows the message:

**LOCK front panel ?**  
yes -> TAKE, next -> MENU

2. Press the *TAKE* button.  
The front panel locks and the Displays momentarily show the messages:

**Front panel LOCKED                      Keyboard LOCKED<sup>3</sup>**  
**to unlock- press MENU<sup>2</sup>**

Pressing a front panel button has no effect<sup>4</sup> but remote RS-232 and RS-485 commands function and show on the MATRIX Display.

To unlock the **VS-1616V**:

**Either:**

1. Press the MENU button.  
The MATRIX Display shows the message:

**to UNLOCK front panel**  
**press TAKE**

The *TAKE* LED blinks.

2. Press the *TAKE* button.  
The front panel unlocks<sup>5</sup> and the MATRIX Display momentarily<sup>2</sup> shows the message:

**Front panel**  
**UNLOCKED**

**Or:**

1 Nevertheless, even though the front panel is locked you can still operate via RS-232 or RS-485 serial (remote controller or PC)

2 After a few seconds, the status of the unit replaces this message

3 This message appears continuously in the STATUS Display, until the front panel is unlocked

4 IR and Keyboard Extension (EXT. KEYS) commands are also blocked

5 Switching the power off and on again also unlocks the front panel

1. Press the *TAKE* button twice.  
The front panel unlocks and the same messages show as in steps 1 and 2 above.

## 8.2 Choosing the Follow-System or Breakaway-From-System Mode

The terms *audio-follow-video*<sup>1</sup> and *audio breakaway*<sup>2</sup> are well known. Sometimes signals other than audio signals need to switch simultaneously and at other times, need to switch independently. For example:

- Non-linear editing systems, that sometimes combine video with analog audio and at other times combine video with digital audio
- Duplication systems, that make Master tapes from programs with different formats: composite analog, component analog and component digital

When the **VS-1616V** functions in the:

- *Follow-SYSTEM* mode, the **VS-1616V** switches with other 16x16 matrix switchers<sup>3</sup>, implementing the same action simultaneously
- *Breakaway-from-SYSTEM* mode, the **VS-1616V**<sup>4</sup> functions independently, implementing an action independently of the others

The **VS-1616V** unit will function<sup>5</sup> in the *Follow-SYSTEM* mode if at least one other **VS-1616V** unit<sup>6</sup> is set to the *Follow-SYSTEM* mode and these units interconnect via an RS-232 and/or RS-485 communication line.

To set the **VS-1616V** unit to function in the *Follow-SYSTEM* mode:

1. Press the MENU button twice.  
The MATRIX Display shows the message:

**Follow the SYSTEM**  
**yes -> TAKE, next -> MENU**

2. Press the *TAKE* button.  
The Displays show the messages:

**set UNIT follow SYSTEM?**  
**Press TAKE to execute**

**current:**  
**breakaway**

---

1 Video and the audio channels switch simultaneously in the same way

2 Audio channels switch independently from the video channels

3 16x16 matrix switchers in the same series, that include, for example, the VS-1616A (16x16 balanced stereo audio matrix switcher) units and/or the VS-1616AD (16x16 digital audio matrix switcher units)

4 Also applies to a VS-1616A unit or a VS-1616AD unit

5 The VS-1616V unit changes its status immediately and goes to the Follow-system mode

6 Or VS-1616A or VS-1616AD unit (as well as other 16x16 matrix switchers in the same series)

3. Press the *TAKE* button again.  
The MATRIX Display momentarily shows this message, followed by the status of the switcher and in the STATUS Display the letter “S” is displayed behind the blinking cursor:

**the UNIT is set in mode  
FOLLOW system**

If the status of the **VS-1616V** unit differs from that of the other unit(s), set the **VS-1616V** unit to the *Follow-SYSTEM* mode. The MATRIX Display blinks the new status of the switcher and the TAKE LED blinks. Pressing the *TAKE* button<sup>1</sup> implements all the changes to the same state as the rest of the system placing the switcher in the *Follow-SYSTEM* mode.

To set the **VS-1616V** unit to function in the *Breakaway-from-SYSTEM* mode:

1. Press the MENU button twice.  
The MATRIX Display shows the message:

**FOLLOW the system  
yes -> TAKE, next -> MENU**

2. Press the *TAKE* button.  
The Displays show the messages:

**BREAKAWAY from system?                      current:  
Press TAKE to execute                      follow SYS**

3. Press the *TAKE* button again.  
The MATRIX Display shows the message:

**the UNIT is set in mode  
BREAKAWAY from system**

### 8.3 Choosing the Video Format Setting

Choose a VIDEO FORMAT setting from a choice of 4 settings: CV, YC, YUV and RGBS.

**WARNING – changing the VIDEO FORMAT resets all the OUTs/INs connections.**

To choose the VIDEO FORMAT setting:

1. Press the MENU button until you reach the VIDEO FORMAT setting command.  
The MATRIX Display shows the message:

---

<sup>1</sup> Pressing a different button cancels the operation and the switcher will remain in its previous state

**VIDEO FORMAT setting**  
**yes -> TAKE, next -> MENU**

2. Press the *TAKE* button.  
 The Displays show the messages:

**Use OUTkey to configure** **current: 1: CV<sup>1</sup>**  
**1: CV 2: YC 3: YUV 4: RGBS**

3. Press the appropriate<sup>2</sup> *OUT* button # 2, 3 or 4<sup>3</sup>.  
 The MATRIX Display shows the message:

**Press TAKE to configure**  
**for x**

Where x is the new VIDEO FORMAT setting, either Y/C, YUV or RGBS

(At this stage, you can still configure a different video format by pressing another *OUT* button). To exit the VIDEO FORMAT setting command, press a non-relevant button, for example, an *IN* button.

4. Press the *TAKE* button again.  
 The Displays show the messages:

**FORMAT changed!** **current: 1: x**  
**All INs/OUTs reset**

Where x is the new VIDEO FORMAT setting, either Y/C, YUV or RGBS

## 8.4 Setting the MACHINE ADDRESS

Press the MENU button until you reach the Setting the MACHINE ADDRESS command. Choose the stand alone or the large matrix setting. You set the MACHINE ADDRESS using the OUTkeys # 1 to 9, and 10 (for 0). The OUTkeys function on a decimal-basis, and not on a positional-basis. For example, to enter the # 15, press # 1 followed by # 5 (not # 15).

You can change the MACHINE ADDRESS from:

- The stand alone setting to a large matrix setting (see section 8.4.1)
- A large matrix setting to the stand alone setting (see section 8.4.2)
- A large matrix setting to a large matrix setting with a different MACHINE ADDRESS (see section 8.4.3)

---

<sup>1</sup> If currently configured for composite (CV)

<sup>2</sup> Depending on the required video format

<sup>3</sup> Pressing OUT button # 1 when the machine is already configured for composite (CV) will show the message: requested the same format NO CHANGES made

Plan your system according to the chart in Figure 8 before setting the MACHINE ADDRESS, because in a matrix configuration you need to enter the highest MACHINE ADDRESS as well as the MACHINE ADDRESS.

### 8.4.1 Changing the MACHINE ADDRESS from stand alone to a large matrix

To set the MACHINE ADDRESS:

1. Press the MENU button until you reach the MACHINE ADDRESS command.

The MATRIX Display shows the message:

**MACHINE ADDRESS**  
**setting yes -> TAKE, next -> MENU**

2. Press the TAKE button.

The Displays show the messages:

<b>OUTkey 1: Stand-Alone UNIT</b>	<b>Current</b>
<b>2: Large Matrix</b>	<b>Alone<sup>1</sup></b>

3. Press the OUT button # 2.

The TAKE LED blinks and the Displays show the messages:

<b>Change to the LARGE MATRIX?</b>	<b>Current</b>
<b>Press TAKE to confirm</b>	<b>16x16<sup>2</sup></b>

4. Press the TAKE button again.

The Displays show the messages:

<b>READY to set MACHINE ADDRESS</b>	<b>Current #</b>
<b>use OUTkey 1-9, 0</b>	<b>1</b>

5. Enter the MACHINE ADDRESS by pressing an OUT button # 1-9, 0.

The STATUS Display shows the message:

**current:**  
**x**

Where x is the OUT button # pressed

6. Press the TAKE button again.

The Displays show the messages:

<b>READY to change MACH. ADDR.</b>	<b>From # 01</b>
<b>Press TAKE to confirm</b>	<b>to # x</b>

---

<sup>1</sup> Indicating that the machine is not set to the large matrix setting

<sup>2</sup> For example, if currently configured for stand alone



**OUTkey 1: Stand-Alone UNIT**                      **Current**  
**2: Large Matrix**    **Matrix<sup>1</sup>**

3. Press the *OUT* button # 1.  
 The Displays show the messages:

**STAND ALONE UNIT (Mach# 01)?**                      **Current**  
**Press TAKE to confirm**                                      **Matrix**

4. Press the *TAKE* button again.  
 The MATRIX Display shows the message:

**MACHINE ADDRESS changed**  
**now STAND-ALONE**

### 8.4.3 Changing the MACHINE ADDRESS from a large matrix setting to a large matrix setting with a different MACHINE ADDRESS

To set the MACHINE ADDRESS:

1. Press the MENU button until you reach the MACHINE ADDRESS command.  
 The MATRIX Display shows the message:

**MACHINE ADDRESS setting**  
**yes -> TAKE, next -> MENU**

2. Press the *TAKE* button.  
 The Displays show the messages:

**OUTkey 1: Stand-Alone UNIT**                      **Current**  
**2: Large Matrix**    **Matrix**

3. Press the *OUT* button # 2.  
 The Displays show the messages:

**set NEW matrix**    **current:**  
**new -> TAKE leave old -> MENU**                                      **16x32**

4. Press the *TAKE* button again.  
 The Displays show the messages:

**READY to set MACHINE ADDRESS**                      **current #**  
**use OUTkey 1-9, 0**    **1**

5. Press an *OUT* button # 1-9, 0.  
 The STATUS Display shows the message:

---

<sup>1</sup> Indicating that the machine is not set to stand alone





## 8.5 Choosing the SWITCHING METHOD Setting

Section 8.5.1 describes the SWITCHING METHOD settings for stand alone units and large matrices. Section 8.5.2 describes how to configure a SWITCHING METHOD.

### 8.5.1 Understanding the SWITCHING METHOD Settings

Setting the **VS-1616V** unit as a Stand-Alone UNIT<sup>1</sup> provides a choice of 3 SWITCHING METHOD settings:

- **NoVIS** - switching occurs immediately after completion of front panel or dry-contact operation or immediately after receiving an RS-232 or RS-485 command, or an IR command. The switching is independent of the vertical reference
- **EXT** (external sync) - switching occurs during the vertical interval of the video reference signal connected to the IN SYNC<sup>2</sup> connector (this signal should be properly terminated via the TERM button<sup>3</sup>)
- **INT# 1** (internal sync) - switching occurs during the vertical interval of the video reference signal connected to IN # 1

Setting the **VS-1616V** unit as a Large Matrix<sup>1</sup> (instead of as a Stand-Alone UNIT) provides a choice of 4 SWITCHING METHOD settings:

- **NoVIS, EXT** or **INT# 1** (as described above)
- **MTX** (SYNC from Matrix) - the vertical interval of the video reference (selected on one unit in the Large Matrix system) is present on the “SYNC” RS-485 terminal block connector<sup>4</sup>. This reference signal applies to all switchers in the multi- switcher system and facilitates switching all **VS-1616V** units simultaneously

To choose the MTX (SYNC from Matrix) setting<sup>5</sup> as the example in Figure 21 illustrates:

- Connect the RS-485 terminal block connectors<sup>6</sup> between each switcher in the multi- switcher system
- Connect and set the video reference signal on one of the video units to EXT (external sync) or INT# 1 (internal sync)
- Set the video reference on the other video units to the MTX (SYNC from

---

1 Via the MACHINE ADDRESS setting (as section 8.4 describes)

2 Item 1 in Figure 2

3 Item 3 in Figure 2

4 Item 5 in Figure 2

5 This sets the matrix sync configuration from another (Master) machine

6 Via a straight connection of all 4 PINS



4. Press the *TAKE* button.  
The Displays show the messages:

**SWITCHING METHOD  
changed**

**current:  
From In #1**

## 8.6 Choosing the extended Keyboard Setting

Section 6.8 describes how to connect a remote unit. Activate or deactivate it by setting the extended Keyboard setting ON or OFF.

To set the extended KEYBOARD mode, do the following:

1. Press the MENU button until reaching the extended Keyboard setting.  
The MATRIX Display shows the message:

**extended KEYBOARD setting  
yes -> TAKE, next -> MENU**

2. Press the *TAKE* button.  
The Displays show the messages:

**Outkey 1: External keys OFF  
2: External keys ON**

**current:  
X-key ON<sup>1</sup>**

3. Press the *OUT* button *1* to deactivate the External keys.  
The TAKE LED blinks and the Displays show the messages:

**Turn OFF external keys?  
Press TAKE to execute**

**current:  
X-key ON**

4. Press the *TAKE* button.  
The Displays show the messages:

**External Keyboard mode  
changed**

**current:  
X-key OFF**

## 8.7 Setting the STORE/RECALL KEYBOARD Mode

Choose one of these STORE/RECALL KEYBOARD modes:

- At ONCE mode in which setups are stored/recalled immediately without the need for user confirmation
- CONFIRM mode in which storing/recalling setups require user confirmation. The CONFIRM mode is the default<sup>2</sup> for storing/recalling setups and is recommended to prevent erroneously storing/recalling of setups

---

<sup>1</sup> Indicating that the external keys are currently activated

<sup>2</sup> The AT ONCE mode is the default for all actions except storing/recalling setups

To set the STORE/RECALL KEYBOARD mode to the AT ONCE mode, instead of the CONFIRM (default) mode, do the following:

1. Press the MENU button until reaching the STORE/RECALL setting.  
The MATRIX Display shows the message:

**STORE/RECALL setting**  
**yes -> TAKE, next -> MENU**

2. Press the TAKE button and choose the appropriate Outkey 1 for the AT ONCE mode (Outkey 2 is for the CONFIRM mode).  
The Displays show the messages:

**STO/RCL mode** **current:**  
**changed** **At once**

## 8.8 Choosing what to INDICATE

Choose what is displayed during regular operation: between scrolling the switcher setup as Figure 22 illustrates, and showing the IN/OUT range<sup>1</sup>.

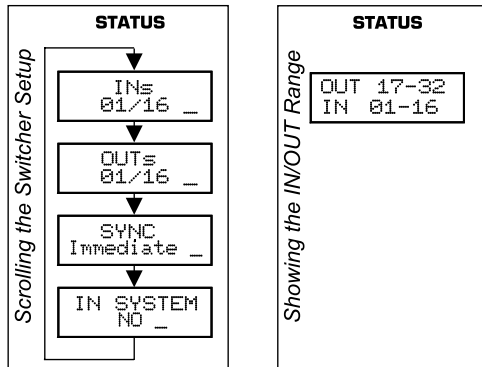

Figure 22: Choosing what to INDICATE

To scroll the switcher setup (instead of showing the IN/OUT range), do the following:

1. Press the MENU button until you reach the what to INDICATE command.  
The MATRIX Display shows the message:

**what to INDICATE**  
**yes -> TAKE, next -> MENU**

<sup>1</sup> Useful in an expanded matrix configuration

2. Press the *TAKE* button.  
The Displays show the messages:
 

<b>Use OUTkey to configure</b>	<b>Current:</b>
<b>1: scroll SETUP 2: OUTs/INs</b>	<b>OUTs/INs</b>
  
3. Press the *OUT* button 1.  
The TAKE LED blinks and the Displays show the messages:
 

<b>Scroll switcher setup?</b>	<b>Current:</b>
<b>Press TAKE to execute</b>	<b>OUTs/INs</b>
  
4. Press the *TAKE* button.  
The Displays show the messages:
 

<b>display mode</b>	<b>Current:</b>
<b>changed</b>	<b>SETUP</b>

## 8.9 Choosing the COMMUNICATION Setting

Choose the response option (reply or no reply).

To choose the No Reply response option, for example, do the following:

1. Press the MENU button until you reach the COMMUNICATION setting.  
The MATRIX Display shows the message:
 

<b>COMMUNICATION setting</b>
<b>yes -&gt; TAKE, next -&gt; MENU</b>
  
2. Press the *TAKE* button.  
The MATRIX Display shows the message:
 

<b>Use OUTkey to configure</b>
<b>1: REPLY 2: No Reply</b>
  
3. Press the *OUT* button 2.  
The TAKE LED blinks and the Displays show the messages:
 

<b>Set serial port No reply</b>	<b>Current:</b>
<b>Press TAKE to execute</b>	<b>Reply</b>
  
4. Press the *TAKE* button again.  
The Displays show the messages:
 

<b>Switcher response</b>	<b>Current:</b>
<b>changed</b>	<b>No reply</b>



## 8.11 Choosing the AUTO STORE Current SETUP

Choose whether or not to save the current setup automatically, that is, whether to save the machine's status on power down, so that it returns to the same status after cycling power.

To save the current setup automatically (when set OFF), do the following:

1. Press the MENU button until you reach the AUTO Store Current SETUP command.

The MATRIX Display shows the message:

**AUTO store current SETUP**  
**yes -> TAKE, next -> MENU**

2. Press the TAKE button.

The Displays show the messages:

<b>OUTkey 1: no AutoSave</b>	<b>current:</b>
<b>2: AutoSave CURRENT setup</b>	<b>NO save</b>

3. Press the OUT button 2.

The TAKE LED blinks and the Displays show the messages:

<b>Auto store CURRENT setup ?</b>	<b>Current:</b>
<b>Press TAKE to execute</b>	<b>NO save</b>

4. Press the TAKE button again.

The Displays show the messages:

<b>AUTOSAVE mode</b>	<b>Current:</b>
<b>changed</b>	<b>AutoSave</b>

## 8.12 Identifying the MACHINE

Display essential information (the product name and version number) to identify your machine, for example, for technical support purposes.

To identify your machine, do the following:

1. Press the MENU button until you reach the Identifying the MACHINE command.

The MATRIX Display shows the message:

**identify MACHINE**  
**yes -> TAKE, next -> MENU**

2. Press the TAKE button.

The MATRIX Display (as Figure 23 illustrates) shows the message:



MATRIX								STATUS								
OUTPUT	1	2	3	4	5	6	7	8								
INPUT	KRAMER ELECTRONICS, Ltd								Software							
INPUT	VS-1616V VIDEO MATRIX								Ver. 1.5 _							
OUTPUT	9	10	11	12	13	14	15	16								

Figure 23: Machine Identification

### 8.13 Choosing the initial RESET

Choose to reset the machine<sup>1</sup> to the:

- Current status<sup>2</sup> (reloads the current setup)
- Factory default (resets to the pre-installed factory default state<sup>3</sup>)

Each VS-1616V unit ships in its factory default

To reset the machine, do the following:

1. Press the MENU button until you reach the initial RESET command.  
The MATRIX Display shows the message:

**initial RESET**  
**yes -> TAKE, next -> MENU**

2. Press the TAKE button.  
The MATRIX Display shows the message:

**Outkey 1: Current status**  
**2: Factory default**

3. Press the OUT button 2, for example, to reset to the factory default.  
The TAKE LED blinks and the Displays show the messages:

**Reset to factory default**                      **WARNING**  
**Press TAKE to execute**                      **!!!!**

4. Press the TAKE button again.  
The Displays show the messages:

**Reset to factory default**                      **WARNING !!!!!**  
**confirm by pressing OUT # 7**

5. Press the OUT # 7.  
The machine resets to the factory default and the Displays show the first messages of the reloading progress (as Figure 23 illustrates).

<sup>1</sup> Without having to switch the power off and on

<sup>2</sup> Sometimes called a “soft reset”

<sup>3</sup> Each VS-1616V unit ships in its factory default state that is a 16x16 composite video matrix, with all setups empty and each input connected to its corresponding output (for example, 1-to-1)

## 9 Flash Memory Upgrade

The main part of the **VS-1616V** firmware is located in FLASH<sup>1</sup> memory, which lets you upgrade to the latest Kramer firmware version in minutes!

Download the up-to-date file from the Internet or obtain it from your dealer. The following example shows how to install a file named (for example) “1616-15.hex” to the FLASH memory<sup>2</sup>.

The current **VS-1616V** software version shows in the *STATUS* display as Figure 19 illustrates in section 7.1.

### 9.1 Connecting the PC to the RS-232 Port

Before installing the latest Kramer firmware version on a **VS-1616V** unit, connect:

- The COM port on your PC to the RS-232 IN port on the **VS-1616V** unit

When simultaneously upgrading the firmware on several VS-1616V units:

- Connect the COM port on your PC to the RS-232 IN port on the first **VS-1616V** unit
- Connect the RS-232 OUT port on the first **VS-1616V** unit to the RS-232 IN port on the second **VS-1616V** unit or another 16x16 unit
- Connect All 16x16 units that you want to upgrade, in this way, linking them in a daisy chain connection
- Set DIP 7 according to whether or not a Null-modem is being used<sup>3</sup>

### 9.2 Upgrading Firmware

1. Install and run the *K-Sender* program on your PC.
2. Open the *K-Sender* program.  
The File COM Port Sender window opens.
3. Choose the appropriate COM port.  
Be sure that “9600 Baudrate” is chosen.  
Click the *File* button.

---

<sup>1</sup> Electrically programmable and erasable

<sup>2</sup> The number “15” in the file name indicates the version number “1.5”. Be sure you receive the latest version, and that it is a “.hex” file

<sup>3</sup> Refer to section 6.5 for full details

4. Locate the file “1616-15.hex” and click the *Open* button.  
The filename appears in the lower part of the window (in bold script).
5. Press and **hold** the *TAKE* button while simultaneously turning on the *POWER* switch on the **VS-1616V**.  
After a few seconds, following the initial machine identification message, the MATRIX Display shows the following message:

**Please,  
release key TAKE**

6. Release the *TAKE* button.  
The TAKE LED blinks and the MATRIX Display shows the following message:

**Update program?  
Please confirm < TAKE >**

7. Press the *TAKE* button.  
The MATRIX Display shows the following message:

**YOU will lose current SETUP<sup>1</sup>  
Confirm < TAKE >**

8. Press the *TAKE* button again.  
The MATRIX Display shows the following message:

**Are you ABSOLUTELY sure?  
Press TAKE to execute**

At this stage, and at any time previously, you can cancel the operation by pressing any button, other than the TAKE button.

9. Press the *TAKE* button once again.  
The program starts working and the TAKE LED turns off.  
The MATRIX Display shows the following message:

**ERASE flash MEMORY  
Please, wait...**

10. After a few seconds the FLASH memory is erased and the MATRIX Display shows the following message:

**Ready for receiving  
Start transmission from PC**

---

<sup>1</sup> Upgrading firmware resets your VS-1616V unit to the factory default. This includes erasing all setups



## 10 Technical Specifications

Table 10 includes the technical specifications:

*Table 10: Technical Specifications of the VS-1616V Video Matrix Switcher*

Inputs:	16 composite video, or 8 s-Video, or 4 RGBS, or 5 YUV, 1 Vpp / 75 Ω on BNC connectors
Outputs:	16 composite video, or 8 s-Video, or 4 RGBS, or 5 YUV, 1 Vpp / 75 Ω on BNC connectors
Video Bandwidth:	230 MHz -3dB
Video Crosstalk:	<-52 dB @ 5MHz
Non Linearity	<0.01%
Video S/N:	70.2 dB
Diff. Gain:	<0.01 %
Diff. Phase:	<0.01 Deg.
K-Factor:	<0.01%
Control:	38 selector switches; RS-232, RS-485, IR remote, dry keyboard extension
Switching:	Vertical interval
Dimensions:	19-inch (W), 7-inch (D) 2U (H) rack-mountable
Power Source:	230 VAC, 50/60 Hz, (115VAC, U.S.A.) 10VA
Weight:	3.5 kg (7.8 lbs.) approx
Accessories:	Power cord, Null modem adapter, Windows 95/98/NT™ Kramer control software

## 11 Communication Protocol

Table 11 includes the Protocol  $2000^1$  hexadecimal codes<sup>2</sup>. The communication parameters are: 9600 baud, with no parity, 8 data bits and 1 stop bit.

<sup>1</sup> Full details are available on our Web site: [www.kramerelectronics.com](http://www.kramerelectronics.com)

<sup>2</sup> This example assumes MACHINE # 1, and node 0



---

## LIMITED WARRANTY

Kramer Electronics (hereafter *Kramer*) warrants this product free from defects in material and workmanship under the following terms.

### HOW LONG IS THE WARRANTY

Labor and parts are warranted for three years from the date of the first customer purchase.

### WHO IS PROTECTED?

Only the first purchase customer may enforce this warranty.

### WHAT IS COVERED AND WHAT IS NOT COVERED

Except as below, this warranty covers all defects in material or workmanship in this product. The following are not covered by the warranty:

1. Any product which is not distributed by Kramer, or which is not purchased from an authorized Kramer dealer. If you are uncertain as to whether a dealer is authorized, please contact Kramer at one of the agents listed in the web site [www.kramerelectronics.com](http://www.kramerelectronics.com).
2. Any product, on which the serial number has been defaced, modified or removed.
3. Damage, deterioration or malfunction resulting from:
  - i) Accident, misuse, abuse, neglect, fire, water, lightning or other acts of nature
  - ii) Product modification, or failure to follow instructions supplied with the product
  - iii) Repair or attempted repair by anyone not authorized by Kramer
  - iv) Any shipment of the product (claims must be presented to the carrier)
  - v) Removal or installation of the product
  - vi) Any other cause, which does not relate to a product defect
  - vii) Cartons, equipment enclosures, cables or accessories used in conjunction with the product

### WHAT WE WILL PAY FOR AND WHAT WE WILL NOT PAY FOR

We will pay labor and material expenses for covered items. We will not pay for the following:

1. Removal or installations charges.
2. Costs of initial technical adjustments (set-up), including adjustment of user controls or programming. These costs are the responsibility of the Kramer dealer from whom the product was purchased.
3. Shipping charges.

### HOW YOU CAN GET WARRANTY SERVICE

1. To obtain service on your product, you must take or ship it prepaid to any authorized Kramer service center.
2. Whenever warranty service is required, the original dated invoice (or a copy) must be presented as proof of warranty coverage, and should be included in any shipment of the product. Please also include in any mailing a contact name, company, address, and a description of the problem(s).
3. For the name of the nearest Kramer authorized service center, consult your authorized dealer.

### LIMITATION OF IMPLIED WARRANTIES

All implied warranties, including warranties of merchantability and fitness for a particular purpose, are limited in duration to the length of this warranty.

### EXCLUSION OF DAMAGES

The liability of Kramer for any effective products is limited to the repair or replacement of the product at our option. Kramer shall not be liable for:

1. Damage to other property caused by defects in this product, damages based upon inconvenience, loss of use of the product, loss of time, commercial loss; or
2. Any other damages, whether incidental, consequential or otherwise. Some countries may not allow limitations on how long an implied warranty lasts and/or do not allow the exclusion or limitation of incidental or consequential damages, so the above limitations and exclusions may not apply to you.

This warranty gives you specific legal rights, and you may also have other rights, which vary from place to place.

**NOTE:** All products returned to Kramer for service must have prior approval. This may be obtained from your dealer.

This equipment has been tested to determine compliance with the requirements of:

- EN-50081: "Electromagnetic compatibility (EMC);  
generic emission standard.  
Part 1: Residential, commercial and light industry"
- EN-50082: "Electromagnetic compatibility (EMC) generic immunity standard.  
Part 1: Residential, commercial and light industry environment".
- CFR-47: FCC Rules and Regulations:  
Part 15: "Radio frequency devices  
Subpart B – Unintentional radiators"

### CAUTION!

- Servicing the machines can only be done by an authorized Kramer technician. Any user who makes changes or modifications to the unit without the expressed approval of the manufacturer will void user authority to operate the equipment.
- Use the supplied DC power supply to feed power to the machine.
- Please use recommended interconnection cables to connect the machine to other components.



**The list of Kramer distributors appears on our web site:**  
**[www.kramerelectronics.com](http://www.kramerelectronics.com)**

**We welcome your questions, comments and feedback.**

---

**Kramer Electronics, Ltd.**

3 Am VeOlamo Street. Jerusalem 95463, Israel Tel: (+972-2)-654-4000

Fax: (+972-2)-653-5369, E-mail: [kramerel@netvision.net.il](mailto:kramerel@netvision.net.il)

**P/N: 2900 – 002051 REV 1**