

Kramer Electronics, Ltd.



USER MANUAL

Model:

VP-719DS, *Seamless Switcher / Scaler*

Contents

1	Introduction	1
2	Getting Started	1
3	Overview	1
4	Your Seamless Switcher / Scaler	3
5	Connecting the Seamless Switcher / Scaler	7
5.1	Connecting a PC	8
6	Understanding the Seamless Switcher / Scaler	10
6.1	Understanding the OUTPUT MODE SELECT Button Functionality	10
6.2	Locking and Unlocking the Front Panel	12
7	Operating the Seamless Switcher / Scaler	13
7.1	Switching and Scaling	13
7.1.1	Switching an Input	13
7.1.2	Choosing the Output Resolution	13
7.2	Controlling the Seamless Switcher / Scaler	14
7.3	Operating via the OSD MENU Screen	14
7.3.1	Controlling the Brightness and Contrast	15
7.3.2	Controlling the Gamma and Color	15
7.3.3	Selecting the Source	16
7.3.4	Controlling the Scale Geometry	17
7.3.5	Adjusting the Zoom Ratio and Position	18
7.3.5.1	Adjusting the Zoom Ratio	20
7.3.5.2	Adjusting the Zoom Position	20
7.3.6	Configuring via the Utility Screens	21
7.3.6.1	Choosing the Graphic Utility Settings	22
7.3.6.2	Choosing the Video Utility Settings	23
7.3.6.3	Choosing the Audio Utility Settings	24
7.3.6.4	Choosing the Seamless Switch Utility Settings	25
7.3.6.5	Choosing the OSD Utility Settings	25
7.3.6.6	Choosing the Output Utility Settings	27
7.3.6.7	Choosing Factory Reset	29
7.3.7	Verifying Configuration Details via the Information Screen	29
7.3.8	Operating via the Infra-red Remote Control Transmitter	29
7.4	Upgrading Firmware	32
8	Technical Specifications	32
9	Communication Protocol	33

Figures

Figure 1: VP-719DS Seamless Switcher / Scaler	4
Figure 2: Connecting the PC	8
Figure 3: Connecting the VP-719DS Rear Panel	9
Figure 4: OUTPUT MODE LED Sequence	11
Figure 5: Locking / Unlocking the Front Panel	12
Figure 6: OSD Input Status	13
Figure 7: OSD Output Status	14
Figure 8: MENU Screen	15
Figure 9: Menu Screen Icons	15
Figure 10: Brightness and Contrast Screen	15
Figure 11: Gamma and Color Screen	16
Figure 12: Gamma, Color Temperature/Manager User 1/2 Screen	16
Figure 13: Source Selection Screen	16
Figure 14: Geometry (Scale and Zoom) Screen	17
Figure 15: Geometry (Scale: Aspect Ratio and Nonlinear) Screen	17
Figure 16: Geometry (Scale: Aspect Ratio) Screen	18
Figure 17: Geometry (Zoom) Screen	18
Figure 18: OSD Enlarge Status	19
Figure 19: Zoom Ratio Adjustment Example	19
Figure 20: Zoom Position Adjustment Example	19
Figure 21: Geometry (Zoom Ratio) Screen	20
Figure 22: Preset Position Control Keys	20
Figure 23: Navigation Control Keys	21
Figure 24: Geometry (Zoom Position Adjustment) Screen	21
Figure 25: Utility Screen	21
Figure 26: Graphic Setting Utility Screen	22
Figure 27: Graphic Setting Color Format Utility Screen	22
Figure 28: Video Setting Utility Screen	23
Figure 29: Video Setting Standard Utility Screen	23
Figure 30: Audio Setting Utility Screen	24
Figure 31: Audio Setting Stereo Utility Screen	24
Figure 32: Seamless Switch Utility Screen	25
Figure 33: OSD Setting Utility Screen	25
Figure 34: OSD Size Utility Screen	26
Figure 35: OSD Source Prompt Activation Utility Screen	26
Figure 36: OSD Blank Color Utility Screen	26
Figure 37: Output Setting Utility Screen	27
Figure 38: Output Setting Resolution Utility Screen	27
Figure 39: Output Setting Refresh Rate Utility Screen	28
Figure 40: Output Setting User Mode Setting Utility Screen	28
Figure 41: Factory Reset Utility Screen	29
Figure 42: Infra-red Remote Control Transmitter	30

Tables

Table 1: Front Panel VP-719DS, Seamless Switcher / Scaler Features	5
Table 2: Rear Panel VP-719DS, Seamless Switcher / Scaler Features	6
Table 3: Selecting the Output Mode Resolution	10
Table 4: User Mode Setting Definitions	28
Table 5: Infra-red Remote Control Transmitter Functions	31
Table 6: Technical Specifications of the VP-719DS	32
Table 7: RS-232 Protocol	33
Table 8: RS-232 Communication Code	33
Table 9: RS-232 Read Command	35

1 Introduction

Dedication by Kramer Electronics since 1981, to the development and manufacture of high quality video/audio equipment, makes the Kramer line an integral part of the finest production and presentation facilities in the world. In recent years, Kramer has redesigned and upgraded most of the line, making the best even better! The Kramer line of professional video/audio electronics is one of the most versatile and complete available, and is a true leader in terms of quality, workmanship, price/performance ratio and innovation. In addition to our high quality Kramer seamless switcher / scaler, we also offer excellent switchers and matrices, as well as distribution amplifiers, remote controllers, processors, interfaces and computer-related products.

Congratulations on purchasing your Kramer **VP-719DS** *Seamless Switcher / Scaler*, which is ideal for the following typical applications:

- Presentation and conference room systems
- Production studios, rental and staging

The **VP-719DS** package includes the following items:

- Seamless Switcher / Scaler
- Power cord, Infra-red remote control transmitter and Null-modem adapter
- This user manual¹ and the Kramer concise product catalog/CD

2 Getting Started

We recommend that you:

- Unpack the equipment carefully and save the original box and packaging materials for possible future shipment
- Review the contents of this user manual
- Use Kramer high performance high resolution cables²

3 Overview

The **VP-719DS** is a *Seamless Switcher / Scaler* designed for a wide variety of presentation and multimedia applications. It is a true multi-standard video to RGBHV (pixel) scaler that converts composite video, s-Video, component

¹ Download up-to-date Kramer user manuals from the Internet at this URL: <http://www.kramerelectronics.com/manuals.html>

² The complete list of Kramer cables is on our Web site at <http://www.kramerelectronics.com> (click "Cables and Connectors" in the Products section)

video, VGA/SVGA/XGA/UXGA, and DVI signals to the following user-selectable pixel rates:

- VGA (640x480)
- SVGA (800x600)
- XGA (1024x768)
- SXGA (1280x1024)
- UXGA (1600x1200)
- 852x1024
- 1024x1024
- 1366x768
- 1365x1024¹
- 1280x720¹
- 720x483¹
- 852x480¹
- 1400x1050¹
- A user definable output mode²

The **VP-719DS** is a 7-input seamless presentation switcher, that:

- Digitally reprocesses the signal to correct mastering errors, and regenerates the video at a chosen line and pixel rate format, providing, for example, native-resolution video for LCD, DLP and Plasma displays
- Facilitates scaling of any graphics resolution to any other resolution³
- Incorporates a unique graphics-scaling engine with image enhancement algorithms, which are built into the firmware
- Is specifically designed to improve video quality by reducing chroma noise
- Scales and zooms (to up to 400% of the original size)

In addition, the **VP-719DS**:

- Switches in true audio-follow-video mode
- Includes an OSD (on-screen display) for making the adjustments that can be located anywhere on the screen, and can be doubled in size. The OSD can be used to deactivate the source prompt, choose the color of the blank screen, and choose from three seamless switching image transition speeds
- Includes seven multi-functional input buttons that cycle between selecting

¹ Not shown on the front panel

² Recommended for advanced users only – non-standard settings may not be recognized by the display device

³ For example, scaling a VGA input to an UXGA output, or an SXGA input to an SVGA output

a source, freezing that source, or deactivating that source (and displaying a blank screen)

- Includes a front panel lock
- Incorporates full ProcAmp¹ processing for video and audio correction
- Offers high quality de-interlacing 3:2/2:2 pull down²
- Can provide non-linear scaling for 4:3, 16:9 transformation³
- Supports firmware upgrade via RS-232
- Includes non-volatile memory that retains the last setting, after switching the power off and then on again

Control the **VP-719DS**:

- From the front panel OSD control buttons
- Remotely, from the infra-red remote control transmitter
- Remotely, via RS-232

Achieving the best performance means:

- Connecting only good quality connection cables, thus avoiding interference, deterioration in signal quality due to poor matching, and elevated noise levels (often associated with low quality cables)
- Avoiding interference from neighboring electrical appliances that may adversely influence signal quality and positioning your Kramer **VP-719DS** away from moisture, excessive sunlight and dust

4 Your Seamless Switcher / Scaler

Figure 1, Table 1 and Table 2 define the front and rear panels of the **VP-719DS**.

¹ Processing amplification enables adjustment of different video and audio signal parameters

² Accommodates the frame-rate of a converted movie (24 frames per second) to video frequencies (25 frames per second (PAL); 30 frames per second (NTSC))

³ See Figure 16

Your Seamless Switcher / Scaler

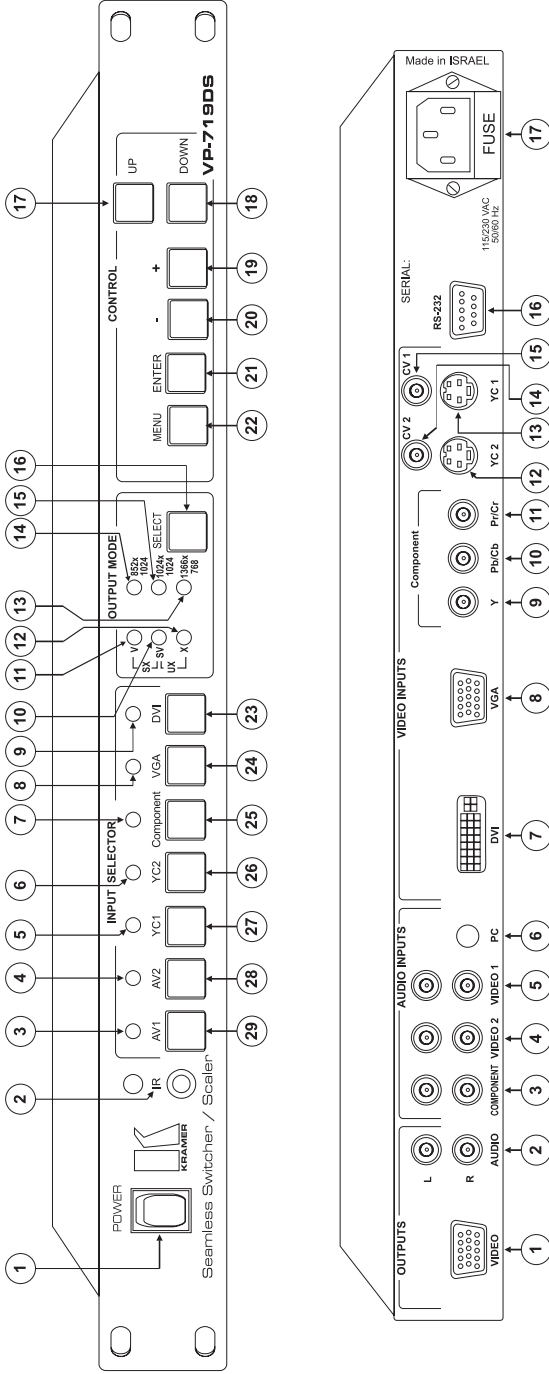

Figure 1: VP-719DS Seamless Switcher / Scaler

Table 1: Front Panel VP-719DS, Seamless Switcher / Scaler Features

#	Feature	Function	
1	POWER Switch	Illuminated switch supplying power to the unit	
2	IR Receiver / LED	Green when the unit will accept IR remote commands	
3	INPUT SELECTOR LEDS	AV1	Illuminates ¹ when the composite video / audio source 1 is selected
4		AV2	Illuminates ¹ when the composite video / audio source 2 is selected
5		YC1	Illuminates ¹ when the s-Video (Y/C) / audio source 1 is selected
6		YC2	Illuminates ¹ when the s-Video (Y/C) / audio source 2 is selected
7		Component	Illuminates ¹ when the component video / audio source is selected
8		VGA	Illuminates ¹ when the VGA / audio source is selected
9	DVI	Illuminates ¹ when the DVI / audio source is selected	
10	OUTPUT MODE LEDS	SV	Illuminates when the SVGA resolution is selected ²
11		V	Illuminates when the VGA resolution is selected ³
12		X	Illuminates when the XGA resolution is selected ⁴
13		1366x768	Illuminates when the 1366x768 resolution is selected ⁵
14		852x1024	Illuminates when the 852x1024 resolution is selected ⁶
15		1024x1024	Illuminates when the 1024x1024 resolution is selected ⁷
16	SELECT Button	Selects the output resolution and illuminates the appropriate LED ⁸	
17	UP Button	Moves up one step (in the same level) in the OSD screen	
18	DOWN Button	Moves down one step (in the same level) in the OSD screen	
19	+ Button	Increases the range by one step in the OSD screen	
20	- Button	Decreases the range by one step in the OSD screen	

1 Flashes when the image is frozen, and flashes more slowly when a blank screen is displayed

2 Illuminates with the V LED when the SXGA resolution is selected, with the X LED when the UXGA resolution is selected, with the 852x1024, 1024x1024 and 1366x768 LEDs when the 852x480 resolution is selected, and with all the other LEDs when UserDefine is selected

3 Illuminates with the SV LED when the SXGA resolution is selected, with the 852x1024, 1024x1024 and 1366x768 LEDs when the 720x483 resolution is selected, and with all the other LEDs when UserDefine is selected

4 Illuminates with the SV LED when the UXGA resolution is selected, with the 852x1024, 1024x1024 and 1366x768 LEDs when the 1400x1050 resolution is selected, and with all the other LEDs when UserDefine is selected

5 Illuminates with the 1024x1024 LED when the 1280x720 (not shown on the front panel) resolution is selected, with the V, 852x1024, and 1024x1024 LEDs when the 720x483 resolution is selected, with the SV, 852x1024, and 1024x1024 LEDs when the 852x480 resolution is selected, with the X, 852x1024, and 1024x1024 LEDs when the 1400x1050 resolution is selected, and with all the other LEDs when UserDefine is selected

6 Illuminates with the 1024x1024 LED when the 1365x1024 (not shown on the front panel) resolution is selected, with the V, 1024x1024, and 1366x768 LEDs when the 720x483 resolution is selected, with the SV, 1024x1024, and 1366x768 LEDs when the 852x480 resolution is selected, with the X, 1024x1024, and 1366x768 LEDs when the 1400x1050 resolution is selected, and with all the other LEDs when UserDefine is selected

7 Illuminates with the 852x1024 LED when 1365x1024 (not shown on the front panel) resolution is selected, with the 1366x768 LED when the 1280x720 (not shown on the front panel) resolution is selected, with the V, 852x1024, and 1366x768 LEDs when the 720x483 resolution is selected, with the SV, 852x1024, and 1366x768 LEDs when the 852x480 resolution is selected, with the X, 852x1024, and 1366x768 LEDs when the 1400x1050 resolution is selected, and with all the other LEDs when UserDefine is selected

8 See section 6.1

Your Seamless Switcher / Scaler

#	Feature	Function	
21	ENTER Button	Moves to the next level in the OSD screen	
22	MENU Button	Displays the OSD Menu screen ¹ and locks/unlocks the front panel ²	
23	INPUT SELECTOR Buttons	DVI	Press ³ to select the DVI / audio source and illuminate the DVI LED
24		VGA	Press ³ to select the VGA / audio source and illuminates the VGA LED
25		Component	Press ³ to select the component video/audio source and illuminate the component LED
26		YC2	Press ³ to select the s-Video (Y/C) / audio source 2 and illuminate the YC2 LED
27		YC1	Press ³ to select the s-Video (Y/C) / audio source 1 and illuminate the YC1 LED
28		AV2	Press ³ to select the composite video / audio source 2 and illuminate the AV2 LED
29		AV1	Press ³ to select the composite video / audio source 1 and illuminate the AV1 LED

Table 2: Rear Panel VP-719DS, Seamless Switcher / Scaler Features

#	Feature	Function		
1	OUTPUTS	VIDEO HD15 Connector	Connects to the video acceptor (for example, Plasma display, projector or monitor) that displays the scaled output (with the OSD superimposed over it)	
2		AUDIO L and R RCA Connectors	Connects to the left and right stereo audio acceptors	
3	AUDIO INPUTS	COMPONENT L and R RCA Connectors	Connects to the left and right stereo audio inputs from the COMPONENT video source	
4		VIDEO 2 L and R RCA Connectors	Connects to the left and right stereo audio inputs from one of the composite or s-Video sources ⁴	
5		VIDEO 1 L and R RCA Connectors	Connects to the left and right stereo audio inputs from one of the composite or s-Video sources ⁵	
6		PC 3.5 mm Socket	Connects to the audio input from either the DVI (digital video interface) graphics source or the VGA analog graphics source	
7	VIDEO INPUTS	DVI Connector	Connects to the DVI (digital video interface) graphics source	
8		VGA HD15 Connector	Connects to the VGA (analog interface) graphics source ⁶	
9		Component RCA Connectors	Y	Connect to the component video source ⁷
10			Pb/Cb	
11			Pr/Cr	
12		YC 2 4p Connector	Connects to the s-Video source 2	
13		YC 1 4p Connector	Connects to the s-Video source 1	
14		CV 2 RCA Connector	Connects to the composite video source 2	
15		CV 1 RCA Connector	Connects to the composite video source 1	
16		RS-232 DB 9 Connector	Connects to PC or Serial Controller	
17	Power Connector with FUSE	AC connector enabling power supply to the unit		

1 Or moves to the previous level in the OSD screen

2 See section 6.2

3 Press again (when the LED illuminates) to freeze the image; the LED flashes. Press once again (when the LED flashes), to display a blank screen; the LED flashes more slowly. Alternatively, to freeze the image, press the FREEZE key on the infra-red remote control transmitter (see Figure 42)

4 Either CV 2 or YC 2

5 Either CV 1 or YC 1

6 Or to a YUV signal; connect the "Y" connector to PIN 1, the "Pb/Cb" connector to PIN 2, and the "Pr/Cr" connector to PIN 3

7 Or to an RGB signal; connect RED to the "Y" connector, GREEN to the "Pb/Cb" connector, and BLUE to the "Pr/Cr" connector

5 Connecting the Seamless Switcher / Scaler

Using the **VP-719DS** you can select any one of the 7 inputs and scale that input to the output at the set¹ resolution.

To connect the **VP-719DS**, connect the following² to the rear panel, as the example in Figure 3 illustrates:

1. Connect one or more of the following video sources:
 - 2 composite video sources, “Composite Video Source 1” and “Composite Video Source 2”, to the RCA connectors CV 1 and CV2, respectively³
 - 2 s-Video sources: “s-Video Source 1” and “s-Video Source 2”, to the 4p connectors, YC 1 and YC 2, respectively
 - A component video source⁴, for example, a Betacam VCR (as illustrated in Figure 3), to the 3 RCA connectors, Y, P_b/C_b, and P_r/C_r⁵
 - A VGA graphics source, for example, a PC with an analog graphics output, to the VGA HD15F connector⁶
 - A DVI graphics source, for example, a PC with a digital graphics output, to the DVI connector
2. Connect the stereo audio sources, as illustrated in Figure 3. In particular:
 - The audio of the “Composite Video Source 1” to the AUDIO INPUT VIDEO 1 pair of RCA connectors⁷
 - The audio of the “s-Video Source 2” to the AUDIO INPUT VIDEO 2 pair of RCA connectors⁸
 - The audio of the Component video source, the Betacam VCR, to the AUDIO INPUT COMPONENT pair of RCA connectors
 - The audio of the DVI Graphics Source to the AUDIO INPUT PC 3.5mm socket⁹. Alternatively, connect the audio from the VGA Graphics Source (not

1 For details of how to set the output resolution, refer to section 6.1

2 Switch OFF the power on each device before connecting it to your Seamless Switcher / Scaler. After connecting your Seamless Switcher / Scaler, switch on its power and then switch on the power on each device

3 Connection to CV 2 is not shown in the example in Figure 3

4 Sometimes called YUV, or Y, B-Y, R-Y, or Y, Pb, Pr

5 Alternatively, you can connect an RGB signal (not shown in Figure 3), as follows: RED to the “Y” connector, GREEN to the “Pb/Cb” connector, and BLUE to the “Pr/Cr” connector

6 Alternatively, you can connect a YUV signal to the HD15 connector (not shown in Figure 3), by connecting the “Y” connector to PIN 1, the “Pb/Cb” connector to PIN 2, and the “Pr/Cr” connector to PIN 3

7 The VIDEO 1 connectors are common to CV 1 and YC 1

8 The VIDEO 2 connectors are common to CV 2 and YC 2

9 The PC connector is common to DVI and VGA

illustrated in Figure 3)

3. Connect the VIDEO OUTPUT HD15F connector to the video acceptor, for example, a projector or a Plasma monitor (as shown in Figure 3), and connect the AUDIO OUTPUT pair of RCA connectors to the audio acceptor, for example, a power amplifier.
4. The power cord (the power connector is not illustrated in Figure 3).
5. A PC (optional), as section 5.1 describes.

5.1 Connecting a PC

You can connect a PC (or other controller) to the **VP-719DS** via the RS-232 port for remote control, and for upgrading the firmware, as section 7.4 describes.

To connect a PC to the **VP-719DS** unit, using the Null-modem adapter provided with the machine (recommended):

- Connect the RS-232 DB9 rear panel port on the **VP-719DS** unit to the Null-modem adapter and connect the Null-modem adapter with a 9 wire flat cable to the RS-232 DB9 port on your PC

To connect a PC to a **VP-719DS** unit, without using a Null-modem adapter:

- Connect the RS-232 DB9 port on your PC to the RS-232 DB9 rear panel port on the **VP-719DS** unit, forming a cross-connection¹, as Figure 2 illustrates

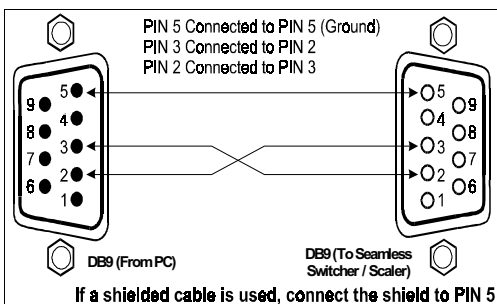

Figure 2: Connecting the PC

¹ Also known as a Null-modem connection

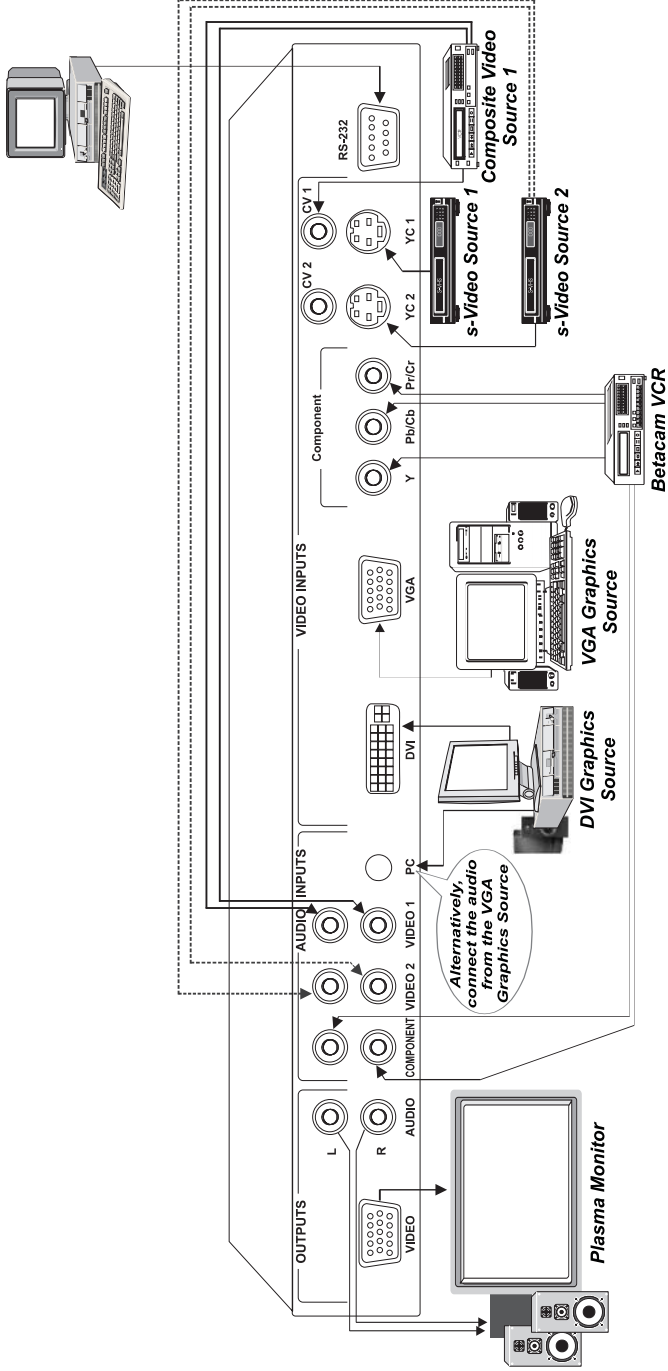

Figure 3: Connecting the VP-719DS Rear Panel

6 Understanding the Seamless Switcher / Scaler

The **VP-719DS** includes the following front panel buttons:

- A set of 7 INPUT SELECTOR buttons (*AV1, AV2, YC1, YC2, Component, VGA, and DVI*)
- An OUTPUT MODE SELECT button (see section 6.1)
- A set of 6 OSD buttons, which are described in Table 1: *MENU, ENTER, -, +, UP, and DOWN*

6.1 Understanding the OUTPUT MODE SELECT Button Functionality

Press the OUTPUT MODE SELECT button¹ to choose the desired output resolution. Table 3 and Figure 4 define how to select the output resolution:

Table 3: Selecting the Output Mode Resolution

To scale to this pixel resolution rate:	Press the SELECT button to illuminate this LED sequence:
VGA (640x480)	V
SVGA (800x600)	SV
XGA (1024x768)	X
SXGA (1280x1024)	V and SV
UXGA (1600x1200)	SV and X
852x1024i	852x1024
1024x1024i	1024x1024
1366x768	1366x768
1365x1024 ²	852x1024 and 1024x1024
1280x720 ²	1024x1024 and 1366x768
720x483 ²	V and 852x1024 and 1024x1024 and 1366x768
852x480 ²	SV and 852x1024 and 1024x1024 and 1366x768
1400x1050 ²	X and 852x1024 and 1024x1024 and 1366x768

To scale to this pixel resolution rate:	Press the SELECT button to illuminate this LED sequence:
UserDefine ²	All LEDs ³

¹ Item 16 in Figure 1

² Not shown on the front panel

³ Recommended for advanced users only – non-standard settings may not be recognized by the display device

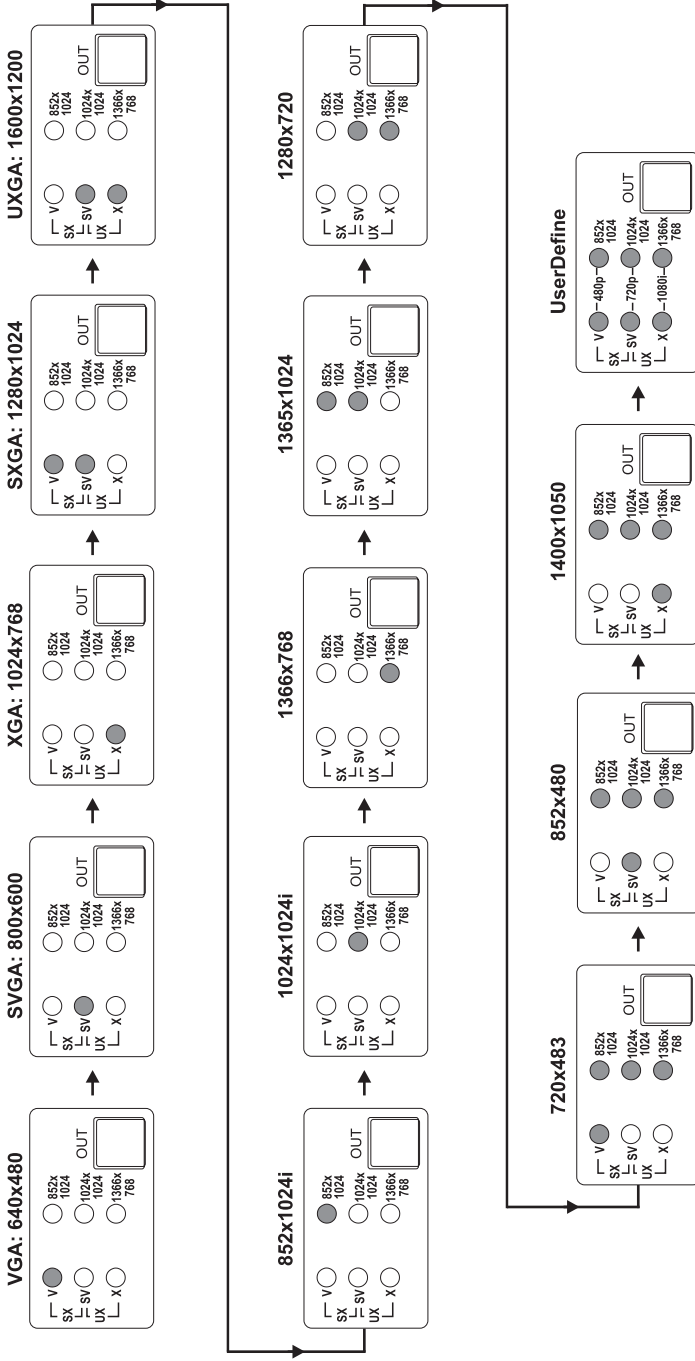

Figure 4: OUTPUT MODE LED Sequence

6.2 Locking and Unlocking the Front Panel

You can lock the front panel¹ and control from the infra-red remote control transmitter to safeguard the settings on the **VP-719DS**.

To lock the front panel:

- Press and hold the *MENU* front panel OSD button² or the MENU key on the infra-red remote control transmitter (see Figure 42) for a few seconds, until the Key Lock On OSD status appears superimposed over the top right corner of the screen for a few seconds³, as Figure 5 illustrates



Figure 5: Locking / Unlocking the Front Panel

To unlock the front panel (releasing the protection mechanism):

- Press and hold the *MENU* front panel OSD button² or the MENU key on the infra-red remote control transmitter (see Figure 42) for a few seconds, until the Key Lock Off OSD status appears superimposed over the top right corner of the screen for a few seconds³

1 However, operation via RS-232 serial commands (remote controller or PC) is still available

2 Item 22 in Figure 1

3 By default, 20 seconds. But you can reset the timeout (from 3 to 60 seconds), see section 7.3.6.5

7 Operating the Seamless Switcher / Scaler

Section 7.1 describes how to switch and scale an input. Section 7.2 describes the methods of controlling the Seamless Switcher / Scaler.

7.1 Switching and Scaling

Section 7.1.1 describes how to switch an input. Section 7.1.2 describes how to select the output resolution.

7.1.1 Switching an Input

You can switch seamlessly¹ between each input² that is connected to a source, by pressing the appropriate INPUT SELECTOR button. The OSD status appears superimposed over the top right corner of the screen for a few seconds³, as Figure 6 illustrates:



Figure 6: OSD Input Status

You can also use the INPUT SELECTOR button to freeze⁴ the image or to display a blank screen⁵.

7.1.2 Choosing the Output Resolution

You can select the output resolution (choosing the pixel resolution, as section 6.1 describes), by pressing the OUTPUT MODE SELECT button⁶ on the front panel or the OUT key on the infra-red remote control transmitter (see

1 For glitchless transitions between inputs

2 To set the image transition speed (fast, safe or moderate), see section 7.3.6.4

3 By default, 20 seconds. But you can reset the timeout (from 3 to 60 seconds), see section 7.3.6.5

4 By pressing the INPUT SELECTOR button again when the appropriate LED illuminates

5 By pressing the INPUT SELECTOR button once again when the appropriate LED flashes

6 Item 16 in Figure 1

Figure 42). The OSD status appears superimposed over the top right corner of the screen for a few seconds¹, as Figure 7 illustrates²:



Figure 7: OSD Output Status

7.2 Controlling the Seamless Switcher / Scaler

You can control the Seamless Switcher / Scaler via:

- The front panel OSD control buttons (see section 7.3)
- The infra-red remote control transmitter (see section 7.3.8)
- RS-232 remote control

7.3 Operating via the OSD MENU Screen

The OSD superimposes a menu on the screen from which you can control your the **VP-719DS**, using the *MENU*, *ENTER*, *-*, *+*, *UP* and *DOWN* front panel OSD buttons.

Pressing the *MENU* front panel OSD button or the *MENU* key on the infra-red remote control transmitter (see Figure 42) displays the first OSD screen, the “Menu screen” (see Figure 8), which displays six interactive icons³ (defined in Figure 9).

After initially pressing the *MENU* front panel OSD button or the *MENU* key on the infra-red remote control transmitter, each subsequent press moves to the previous level in the OSD screen (Esc.).

¹ By default, 20 seconds. But you can reset the timeout (from 3 to 60 seconds), see section 7.3.6.5

² Adjusting the output resolution results in a corresponding adjustment to the size of the OSD status window

³ Each icon represents a Level 1 function. In addition to Level 1, the OSD structure includes Level 2 (a subset of level 1), Level 3 (a subset of level 2), Level 4 (a subset of level 3) and Range

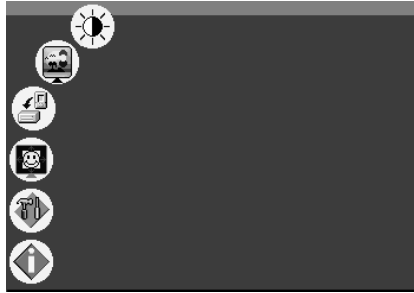

Figure 8: MENU Screen

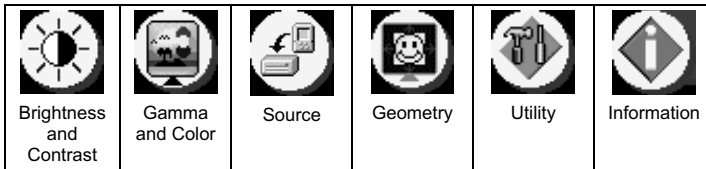

Figure 9: Menu Screen Icons

7.3.1 Controlling the Brightness and Contrast

Figure 10 illustrates the Brightness and Contrast Screen:

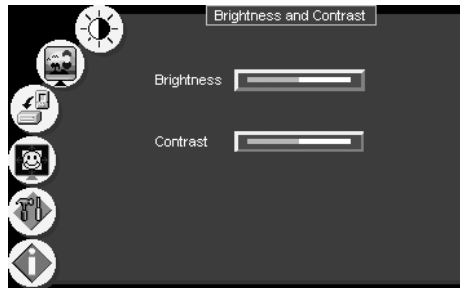

Figure 10: Brightness and Contrast Screen

7.3.2 Controlling the Gamma and Color

Figure 11 illustrates the Gamma and Color Screen. You can choose Normal (average setting), Presentation (higher black level), Cinema (higher white balance), Nature (higher green level), User 1 or User 2.

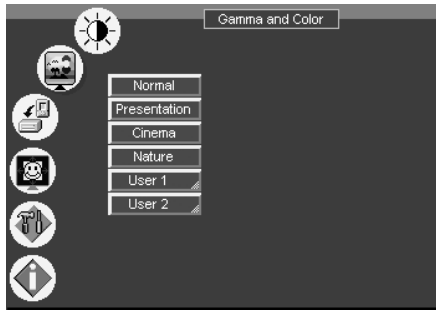

Figure 11: Gamma and Color Screen

Choosing User 1 or User 2 from the Gamma and Color Screen illustrated in Figure 11, displays the Gamma, Color Temperature and Color Manager Screen in Figure 12. Each user setting is customized to the applicable environment. The user sets the parameters and saves them for recall later.

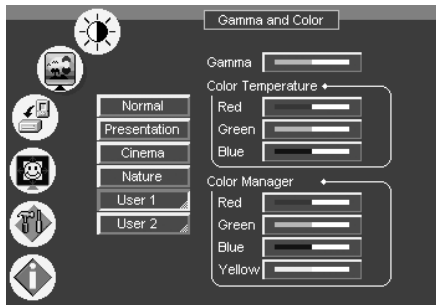

Figure 12: Gamma, Color Temperature/Manager User 1/2 Screen

7.3.3 Selecting the Source

Figure 13 illustrates the Source Screen, displaying the active source, as well as facilitating changing of the source.

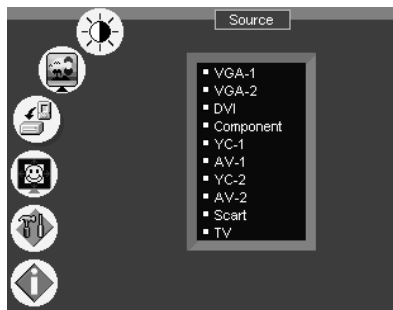

Figure 13: Source Selection Screen

7.3.4 Controlling the Scale Geometry

Figure 14 illustrates the main Geometry Screen, from which you can scale and zoom.

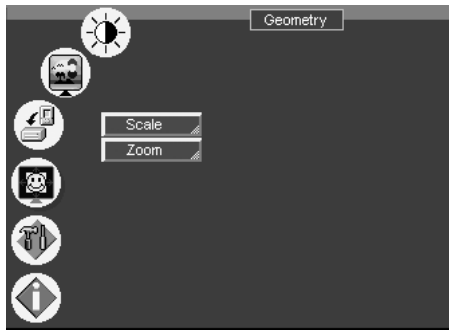

Figure 14: Geometry (Scale and Zoom) Screen

Figure 15 illustrates the Geometry (Scale) Screen, from which you can scale (Aspect Ratio and Nonlinear):

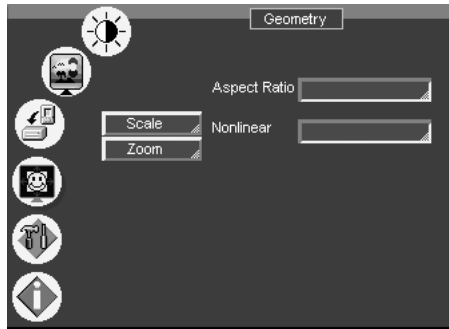

Figure 15: Geometry (Scale: Aspect Ratio and Nonlinear) Screen

Set the aspect ratio according to your specific requirements—the native resolution—that is, depending on the specifications of the Plasma screen or projector.

When using a VGA, DVI and/or component video¹ source, you can choose an aspect ratio from the following: Full Screen, Native, 4:3 Output², and 16:9 Output³.

When using a composite video source and/or an s-Video source and/or component video¹ source, you can choose an aspect ratio from the following: Normal, Wide Screen, Pan⁴ & Scan, 4:3 Output², and 16:9 Output³, as Figure 16 illustrates:

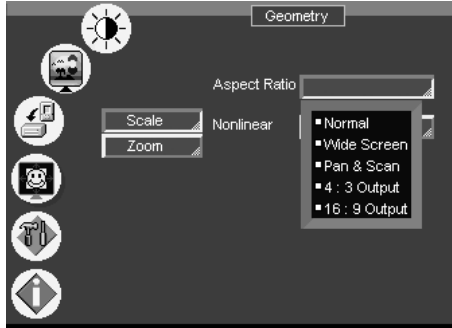

Figure 16: Geometry (Scale: Aspect Ratio) Screen

7.3.5 Adjusting the Zoom Ratio and Position

Figure 17 illustrates the Geometry (Zoom) Screen:

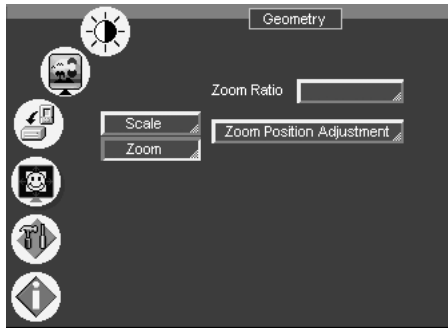

Figure 17: Geometry (Zoom) Screen

1 Depending on the resolution of the component source

2 In this standard, the ratio between the length and height is 4:3

3 In this standard (a Cinema mode standard used for movies and DVDs), the ratio between the length and height is 16:9 (or sometimes 1:2.35)

4 Panning the picture refers to resizing and cropping it

The zoom ratio and the zoom position are illustrated by a small rectangle inside a transparent pop-up OSD Enlarge status box that appears at the top right corner of the screen, as the example in Figure 18 illustrates:



Figure 18: OSD Enlarge Status

When you change the zoom ratio or zoom position, the screen image is adjusted correspondingly, and the change is reflected in the pop-up OSD Enlarge status box. For example, Figure 19 illustrates a zoom ratio increase from 200% (Image A) to 400% (Image B):

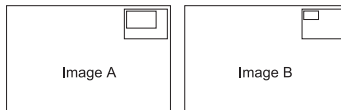

Figure 19: Zoom Ratio Adjustment Example

Figure 20 illustrates how the pop-up OSD Enlarge status box shows a zoom position adjustment from the top left corner (Image C) to the lower right corner (Image D):

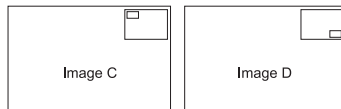

Figure 20: Zoom Position Adjustment Example

7.3.5.1 Adjusting the Zoom Ratio

You can adjust the zoom ratio to up to 400% via one or both of these methods:

- Using the Zoom + and/or the Zoom - control keys¹ on the infra-red remote control transmitter (see Figure 42). The pop-up OSD Enlarge status box continuously displays the zoom ratio and position, as Figure 18 illustrates
- Using the OSD Menu buttons, as Figure 21 illustrates

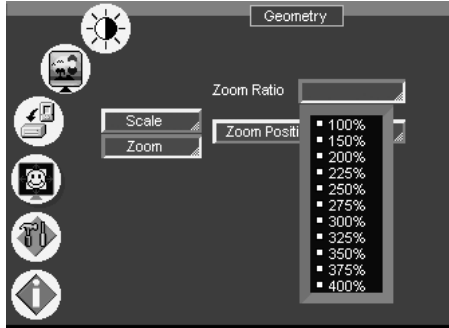

Figure 21: Geometry (Zoom Ratio) Screen

7.3.5.2 Adjusting the Zoom Position

You can adjust the zoom position (see the example in Figure 20) via one or more of the following methods:

- Using the preset position control keys (see Figure 22) on the infra-red remote control transmitter (see Figure 42), which instantly move the position of the zoom to up to nine preset fixed locations²

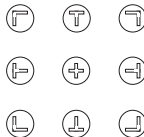





Figure 22: Preset Position Control Keys

- Using the navigation control keys on the infra-red remote control transmitter (see Figure 42), to fine tune the zoom position (that is, to slowly zoom-in at a location on the screen)³, as Figure 23 illustrates

1 The  and the  buttons

2 For example, to zoom-in to the lower right corner of the image, press the  button

3 For example, to zoom-in toward the lower right of the image, press the  and the  buttons separately, as required

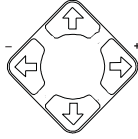

Figure 23: Navigation Control Keys

- Using the OSD Menu buttons (see Figure 24)¹

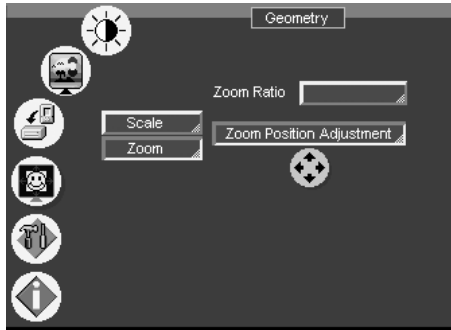

Figure 24: Geometry (Zoom Position Adjustment) Screen

7.3.6 Configuring via the Utility Screens

You can determine how your **VP-719DS** will function either generally or on a specific occasion, via the Utility screen settings (see Figure 25):

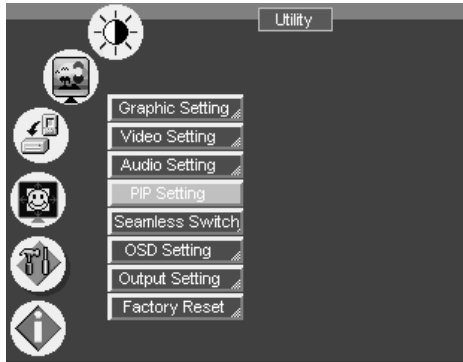

Figure 25: Utility Screen

¹ For example, to zoom-in to the lower right part of the image instead of the top left part, press the + and DOWN OSD Menu buttons (items 19 and 18, respectively, in Figure 1) separately, as required

7.3.6.1 Choosing the Graphic Utility Settings

From the Graphic¹ Setting Utility screen (see Figure 26), you can set the color format (see Figure 27), position, saturation, hue, sharpness, frequency and phase, as well as auto image² and auto gain³.

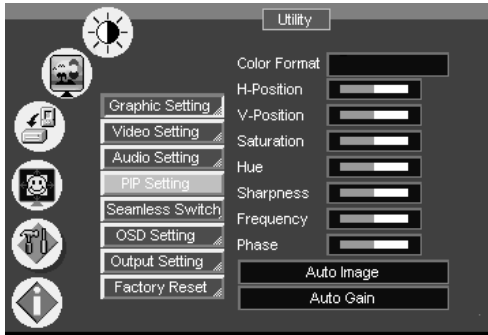

Figure 26: Graphic Setting Utility Screen

Selecting the color format (see Figure 27) lets you select RGB or YUV⁴ colorspace. When the Default setting is chosen, the colorspace is set according to the detected input resolution.

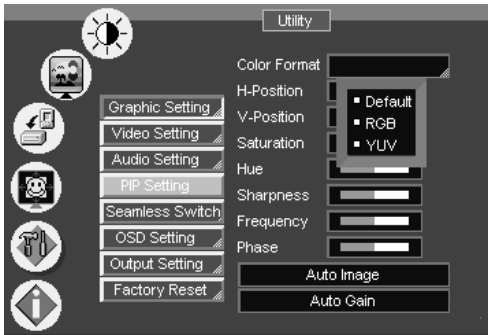

Figure 27: Graphic Setting Color Format Utility Screen

1 When a VGA source is selected, “Graphic Setting” will be shown (or “PC Data Setting” in earlier versions)

2 Assesses the image and improves the quality accordingly, by automatically adjusting the phase, frequency and position

3 Automatically adjusts the brightness and contrast

4 That is Y, B-Y, R-Y colorspace, also known as Y, C_b, C_r or Y, P_b, P_r

7.3.6.2 Choosing the Video Utility Settings

From the Video Setting Utility screen (see Figure 28), you can set the Standard (see Figure 29), color, hue, sharpness, and position.

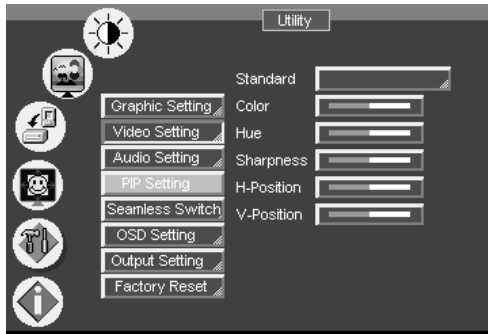

Figure 28: Video Setting Utility Screen

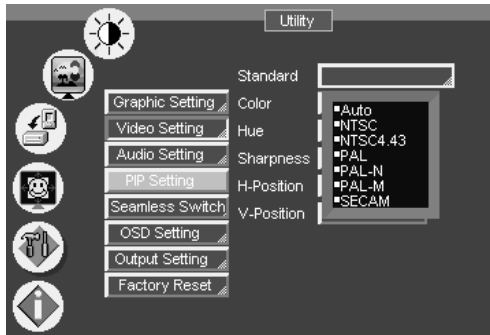

Figure 29: Video Setting Standard Utility Screen

7.3.6.3 Choosing the Audio Utility Settings

From the Audio Setting Utility screen (see Figure 30), you can set the volume, treble, bass, and choose between stereo and mono (see Figure 31).

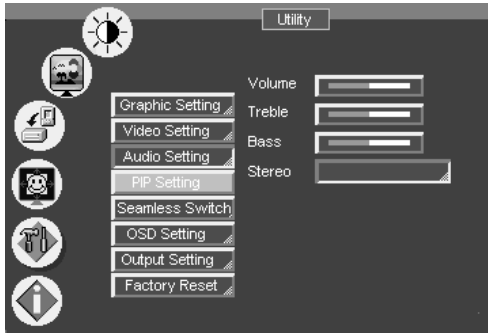

Figure 30: Audio Setting Utility Screen

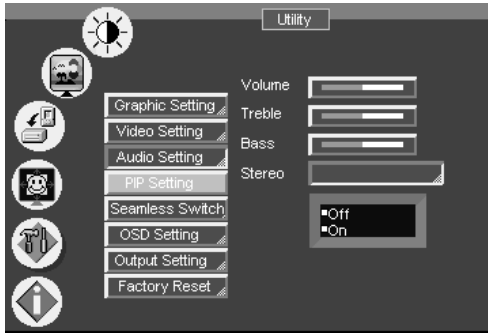

Figure 31: Audio Setting Stereo Utility Screen

7.3.6.4 Choosing the Seamless Switch Utility Settings

From the Seamless Switch Utility screen (see Figure 32), you can choose a fast¹, safe² (takes longer than fast) or moderate (between fast and safe) image transition speed:

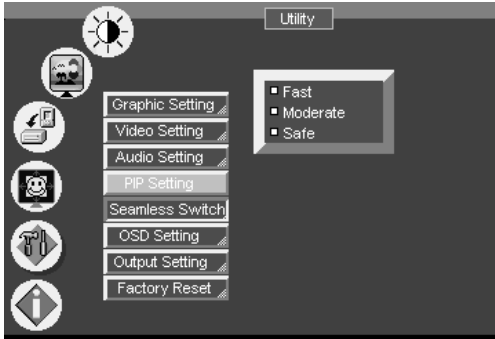

Figure 32: Seamless Switch Utility Screen

7.3.6.5 Choosing the OSD Utility Settings

From the OSD Setting Utility screen (see Figure 33), you can set the OSD position, time out, size (see Figure 34), source prompt³ (see Figure 35), and choose the blank color (blue or black - see Figure 36).

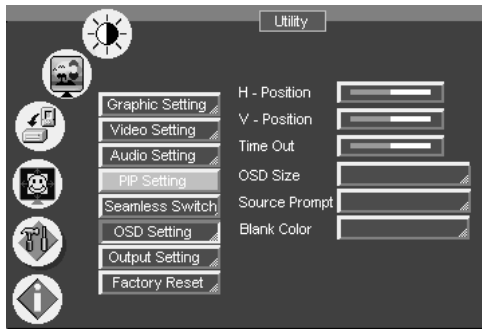

Figure 33: OSD Setting Utility Screen

1 An immediate switch, without checking the resolution. However, the image transition may appear unstable

2 A smooth image transition (the input resolution at the input is checked and outputted after a few seconds delay)

3 We recommend that you set the source prompt ON, when adjusting the system. During a presentation, set the source prompt OFF to avoid the appearance of OSD screen labels

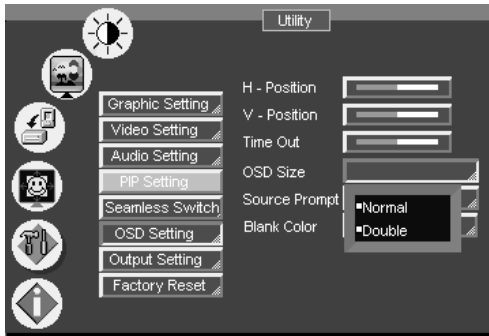

Figure 34: OSD Size Utility Screen

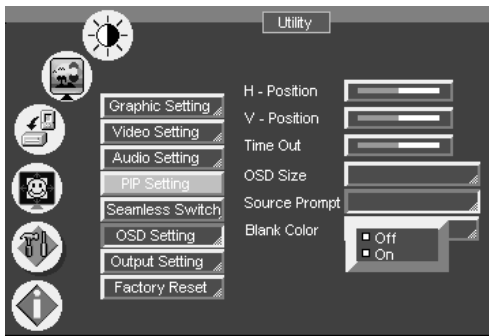

Figure 35: OSD Source Prompt Activation Utility Screen

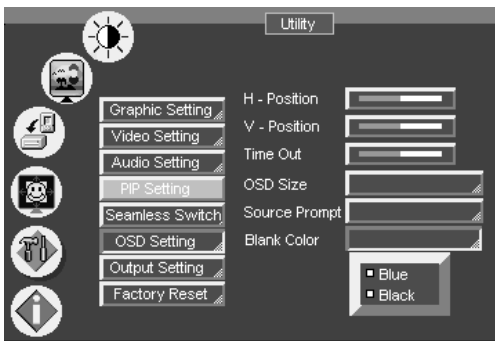

Figure 36: OSD Blank Color Utility Screen

7.3.6.6 Choosing the Output Utility Settings

From the Output Setting Utility screen (see Figure 37), you can set the resolution (see Figure 38), refresh rate (see Figure 39), and a user definable output mode¹ (see Figure 40 and Table 4).

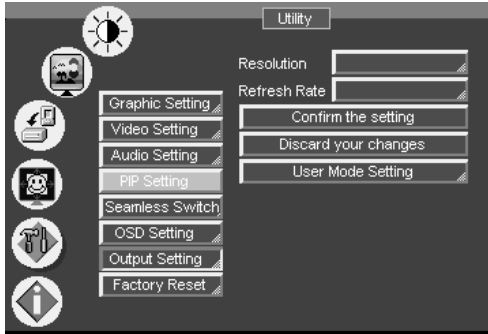

Figure 37: Output Setting Utility Screen

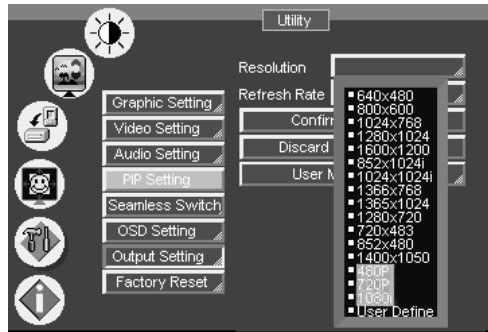

Figure 38: Output Setting Resolution Utility Screen

¹ Recommended for advanced users only – non-standard settings may not be recognized by the display device

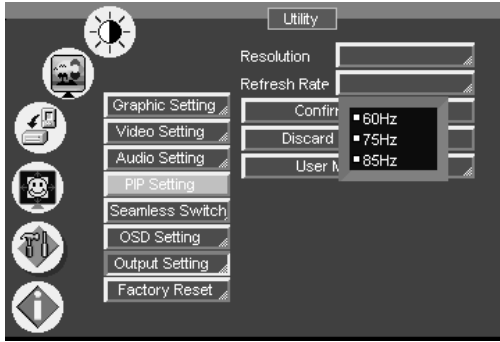

Figure 39: Output Setting Refresh Rate Utility Screen

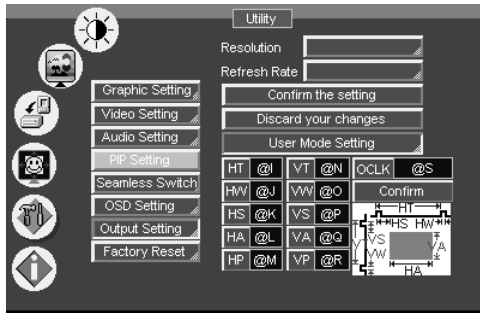

Figure 40: Output Setting User Mode Setting Utility Screen

Table 4: User Mode Setting Definitions

User Mode Setting Definitions	
HT	Horizontal total
HW	Horizontal sync pulse width
HS	Horizontal active start point
HA	Horizontal active region
HP	Horizontal polarity
VT	Vertical total
VW	Vertical sync pulse width
VS	Vertical active start point
VA	Vertical active region
VP	Vertical polarity
OCLK	Output clock

7.3.6.7 Choosing Factory Reset

From the Factory Reset Utility screen (see Figure 41), you can reset your **VP-719DS** to its preset default setting:

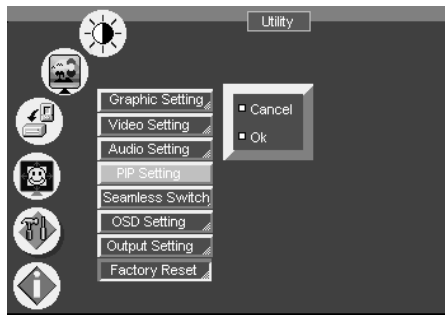

Figure 41: Factory Reset Utility Screen

7.3.7 Verifying Configuration Details via the Information Screen

From the Information screen, you can verify the main source, whether mute is activated, output mode, as well as the firmware version number.

7.3.8 Operating via the Infra-red Remote Control Transmitter

You can control the Seamless Switcher / Scaler remotely, from the Infra-red remote control transmitter, which:

- Is a hand held wireless instrument with a convenient keypad
- Receives its power from 2 AAA size 1.5V DC batteries
- Has a range of up to 15 meters
- Delivers instantaneous results

Figure 42 and Table 5 define¹ the Infra-red Remote Control Transmitter:

¹ The illustration in Figure 42 shows an enlarged view of 3 separate parts of the Infra-red remote control transmitter

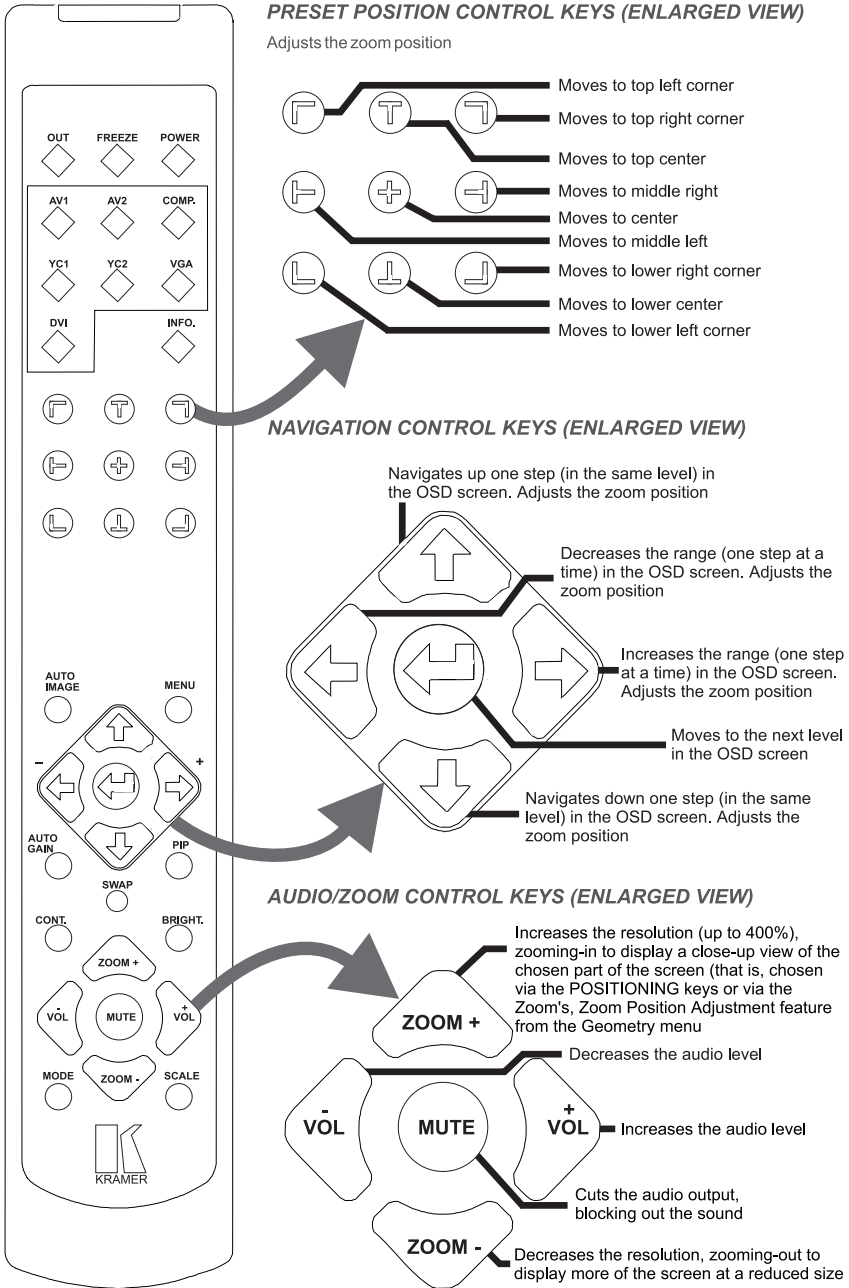

Figure 42: Infra-red Remote Control Transmitter

Table 5: *Infra-red Remote Control Transmitter Functions*

Keys	Function
OUT	Selects the output resolution and illuminates the appropriate LED
FREEZE	Pauses the output video
POWER	Cycles power
INPUT SELECTOR ¹	7 separate keys for selecting each of the following sources: AV1, AV2, COMP. (Component) YC1, YC2, VGA, and DVI
INFO.	Defines the main source, whether mute is activated, output mode, as well as the firmware version number
PRESET POSITION CONTROL ²	Adjusts the zoom ³ position ⁴
AUTO IMAGE	Assesses the image and improves the quality accordingly, by automatically adjusting the phase, frequency and position
MENU	Displays the OSD Menu screen ⁵ and locks/unlocks the front panel ⁶
NAVIGATION CONTROL ⁷	Allow maneuvering within an OSD screen (all keys); adjusts the zoom position (4 keys)
AUTO GAIN	Automatically adjusts the brightness and contrast
SWAP	Not applicable ⁸
PIP	Not applicable ⁹
CONT.	Displays the contrast status ¹⁰
BRIGHT.	Displays the brightness status ¹⁰
AUDIO/ZOOM CONTROL ⁷	Allow volume and zoom control
MODE	Toggles between each of the following modes: Normal, Presentation, Cinema, Nature, User 1 and User 2
SCALE	Toggles between each of the following Aspect Ratios: Normal, Wide Screen, Pan & Scan, 4:3 Output, and 16:9 Output ¹¹

1 Press to select the source; the LED illuminates. Press again to freeze the image; the LED flashes. Press once again to display a blank screen; the LED flashes more slowly

2 Consists of a set of 9 separate keys. See the illustration in Figure 42 which shows an enlarged view of this part of the Infra-red remote control transmitter

3 A small rectangle inside a transparent pop-up OSD Enlarge status box appears at the top right corner of the screen showing the position of the zoom within a picture

4 For example, when enlarging the display, press this button:  to go to the lower right corner of the display area

5 As Figure 8 illustrates

6 See section 6.2

7 Consists of a set of 5 separate keys. See the illustration in Figure 42 which shows an enlarged view of this part of the Infra-red remote control transmitter

8 Not available on the VP-719DS (to toggle between the PIP content and the screen source content). Available on machines such as the VP-720DS

9 Not available on the VP-719DS (to select the picture-in-picture function). Available on machines such as the VP-720DS

10 Adjust using the +/- keys

11 See Figure 16

7.4 Upgrading Firmware

To install the latest Kramer firmware version on a **VP-719DS** unit, connect the COM port on your PC to the RS-232 port on the **VP-719DS** unit, as section 5.1 describes, and go to the Kramer Web site at this URL: <http://www.kramerelectronics.com> for the latest information.

8 Technical Specifications

Table 6 includes the technical specifications:

Table 6: Technical Specifications¹ of the VP-719DS

Inputs:	VIDEO: 2 x composite video 1 Vpp/75 Ω on RCA connectors; 2 x Y/C (s-Video) 1 Vpp (Y), 0.3Vpp (C) / 75 Ω on 4 pin connectors; 1 x Component (Y, Pb/Cb, Pr/Cr) on RCA connectors; 1x VGA (VGA/SVGA/XGA/UXGA) on an HD15F connector; and 1x DVI connector AUDIO: 3 x stereo audio on RCA connectors (for VIDEO 1, VIDEO 2 and COMPONENT) and 1x PC audio on a 3.5mm mini socket
Outputs:	VIDEO: 1 x VGA/SVGA/XGA/UXGA on an HD15F connector AUDIO: 1 x stereo audio on RCA connectors
Output Resolutions:	VGA (640x480), SVGA (800x600), XGA (1024x768), SXGA (1280x1024), UXGA (1600x1200), 1024x852, 1024x1024, 1366x768, 1365x1024, 1280x720, 720x483, 852x480, 1400x1050, as well as a user definable output mode
Control:	Front panel buttons/ OSD, IR remote control, RS-232 on a DB-9 connector
Additional Controls:	Different vertical refresh rates, ProcAmp control, output image scaling and aspect ratio change
Firmware:	Frame freeze, digital zoom 4X, Flesh tone (special color processing), Gamma setting
H Frequency:	15.63~90kHz
V Frequency:	50~100Hz
Computer Resizing:	Auto-resizing to panel pixel number
RGB Video Signal:	RGB, 1.0 Vpp, 75 Ω
RGB Sync Signal:	Separate H/VTTTL, composite sync, analog
Audio Input Voltage:	0~0.5 Vrms
Audio Output Voltage:	0~0.5 Vrms
Plug and Play:	DDC1 / DDC2B
De-interlacing:	Adaptive and pixel based
Film mode detection:	2:2 / 3:2 pull down reverse
Power Source:	100-240 VAC, 50/60 Hz, 30VA automatic power supply
Dimensions:	19 " (W), 9.3" (D) 1U (H)
Accessories:	IR remote control, power cord
Weight:	3 kg (6.6 lbs.) approx.

¹ Specifications are subject to change without notice

9 Communication Protocol¹

The Com port setting details are: Baud Rate: 9600/115200, Parity: none, Data Bits: 8 bits, Stop Bits: 1 bit, Set CTS Mode: Off, and Set XON/XOFF: Off.

Table 7: RS-232 Protocol

Field 1	Field 2	Field 3	Field 4	Field 5
"L"	" "	"Code"	"~Code"	0x0d
"L" ASCII Code, 1 byte	" " ASCII space, 1 byte	"xx" Code Str, 2 byte	"xx" is 1's complement of Code str, 2 byte	0x0d, 1 byte

Example: Menu On Command is "L 12ED" + Enter

Table 8: RS-232 Communication Code

Item	Code	Code(Hex)	~Code(Hex)	Function	Command
1	18	0x12	0xED	Menu	L 12ED
2	19	0x13	0xEC	Volume +	L 13EC
3	20	0x14	0xEB	Volume -	L 14EB
4	21	0x15	0xEA	Source	L 15EA
5	22	0x16	0xE9	VGA1	L 16E9
6	23	0x17	0xE8	VGA2	L 17E8
7	24	0x18	0xE7	DVI	L 18E7
8	25	0x19	0xE6	Component	L 19E6
9	26	0x1A	0xE5	Video 1	L 1AE5
10	27	0x1B	0xE4	Video 2	L 1BE4
11	28	0x1C	0xE3	Freeze	L 1CE3
12	29	0x1D	0xE2	PIP	L 1DE2
13	30	0x1E	0xE1	Auto Image	L 1EE1
14	31	0x1F	0xE0	Auto Gain	L 1FE0
15	32	0x20	0xDF	Zoom +	L 20DF
16	33	0x21	0xDE	Zoom -	L 21DE
17	34	0x22	0xDD	Mute	L 22DD
18	35	0x23	0xDC	Brightness	L 23DC
19	36	0x24	0xDB	Contrast	L 24DB
20	37	0x25	0xDA	Mode	L 25DA
21	38	0x26	0xD9	Normal	L 26D9
23	40	0x27	0xD8	Presentation	L 27D8
22	39	0x28	0xD7	Cinema	L 28D7
24	41	0x29	0xD6	Nature	L 29D6
25	42	0x2A	0xD5	USER 1	L 2AD5
26	43	0x2B	0xD4	USER 2	L 2BD4
27	44	0x2C	0xD3	SWAP	L 2CD3
28	45	0x2D	0xD2	Scale	L 2DD2
29	46	0x2E	0xD1	Normal	L 2ED1
30	47	0x2F	0xD0	WideScreen	L 2FD0
31	48	0x30	0xCF	Pan & Scan	L 30CF
32	49	0x31	0xCE	4:3	L 31CE
33	50	0x32	0xCD	Up	L 32CD
34	51	0x33	0xCC	Down	L 33CC
35	52	0x34	0xCB	Left	L 34CB
36	53	0x35	0xCA	Right	L 35CA
37	54	0x36	0xC9	Enter	L 36C9

¹ This Communication Protocol also applies to the VP-720DS and VP-723DS, as well as to the VP-719DS

Communication Protocol

Item	Code	Code(Hex)	~Code(Hex)	Function	Command
38	55	0x37	0xC8	Status	L 37C8
39	56	0x38	0xC7	Enter+UP	L 38C7
40	57	0x39	0xC6	C-Video 1	L 39C6
41	58	0x3A	0xC5	C-Video2	L 3AC5
42	59	0x3B	0xC4	S-Video 1	L 3BC4
43	60	0x3C	0xC3	S-Video 2	L 3CC3
44	61	0x3D	0xC2	OUT	L 3DC2
45	62	0x3E	0xC1	Blank	L 3EC1
46	70	0x46	0xB9	Factory Reset	L 46B9
47	71	0x47	0xB8	Key Lock	L 47B8
48	176	0xB0	0x4F	PIP On	L B04F
49	177	0xB1	0x4E	PIP Off	L B14E
50	178	0xB2	0x4D	Freeze On	L B24D
51	179	0xB3	0x4C	Freeze Off	L B34C
52	180	0xB4	0x4B	Mute On	L B44B
53	181	0xB5	0x4A	Mute Off	L B54A
54	182	0xB6	0x49	Blank On	L B649
55	183	0xB7	0x48	Blank Off	L B748
56	184	0xB8	0x47	Key Lock On	L B847
57	185	0xB9	0x46	Key Lock Off	L B946
58	186	0xBA	0x45	Output Resolution	L BA45 **
59	227	0xE3	0x1C	PIP Size	L E31C **
				** is Resolution index	
				** is PIP size index	

Table 9: RS-232 Read Command

Command Sent		Return	
Source	K 15EA	VGA1	K 16E9
		VGA2	K 17E8
		DVI	K 18E7
		Component	K 19E6
		C-Video 1	K 39C6
		C-Video 2	K 3AC5
		S-Video 1	K 3BC4
		S-Video 2	K 3CC3
Freeze	K 1CE3	Freeze On	K B24D
		Freeze Off	K B34C
PIP	K 1DE2	PIP On	K B04F
		PIP Off	K B14E
Mute	K 22DD	Mute On	K B44B
		Mute Off	K B54A
Blank	K 3EC1	Blank On	K B649
		Blank Off	K B748
Key Lock	K 47B8	Key Lock On	K B847
		Key Lock Off	K B946
Output Resolution	K BA45	640x480	K 00FF
		800x600	K 01FE
		1024x768	K 02FD
		1280x1024	K 03FC
		1600x1200	K 04FB
		852x1024i	K 05FA
		1024x1024i	K 06F9
		1366x768	K 07F8
		1366x1024	K 08F7
		1280x720	K 09F6
		720x483	K 0AF5
		480P	K 0BF4
		720P	K 0CF3
		1080i	K 0DF2
VGA/DVI Resolution	K E01F	640x480	K 00FF
		NTSC 60	K 01FE
		PAL 50	K 02FD
		720x400	K 03FC
		800x600	K 04FB
		832x624	K 05FA
		1024x768	K 06F9
		1024x800	K 07F8
		1152x870	K 08F7
		1280x960	K 09F6
		1280x1024	K 0AF5
		1600x1200	K 0BF4
		1280x720P	K 0CF3
		853x480P	K 0DF2
		1920x1080i	K 0EF1
		720x576P	K 0FF0
		1152x900	K 10EF
		1400x1050	K 11EE
		No Signal	K FF00
VGA/DVI Refresh rate	K E11E	Refresh rate(Hex)	K ###&&
		No Signal	K FF00
Video Standard	K E21D	NTSC	K 01FE
		NTSC 4.43	K 02FD
		PAL	K 03FC
		PAL N	K 04FB
		PAL M	K 05FA
		SECAM	K 06F9
		PAL 60	K 07F8
		NTSC 4.43 50	K 08F7
		No Signal	K FF00
PIP Size	K E31C	1/25	K 00FF
		1/16	K 01FE
		1/9	K 02FD
		1/4	K 03FC
		Split	K 04FB
PIP H position	K E41B	H position(Hex)	K ###&&
PIP V position	K E51A	V position(Hex)	K ###&&

is Value,&& is ## invert

is Value,&& is ## invert

LIMITED WARRANTY

Kramer Electronics (hereafter *Kramer*) warrants this product free from defects in material and workmanship under the following terms.

HOW LONG IS THE WARRANTY

Labor and parts are warranted for three years from the date of the first customer purchase.

WHO IS PROTECTED?

Only the first purchase customer may enforce this warranty.

WHAT IS COVERED AND WHAT IS NOT COVERED

Except as below, this warranty covers all defects in material or workmanship in this product. The following are not covered by the warranty:

1. Any product which is not distributed by Kramer, or which is not purchased from an authorized Kramer dealer. If you are uncertain as to whether a dealer is authorized, please contact Kramer at one of the agents listed in the web site www.kramerelectronics.com.
2. Any product, on which the serial number has been defaced, modified or removed.
3. Damage, deterioration or malfunction resulting from:
 - i) Accident, misuse, abuse, neglect, fire, water, lightning or other acts of nature
 - ii) Product modification, or failure to follow instructions supplied with the product
 - iii) Repair or attempted repair by anyone not authorized by Kramer
 - iv) Any shipment of the product (claims must be presented to the carrier)
 - v) Removal or installation of the product
 - vi) Any other cause, which does not relate to a product defect
 - vii) Cartons, equipment enclosures, cables or accessories used in conjunction with the product

WHAT WE WILL PAY FOR AND WHAT WE WILL NOT PAY FOR

We will pay labor and material expenses for covered items. We will not pay for the following:

1. Removal or installations charges.
2. Costs of initial technical adjustments (set-up), including adjustment of user controls or programming. These costs are the responsibility of the Kramer dealer from whom the product was purchased.
3. Shipping charges.

HOW YOU CAN GET WARRANTY SERVICE

1. To obtain service on you product, you must take or ship it prepaid to any authorized Kramer service center.
2. Whenever warranty service is required, the original dated invoice (or a copy) must be presented as proof of warranty coverage, and should be included in any shipment of the product. Please also include in any mailing a contact name, company, address, and a description of the problem(s).
3. For the name of the nearest Kramer authorized service center, consult your authorized dealer.

LIMITATION OF IMPLIED WARRANTIES

All implied warranties, including warranties of merchantability and fitness for a particular purpose, are limited in duration to the length of this warranty.

EXCLUSION OF DAMAGES

The liability of Kramer for any effective products is limited to the repair or replacement of the product at our option. Kramer shall not be liable for:

1. Damage to other property caused by defects in this product, damages based upon inconvenience, loss of use of the product, loss of time, commercial loss; or
2. Any other damages, whether incidental, consequential or otherwise. Some countries may not allow limitations on how long an implied warranty lasts and/or do not allow the exclusion or limitation of incidental or consequential damages, so the above limitations and exclusions may not apply to you.

This warranty gives you specific legal rights, and you may also have other rights, which vary from place to place.

NOTE: All products returned to Kramer for service must have prior approval. This may be obtained from your dealer.

This equipment has been tested to determine compliance with the requirements of:

- EN-50081: "Electromagnetic compatibility (EMC);
generic emission standard.
Part 1: Residential, commercial and light industry"
- EN-50082: "Electromagnetic compatibility (EMC) generic immunity standard.
Part 1: Residential, commercial and light industry environment".
- CFR-47: FCC Rules and Regulations:
Part 15: "Radio frequency devices
Subpart B – Unintentional radiators"

CAUTION!

- ☒ Servicing the machines can only be done by an authorized Kramer technician. Any user who makes changes or modifications to the unit without the expressed approval of the manufacturer will void user authority to operate the equipment.
- ☒ Use the supplied DC power supply to feed power to the machine.
- ☒ Please use recommended interconnection cables to connect the machine to other components.



**For the latest information on our products and a list of Kramer distributors, visit our Web site: www.kramerelectronics.com.
Updates to this user manual may be found at
<http://www.kramerelectronics.com/manuals.html>.
We welcome your questions, comments and feedback.**

Kramer Electronics, Ltd.

3 Am VeOlamo Street. Jerusalem 95463, Israel Tel: (+972-2)-654-4000

Fax: (+972-2)-653-5369, E-mail: info@kramerel.com

P/N: 2900 – 007014 REV 2