

FlexCam iCam®



Installation & Operation Manual

ClearOne
You're Virtually ThereSM

Table of Contents

Introduction	1
Services and support	1
Product returns	1
Important safeguards	2
Handling the camera	2
Operating and storage conditions	2
Unpacking	3
Product overview	4
FlexCam iCam application examples	5
Making Connections	6
To connect to a TV, VCR or projector	6
To connect to a computer	6
Using the Camera	7
To view images on a TV	7
To record images on a VCR	7
To view images on a LCD projector	7
To use the microscope couplers	7
Troubleshooting	8
Appendix	9
Specifications	9
Optional accessories	10
To attach the microscope adapter	10
Warranty	11
FCC Part 15/ICES-003 Compliance	12

FlexCam iCam® Installation and Operation Manual
ClearOne Part No. 800-171-103 January 2004 (Rev. 1.0)

© 2004 ClearOne Communications, Inc. All rights reserved. No part of this document may be reproduced in any form or by any means without written permission from ClearOne Communications. Printed in the United States of America. ClearOne Communications reserves specific privileges. Information in this document is subject to change without notice.

Introduction

The FlexCam iCam® is a video-only, entry-level presentation camera suitable for a variety of classroom activities. This innovative camera is perfect for presenting objects, sharing images and displaying student work or pages from a textbook. The camera easily connects to a microscope using the included microscope couplers, allowing class-wide display of microscopic images.

Services and support

If you need additional information on how to install, set up or operate your FlexCam iCam, please contact us. We welcome and encourage your comments so we can continue to improve our products and better meet your needs.

Technical support

Tel: 1-800-283 5936 (USA) or
1-801-974-3760

Fax: 1-801-977-0087

E-mail: tech.support@clearone.com

Web: www.clearone.com

Sales and customer service

Tel: 1-800-945-7730 (USA) or
1-801-975-7200

Fax: 1-800-933-5107 (USA) or
1-801-977-0087

E-mail: sales@clearone.com

Sales and customer service international

Unit 4 Hernes Estate
Greys Road
Henley on Thames
Oxfordshire United Kingdom
RG9 4NT

Tel: 44 (0) 1491 414430

Fax: 44 (0) 1491 579137

E-mail: global@clearone.com

Product returns

All product returns require a return authorization (RA) number. Please contact ClearOne Technical Support before attempting to return your product. Make sure you return all the items that shipped with your product and include a brief description of how the product was being used when the problem occurred.

Important safeguards

Before operating the FlexCam iCam, please read the entire manual thoroughly. The FlexCam iCam was designed, built and tested for use indoors. The use of a power supply other than the one provided or outdoor operation has not been tested and could damage the camera or peripheral equipment and/or create a potentially unsafe operating condition.

- Do not operate the FlexCam iCam if the power cord is damaged or if the camera has been dropped or damaged. A qualified service technician must examine the FlexCam iCam before operating.
- Position the cord so that it will not be tripped over, pulled on or come into contact with hot surfaces.
- Always unplug the FlexCam iCam from the electrical outlet before cleaning or servicing.
- To reduce the risk of electric shock, do not immerse in water or other liquid.

 Use only the power supply provided with the FlexCam iCam. Use of any unauthorized power supply will void any and all warranties.

Handling the camera

- All ClearOne cameras are for indoor use only.
- Do not use cameras next to food or beverages. Cameras have been tested and approved for use in chemistry labs. However, be very careful not to spill liquid or dry chemicals or solvents on the camera.
- Do not use cameras right next to working TVs, radios, motors, transformers or magnetic fields.
- Avoid touching the lens. To clear any dust, blow pressurized air onto the lens. For accidental smears or smudges, wipe carefully with a lens cleaning cloth.
- Clean exterior of camera by wiping with a clean, damp cloth; do not use any abrasive chemicals.
- Use both hands whenever adjusting the neck of the camera; this will avoid any unnecessary strain on the camera's base and will keep the camera from tipping over unexpectedly.
- Do not attempt to take the camera apart. There are no user-serviceable components inside.
- Do not direct the lens of the camera toward the sun. This may damage the camera.

Operating and storage conditions

Do not store or operate the camera under the following conditions:

- Outdoors or connected to outdoor or auxiliary power sources.
- In environments with high humidity.
- In inclement weather.
- Under severe vibration.

Unpacking

Carefully remove the FlexCam iCam unit, cables and power supply from the packaging. Ensure that you received the following parts:

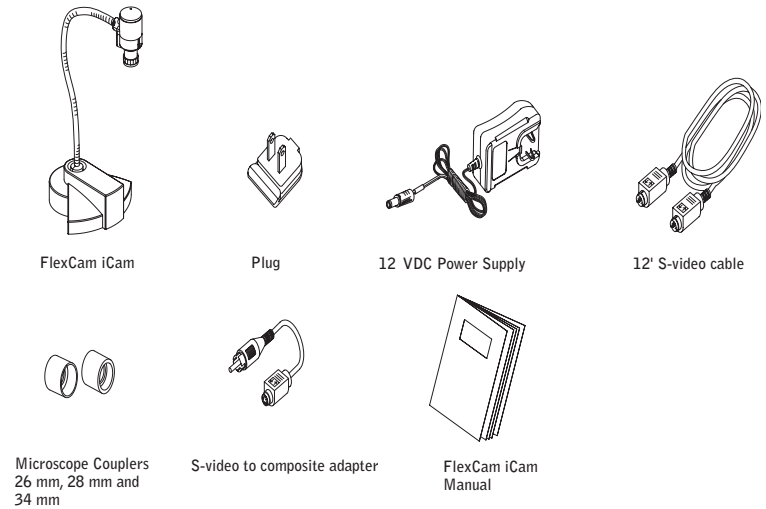



Figure 1. FlexCam iCam and accessories

 ClearOne is not responsible for product damage incurred during shipment. You must make claims directly with the carrier. Inspect your shipment carefully for obvious signs of damage. If the shipment appears damaged, retain the original boxes and packing material for inspection by the carrier. Contact your carrier immediately.

Product overview

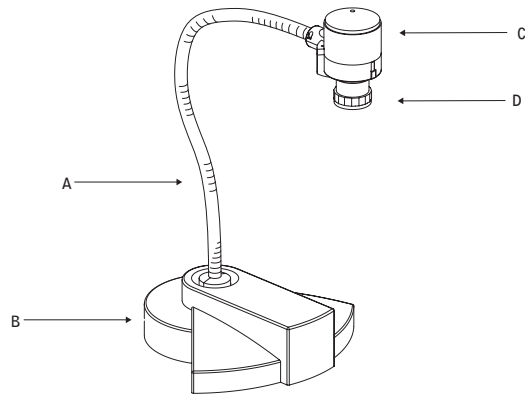

Figure 2. FlexCam iCam overview

- A. **Gooseneck.** The gooseneck allows you to adjust the camera head/camera lens over the object to be viewed. Do not bend the gooseneck more than 90° in any direction or attempt to tie it in a knot. Do not attempt to repair any cracks in the vinyl coating. The gooseneck is nondetachable and should be replaced only by ClearOne.
- B. **Camera base.** The camera base has five rubber feet for non-slip support of the camera.
- C. **Camera head.** The head of the camera unit contains the camera lens, lens holder, focus ring attachments, connections to gooseneck and all cables.
- D. **Camera lens and lens holder.** The camera lens is held in place by the lens holder. Both are permanently attached to the camera head. If you unscrew the lens, take care not to cross thread the lens when putting it back.

FlexCam iCam application examples

The FlexCam iCam easily connects to a variety of display devices allowing many different uses in the classroom. You can display presentations, student work or slides on a TV or projector or use the microscope and optional couplers and eyepiece to share lab work and view microscopic organisms. Using a USB adapter or a video capture card, you can connect the camera to a computer to add video or photos to a web site and enhance presentations.

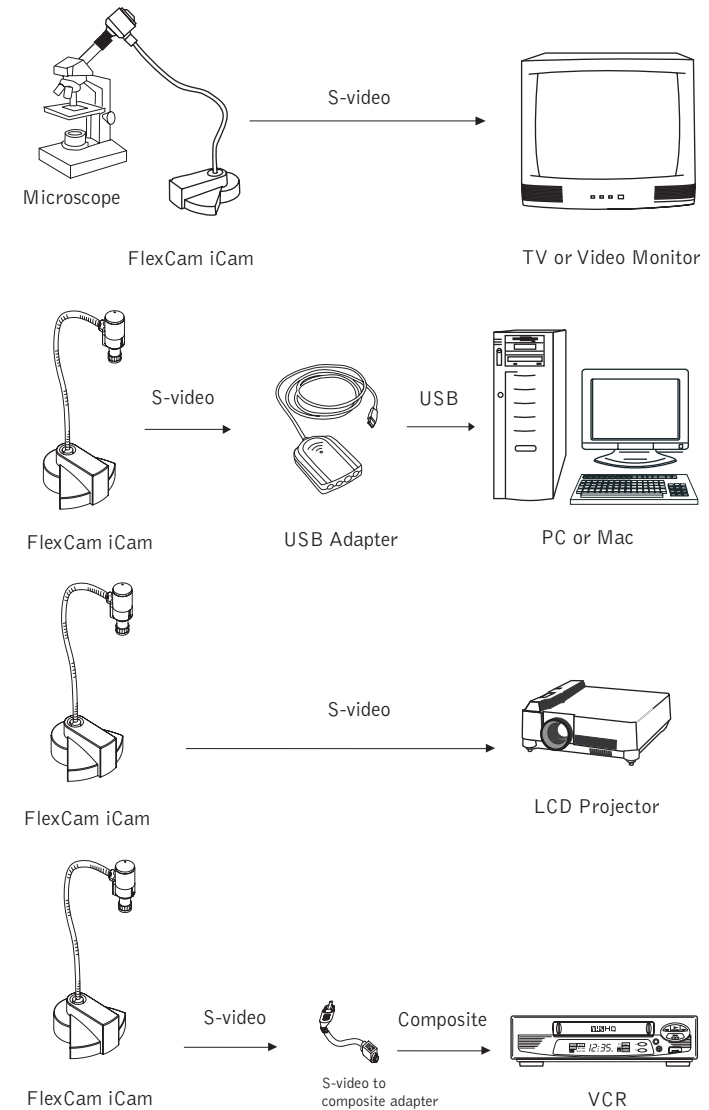

Figure 3. FlexCam iCam Applications

Making Connections

You can connect the FlexCam iCam to a TV, VCR or LCD projector using the included 12' S-video cable. If your video supply device requires a composite signal, use the provided S-video to composite adapter.

You can also connect the FlexCam iCam to a PC or Macintosh using the S-video to USB Adapter (ClearOne part number 911-171-100).

To connect to a TV, VCR or projector

1. Connect the S-Video output of the FlexCam iCam to the input of the display device.
1. If needed, use the S-video to composite video adapter.
2. Connect the power plug to the power jack on the back of the Flex Cam iCam.
3. Plug the power adapter into the wall.

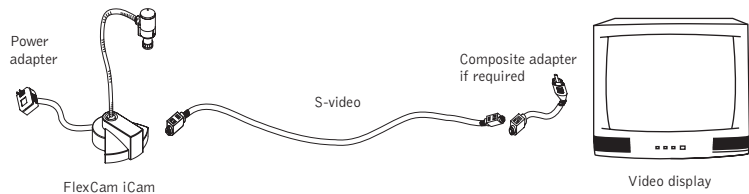

Figure 4. Connections to a display device

To connect to a computer

- If your computer has a video capture card, plug the S-video cable into the card. Refer to the video capture card manual for more information.

or

- If your computer does not have a video capture card, you will need to purchase the USB Adapter. Refer to the USB Adapter manual for more information.

Using the Camera

To view images on a TV

1. Connect the camera to a TV using the S-video cable or composite adapter.
2. Switch the TV to video mode by using the switch on the TV front panel or pressing the corresponding button on the remote control (consult your owner's manual for further instructions).
1. **Note:** Not all TVs have video inputs. If your TV only has an antenna input, you will need a modulator or a VCR with video inputs.
3. Turn camera on using the on/off switch located at the base of the gooseneck.
4. Adjust the flexible gooseneck until the camera is aligned with the subject.
5. Turn the focus ring to the left for close-up or right for distance.

To record images on a VCR

1. Connect the camera to a VCR using the S-video cable or composite adapter.
2. Switch the VCR to the video-in mode (consult your owner's manual for instructions).
3. Turn camera on using the on/off switch located at the base of the gooseneck.
4. Turn the VCR/TV switch to VCR and the TV to either channel 3 or 4.
5. Adjust the flexible gooseneck until the camera is aligned with the subject.
6. Turn the focus ring to the left for close-up or right for distance.
7. Press record on the VCR.

To view images on a LCD projector

1. Connect the camera to a projector using the S-video cable or composite adapter.
2. Turn the projector on (consult your owner's manual for further instructions).
3. Turn camera on using the on/off switch located at the base of the gooseneck.
4. Adjust the flexible gooseneck until the camera is aligned with the subject.
5. Turn the focus ring to the left for close-up or right for distance.

To use the microscope couplers

- Depending on the size of your microscope (28 mm and 34 mm), attach the correct coupler to the microscope by placing it over the microscope's original eyepiece.

Troubleshooting

If you are experiencing problems with your camera:

- Ensure all camera adapter/cable connections and electrical connections are done correctly and completely.
- Check your computer, video capture cards, digitizer boards, VCR, TV, etc., for faulty operation.
- Check all settings on your camera and adjust them for viewing conditions in the presentation room.

If any component of any camera is damaged, contact ClearOne Technical Support for repair information.

Appendix

Specifications

Gooseneck
20"/50.8 cm

Weight
4 lb/1.81 kg

Power Supply
12 VDC

Operating Temperature
32° F – 104° F/0° C – 40° C

Image Sensor
1/3" (8.5 mm) CMOS

No. of Effective Pixels
508(H) x 492(V), 251K pixels NTSC
628(H) x 582(V), 365K pixels PAL

Resolution
330 TV lines (horizontal)

Focus Range
1/4" (6.35 mm) to infinity

Lens
8 mm (.32") D-mount glass lens

Gain Control
Auto

White Balance
Auto

Iris
Auto, electronic with flicker-free performance

Sensitivity
3 lux

S/N Ratio
>4 adB

Video Output
S-video and composite

Video Format
910-171-101 NTSC
910-171-101 PAL

Exterior Color
Translucent blueberry with black accents

Included Accessories
12' (3.65 m) S-video cable
S-video to RCA adapter
SCART adapter (PAL models)
Microscope couplers

Optional Accessories
910-171-320 FlexLite™
910-171-100 USB adapter
910-171-327 Microscope eyepiece adapter

Optional accessories

Contact your ClearOne reseller for more information on the following accessories.

FlexLite™

The FlexLite™ is designed for use with any flexible camera. Dual flexneck top lights attach to the base of your FlexCam to provide adequate lighting for all subjects. Available in 110 V (NTSC) and 220 V (PAL) versions.

USB adapter

Use the USB adapter for Internet videoconferencing, motion video capture, still frame capture and video editing.

Microscope eyepiece adapter

Create a firm connection between your camera and microscope with the microscope eyepiece adapter. Remove the original eyepiece of the microscope and replace with this adapter for a tighter fit between camera and microscope.

To attach the microscope adapter

1. Remove the microscope eyepiece.
2. Replace the original eyepiece with the custom eyepiece adapter by sliding the narrow end into place on the microscope.

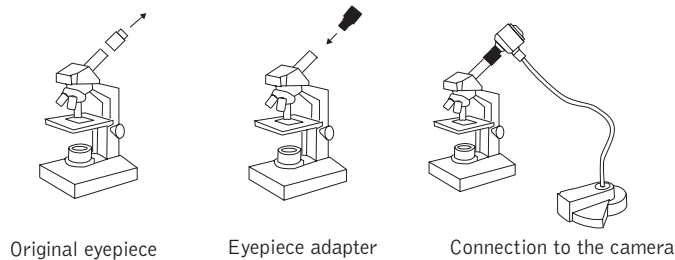

Figure 5. Optional eyepiece attachment

3. Gently push the camera into position.

Warranty

ClearOne Communications, Inc. (Manufacturer) warrants that this product is free of defects in both materials and workmanship. Should any part of this product be defective, the Manufacturer agrees, at its option, to:

Repair or replace any defective part free of charge (except transportation charges) for a period of two years from the date the end user is invoiced for the product, provided the end user returns the product to ClearOne Communications or an authorized ClearOne dealer according to the Product Return and Repair statement set forth below;

This warranty excludes assembled products not manufactured by the Manufacturer whether or not they are incorporated in a Manufacturer product or sold under a Manufacturer part or model number.

Product Return and Repair

1. Return to Seller if Purchased Through an Authorized Dealer
 - a. Proof of purchase date from reseller within warranty period must be provided by the end user.
 - b. Seller may, at its discretion, provide an immediate exchange or repair or may return the unit to the Manufacturer for repair.
2. Return to Manufacturer
 - a. An RMA (return merchandise authorization) number must be issued to the end user from ClearOne technical support.
 - b. The end user must return the product to ClearOne with proof of purchase (showing purchase date) for a warranty claim, and display the RMA number on the outside of the shipping package.

This warranty is void if:

- A. The product has been damaged by negligence, accident, act of God, or mishandling, or has not been operated in accordance with the procedures described in the operating and technical instructions; or,
- B. The product has been altered or repaired by other than the Manufacturer or an authorized service representative of the Manufacturer; or,
- C. Adaptations or accessories other than those manufactured or provided by the Manufacturer have been made or attached to the product which, in the determination of the Manufacturer, shall have affected the performance, safety or reliability of the product; or,
- D. The product's original serial number has been modified or removed.

NO OTHER WARRANTY, EXPRESS OR IMPLIED, INCLUDING WARRANTIES OF MERCHANTABILITY OR FITNESS FOR ANY PARTICULAR USE, APPLIES TO THE PRODUCT. MANUFACTURER'S MAXIMUM LIABILITY HEREUNDER SHALL BE THE AMOUNT PAID BY THE END USER FOR THE PRODUCT. No person or entity authorized to assume any obligation or other liability in connection with the products. No action, regardless of form, arising out of or relating to the product or this warranty, may be brought by end user more than two (2) years after the cause of action has accrued.

Manufacturer shall not be liable for punitive, consequential, or incidental damages, expenses, or loss of revenue or property, inconvenience, or interruption in operation experienced by the end user due to a malfunction in the purchased product. No warranty service performed on any product shall extend the applicable warranty period.

In case of unsatisfactory operation, the end user shall promptly notify the Manufacturer at the address set forth below in writing, giving full particulars as to the defects or unsatisfactory operation. Upon receipt of such notice, the Manufacturer will give instructions respecting the shipment of the product, or such other matters as it elects to honor this warranty as above provided. This warranty does not cover damage to the product during shipping and the Manufacturer assumes no responsibility for such damage. All shipping costs shall be paid by the customer.

This warranty extends only to the original end user and is not assignable or transferable. This warranty is governed by the laws of the State of Utah, without regard to the conflicts of interests provisions thereof.

ClearOne Communications Inc.
1825 Research Way
Salt Lake City, Utah 84119

FCC Part 15/ICES-003 Compliance

This equipment has been tested and found to comply with the limits for a Class A digital device, pursuant to Part 15 of the FCC rules and Industry Canada ICES-003. These limits are designed to provide reasonable protection against harmful interference when the equipment is operated in a commercial environment. This equipment generates, uses, and can radiate radio frequency energy and, if not installed and used in accordance with the instruction manual, may cause harmful interference to radio communications. Operation of this equipment in a residential area is likely to cause harmful interference, in which case the user will be required to correct the interference at his/her own expense.

Operation is subject to the following two conditions: (1) This device may not cause interference, and (2) This device must accept any interference including interference that may cause undesired operation of the device.

Changes or modifications not expressly approved by ClearOne Communications could void the user's authority to operate the equipment.

European Compliance

This equipment has been approved in accordance with Council Directive 1999/5/EC "Radio Equipment and Telecommunications Equipment". Compliance of the equipment with the Directive is attested by the application of the CE mark on the equipment.

EC Declaration of Conformity

Application of Council Directive(s):	1999/5/EC Radio equipment and Telecommunications Terminal Equipment (R&TTE) Directive
Manufacturer's Name:	ClearOne Communications
Manufacturer's Address:	1825 West Research Way Salt Lake City, Utah 84119 U.S.A.
Model No.:	FlexCam iCam 910-171-101-PAL FlexCam iCam Digital 910-171-102-PAL

Standard(s) to which Conformity is declared:

89/336/EEC "Electromagnetic Compatibility (EMC) Directive":

EN 55022: 1994 (Emissions)	Specification for limits and methods of measurement of radio interference characteristics of information technology equipment
EN 61000-3-2:1995/A1/A2:1998	Part 3: Limits - Section 2: Limits for harmonic current emissions.
EN 61000-3-3:1995	Section 3: Limitation of voltage fluctuations and flicker in low voltage supply systems for equipment with rated current up to and including 16 A
EN 55024: 1998 (Immunity)	Information technology equipment -Immunity characteristics - Limits and methods of measurement
EN 61000-4-2: 1995/A1:1998	Electrostatic Discharge
EN 61000-4-3: 1996/A1:1998	Radiated RF Immunity
EN 61000-4-4: 1995	Electrical Fast Transients
EN 61000-4-5: 1995	Lighting Surge
EN 61000-4-6: 1996	Conducted RF Immunity
EN 61000-4-11: 1994	Voltage Dips and Voltage Interruptions
73/23/EEC "Low Voltage Directive (LVD)":	
IEC 60950-1: 2003	Safety of Information Technology Equipment, Including Electrical Business Equipment

We, the undersigned, hereby declare that the equipment specified above conforms to the above Directives and Standards.

Manufacturer



Signature

Roger J. Midgley

Full Name

Project Manager

Position

Legal Representative in Europe



Signature

Martin Offwood

Full Name

Managing Director EMEA North

Position