

Ken-A-Vision has over 50 years of history providing quality products to institutions world wide. We stand behind our workmanship and offer an unbeatable warranty. We offer products for education, lesson plan ideas, technical support and certified microscope repair. If you have questions about how our repair facility could serve your repair needs, please contact **Ken-A-Vision at (816) 353-4787 or e-mail us at info@ken-a-vision.com.**



WARRANTY

To activate the five (5) year limited warranty on your new Video Flex®, simply fill out the warranty at www.ken-a-vision.com/warranty.htm. Returns and repairs may be handled through your local dealer or directly with Ken-A-Vision. The warranty will not apply if your serial number has been removed or if the product has been tampered with, disassembled or damaged by misuse, accident, modification or unauthorized repair. To contact Ken-A-Vision please call 1-816-353-4787, or your local dealer.

To learn more about our company's products and services please visit our web-site: **www.ken-a-vision.com**.

Camera complies with Class A and B, part 15 of the FCC Rules.

Use only Ken-A-Vision Video Flex parts. The Power Supply and Charger are made exclusively for the Video Flex. Failure to use non-Video Flex parts will void your warranty.

INFORMATION TO THE USER Changes or modifications not expressly approved by the party responsible for compliance could void the user's authority to operate the equipment.

NOTE: This equipment has been tested and found to comply with the limits for a Class B digital device, pursuant to part 15 of the FCC rules. These limits are designed to provide reasonable protection against harmful interference in a residential installation. This equipment generates, uses and can radiate radio frequency energy, and if not installed and used in accordance with instructions, may cause harmful interference to radio communication. However, there is no guarantee that interference will not occur in a particular installation. If this equipment does cause harmful interference to radio reception which can be determined by turning the equipment off and on, the user is encouraged to try to correct the interference by one or more of the following measures: Reorient or relocate the receiving antenna and/or increase the separation distance between the equipment and the receiver, and/or connect equipment into an outlet on a circuit different from that which the receiver is connected; and/or consult your dealer or experienced radio/ TV technician for help.



www.ken-a-vision.com



ken-a-vision®
KNOWLEDGE THROUGH VISION

5615 Raytown Road Kansas City, MO 64133
Tel. 816-353-4787 Fax. 816-358-5072

Video Flex®

by  **ken-a-vision®**

7000 Series

Instruction Manual



Knowledge Through Vision

Video Flex® 7000 Series Instruction Manual

**Thank you for your purchase of a
Ken-A-Vision Video Flex!**



When removing, note that there are no parts to assemble—it's ready to use. Your Video Flex comes standard with the following accessories:

- a. Power Supply
- b. 28mm Microscope Eyepiece Adapter (the 34.5mm adapter is built in to the C-mount camera lens)
- c. 12ft. Audio/Video Cable
- d. Instructional Manual

If any components are missing, please contact your Ken-A-Vision® dealer.

Using Your Video Flex is as Easy as 1, 2, 3...

1 CONNECTING THE AUDIO/VIDEO CABLE:

Simply connect one end of the supplied video cable into the "C-VID" and "A-OUT" connector on the base of the Video Flex. Connect the other end of the cable into the "Video In" and "Audio In" connector of the TV/Monitor, VCR, Video Projector or computer.



NOTE: Consult your owner's manual when using any of these components for operating procedures to accept a video or audio signal.

2 CONNECTING THE POWER SUPPLY:

Simply connect the end of the power supply in the "PWR" connector located on the back of your Video Flex. The other end connects to a 110-Volt AC (or 220v electrical outlet). When you push the "On/Off" button located on the top of your Video Flex, the power is indicated by an illuminated RED light.

● Should you need a replacement power supply, contact Ken-A-Vision or your dealer. When using internationally, be sure to use the correct AC input voltage either 110V, 220V, or 240V output voltage. For your Video Flex to operate correctly it should be between 5V-16V with a minimum of 500mA and a plug connection of  .

INPUT: 9VDC, 300 mA

Some Application Ideas On Using Your Video Flex®



Multimedia



Training

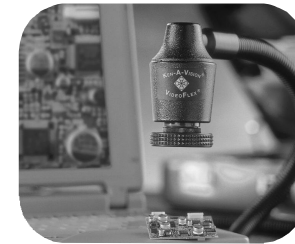

Quality Control

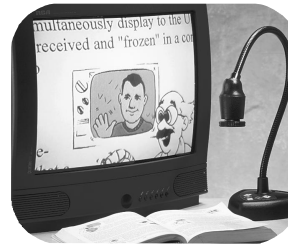

Visually Challenged



Arts & Crafts



Medical



Science

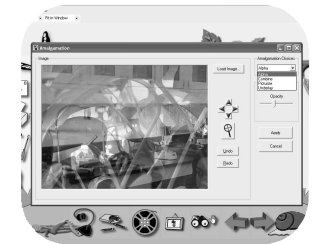

Software

VIDEO FLEX ACCESSORIES:

Expand the capabilities of your Video Flex with accessories. Additional accessories are available on our Web-site at www.ken-a-vision.com.



Manipulate your images with Vision Explorer™ Software VFCD9 (included w/the 7600 model)



Convert your video camera into a digital camera with a USB Adapter complete with software VFUSBAD2

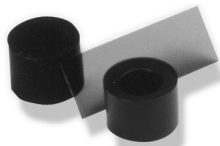

Microscope Polarization Kit VFEAPKO



Discovery Scope Polarization Kit



Battery Pack & Charger for greater mobility VFBAT



C-Mount Interchangeable Lenses 4mm, 16mm, 25mm and 50mm for different viewing angles



Microscope Eyepiece Adapter VFEA

Replacement Parts

VFDS.....Discovery Scope Kit
 VFPSEU.....Discovery Scope Kit 2200
 VFPSUSA.....Power Supply 1100
 VFEA280.....28mm Eyepiece Adapter
 VFC12AV.....12' Audio/Video Cable
 VF8MM.....8mm Lens



Make it wireless with the Wireless Clip Kit VFCLIPKIT

CONNECTING THE OPTIONAL S-VHS CABLE:

(The S-VHS signal hook-up applies to the 7300 and 7600 models)

When using S-VHS connection, connect one end of the S-VHS cable into the "S-VHS" connection on the base of the Video Flex®. Connect the other end of the S-VHS cable into the "S-VHS IN" connection on the TV/Monitor, VCR, Video Projector or computer. S-VHS video will provide sharper definition and truer color than standard Composite Video.

Accessories are available at our web-site www.ken-a-vision.com

3 CONNECTING THE USB CABLE:

(The USB signal hook-up applies to the 7600 USB model or optional adapter)

Prior to connecting the USB cable, you must first install the supplied software. When connecting the USB cable, insert the square end of the cable into the USB port on the Video Flex®. Next, insert the rectangular end of the USB cable into the USB port on your computer. See software instruction manual to capture images.

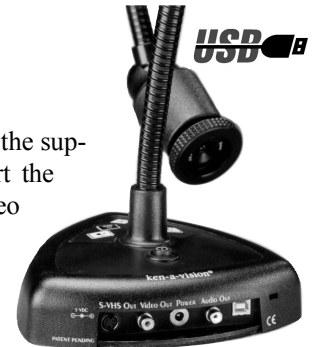

7600 USB VIDEO FLEX:

The USB port will supply ample power to run the Video Flex and can operate simultaneously with your computer and a TV monitor. A CD-Rom of the software has been provided with this model. For more details on loading the software and capturing images, see the software instruction manual included with this model.

USER INFORMATION ABOUT WIRELESS OPERATION:

Changes or modifications not expressly approved by the party responsible for compliance could void the user's authority to operate the equipment.

Video interference is inherent to wireless products - please try the following options to increase picture quality.

1. Re-orient or relocate the receiving antenna.
2. Increase the separation distance between the displaying equipment and receiver.
3. Connect equipment into an outlet on a different circuit from that to which the receiver is connected.
4. Readjust tuning control, located on right side, after each move of the receiver (or antenna) location.
5. Consult the dealer or an experienced radio/TV technician for additional assistance, if necessary.



7700 Network Ready VIDEO FLEX®

See the 7700 instruction manual to connect to the network and on how to use the software.

CONNECTING TO OTHER DEVICES:

TV/MONITOR: Connect video cable from the “C-VID” connector of the Video Flex into the “Video In” connector of the TV/Monitor. If no “Video-in” is available, you may need an RF Modulator or a VCR recorder. *See owner’s manual of TV/Monitor for operating procedures.*

VCR: (Recorder) Connect video cable from the “C-VID” connector of the Video Flex into the “Video-In” connector on the VCR. Connect audio cable from the “A” connector on the Video Flex into the “Audio-In” connector of the VCR. For VCR with stereo sound the audio can be connected into either the right or left “Audio-In”. *See owner’s manual of VCR for operating procedures.*

VIDEO PROJECTOR: Connect the video cable from the “C” connector of the Video Flex into the “Video-In” connector on the video projector. *See owner’s manual of video projector for operating procedures.*

COMPUTERS: To connect the Video Flex to a computer, the computer must have a “USB” port. Video Only units require a USB adapter to connect video to digital. *See the software instruction manual for capturing images. See the 7700 instruction manual to learn how to connect to the network.*

You can use several different devices to project the high-resolution images captured with your Video Flex such as: TV/Monitors, VCRs, CAM-corders, Video Projectors, Smart Presentation Boards, ID Card Printing Systems, Computers (PC & Mac)-anything that has a “VIDEO IN” or “USB”connection.

Video Flex Magnification Chart

<u>Monitor Size</u>	<u>Magnification</u>	<u>Distance from Object</u>	<u>Field of View</u>	<u>Depth of View</u>
13” (33cm)	10x	1-7/8” (48mm)	1-5/16 x 1-5/16” (33mm x 33mm)	1/8” (3mm)
13” (33cm)	20x	7/8” (22mm)	5/8” x 5/8” (16mm x 16mm)	1/16” (2mm)
20” (51cm)	10x	2-7/8 (73mm)	2” x 2” (51mm x 51mm)	5/8” (16mm)
20” (51cm)	20x	1-1/2” (38mm)	1” x 1” (26mm x 26mm)	3/8” (9mm)
20” (51cm)	30x	5/8” (16mm)	1/2” x 1/2” (13mm x 13mm)	1/8” (3mm)
20” (51cm)	40x	1/4” (6mm)	5/16” x 5/16” (6mm x 6mm)	1/16” (2mm)
27” (63cm)	10x	3-3/4” (95mm)	2-3/4” x 2-3/4” (70mm x 70mm)	1-1/16” (27mm)
27” (63cm)	20x	2-3/4” (44mm)	1-5/16” x 1-5/16” (33mm x 33mm)	3/8” (9mm)
27” (63cm)	30x	7/8” (22mm)	5/8” x 5/8” (16mm x 16mm)	1/8” (3mm)
27” (63cm)	40x	3/8” (9mm)	5/16” x 5/16” (8mm x 8mm)	1/16” (2mm)
27” (63cm)	40x	1/4” (6mm)	1/8” x 1/8” (3mm x 3mm)	1/32” (1mm)

As the size of the monitor of video project image is increased, the magnification will increase proportionally.

Video Flex Specification Chart

Base	Triangular Poly-carbonate
Neck Length	25”
Head	Ball & Socket
Lens	8mm C-Mount 1/4 Quick Focus™
Magnification	50:1
Light Sensitivity	1 LUX
Focal Distance	1/4” to infinity
Resolution	500 lines
Eyepiece Adapters	28mm & Built-in 34.5mm
Warranty	5 years

OPTIONAL BATTERY PACK & CHARGER:

The Battery Pack is for powering the Video Flex® for use without a power supply for more mobility. It is a sealed lead acid battery, meaning it does not have a "memory". When you charge the battery, it does not have to be completely drained. It takes approximately four (4) hours to fully charge a drained battery.



You do not have to worry about overcharging the battery. Use only the battery charger supplied. Using any other charging source (even if it will fit the battery connection) could damage the battery and *void* the warranty.

USING THE DISCOVERY SCOPE KIT:

(Included with models 7200, 7300, 7600, and 7700)

The Discovery Scope Kit is a unique device that allows you to view specimens, coins or 35mm slides up close. The Kit includes Clamps, Zoom Bar, Tweezers Clamps, Box Holder, and (2) Bio-Bags.

Step 1- Attach the Discovery Scope Clamp onto the neck of the Video Flex, spaced approximately 1/2" down from the camera head. The force of the clamp itself will hold it in place.

Step 2 - Attach the Telescoping Tube to the other clamp opening as shown to the right.

Step 3 - Select which attachment you would like to use - either the tweezers-clamp for 35mm slides and other gripable items, or the specimen "Bug" box holder. Slide the attachment shaft through the opening located at the opposite end of the telescoping tube.

Step 4 - Adjust the telescoping tube attachment holders to position the object directly in front of the Video Flex camera lens. That's it! You can quickly and easily interchange the attachment holders to suit your needs.



CONTRAST ADJUSTMENT:

(Applies to models 7300, 7600, and 7700)

The amount of light can be adjusted using the manual contrast controls on the base of the Video Flex®. There are two sunburst buttons that allow you to adjust the brightness. Hold the desired button until maximum clarity is achieved.

POSITIVE/NEGATIVE:

(Applies to models 7300, 7600, and 7700)

The positive/negative switch allows the video image to be reversed, like film negatives or a Darkfield control on microscopes. This feature is excellent for multi-media applications and use in forensics. Use the contrast controls to adjust the contrast while in the negative/positive mode.

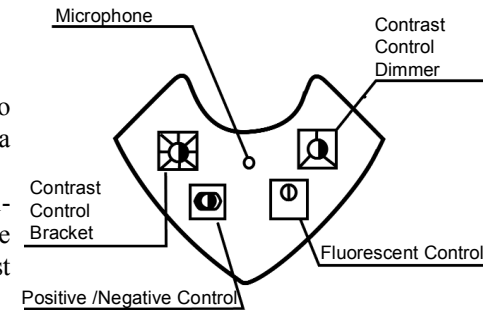

FLUORESCENT CONTROL:

(Applies to the 7300, 7600, and 7700)

This will eliminate the flicker found with certain fluorescent lighting conditions. When using this feature with a microscope, it may be necessary to adjust or filter the light on the microscope, for the correct amount of light. This can be accomplished with the iris on the microscope 5-hole diaphragm or by using frosted filters. Under prolonged fluorescent lighting conditions, color may slowly change. **Please note that touching either contrast control button will disable this capability.**

VIDEO FLEX LENSES:

Your Video Flex comes with a threaded C-mount 8mm lens. Optional lenses include a 4mm (VF4MM) for wide angle applications, and 16mm (VF1614), 25mm (VF25MM) or 50mm (VF50MM) to increase focal distance. You can also use 35mm camera lenses, provided you have the appropriate adapter. An extension tube can be added for extra detail magnification. The C-Mount style camera lens provides a quick and easy method of changing from one lens to another.



CHANGING THE CAMERA LENS:

A standard 8mm lens is assembled on each camera. Optional lenses are available for different viewing angles. To change the lens, simply extend the lens by rotating in a counter-clockwise rotation until fully extended. Apply a small amount of additional force in this same direction to free the lens. Screw on the new lens, apply a small amount of additional force to lock it in place. Rotate the lens back in a counter-clockwise direction to ensure it extends, rather than unscrew. If it unscrews, re-tighten in a clockwise direction, adding an additional amount of force to lock it in place.

FOCUSING DIRECTIONS:

The Video Flex® uses the patented Quick Focus® C-mount lens. The focusing ring, located on the camera head, is similar to that of a 35mm camera. The new ergonomic design makes focusing with one hand a snap. Just a 1/4 turn of the focus ring adjusts focus from close-up to infinity.



When using the standard 8mm lens, the light will automatically be adjusted for optimum viewing conditions, depending on the available light and options in use. When using the optional 16mm manual iris lens (VF16MM), open the iris until you have sufficient light to show the image on the monitor. Then, adjust the focus ring until your image is crisp. Once you have a crisp image, you may want to readjust your manual iris, to achieve the best image possible.

OPTIONAL POLARIZING ADAPTER:

Polarizing accessories are used for geology, petrology, mineralogy, toxicology, chemistry, pharmaceutical, medicine, pulp/paper, atmospheric pollution, ceramics technology, forensic medicine and more.

The Microscope Polarizing adapter kit (VFEAPKO) allows you to turn any microscope into a polarizing microscope. Place the polarizing eyepiece adapter over the microscope eyepiece and connect the Video Flex, slip the polarizing film between the slide and the light source, and rotate the polarizing eyepiece to reveal the polarizing light spectrum.



The Discovery Scope Polarizing Filter (VFDCPF) is used with the Discovery Scope Kit to create a Polarizing Video Microscope. The polarized analyzer is press fitted into the inner ring of the C-mount camera lens, and the polarizing film is positioned in-between the guides on the discovery scope holder and behind the specimen slide. When the analyzer is rotated, the Video Flex will reveal the polarized spectrum, all without the use of a microscope!

USING YOUR MICROSCOPE EYEPIECE ADAPTERS:

The two (2) included Microscope Eyepiece Adapters will allow your Video Flex® to be coupled with microscopes, stereomicroscopes, gescopes, telescopes or other objects with an eyepiece. The 28mm adapter included with your Video Flex will fit most compound microscopes, and the built-in 34.5mm adapter will fit most stereomicroscopes, telescopes and gescopes. Other sizes are available through Ken-A-Vision or your local dealer.



28mm

Before installing a Microscope Eyepiece Adapter, measure the size of the outside diameter of the microscope eyepiece. (You must first remove the eyepiece cup if one is attached to the eyepiece.)

1. Fully extend the lens. Gently rotate the lens counter-clockwise until it is extended out for maximum magnification.

2. Attach the Microscope Eyepiece Adapter. To install the eyepiece adapter, gently slip the adapter over the Microscope eyepiece. If it does not slide on easily, measure to be sure the outside diameter is 16mm or less. Additional sizes are available through Ken-A-Vision.

3. Attach the Video Flex to the Eyepiece Adapter. Next, gently slide the Video Flex camera head onto the eyepiece adapter, aligning the groove around the lens on the Video Flex with the edge of the eyepiece adapter.

4. Power up. After checking to be sure that the Video Flex is situated securely, plug in the power supply and the TV/Monitor or other video device (see “Connecting to other devices” section (pg.3) for more details).

5. Use it. Put a slide on the microscope stage. Focus the image being viewed on the TV/Monitor by first adjusting the microscope, then the Video Flex lens.



LIGHTING:

Never point your Video Flex at direct sunlight. The Video Flex iris is very sensitive and requires minimal light to operate. Subjecting the Video Flex “eye” to direct sunlight will discolor the filter over the CCD chip and create an adverse picture. When using the Video Flex for viewing through a fluorescent microscope, simply set the disc diaphragm on the smallest diameter hole, or close the iris diaphragm.

