

JVC

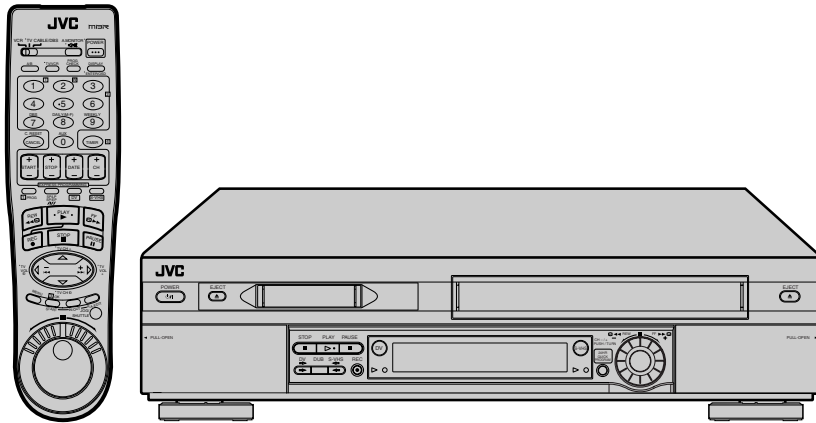

Mini DV/S-VHS VIDEO CASSETTE RECORDER

HR-DVS3U



SVHS
Mini **DV** NTSC
Hi-Fi
VCRplus⁺ [®]
CABLE BOX CONTROL
Super VHS ET

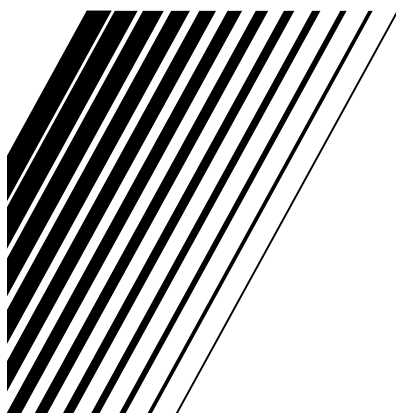

INSTRUCTIONS

For Customer Use:

Enter below the Model No. and Serial No. which are located on the rear of cabinet. Retain this information for future reference.

Model No. _____

Serial No. _____

Dear Customer,

Thank you for purchasing the JVC Mini DV/S-VHS video cassette recorder. Before use, please read the safety information and precautions to ensure safe use of your new VCR.

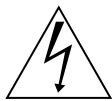
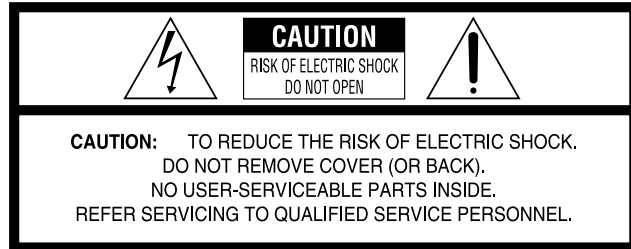
CAUTIONS

The lightning flash with arrowhead symbol, within an equilateral triangle, is intended to alert the user to the presence of uninsulated "dangerous voltage" within the product's enclosure that may be of sufficient magnitude to constitute a risk of electric shock to persons.



The exclamation point within an equilateral triangle is intended to alert the user to the presence of important operating and maintenance (servicing) instructions in the literature accompanying the appliance.

WARNING:

TO PREVENT FIRE OR SHOCK HAZARD, DO NOT EXPOSE THIS UNIT TO RAIN OR MOISTURE.

CAUTION:

This video cassette recorder should be used with AC 120V~, 60Hz only.

To prevent electric shocks and fire hazards, DO NOT use any other power source.

CAUTION:

TO PREVENT ELECTRIC SHOCK, MATCH WIDE BLADE OF PLUG TO WIDE SLOT, FULLY INSERT.

ATTENTION:

POUR ÉVITER LES CHOCS ÉLECTRIQUES, INTRODUIRE LA LAME LA PLUS LARGE DE LA FICHE DANS LA BORNE CORRESPONDANTE DE LA PRISE ET POUSSER JUSQU'AU FOND.

Note to CATV system installer:

This reminder is provided to call the CATV system installer's attention to Article 820-40 of the NEC that provides guidelines for proper grounding and, in particular, specifies that the cable ground shall be connected to the grounding system of the building, as close to the point of cable entry as practical.

CAUTION:

Changes or modifications not approved by JVC could void user's authority to operate the equipment.

Failure to heed the following precautions may result in damage to the VCR, Remote or video cassette.

- DO NOT place the VCR . . .**
 - ...in an environment prone to extreme temperatures or humidity.
 - ...in direct sunlight.
 - ...in a dusty environment.
 - ...in an environment where strong magnetic fields are generated.
 - ...on a surface that is unstable or subject to vibration.
- DO NOT block the VCR's ventilation openings.**
- DO NOT place heavy objects on the VCR or on the Remote.**
- DO NOT place anything which might spill on the top of the VCR or on the Remote.**
- AVOID violent shocks to the VCR during transport.**

MOISTURE CONDENSATION

Moisture in the air will condense on the VCR when you move it from a cold place to a warm place, or under extremely humid conditions—just as water droplets form on the surface of a glass filled with cold liquid. Moisture condensation on the head drum will cause damage to the tape. In conditions where condensation may occur, keep the VCR's power turned on for a few hours to let the moisture dry before inserting a tape.

VCR Plus+, C³ and PlusCode are registered trademarks of Gemstar Development Corporation. The VCR Plus+ system is manufactured under license from Gemstar Development Corporation.

DSS™ is an official trademark of DIRECTV, Inc., a unit of GM Hughes Electronics. PRIMESTAR is a registered service mark of Primestar Partners, L.P. DISH Network™ is a trademark of EchoStar Communications Corporation.



- Cassettes marked "S-VHS" and "VHS" can be used with this video cassette recorder. However, S-VHS recordings are possible only with cassettes marked "S-VHS". By using the S-VHS ET function, it is possible to record and play back with S-VHS picture quality on VHS cassettes with this VCR.
- Cassettes marked "Mini DV" can be used with the DV deck of this VCR. The DV deck can play back and record only NTSC signals.

This product incorporates copyright protection technology that is protected by method claims of certain U.S. patents and other intellectual property rights owned by Macrovision Corporation and other rights owners. Use of this copyright protection technology must be authorized by Macrovision Corporation, and is intended for home and other limited viewing users only unless otherwise authorized by Macrovision Corporation. Reverse engineering or disassembly is prohibited.

IMPORTANT PRODUCT SAFETY INSTRUCTIONS

Electrical energy can perform many useful functions. But improper use can result in potential electrical shock or fire hazards. This product has been engineered and manufactured to assure your personal safety. In order not to defeat the built-in safeguards, observe the following basic rules for its installation, use and servicing.

ATTENTION:

Follow and obey all warnings and instructions marked on your product and its operating instructions. For your safety, please read all the safety and operating instructions before you operate this product and keep this booklet for future reference.

INSTALLATION

1. Grounding or Polarization

(A) Your product may be equipped with a polarized alternating-current line plug (a plug having one blade wider than the other). This plug will fit into the power outlet only one way. This is a safety feature.

If you are unable to insert the plug fully into the outlet, try reversing the plug. If the plug should still fail to fit, contact your electrician to replace your obsolete outlet. Do not defeat the safety purpose of the polarized plug.

(B) Your product may be equipped with a 3-wire grounding-type plug, a plug having a third (grounding) pin. This plug will only fit into a grounding-type power outlet. This is a safety feature.

If you are unable to insert the plug into the outlet, contact your electrician to replace your obsolete outlet. Do not defeat the safety purpose of the grounding-type plug.

2. Power Sources

Operate your product only from the type of power source indicated on the marking label. If you are not sure of the type of power supply to your home, consult your product dealer or local power company. If your product is intended to operate from battery power, or other sources, refer to the operating instructions.

3. Overloading

Do not overload wall outlets, extension cords, or integral convenience receptacles as this can result in a risk of fire or electric shock.

4. Power Cord Protection

Power supply cords should be routed so that they are not likely to be walked on or pinched by items placed upon or against them, paying particular attention to cords at plugs, convenience receptacles, and the point where they exit from the product.

5. Ventilation

Slots and openings in the cabinet are provided for ventilation. To ensure reliable operation of the product and to protect it from overheating, these openings must not be blocked or covered.

- Do not block the openings by placing the product on a bed, sofa, rug or other similar surface.
- Do not place the product in a built-in installation such as a bookcase or rack unless proper ventilation is provided or the manufacturer's instructions have been adhered to.

6. Wall or Ceiling Mounting

The product should be mounted to a wall or ceiling only as recommended by the manufacturer.

ANTENNA INSTALLATION INSTRUCTIONS

1. Outdoor Antenna Grounding

If an outside antenna or cable system is connected to the product, be sure the antenna or cable system is grounded so as to provide some protection against voltage surges and built-up static charges. Article 810 of the National Electrical Code, ANSI/NFPA 70, provides information with regard to proper grounding of the mast and supporting structure, grounding of the lead-in wire to an antenna discharge unit, size of grounding connectors, location of antenna discharge unit, connection to grounding electrodes, and requirements for the grounding electrode.

2. Lightning

For added protection for this product during a lightning storm, or when it is left unattended and unused for long periods of time, unplug it from the wall outlet and disconnect the antenna or cable system. This will prevent damage to the product due to lightning and power-line surges.

3. Power Lines

An outside antenna system should not be located in the vicinity of overhead power lines or other electric light or power circuits, or where it can fall into such power lines or circuits. When installing an outside antenna system, extreme care should be taken to keep from touching such power lines or circuits as contact with them might be fatal.

EXAMPLE OF ANTENNA GROUNDING AS PER NATIONAL ELECTRICAL CODE, ANSI/NFPA 70

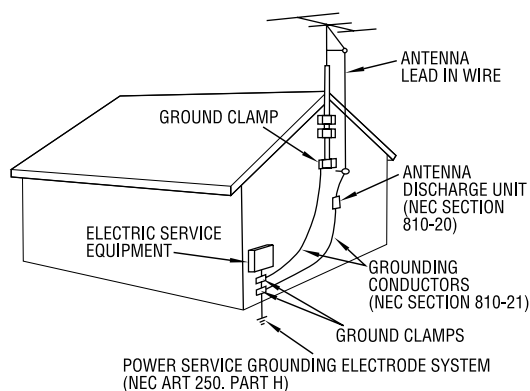

NEC – NATIONAL ELECTRICAL CODE

USE

1. Accessories

To avoid personal injury:

- Do not place this product on an unstable cart, stand, tripod, bracket, or table. It may fall, causing serious injury to a child or adult, and serious damage to the product.
- Use only with a cart, stand, tripod, bracket, or table recommended by the manufacturer or sold with the product.
- Use a mounting accessory recommended by the manufacturer and follow the manufacturer's instructions for any mounting of the product.
- Do not try to roll a cart with small casters across thresholds or deep-pile carpets.

2. Product and Cart Combination

A product and cart combination should be moved with care. Quick stops, excessive force, and uneven surfaces may cause the product and cart combination to overturn.

PORTABLE CART WARNING
(Symbol provided by RETAC)



3. Water and Moisture

Do not use this product near water—for example, near a bath tub, wash bowl, kitchen sink or laundry tub, in a wet basement, or near a swimming pool and the like.

4. Object and Liquid Entry

Never push objects of any kind into this product through openings as they may touch dangerous voltage points or short-out parts that could result in a fire or electric shock. Never spill liquid of any kind on the product.

5. Attachments

Do not use attachments not recommended by the manufacturer of this product as they may cause hazards.

6. Cleaning

Unplug this product from the wall outlet before cleaning. Do not use liquid cleaners or aerosol cleaners. Use a damp cloth for cleaning.

7. Heat

The product should be situated away from heat sources such as radiators, heat registers, stoves, or other products (including amplifiers) that produce heat.

SERVICING

1. Servicing

If your product is not operating correctly or exhibits a marked change in performance and you are unable to restore normal operation by following the detailed procedure in its operating instructions, do not attempt to service it yourself as opening or removing covers may expose you to dangerous voltage or other hazards. Refer all servicing to qualified service personnel.

2. Damage Requiring Service

Unplug this product from the wall outlet and refer servicing to qualified service personnel under the following conditions:

- When the power supply cord or plug is damaged.
- If liquid has been spilled, or objects have fallen into the product.
- If the product has been exposed to rain or water.
- If the product does not operate normally by following the operating instructions. Adjust only those controls that are covered by the operating instructions as an improper adjustment of other controls may result in damage and will often require extensive work by a qualified technician to restore the product to its normal operation.
- If the product has been dropped or damaged in any way.
- When the product exhibits a distinct change in performance—this indicates a need for service.

3. Replacement Parts

When replacement parts are required, be sure the service technician has used replacement parts specified by the manufacturer or which have the same characteristics as the original part. Unauthorized substitutions may result in fire, electric shock or other hazards.

4. Safety Check

Upon completion of any service or repairs to this product, ask the service technician to perform safety checks to determine that the product is in safe operating condition.

HOW TO USE THIS INSTRUCTION MANUAL

- All major sections and subsections are listed in the Table Of Contents on page 5. Use this when searching for information on a specific procedure or feature.
- The Index on pages 6 – 11 lists frequently-used terms, and the number of the page on which they are used or explained in the manual. This section also illustrates the controls and connections on the front and rear panel, the front display panel and the remote control.
- The  mark signals a reference to another page for instructions or related information.
- Operation buttons necessary for the various procedures are clearly indicated through the use of illustrations at the beginning of each major section.

BEFORE YOU INSTALL YOUR NEW VCR . . .

. . . please read the sections/literature listed below.

- "CAUTIONS" on page 2
- "IMPORTANT PRODUCT SAFETY INSTRUCTIONS" on pages 3 – 4

INDEX	6
FRONT VIEW	6
REAR VIEW	7
FRONT DISPLAY PANEL	8
REMOTE	9
How To Use	9
ON-SCREEN DISPLAY (for VHS deck)	10
ON-SCREEN DISPLAY (for DV deck)	11
INSTALLING YOUR NEW VCR	12
Basic Connections	12
S-VIDEO Connection	13
INITIAL SETTINGS	14
Plug & Play Set	14
Language	15
Clock Set	16
Preparations	16
Semiauto Clock Set	17
Manual Clock Set	17
Tuner Set	18
Auto Channel Set	18
Manual Channel Set	19
Cable Box Control Setting	20
Installing Controller	20
Setting cable box's brand and channel	21
DBS Receiver Control Setting	23
Installing Controller	23
Setting DBS receiver's brand and channel	24
PLAYBACK/RECORDING ON VHS DECK	26
Basic Playback	26
Basic Recording	27
Playback Features	28
Still Picture/Frame-By-Frame Playback (On the VCR)	28
Slow Motion (On the VCR)	28
High-Speed (Turbo) Search (On the VCR)	28
Variable Speed Search (On the VCR)	28
Still Picture/Frame-By-Frame Playback (On the Remote)	29
Slow Motion (On the Remote)	29
High-Speed (Turbo) Search (On the Remote)	29
Variable Speed Search (On the Remote)	29
Repeat Playback	30
Index Search	30
Next Function Memory	30
Manual Tracking	31
Soundtrack Selection	31
Recording Features	32
Record One Program While Watching Another	32
Instant Timer Recording (ITR)	32
Elapsed Recording Time Indication	33
Tape Remaining Time	33
Retake	34
Second Audio Recording	34
Active Video Calibration	35
Playback	35
Recording	35

PLAYBACK/RECORDING ON DV DECK	36
Basic Playback	36
Basic Recording	37
Playback Features	38
Still Picture/Frame-By-Frame Playback (On the VCR)	38
Slow Motion (On the VCR)	38
High-Speed (Turbo) Search (On the VCR)	38
Variable Speed Search (On the VCR)	38
Still Picture/Frame-By-Frame Playback (On the Remote)	39
Slow Motion (On the Remote)	39
High-Speed (Turbo) Search (On the Remote)	39
Variable Speed Search (On the Remote)	39
Next Function Memory	40
Soundtrack Selection	40
Recording Features	41
Second Audio Recording	41
Record One Program While Watching Another	41
Instant Timer Recording (ITR)	41
Time Code	41
TIMER RECORDING	42
VCR Plus+® Timer Programing	42
Changing VCR Plus+® Setting	44
Guide Channel Number Set	44
Guide Channel Number	45
Express Timer Programing	46
24HR Quick Programing	48
Check, cancel and change programs	50
To cancel or change a program... ..	50
When programs overlap each other	51
EDITING	52
Tape Dubbing (from DV to VHS)	52
Dubbing An Entire Cassette	52
Tape Dubbing (from VHS to DV)	53
Dubbing An Entire Cassette	53
Normal Dubbing (from DV to VHS)	54
Normal Dubbing (from VHS to DV)	55
Edit From A Camcorder	56
Edit To Or From Another VCR/PC	58
Audio Dubbing	60
VHS Audio Dubbing	60
DV Audio Dubbing	60
Insert Editing	62
VHS Insert Editing	62
DV Insert Editing (SP mode only)	62
AV Insert Editing (VHS deck only)	63
Random Assemble Editing	64
64-program Editing Memory (8 programs x 8 scenes)	64
REMOTE CONTROL FUNCTIONS	66
Remote A/B Code Switching	66
TV Multi-Brand Remote Control	67
Cable Box Multi-Brand Remote Control	68
DBS Receiver Multi-Brand Remote Control	69
SUBSIDIARY SETTINGS	70
Mode Set	70
TROUBLESHOOTING	77
QUESTIONS AND ANSWERS	81
PLAYBACK	81
RECORDING	81
TIMER RECORDING	81
SPECIFICATIONS	82
INDEX	83
FOR SERVICING (Only in U.S.A.)	84
WARRANTY (Only in U.S.A.)	85

FRONT VIEW

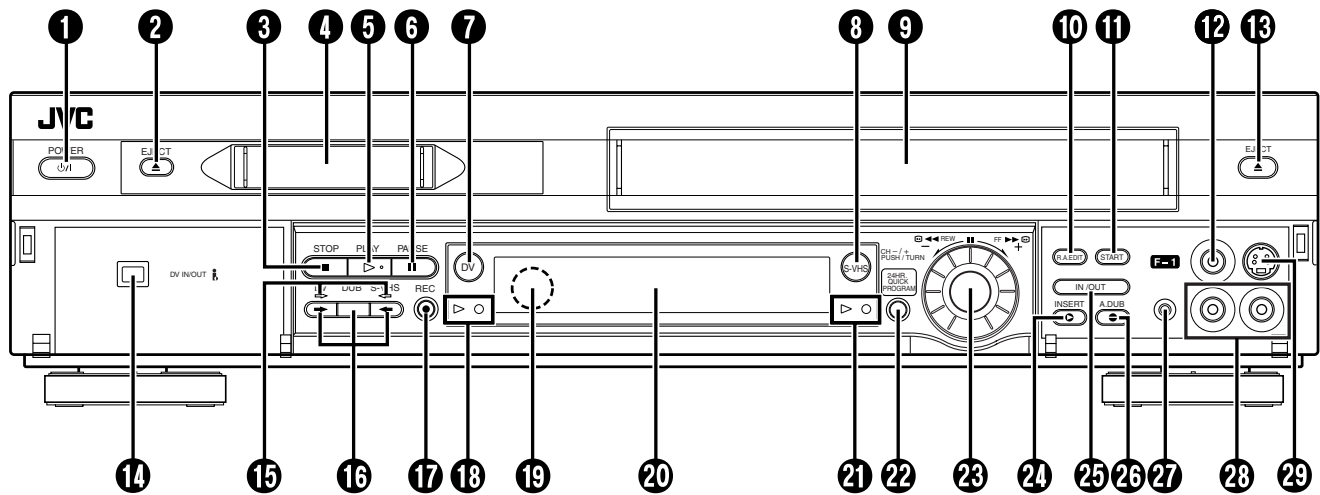

- ① POWER Button ☞ pg. 15
- ② DV Eject (EJECT ▲) Button ☞ pg. 36, 37
- ③ STOP ■ Button ☞ pg. 26, 27, 36, 37
- ④ Mini DV Cassette Loading Slot
- ⑤ PLAY ► Button ☞ pg. 26, 36
- ⑥ PAUSE || Button ☞ pg. 27, 28, 37, 38
- ⑦ DV Button ☞ pg. 36, 37
- ⑧ S-VHS Button ☞ pg. 26, 27
- ⑨ VHS Cassette Loading Slot
- ⑩ Random Assemble Edit (R.A.EDIT) Button ☞ pg. 64
- ⑪ Random Assemble Edit START Button ☞ pg. 65
- ⑫ VIDEO Input Connector ☞ pg. 56, 62
- ⑬ VHS Eject (EJECT ▲) Button ☞ pg. 26, 27
- ⑭ DV IN/OUT connector (i.Link*) ☞ pg. 56
- ⑮ Dubbing Direction (DV ⇌/⇐ S-VHS) Indicators ☞ pg. 52, 53
- ⑯ Dubbing (DUB) Button ☞ pg. 52, 53
- ⑰ Dubbing Direction (►/◄) Buttons ☞ pg. 52, 53
- ⑱ REC ● Button ☞ pg. 27, 37
- ⑲ DV mode Indicators ☞ pg. 36, 37
- ⑳ Remote Sensor
- ㉑ Front Display Panel ☞ pg. 8
- ㉒ VHS mode Indicators ☞ pg. 26, 27
- ㉓ 24HR QUICK PROGRAM Button ☞ pg. 48
- ㉔ ADVANCED JOG Dial ☞ pg. 26, 36, 48
- ㉕ INSERT Button ☞ pg. 63
- ㉖ Random Assemble Edit IN/OUT Button ☞ pg. 64
- ㉗ Audio Dubbing (A.DUB) Button ☞ pg. 61
- ㉘ Remote PAUSE Connector ☞ pg. 56
- ㉙ AUDIO Input Connectors ☞ pg. 56, 60, 62
- ㉚ S-VIDEO Input Connector ☞ pg. 56, 62

* i.Link refers to the IEEE1394-1995 industry specification and extensions thereof. The  logo is used for products compliant with the i.Link standard.

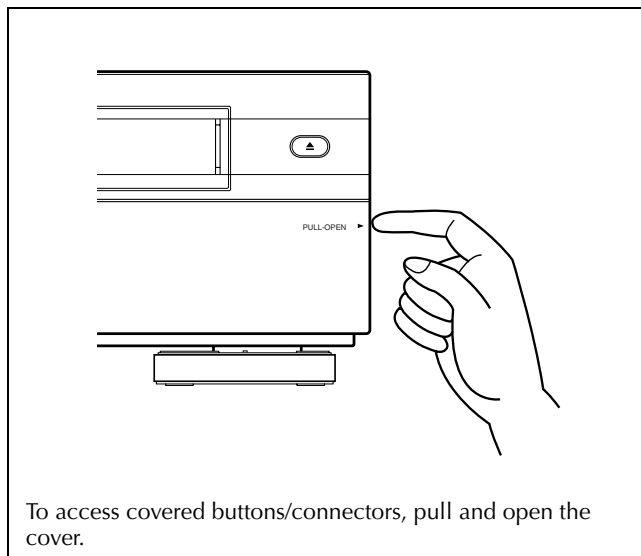

To access covered buttons/connectors, pull and open the cover.

REAR VIEW

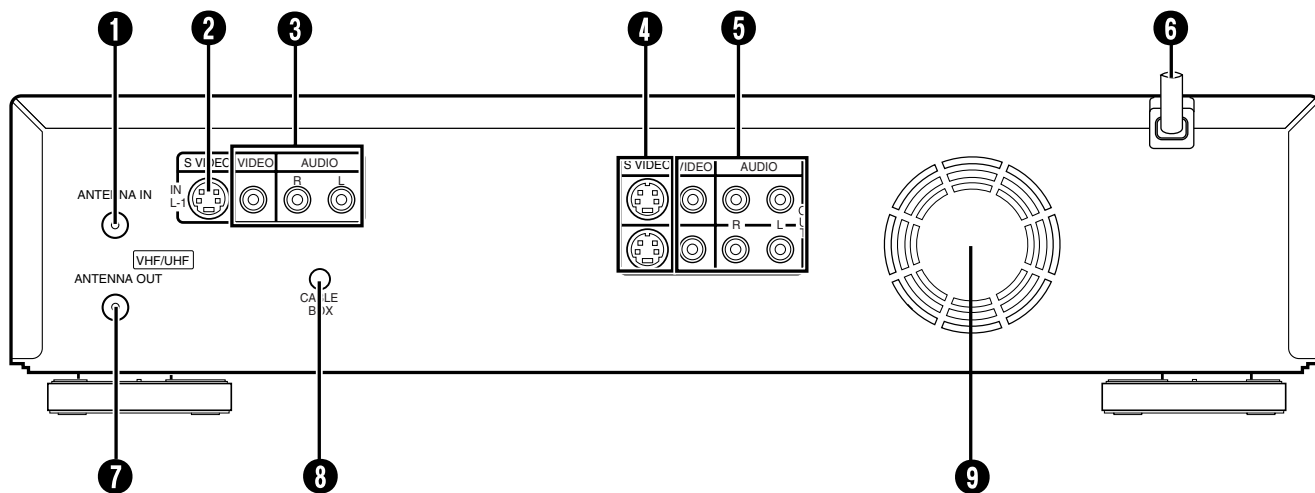

- 1** ANTENNA IN Connector ☞ pg. 12
- 2** S VIDEO IN Connector ☞ pg. 56, 58
- 3** VIDEO/AUDIO IN Connectors
☞ pg. 56, 58
- 4** S VIDEO OUT Connectors ☞ pg. 13, 58
- 5** VIDEO/AUDIO OUT Connectors ☞ pg. 58
- 6** AC Power Cord ☞ pg. 12

- 7** ANTENNA OUT Connector ☞ pg. 12
- 8** CABLE BOX Connector ☞ pg. 20, 23
- 9** Cooling fan
 - This prevents the temperature from rising inside the VCR. Do not remove it.
 - Install the VCR so as not to block the area around the fan.
 - The fan may be activated even if the VCR is turned off.

FRONT DISPLAY PANEL

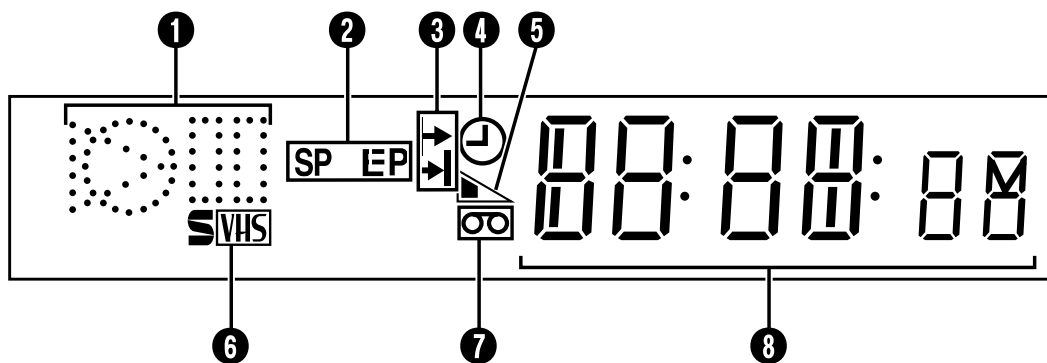

1 Symbolic Mode Indicators

PLAY: FF/REW VARIABLE SEARCH:	▶	STILL: SLOW:	▶■
		RECORD:	○
		RECORD PAUSE:	○■
AUDIO DUBBING:			⊙
AUDIO DUBBING PAUSE:			⊙■
INSERT:			Ⓜ
INSERT PAUSE:			Ⓜ■
AV INSERT:			⊙
AV INSERT PAUSE:			⊙■

- 2 Tape Speed Indicators ☞ pg. 27, 37
- 3 Start Time Indicator (▶) ☞ pg. 48
Stop Time Indicator (▶|) ☞ pg. 48
- 4 "Timer" Indicator ☞ pg. 43, 47, 48
- 5 Tape Remaining Time Indicator (VHS deck only)
☞ pg. 33
- 6 S-VHS Indicator (VHS deck only) ☞ pg. 72
- 7 "Cassette Loaded" Mark
- 8 Counter/Remain Display (VHS deck only)
☞ pg. 33
Time Code Display (DV deck only) ☞ pg. 41
Channel/Mode Display (L-1 or F-1) ☞ pg. 14
Clock Display ☞ pg. 14

REMOTE

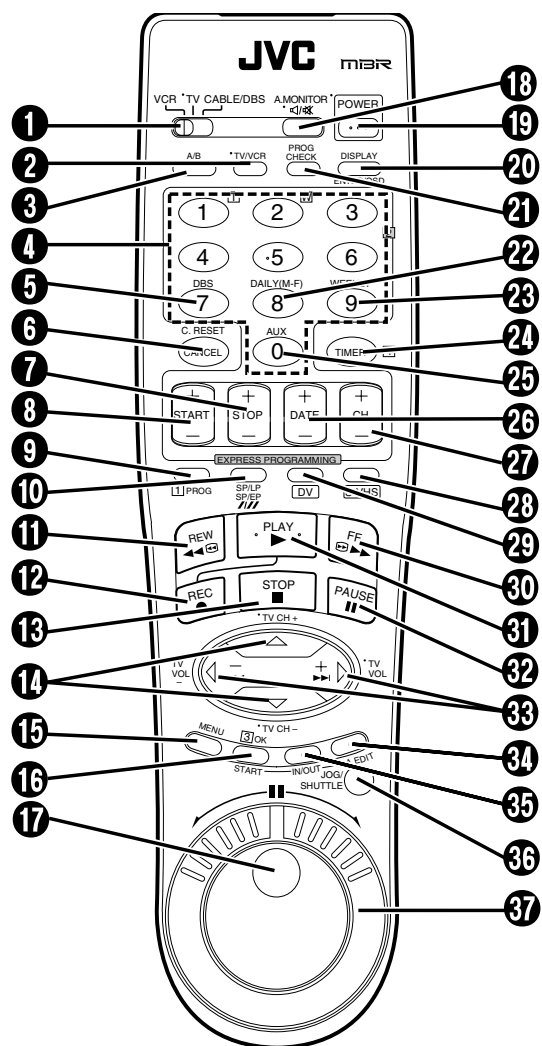

Buttons with a small dot on the left side of the name can also be used to operate your TV with the **VCR/TV/CABLE/DBS** switch set to TV. (☞ pg. 67)

How To Use

Before use, insert two AA size batteries into the Remote with the polarity (⊕ and ⊖) matched correctly as indicated on the battery compartment or on the lid.

The Remote can operate most of your VCR's functions, as well as basic functions of TV sets, cable boxes and DBS receivers.

- Point the Remote toward the remote sensor on the target component.
- The maximum operating distance of the remote control is about 8 m.

NOTE:

If the Remote does not work properly, remove its batteries, wait for a few seconds, replace the batteries and then try again.

- 1 VCR/TV/CABLE/DBS Button ☞ pg. 67, 68, 69
- 2 TV/VCR Button ☞ pg. 67
- 3 A/B Code Button ☞ pg. 66
- 4 Number Keys ☞ pg. 27, 37
- 5 DBS Button ☞ pg. 47
- 6 CANCEL Button ☞ pg. 50
- 7 Counter Reset (C.RESET) Button ☞ pg. 33
- 8 STOP +/- Button ☞ pg. 46
- 9 START +/- Button ☞ pg. 46
- 10 PROG Button ☞ pg. 46
- 11 Auto Tracking /// Button ☞ pg. 31
- 12 SP/LP, SP/EP Button ☞ pg. 27, 37
- 13 Rewind (REW ◀) Button ☞ pg. 26, 36
- 14 REC ● Button ☞ pg. 27, 37
- 15 STOP ■ Button ☞ pg. 26, 36
- 16 $\Delta \nabla$ Button ☞ pg. 15
- 17 TV CH +/- Button ☞ pg. 67
- 18 MENU Button ☞ pg. 15
- 19 OK Button ☞ pg. 15
- 20 Random Assemble Edit START Button ☞ pg. 65
- 21 JOG dial ☞ pg. 26, 36
- 22 A. MONITOR Button ☞ pg. 31, 40
- 23 M (TV Muting) Button ☞ pg. 67
- 24 POWER Button ☞ pg. 15
- 25 DISPLAY Button ☞ pg. 33
- 26 ENTER Button ☞ pg. 67
- 27 On-Screen Display (OSD) Button ☞ pg. 10, 11
- 28 PROG CHECK Button ☞ pg. 50
- 29 DAILY (M-F) Button ☞ pg. 43, 47
- 30 WEEKLY Button ☞ pg. 43, 47
- 31 TIMER Button ☞ pg. 43, 47
- 32 AUX Button ☞ pg. 56
- 33 DATE +/- Button ☞ pg. 47
- 34 CH +/- Button ☞ pg. 27, 37
- 35 S-VHS Button ☞ pg. 26, 27
- 36 DV Button ☞ pg. 36, 37
- 37 Fast Forward (FF ▶▶) Button ☞ pg. 26, 36
- 38 PLAY ▶ Button ☞ pg. 26, 36
- 39 PAUSE || Button ☞ pg. 27, 37
- 40 $\langle \rangle$ Button ☞ pg. 29, 39
- 41 TV Volume (VOL) +/- Button ☞ pg. 67
- 42 Random Assemble Edit (R.A.EDIT) Button ☞ pg. 64
- 43 Random Assemble Edit IN/OUT Button ☞ pg. 64
- 44 JOG/SHUTTLE Button ☞ pg. 29, 39
- 45 SHUTTLE Ring ☞ pg. 29, 39

ON-SCREEN DISPLAY (for VHS deck)

If you press **DISPLAY/OSD** on the Remote when "SUPERIMPOSE" is set to "ON" (☞ pg. 71), various operational indicators appear on the TV screen.

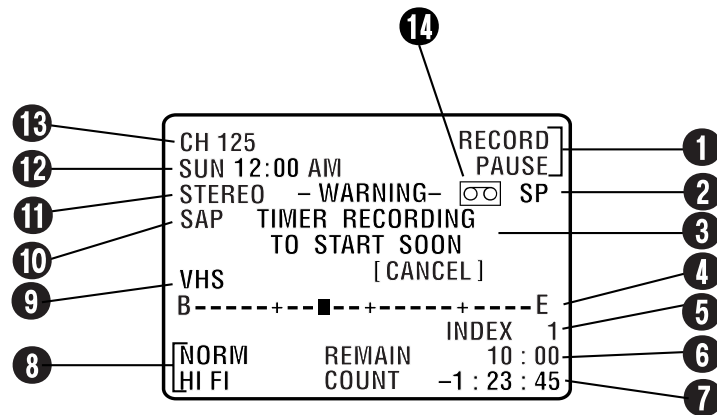

1 Operation Mode Indicators

2 Tape Speed SP/EP

3 Timer Warning Display

A warning appears on the TV screen to tell you that the timer-recording is to start in 5 minutes if you're not in the Timer mode at that time. The warning blinks for the entire 5 minutes leading up to the start of timer recording. To clear the display, press **CANCEL** on the Remote.

4 Tape Position Indicator

The tape position indicator appears on the TV screen when you press **REW** (◀◀) or **FF** (▶▶) from the Stop mode or perform an Index Search (☞ pg. 30). The position of "█" in relation to "B" (beginning) or "E" (end) shows you where you are on the tape.

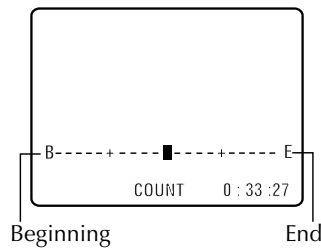

NOTE:

Depending on the type of tape being used, the tape position indicator may not appear correctly.

5 Index number ☞ pg. 30

6 Tape Remaining Time Indicator

7 Counter Display ☞ pg. 33

8 Audio Mode Display ☞ pg. 31

9 VHS Indicator

10 SAP Indicator ☞ pg. 34

11 Stereo program Indicator ☞ pg. 34

12 Day/Clock Display

13 Channel Position Number/ Auxiliary Input Indicator (L-1 or F-1) Dubbing Direction Indicators (DV → VHS) ☞ pg. 52

14 "Cassette Loaded" Mark

To recall an indication

1 Press **DISPLAY/OSD**.

- All indications corresponding to the current status are displayed for 5 seconds. After that, the counter information and RECORD/PAUSE if in the Record Pause mode, remain on the screen.

2 Press **DISPLAY/OSD** again to clear the display.

- The RECORD/PAUSE indication remains on the screen.

ON-SCREEN DISPLAY (for DV deck)

If you press **DISPLAY/OSD** on the Remote when "SUPERIMPOSE" is set to "ON" (☞ pg. 71), various operational indicators appear on the TV screen.

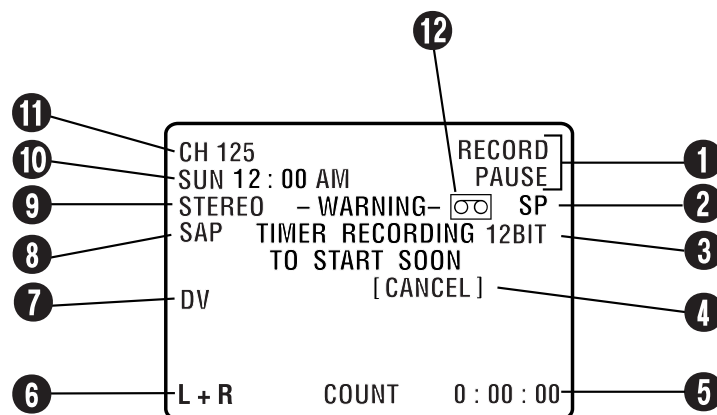

① Operation Mode Indicators

② Tape Speed SP/LP

③ Sound Mode Display ☞ pg. 76

④ Timer Warning Display

A warning appears on the TV screen to tell you that the timer-recording is to start in 5 minutes if you're not in the Timer mode at that time. The warning blinks for the entire 5 minutes leading up to the start of timer recording. To clear the display, press **CANCEL** on the Remote.

ERROR Indicator*

* *ERROR* indicator appears when you start dubbing a tape with a copy protection signals or when Audio Dubbing or Insert Editing is not possible depending on the condition.

⑤ Time Code Display ☞ pg. 41

⑥ Audio Mode Display ☞ pg. 40

⑦ DV Indicator

⑧ SAP Indicator ☞ pg. 41

⑨ Stereo program Indicator ☞ pg. 41

⑩ Day/Clock Display

⑪ Channel Position Number/
Auxiliary Input Indicator (L-1 or F-1)
Dubbing Direction Indicators
(VHS → DV) ☞ pg. 53

⑫ "Cassette Loaded" Mark

To recall an indication

① Press **DISPLAY/OSD**.

- All indications corresponding to the current status are displayed for 5 seconds. After that, the counter information and RECORD/PAUSE if in the Record Pause mode, remain on the screen.

② Press **DISPLAY/OSD** again to clear the display.

- The RECORD/PAUSE indication remains on the screen.

Basic Connections

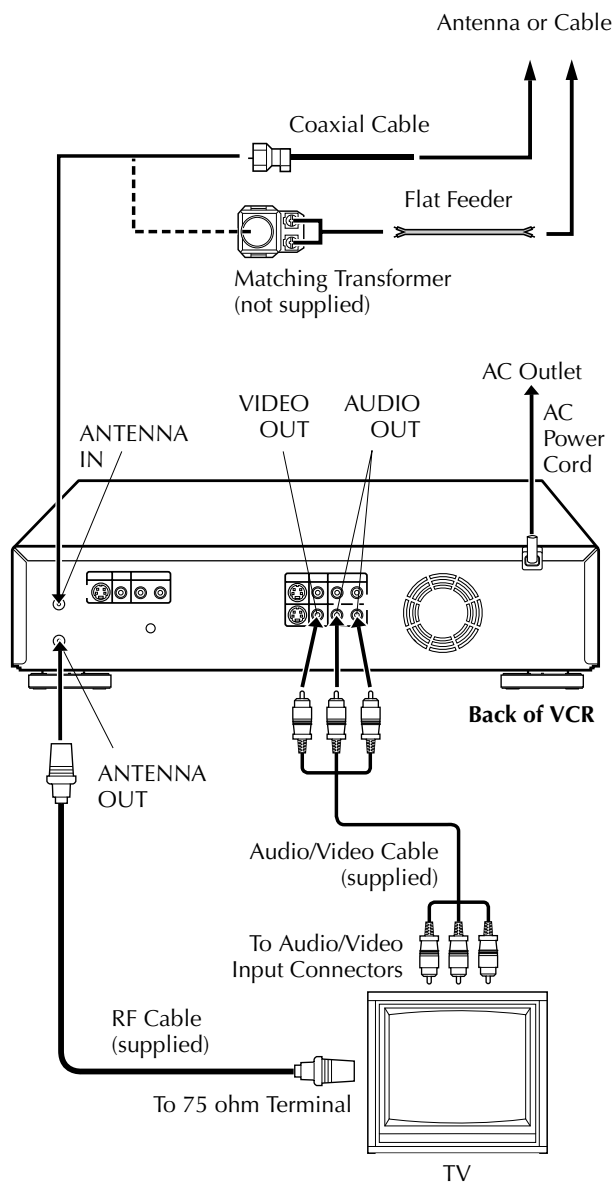

It's essential that your VCR be properly connected.

THESE STEPS MUST BE COMPLETED BEFORE ANY VIDEO OPERATION CAN BE PERFORMED.

1 Check the contents.

Make sure the package contains all of the accessories listed in "SPECIFICATIONS" on page 82.

2 Situate the VCR.

Place the VCR on a stable, horizontal surface.

3 Connect the VCR to TV.

- 1 Disconnect the TV antenna from the TV.
 - 2 Connect the TV antenna cable to the ANTENNA IN connector on the rear panel of the VCR.
 - 3 Connect the supplied RF cable between the ANTENNA OUT connector on the rear panel of the VCR and the TV's antenna terminal.
 - 4 Connect the supplied Audio/Video cable between the AUDIO/VIDEO OUT connectors on the rear of the VCR and the Audio/Video input connectors on the TV.
- Set your TV to AV mode.
 - For switching the TV's mode, refer to the instruction manual of your television.
 - To obtain high-quality S-VHS pictures, you can also use the S-VIDEO connection described on page 13.

4 Connect the VCR to power source.

Plug the end of the AC power cord into an AC outlet.

- The clock and tuner channels will automatically be set when the antenna is connected and when the AC power cord is first connected to an AC outlet (pg. 14). (If "Auto" or "CH" is displayed on the front display panel before the VCR is powered on, the clock and tuner channels are being set automatically. Wait for the time to be displayed on the front display panel before turning on the VCR.)

S-VIDEO Connection

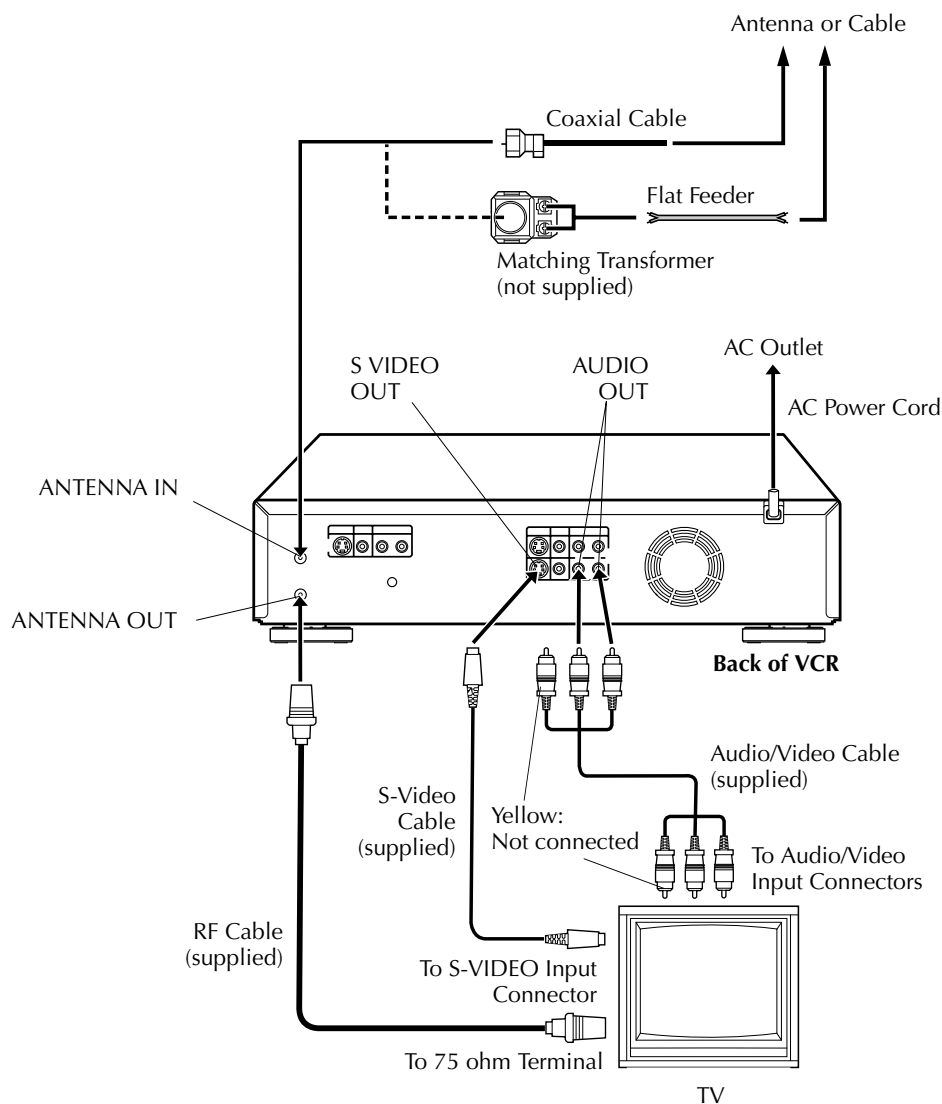

■ To connect to a TV with S-VIDEO/AUDIO input connectors . . .

1 Connect the VCR to TV.

- 1 Connect the antenna, VCR and TV as per "Basic Connections" (pg. 12).
- 2 Connect the VCR's S VIDEO OUT connector to the TV's S-VIDEO input connector.
- 3 Connect the VCR's AUDIO OUT connectors to the TV's AUDIO input connectors.

2 Connect the VCR to power source.

Plug the end of the AC power cord into an AC outlet.

- The clock and tuner channels will automatically be set when the antenna is connected and when the AC power cord is first connected to an AC outlet (pg. 14). (If "Auto" or "CH" is displayed on the front display panel before the VCR is powered on, the clock and tuner channels are being set automatically. Wait for the time to be displayed on the front display panel before powering on the VCR.)

NOTES:

- You can obtain high-quality S-VHS pictures.
- To operate the VCR with your TV using the S-VIDEO connection, set your TV to its AV mode. You can also use the TV/VCR button on the VCR's Remote to set your TV to the AV mode. (pg. 67)
- For switching the TV's mode, refer to the instruction manual of your television.

Plug & Play Set

Auto Clock Set/Auto Tuner Set

ATTENTION:

- If you use a cable box, Plug&Play will not function; set the clock and tuner channels separately. (☞ pg. 16 – 19)
- Depending on areas or reception conditions, the VCR may not receive the Auto clock setting data from the PBS channel. If this function is taking a considerable amount of time, it may be necessary to perform the Semiauto or Manual Clock Set procedure.

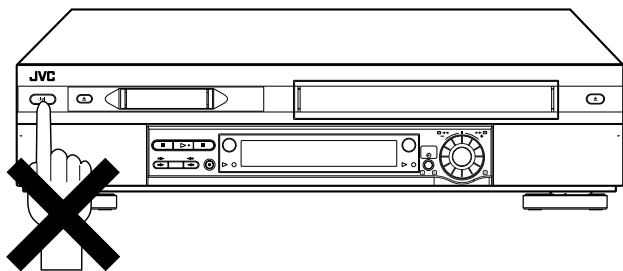

This VCR sets the clock and tuner channels automatically when AC power cord is first connected to an AC outlet. The antenna cable must be connected for the Plug & Play setting.

The time and date can be set automatically by the clock setting data transmitted from one of the regular TV broadcast channels. We call this TV channel the “host channel” and it is a PBS channel in your area.

1 Perform Plug & Play setup.

Connect the antenna cable to the VCR (☞ pg. 12). Then connect the AC power cord to an AC outlet. Do not turn on the VCR.

The clock and tuner channels will be set automatically.

NOTES:

- *Auto Clock Set is performed first. “Auto” blinks on the front display panel during Auto Clock Set.*
- *Auto Channel Set is performed next. Auto Channel Set scans all the channels that are receivable by your VCR. During Auto Channel Set, the channel numbers are displayed as they are scanned and set.*
- *When Plug & Play setting has been complete successfully, the correct clock time is displayed. If you perform Plug & Play setting successfully, there is no need to perform “Clock Set” (☞ pg. 16) and “Tuner Set” (☞ pg. 18). If, however, you want to add or delete channels, refer to “Manual Channel Set” (☞ pg. 19).*

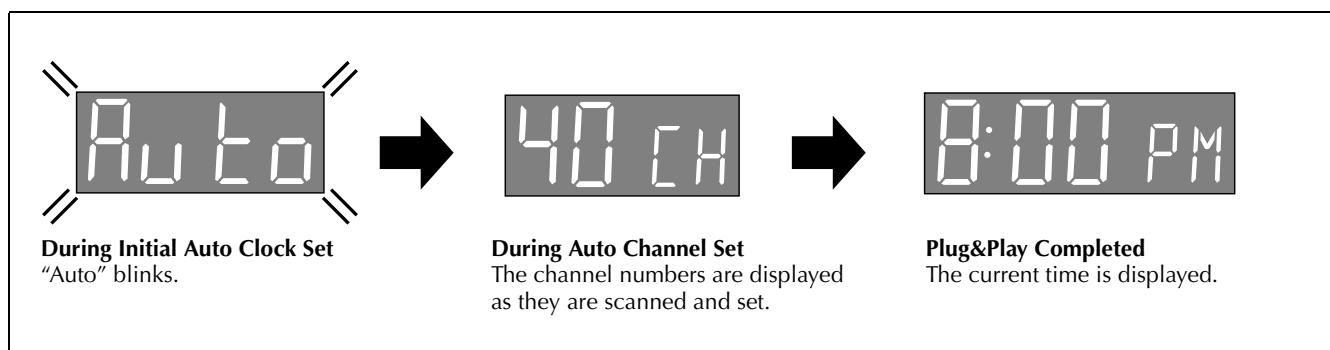

* If an incorrect clock time or “--:--” appears on the display panel, see “What to do if Plug & Play setting failed” below.

INFORMATION

- If “AUTO CLOCK” is set to “ON” (☞ pg. 17), the clock will be adjusted automatically by the host channel every hour (except 11:00 PM, midnight, 1:00 AM and 2:00 AM) using the incoming PBS channel clock setting data. (This automatic clock adjustment can only be performed when the VCR is turned off. The clock will be adjusted just on these hours — on the time displayed on the front display panel, not on the actual real time.) The default setting of “AUTO CLOCK” is “ON”. (☞ pg. 17)
- If the memory backup fails, because a power outage occurs or because the AC power cord is unplugged, Plug & Play will be performed when power is restored to the VCR.

What to do if Plug & Play setting failed

- If an incorrect time is displayed on the front display panel, you may be receiving the clock setting data of a PBS channel from an adjacent time zone, or an incorrect PBS channel from a cable TV system. In this case, perform “Semiauto Clock Set” (☞ pg. 17) or “Manual Clock Set” (☞ pg. 17).
- If “--:--” appears on the front display panel, your antenna cable may not be connected to the VCR or there may not be a Host PBS signal available in your area. Ensure that the antenna cable is connected correctly. Then turn on and off the VCR; the Plug & Play setting will be automatically reactivated. If Plug & Play setting is not performed though the antenna cable is connected correctly, perform “Manual Clock Set” (☞ pg. 17) and “Auto Channel Set” (☞ pg. 18) or “Manual Channel Set” (☞ pg. 19).

Language

Turn on the TV and select the AV mode.

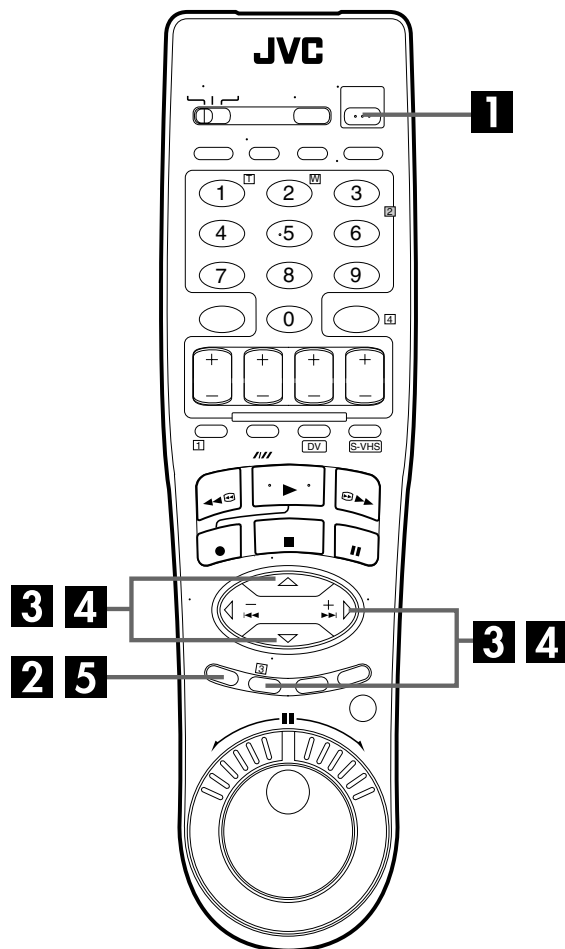

1 Turn on the VCR.

Press **POWER**.

2 Access the Main Menu screen.

Press **MENU**.

3 Access the Initial Set screen.

Press Δ / ∇ to move the highlight bar (arrow) to "INITIAL SET", then press **OK** or \triangleright .

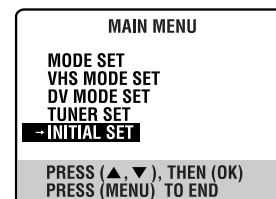

4 Select the language.

Press Δ / ∇ to move the highlight bar (arrow) to "LANGUAGE", then press **OK** or \triangleright repeatedly until the desired language is selected.

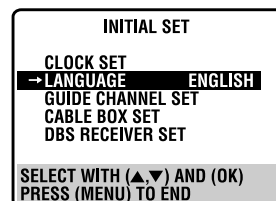

5 Return to the normal screen.

Press **MENU**.

Clock Set

Turn on the TV and select the AV mode.

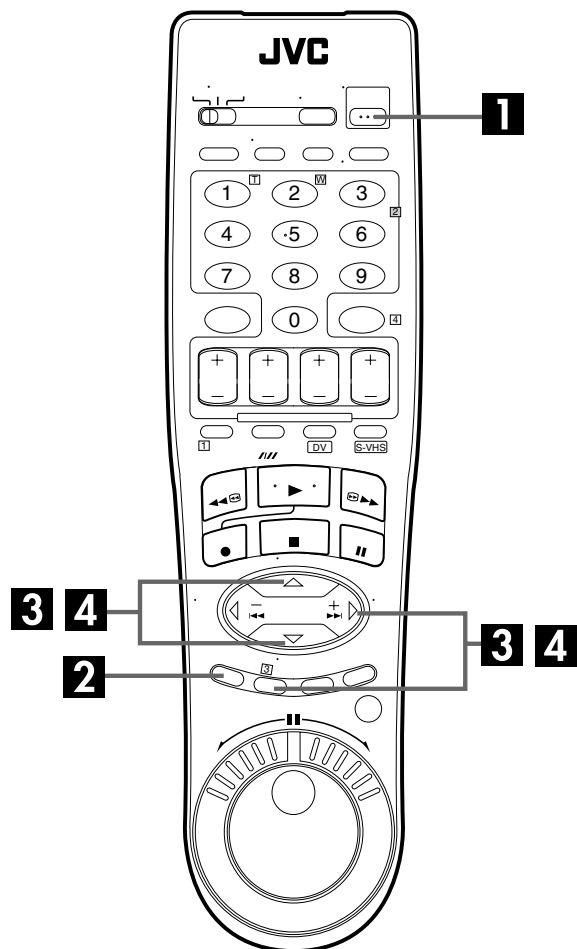

Perform clock setting only if the clock has not been set correctly by the Plug&Play setting or if you use a cable box.

Preparations

1 Turn on the VCR.

Press **POWER**.

2 Access the Main Menu screen.

Press **MENU**.

3 Access the Initial Set screen.

Press Δ / ∇ to move the highlight bar (arrow) to "INITIAL SET", then press **OK** or \triangleright .

4 Access the Clock Set screen.

Press Δ / ∇ to move the highlight bar (arrow) to "CLOCK SET", then press **OK** or \triangleright .

- "CABLE BOX USERS SET CLOCK MANUALLY" appears on the screen for about 5 seconds, then the Clock Set screen appears.

Semiauto Clock Set

You can change the host channel/D.S.T. (Daylight Saving Time)/time zone setting manually. First follow steps 1 to 4 in "Preparations" (pg. 16), then go to the following steps.

NOTE:

The time set previously will be erased when "AUTO CLOCK", "HOST CH", "D.S.T." or "TIME ZONE" setting is changed.

1 Set "Auto Clock" to "ON".

Press **OK** or **▷** repeatedly to move the highlight bar to "AUTO CLOCK", then press **△▽** so that "ON" is selected.

CLOCK SET		
TIME	DATE	YEAR
--:--AM	1/ 1	02
AUTO CLOCK : ON		
HOST CH : AUTO		(CATV)
D.S.T. : AUTO		
TIME ZONE : AUTO		
PRESS (▲▼), THEN (OK)		
PRESS (MENU) TO END		

2 Select the host channel.

You can either select "AUTO" or enter a PBS channel number.

Press **OK** or **▷** to move the highlight bar to "HOST CH", then press **△▽** repeatedly until "AUTO" or the desired PBS channel number is selected.

NOTE:

Some PBS channels do not transmit clock setting data.

3 Select the D.S.T. mode.

Press **OK** or **▷** to move the highlight bar to "D.S.T.", then press **△▽** repeatedly until the desired setting is selected.

AUTO: Select if you want to adjust your VCR's clock automatically by the incoming signal from the host channel. Be sure to select the correct time zone manually in step 4.

ON: Adjustment will be made by the built-in clock itself.

OFF: Select when Daylight Saving Time does not apply to you.

4 Select the time zone.

Press **OK** or **▷** to move the highlight bar to "TIME ZONE", then press **△▽** repeatedly until "AUTO" or the desired time zone is selected. Each time you press the button, the time zone changes as follows:

↔ AUTO ↔ ATLANTIC ↔ EASTERN ↔ CENTRAL
 ↔ MOUNTAIN ↔ PACIFIC ↔ ALASKA ↔ HAWAII
 ↔ (back to the beginning)

NOTE:

If an incorrect time is displayed by the Plug & Play function, you may be receiving the clock setting data of a PBS channel from an adjacent time zone or from an incorrect PBS channel from a cable TV system. If you selected "AUTO" for the host channel in step 2, be sure to select the correct time zone manually.

5 Complete the Semiauto Clock Set.

Press **MENU** to return to normal screen.

IMPORTANT

Turn off the VCR after performing Semiauto Clock. "Auto" will appear on the display panel while the clock is being set. The current clock time will appear automatically when the clock setting is complete.

AUTO DAYLIGHT SAVING TIME

This function enables automatic adjustment of the VCR's clock at the start and end of Daylight Saving Time.

With Auto DST activated, . . .

. . . on the first Sunday of April at 2:00 AM, the clock is adjusted to 3:00 AM.

. . . on the last Sunday of October at 2:00 AM, the clock is adjusted to 1:00 AM.

Manual Clock Set

First follow steps 1 to 4 in "Preparations" (pg. 16), then go to the following steps.

1 Set time, date and year.

Press **△▽** until the desired time appears, then press **OK** or **▷**. Set the date and year in the same way.

- Holding **△▽** changes the time in 30-minute intervals, or changes the date in 15-day intervals.

CLOCK SET		
TIME	DATE	YEAR
--:--AM	1/ 1	02
AUTO CLOCK : ON		
HOST CH : AUTO		(CATV)
D.S.T. : AUTO		
TIME ZONE : AUTO		
PRESS (▲▼), THEN (OK)		
PRESS (MENU) TO END		

2 Select D.S.T. mode.

Press **OK** or **▷** to move the highlight bar to "D.S.T.", then press **△▽** to select the desired setting.

ON: Adjustment will be made by the built-in clock itself.

OFF: Select when Daylight Saving Time does not apply to you.

CLOCK SET		
TIME	DATE	YEAR
1:00AM	12/ 24	02 TUE
AUTO CLOCK : OFF		
D.S.T. : ON		
PRESS (▲▼), THEN (OK)		
PRESS (MENU) TO END		

3 Start clock.

Press **MENU** and normal screen appears.

To make corrections any time during the process

Press **OK** or **▷** repeatedly until the item you want to change blinks, then press **△▽**.

Tuner Set

Turn on the TV and select the AV mode.

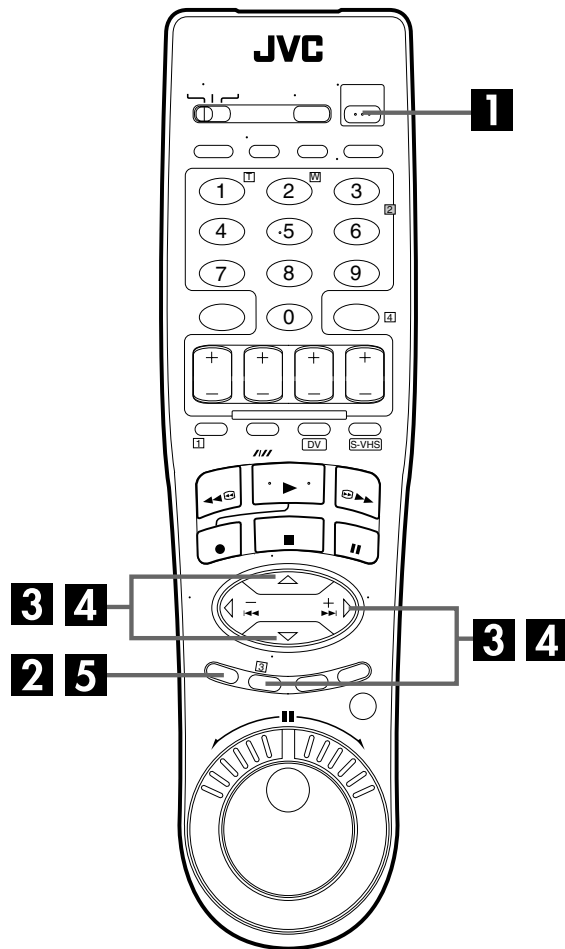

INFORMATION

The VCR selects the correct band (TV or CATV) automatically during Auto Channel Set. The selected band will be displayed on the right side of "BAND" on the Tuner Set screen.

Auto Channel Set

Perform Auto Channel Set only if channels have not been set correctly by the Plug&Play setting.

1 Turn on the VCR.

Press **POWER**.

2 Access the Main Menu screen.

Press **MENU**.

3 Access the Tuner Set screen.

Press Δ / ∇ to move the highlight bar (arrow) to "TUNER SET", then press **OK** or \triangleright .

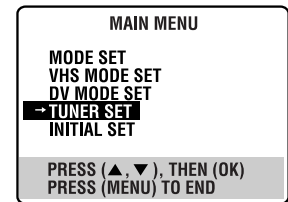

4 Perform Auto Channel Set.

Press Δ / ∇ to move the highlight bar (arrow) to "AUTO CH SET", then press **OK** or \triangleright . You can automatically set the receivable channels in your area in the order of their frequencies.

- When Auto Channel Set is complete, "SCAN COMPLETED" appears on the TV screen.
- If the scan was unsuccessful, "SCAN COMPLETED-NO SIGNAL-" appears on screen. Check the connections and start again.

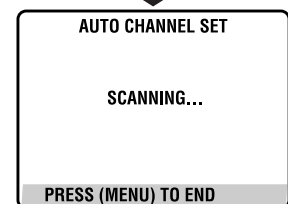
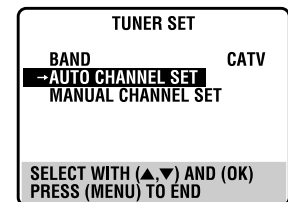

5 Return to the normal screen.

Press **MENU**.

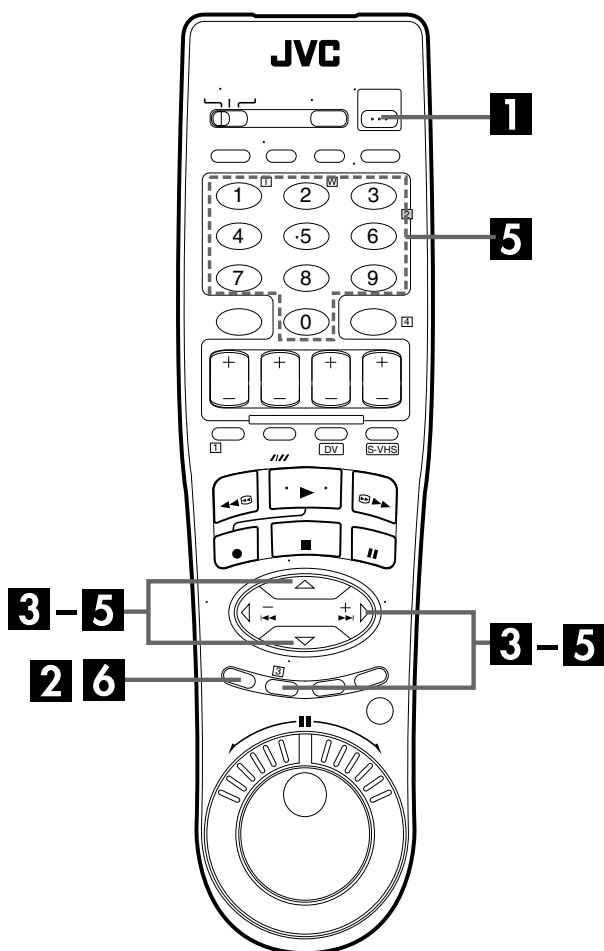

Manual Channel Set

You can add the channels you want or delete the channels you do not want manually.

1 Turn on the VCR.

Press **POWER**.

2 Access the Main Menu screen.

Press **MENU**.

3 Access the Tuner Set screen.

Press Δ / ∇ to move the highlight bar (arrow) to "TUNER SET", then press **OK** or \triangleright .

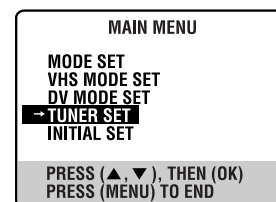

4 Access the Manual Channel Set screen.

Press Δ / ∇ to move the highlight bar (arrow) to "MANUAL CHANNEL SET", then press **OK** or \triangleright .

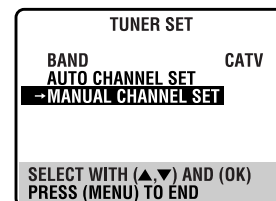

5 Add or skip the desired channels.

To add channels

- 1 Press the **number keys** to input a channel number you want to add.
- 2 Press **OK** or \triangleright to set to "ADD".
- 3 Repeat 1 to 2 to add other channels.

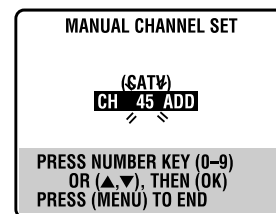

To skip channels

- 1 Press Δ / ∇ or the **number keys** to select a channel number you want to skip.
- 2 Press **OK** or \triangleright to set to "SKIP".
- 3 Repeat 1 and 2 to skip other channels.

6 Return to the normal screen.

Press **MENU**.

Cable Box Control Setting

Place the cable box on top of the VCR. Attach the VCR's Controller to the top of the VCR with the Controller's transmitter pointed towards the cable box's remote sensor.

ATTENTION:

The Controller can also control a DBS receiver. If both a cable box and a DBS receiver are used, position the Controller so its signal reaches the remote sensors of both the cable box and DBS receiver.

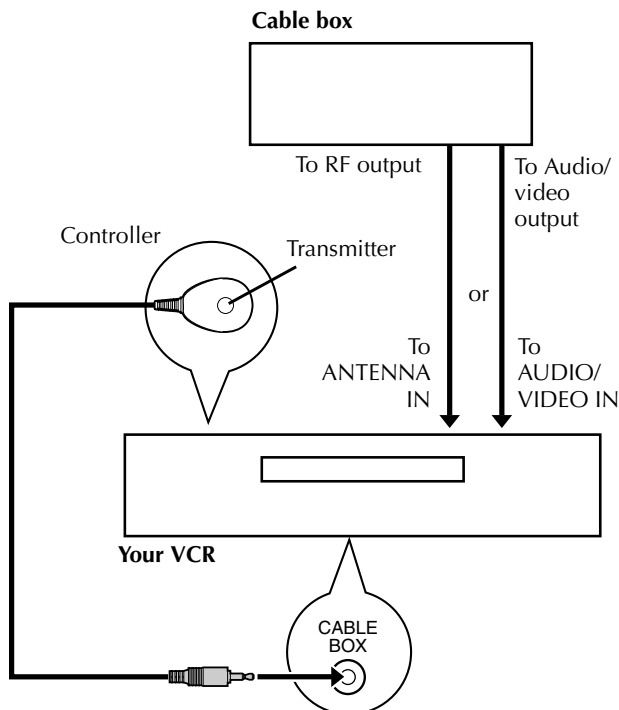
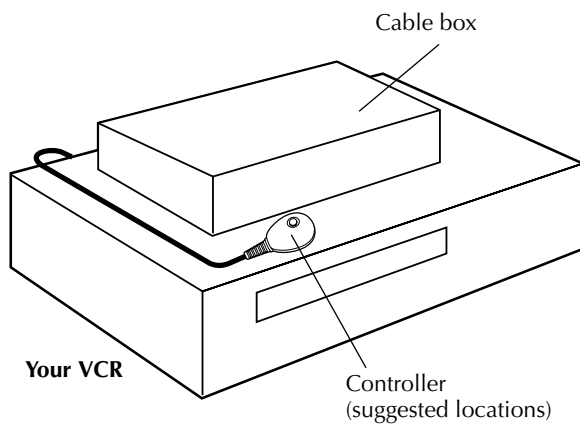

The following procedure is required if you receive your TV channels through a cable box (descrambler). The Controller allows the VCR to automatically switch the cable box channel during timer recording. The Controller is effective for recording broadcasts that have been programmed using "VCR Plus+® Timer Programming" (pg. 42) or "Express Timer Programming" (pg. 46).

Installing Controller

1 Situate the Controller.

Place the Controller so that the path between its transmitter and the cable box's remote sensor is unobstructed.

2 Attach the Controller.

Fix securely using the adhesive strip attached on the back of the Controller.

3 Make connections.

If your cable box does not have audio/video output connectors

Connect the RF output connector on the cable box to the ANTENNA IN connector on the rear of your VCR.

If your cable box has audio/video output connectors

Connect an audio/video cable between the AUDIO/VIDEO IN connectors on the rear of the VCR and the audio/video output connectors on the cable box.

NOTE:

When connecting your cable box, refer to its instruction manual.

4 Connect the Controller to VCR.

Connect the Controller to the CABLE BOX connector on the rear panel.

How to control the cable box

This VCR has two separate methods to control your cable box.

- The VCR's wireless Remote can control your cable box. This eliminates the need for a separate cable box's Remote.
- The VCR's Controller can also control your cable box. This allows the VCR to change your cable box's channel number during timer recording.

Each method must be set up separately. To set up the VCR's Remote, refer to page 68. To set up the Controller, go to page 21.

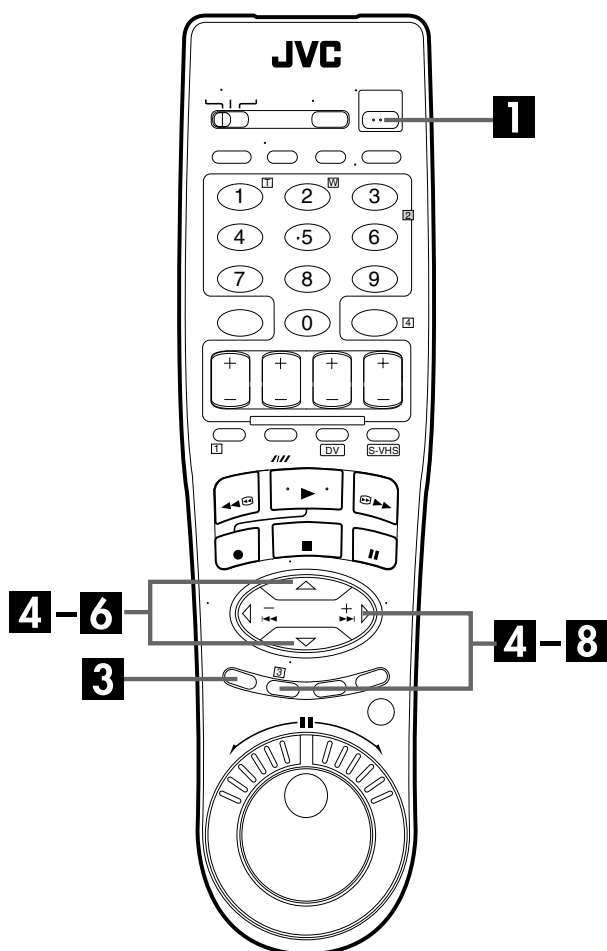

4 Access the Initial Set screen.

Press Δ / ∇ to move the highlight bar (arrow) to "INITIAL SET", then press **OK** or \triangleright .

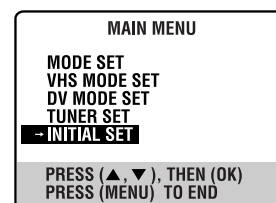

5 Access the Cable Box Set screen.

Press Δ / ∇ to move the highlight bar (arrow) to "CABLE BOX SET", then press **OK** or \triangleright .

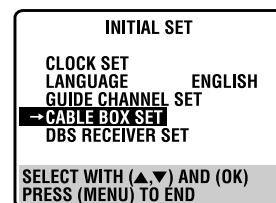

6 Select the cable box's channel.

Your selection depends on how the cable box is connected to your VCR.

If the cable box is connected to your VCR's ANTENNA IN connector on the rear panel, press Δ / ∇ until the channel number representing the cable box's output (CH2 – CH9) appears on the screen.

If the cable box is connected to your VCR's AUDIO/VIDEO IN connectors on the rear panel, press Δ / ∇ until "ON L-1 (REAR)" appears on the screen.

If you do not use a cable box, press Δ / ∇ until "OFF" appears on the screen.

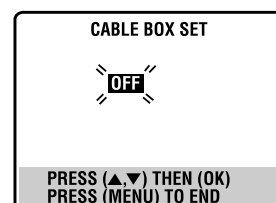

Setting cable box's brand and channel

After installation, set the cable box's brand and channel correctly; otherwise, the Controller cannot work correctly.

Turn on the TV and select the AV mode.

1 Turn on the VCR.

Press **POWER**.

2 Turn on the cable box.

Turn on the cable box's power.

3 Access the Main Menu screen on the VCR.

Press **MENU**.

7 Access the Cable Box Brand Set screen.

Press **OK** or \triangleright .

8 Enter the cable box's brand.

Press the appropriate **number keys** to enter the brand code from the following list, then press **OK** or \triangleright and "CABLE BOX CONTROL IS ON" appears on the screen for about 5 seconds, then it returns to the normal screen.

If the cable box's channel changes to 9, setting is complete. Press **OK**.

If the cable box's channel does not change to 9;

- 1 Press \triangle / ∇ to move the highlight bar (arrow) to "NO", then press **OK** or \triangleright .
- 2 Repeat step 8 until the cable box's channel changes to 9 by entering another code.
- 3 If the channel does not change after going through all the code numbers listed for your model of cable box, then try all the other numbers.

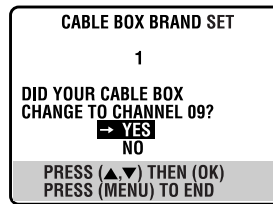
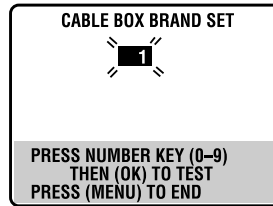

BRAND NAME	CODE
ARCHER	1, 5, 17
CABLETENNA	1, 17
CABLEVIEW	15, 16, 17, 21, 25
CITIZEN	15, 16, 17, 21, 25
CURTIS	2, 8
DIAMOND	1, 17
GC BRAND	15, 16, 17, 21, 25
GEMINI	15
GENERAL INSTRUMENTS	1, 4, 6, 11, 12, 15, 28
HAMLIN	10, 18, 23
JASCO	15
JERROLD	1, 4, 6, 11, 12, 15, 28
NOVAVISION	2, 8
OAK	7, 20
PANASONIC	13, 14
PULSER	15, 16, 17, 21, 25
RCA	13, 14
REGAL	10, 18, 23
REMBRANDT	1, 16, 17
SAMSUNG	5, 16, 24
SCIENTIFIC ATLANTA	2, 8
SIGMA	7, 20
SL MARX	5, 16, 17, 24, 25
SPRUCER	13, 14
STARGATE	5, 15, 16, 17, 21, 24, 25
TELEVIEW	5, 16, 24
TOCOM	1, 4, 16
UNIKA	1, 17
UNIVERSAL	16, 17, 25
VIDEOWAY	3, 9, 22
ZENITH	3, 9, 22

NOTES:

- The Controller may not work with all types of cable box.
- If your cable box does not respond to any code between 1 and 25, you cannot use the Controller to change cable box channels. In this case, make sure to leave the cable box turned on and tuned to the proper channel before the scheduled start time of timer recording.
Contact your cable company about the possibility of exchanging your current cable box with the one compatible with your VCR.
- The VCR can only change the cable box channel through the Controller during timer recording.
- If your cable box cannot be operated with a Remote (because it has no remote sensor), you cannot use the Controller to change its channels. Make sure to leave the cable box turned on and tuned to the proper channel before the scheduled start time of timer recording.
- If the VCR's memory backup expires because of a power failure, set the cable box output channel and brand again.
- **For customers in U.S.A.:** If you are unable to set the Controller, contact JVC toll free at 1-800-537-5722.

DBS Receiver Control Setting

Place the DBS (Direct Broadcast Satellite) receiver on top of the VCR. Attach the VCR's Controller to the top of the VCR with the Controller's transmitter pointed towards the DBS receiver's remote sensor.

ATTENTION:

The Controller can also control a cable box. If both a DBS receiver and a cable box are used, position the Controller so its signal reaches the remote sensors of both the DBS receiver and cable box.

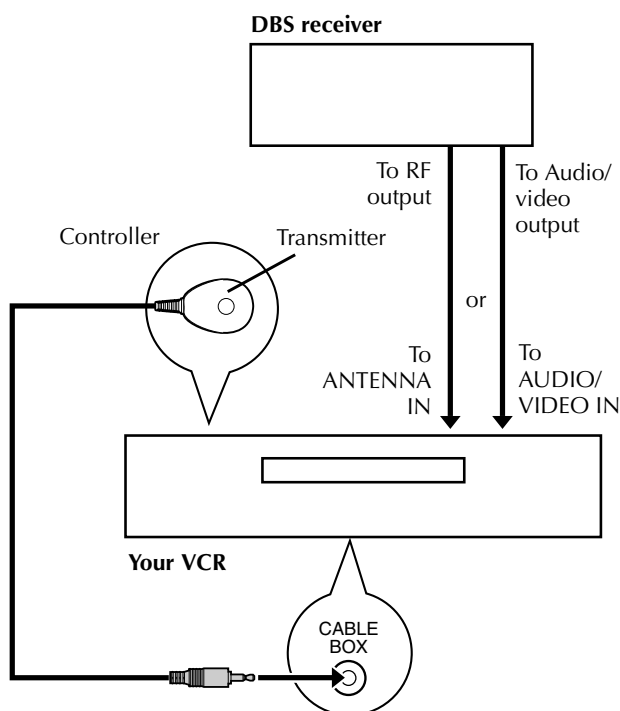
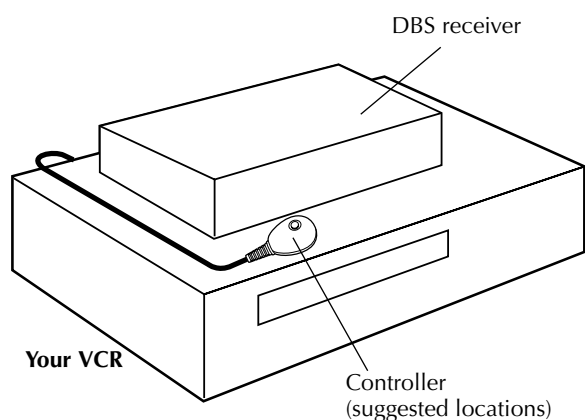

The following procedure is required if you receive satellite channels through a DBS (Direct Broadcast Satellite) receiver. The Controller allows the VCR to automatically switch the DBS receiver's channel during timer recording.

NOTES:

- The VCR can automatically change the DBS receiver channels using the Controller when the VCR has been programmed using "Express Timer Programming" (☞ pg. 46). Because satellite programming does not use PlusCode, the Controller cannot change the DBS receiver channels during "VCR Plus+™ Timer Programming" (☞ pg. 42).
- If a cable box is also used, it is recommended that you connect the DBS receiver to your VCR's audio/video input connectors and the cable box to your VCR's antenna input terminal.

Installing Controller

1 Situate the Controller.

Place the Controller so that the path between its transmitter and the DBS receiver's remote sensor is unobstructed.

2 Attach the Controller.

Fix securely using the adhesive strip attached on the back of the Controller.

3 Make connections.

If your DBS receiver does not have audio/video output connectors

Connect the RF output terminal on the DBS receiver to the ANTENNA IN connector on the rear of your VCR.

If your DBS receiver has audio/video output connectors

Connect an audio/video cable between the AUDIO/VIDEO IN connectors on the rear of the VCR and the audio/video output connectors on the DBS receiver.

NOTE:

When connecting your DBS receiver, refer to its instruction manual.

4 Connect the Controller to VCR.

Connect the Controller to the CABLE BOX connector on the rear panel.

How to control the DBS receiver

This VCR has two separate methods to control your DBS receiver.

- The VCR's wireless Remote can control your DBS receiver. This eliminates the need for a separate DBS receiver's Remote.
- The VCR's Controller can also control your DBS receiver. This allows the VCR to change your DBS receiver's channel number during timer recording.

Each method must be set up separately. To set up the VCR's Remote, refer to page 69. To set up the Controller, go to page 24.

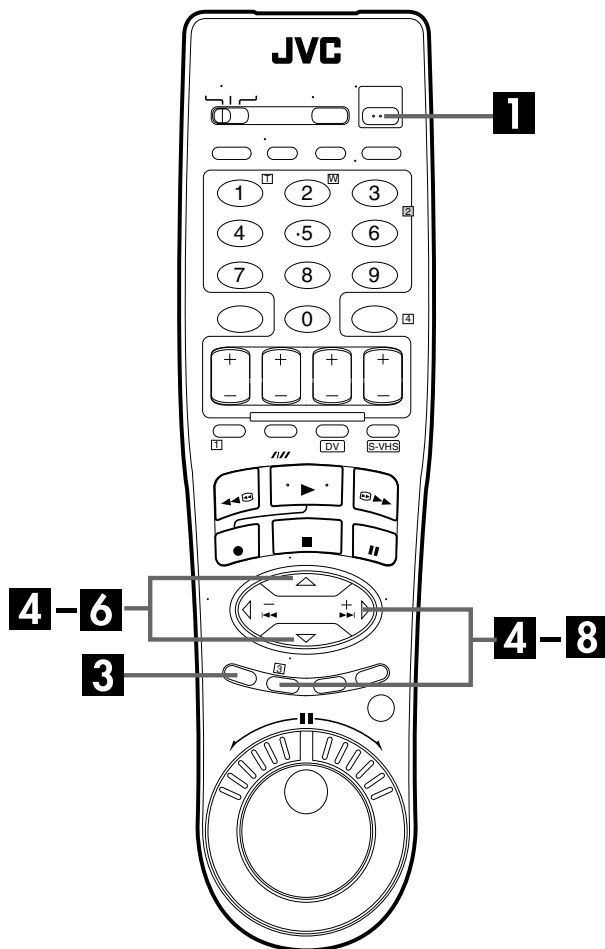

4 Access the Initial Set screen.

Press Δ / ∇ to move the highlight bar (arrow) to "INITIAL SET", then press **OK** or \triangleright .

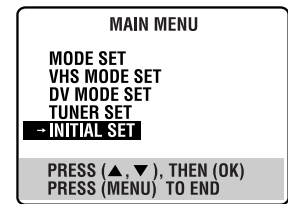

5 Access the DBS Receiver Set screen.

Press Δ / ∇ to move the highlight bar (arrow) to "DBS RECEIVER SET", then press **OK** or \triangleright .

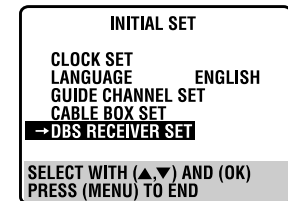

6 Select the DBS receiver's channel.

Your selection depends on how the DBS receiver is connected to your VCR.

If the DBS receiver is connected to your VCR's ANTENNA IN connector on the rear panel, press Δ / ∇ until the channel number representing the DBS receiver's output (CH3 or CH4) appears on the screen.

If the DBS receiver is connected to your VCR's AUDIO/VIDEO IN connectors on the rear panel, press Δ / ∇ until "ON L-1 (REAR)" appears on the screen.

If you do not use a DBS receiver, press Δ / ∇ until "OFF" appears on the screen.

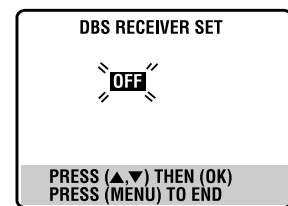

Setting DBS receiver's brand and channel

After installation, set the DBS receiver's brand and channel correctly; otherwise, the Controller cannot work correctly.

Turn on the TV and select the AV mode.

1 Turn on the VCR.

Press **POWER**.

2 Turn on the DBS receiver.

Turn on the DBS receiver's power.

3 Access the Main Menu screen on the VCR.

Press **MENU**.

7 Access the DBS Receiver Brand Set screen.

Press **OK** or \triangleright .

8 Enter the DBS receiver's brand.

Press the appropriate **number keys** to enter the brand code from the following list, then press **OK** or \triangleright .

The program currently received through the DBS receiver appears for about 10 seconds.

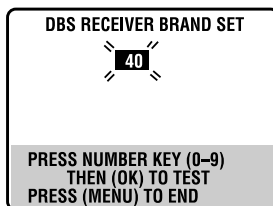

BRAND NAME	CODE
JVC (DISH Network)	51
ECHOSTAR (DISH Network)	51
SONY (DSS)	41
RCA (DSS)	40

If the DBS receiver's channel changes to the channel listed below for your brand, setting is complete.

JVC \rightarrow 100

ECHOSTAR \rightarrow 100

SONY \rightarrow 205

RCA \rightarrow 205

Press **OK** or \triangleright and "DBS RECEIVER CONTROL IS ON" appears on the screen for about 5 seconds, then it returns to the normal screen.

If the DBS receiver's channel does not change as shown above;

1 Press \triangle / ∇ to move the highlight bar (arrow) to "NO", then press **OK** or \triangleright .

2 Repeat step 8.

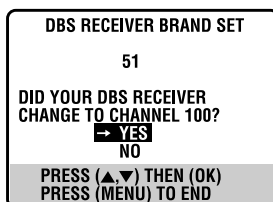

NOTES:

- The Controller may not work with all types of DBS receiver.
- If your DBS receiver does not respond to the code, you cannot use the Controller to change satellite channels. In this case, make sure to leave the DBS receiver turned on and tuned to the proper channel before the scheduled start time of timer recording.
- The VCR can only change the satellite channel through the Controller during timer recording.
- If your DBS receiver cannot be operated with a Remote (because it has no remote sensor), you cannot use the Controller to change its channels. Make sure to leave the DBS receiver turned on and tuned to the proper channel before the scheduled start time of timer recording.
- If the VCR's memory backup expires because of a power failure, set the cable box output channel and brand again.
- **For customers in U.S.A.:** If you are unable to set the Controller, contact JVC toll free at 1-800-537-5722.

Basic Playback

(VHS deck)

Turn on the TV and select the AV mode.

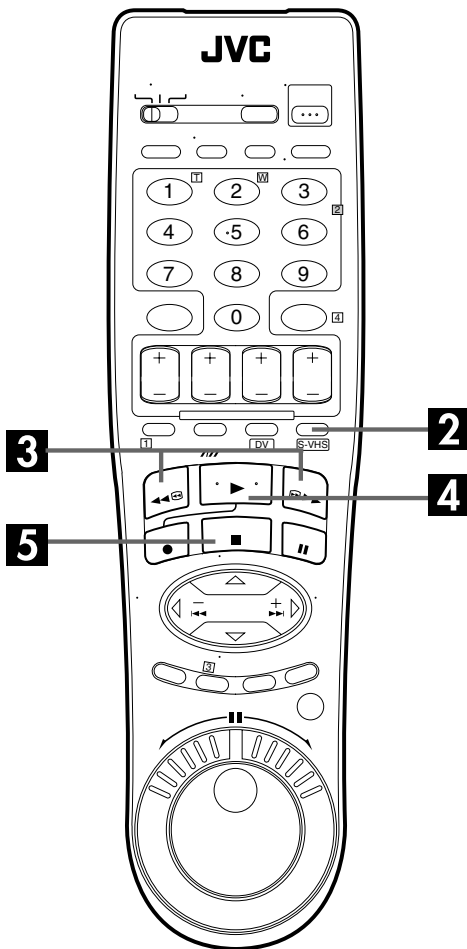
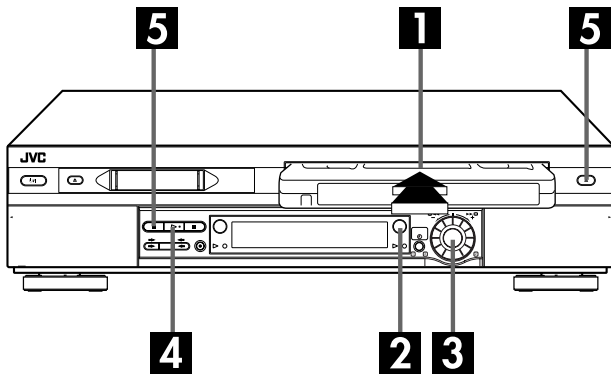

1 Load a cassette.

Make sure the window side is up, the rear label side is facing you and the arrow on the front of the cassette is pointed toward the VCR.

- Do not apply too much pressure when inserting.
- The VCR's power comes on automatically.
- If the record safety tab has been removed, playback begins automatically.

2 Select the VHS deck.

Press **S-VHS**.

- The S-VHS button lights on the VCR.

3 Find the program start point.

If the tape is advanced past the start point, press **REW** (◀◀) or turn the **ADVANCED JOG** dial on the VCR to the left. To go forward, press **FF** (▶▶) or turn the **ADVANCED JOG** dial on the VCR to the right.

4 Start playback.

Press **PLAY** (▶). "VIDEO CALIBRATION" appears blinking on the TV screen during automatic tracking. (☞ pg. 35)

- The VHS playback indicator lights on the VCR.

5 Stop playback.

Press **STOP** (■). Then press **EJECT** (▲) to remove the cassette.

- The VHS playback indicator turns off.

NOTE:

It is impossible to play back a tape on the VHS deck while the recording is in progress on the DV deck. When you start recording on the DV deck during playback on the VHS deck, playback stops on the VHS deck and recording continues on the DV deck.

Usable cassettes

Full-Size VHS

T-30 (ST-30**)
T-60 (ST-60**)
T90
T-120 (ST-120**)
T-160 (ST-160**)
ST-210**

Compact VHS*

TC-20 (ST-C20**)
TC-30 (ST-C30**)
TC-40 (ST-C40**)

* Compact VHS camcorder recordings can be played on this VCR. Simply place the recorded cassette into a VHS Cassette Adapter and it can be used just like any full-sized VHS cassette.

**This VCR can record on regular VHS and Super VHS cassettes. While only VHS signals can be recorded on regular VHS cassettes¹⁾, both VHS and Super VHS signals can be recorded and played back using Super VHS cassettes.

1)By using the S-VHS ET function, it is possible to record and play back with S-VHS picture quality on VHS cassettes with this VCR.

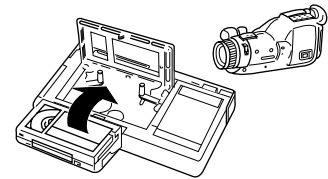

Basic Recording

(VHS deck)

Turn on the TV and select the AV mode.

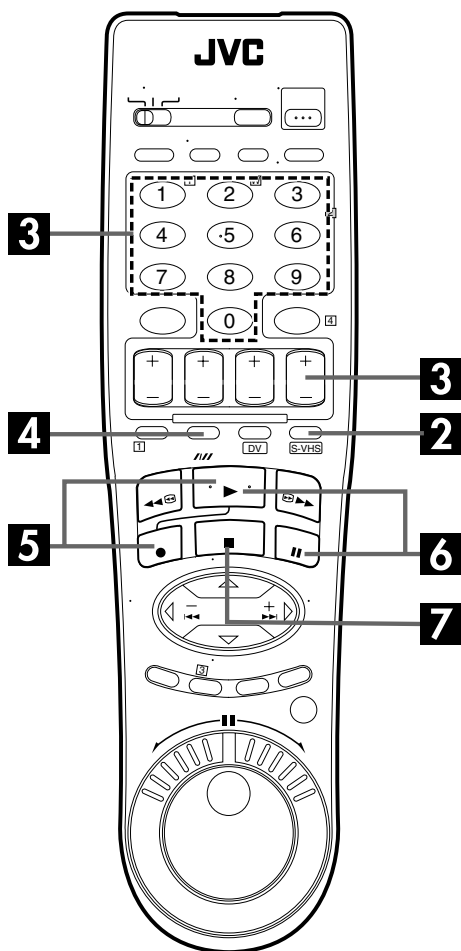
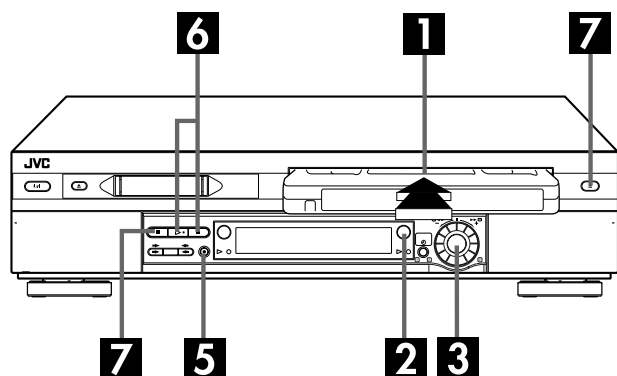

1 Load a cassette.

Insert a VHS (or S-VHS) cassette with the record safety tab intact.

- The VCR's power comes on automatically.

2 Select the VHS deck.

Press **S-VHS**.

- The S-VHS button lights on the VCR.

3 Choose a program.

On the Remote

Press **CH +/-** or the **number keys**.

On the VCR

Push the **ADVANCED JOG** dial and turn it to the left or right to select the channel you wish to record.

4 Set the tape speed.

Press **SP/EP (//)**. Check the SP/EP indicator on the VCR's front display panel to confirm the selected tape speed.

5 Start recording.

Press and hold **REC (●)** and press **PLAY (▶)** on the Remote, or press **REC (●)** on the VCR.

- The VHS recording indicator lights on the VCR.

Video Calibration takes place at the beginning of both the first SP and the first EP recording after inserting the cassette. (pg. 35)

6 Pause/Resume recording.

Press **PAUSE (||)**. Press **PLAY (▶)** to resume recording.

- You can select channel during the Record Pause mode.

7 Stop recording.

Press **STOP (■)**. Then press **EJECT (▲)** to remove the cassette.

- The VHS recording indicator turns off.

NOTE:

It is not possible to record a TV program on both the VHS deck and the DV deck simultaneously. In addition, it is not possible to record simultaneously from the same external input.

Playback Features

(VHS deck)

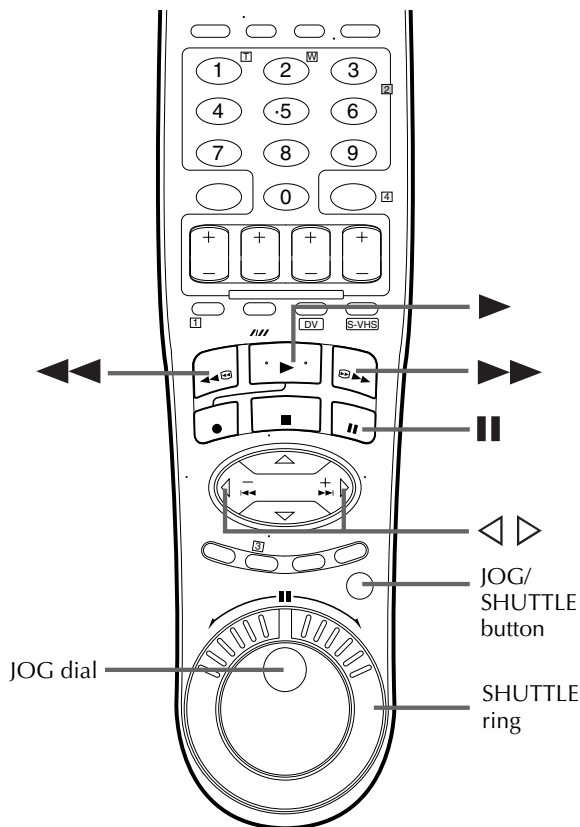
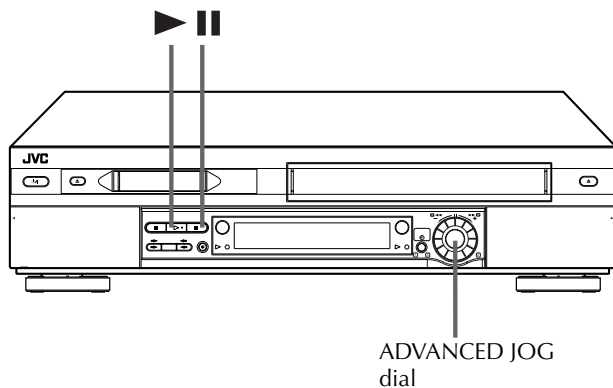

Clean the video heads using a dry cleaning cassette — TCL-2 — when:

- Rough, poor picture appears while a tape is played back.
- The picture is unclear or no picture appears.
- "USE CLEANING CASSETTE" appears on the screen (only with "SUPERIMPOSE" set to "ON" (pg. 71)). "U:01" appears on the front display panel.

Still Picture/Frame-By-Frame Playback (On the VCR)

1 Pause during playback.

Push the ADVANCED JOG dial.

OR

Press PAUSE (II).

2 Activate frame-by-frame playback.

Turn the ADVANCED JOG dial to the right for forward frame-by-frame playback, or to the left for reverse frame-by-frame playback.

OR

Press PAUSE (II) to advance a still picture.

NOTE:

Still picture playback stops automatically after 5 minutes to protect the heads.

To resume normal playback, press PLAY (▶) or push the ADVANCED JOG dial.

Slow Motion (On the VCR)

During playback, turn the ADVANCED JOG dial one click to the left for forward slow motion. To play in reverse slow motion, continue to turn the ADVANCED JOG dial to the left after selecting all the forward direction slow motion modes.

OR

During still picture, press and hold PAUSE (II) for more than 2 seconds, then release. Press PAUSE (II) and release again to return to still picture.

NOTES:

- During slow motion, some noise may appear on the TV screen. Press CH+/- to eliminate the noise. However, the VCR will return to the default setting once a power failure occurs.
- Slow motion playback stops automatically after 5 minutes to protect the heads.

High-Speed (Turbo) Search (On the VCR)

During playback, turn the ADVANCED JOG dial quickly to the left or right.

Variable Speed Search (On the VCR)

During playback, turn the ADVANCED JOG dial to the right for forward variable-speed search, or to the left for reverse variable-speed search.

To resume normal playback, press PLAY (▶).

Still Picture/Frame-By-Frame Playback (On the Remote)

1 Pause during playback.

Press **PAUSE** (II).

2 Activate frame-by-frame playback.

Press **JOG/SHUTTLE** so that the button lights up. Turn the **JOG** dial to the right for forward frame-by-frame playback, or to the left for reverse frame-by-frame playback.

OR

Press **PAUSE** (II) to advance a still picture.

OR

Press ◀ for reverse frame-by-frame playback or ▶ for forward frame-by-frame playback.

NOTE:

Still picture playback stops automatically after 5 minutes to protect the heads.

Slow Motion (On the Remote)

Press **JOG/SHUTTLE** so that the button lights up. During playback or still, turn the **SHUTTLE** ring to the right for forward slow motion, or to the left for reverse slow motion. Release to return to still picture.

OR

During still picture, press and hold **PAUSE** (II) for more than 2 seconds, then release. Press **PAUSE** (II) and release again to return to still picture.

OR

During still picture, press and hold ◀ or ▶. Release to return to still picture.

NOTES:

- During slow motion, some noise may appear on the TV screen. Press **CH+/-** to eliminate the noise. However, the VCR will return to the default setting once a power failure occurs.
- Slow motion playback stops automatically after 5 minutes to protect the heads.

To resume normal playback, press **PLAY** (▶).

You can also use the Remote's **JOG** dial/**SHUTTLE** ring for the operations. First press the **JOG/SHUTTLE** button on the Remote so that the button lights up before use. Refer to the **SHUTTLE** ring illustration below as you read the procedures.

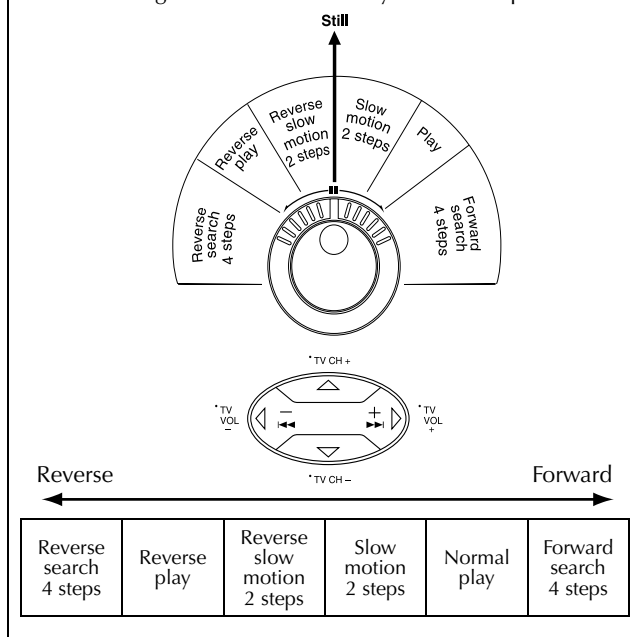

High-Speed (Turbo) Search (On the Remote)

Press **JOG/SHUTTLE** so that the button lights up. During playback or still, turn the **SHUTTLE** ring all the way to the right for forward high-speed search, or to the left for reverse high-speed search. Releasing **SHUTTLE** ring resumes still picture playback.

OR

During playback or still, press **FF** (▶▶) for forward high-speed search, or **REW** (◀◀) for reverse high-speed search.

NOTE:

For short searches, press and hold **FF** (▶▶) or **REW** (◀◀) for over 2 seconds during playback or still picture. When released, normal playback resumes.

Variable Speed Search (On the Remote)

Press **JOG/SHUTTLE** so that the button lights up. During playback or still, turn the **SHUTTLE** ring to the right for forward variable-speed search, or to the left for reverse variable-speed search.

OR

During playback, press ◀ or ▶.

- The more times you press, the faster the playback picture moves.
- To decrease speed, press the button for the opposite direction.

To resume normal playback, press **PLAY** (▶).

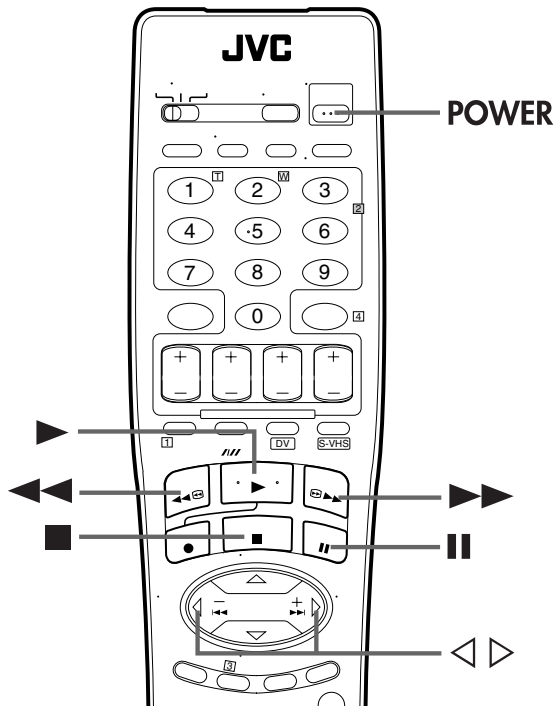
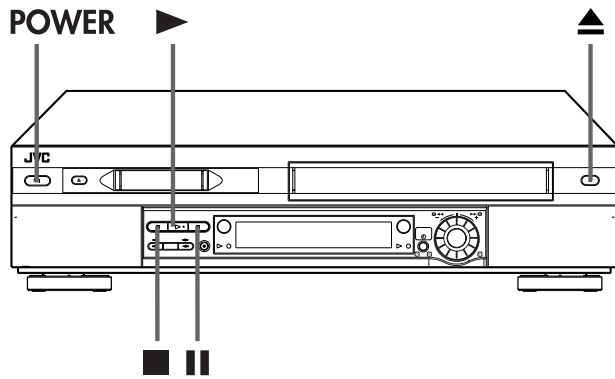

Repeat Playback

Your VCR can automatically play back the whole tape 100 times repeatedly.

1 Start playback.

Press **PLAY** (▶).

2 Activate Repeat Playback.

Press **PLAY** (▶) and hold for over 5 seconds, then release.

- The Play indicator (▶) on the front display panel blinks slowly.
- After playing back a tape 100 times, the VCR stops automatically.

3 Stop Repeat Playback.

Press **STOP** (■) at any time.

- Pressing **PLAY** (▶), **REW** (◀◀), **FF** (▶▶) or **PAUSE** (||) also stops Repeat Playback.

Index Search

Your VCR automatically marks index codes at the beginning of each recording. This function gives you quick access to any one of 9 index codes in either direction.

NOTE:

Before starting, make sure the VCR is in the Stop mode.



Activate Index Search.

Press ◀ or ▶ (◀◀ or ▶▶). "INDEX -1" or "INDEX 1" is displayed on the TV screen and search begins in the corresponding direction.

- To access index codes 2 through 9, press ◀ or ▶ repeatedly until the correct index number is displayed.

Example:

To locate the beginning of B from the current position, press ◀ twice.

To locate the beginning of D from the current position, press ▶ once.

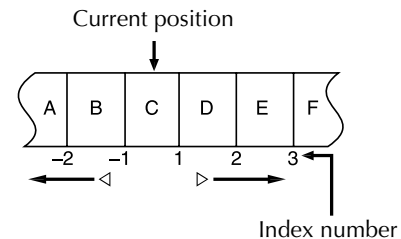

- When the specified index code is located, playback begins automatically.

Next Function Memory

The Next Function Memory "tells" the VCR what to do after rewinding. Before continuing, make sure the VCR is in the Stop mode.

- For Automatic Start Of Playback
Press **REW** (◀◀), then press **PLAY** (▶) within 2 seconds.
- For Automatic Power Off
Press **REW** (◀◀), then press **POWER** within 2 seconds.
- For Automatic Cassette Ejection After Tape Rewind
Press **REW** (◀◀), then press **EJECT** (▲) within 2 seconds.

NOTE:

The Automatic Power Off does not work if "AUTO TIMER" is set to "ON" (pg. 71) and if any timer programming has been made. If "AUTO TIMER" is set to "ON", the VCR directly goes into the Timer-Standby mode at the same time when the **POWER** is pressed for the Automatic Power Off.

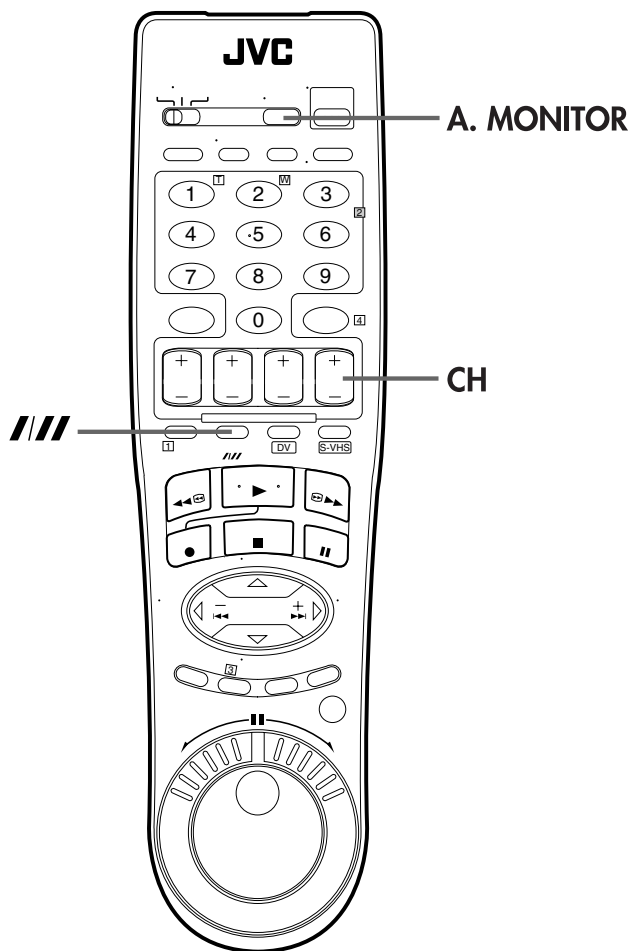

Manual Tracking

Your VCR is equipped with automatic tracking control. During playback, you can override this and adjust the tracking manually by pressing the **CH** buttons.

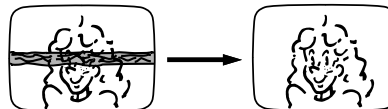

1 Override automatic tracking.

Press **///** on the Remote.

2 Adjust the tracking manually.

Press **CH +** or **-**.

- Press **///** again to return to automatic tracking.

NOTE:

When a new tape is inserted, the VCR enters the automatic tracking mode automatically.

Soundtrack Selection

Your VCR is capable of recording three soundtracks (HI-FI L, HI-FI R and NORM) and will play back the one you select.

During Playback

Pressing **A. MONITOR** changes the soundtrack as follows:

- You can also select the soundtrack on the VHS MODE SET screen. (☞ pg. 75, "AUDIO MONITOR")

TRACK	USE
On-Screen Display	
H I-F I	Hi-Fi sound is played back
H I-F I L	Sound on the left Hi-Fi channel is played back
H I-F I R	Sound on the right Hi-Fi channel is played back
NORM	Sound on the normal track is played back
NORM H I-F I	Both sounds on the Hi-Fi track and normal track are mixed and played back

NOTES:

- "HI-FI" should normally be selected. In this mode, Hi-Fi stereo tapes are played back in stereo, and the normal audio track is played back automatically for tapes with only normal audio.
- "SUPERIMPOSE" must be set to "ON" or the on-screen displays will not appear (☞ pg. 71).

Recording Features

(VHS deck)

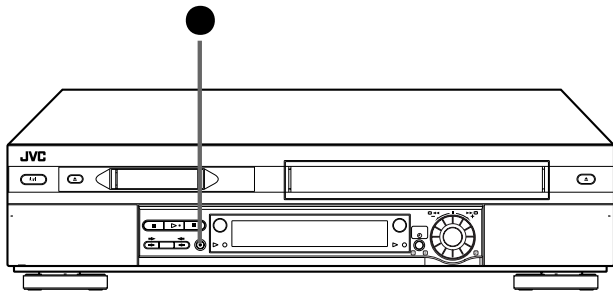

Recording Resume Function

If there is a power outage during recording, Instant Timer Recording (in the right column) or timer recording (pg. 42, 46, 48), the recording will resume automatically when power is restored to the VCR unless the VCR's memory backup has expired.

Accidental erasure prevention

To prevent accidental recording on a recorded cassette, remove its safety tab. To record on it later, cover the hole with adhesive tape.

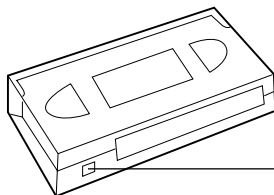

Record safety tab

Record One Program While Watching Another

Once recording is in progress, all you need to do is to set the channel controls on the TV for the station you wish to view.

- The program selected with the TV's channel controls appears on the TV screen, while the one selected with the VCR's **CH** buttons is recorded on the tape.

Instant Timer Recording (ITR)

This easy method lets you record for from 30 minutes to 6 hours (selectable in 30-min. increments), and shuts the VCR off after recording is finished.

1 Start recording.

Press **REC** (●) on the VCR.

2 Engage the ITR mode.

Press **REC** (●) again. "○" blinks and "0:30" appears on the front display panel.

3 Set the recording duration.

If you want to record for more than 30 minutes, press **REC** (●) to extend the time. Each press extends recording time by 30 minutes.

NOTES:

- You can only perform ITR using the **REC** (●) button on the VCR's front panel.
- You can play back a tape on DV deck while using the VHS deck for Instant Timer Recording. However, remember that the VCR will turn itself off when the Instant Timer Recording ends.

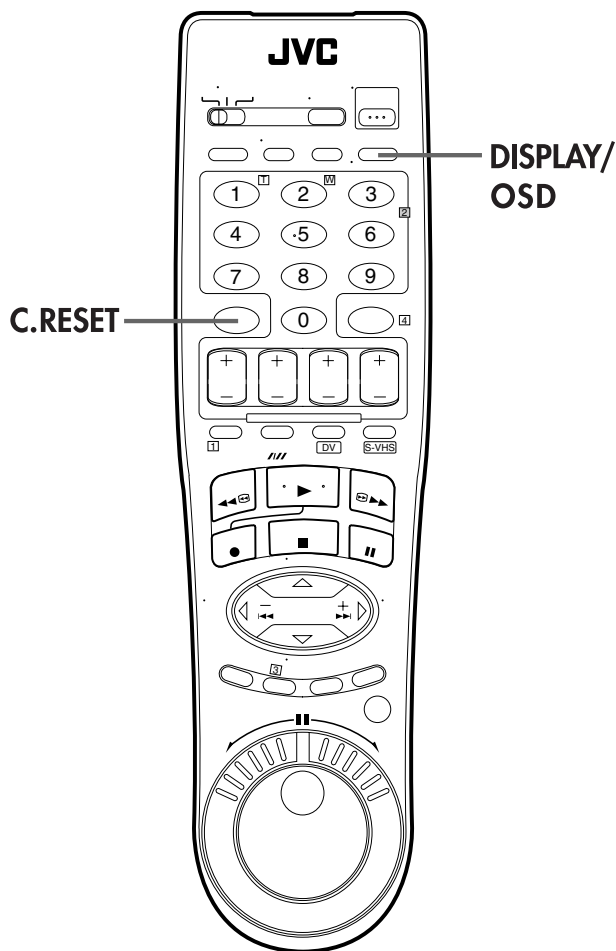

Elapsed Recording Time Indication

1 Set the counter display.

Press **DISPLAY/OSD** until a counter reading appears on the front display panel.

2 Reset the counter.

Press **C.RESET** before starting recording or playback.

- The counter is reset to "0:00:00" and shows the exact elapsed time as the tape runs. You can check the exact time of a recording or playback.

Tape Remaining Time

Press **DISPLAY/OSD** until the time remaining on the tape appears on the front display panel.

- The front display panel shows the tape remaining time with "▶" displayed.
- By pressing the **DISPLAY/OSD** button, you can change the display to show the counter reading, tape remaining time, channel position* or clock time.
 - * Channel position is not displayed during playback.

NOTES:

- When you press **DISPLAY/OSD**, the on-screen display appears (pg. 10) on the TV screen for 5 seconds, then the displays other than the counter disappears. To clear the counter display, press **DISPLAY/OSD**.
- Depending on the type of tape being used, the tape remaining time reading may not appear right away, or is not correct. "--:--" may sometimes appear, or the display may blink on occasion.

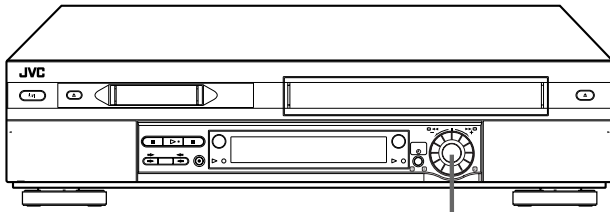

ADVANCED JOG dial

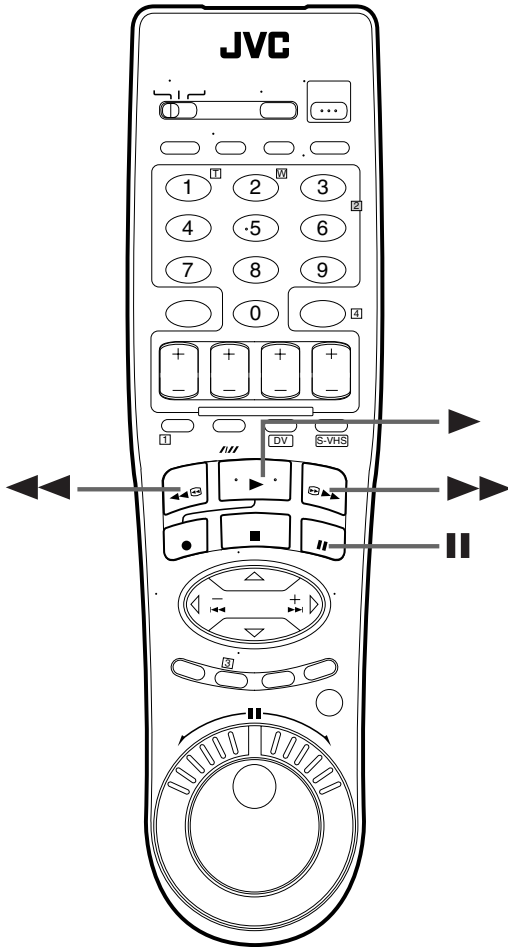

Retake

You can cut out unnecessary parts of a TV program while you are recording it.

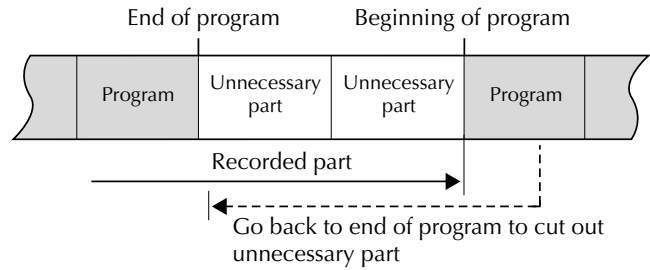

1 Engage the Record-Pause mode.

Press **PAUSE** (II) during recording.

2 Locate the start point.

Turn the **ADVANCED JOG** dial to the left or right (or hold down **REW** (◀◀) or **FF** (▶▶)) and release it when you reach the point where you want to resume recording.

- Your VCR returns to the Record-Pause mode.

3 Resume recording.

Press **PLAY** (▶) when you wish to resume recording.

Second Audio Recording

This VCR's built-in MTS decoder enables reception of Multichannel TV Sound broadcast. To record a SAP program received, set "2ND AUDIO RECORD" to "ON". (pg. 71)

NOTES:

When the channel is changed on the VCR;

- The "STEREO" indicator appears on the screen for about 5 seconds if the program is a stereo broadcast.
- The "SAP" indicator appears on the screen for about 5 seconds if the program is a SAP broadcast.
- Both indicators appear when a stereo program is accompanied by SAP sound.

Active Video Calibration

(VHS deck)

Active Video Calibration checks the condition of the tape in use during playback and recording, and compensates to provide the highest-possible playback and recording pictures. You can set "VIDEO CALIBRATION" to "ON" or "OFF" to your preference (☞ pg. 73).

Playback

The VCR assesses the quality of the tape once you initiate playback.

- The VCR adjusts the playback picture quality based on the quality of the tape in use.
- Video Calibration is active during automatic tracking. The Video Calibration screen appears blinking on the TV screen.



NOTES:

- When watching a tape recorded with "VIDEO CALIBRATION" set to "ON", it is recommended that you leave VIDEO CALIBRATION on during playback as well.
- When watching a rental tape or one recorded on another VCR, or when using this VCR as the player for editing, set VIDEO CALIBRATION to your preference (☞ pg. 73).
- The Video Calibration screen only appears at the beginning of automatic tracking. Even though it doesn't appear after that, the Video Calibration function is operative.

Recording

The VCR assesses the quality of the tape once you initiate recording.

- The VCR spends approximately 7 seconds assessing the condition of the tape, then begins recording.

NOTES:

- The Video Calibration works for both SP and EP modes only after a tape has been inserted and the Record mode is first initiated. It does not work during recording.
- In the case of timer recordings, the Video Calibration works before recording is initiated.
- Once the cassette is ejected, the Video Calibration data is cancelled. The next time the cassette is used for recording, Video Calibration is re-performed.

DURING VIDEO CALIBRATION

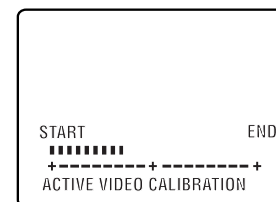

VIDEO CALIBRATION COMPLETE

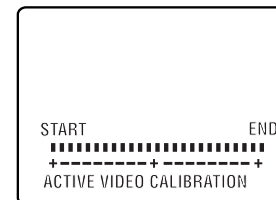

ATTENTION

Since the Video Calibration works before recording actually starts, there is a delay of approximately 7 seconds after **REC** (●) and **PLAY** (▶) on the Remote are pressed, or **REC** (●) on the VCR is pressed. To make sure you record the desired scene or program in its entirety, first perform the following steps:

- 1 Press and hold **PAUSE** (||) and press **REC** (●) to engage the Record Pause mode.
- The VCR then automatically checks the condition of the tape and, after approximately 7 seconds, re-enters Record Pause mode.
- 2 Press **PLAY** (▶) to start recording.

If you want to bypass the Video Calibration and begin recording immediately, set "VIDEO CALIBRATION" to "OFF" (☞ pg. 73).

Basic Playback

(DV deck)

Turn on the TV and select the AV mode.

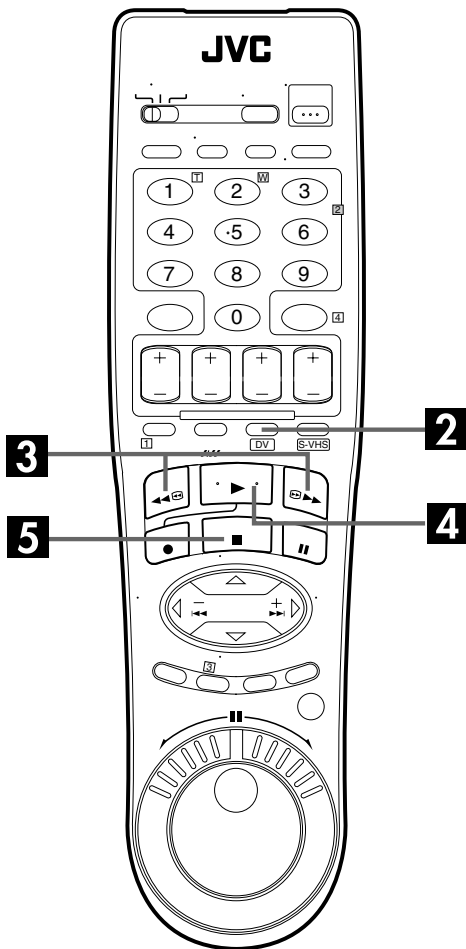
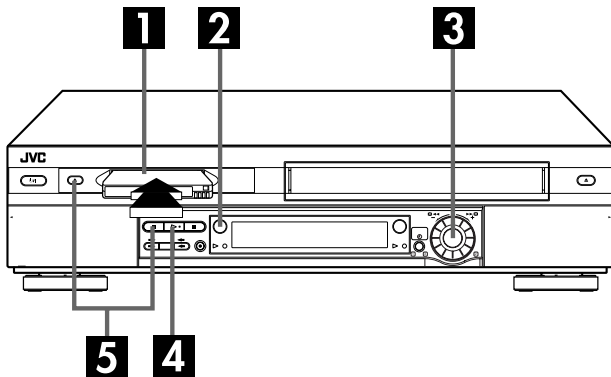

1 Load a cassette.

Make sure the window side is up, the rear label side is facing you and the arrow on the front of the cassette is pointed toward the VCR.

- Do not apply too much pressure when inserting.
- The VCR's power comes on automatically.
- If the erase protection switch is set to "SAVE", playback begins automatically. It takes about 15 seconds until the playback picture appears.

2 Select the DV deck.

Press **DV**.

- The DV button lights on the VCR.

3 Find the program start point.

If the tape is advanced past the start point, press **REW** (◀◀) or turn the **ADVANCED JOG** dial to the left. To go forward, press **FF** (▶▶) or turn the **ADVANCED JOG** dial to the right.

4 Start playback.

Press **PLAY** (▶).

- The DV playback indicator lights on the VCR.

5 Stop playback.

Press **STOP** (■). Then press **EJECT** (▲) to remove the cassette.

- The DV playback indicator turns off.

Usable cassettes

Only cassettes marked **Mini DV NTSC** can be used with the DV deck.

NOTE:

When you record a tape on the DV deck with the recording speed set to "LP", it is recommended to play back the tape on this DV deck. Digital video recorder from other manufacturers may not be able to play back the tape properly.

Basic Recording

(DV deck)

Turn on the TV and select the AV mode.

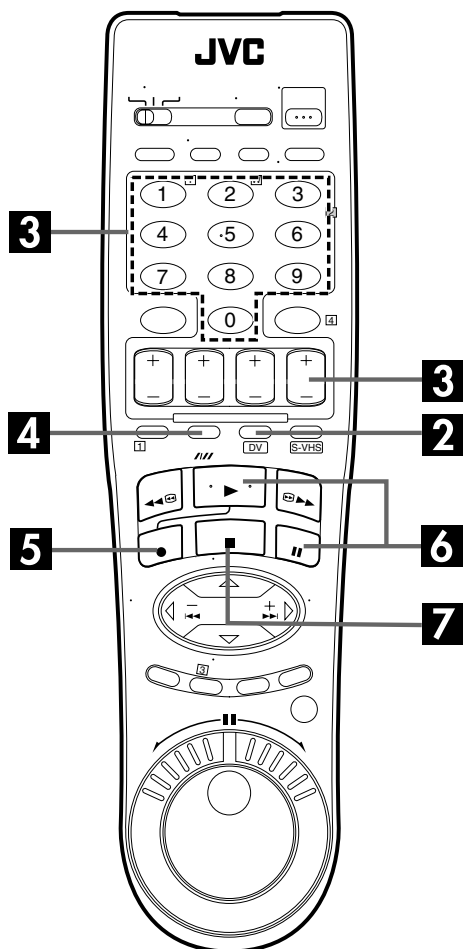
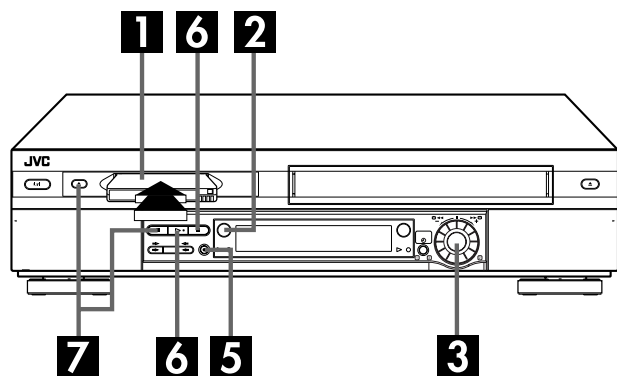

1 Load a cassette.

Insert a Mini DV cassette with the erase protection switch set to "REC".

- The VCR's power comes on automatically.

2 Select the DV deck.

Press **DV**.

- The DV button lights on the VCR.

3 Choose a program.

On the Remote

Press **CH +/-** or the **number keys**.

On the VCR

Push the **ADVANCED JOG** dial and turn it to the left or right to select the channel you wish to record.

4 Set the tape speed.

Press **SP/LP (//)**. Check the SP/LP indicator on the VCR's front display panel to confirm the selected tape speed.

5 Start recording.

Press and hold **REC (●)** and press **PLAY (▶)** on the Remote, or press **REC (●)** on the VCR.

- The DV recording indicator lights on the VCR.

6 Pause/Resume recording.

Press **PAUSE (||)**. Press **PLAY (▶)** to resume recording.

- You can select channel during the Record Pause mode.

7 Stop recording.

Press **STOP (■)**. Then press **EJECT (▲)** to remove the cassette.

- The DV recording indicator turns off.

NOTES:

- It is not possible to record a TV program on both the VHS deck and the DV deck simultaneously. In addition, it is not possible to record simultaneously from the same external input.
- When you record a tape on the DV deck with the recording speed set to "LP", it is recommended to play back the tape on this DV deck. Digital video recorder from other manufacturers may not be able to play back the tape properly.

Playback Features

(DV deck)

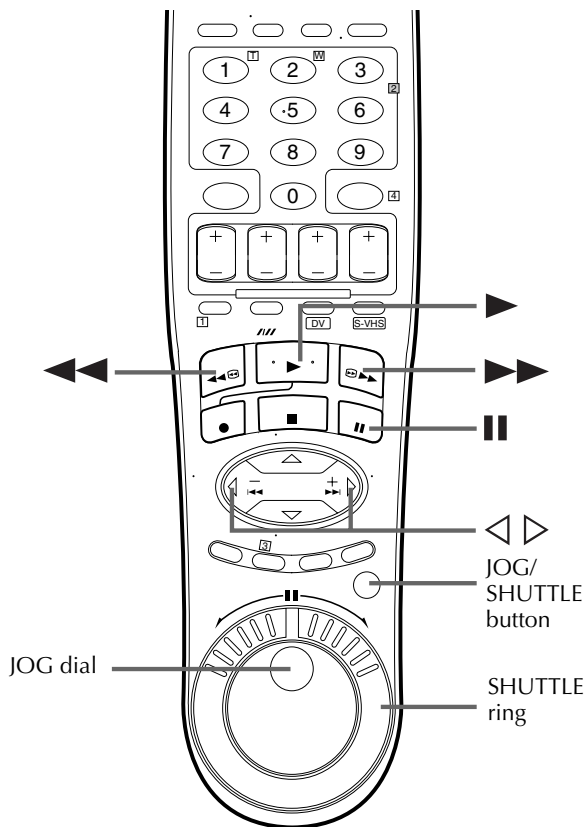
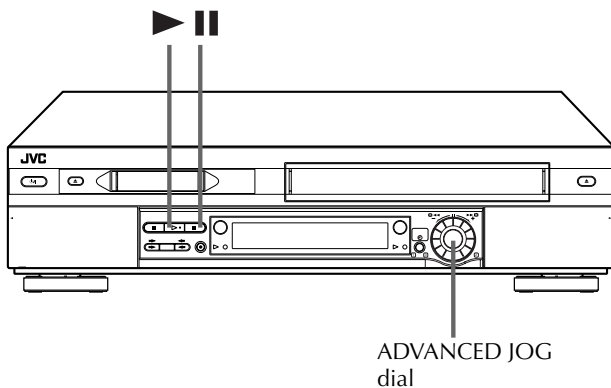

ATTENTION

Picture may appear distorted during variable speed search.

Clean the video heads using a dry cleaning cassette — M-DV12CL — when:

- No picture during playback.
- Blocks of noise appear during playback.
- "USE CLEANING CASSETTE" appears on the screen (only with "SUPERIMPOSE" set to "ON" (pg. 71)).

Still Picture/Frame-By-Frame Playback (On the VCR)

1 Pause during playback.

Push the ADVANCED JOG dial.

OR

Press PAUSE (II).

2 Activate frame-by-frame playback.

Turn the ADVANCED JOG dial to the right for forward frame-by-frame playback, or to the left for reverse frame-by-frame playback.

OR

Press PAUSE (II) to advance a still picture.

NOTE:

Still picture playback stops automatically after 3 minutes to protect the heads.

To resume normal playback, press PLAY (▶) or push the ADVANCED JOG dial.

Slow Motion (On the VCR)

During playback, turn the ADVANCED JOG dial one click to the left for forward slow motion. To play in reverse slow motion, continue to turn the ADVANCED JOG dial to the left.

OR

During still picture, press and hold PAUSE (II) for more than 2 seconds, then release. Press PAUSE (II) and release again to return to still picture.

NOTE:

Forward slow motion playback stops automatically after 1 minute, reverse slow motion playback after 30 seconds to protect the heads.

High-Speed (Turbo) Search (On the VCR)

During playback, turn the ADVANCED JOG dial quickly to the left or right.

Variable Speed Search (On the VCR)

During playback, turn the ADVANCED JOG dial to the right for forward variable-speed search, or to the left for reverse variable-speed search.

To resume normal playback, press PLAY (▶).

Still Picture/Frame-By-Frame Playback (On the Remote)

1 Pause during playback.

Press **PAUSE** (II).

2 Activate frame-by-frame playback.

Press **JOG/SHUTTLE** so that the button lights up. Turn the **JOG** dial to the right for forward frame-by-frame playback, or to the left for reverse frame-by-frame playback.

OR

Press **PAUSE** (II) to advance a still picture.

OR

Press ◀ for reverse frame-by-frame playback or ▶ for forward frame-by-frame playback.

NOTE:

Still picture playback stops automatically after 3 minutes to protect the heads.

Slow Motion (On the Remote)

Press **JOG/SHUTTLE** so that the button lights up. During playback or still, turn the **SHUTTLE** ring to the right for forward slow motion, or to the left for reverse slow motion. Release to return to still picture.

OR

During still picture, press and hold **PAUSE** (II) for more than 2 seconds, then release. Press **PAUSE** (II) and release again to return to still picture.

OR

During still picture, press and hold ◀ or ▶. Release to return to still picture.

NOTE:

Forward slow motion playback stops automatically after 1 minute, reverse slow motion playback after 30 seconds to protect the heads.

To resume normal playback, press **PLAY** (▶).

You can also use the Remote's **JOG** dial/**SHUTTLE** ring for the operations. First press the **JOG/SHUTTLE** button on the Remote so that the button lights up before use. Refer to the **SHUTTLE** ring illustration below as you read the procedures.

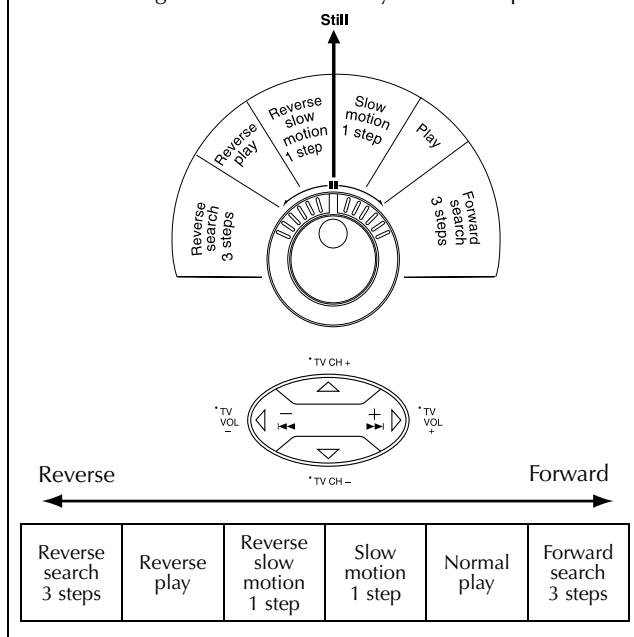

High-Speed (Turbo) Search (On the Remote)

Press **JOG/SHUTTLE** so that the button lights up. During playback or still, turn the **SHUTTLE** ring all the way to the right for forward high-speed search, or to the left for reverse high-speed search. Releasing **SHUTTLE** ring resumes still picture playback.

OR

During playback or still, press **FF** (▶▶) for forward high-speed search, or **REW** (◀◀) for reverse high-speed search.

NOTE:

For short searches, press and hold **FF** (▶▶) or **REW** (◀◀) for over 2 seconds during playback or still picture. When released, normal playback resumes.

Variable Speed Search (On the Remote)

Press **JOG/SHUTTLE** so that the button lights up. During playback or still, turn the **SHUTTLE** ring to the right for forward variable-speed search, or to the left for reverse variable-speed search.

OR

During playback, press ◀ or ▶.

- The more times you press, the faster the playback picture moves.
- To decrease speed, press the button for the opposite direction.

To resume normal playback, press **PLAY** (▶).

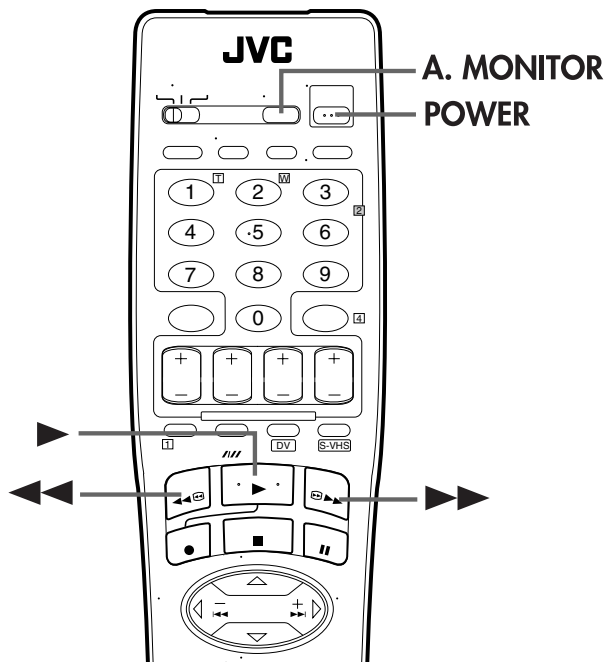
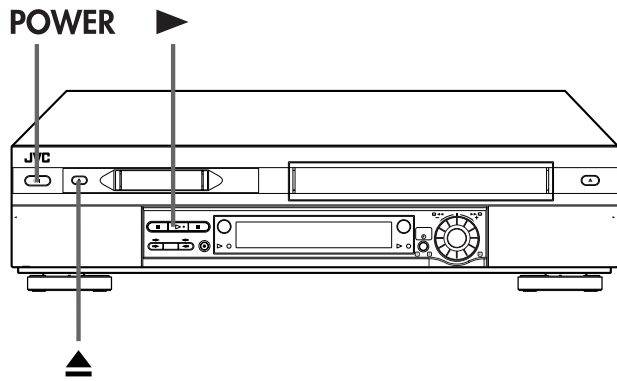

Next Function Memory

The Next Function Memory "tells" the VCR what to do after rewinding. Before continuing, make sure the VCR is in the Stop mode.

- a- For Automatic Start Of Playback
Press **REW** (◀◀), then press **PLAY** (▶) within 2 seconds.
- b- For Automatic Power Off
Press **REW** (◀◀), then press **POWER** within 2 seconds.
- c- For Automatic Cassette Ejection After Tape Rewind
Press **REW** (◀◀), then press **EJECT** (▲) within 2 seconds.

NOTE:

The Automatic Power Off does not work if "AUTO TIMER" is set to "ON" (☞ pg. 71) and if any timer programming has been made. If "AUTO TIMER" is set to "ON", the VCR directly goes into the Timer-Standby mode at the same time when the **POWER** is pressed for the Automatic Power Off.

Soundtrack Selection

Your VCR is capable of recording two soundtracks (L and R) and will play back the one you select.

During Playback

Pressing **A. MONITOR** changes the soundtrack as follows:

TRACK	USE
On-Screen Display	
L+R	Both sounds on the left channel and the right channel are mixed and played back
L	Sound on the left channel is played back
R	Sound on the right channel is played back

NOTE:

"SUPERIMPOSE" must be set to "ON" or the on-screen displays will not appear (☞ pg. 71).

Recording Features

(DV deck)

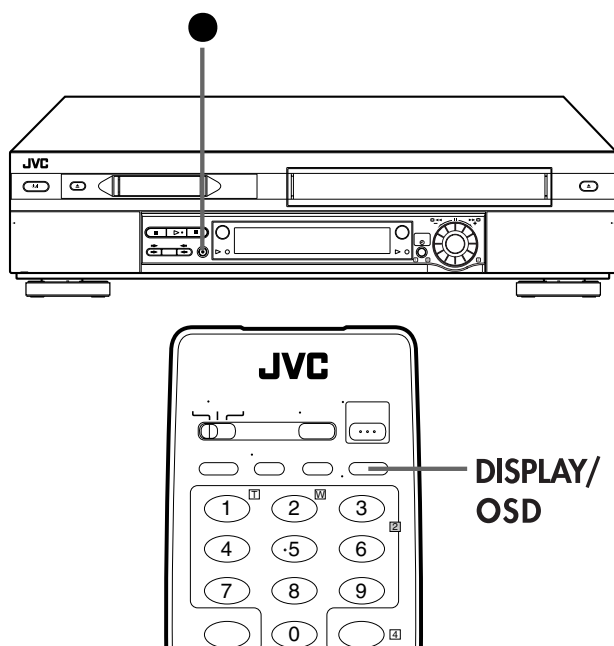

Recording Resume Function

If there is a power outage during recording, Instant Timer Recording (in the right column) or timer recording (☞ pg. 42, 46, 48), the recording will resume automatically when power is restored to the VCR unless the VCR's memory backup has expired.

Accidental erasure prevention

To prevent accidental recording on a recorded cassette, set its erase protection switch to "SAVE". To record on it later, set the switch to "REC".

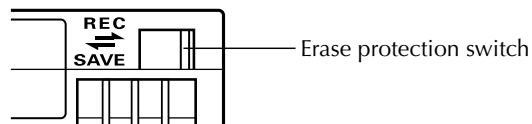

Second Audio Recording

This VCR's built-in MTS decoder enables reception of Multichannel TV Sound broadcast. To record a SAP program received, set "2ND AUDIO RECORD" to "ON". (☞ pg. 71)

NOTES:

When the channel is changed on the VCR;

- The "STEREO" indicator appears on the screen for about 5 seconds if the program is a stereo broadcast.
- The "SAP" indicator appears on the screen for about 5 seconds if the program is a SAP broadcast.
- Both indicators appear when a stereo program is accompanied by SAP sound.

Record One Program While Watching Another

Once recording is in progress, all you need to do is to set the channel controls on the TV for the station you wish to view.

- The program selected with the TV's channel controls appears on the TV screen, while the one selected with the VCR's **CH** buttons is recorded on the tape.

Instant Timer Recording (ITR)

This easy method lets you record for from 30 minutes to 2 hours (selectable in 30-min. increments), and shuts the VCR off after recording is finished.

1 Start recording.

Press **REC** (●) on the VCR.

2 Engage the ITR mode.

Press **REC** (●) again. "○" blinks and "0:30" appears on the front display panel.

3 Set the recording duration.

If you want to record for more than 30 minutes, press **REC** (●) to extend the time. Each press extends recording time by 30 minutes.

NOTE:

You can only perform ITR using the **REC** (●) button on the VCR's front panel.

Time Code

During recording, a time code is recorded on the tape. This time code is used to confirm the position on the tape when playing back or editing a tape. To perform Random Assemble Editing (☞ pg. 64), time code is necessary.

Press **DISPLAY/OSD** until the time code on the tape appears on the front display panel.

- By pressing the **DISPLAY/OSD** button, you can change the display to show the time code, channel position*, clock time.

* Channel position is not displayed during playback.

NOTES:

The presence of a blank (unrecorded) portion in the middle of a tape can result in misoperation.

A "blank portion" of a tape is a section where nothing is recorded on the tape. If you start recording in a blank portion of a tape, the time codes will start from "0:00:00" again. If identical time codes are recorded in two different places on a tape, Random Assemble Editing and other similar functions might not operate properly.

In the following cases, you should play back the tape and confirm where a scene ends, and then begin recording from there:

- When starting recording in the middle of a tape on which a recording has already been made.
- When you finish recording on a tape, then played back that recording in order to check it, and now wish to continue recording.
- When you lost power or the batteries died while you were recording with a camcorder.

VCR Plus+® Timer Programming

With the VCR Plus+ system, timer programming is greatly simplified because each TV program has a corresponding code number which your VCR is able to recognize.

Before performing the VCR Plus+ Timer Programming:

- Make sure that the VCR's built-in clock is set properly.
- Turn on the TV and select the AV mode.

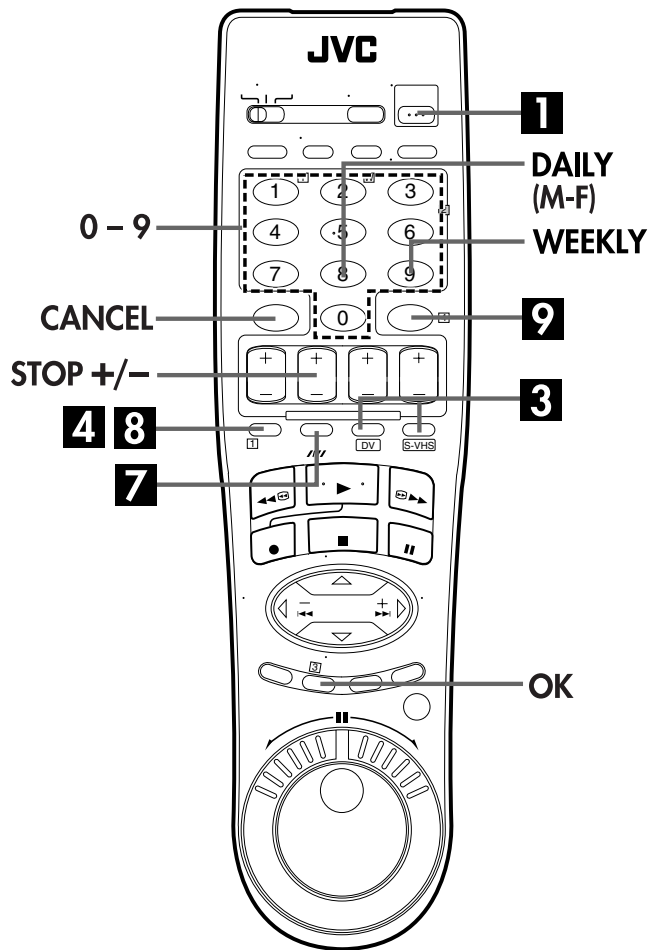

1 Turn on the VCR.

Press **POWER**.

2 Load a cassette.

Insert a VHS (or S-VHS) cassette with the record safety tab intact.

OR

Insert a Mini DV cassette with the erase protection switch set to "REC".

3 Select the deck.

Press **S-VHS** or **DV**.

4 Access the PlusCode No. screen.

Press **PROG.**

- The clock must be set to access the PlusCode No. screen. If you have not set the clock, the Main Menu screen appears after an error message is displayed. Refer to "Plug & Play Set" (pg. 14) or "Clock Set" (pg. 16).

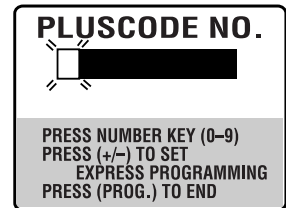

5 Enter the PlusCode number.

Press the **number keys** to enter the PlusCode number of a program you wish to record. Then press **OK**.

- If you make a mistake, press **CANCEL** and input the correct number.

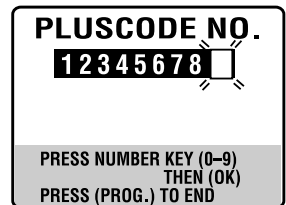

6 Access the VCR Plus+ Program screen.

The VCR Plus+ Program screen appears (if you're just starting out and you have selected the VHS deck, "VHS PROGRAM 1" appears).

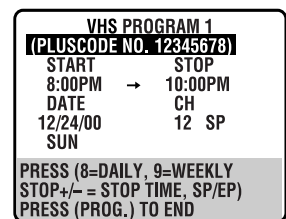

IMPORTANT

Make sure the channel position number you wish to record is displayed; if not, see "Changing VCR Plus+ Setting" on page 44 and set the Guide Channel number correctly.

- If the number you entered is invalid, "ERROR" appears on the TV screen. Press **CANCEL** and input a valid PlusCode number.
- If the "GUIDE CHANNEL SET" screen appears, see "ATTENTION" on page 43.

7 Set the tape speed.

For the VHS deck
Press **SP/EP** (//).

For the DV deck
Press **SP/LP** (//).

8 Return to the normal screen.

Press **PROG** or **OK**. "PROGRAM COMPLETED" appears on the TV screen for about 5 seconds, then the normal screen appears. If "PROGRAM NOT COMPLETED PROGRAM OVERLAP" appears on the TV screen, see page 51.

- Repeat steps 3 – 8 for each additional program.

9 Engage the VCR's timer mode.

Press **TIMER**. The VCR turns off automatically and "⊕" appears on the front display panel.

- To disengage the timer mode, press **TIMER** again.

Cable Box or DBS Receiver Users

To timer-record a cable or satellite broadcast using the VCR plus+ system:

- 1 Perform "Cable Box Control Setting" (☞ pg. 20) or "DBS Receiver Control Setting" (☞ pg. 23).
- 2 Perform steps 1 – 9.
- 3 Leave the power of cable box or DBS receiver on.

IMPORTANT

If you have moved to a different area or if a broadcasting station's channel number has been changed, the wrong VCR CH or CABLE CH number will be displayed on the VCR Plus+ program screen in step 6. When this happens, set the correct Guide Channel number for that station. (☞ pg. 44, "Changing VCR Plus+ Setting")

NOTES:

- To Change The Stop Time . . .
. . . press **STOP +/-** in step 6. You can compensate for anticipated program schedule delays.
- To Timer-Record Weekly Or Daily Serials . . .
. . . in step 6, press **WEEKLY** (number key "9") for weekly serials or **DAILY (M-F)** (number key "8") for daily serials (Monday — Friday). Either "WEEKLY" or "DAILY" appears on the TV screen. Pressing the button again makes the corresponding indication disappear.
- In case of a power failure after programing, the VCR's memory backup keeps your selections for approximately 10 minutes.
- You can program each deck to timer-record as many as 6 programs. If you try to program the VCR to record a seventh, "PROGRAM FULL" appears on the TV screen. To record the extra program, you must first cancel any unnecessary programs (☞ pg. 50).
- It is not possible to timer-record the same program on both the VHS deck and the DV deck simultaneously.
- During timer recording, it is not possible to change the recording deck (VHS or DV).
- If the times that are programmed for recording on the DV deck and on the VHS deck overlap, the earlier start time takes precedence. If the start times are the same, the VHS deck takes precedence.

ATTENTION

Guide Channel Number Set

"GUIDE CHANNEL SET" appears after performing step 6 if the Guide Channel number for the PlusCode number you entered has not been set.

If you want to set the Guide Channel number for the TV or cable station, press **number keys** or Δ/∇ to input the channel position number on which your VCR or cable box receives that station, then press **OK** or \triangleright to set the Guide Channel number. VCR Plus+ Program screen appears.

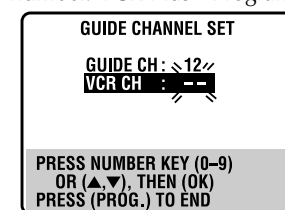

If you receive your channels with a cable box and if you have properly set your Controller, "CABLE CH" appears in place of "VCR CH". If not, refer to pages 20.

Changing VCR Plus+® Setting

Turn on the TV and select the AV mode.

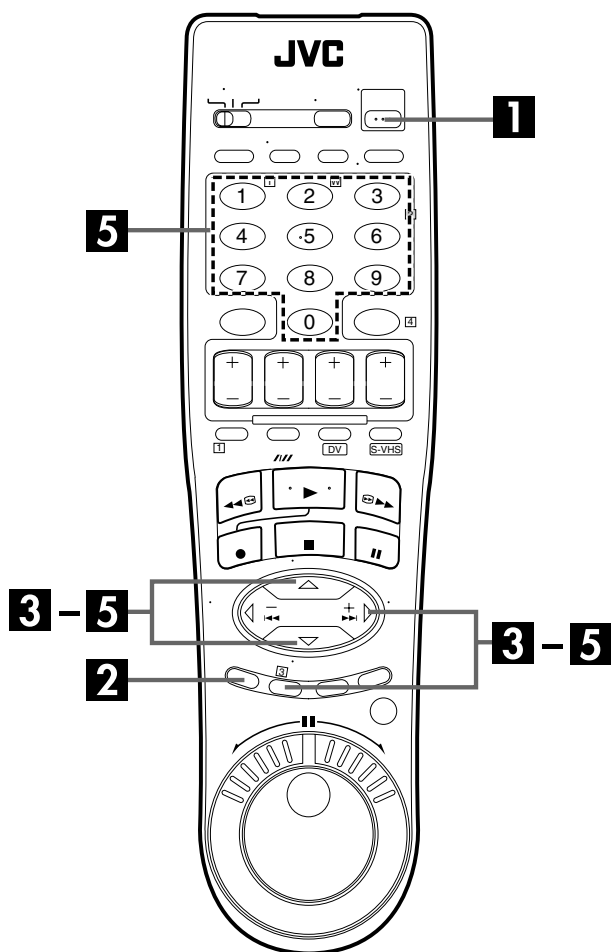

The VCR Plus+ programming system assigns a VCR Plus+ guide channel to the TV channels and the cable channels. These guide channel numbers are also called the VCR Plus+ channel codes. Most TV listings have a section, usually a chart, indicating the guide channel numbers assigned to each station.

To ensure that VCR Plus+ timer recording operates correctly, it is necessary to set the VCR Plus+ "Guide Channel Set" for each station.

If you have moved to a different area or if a broadcasting station's channel number has been changed, perform the following steps to set the correct guide channel number.

NOTES:

- In many instances, the VCR Plus+ guide channel numbers for cable and broadcast TV stations DO NOT match the channel number on which it is received by your VCR or cable box. Check your TV listing, or contact your cable supplier for details.
- Many TV stations can be viewed on cable. Check your TV listing, or contact your cable supplier for details.

Guide Channel Number Set

1 Turn on the VCR.

Press **POWER**.

2 Access the Main Menu screen.

Press **MENU**.

3 Access the Initial Set screen.

Press Δ / ∇ to move the highlight bar (arrow) to "INITIAL SET", then press **OK** or \triangleright .

4 Access the Guide Channel Set screen.

Press Δ / ∇ to move the highlight bar (arrow) to "GUIDE CHANNEL SET", then press **OK** or \triangleright .

5 Enter the Guide Channel number.

Press Δ / ∇ or the **number keys** to select the VCR Plus+ guide channel number as shown in the TV listing, then press **OK** or \triangleright .

- If you receive your channels with a cable box and if you have properly set your Controller, "CABLE CH" appears in place of "VCR CH". If not, perform "Cable Box Control Setting" (pg. 20).

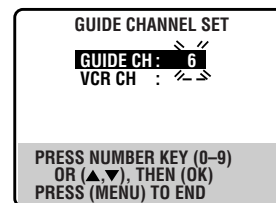

(Example)
When inputting the Guide Channel number 6 for WNJU (ind.).

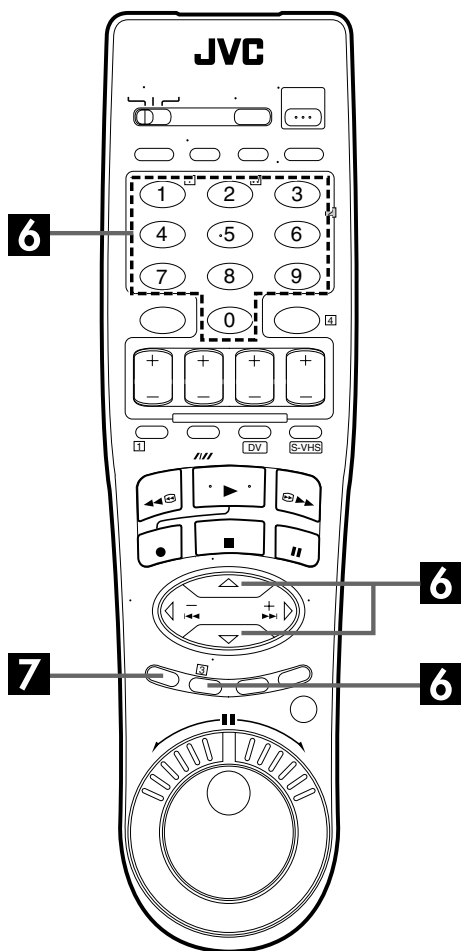

6 Enter the receiving channel position number.

Press Δ / ∇ or the **number keys** to select the number of the channel on which the guide channel's broadcasts are received, then press **OK** or \triangleright .

- Repeat steps 5 and 6 as necessary.

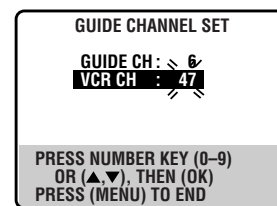

(Example) If WNJU (ind.) is received on channel position 47.

7 Return to the normal screen.

Press **MENU**.

Guide Channel Number

"Guide Channel (GUIDE CH) number" refers to the assigned TV station numbers, according to broadcast area, for the VCR Plus+ timer recording. The Guide Channel numbers can be found in most TV listings.

Express Timer Programming

If you do not know the PlusCode number for the program you wish to record, use the following procedure to set your VCR to timer-record the program.

Before performing Express Timer Programming:

- Make sure that the VCR's built-in clock is set properly.
- Turn on the TV and select the AV mode.

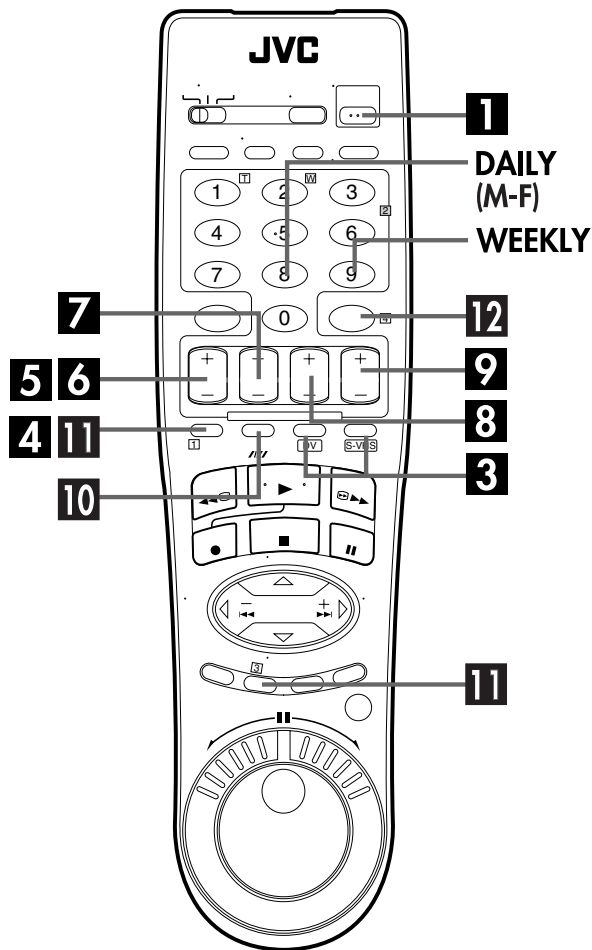

1 Turn on the VCR.

Press **POWER**.

2 Load a cassette.

Insert a VHS (or S-VHS) cassette with the record safety tab intact.

OR

Insert a Mini DV cassette with the erase protection switch set to "REC".

3 Select the deck.

Press **S-VHS** or **DV**.

4 Access the PlusCode screen.

Press **PROG.**

5 Access the Program screen.

Press **START+/-**. (If you're just starting out and you have selected the VHS deck, "VHS PROGRAM 1" appears.)

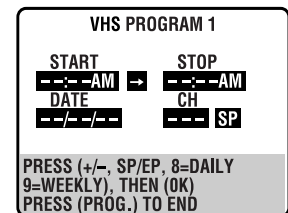

6 Enter the program start time.

Press **START+/-** to enter the time you want recording to start.

- Press and hold **START+/-** to move in 30-minute increments, or press and release repeatedly to move 1 minute at a time.

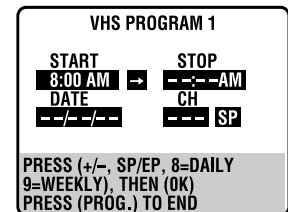

7 Enter the program stop time.

Press **STOP+/-** to enter the time you want recording to stop.

- Press and hold **STOP+/-** to move in 30-minute increments, or press and release repeatedly to move 1 minute at a time.

8 Enter the program date.

Press **DATE+/-**.

- The current date appears on the TV screen. The date you enter appears in its place.

9 Enter the channel position.

Press **CH+/-**.

- If you are using a DBS receiver, see "ATTENTION FOR DBS RECEIVER USERS" in the right column.
- Holding down **CH +/-** rapidly scans through the channels.

10 Set the tape speed.

For the VHS deck

Press **SP/EP (//)**.

For the DV deck

Press **SP/LP (//)**.

11 Return to the normal screen.

Press **PROG** or **OK**. "PROGRAM COMPLETED" appears on the TV screen for about 5 seconds, then the normal screen appears. If "PROGRAM NOT COMPLETED PROGRAM OVERLAP" appears on the TV screen, see page 51.

- Repeat steps 3 – 11 for each additional program.

12 Engage the VCR's timer mode.

Press **TIMER**. The VCR turns off automatically and "⊕" appears on the front display panel.

- To disengage the timer mode, press **TIMER** again.

NOTES:

- To *Timer-Record Weekly Or Daily Serials . . .*
. . . anytime during steps 5 through 10, press **WEEKLY** (number key "9") for weekly serials or **DAILY (M-F)** (number key "8") for daily serials (Monday – Friday). Either "WEEKLY" or "DAILY" appears on the TV screen. Pressing the button again makes the corresponding indication disappear.
- You can program each deck to timer-record as many as 6 programs. If you try to program the VCR to record a seventh, "PROGRAM FULL" appears on the TV screen. To record the extra program, you must first cancel any unnecessary programs (⏏ pg. 50).
- In case of a power failure after programing, the VCR's memory backup keeps your selections for approximately 10 minutes.
- Programs that start after midnight must have the next day's date.
- You can program the timer while a regular recording is in progress; the on-screen menu will not be recorded.
- It is not possible to timer-record the same program on both the VHS deck and the DV deck simultaneously.
- During timer recording, it is not possible to change the recording deck (VHS or DV).
- If the times that are programed for recording on the DV deck and on the VHS deck overlap, the earlier start time takes precedence. If the start times are the same, the VHS deck takes precedence.

Cable Box or DBS Receiver Users

To timer-record a cable or satellite broadcast using Express Timer Programing:

- 1 Perform "Cable Box Control Setting" on page 20 or "DBS Receiver Control Setting" on page 23.
- 2 Perform steps 1 – 12.
- 3 Leave the power of cable box or DBS receiver on.

ATTENTION FOR DBS RECEIVER USERS

If you are using a DBS receiver (unless "DBS RECEIVER SET" is set to "OFF" ⏏ pg. 24), the band indication (TV, CATV or DBS) appears under the channel number indication.

TV: To timer-record a regular TV broadcast received on the VCR.

CATV: To timer-record a cable TV broadcast received on the VCR, or through a cable box (unless "CABLE BOX SET" is set to "OFF" ⏏ pg. 21).

DBS: To timer-record a satellite broadcast received through a DBS receiver.

VHS PROGRAM 1			
START	8:00AM	→	STOP
DATE	12/24/00		CH
	SUN		110 SP
			DBS
PRESS (+/-, SP/EP, 8=DAILY 9=WEEKLY, 7=DBS), THEN (OK) PRESS (PROG.) TO END			

NOTE:

If "BAND" is set to "TV" on the Tuner Set screen (⏏ pg. 18) and "CABLE BOX SET" is set to "OFF" on the Cable Box Set screen (⏏ pg. 21), "CATV" will not be displayed on the Program screen; If "BAND" is set to "CATV" or "CABLE BOX SET" is set to "ON", "TV" will not be displayed.

If the channel number entered requires that the band be set, "7=DBS" is displayed on the screen.

If this happens, press the **number key "7 (DBS)"** to select "DBS".

24HR Quick Programming

Before performing the 24HR Quick Programming:

- Make sure that the VCR's built-in clock is set properly.
- Select the deck.
- Set the tape speed.
- **For the VHS deck:**
Insert a VHS (or S-VHS) cassette with the record safety tab intact.
- **For the DV deck:**
Insert a Mini DV cassette with the erase protection switch set to "REC".

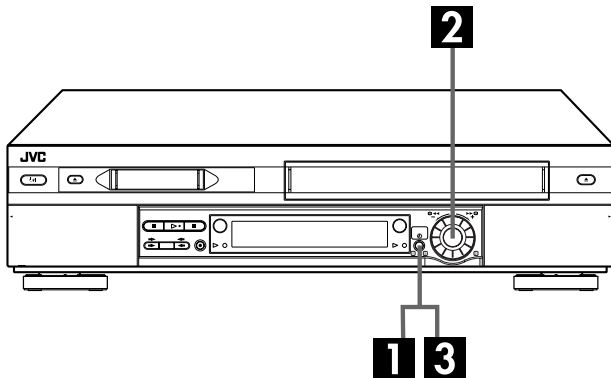

You can program a timer recording that starts within 24 hours using the ADVANCED JOG dial on the VCR.

1 Enter the program mode.

Press **24HR QUICK PROGRAM** on the VCR. The start time indicator (▶) starts blinking on the front display panel.

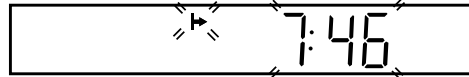

2 Set the program start/stop time and channel.

Turn the **ADVANCED JOG** dial to the left or right to set the time you want recording to start.

- One click stop of the **ADVANCED JOG** dial changes the time in 5-minute intervals.

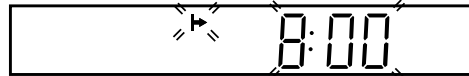

Push the **ADVANCED JOG** dial. The stop time indicator (▶) starts blinking on the front display panel. Turn the **ADVANCED JOG** dial to the left or right to set the time you want recording to stop.



Push the **ADVANCED JOG** dial. Turn the **ADVANCED JOG** dial to the left or right to select the channel you wish to record.

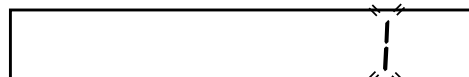

- You can cancel the setting at any time by pressing and holding the **ADVANCED JOG** dial for more than 3 seconds or pressing **CANCEL** on the Remote. Repeat the step 2.

3 Engage the VCR's timer mode.

Press **24HR QUICK PROGRAM**. The VCR turns off automatically and "Ⓢ" appears on the front display panel.

- To disengage the timer mode, press **TIMER** or **24HR QUICK PROGRAM** again.

NOTES:

- You can program each deck to timer-record as many as 6 programs. If you try to program the VCR to record a seventh, "FULL" appears on the front display panel. To record the extra program, you must first cancel any unnecessary programs (see pg. 50).
- If "Err" appears on the front display panel, repeat the steps on page 48 again.
- When a menu screen is shown, you cannot use 24HR Quick Programing function. Press **MENU** to return to normal screen, and try again.
- You can use 24HR Quick Programing function also when the VCR is turned off.
- For 24HR Quick Programing function, the program overlap warning display does not appear even if some programs overlap each other. The program with the lower program number will be recorded and the other one will not be recorded correctly.
- It is not possible to timer-record the same program on both the VHS deck and the DV deck simultaneously.
- During timer recording, it is not possible to change the recording deck (VHS or DV).
- If the times that are programed for recording on the DV deck and on the VHS deck overlap, the earlier start time takes precedence. If the start times are the same, the VHS deck takes precedence.
- If you perform 24HR Quick Programing during recording or Instant Timer Recording (ITR), press **TIMER** to engage the timer mode after the recording (or ITR) is finished.

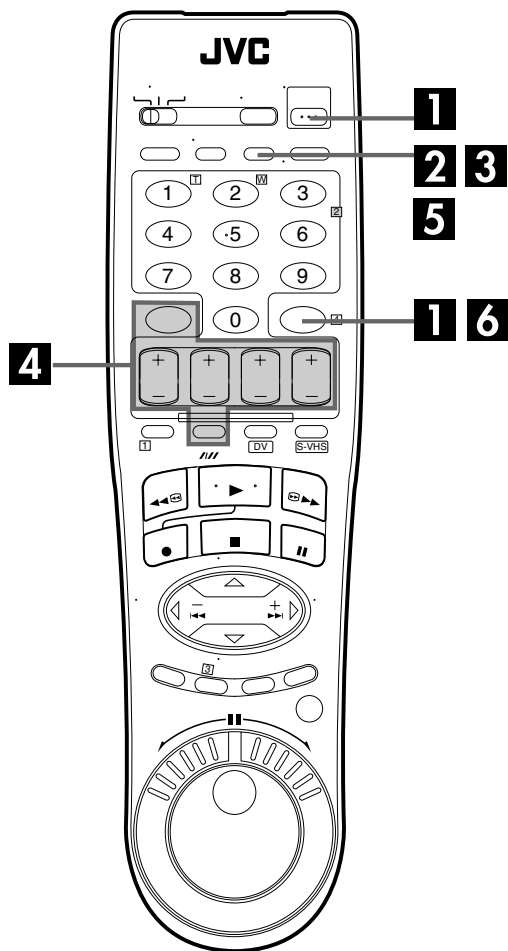

Check, cancel and change programs

1 Disengage the timer mode.

Press **TIMER**, then press **POWER**.

2 Access the Program Check screen.

Press **PROG CHECK**.

- The Program Check screen appears for the deck (VHS or DV) being selected.

VHS				
PR	START	STOP	CH	DATE
1	8:00P	10:00	12	12/24
2	10:00A	10:45	40	12/25
3	11:30P	1:00	125	12/25
4				
5				
6				

PRESS (CHECK) TO NEXT

3 Access the Program screen.

Press **PROG CHECK** again to check more information.

Each time you press **PROG CHECK**, the next program's information appears.

VHS PROGRAM 1				
START	STOP			
8:00AM	9:00AM			
DATE	CH			
7/15/00	12 SP			
DAILY	CATV			

PRESS (CANCEL) TO CANCEL
PRESS (CHECK) TO NEXT

To cancel or change a program...

4 Cancel or change a program.

Press **CANCEL** to cancel a program. To change program settings, press the appropriate button: **START+/-**, **STOP+/-**, **DATE+/-**, **CH+/-**, and/or **SP/EP (///)**.

5 Return to the normal screen.

Press **PROG CHECK** as many times as necessary. If there are still some programs remaining, go to step 6.

6 Return to the timer mode.

Press **TIMER**.

ATTENTION

If there is a conflict in the timer schedule and one program overlaps with another, only the parts shown below in gray will be recorded.

Pattern 1: The program with the lower program number will be recorded.

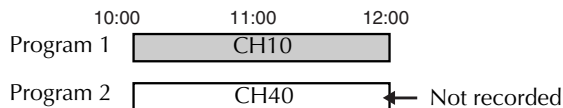

Pattern 2: The program starting earlier will be recorded.

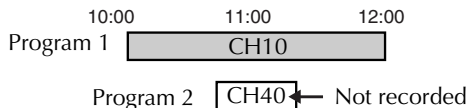

Pattern 3: The program starting earlier will be recorded, followed by the remaining portion of the other program.

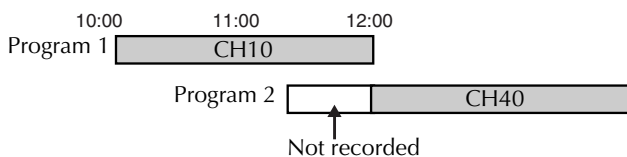

ATTENTION

If the program you have just made and "DV" are blinking, there is a conflicting program on the DV deck.

- 1 Press $\Delta \nabla$ to move the highlight bar to "DV", then press **OK** or \triangleright . DV Program Check screen appears.
- 2 Cancel or change program setting as described in step 2 and 3 in the right column.

VHS				
PR	START	STOP	CH	DATE
1	8:00	10:00	12	12/24
2	10:00	10:45	40	12/25
3	11:30	1:00	125	12/25
4	9:00	10:00	10	12/24
5				
6				
DV				
($\Delta \nabla$), THEN (\triangleright) (PROG.): END				



DV				
PR	START	STOP	CH	DATE
1	9:00	10:00	12	12/24
2				
3				
4				
5				
6				
VHS				
($\Delta \nabla$), THEN (\triangleright) (PROG.): END				

When programs overlap each other

If "PROGRAM NOT COMPLETED PROGRAM OVERLAP" appears, you have another program overlapping the program you have just made. The Program Check screen appears and conflicting programs will start blinking.

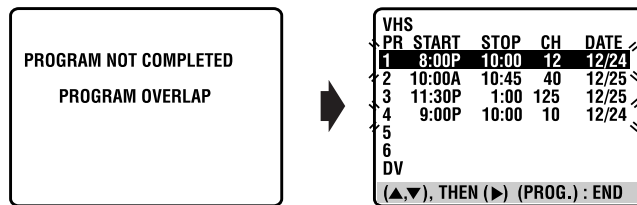

Example: Program 1 (you have just made) and Program 4 overlap each other on the VHS deck.

1 Confirm the overlapping programs.

Overlapping programs blink on the TV screen.

2 Select the program to modify.

Press $\Delta \nabla$, then press **OK** or \triangleright .

- You can only select one of the overlapping programs.

NOTE:

If you do not mind this overlap, press **PROG** to finish the timer program setting. See "ATTENTION" in the left column. The program with the lower program number will be recorded and the other one will not be recorded correctly. If no changes are made for approximately 3 minute, the VCR will return to the normal screen.

3 Cancel or change program setting.

To cancel a program, press **CANCEL** when the Program screen you do not want is shown. "PROGRAM COMPLETED" appears on the TV screen for about 5 seconds, then the normal screen appears.

To change a program, press the appropriate button: **START+/-**, **STOP+/-**, **DATE+/-**, **CH+/-**, and/or **SP/EP (///)** when the Program screen on which you want to make changes is shown, then press **OK**. "PROGRAM COMPLETED" appears on the TV screen for about 5 seconds, then the normal screen appears.

NOTE:

If the overlap is not yet solved, or another overlap occurs with the timer program setting after making the last correction on a program, the conflicting programs will be shown on the Program Check screen again. Repeat the above steps again until the overlap is solved.

Tape Dubbing

(from DV to VHS)

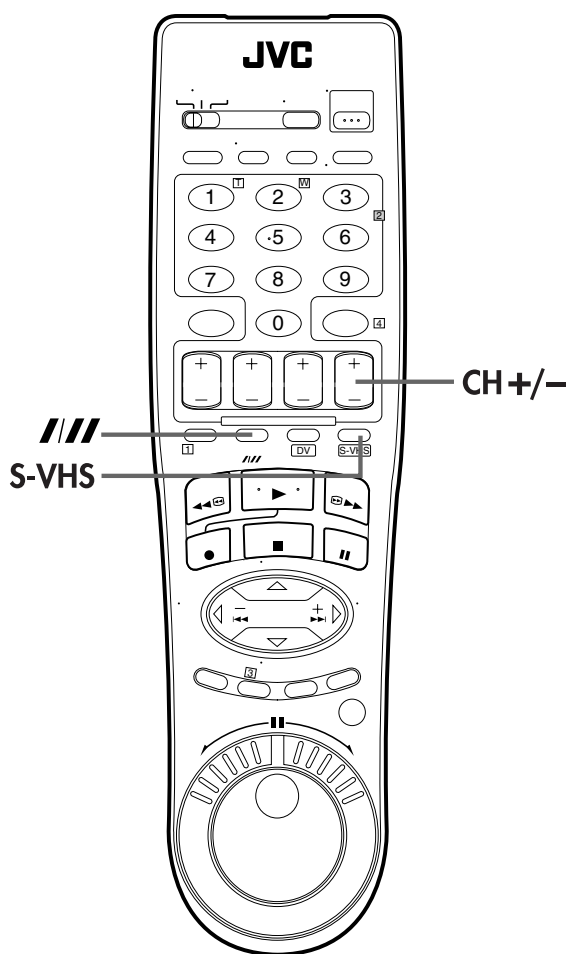
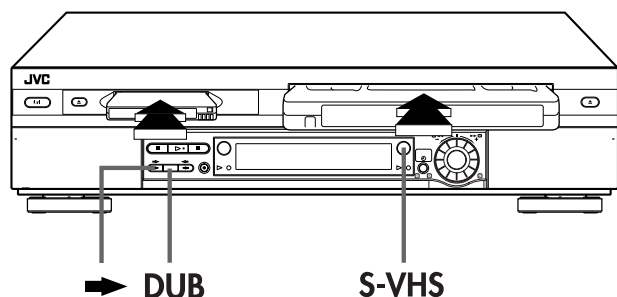

Dubbing An Entire Cassette

Because this VCR includes both VHS deck and DV deck, you can easily use it for dubbing without connecting any other equipment.

1 Load cassettes.

For the VHS deck

Insert a VHS (or S-VHS) cassette with the record safety tab intact, or cover the hole using adhesive tape.

For the DV deck

Insert a Mini DV cassette with the erase protection switch set to "SAVE".

2 Select the dubbing direction.

Press \Rightarrow .

- The dubbing direction indicator (DV \Leftrightarrow) lights.

3 Set the tape speed.

Press **S-VHS**, then press **SP/EP (///)**.

- "DV \rightarrow VHS" appears on the TV screen if "SUPERIMPOSE" is set to "ON". (pg. 71)

4 Start dubbing.

Press **DUB** for more than 2 seconds.

- DV playback indicator and VHS recording indicator light.
- If the tapes have not been rewound, both decks rewind automatically. The VHS deck goes into Record Pause mode, and the DV deck goes into Pause mode. When both decks have finished rewinding, dubbing begins automatically. After dubbing is completed, the decks rewind both tapes automatically and eject them. The VCR then shuts off.

NOTES:

- If you set the dubbing direction incorrectly, you could erase an important recording that you wanted to copy. It is recommended to conduct a test with unimportant cassettes first.
- If you start dubbing a copy-protected tape, "ERROR" message is displayed on screen and the dubbing is aborted.
- To cancel the dubbing mode, press **CH +/-** so that the dubbing direction indicator (DV \Leftrightarrow) goes off.

Tape Dubbing

(from VHS to DV)

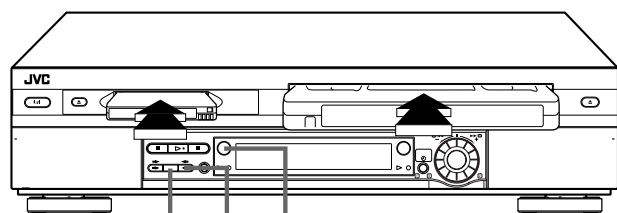

DUB ← DV

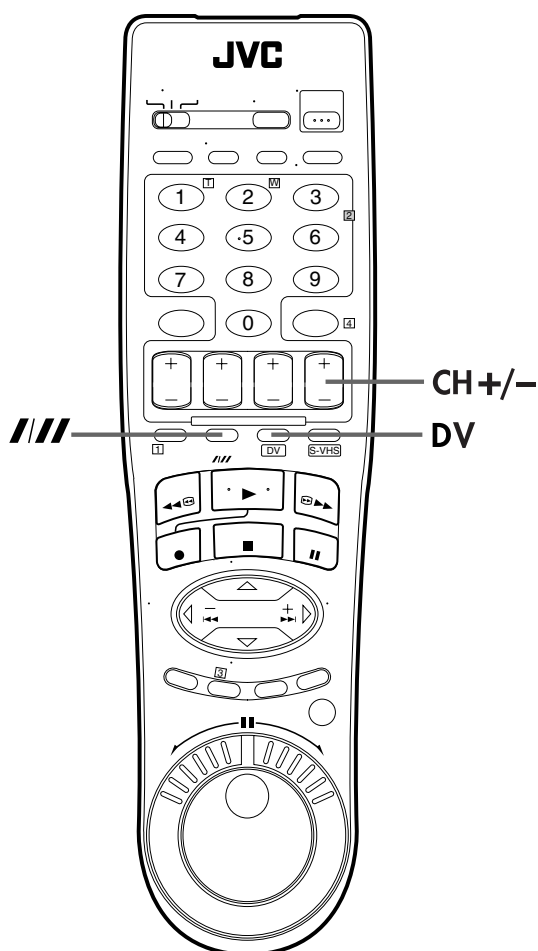

Dubbing An Entire Cassette

Because this VCR includes both VHS deck and DV deck, you can easily use it for dubbing without connecting any other equipment.

1 Load cassettes.

For the VHS deck

Insert a VHS (or S-VHS) cassette with the record safety tab removed.

For the DV deck

Insert a Mini DV cassette with the erase protection switch set to "REC".

2 Select the dubbing direction.

Press ←.

- The dubbing direction indicator (↔ S-VHS) lights.

3 Set the tape speed.

Press DV, then press SP/LP (///).

- "VHS → DV" appears on the TV screen if "SUPERIMPOSE" is set to "ON". (ⓘ pg. 71)

4 Start dubbing.

Press DUB for more than 2 seconds.

- VHS playback indicator and DV recording indicator light.
- If the tapes have not been rewound, both decks rewind automatically. The DV deck goes into Record Pause mode, and the VHS deck goes into Pause mode. When both decks have finished rewinding, dubbing begins automatically. After dubbing is completed, the decks rewind both tapes automatically and eject them. The VCR then shuts off.

NOTES:

- If you set the dubbing direction incorrectly, you could erase an important recording that you wanted to copy. It is recommended to conduct a test with unimportant cassettes first.
- If you start dubbing a tape from a tape with a copy protection signal, the tapes will be automatically ejected, and the VCR will turn off.
- To cancel the dubbing mode, press CH +/- so that the dubbing direction indicator (↔ S-VHS) goes off.

Normal Dubbing

(from DV to VHS)

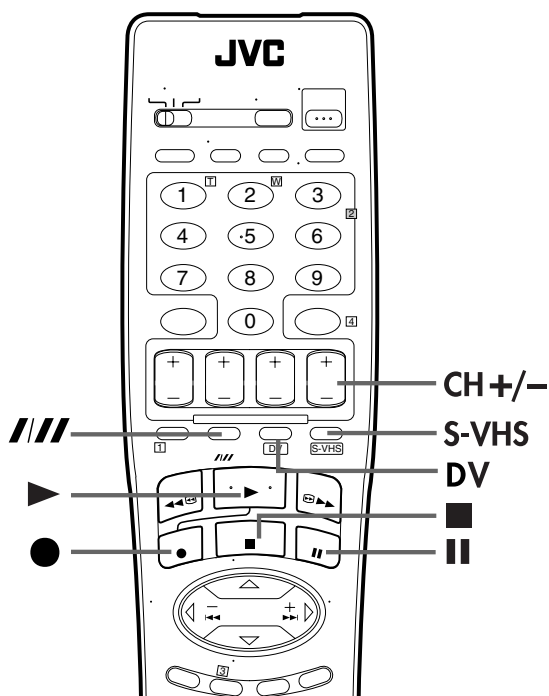
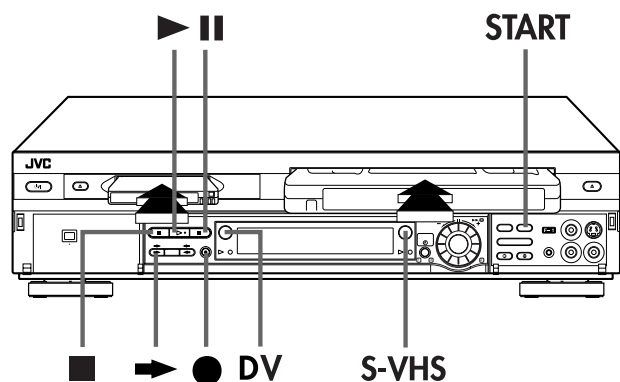

NOTES:

- If you set the dubbing direction incorrectly, you could erase an important recording that you wanted to copy. It is recommended to conduct a test with unimportant cassettes first.
- There may be a discrepancy of several seconds between where you intend editing to start, and where it actually starts.
- The superimposed indication during the operation or dubbing is not recorded.
- To cancel the dubbing mode, press **CH +/-** so that the dubbing direction indicator (DV ⇄) goes off.
- When dubbing a Mini DV tape that was produced by audio dubbing, you need to set "12BIT MODE" to the appropriate mode before playing back the tape. (pg. 76)

You can dub selected scenes on a tape, starting and stopping wherever you wish.

1 Load cassettes.

For the VHS deck

Insert a VHS (or S-VHS) cassette with the record safety tab intact, or cover the hole using adhesive tape.

For the DV deck

Insert a Mini DV cassette with the erase protection switch set to "SAVE".

2 Select the dubbing direction.

Press →.

- The dubbing direction indicator (DV ⇄) lights.

3 Set the tape speed.

Press **S-VHS**, then press **SP/EP (///)**.

- "DV → VHS" appears on the TV screen if "SUPERIMPOSE" is set to "ON". (pg. 71)

4 Locate the start point on the DV deck.

- 1 Press **DV**.
- 2 Press **PLAY (▶)** to start playback.
- 3 Press **PAUSE (II)** to pause playback a little before the start point.

5 Prepare the VHS deck for dubbing.

- 1 Press **S-VHS**.
 - 2 Press and hold **PAUSE (II)** and press **REC (●)** so that the VHS deck enters the Record Pause mode.
- DV playback indicator and VHS recording indicator light.

6 Start dubbing.

Press **START**.

7 Pause dubbing.

Press **START**.

- The VHS deck enters the Recording Pause mode, then the DV deck enters the Dubbing Pause mode.

8 End dubbing.

Press **STOP (■)** to stop recording on the VHS deck. Then press **DV** and press **STOP (■)** to stop playback on the DV deck.

Normal Dubbing

(from VHS to DV)

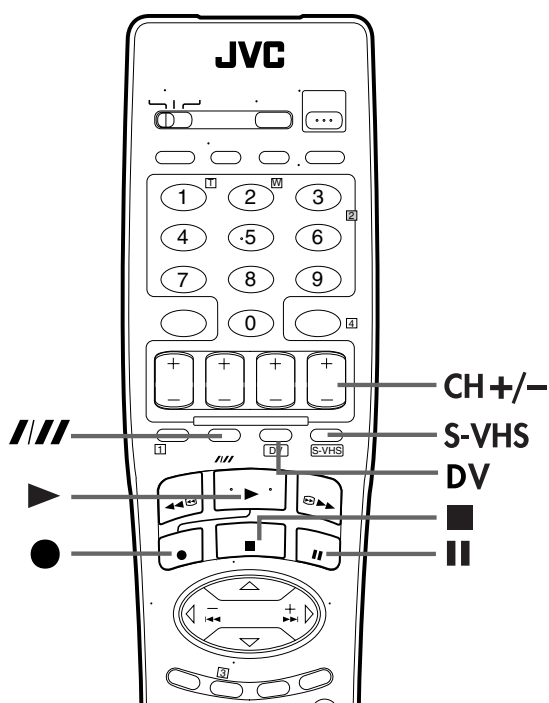
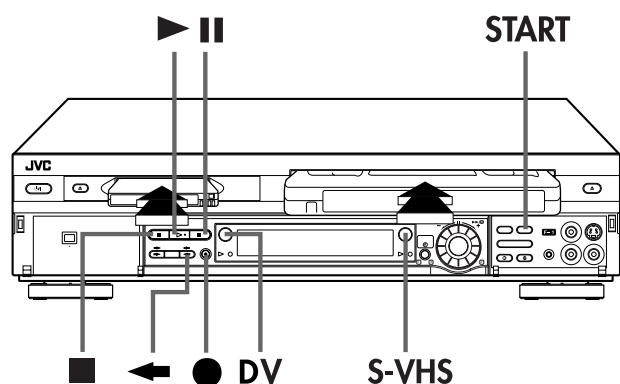

NOTES:

- If you set the dubbing direction incorrectly, you could erase an important recording that you wanted to copy. It is recommended to conduct a test with unimportant cassettes first.
- There may be a discrepancy of several seconds between where you intend editing to start, and where it actually starts.
- The superimposed indication during the operation or dubbing is not recorded.
- To cancel the dubbing mode, press **CH +/-** so that the dubbing direction indicator (↔S-VHS) goes off.
- Before you start dubbing, set "SOUND MODE" to the appropriate mode. (☞ pg. 76)

You can dub selected scenes on a tape, starting and stopping wherever you wish.

1 Load cassettes.

For the VHS deck

Insert a VHS (or S-VHS) cassette with the record safety tab removed.

For the DV deck

Insert a Mini DV cassette with the erase protection switch set to "REC".

2 Select the dubbing direction.

Press ←.

- The dubbing direction indicator (↔S-VHS) lights.

3 Set the tape speed.

Press **DV**, then press **SP/LP (///)**.

- "VHS → DV" appears on the TV screen if "SUPERIMPOSE" is set to "ON". (☞ pg. 71)

4 Locate the start point on the VHS deck.

- 1 Press **S-VHS**.
- 2 Press **PLAY (▶)** to start playback.
- 3 Press **PAUSE (II)** to pause playback a little before the start point.

5 Prepare the DV deck for dubbing.

- 1 Press **DV**.
 - 2 Press and hold **PAUSE (II)** and press **REC (●)** so that the DV deck enters the Record Pause mode.
- VHS playback indicator and DV recording indicator light.

6 Start dubbing.

Press **START**.

7 Pause dubbing.

Press **START**.

- The DV deck enters the Recording Pause mode, then the VHS deck enters the Dubbing Pause mode.

8 End dubbing.

Press **STOP (■)** to stop recording on the DV deck. Then press **S-VHS** and press **STOP (■)** to stop playback on the VHS deck.

Edit From A Camcorder

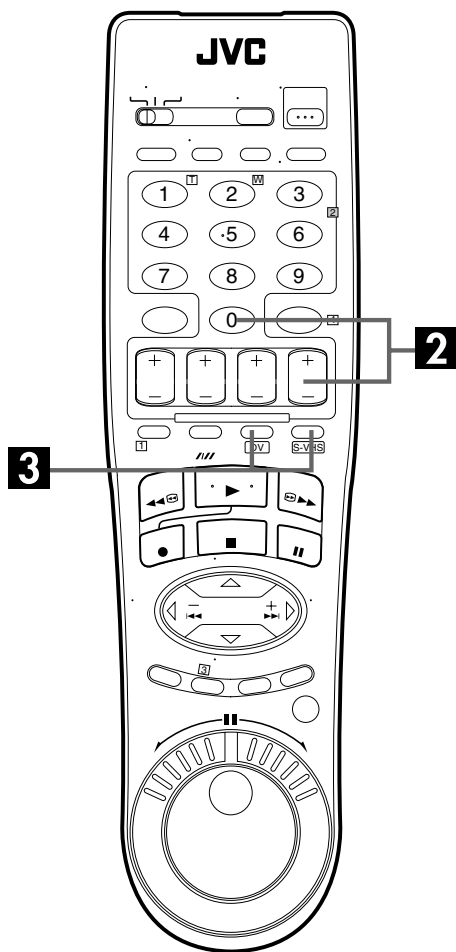
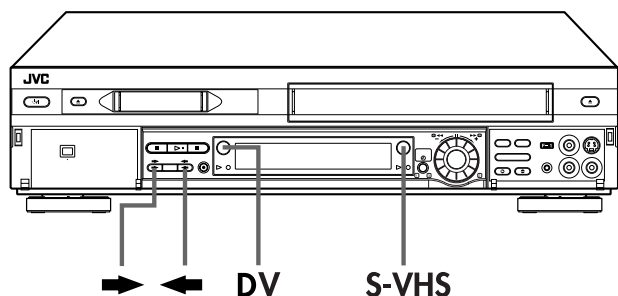

You can use a camcorder as the source player and your VCR as the recording deck. You can perform digital dubbing if you connect a device such as a camcorder which has a DV IN/OUT connector. Because the signals are digital, there is no loss of video or audio quality as a result of editing.

1 Make connections.

- 1 If the camcorder has no S-VIDEO output connector ... connect the camcorder's AUDIO OUT and VIDEO OUT connectors to the VCR's front panel AUDIO and VIDEO input connectors.
- 2 If the camcorder has an S-VIDEO output connector ... connect the camcorder's AUDIO OUT and S-VIDEO OUT connectors to the VCR's front panel AUDIO and S-VIDEO input connectors.
- 3 If the camcorder has a DV IN/OUT connector ... connect the camcorder's DV IN/OUT connector to the VCR's DV IN/OUT connector.
 - When using a monaural camcorder, connect its AUDIO OUT connector to the AUDIO L input connector on your VCR.
 - When a Master Edit Control-equipped JVC camcorder is used, the camcorder is capable of controlling the VCR. Refer to the camcorder's instruction manual for operating procedure.

2 Set the VCR's input mode.

Press **AUX** (number key "0") and/or **CH +/-** to select "F-1".

F-1: when connecting the camcorder to the audio/video input connectors or DV IN/OUT connector on the front panel.

- When using S VIDEO connector, set "FRONT AUX INPUT" to "S-VIDEO". (pg. 73)
- When using VIDEO connector, set "FRONT AUX INPUT" to "VIDEO". (pg. 73)

3 Select the recording deck.

Press **S-VHS** or **DV**.

- To edit from a camcorder to the VHS deck through the DV IN/OUT connector, press **➡**.
- To edit from a camcorder to the DV deck through the S-VIDEO (VIDEO)/AUDIO input connectors, press **⬅**.

4 Set the edit mode. (VHS deck only)

See "PICTURE CONTROL" on page 73.

5 Start the camcorder.

Engage the Play mode of the camcorder.

6 Start the VCR.

Engage the Record mode of the VCR.

1 If the camcorder has no S-VIDEO output connector ...

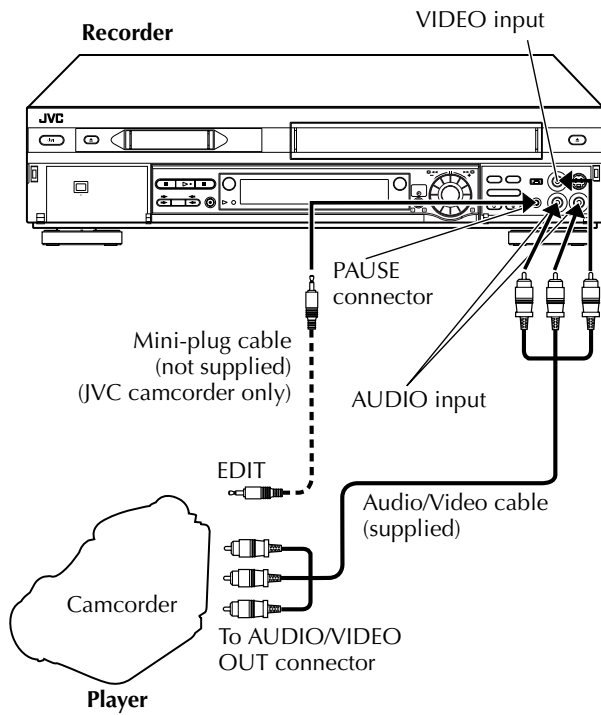

2 If the camcorder has an S-VIDEO output connector ...

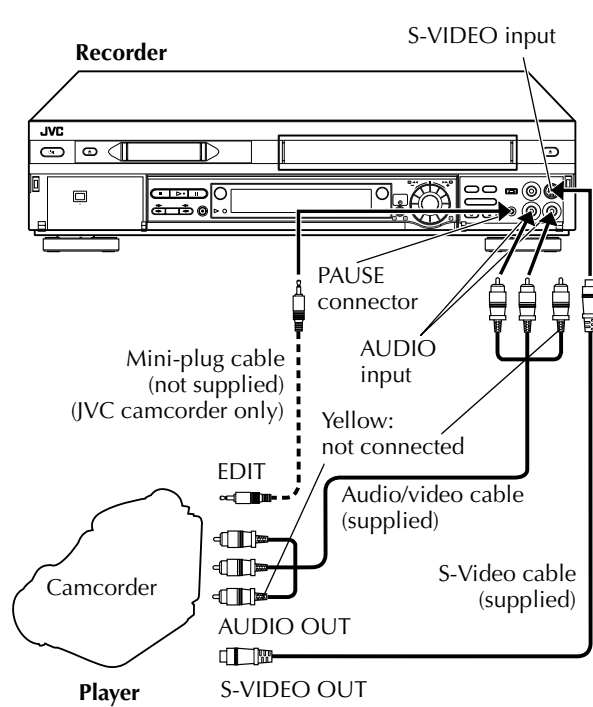

3 If the camcorder has a DV IN/OUT connector ...

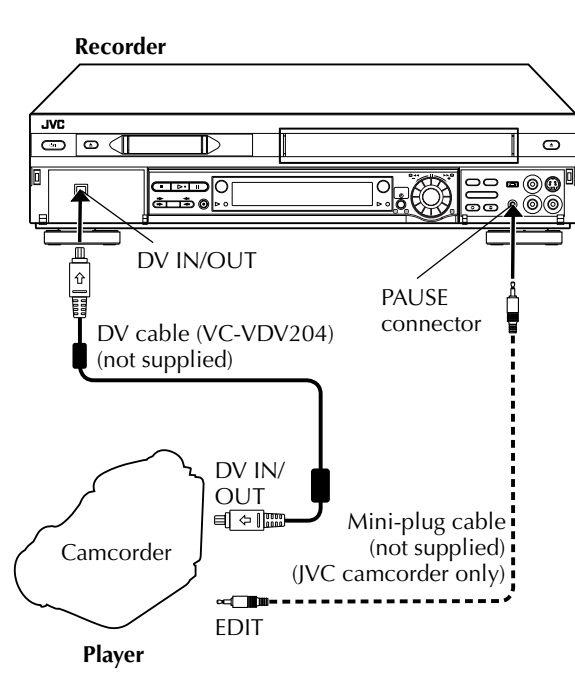

NOTES:

About DV IN/OUT connector

- To output digital signal when dubbing from the VHS deck to other device through the DV IN/OUT connector, press ◀, and then press **PLAY** (▶) to start playback on the VHS deck.
- To input digital signal when dubbing from other device to the VHS deck through the DV IN/OUT connector, press ▶ then **S-VHS**, and then press **REC** (●) to start recording on the VHS deck.
- It is possible to control the DV deck from the AVC protocol-equipped device that is connected to the DV IN/OUT connector. To control the VHS deck, use the buttons on this VCR and the Remote.
- Dubbing is also possible using the rear panel connectors.
- All necessary cables can be obtained from your dealer.
- When you select "EDIT" to dub tapes in step 4, be sure to select "AUTO" (or "NORM" when "VIDEO CALIBRATION" is set to "OFF") after you finish dubbing the tapes.
- When you are editing through the DV IN/OUT connector, the VCR will stop if the signal is interrupted.
- When connecting this VCR to a device equipped with a DV input connector, be sure to use the optional DV cable (VC-VDV204).

Edit To Or From Another VCR/PC

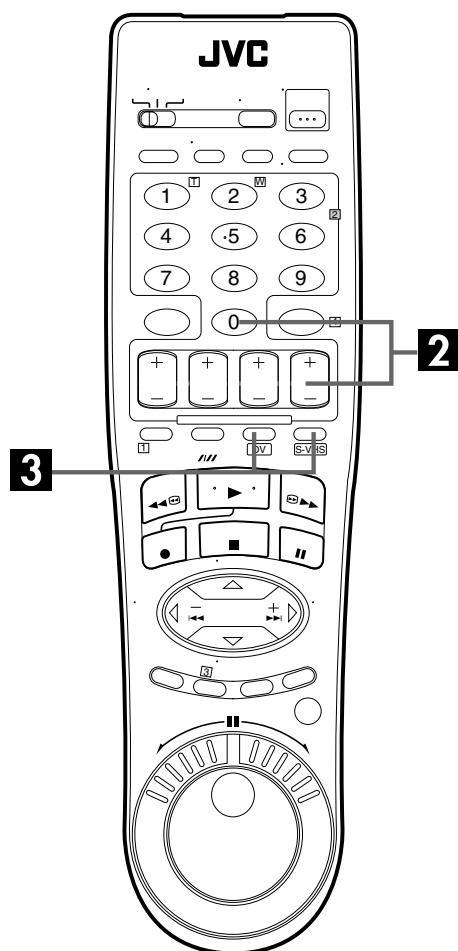

You can use your VCR as the source player or as the recording deck.

1 Make connections.

Connect an audio/video cable between the player's VIDEO OUT and AUDIO OUT connectors and the recorder's VIDEO IN and AUDIO IN connectors.

- If connecting a VCR with an S-VIDEO input/output connector, it is recommended to use the S-VIDEO connection to minimize picture degradation while editing.

2 Set the input mode of recording deck.

If using your VCR as a recording deck, press **AUX** (number key "0") and/or **CH +/-** to select "L-1".

L-1: when connecting the VCR to the audio/video input connectors on the rear panel.

- When using S VIDEO connector, set "REAR AUX INPUT" to "S-VIDEO". (pg. 71)
- When using VIDEO connector, set "REAR AUX INPUT" to "VIDEO". (pg. 71)

3 Select the recording deck.

Press **S-VHS** or **DV**.

4 Set the edit mode. (VHS deck only)

See "PICTURE CONTROL" on page 73.

5 Start the source player.

Engage the Play mode of the source player.

6 Start the recording deck.

Engage the Record mode of the recording deck.

Connection to another VCR

(Example: When using this VCR as the source player)

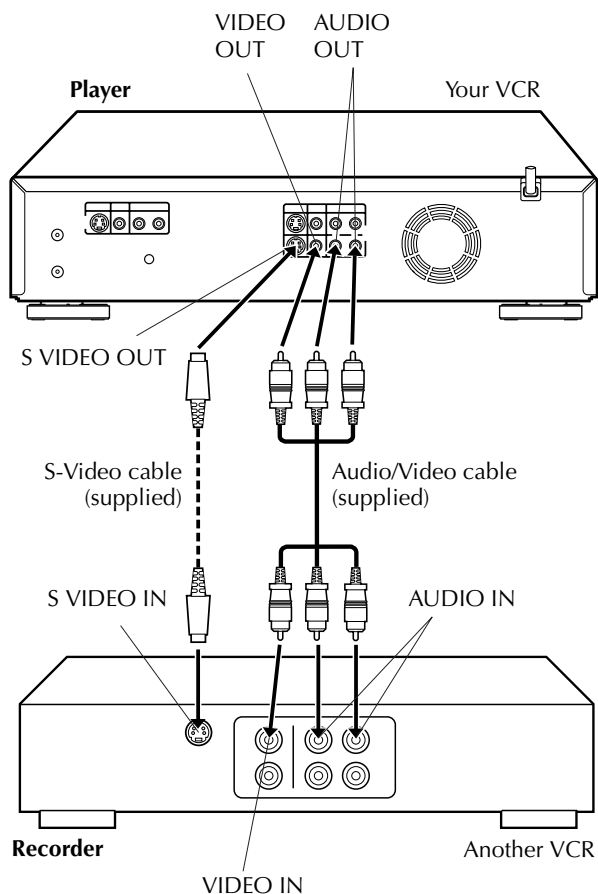

Advantages of S-VHS video recorders

You can edit from VHS to S-VHS, S-VHS to VHS, or from S-VHS to S-VHS.

- From VHS to S-VHS: Record VHS playback signals in the S-VHS mode. Although the picture quality is inherently limited by that of the original, the edited tape has better picture quality than those made by VHS-to-VHS editing.
- From S-VHS to VHS: Because the picture quality of the source material is very high, the edited tape has better picture quality than those made by VHS-to-VHS editing.
- From S-VHS to S-VHS: All signals will be transferred with minimum degradation.

NOTES:

- Dubbing is also possible using the front panel connectors.
- All necessary cables can be obtained from your dealer.
- When you select "EDIT" to dub tapes in step 4, be sure to select "AUTO" (or "NORM" when "VIDEO CALIBRATION" is set to "OFF") after you finish dubbing the tapes.
- When you use this VCR as the source player for editing, be sure to set "SUPERIMPOSE" to "OFF" before starting (pg. 71).
- If you are using another VCR with S-Video and Audio input/output connectors, you can connect those connectors to this VCR's S-VIDEO and AUDIO input/output connectors.

Connection to a PC with DV connector

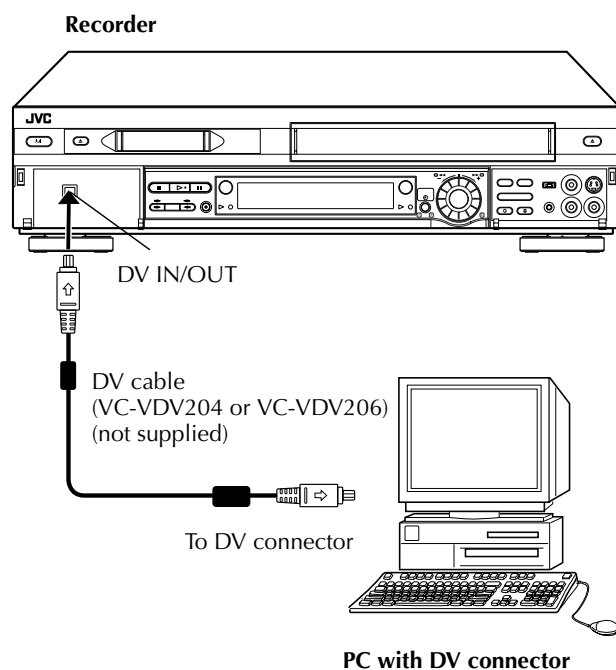

NOTES:

- It is possible to control the DV deck from the PC with DV connector by using some of the commercially sold or pre-installed DV editing software. Refer to the instruction manuals of PC and software.
- The system may not work properly depending on the PC or DV editing software.
- When connecting this VCR to a PC with a DV connector, be sure to use the optional DV cable (VC-VDV204 or VC-VDV206).

Audio Dubbing

VHS Audio Dubbing

Audio Dubbing replaces the normal audio sound of a previously recorded tape with a new soundtrack.

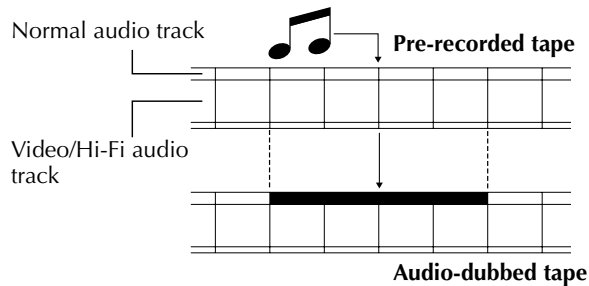

DV Audio Dubbing

This function lets you record new audio, without erasing the original audio, on a DV tape that was recorded with "SOUND MODE" set to "12BIT" (pg. 76).

ATTENTION:

You cannot perform Audio Dubbing on a tape that was recorded with "SOUND MODE" set to "16BIT" (pg. 76), on a tape that was recorded at the "LP" speed, or on a blank tape.

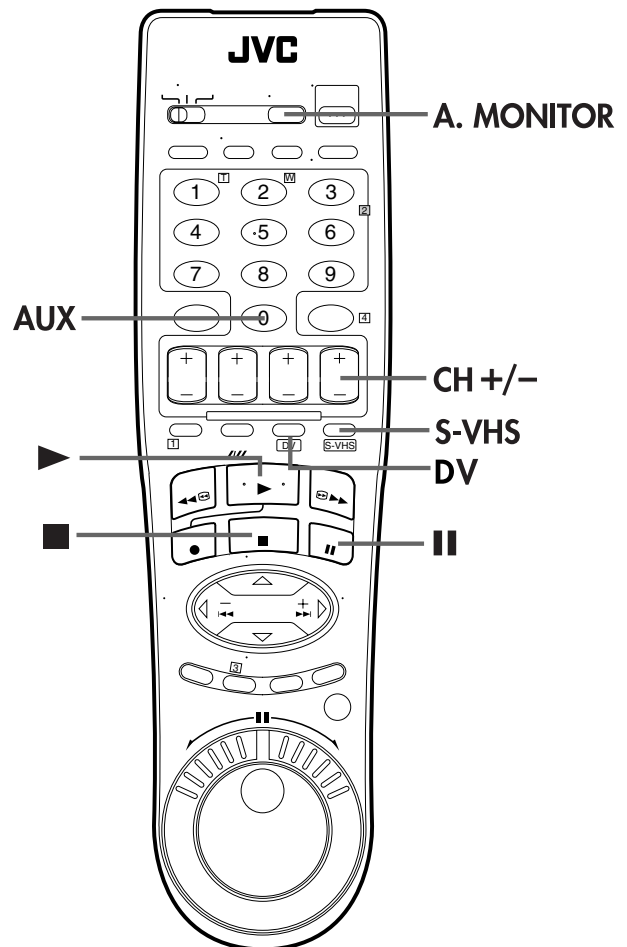
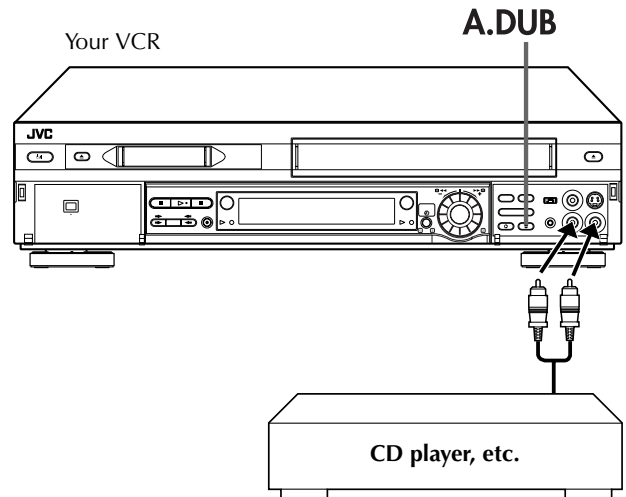

1 Make connections.

Connect an audio component to the AUDIO L + R input connectors on the VCR's front panel.

- When connecting a monaural audio component, use only the VCR's AUDIO L input connector.

2 Load a cassette.

For the VHS deck

Insert a VHS (or S-VHS) cassette with the record safety tab intact, or cover the hole using adhesive tape.

For the DV deck

Insert a Mini DV cassette with the erase protection switch set to "REC".

3 Set the VCR's input mode.

Press **AUX** (number key "0") and/or **CH +/-** to select "F-1".

4 Select the recording deck.

Press **S-VHS** or **DV**.

- When using the DV deck as the recording deck, press **←** so that the audio signals from the AUDIO L + R input connectors can be recorded. The dubbing direction indicator (**↔** S-VHS) lights.

5 Locate the start point.

Press **PLAY** (▶) to start playback of the tape in your VCR, and press **PAUSE** (⏸) when you reach the point where you want to start dubbing.

6 Engage the Audio Dubbing mode.

Press **A.DUB**.

- Your VCR enters the Audio Dubbing Pause mode. ("⦿" blinks, "⦿" and "⦿" light up on the front display panel.)

7 Start dubbing.

Engage the audio component's Play mode, then press **PLAY** (▶) to start the tape in your VCR; Audio Dubbing begins at this point.

- "⦿" blinks and "⦿" is displayed on the front display panel.
- To stop dubbing temporarily, press **PAUSE** (⏸). Press **PLAY** (▶) to resume dubbing.

8 End Audio Dubbing.

Press **STOP** (■) to stop the tape in your VCR, and engage the audio component's Stop mode.

NOTES:

- Once the Audio Dubbing starts, you can not use the other deck.
- When monitoring the audio-dubbed sound on the DV deck, set "12BIT MODE" to "SOUND2" (⦿ pg. 76).
- When monitoring the sound during Audio Dubbing, the normal soundtrack is automatically selected. If you wish to hear the mixed sound (Hi-Fi + Normal soundtracks), press **A. MONITOR** to select "NORM HI FI" (⦿ pg. 31). (VHS deck only)
- Audio Dubbing stops automatically when the counter reaches "0:00:00", and the VCR enters the Play mode. Check the counter reading before dubbing. (VHS deck only)
- Audio Dubbing is also possible using the rear panel **AUDIO IN** connector.
- When playing back an audio-dubbed tape on the VHS deck, press **A. MONITOR** on the Remote to select the soundtrack you wish to hear (⦿ pg. 31). When playing back an audio-dubbed Mini DV tape on the DV deck, set "12BIT MODE" to "SOUND2" (⦿ pg. 76).
- Picture may be distorted during Audio Dubbing Pause.
- It may be unlawful to record or play back copyrighted material without the consent of the copyright owner.
- Audio dubbing is not possible using the DV IN/OUT connector.
- Audio dubbing is not possible on a blank portion of the tape.

Insert Editing

VHS Insert Editing

Insert Editing replaces part of the recorded scene with new material. Both the picture and Hi-Fi audio soundtrack are replaced with new ones, while the normal audio soundtrack remains unchanged. If you wish to change the normal audio track as well, use the Audio Dubbing function simultaneously. For Insert Editing, use your VCR as the recording deck.

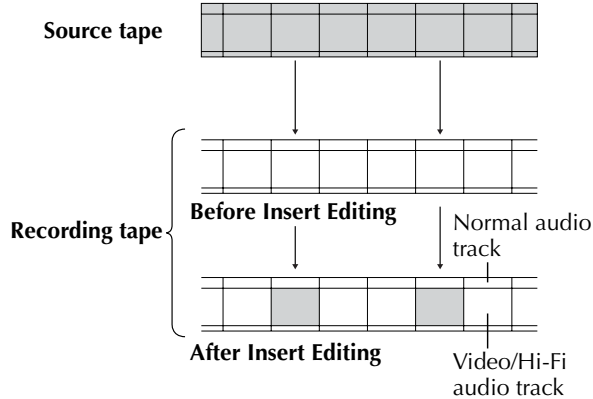

DV Insert Editing (SP mode only)

The picture is replaced with new one, while the audio soundtrack remains unchanged. For Insert Editing, use your VCR as the recording deck.

ATTENTION:

Insert Editing is not possible with a Mini DV cassette recorded in LP mode or on a blank tape.

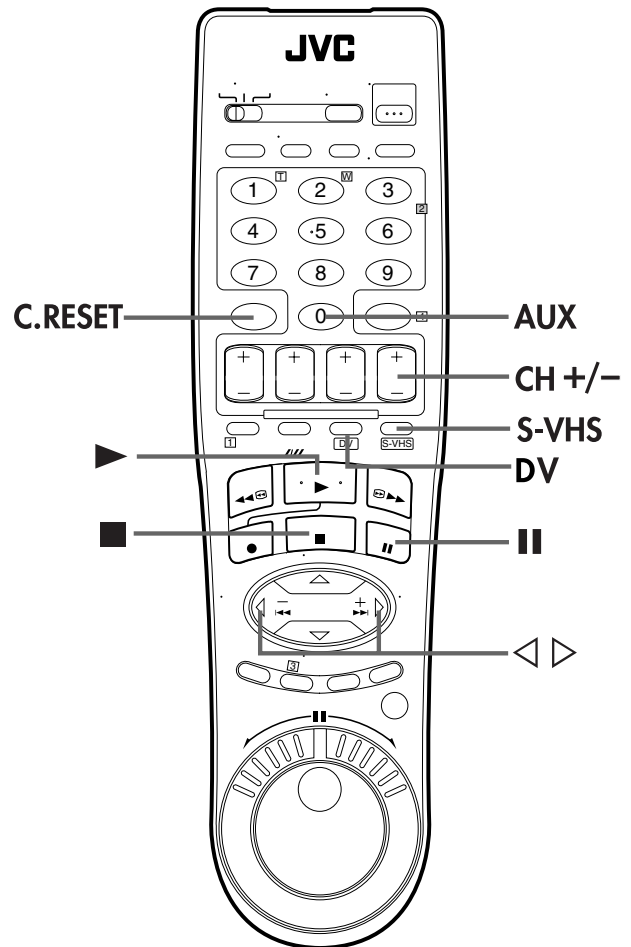
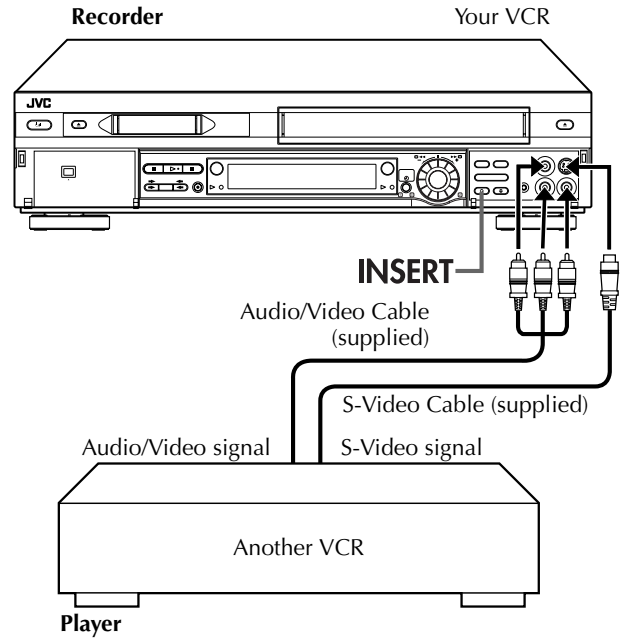

1 Make connections.

Connect the player's VIDEO OUT or S-VIDEO OUT and AUDIO OUT connectors to your VCR's VIDEO or S-VIDEO and AUDIO input connectors.

2 Set the VCR's input mode.

Press **AUX** (number key "0") and/or **CH +/-** to select "F-1" (or "L-1" if you use the connectors on the rear).

- When using S VIDEO connector, set "FRONT AUX INPUT" (or "REAR AUX INPUT" if you use the connectors on the rear) to "S-VIDEO". (☞ pg. 71, 73)
- When using VIDEO connector, set "FRONT AUX INPUT" (or "REAR AUX INPUT") to "VIDEO". (☞ pg. 71, 73)

3 Select the recording deck.

Press **S-VHS** or **DV**.

- When using the DV deck as the recording deck, press ◀ so that the video and audio signals from the VIDEO/S-VIDEO and AUDIO L + R input connectors can be recorded. The dubbing direction indicator (⇌ S-VHS) lights.

4 Prepare the recording cassette.

For the VHS deck

Load the recording cassette into the VHS deck, and play it back to determine the edit-out point (the end of the segment to be replaced) using the **ADVANCED JOG** dial, or pressing ◁▷ and **PAUSE (II)**. Then press **C.RESET** to reset the counter.

For the DV deck

Load the recording cassette into the DV deck.

5 Locate the start point.

Determine the edit-in point (the beginning of the segment to be replaced) using the **ADVANCED JOG** dial, or pressing ◁▷ and **PAUSE (II)**.

- Be sure to engage the Still mode at the edit-in point.

6 Engage the Insert Editing mode.

Press **INSERT**.

- Your VCR enters the Insert Pause mode. ("○", "▶" and "■" light up on the front display panel.)
- The TV screen changes from the still picture to the input source you are going to record.

7 Start Editing.

Load the source cassette and play back the segment that is to be inserted. When you reach the start of the section of the source tape that you wish to insert, press **PLAY (▶)** to start the tape in your VCR; Insert Editing begins at this point.

- "○" and "▶" are displayed on the front display panel.

8 End Insert Editing.

For the VHS deck

At counter "0:00:00", Insert Editing will stop automatically while the tape continues running in the Play mode. If you wish to stop Insert Editing before the specified edit-out point, press **C.RESET**.

For the DV deck

Press **STOP (■)** to stop recording on the DV deck.

AV Insert Editing (VHS deck only)

If you want to replace the picture, Hi-Fi audio soundtrack and normal audio soundtrack all at the same time ...

... In step 6, after you press **INSERT**, press **A.DUB** also.

("○" and "▶" blink and "■" lights up on the front display panel.)

NOTES:

- Once the Insert Editing starts, you can not use the other deck.
- All necessary cables can be obtained from your dealer.
- Insert Editing cannot be performed on a VHS (or S-VHS) cassette that has had its record safety tab removed, or on a Mini DV cassette that has had its erase protection switch set to "SAVE".
- When Insert Editing is performed on a tape that has been recorded on another VCR, the inserted portion may appear distorted.
- In Insert Editing, the recording speed (SP/EP) is determined by the previous recording to be replaced. If the previous recording's speed changes within a single edit, the inserted picture will be distorted at the switching point. (VHS deck only)
- A small portion of the recording which precedes an insert edit may become erased.
- Insert Editing is also possible using the rear panel connectors. When using these connectors, be sure to set "REAR AUX INPUT" to the appropriate mode. (☞ pg. 71)
- Insert Editing is not possible using the DV IN/OUT connector.
- Insert Editing is not possible on a blank portion of the tape.

Random Assemble Editing

64-program Editing Memory (8 programs x 8 scenes)

By using the Random Assemble Editing function, you can select up to 8 scenes from a previously recorded Mini DV cassette and automatically dub them onto a VHS (or S-VHS) cassette. Random Assemble Editing is possible only when dubbing from the DV deck to the VHS deck.

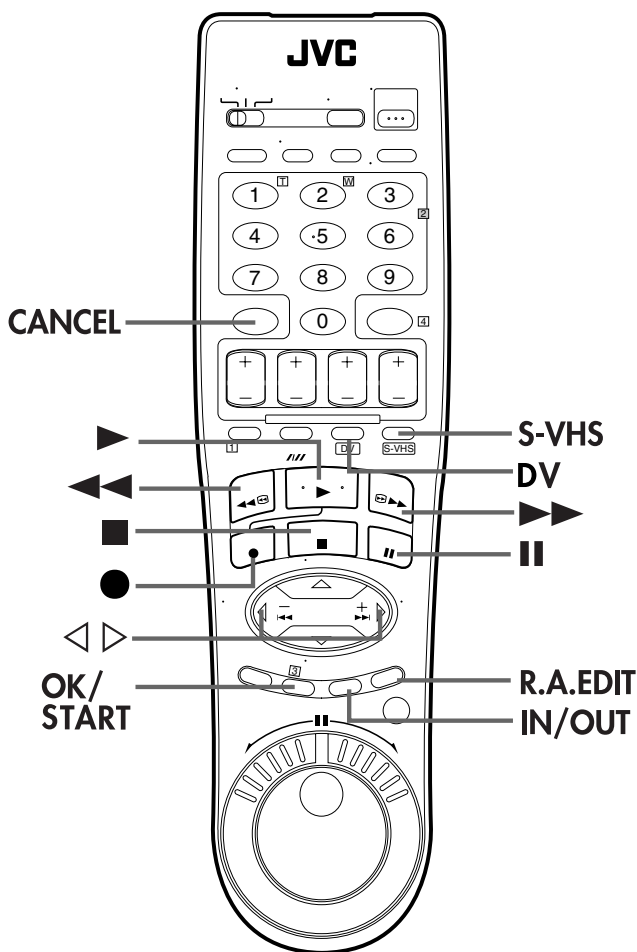
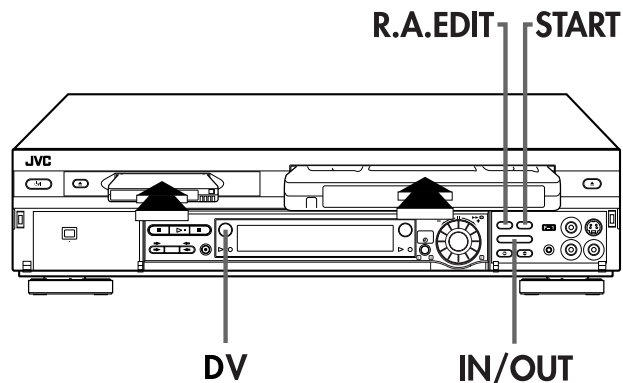

1 Load cassettes.

For the VHS deck

Insert a VHS (or S-VHS) cassette with the record safety tab intact, or cover the hole using adhesive tape.

For the DV deck

Insert a Mini DV cassette with the erase protection switch set to "SAVE".

2 Select the DV deck.

Press DV.

3 Access the R.A.Edit screen.

Press R.A.EDIT. The R.A.Edit screen appears.

4 Select the program.

Press Δ / ∇ to move the arrow to select one program you want to edit, then press OK or \triangleright .

- To remove a program from the R.A.EDIT screen, select the program number, then press CANCEL for more than 2 seconds.

DV → VHS			
☑ P1	3:46 PM	1/24/2000	
P2	--:-- AM	--/--/--	
P3	--:-- AM	--/--/--	
P4	--:-- AM	--/--/--	
P5	--:-- AM	--/--/--	
P6	--:-- AM	--/--/--	
P7	--:-- AM	--/--/--	
P8	--:-- AM	--/--/--	

PRESS (\blacktriangle , \blacktriangledown), THEN START

5 Locate the start point.

Press PLAY (\blacktriangleright) to start playback. Find the edit-in point on the source tape from where you want the edited scene to begin by pressing PAUSE (\parallel), then press IN/OUT.

- The edit-in point is registered in memory and appears on the screen.

P1	IN	OUT
1	-:--:-->	
2		→
3		→
4		→
5		→
6		→
7		→
8		→

TC 0:00:00 TOTAL 0:00:00

6 Locate the end point.

Press **PLAY** (▶) to start playback. Find the edit-out point where you want the edited scene to end by pressing **PAUSE** (■), then press **IN/OUT**.

- The edit-out point is registered in memory and appears on the screen.
- The total time of the edited scenes is displayed to the right of "TOTAL".
- Repeat steps 5 and 6 for each additional scene.

P1	IN	OUT
1	0:02:23	→ -: -: -:
2		→
3		→
4		→
5		→
6		→
7		→
8		→
TC	0:02:23	TOTAL 0:00:00

P1	IN	OUT
1	0:02:23	→ 0:02:51
2		→
3		→
4		→
5		→
6		→
7		→
8		→
TC	0:02:51	TOTAL 0:00:28

7 Prepare the source tape.

Rewind the tape in the DV deck to the beginning of the scene you want to edit.

8 Prepare the VHS deck for dubbing.

- 1 Press **S-VHS**.
- 2 Search for the point where you want to start dubbing by pressing **PLAY** (▶), **FF** (▶▶) or **REW** (◀◀) then press **STOP** (■).
- 3 Press **REC** (●), then the VHS deck enters the Record Pause mode.

9 Start Random Assemble Editing.

Press **START** (or **OK**).

- Automatic editing begins; all the specified scenes are copied to the VHS deck in the order they were registered.
- The on-screen display remains while your VCR searches for each scene (blinking cursor indicates scene currently being searched for), but disappears during actual editing.
- During scene search, the VHS deck automatically enters its Record-Standby mode.
- When all registered scenes have been edited, the DV deck enters the Pause mode, the VHS deck enters its Record Pause mode, and "- : - : - : -" blinks at the next available number.

10 End Random Assemble Editing.

Press **R.A.EDIT** twice to return to the normal screen.

Press **STOP** (■) to stop the VHS deck's Record Pause mode.

Press **DV**, then press **STOP** (■) to stop the DV deck's Pause mode.

To Make Corrections ...

... in step 5 or 6, you can cancel registered in and out points by pressing **CANCEL**. Each time you press, the preceding point is erased.

- If, for example, you have registered 5 sets of in and out points and want to reset the first set, you have to press **CANCEL** until all points after the first set have been erased. Reenter them after you have repaired the first set of points.

NOTES:

- When Random Assemble Editing does not work, press **▶**, then perform Random Assemble Editing again.
- To cancel the registered scene, press **CANCEL**. Each time **CANCEL** is pressed, the latest registered scene is erased.
- When the source tape has more than 2 identical time codes (☞ pg. 41), the VCR may not find the edit-in point you set and a malfunction may occur.
- When choosing a scene, set edit-in and edit-out points so that there's a relatively large difference between them.
- If the search time for an in-point exceeds 5 minutes, the VHS deck's Record-Pause mode will be cancelled and editing will not take place.
- If there are blank portions before or after the edit-in and edit-out points, a blue-backed screen may be included in the edited version.
- Since time codes register time only as accurately as seconds, the time code total time may not match the total program time exactly.
- To use Random Assemble Editing consecutively for two or more programs, press **START** for each program. When dubbing from another Mini DV cassette, change the Mini DV cassette first, and then press **START**.

Remote A/B Code Switching

This Remote is capable of transmitting two control codes; one set to respond to A code control signals and another set to respond to B code control signals. This Remote control is preset to send A code signals because your VCR is initially set to respond to A code signals. You can easily modify your VCR and the Remote to respond to B code signals. When using two JVC VCRs, set two VCRs and their Remotes to different codes, so that you can operate these VCRs separately.

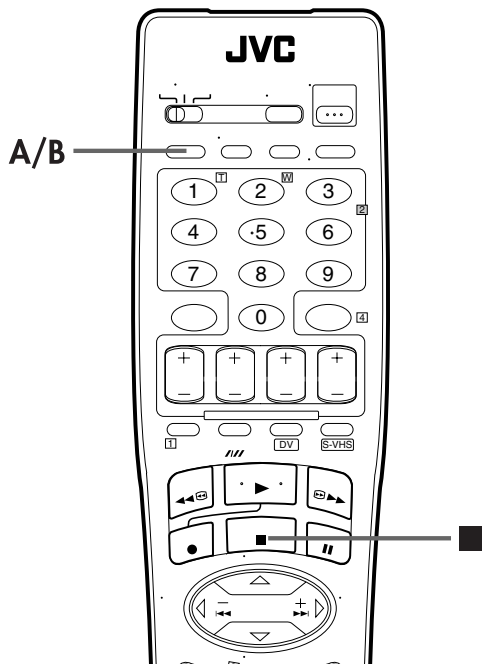
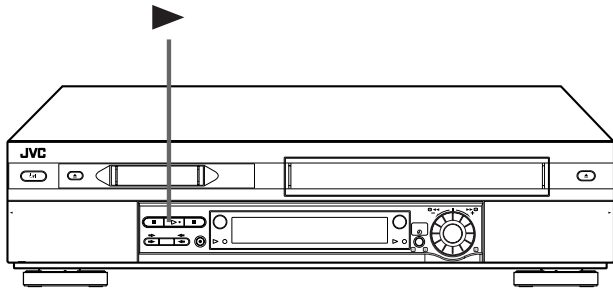

1 Set the remote control code for Remote.

- 1 Press and hold **A/B**.
- 2 Press the **number key "2"**.
- 3 Press **STOP** (■), and release **A/B**.

- The Remote now can transmit B code control signals.

2 Check the remote control code for VCR.

Press and hold **PLAY** (▶) on the VCR for more than 5 seconds while the VCR is turned off. The code currently set appears on the display panel.

3 Change the code for VCR.

Press any key on the Remote. The VCR now responds to B code control signals.

- To set the Remote and the VCR back to A code control signals, repeat the same procedure as shown above except pressing the **number key "1"** in step 2 of 1.

To control two VCRs with the same Remote

You can control two JVC VCRs by switching the remote control code for the Remote between A and B (step 1), keeping two VCRs to different control codes.

- To change only the remote control code for the Remote, DO NOT perform steps 2 and 3.

TV Multi-Brand Remote Control

Your Remote can operate the basic functions of your TV set. In addition to JVC TVs, other manufacturer's TVs can also be controlled.

Before performing the following steps:

Turn ON the TV using its Remote.

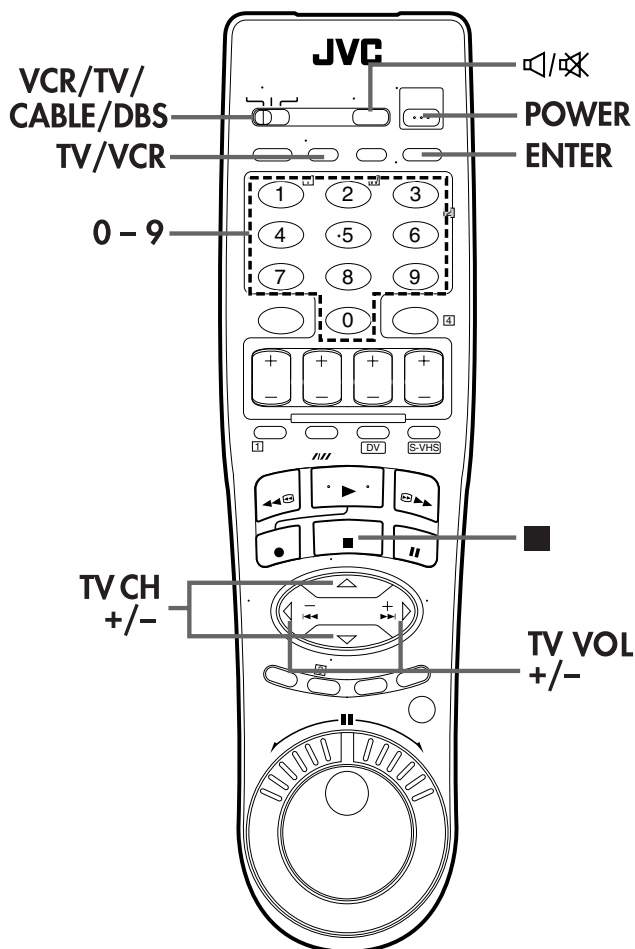

1 Set the TV brand code.

- 1 Set the **VCR/TV/CABLE/DBS** switch on the VCR's Remote to TV.
 - 2 Press and hold **POWER**.
 - 3 Press the **number keys** to enter your TV's brand code.
 - 4 Press **STOP** (■), and release **POWER**. The TV should turn off. If it does, try other operation (☞ step 2).
- Once you have set the Remote to operate the TV, you do not have to repeat this step until you replace your Remote's batteries.
 - Some brands of TV have more than one code. If the TV does not function with one code, try entering another.

2 Operate the TV.

Press the corresponding button: **POWER**, **TV/VCR**, **TV CH +/-**, **TV VOL +/-**, **Muting** (TV Muting), **number keys**.

- For some brands of TV, you must press **ENTER** after having pressed the **number keys**.
- To return the Remote to VCR control, Set the **VCR/TV/CABLE/DBS** switch to VCR.

BRAND NAME	CODE
JVC	01, 03
HITACHI	10
MAGNAVOX	02
MITSUBISHI	03
PANASONIC	04, 11
RCA	05
SHARP	06
SONY	07
SAMSUNG	12
SANYO	13
SEARS	13
TOSHIBA	08
ZENITH	09

IMPORTANT

Although the supplied Remote unit is compatible with JVC televisions, as well as many other models, it may not work with your TV or in some instances, may have limited function capability.

Cable Box Multi-Brand Remote Control

Your Remote can operate the basic functions of your cable box set. In addition to JVC cable boxes, other manufacturer's cable boxes can also be controlled.

Before performing the following steps:
Turn ON the cable box using its Remote.

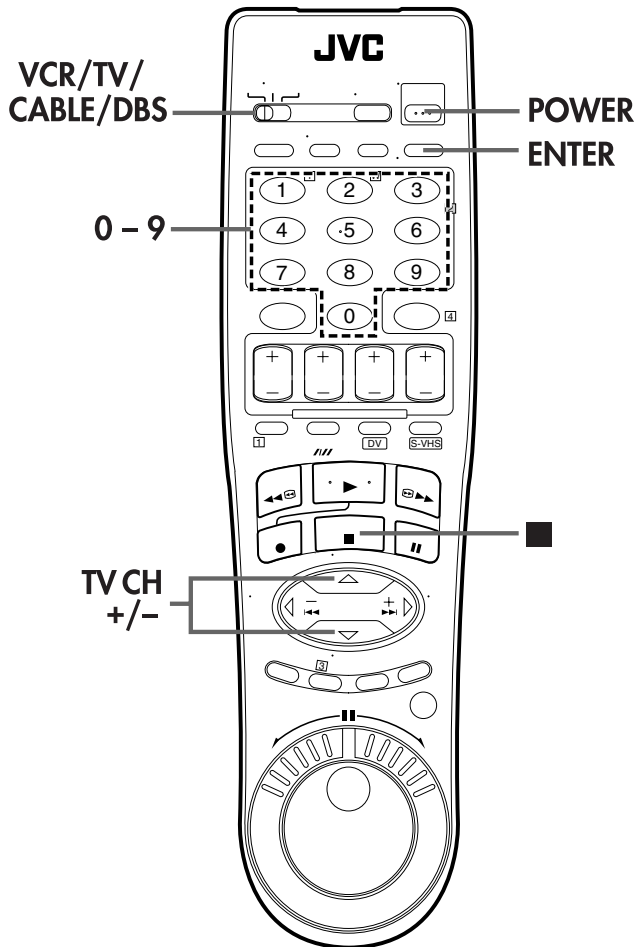

IMPORTANT

It may not work with your cable box, or in some instances, may have limited function capability.

NOTES:

- You must set the cable box brand for your Remote and the cable box brand for your Controller (pg. 21) separately. The list of cable box brands that can be controlled by your Remote is different from the list of brands that can be controlled by your controller.
- It's not possible to set the Remote for both your cable box and a DBS receiver at the same time. You can only set the Remote to operate one of these units at a time.

1 Set the Cable Box brand code.

- 1 Set the **VCR/TV/CABLE/DBS** switch on the VCR's Remote to CABLE/DBS.
 - 2 Press and hold **POWER**.
 - 3 Press the **number keys** to enter your cable box's brand code.
 - 4 Press **STOP** (■), and release **POWER**. The cable box should turn off. If it does, try other operations (step 2).
- Once you have set the Remote to operate the cable box, you do not have to repeat this step until you replace your Remote's batteries.
 - Some brands of cable box have more than one code. If the cable box does not function with one code, try entering another.

2 Operate the Cable Box.

Press the corresponding button: **POWER**, **TV CH +/-**, **number keys**.

- For some brands of cable box, you must press **ENTER** after having pressed the **number keys**.
- To return the Remote to VCR control, Set the **VCR/TV/CABLE/DBS** switch to VCR.

BRAND NAME	CODE
ARCHER	01, 05, 17
CABLETENNA	01, 17
CABLEVIEW	15, 16, 17, 21, 25
CITIZEN	15, 16, 17, 21, 25
CURTIS	02
DIAMOND	01, 17
GC BRAND	15, 16, 17, 21, 25
GEMINI	15
GENERAL INSTRUMENTS	01, 04, 06, 11, 12, 15, 28
HAMLIN	10, 18, 23
JASCO	15
JERROLD	01, 04, 06, 11, 12, 15, 28
NOVAVISION	02
OAK	07
PANASONIC	13, 14
PULSER	15, 16, 17, 21, 25
RCA	13, 14
REGAL	10, 18, 23
REMBRANDT	01, 16, 17
SAMSUNG	05, 16, 24
SCIENTIFIC ATLANTA	02
SIGMA	07
SL MARX	05, 16, 17, 24, 25
SPRUCER	13, 14
STARGATE	05, 15, 16, 17, 21, 24, 25
TELEVIEW	05, 16, 24
TOCOM	01, 04, 16
UNIKA	01, 17
UNIVERSAL	16, 17, 25
VIDEOWAY	03, 09, 22
ZENITH	03, 09, 22

DBS Receiver Multi-Brand Remote Control

Your Remote can operate the basic functions of your DBS (Direct Broadcast Satellite) receiver set. In addition to JVC DBS receivers, other manufacturer's DBS receivers can also be controlled.

Before performing the following steps:

Turn ON the DBS receiver using its Remote.

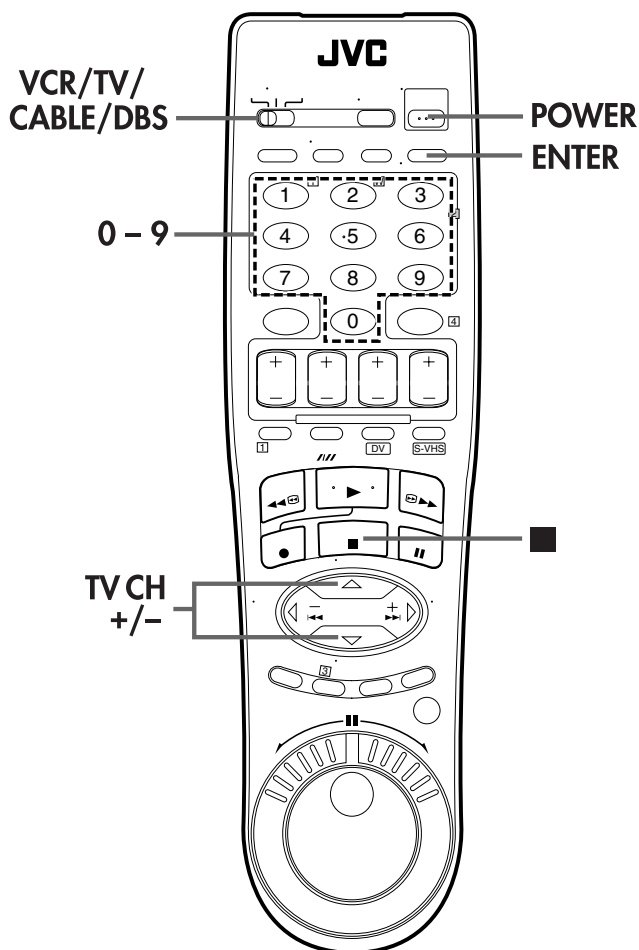

IMPORTANT

Although the supplied Remote unit is compatible with JVC DBS receivers, as well as many other models, it may not work with your DBS receiver, or in some instances, may have limited function capability.

1 Set the DBS receiver brand code.

- 1 Set the **VCR/TV/CABLE/DBS** switch on the VCR's Remote to **CABLE/DBS**.
 - 2 Press and hold **POWER**.
 - 3 Press the **number keys** to enter your DBS receiver's brand code.
 - 4 Press **STOP** (■), and release **POWER**. The DBS receiver should turn off. If it does, try other operations (☞ step 2).
- Once you have set the Remote to operate the DBS receiver, you do not have to repeat this step until you replace your Remote's batteries.
 - Some brands of DBS receiver have more than one code. If the DBS receiver does not function with one code, try entering another.

2 Operate the DBS receiver.

Press the corresponding button: **POWER**, **TV CH +/-**, **number keys**.

- For some brands of DBS receiver, you must press **ENTER** after having pressed the **number keys**.
- To return the Remote to VCR control, Set the **VCR/TV/CABLE/DBS** switch to VCR.

BRAND NAME	CODE
JVC (DISH Network)	51
ECHOSTAR (DISH Network)	51
SONY (DSS)	41
RCA (DSS)	40

NOTES:

- You must set the DBS receiver brand for your Remote and the DBS receiver brand for your Controller (☞ pg. 24) separately.
- It's not possible to operate a DBS receiver that is not equipped with a remote control sensor.
- It's not possible to set the Remote for both your DBS receiver and a cable box at the same time. You can only set the Remote to operate one of these units at a time.

Mode Set

Turn on the TV and select the AV mode.

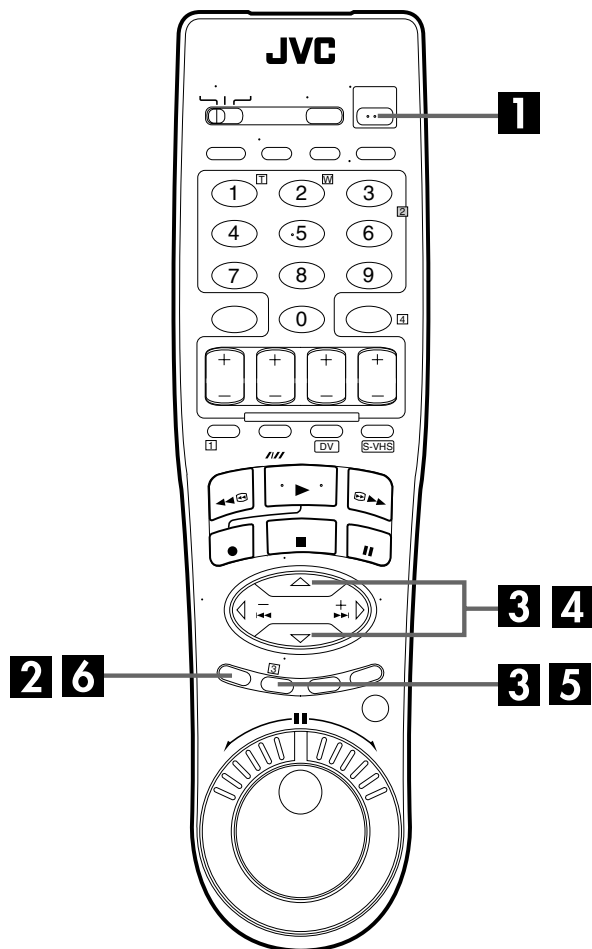

You can change various mode settings on TV screen by following the procedure described below.
For each mode setting, see pages 71 to 76.

MODE SET	pg. 71
VHS MODE SET	pg. 72
DV MODE SET	pg. 76

- The procedure shows how to set "SUPERIMPOSE" to "ON" on the "MODE SET" screen as an example.

1 Turn on the VCR.

Press **POWER**.

2 Access the Main Menu screen.

Press **MENU**.

3 Access the Mode Set screen.

Press Δ / ∇ to move the highlight bar (arrow) to "MODE SET", then press **OK** or \triangleright .

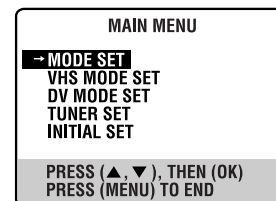

4 Select the mode.

Press Δ / ∇ to move the highlight bar (arrow) to "SUPERIMPOSE".

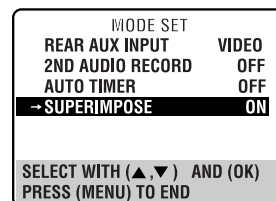

5 Select the mode setting.

Press **OK** or \triangleright .

6 Return to the normal screen.

Press **MENU**.

MODE SET

* The default setting is **bold** in the table below.

<p>■ REAR AUX INPUT VIDEO S-VIDEO</p>	<p>Select the appropriate mode depending on the connector being used on the rear panel.</p> <p>VIDEO: To use the VIDEO input connector on the rear panel. S-VIDEO: To use the S-VIDEO input connector on the rear panel.</p>
<p>■ 2ND AUDIO RECORD ON OFF</p>	<p>● When this function is set to “ON”; If a SAP program is received, the SAP audio is recorded on both the normal and Hi-Fi tracks. The main audio is not recorded. If a non-SAP program is received, the main audio is recorded on both the Hi-Fi and normal tracks.</p> <p>● When this function is set to “OFF”, the SAP audio cannot be recorded.</p> <p>NOTES: <i>When the channel is changed on the VCR;</i></p> <ul style="list-style-type: none"> ● The “STEREO” indicator appears on the screen for about 5 seconds if the program is a stereo broadcast. ● The “SAP” indicator appears on the screen for about 5 seconds if the program is a SAP broadcast. ● Both indicators appear when a stereo program is accompanied by SAP sound.
<p>■ AUTO TIMER ON OFF</p>	<p>When this function is set to “ON”, the timer is automatically engaged when the VCR power is turned off, and automatically disengaged when the VCR is powered back on.</p> <p>NOTE: <i>For safety, when “AUTO TIMER” is set to “OFF”, all other VCR functions are disabled while the Timer mode is engaged. To disengage the timer, press TIMER.</i></p>
<p>■ SUPERIMPOSE ON OFF</p>	<p>When this function is set to “ON”, various operational indicators appear on the TV screen. Messages appear in the selected language (☞ pg. 15).</p> <p>NOTES:</p> <ul style="list-style-type: none"> ● <i>When you use this VCR as the source player for editing, be sure to set “SUPERIMPOSE” to “OFF” before starting.</i> ● <i>During playback, the operation mode indicators may be disturbed depending on the type of tape being used.</i>

VHS MODE SET

* The default setting is **bold** in the table below.

<p>■ S-VHS ET ON OFF</p>	<p>You can record on VHS cassettes with S-VHS picture quality. Tapes recorded using this function can be played back on a VCR equipped with the S-VHS ET function. When this function is set to "ON", the S-VHS indicator lights up on the front display panel.</p> <p>NOTES:</p> <ul style="list-style-type: none"> ● You can activate the S-VHS ET function only before you start recording on a VHS cassette. ● Before recording, make sure that "VIDEO CALIBRATION" is set to "ON". (☞ pg. 73) ● You cannot activate the S-VHS ET function ... <ul style="list-style-type: none"> ... while recording is in progress. ... while timer-recording or Instant Timer Recording (☞ pg. 32) is in progress. ... while Video Calibration (☞ pg. 35) is in progress. ● The S-VHS ET function does not work with S-VHS cassettes. ● To keep the highest quality recording and playback pictures over a long period of time, S-VHS recording on S-VHS cassettes is recommended. ● Use of high grade tapes is recommended for S-VHS ET recordings. On some tapes, picture quality will not improve even if the S-VHS ET function is used. Check the recording quality before you start important recordings. ● You can play back a tape recorded using the S-VHS ET function on most of S-VHS VCRs and of VHS VCRs equipped with SQPB (S-VHS QUASI PLAYBACK) function. (Notice some VCRs are not compatible with the S-VHS ET function.) ● While playing back a tape recorded using the S-VHS ET function on some VCRs, noise may appear. (If playback picture becomes blurred or interrupted, use a cleaning cassette.) ● In the high-speed search, still, slow-motion or frame-by-frame playback modes (☞ pg. 28), noise may appear. If these modes are performed frequently on a tape recorded using the S-VHS ET function, the tape may be damaged and the picture may be deteriorated.
<p>■ S-VHS MODE ON OFF</p>	<p>Your VCR can record in S-VHS (Super VHS), S-VHS ET or VHS.</p> <ul style="list-style-type: none"> ● To record in S-VHS: Set "S-VHS MODE" to "ON". Then, insert a cassette marked "S-VHS". The S-VHS indicator lights up on the front display panel. The S-VHS recording mode is selected. ● To record in S-VHS ET on a VHS cassette: Set "S-VHS ET" to "ON". (☞ See above.) Then, insert a cassette marked "VHS". The S-VHS indicator lights up on the front display panel. ● To record in VHS: Insert a cassette marked "VHS". Set "S-VHS ET" to "OFF". (☞ See above.) ● To record in VHS on an S-VHS cassette: Insert a cassette marked "S-VHS". The S-VHS indicator lights up on the front display panel. Then, set "S-VHS MODE" to "OFF". The S-VHS indicator goes off. The VHS recording mode is selected. <p>NOTE: When playing back a tape that has been recorded in S-VHS or S-VHS ET, the S-VHS indicator lights up on the front display panel regardless of the "S-VHS MODE" setting.</p>

VHS MODE SET (cont.)

* The default setting is **bold** in the table below.

<p>■ VIDEO CALIBRATION ON OFF</p>	<p>When this function is set to "ON", this VCR checks the condition of the tape in use during playback and recording, and compensates to provide the highest-possible pictures. This takes place whenever you play back a tape or start recording after inserting a tape. (☞ pg. 35)</p>
<p>■ PICTURE CONTROL AUTO EDIT SOFT SHARP</p>	<p>This feature helps you to adjust the playback picture quality according to your preference. Normally select "AUTO".</p> <p>AUTO: Provides the optimized picture benefits of the VIDEO CALIBRATION Picture System.</p> <p>EDIT: Minimizes picture degradation during editing (recording and playback).</p> <p>SOFT: Reduces image coarseness when viewing overplayed tapes containing a lot of noise.</p> <p>SHARP: Clearer, sharper-edged picture when viewing images with lots of flat, same-coloured surfaces such as cartoons.</p> <p>NOTES:</p> <ul style="list-style-type: none"> ● When you select "EDIT", "SOFT" or "SHARP", the selected mode will not change until you select another mode. ● When you select "EDIT" to dub tapes, be sure to select "AUTO" after you finish dubbing the tapes. ● When "VIDEO CALIBRATION" is "OFF", "PICTURE CONTROL" switches automatically from "AUTO" to "NORM".
<p>■ FRONT AUX INPUT VIDEO S-VIDEO</p>	<p>Select the appropriate mode depending on the connector being used on the front panel.</p> <p>VIDEO: To use the VIDEO input connector on the front panel.</p> <p>S-VIDEO: To use the S-VIDEO input connector on the front panel.</p>

VHS MODE SET (cont.)

* The default setting is **bold** in the table below.

<p>■ AUTO SP→EP TIMER ON OFF</p>	<p>When this function is set to “ON”, the VCR automatically switches to EP mode to allow complete recording if there is not enough tape to record the entire program while timer-recording in SP mode.</p> <p>For Example . . . Recording a program of 140 minutes in length onto a 120-minute tape</p> <p style="text-align: center;">Approximately 110 minutes Approximately 30 minutes</p> <table border="1" style="margin-left: auto; margin-right: auto;"> <tr> <td style="width: 50%; text-align: center;">SP mode</td> <td style="width: 50%; text-align: center;">EP mode</td> </tr> </table> <p style="text-align: center;">Total 140 minutes</p> <p>Make sure you set this function to “ON”, before the timer-recording starts.</p> <p>NOTES:</p> <ul style="list-style-type: none"> ● If you have programed the VCR to timer-record 2 or more programs, the second program and those thereafter may not fit on the tape if you set “AUTO SP→EP TIMER” to “ON”. In this case, make sure the mode is not engaged, then set the tape speed manually during timer programing. ● In order to ensure that the recording fits on the tape, this feature may leave a slight non-recorded section at the end of the tape. ● There may be some noise and sound disturbance at the point on the tape where the VCR switches from SP to EP mode. ● The Auto SP→EP Timer feature is not available during ITR (Instant Timer Recording), and the feature will not work properly on the following tapes: T(ST)-30, T(ST)-60, T(ST)-90, and T(ST)-120. 	SP mode	EP mode
SP mode	EP mode		
<p>■ BLUE BACK ON OFF</p>	<p>When this function is set to “ON”, the TV screen becomes all blue when receiving a channel not in use.</p> <p>NOTE: When you want to receive an unstable channel with poor signals, set this function to “OFF”.</p>		
<p>■ DIGITAL TBC/NR ON OFF</p>	<p>Your VCR is equipped with the Digital TBC (Time Base Corrector) that removes jitter from fluctuating video signals to deliver a stable picture even with old tapes and rental cassettes.</p> <p>The on/off of Digital 3-DNR (Noise Reduction) which cuts noise and enables clear picture reproduction is also linked to this function.</p> <p>We recommend that you set “DIGITAL TBC/NR” to “ON” when ...</p> <ul style="list-style-type: none"> ... playing back a tape recorded on a camcorder. ... playing back a tape repeatedly used. ... using this VCR as the source player for editing. <p>NOTES:</p> <ul style="list-style-type: none"> ● If you play back a tape recorded under poor TV reception condition, the picture may become more stable with Digital TBC/NR set to off. ● When “DIGITAL TBC/NR” is set to “ON”, if you play back a tape where certain types of signals are recorded (using a PC or some character generators), the playback picture may be distorted. If this is the case, set “DIGITAL TBC/NR” to “OFF”. 		

VHS MODE SET (cont.)

* The default setting is **bold** in the table below.

<p>■ VIDEO STABILIZER ON OFF</p>	<p>When this function is set to "ON", you can automatically correct vertical vibration in the picture when playing back unstable recordings made on another VCR.</p> <p>NOTES:</p> <ul style="list-style-type: none"> • When you finish viewing a tape, be sure to set this function to "OFF". • Regardless of the setting, this function has no effect during recording and during special effects playback. • The on-screen display may jitter vertically when this function is set to "ON". • To watch recordings with close-caption, set this function to "OFF". • Video Stabilizer and Digital TBC/NR cannot be used at the same time. If you activate Digital TBC/NR when "VIDEO STABILIZER" is set to "ON", Video Stabilizer will be automatically turned "OFF".
<p>■ DIGITAL R3 ON OFF</p>	<p>When this function is set to "ON", the Digital R3 picture system applies edge correction to the luminance signal to enhance details.</p> <p>NOTES:</p> <ul style="list-style-type: none"> • Normally it is recommended to keep "DIGITAL R3" set to "ON". • Depending on the type of tape being used, picture quality may be better with "DIGITAL R3" set to "OFF". • If you use the VCR as the source player for editing, be sure to set "DIGITAL R3" to "OFF" before starting.
<p>■ AUDIO MONITOR HI-FI HI-FI L HI-FI R NORM MIX</p>	<p>This VCR can record two sound tracks simultaneously (normal and Hi-Fi) on a Hi-Fi stereo tape. You can select the sound track(s) to listen to while playing back a Hi-Fi stereo tape. In addition, when playing back a prerecorded tape containing two separate audio programs on the Hi-Fi tracks, you can choose either one by selecting either "HI-FI L" or "HI-FI R".</p> <p>HI-FI: Normally select this. Hi-Fi sound is played back. HI-FI L: Sound on the left Hi-Fi channel is played back. HI-FI R: Sound on the right Hi-Fi channel is played back. NORM: Sound on the normal track is played back. MIX: Both sounds on the Hi-Fi track and normal track are mixed and played back.</p> <p>NOTES:</p> <ul style="list-style-type: none"> • While playing back a monaural tape, sounds on the normal track will be heard regardless of this setting. • You can also use the A. MONITOR button on the Remote to select the desired monitor sound. (☞ pg. 31)

DV MODE SET

* The default setting is **bold** in the table below.

<p>■ SOUND MODE 12BIT 16BIT</p>	<p>Select the appropriate mode before recording on a Mini DV tape.</p> <p>12BIT: Enables Audio Dubbing later. 16BIT: Audio Dubbing is impossible but the recorded sound quality is higher than "12BIT".</p>
<p>■ 12BIT MODE SOUND1 SOUND2 FULL</p>	<p>Select the appropriate mode when playing back an audio-dubbed Mini DV tape.</p> <p>SOUND1: Original recorded sound SOUND2: Audio-dubbed sound FULL: Original recorded sound and Audio-dubbed sound</p> <p>NOTES:</p> <ul style="list-style-type: none"> • When "12BIT MODE" is set to "FULL", both the main and sub audio will be audible. • To select only the main audio or only the sub audio of bilingual tapes, set "12BIT MODE" to "SOUND1".

Before requesting service for a problem, use this chart and see if you can repair the trouble yourself. Small problems are often easily corrected, and this can save you the trouble of sending your VCR off for repair.

POWER

SYMPTOM	POSSIBLE CAUSE	CORRECTIVE ACTION
1. No power is supplied to the VCR.	<ul style="list-style-type: none"> The AC power cord is disconnected. 	Connect the AC power cord.
2. The clock is functioning properly, but the VCR cannot be powered.	<ul style="list-style-type: none"> "⊖" is displayed on the front display panel with "AUTO TIMER" set to "OFF". 	Press the TIMER button to turn the "⊖" indicator off.
3. The Remote won't function.	<ul style="list-style-type: none"> The batteries are discharged. 	Replace the dead batteries with new ones.

TAPE TRANSPORT

SYMPTOM	POSSIBLE CAUSE	CORRECTIVE ACTION
1. The tape does not run during recording.	<ul style="list-style-type: none"> "⏏" is displayed on the front display panel. 	Press PLAY (▶) to turn the "⏏" indicator off.
2. The tape will not rewind or fast-forward.	<ul style="list-style-type: none"> The tape is already fully rewound or fast-forwarded. 	Check the cassette.

PLAYBACK

SYMPTOM	POSSIBLE CAUSE	CORRECTIVE ACTION
1. The playback picture does not appear while the tape is running.	<ul style="list-style-type: none"> The TV receiver is not set to the AV mode. 	Set the TV to its AV mode.
2. Noise appears during visual search.	<ul style="list-style-type: none"> This is normal. 	
3. Noise appears during normal playback. (VHS deck only)	<ul style="list-style-type: none"> The automatic tracking mode is engaged. 	Try manual tracking. (📖 pg. 31)
4. The playback picture is blurred or interrupted while TV broadcasts are clear or "USE CLEANING CASSETTE" message appears on the screen.	<ul style="list-style-type: none"> The video heads may be dirty. 	<p>For the VHS deck Use a dry cleaning cassette TCL-2, or consult your JVC dealer.</p> <p>For the DV deck Use a dry cleaning cassette M-DV12CL, or consult your JVC dealer.</p>
5. Breaks are noticeable in Hi-Fi soundtrack. (VHS deck only)	<ul style="list-style-type: none"> The automatic tracking mode is engaged. 	Try manual tracking. (📖 pg. 31)

RECORDING

SYMPTOM	POSSIBLE CAUSE	CORRECTIVE ACTION
1. Recording cannot be started.	<ul style="list-style-type: none"> ● For the VHS deck There is no cassette loaded, or the cassette loaded has had its record safety tab removed. ● For the DV deck There is no cassette loaded, or the cassette loaded has had its erase protection switch set to "SAVE". 	<p>Insert a VHS (or S-VHS) cassette, or using adhesive tape, cover the hole where the tab was removed.</p> <p>Insert a Mini DV cassette, or set the erase protection switch set to "REC".</p>
2. TV broadcasts cannot be recorded.	<ul style="list-style-type: none"> ● "L-1" or "F-1" has been selected as the input mode. 	Set to the desired channel.
3. Tape-to-tape editing using another component is not possible.	<ul style="list-style-type: none"> ● The components have been incorrectly connected, or correct video connector (S-VIDEO or VIDEO) is not selected. ● All necessary power switches have not been turned on. ● The input mode is not correct. 	<p>Connect the components correctly (☞ pg. 56 – 62) or check "REAR AUX INPUT" or "FRONT AUX INPUT" setting. (☞ pg. 71, 73)</p> <p>Confirm that all units' power switches are turned on.</p> <p>Set the input mode to "L-1" or "F-1".</p>
4. Camcorder recording is not possible.	<ul style="list-style-type: none"> ● The camcorder has not been properly connected. ● The input mode is not correct. 	<p>Confirm that the camcorder is properly connected. (☞ pg. 56)</p> <p>Set the input mode to "L-1" or "F-1".</p>
5. "☐" on the front display panel won't stop blinking.	<ul style="list-style-type: none"> ● The end of the tape was reached during recording. 	The program may not have been recorded in its entirety. Next time make sure you have enough time on the tape to record the entire program.
6. Audio dubbing is not possible.	<ul style="list-style-type: none"> ● For the DV deck ● "SOUND MODE" had been set to "16BIT" at the original recording. ● The tape speed had been set to LP at the original recording. 	<p>Set "SOUND MODE" to "12BIT" at the original recording. (☞ pg. 76)</p> <p>Set the tape speed to SP at the original recording.</p>
7. Monitoring the audio-dubbed sound is not possible during audio dubbing using the DV deck.	<ul style="list-style-type: none"> ● This is normal. 	Set "12BIT MODE" to "SOUND 2" or monitor the sound using the connected devices.
8. The programed memory of Random Assemble Editing is disappeared.	<ul style="list-style-type: none"> ● The memory backup time has expired. 	Perform Random Assemble Editing again. (☞ pg. 64)
9. When performing Tape Dubbing, the beginning of the dubbing start point is not dubbed.	<ul style="list-style-type: none"> ● This is normal. 	Locate the start point a little before the point where you want to start dubbing. (☞ pg. 54, 55)

TIMER RECORDING

SYMPTOM	POSSIBLE CAUSE	CORRECTIVE ACTION
1. Timer recording won't work.	<ul style="list-style-type: none"> ● The clock and/or the timer have been set incorrectly. ● The timer is not engaged. ● Timer recording may not work when the VCR's input mode is set to "F-1" for recording on the DV deck. 	<p>Re-perform the clock and/or timer settings.</p> <p>Press TIMER and confirm that "⊖" is displayed on the front display panel.</p> <p>Set the channel position other than "F-1" before engaging to Timer-Standby mode.</p>
2. Timer programming is not possible.	<ul style="list-style-type: none"> ● Timer recording is in progress. 	<p>Timer programming can't be performed while a timer recording is in progress. Wait until it finishes.</p>
3. "⊖" and "⏏" on the front display panel won't stop blinking.	<ul style="list-style-type: none"> ● The timer is engaged but there's no cassette loaded. ● The end of the tape was reached during timer recording. ● VHS deck The loaded cassette has had its record safety tab removed. ● DV deck The loaded cassette has had its erase protection switch set to "SAVE". 	<p>For the VHS deck Insert a VHS (or S-VHS) cassette with the record safety tab intact, or cover the hole using adhesive tape.</p> <p>For the DV deck Insert a Mini DV cassette with the erase protection switch set to "REC".</p> <p>The program may not have been recorded in its entirety. Next time make sure you have enough time on the tape to record the entire program.</p> <p>Remove the cassette and cover the hole with adhesive tape, or insert a cassette with the record safety tab intact.</p> <p>Remove the cassette and set the erase protection switch to "REC".</p>
4. "⊖" blinks for 10 seconds and the Timer mode is disengaged.	<ul style="list-style-type: none"> ● TIMER has been pressed when there are no programs in memory, or the timer record information has been programmed incorrectly. 	<p>Check the programmed data and re-program as necessary, then press TIMER again.</p>
5. The VCR Plus+ system does not timer-record properly.	<ul style="list-style-type: none"> ● The VCR's channel positions have been set incorrectly. 	<p>Refer to "Guide Channel Number Set" (ⓘ pg. 44) and re-perform the procedure.</p>
6. The power shuts off and "⏏" won't stop blinking.	<ul style="list-style-type: none"> ● The end of the tape was reached during Instant Timer Recording. 	<p>The program may not have been recorded in its entirety. Next time make sure you have enough time on the tape to record the entire program.</p>

TIMER RECORDING (cont.)

SYMPTOM	POSSIBLE CAUSE	CORRECTIVE ACTION
7. Cable channels are not automatically switched during timer recording.	<ul style="list-style-type: none"> • The Controller is not properly connected to the VCR. • The output channel selected in the Cable Box Set screen is incorrect. • The cable box is turned off. 	<p>Connect the Controller correctly (☞ pg. 20).</p> <p>After confirming your cable box's output channel number, re-access the Cable Box Set screen and select the correct number (☞ pg. 21).</p> <p>Make sure the power is on before timer recording starts.</p>
8. Satellite channels are not automatically switched during timer recording.	<ul style="list-style-type: none"> • The Controller is not properly connected to the VCR. • The output channel selected in the DBS Receiver Set screen is incorrect. • The VCR is not set correctly to control the DBS receiver. • The DBS receiver is turned off. 	<p>Connect the Controller correctly (☞ pg. 23).</p> <p>After confirming your DBS receiver's output channel number, re-access the DBS Receiver Set screen and select the correct number (☞ pg. 24).</p> <p>Set the correct DBS receiver brand code (☞ pg. 24).</p> <p>Make sure the power is on before timer recording starts.</p>
9. Timer recording begins as scheduled, but the channel is always incorrect.	<ul style="list-style-type: none"> • Even though you do not use an external cable box or DBS receiver, "CABLE BOX SET" is set to "ON" or "DBS RECEIVER SET" is set to "ON". 	<p>Set "CABLE BOX SET" to "OFF" (☞ pg. 21) or "DBS RECEIVER SET" is set to "OFF" (☞ pg. 24).</p>

OTHER PROBLEMS

SYMPTOM	POSSIBLE CAUSE	CORRECTIVE ACTION
1. Whistling or howling is heard from the TV during camcorder recording.	<ul style="list-style-type: none"> • The camcorder's microphone is too close to the TV. • The TV's volume is too high. 	<p>Position the camcorder so its microphone is away from the TV.</p> <p>Turn the TV's volume down.</p>
2. When scanning channels, some of them are skipped over.	<ul style="list-style-type: none"> • Those channels have been designated to be skipped. 	<p>If you need the skipped channels, restore them (☞ pg. 19).</p>
3. The channel cannot be changed.	<ul style="list-style-type: none"> • Recording is in progress. 	<p>Press PAUSE (II) to pause the recording, change channels, then press PLAY (▶) to resume recording.</p>
4. Channel settings that were made manually seem to have changed or disappeared.	<ul style="list-style-type: none"> • After the manual settings were made, Auto Channel Set was performed. 	<p>Perform manual setting again.</p>
5. The Remote will not operate your TV or cable box or DBS receiver.	<ul style="list-style-type: none"> • The brand codes are set incorrectly. 	<p>Reset the correct brand codes (☞ pg. 67, 68, or 69).</p>
6. Even though Auto or Semiauto Clock Set has been performed, the clock is incorrect.	<ul style="list-style-type: none"> • The clock setting data received from the host channel is incorrect. 	<p>Select a different host channel during "Semiauto Clock Set" (☞ pg. 17), or perform "Manual Clock Set" (☞ pg. 17).</p>
7. No picture appears when you connect a device to DV IN/OUT connector.		<p>Turn off the VCR or the connected appliance once, then turn it on again.</p>

ATTENTION

This VCR contains microcomputers. External electronic noise or interference can cause microcomputer to malfunction. If the VCR does not operate correctly switch its power off and unplug the AC power cord from the AC supply. Wait for a while and then plug the power cord back in. Eject and check the condition of the cassette. If everything appears normal, you can operate the VCR as usual.

PLAYBACK

- Q. What happens if the end of the tape is reached during playback or search?**
- A. The tape is automatically rewound to the beginning.
- Q. Can the VCR indefinitely remain in the Still mode?**
- A. No. It stops automatically after 5 minutes on the VHS deck, 3 minutes on the DV deck to protect the heads.
- Q. When returning from variable-speed search to normal playback, the picture is disturbed. Should I be concerned about this?**
- A. No, it is normal.
- Q. Noise bar appear during variable-speed search. What's the problem?**
- A. This is normal.
- Q. Sometimes, during Index Search, the VCR can't find the program I want to see. Why not?**
- A. There may be index codes too close together.

RECORDING

- Q. When I pause and then resume a recording, the end of the recording before the pause is overlapped by the beginning of the continuation of recording. Why does this happen?**
- A. This is normal. It reduces distortion at the pause and resume points.
- Q. Can the VCR indefinitely remain in the Record-Pause mode?**
- A. No. The VCR goes to its Stop mode automatically after 5 minutes to protect the heads.
- Q. What happens if the tape runs out during recording?**
- A. The VCR stops recording, and "00" on the front display panel won't stop blinking.

TIMER RECORDING

- Q. "○" and "⊖" remain lit on the front display panel. Is there a problem?**
- A. No. This is a normal condition for a timer recording in progress.
- Q. Can I program the timer while I'm watching a tape or a TV broadcast?**
- A. You won't see the picture as it is replaced by the on-screen menu, but the audio from the program or tape you're viewing can be heard.

GENERAL

Power requirement	: AC 120 V~, 60 Hz
Power consumption	
Power on	: 35 W
Power off	: 4.4 W
Temperature	
Operating	: 5°C to 40°C (41°F to 104°F)
Storage	: -20°C to 60°C (-4°F to 140°F)
Operating position	: Horizontal only
Dimensions (WxHxD)	
	: 435 mm x 106 mm x 380 mm (17- ³ / ₁₆ " x 4- ³ / ₁₆ " x 15")
Weight	: 5.1 kg (11.2 lbs)
Input/Output	: RCA connectors: IN x 2, OUT x 2 S-Video connectors: IN x 2, OUT x 2 DV connector: IN/OUT x 1 (4-pin, IEEE1394 conformity, digital input/output)

VHS DECK VIDEO/AUDIO

Signal system	: NTSC-type color signal and EIA monochrome signal, 525 lines/ 60 fields
Recording system	: DA4 (Double Azimuth) head helical scan system
Format	: S-VHS/VHS NTSC standard
Signal-to-noise ratio	: 45 dB
Horizontal resolution	
	: 230 lines (VHS) 400 lines (S-VHS)
Frequency range	: 70 Hz to 10,000 Hz (Normal audio) 20 Hz to 20,000 Hz (Hi-Fi audio)
Maximum recording time	
(SP)	: 210 min. with ST-210 video cassette
(EP)	: 630 min. with ST-210 video cassette

DV DECK VIDEO/AUDIO

Signal system	: NTSC-type colour signal, 525 lines 60 fields
Recording system	: Digital Component Recording
Format	: DV format (SD mode)
Cassette	: Mini DV Cassette
Maximum recording time	
(SP)	: 80 min. with M-DV80ME cassette
(LP)	: 120 min. with M-DV80ME cassette
Audio recording system	
	: PCM 48 kHz, 16 bit (2 ch)/ 32 kHz, 12 bit (4 ch)

TUNER

Tuning system	: Frequency synthesized tuner
Channel coverage	
VHF	: Channels 2-13
UHF	: Channels 14-69
CATV	: 113 Channels

TIMER

Clock reference	: Quartz
Program capacity	: 1-year programmable timer/ 6 programs each on the VHS and DV deck
Memory backup time	: Approx. 10 min.

ACCESSORIES

Provided accessories	
	: RF cable (F-type), Audio/Video cable, S-Video cable (4-pin), Controller, Infrared remote control unit, "AA" battery x 2

*Specifications shown are for SP mode unless otherwise specified.
E.& O.E. Design and specifications subject to change without
notice.*

This equipment has been tested and found to comply with the limits for a Class B digital device, pursuant to Part 15 of the FCC Rules. These limits are designed to provide reasonable protection against harmful interference in a residential installation. This equipment generates, uses, and can radiate radio frequency energy and, if not installed and used in accordance with the instructions, may cause harmful interference to radio communications. However, there is no guarantee that interference will not occur in a particular installation. If this equipment does cause harmful interference to radio or television reception, which can be determined by turning the equipment off and on, the user is encouraged to try to correct the interference by one or more of the following measures:

- Reorient or relocate the receiving antenna.
- Increase the separation between the equipment and receiver.
- Connect the equipment into an outlet on a circuit different from that to which the receiver is connected.
- Consult the dealer or an experienced radio/TV technician for help.

A

Active Video Calibration	35
Advantages of S-VHS video recorders	59
Audio Dubbing	60
AUDIO MONITOR	75
Auto Channel Set	18
AUTO SP→EP TIMER	74
AUTO TIMER	71
AV Insert Editing	63

B

BLUE BACK	74
-----------------	----

C

Cable box	20
Cable Box Control Setting	20
Cable Box Multi-Brand Remote Control	68
Changing VCR Plus+® Setting	44
Check, cancel and change programs	50
Clock Set	16
Controller	20, 23

D

DBS receiver	23
DBS Receiver Control Setting	23
DBS Receiver Multi-Brand Remote Control	69
DIGITAL R3	75
DIGITAL TBC/NR	74

E

EDITING	52
Elapsed Recording Time Indication	33
Express Timer Programming	46

F

FRONT AUX INPUT	73
-----------------------	----

G

Guide Channel Number Set	43, 44
--------------------------------	--------

H

High-Speed (Turbo) Search (On the Remote)	29, 39
High-Speed (Turbo) Search (On the VCR)	28, 38

I

Index Search	30
Insert Editing	62
Instant Timer Recording (ITR)	32, 41

L

Language	15
----------------	----

M

Manual Channel Set	19
Manual Clock Set	17
Manual Tracking	31
Mode Set	70

N

Next Function Memory	30, 40
Normal Dubbing (from DV to VHS)	54
Normal Dubbing (from VHS to DV)	55

O

ON-SCREEN DISPLAY (for DV deck)	11
ON-SCREEN DISPLAY (for VHS deck)	10

P

PICTURE CONTROL	73
PLAYBACK/RECORDING ON DV DECK	36
PLAYBACK/RECORDING ON VHS DECK	26
Plug & Play Set	14

R

Random Assemble Editing	64
REAR AUX INPUT	71
Record One Program While Watching Another	32, 41
Recording Resume Function	32, 41
Remote A/B Code Switching	66
Repeat Playback	30
Retake	34

S

Second Audio Recording	34, 41
Semiauto Clock Set	17
Slow Motion (On the Remote)	29, 39
Slow Motion (On the VCR)	28, 38
SOUND MODE	76
Soundtrack Selection	31, 40
Still Picture/Frame-By-Frame Playback (On the Remote)	29, 39
Still Picture/Frame-By-Frame Playback (On the VCR)	28, 38
SUPERIMPOSE	71
S-VHS ET	72
S-VHS MODE	72

T

Tape Dubbing (from DV to VHS)	52
Tape Dubbing (from VHS to DV)	53
Tape Position Indicator	10
Tape Remaining Time	33
Time Code	41
TIMER RECORDING	42
Timer Warning Display	10, 11
Tuner Set	18
TV Multi-Brand Remote Control	67

V

Variable Speed Search (On the Remote)	29, 39
Variable Speed Search (On the VCR)	28, 38
VCR Plus+® Timer Programing	42
VIDEO CALIBRATION	73
VIDEO STABILIZER	75

W

When programs overlap each other	51
12BIT MODE	76
24HR Quick Programing	48
2ND AUDIO RECORD	71

HOW TO LOCATE YOUR JVC SERVICE CENTER

TOLL FREE: 1-800-537-5722

<http://www.jvc.com>

Dear Customer,

In order to receive the most satisfaction from your purchase, please read the instruction booklet before operating the unit. In the event that repair is necessary, or for the address nearest your location within the Continental United States, please call 1-800-537-5722 for your nearest authorized servicer or visit our website at www.JVC.com. Remember to retain your Bill of Sale for Warranty Service.

— JVC

JVC SERVICE & ENGINEERING COMPANY OF AMERICA

DIVISION OF JVC AMERICAS CORP.

Sophisticated electronic products may require occasional service. Just as quality is a keyword in the engineering and production of the wide array of JVC products, service is the key to maintaining the high level performance for which JVC is world famous. The JVC service and engineering organization stands behind our products.

NATIONAL HEADQUARTERS
JVC SERVICE & ENGINEERING COMPANY OF AMERICA
DIVISION OF JVC AMERICAS CORP.
10 New Maple Avenue
Pine Brook, NJ 07058-9641

ACCESSORIES

To purchase accessories for your JVC product, you may contact your local JVC Dealer. From the 48 Continental United States call toll free: 1-800-882-2345 or on the web at www.JVC.com

Don't service the product yourself.

CAUTION

To prevent electrical shock, do not open the cabinet. There are no user serviceable parts inside. Please refer to qualified service personnel for repairs.

LIMITED WARRANTY CONSUMER VIDEO 1-90

JVC COMPANY OF AMERICA warrants this product and all parts thereof, except as set forth below ONLY TO THE ORIGINAL PURCHASER AT RETAIL to be FREE FROM DEFECTIVE MATERIALS AND WORKMANSHIP from the date of original retail purchase for the period as shown below. ("The Warranty Period")

PARTS	LABOR
1 YR	90 DAYS

THIS LIMITED WARRANTY IS VALID ONLY IN THE FIFTY (50) UNITED STATES, THE DISTRICT OF COLUMBIA AND IN COMMONWEALTH OF PUERTO RICO.

WHAT WE WILL DO:

If this product is found to be defective, JVC will repair or replace defective parts at no charge to the original owner. Such repair and replacement services shall be rendered by JVC during normal business hours at JVC authorized service centers. Parts used for replacement are warranted only for the remainder of the Warranty Period. All products and parts thereof may be brought to a JVC authorized service center on a carry-in basis except for Television sets having a screen size 25 inches and above which are covered on an in-home basis.

WHAT YOU MUST DO FOR WARRANTY SERVICE:

Return your product to a JVC authorized service center with a copy of your bill of sale. For your nearest JVC authorized service center, please call toll free: (800) 537-5722.

If service is not available locally, box the product carefully, preferably in the original carton, and ship, insured, with a copy of your bill of sale plus a letter of explanation of the problem to the nearest JVC Factory Service Center, the name and location of which will be given to you by the toll-free number.

If you have any questions concerning your JVC Product, please contact our Customer Relations Department.

WHAT IS NOT COVERED:

This limited warranty provided by JVC does not cover:

1. Products which have been subject to abuse, accident, alteration, modification, tampering, negligence, misuse, faulty installation, lack of reasonable care, or if repaired or serviced by anyone other than a service facility authorized by JVC to render such service, or if affixed to any attachment not provided with the products, or if the model or serial number has been altered, tampered with, defaced or removed;
2. Initial installation and installation and removal for repair;
3. Operational adjustments covered in the Owner's Manual, normal maintenance, video and audio head cleaning;
4. Damage that occurs in shipment, due to act of God, and cosmetic damage;
5. Signal reception problems and failures due to line power surge;
6. Video Pick-up Tubes/CCD Image Sensor, Cartridge, Stylus (Needle) are covered for 90 days from the date of purchase;
7. Accessories;
8. Batteries (except that Rechargeable Batteries are covered for 90 days from the date of purchase);

There are no other express warranties except as listed above.

THE DURATION OF ANY IMPLIED WARRANTIES INCLUDING THE IMPLIED WARRANTY OF MERCHANTABILITY, IS LIMITED TO THE DURATION OF THE EXPRESS WARRANTY HEREIN.

JVC SHALL NOT BE LIABLE FOR THE LOSS OF USE OF THE PRODUCT, INCONVENIENCE, LOSS OR ANY OTHER DAMAGES, WHETHER DIRECT, INCIDENTAL OR CONSEQUENTIAL (INCLUDING, WITHOUT LIMITATION, DAMAGE TO TAPES, RECORDS OR DISCS) RESULTING FROM THE USE OF THIS PRODUCT, OR ARISING OUT OF ANY BREACH OF THIS WARRANTY. ALL EXPRESS AND IMPLIED WARRANTIES, INCLUDING THE WARRANTIES OF MERCHANTABILITY AND FITNESS FOR PARTICULAR PURPOSE, ARE LIMITED TO THE WARRANTY PERIOD SET FORTH ABOVE.

Some states do not allow the exclusion of incidental or consequential damages or limitations on how long an implied warranty lasts, so these limitations or exclusions may not apply to you. This warranty gives you specific legal rights and you may also have other rights which vary from state to state.

JVC COMPANY OF AMERICA
DIVISION OF JVC AMERICAS CORP.

1700 Valley Road
Wayne, New Jersey 07470

REFURBISHED PRODUCTS CARRY A SEPARATE WARRANTY, THIS WARRANTY DOES NOT APPLY. FOR DETAILS OF REFURBISHED PRODUCT WARRANTY, PLEASE REFER TO THE REFURBISHED PRODUCT WARRANTY INFORMATION PACKAGED WITH EACH REFURBISHED PRODUCT.

For customer use:

Enter below the Model No. and Serial No. which is located either on the rear, bottom or side of the cabinet. Retain this information for future reference.

Model No.: _____

Serial No.: _____

Purchase date: _____

Name of dealer: _____



EN

HR-DVSS3U

JVC
VICTOR COMPANY OF JAPAN, LIMITED