

JVC

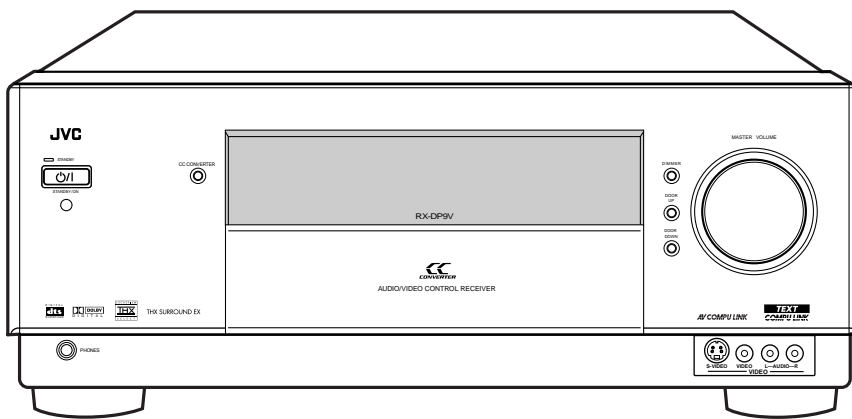

AUDIO/VIDEO CONTROL RECEIVER

RX-DP9VBK

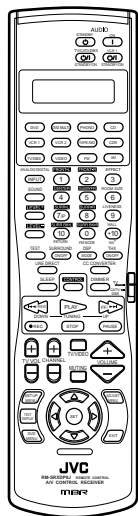

AV COMPU LINK

**TEXT
COMPU LINK**

DIGITAL
dts
SURROUND

DOLBY
DIGITAL

LUCASFILM
THX
SELECT

THX SURROUND EX

INSTRUCTIONS

For Customer Use:

Enter below the Model No. and Serial No. which are located either on the rear, bottom or side of the cabinet. Retain this information for future reference.

Model No. _____

Serial No. _____

LVT0722-001A

[J]

Warnings, Cautions and Others

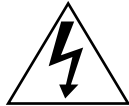

The lightning flash with arrowhead symbol, within an equilateral triangle is intended to alert the user to the presence of uninsulated "dangerous voltage" within the product's enclosure that may be of sufficient magnitude to constitute a risk of electric shock to persons.



The exclamation point within an equilateral triangle is intended to alert the user to the presence of important operating and maintenance (servicing) instructions in the literature accompanying the appliance.

WARNING: TO REDUCE THE RISK OF FIRE OR ELECTRIC SHOCK, DO NOT EXPOSE THIS APPLIANCE TO RAIN OR MOISTURE.

CAUTION

To reduce the risk of electrical shocks, fire, etc.:

1. Do not remove screws, covers or cabinet.
2. Do not expose this appliance to rain or moisture.

Caution — (STANDBY/ON) switch!

Disconnect the mains plug to shut the power off completely. The  (STANDBY/ON) switch in any position does not disconnect the mains line. The power can be remote controlled.

Caution — SPEAKER LOAD SELECTOR switch!

Match the position of SPEAKER LOAD SELECTOR switch on the back panel to the impedance of the speaker connected, to protect from overheating.



21.1 kg / 47 lb.

CAUTION!

To avoid personal injury or accidentally dropping the unit, have two persons unpack, carry, and install the unit.

Note to CATV system installer:

This reminder is provided to call the CATV system installer's attention to Section 820-40 of the NEC which provides guidelines for proper grounding and, in particular, specifies that the cable ground shall be connected to the grounding system of the building, as close to the point of cable entry as practical.

This equipment has been tested and found to comply with the limits for a Class B digital device, pursuant to part 15 of the FCC Rules. These limits are designed to provide reasonable protection against harmful interference in a residential installation.

This equipment generates, uses and can radiate radio frequency energy and, if not installed and used in accordance with the instructions, may cause harmful interference to radio communications. However, there is no guarantee that interference will not occur in a particular installation. If this equipment does cause harmful interference to radio or television reception, which can be determined by turning the equipment off and on, the user is encouraged to try to correct the interference by one or more of the following measures:

Reorient or relocate the receiving antenna.

Increase the separation between the equipment and receiver.

Connect the equipment into an outlet on a circuit different from that to which the receiver is connected.

Consult the dealer or an experienced radio/TV technician for help.

Changes or modifications not expressly approved by the manufacturer for compliance could void the user's authority to operate the equipment.

Table of Contents

Introduction	2	Sound Adjustments	34
Features	2	Adjustment Menu Configuration	34
Precautions	2	Operation through On-Screen Display Menus	35
Parts Identification	3	Menu Operating Procedure	36
Getting Started	6	■ Adjusting the Speaker Channel Output Levels—LEVEL	37
Before Installation	6	■ Adjusting the Parametric Equalizer—PARAMETRIC EQ	37
Checking the Supplied Accessories	6	■ Adjusting the DSP Parameters—DSP PARAMETER	38
Connecting the FM and AM Antennas	6	■ Adjusting the Center Channel—CENTER CHANNEL	38
Connecting the Speakers	7	Using the Surround Modes	39
Connecting Audio/Video Components	9	Reproducing Theater Ambience	39
■ Analog Connections	9	Introducing the Surround Modes	39
■ Digital Connections	14	Activating the Surround Modes	41
Connecting the Power Cord	15	Adjusting the Surround Sounds Temporarily	42
Putting Batteries in the Remote Control	15	Using the DSP Modes	43
Basic Operations	16	Reproducing the Sound Field	43
Simple Operating Procedure	16	Introducing the DSP Modes	43
Turning the Power On and Off (Standby)	17	Activating the DSP Modes	44
Selecting the Source to Play	17	Adjusting the DSP Parameters Temporarily	45
Adjusting the Volume	19	Using the DVD MULTI Playback Mode	46
Activating the Front Speakers	19	Activating the DVD MULTI Playback Mode	46
Selecting the Analog or Digital Input Mode	20	COMPU LINK Remote Control System	47
Attenuating the Input Signal	21	TEXT COMPU LINK Remote Control System ..	48
Muting the Sound	21	■ Showing the Disc Information on the TV Screen	49
Turning Line Direct On and Off	21	■ Searching for a Disc (Only for the CD player)	50
Making Sounds Natural	22	■ Entering the Disc Information	51
Changing the Display Brightness	22	AV COMPU LINK Remote Control System	53
Changing the Source Name	22	Operating JVC's Audio/Video Components ...	55
Using the Sleep Timer	23	Operating Audio Components	55
Receiving Radio Broadcasts	24	Operating Video Components	57
Tuning into Stations Manually	24	Operating Other Manufacturers' Equipment ...	58
Using Preset Tuning	25	Changing the Preset Signal Codes	58
Selecting the FM Reception Mode	25	Troubleshooting	62
Basic Settings	26	Specifications	63
Setup Menu Configuration	26		
Operation through On-Screen Display Menus	27		
Menu Operating Procedure	28		
■ Setting the Speakers—SPEAKER SETTING	29		
■ Setting the Speaker Distance—SPEAKER DISTANCE	29		
■ Setting the Bass Sounds—SUBWOOFER	30		
■ Setting the Dynamic Range—DYNAMIC RANGE	31		
■ Preparing for THX Surround Modes—THX	31		
■ Setting the Surround Sound Output—SURROUND			
SPEAKER	31		
■ Setting the Digital Input Terminals—DIGITAL IN	32		
■ Preparing for the Component Video Input			
—COMPONENT IN	32		
■ Turning On and Off the Video Output—VIDEO POWER ...	33		
■ Showing the Text Information on the Display			
—FL DISPLAY	33		
■ Memorizing the Volume Level for Each Source			
—ONE TOUCH OPE(ration)	33		

Introduction

We would like to thank you for purchasing one of our JVC products. Before operating this unit, read this manual carefully and thoroughly to obtain the best possible performance from your unit, and retain this manual for future reference.

Features

THX Surround EX (DTS-ES compatible)

By adding surround back speakers through an amplifier (separately purchased) connected to the PREOUT (SURR BACK) jacks, you can enjoy THX Surround EX. It is a format that has additional left and right surround back channels on the basis of Dolby Digital 5.1 channels. It improves the definition and the sense of sound movement in surround (rear) channels.

- This receiver is also compatible with DTS Extended Surround (DTS-ES)—another multichannel surround containing additional left and right surround back channels.

5.1 channel DAP (Digital Acoustic Processor)

Sound field simulation technology allows precise ambience recreation of existing theaters and halls. Thanks to the high-performance DSP (Digital Signal Processor) and high-capacity memory, you can enjoy 5.1-channel surround by playing 2-channel or 5.1-channel software.

- By adding surround back speakers through an amplifier (separately purchased) connected to the PREOUT (SURR BACK) jacks, you can enjoy 7.1-channel surround.

Multichannel headphone virtual surround sound—3D HEADPHONE

The built-in headphone virtual surround system is compatible with multichannel software like Dolby Digital, DTS Surround, etc. Thanks to the new signal processing algorithms used by the high-performance DSP, you can enjoy a natural surround sound through the headphones.

192 kHz/24 bit PEM DD audio DA converter

The JVC-exclusive converter is now upgraded to be fully compatible with DVD Audio's high specifications. Subtle nuances are accurately reproduced.

CC (Compensative Compression) converter

CC Converter eliminates jitter and ripples, achieving a drastic reduction in digital distortion by processing the digital music data in 24 bit—quantization and by expanding the sampling frequency to 176.4 kHz (for fs 44.1 kHz signals)/192 kHz (for fs 48 kHz signals). By using the CC Converter, you can obtain a natural sound field from any source.

Multi-brand remote control

The remote control provided for this receiver can transmit control signals for many manufacturers' components.

COMPU LINK/AV COMPU LINK remote control systems

The COMPU LINK/AV COMPU LINK remote control systems allow you to operate other JVC audio/video components from this receiver.

TEXT COMPU LINK remote control system

The TEXT COMPU LINK remote control system has been developed to deal with the disc information recorded on the CD Text and MDs. Using this information on the discs, you can operate the CD player or MD recorder through the receiver.

Precautions

Power sources

- When unplugging the receiver from the wall outlet, always pull the plug, not the AC power cord.
- Do not handle the AC power cord with wet hands.
- If you are not going to operate the receiver for an extended period of time, unplug the AC power cord from the wall outlet.

Ventilation

Five high power amplifiers built in this receiver will generate heat inside the cabinet. When the temperature inside the cabinet increases, the internal fan automatically starts rotating to reduce the internal temperature. For safety, observe the following carefully.

- Make sure there is good ventilation around the receiver. Poor ventilation could overheat and damage the receiver.
- Do not block the ventilation openings or holes. (If the ventilation openings or holes are blocked by a newspaper or cloth, etc., the heat may not be able to get out.)

Others

- Should any metallic object or liquid fall onto the unit, unplug the unit and consult your dealer before operating any further.
- Do not use this receiver in a bathroom or places with water.
- Do not place any containers filled with water or liquids (such as cosmetics or medicines, flower vases, potted plants, cups, etc.) on top of this receiver.
- Do not disassemble the unit since there are no user serviceable parts inside.

If anything goes wrong, unplug the AC power cord and consult your JVC dealer.

Parts Identification

Front Panel

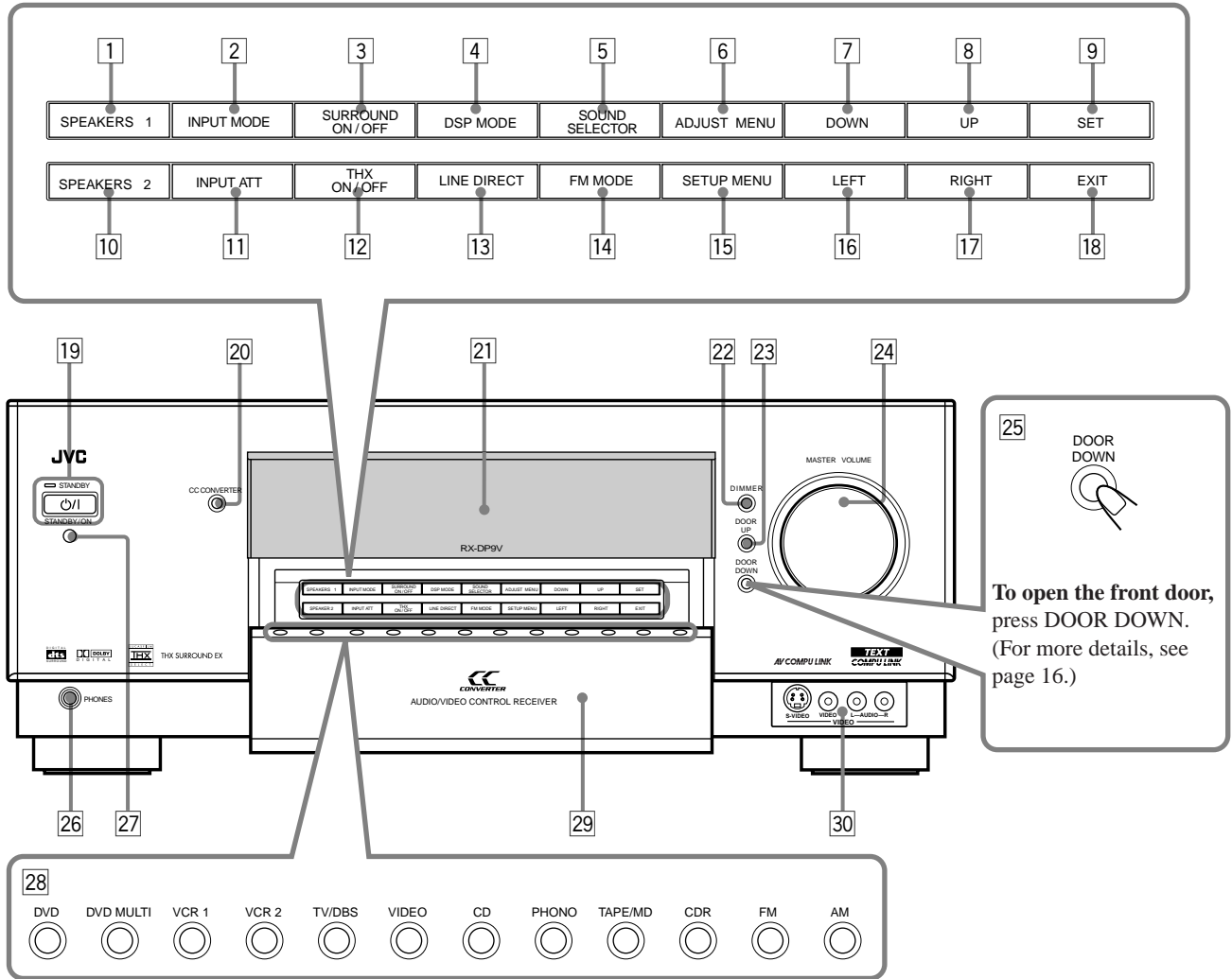

Display Window

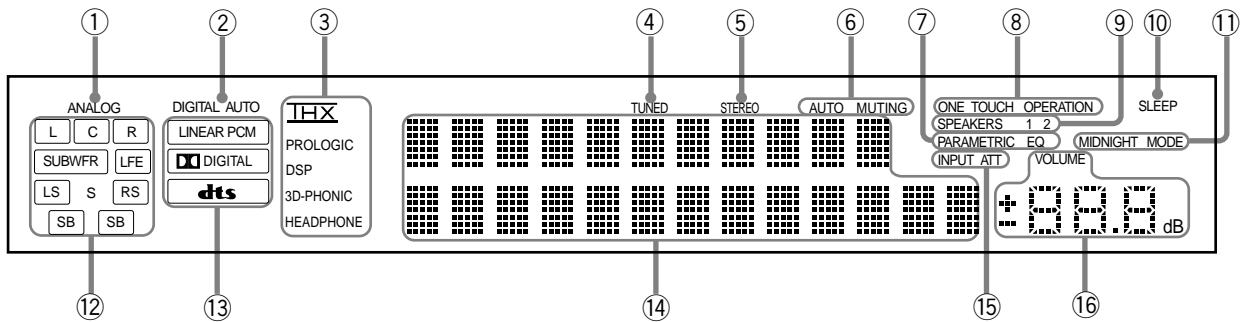

Refer to the pages in parentheses for details.

Front Panel

- 1 **SPEAKERS 1 button (16, 19)**
- 2 **INPUT MODE button (20)**
- 3 **SURROUND ON/OFF button (41)**
- 4 **DSP MODE button (44)**
- 5 **SOUND SELECTOR button (18)**
- 6 **ADJUST MENU button (35)**
- 7 **DOWN button (24, 27, 35)**
- 8 **UP button (24, 27, 35)**
- 9 **SET button (25, 27, 35)**
- 10 **SPEAKERS 2 button (16, 19)**
- 11 **INPUT ATT button (21)**
- 12 **THX ON/OFF button (41)**
- 13 **LINE DIRECT button (21)**
- 14 **FM MODE button (25)**
- 15 **SETUP MENU button (27)**
- 16 **LEFT button (25, 27, 35)**
- 17 **RIGHT button (25, 27, 35)**
- 18 **EXIT button (27, 35)**
- 19 **⏻/⏻ (STANDBY/ON) button and STANDBY lamp (16, 17)**
 - STANDBY lamp lights up in red when main room is turned on.
- 20 **CC CONVERTER button and lamp (22)**
 - CC CONVERTER lamp lights up in red when CC Converter is turned on.
- 21 **Display**
- 22 **DIMMER button (22)**
- 23 **DOOR UP button (16)**
- 24 **MASTER VOLUME control (16, 19)**
- 25 **DOOR DOWN button (16)**
- 26 **PHONES jack (19)**
- 27 **Remote sensor**
- 28 **Source selecting buttons (16 – 18)**
 - DVD, DVD MULTI, VCR 1, VCR 2, TV/DBS, VIDEO, CD, PHONO, TAPE/MD, CDR, FM, AM
- 29 **Front door**
- 30 **VIDEO input terminals (11)**

Display Window

- 1 **ANALOG indicator (20)**
 - Lights up when an analog input (source) is selected.
- 2 **DIGITAL AUTO indicator (20)**
 - Lights up when auto digital input (DIGITAL AUTO) is selected.
- 3 **Surround/DSP mode indicators**
 - Indicate the current Surround/DSP mode setting.
- 4 **TUNED indicator (24)**
 - Lights up when a station is received.
- 5 **STEREO indicator (24)**
 - Lights up when an FM stereo station is received.
- 6 **AUTO MUTING indicator (25)**
 - Lights up when the FM station reception mode is set to Auto Reception mode (AUTO MUTING).
- 7 **PARAMETRIC EQ indicator (38)**
 - Lights up when Parametric Equalizer is in use.
- 8 **ONE TOUCH OPERATION indicator (33)**
 - Lights up when One Touch Operation is in use.
- 9 **SPEAKERS 1/2 indicators (16, 17, 19)**
 - Lights up to indicate the activated speakers.
- 10 **SLEEP indicator (23)**
 - Lights up when Sleep Timer is in use.
- 11 **MIDNIGHT MODE indicator (31)**
 - Lights up when Midnight Mode is in use.
- 12 **Speaker indicators and signal indicators (18)**
 - Speaker indicators: Indicate the activated speakers.
 - Signal indicators: Indicate the incoming channel signals.
- 13 **Digital signal format indicators (20)**
 - Indicates the digital signal format of incoming signals.
- 14 **Main display**
 - Shows the source name, station frequency, Surround/DSP mode, etc.
- 15 **INPUT ATT indicator (21)**
 - Lights up when Input Attenuator is in use.
- 16 **VOLUME level indicator**
 - Indicates the volume level.
 - Goes off while muting sounds.

Remote Control

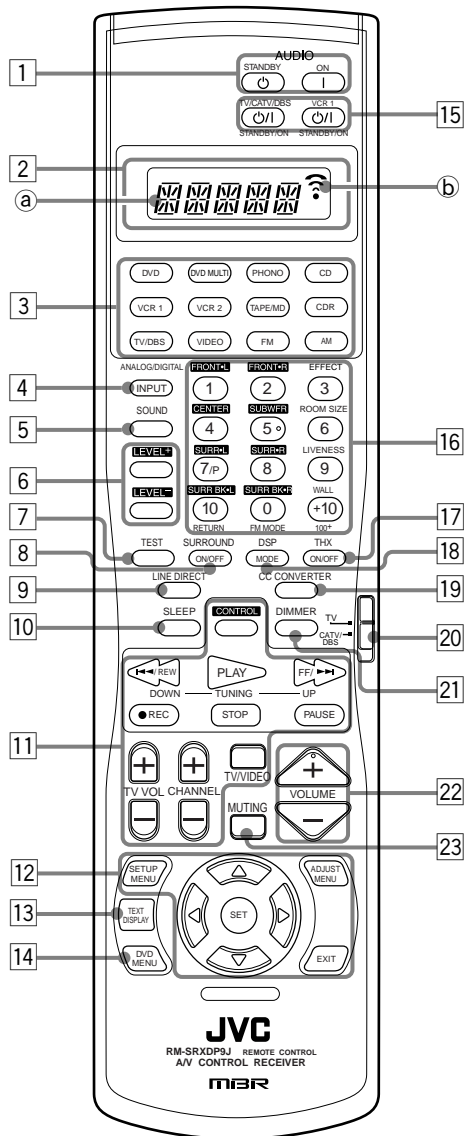

- 1 **AUDIO buttons**
 - ⏻ (STANDBY), I (ON) (16, 17)
- 2 **Display window**
 - a **Remote control operation mode display**
 - Remote control operation mode such as “DVD,” “CD,” “SOUND,” etc. appears.
 - When the remote control operation mode changes, it is shown on this display for about 10 seconds.
 - (When showing the remote control operation mode just for confirmation, it is shown only for about 5 seconds—i.e. when pressing Number button 1 while the remote control operation mode is “CD,” “CD” appears for about 5 seconds.)
 - b **Signal transmission indicator**
 - Lights up when transmitting the remote control signals.
- 3 **Source selecting buttons (16 – 18)**
 - DVD, DVD MULTI, PHONO, CD, VCR 1, VCR 2, TAPE/MD, CDR, TV/DBS, VIDEO, FM, AM
- 4 **ANALOG/DIGITAL INPUT button (20)**
- 5 **SOUND button (42, 45)**
- 6 **LEVEL +/- buttons (42)**
- 7 **TEST button (42, 55)**
- 8 **SURROUND ON/OFF button (41, 55)**
- 9 **LINE DIRECT button (21)**
- 10 **SLEEP button (23)**
- 11 **Operating buttons for audio/video components (24, 55 – 60)**
- 12 **On-screen operation buttons (27, 35, 49)**
 - SETUP MENU, ADJUST MENU, SET, EXIT, Δ (UP), ∇ (DOWN), ◀ (LEFT), ▶ (RIGHT)
- 13 **TEXT DISPLAY button (49)**
- 14 **DVD MENU button (57, 60)**
- 15 **TV/CATV/DBS ⏻/I (STANDBY/ON) button (57 – 59)**
- 16 **VCR 1 ⏻/I (STANDBY/ON) (57, 59, 60)**
- 17 **• 10 keys for selecting preset channels (25)**
- 18 **• 10 keys for adjusting sound (42)**
- 19 **• 10 keys for adjusting DSP parameters (45)**
- 20 **• 10 keys for operating audio/video components (55 – 60)**
- 21 **THX ON/OFF button (41, 55)**
- 22 **DSP MODE button (44, 55)**
- 23 **CC CONVERTER button (22)**
- 24 **TV operation mode selector (TV or CATV/DBS) (57 – 59)**
- 25 **DIMMER button (22)**
- 26 **VOLUME +/- buttons (16, 19)**
- 27 **MUTING button (21)**

Getting Started

This section explains how to connect audio/video components and speakers to the receiver, and how to connect the power supply.

Before Installation

General

- Be sure your hands are dry.
- Turn the power off on all components.
- Read the manuals supplied with the components you are going to connect.

Location

- Install the receiver in a location that is level, well-ventilated and free from moisture.
- The temperature around the receiver must be between -5°C and 35°C (23°F and 95°F).
- Make sure there is good ventilation around the receiver. Poor ventilation could overheat and damage the receiver.

Handling the receiver

- Do not insert any metal object into the receiver.
- Do not disassemble the receiver or remove screws, covers, or cabinet.
- Do not expose the receiver to rain or moisture.

Checking the Supplied Accessories

Check to be sure you have all of the following items, which are supplied for the receiver.

The number in the parentheses indicates quantity of the pieces supplied.

- Remote Control (1)
- Batteries (2)
- AM Loop Antenna (1)
- FM Antenna (1)

If any item is missing, contact your dealer immediately.

Connecting the FM and AM Antennas

FM Antenna Connections

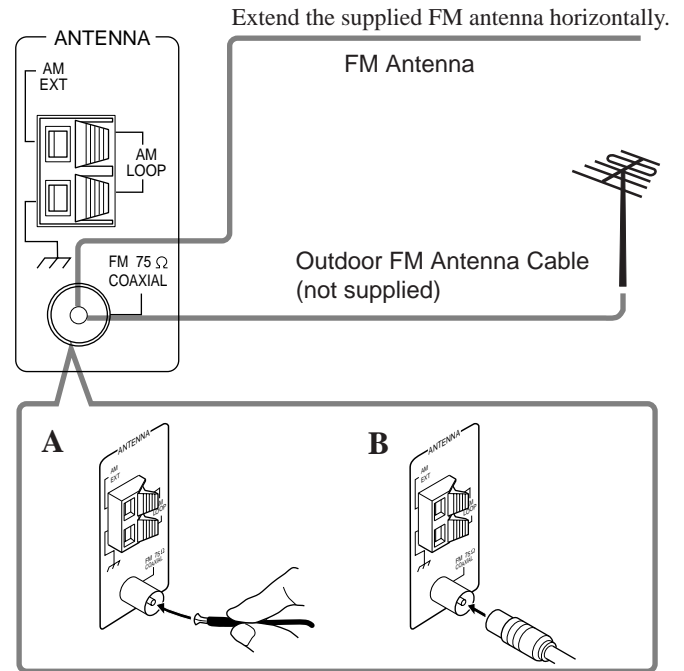

A. Using the Supplied FM Antenna

The FM antenna provided can be connected to the FM 75 Ω COAXIAL terminal as a temporary measure.

B. Using the Standard Type Connector with Outdoor FM Antenna (Not Supplied)

A standard type connector should be connected to the FM 75 Ω COAXIAL terminal.

Note:

If reception is poor, connect the outdoor antenna. Before attaching a 75 Ω coaxial cable (the kind with a round wire going to an outdoor antenna), disconnect the supplied FM antenna.

AM Antenna Connections

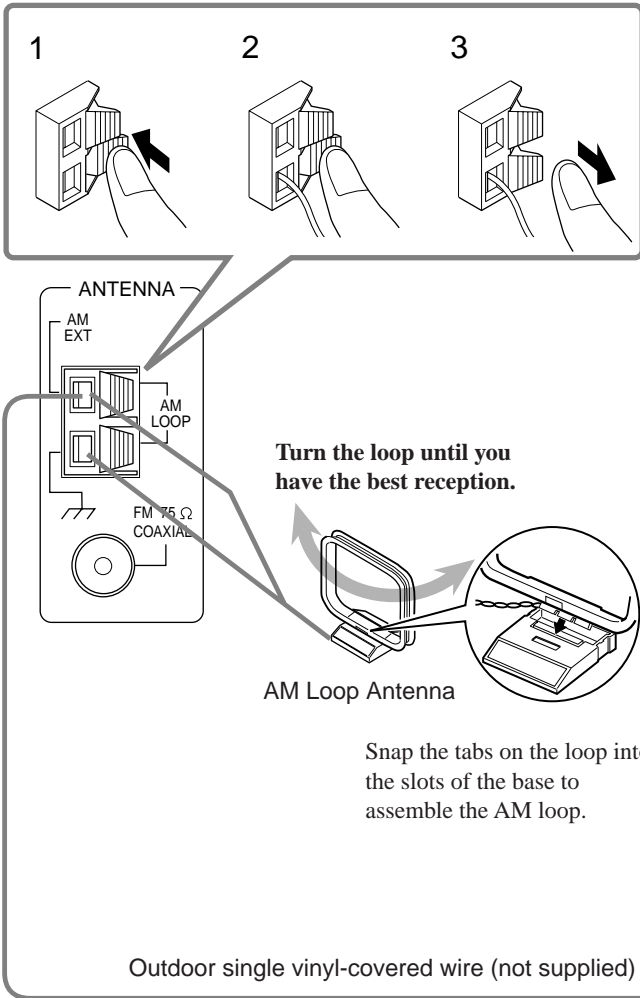

Notes:

- If the AM loop antenna wire is covered with vinyl, remove the vinyl by twisting it as shown in the diagram.
- Make sure the antenna conductors do not touch any other terminals, connecting cords and power cord. This could cause poor reception.
- If reception is poor, connect an outdoor single vinyl-covered wire to the AM EXT terminal. (Keep the AM loop antenna connected.)



Connecting the Speakers

You can connect the following speakers:

- Two pairs of front speakers to produce normal stereo sound.
- One pair of surround speakers to enjoy the surround effect.
- One center speaker to produce more effective surround effect (to emphasize human voices).
- One powered subwoofer to enhance the bass.

IMPORTANT:

After connecting the speakers listed above, set the speaker setting information properly:

- To obtain the best possible Surround and DSP effect in the main room, see "Basic Settings" on pages 26 to 33.

For each speaker (except for a subwoofer), connect the (+) and (-) terminals on the rear panel to the (+) and (-) terminals marked on the speakers. For connecting a subwoofer, see page 8.

CAUTION:

Use speakers with the SPEAKER IMPEDANCE indicated by the speaker terminals.

Speaker layout

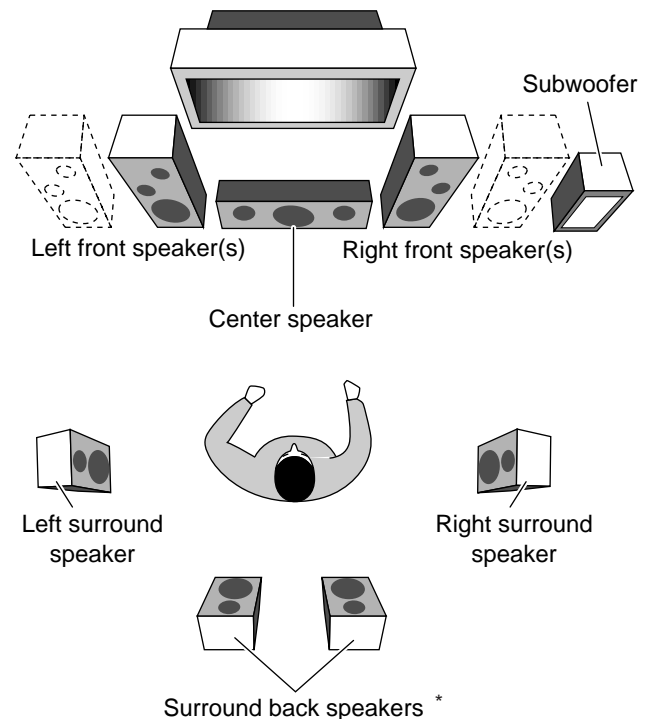

Note:

- * When connecting the surround back speakers, you have to prepare another amplifier, see also page 8.

Basic connecting procedure

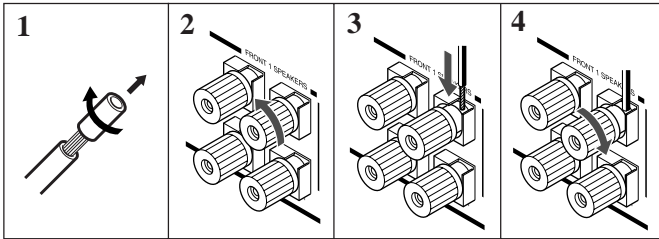

- 1 Cut, twist and remove the insulation at the end of each speaker signal cable (not supplied).
- 2 Turn the knob counterclockwise.
- 3 Insert the speaker signal cable.
- 4 Turn the knob clockwise.

CAUTION:

Use only the speakers of the SPEAKER IMPEDANCE indicated by the speaker terminals.

IMPORTANT for the FRONT 1 SPEAKERS connection:

To obtain the best possible output power from the receiver, and to prevent the receiver from being overheated, the receiver has the SPEAKER LOAD SELECTOR which has to be set as follows:

- Set it to the "HIGH" position when the impedance of the front speakers connected is within the range of 8 Ω to 16 Ω.
- Set it to the "LOW" position when the impedance of the front speakers connected is within the range of 4 Ω to 6 Ω.

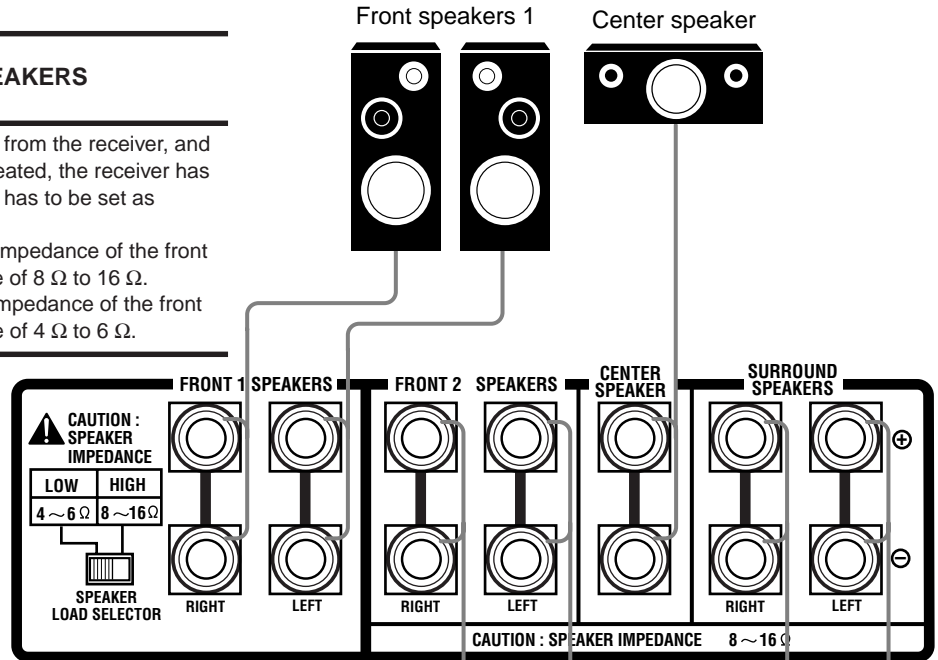

Connecting the surround back speakers

To fully enjoy THX Surround (see page 39), you need to connect the surround back speakers through a power amplifier connected to the SURR BACK PREOUT jacks on the rear.

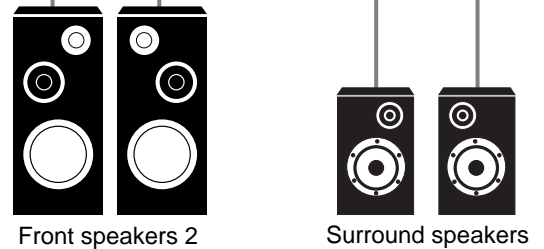
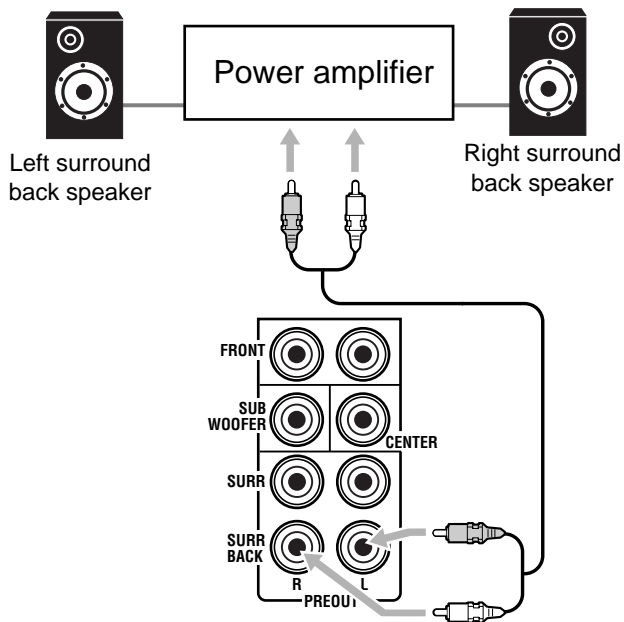

Connecting the subwoofer speaker

You can enhance the bass by connecting a subwoofer. Connect the input jack of a powered subwoofer to the SUBWOOFER PREOUT jack on the rear panel, using a cable with RCA pin plugs (not supplied).

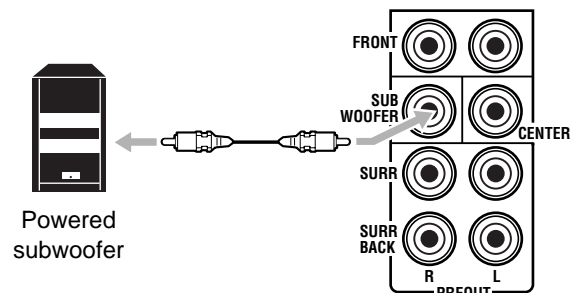

Enhance your audio system

You can use this receiver as the pre-amplifier (control amplifier) when you connect power amplifiers to the PREOUT jacks on the rear panel, using cables with RCA pin plugs (not supplied).

- Connect the white plug to the audio left jack, and the red plug to the audio right jack.

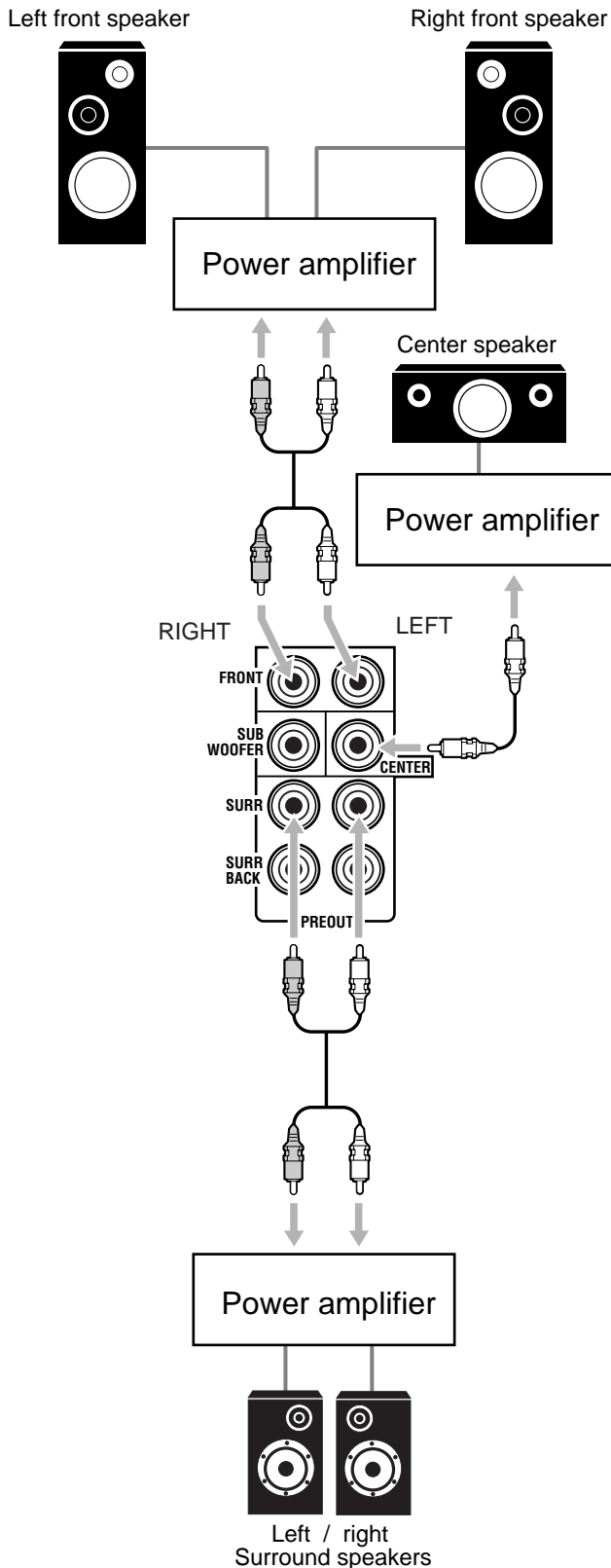

Connecting Audio/Video Components

You can connect the following audio/video components to this receiver. Refer also to the manuals supplied with your components.

Audio Components	Video Components
• Turntable	• DVD player*
• CD player*	• TV*
• Cassette deck or MD recorder*	• DBS tuner*
• CD recorder*	• VCRs
	• Video camera

* You can connect these components using the methods described in "Analog connections" (below) and in "Digital connections" (see page 14).

Analog Connections

Audio component connections

Use the cables with RCA pin plugs (not supplied).

- Connect the white plug to the audio left jack, and the red plug to the audio right jack.

CAUTION:

If you connect a sound-enhancing device such as a graphic equalizer between the source components and this receiver, the sound output through this receiver may be distorted.

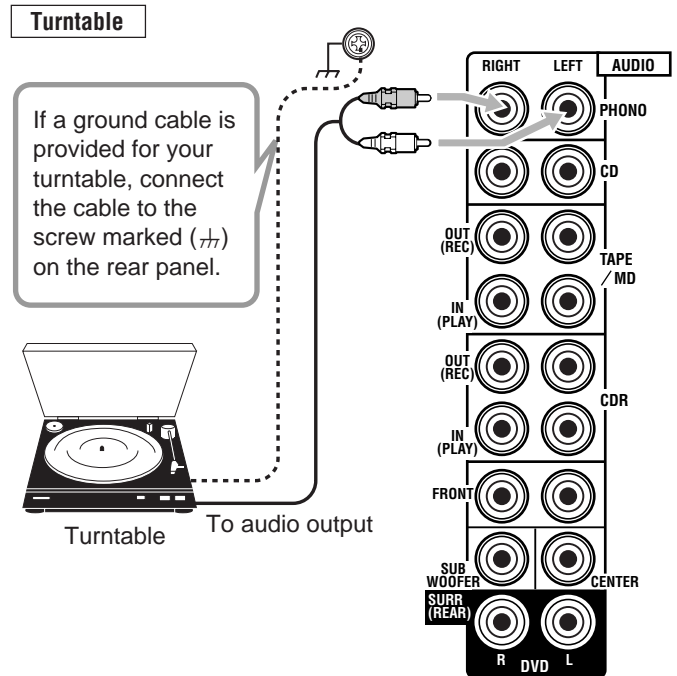

Note:

The above connection is for a turntable with an MM (moving-magnet) type cartridge.

Any turntables incorporating a small-output cartridge such as an MC (moving-coil) type must be connected to this receiver through a commercial head amplifier or step-up transformer. Direct connection may result in insufficient volume.

CD player

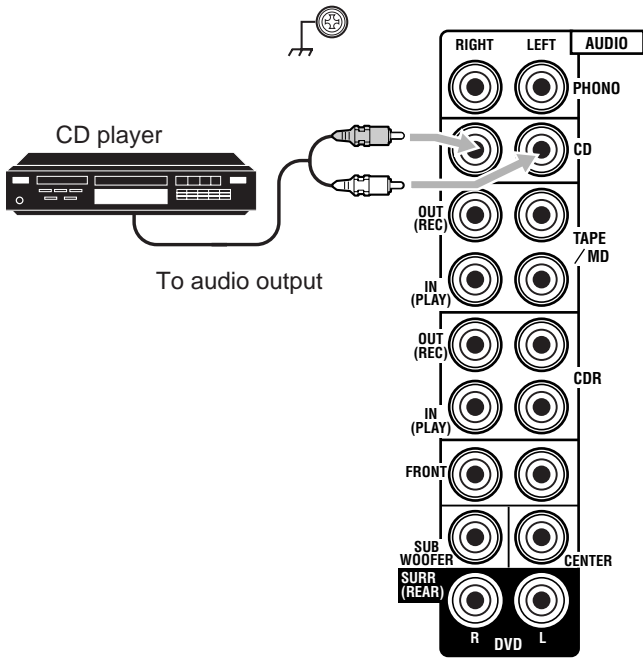

CD recorder

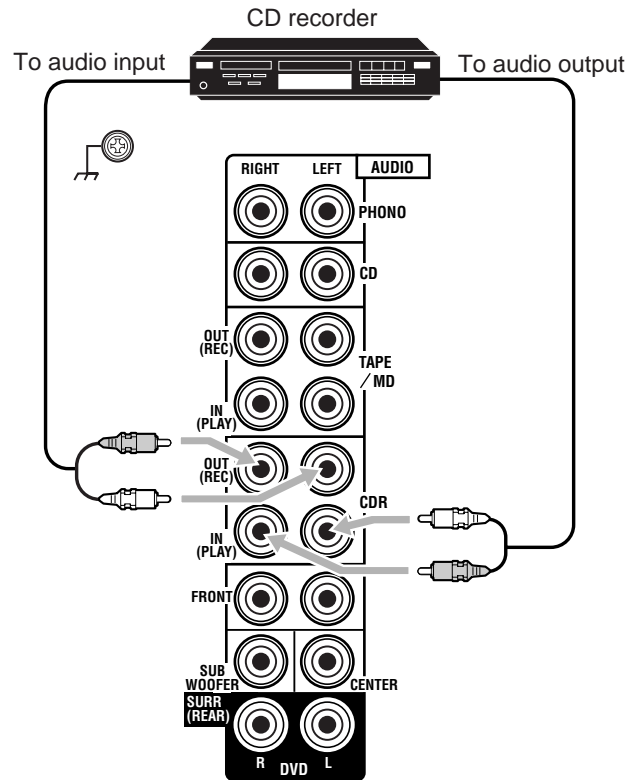

Cassette deck or MD recorder

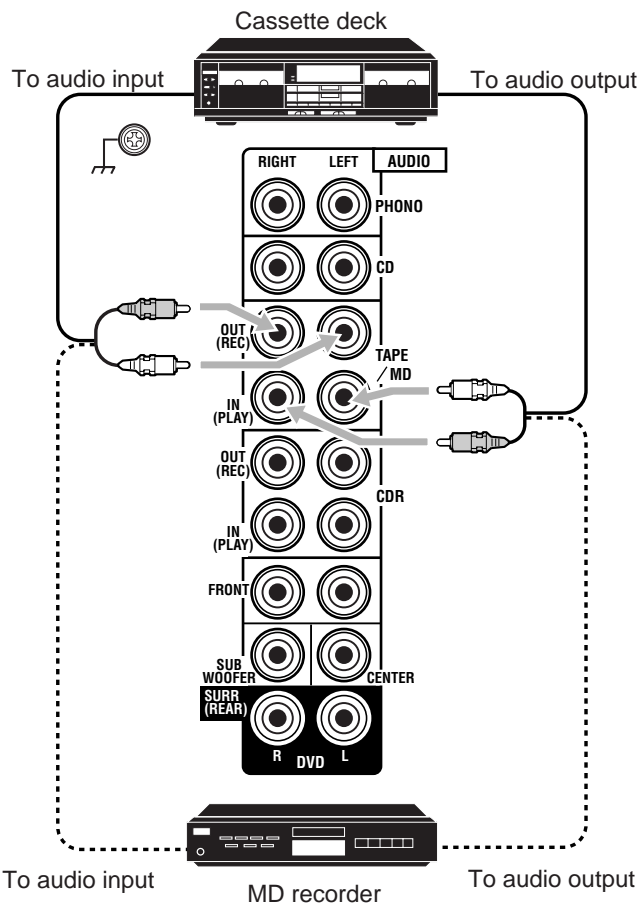

If your audio components have a COMPU LINK or TEXT COMPU LINK jack

- See page 47 for detailed information about the connection and the COMPU LINK remote control system.
- See page 48 for detailed information about the connection and the TEXT COMPU LINK remote control system.

Note:

You can connect either a cassette deck or an MD recorder to the TAPE/MD jacks. When connecting an MD recorder to the TAPE/MD jacks, change the source name to "MD," which will be shown on the display when selected as the source. See "Changing the Source Name" on page 22 for details.

Video component connections

Use the cables with RCA pin plugs (not supplied).

Connect the white plug to the audio left jack, the red plug to the audio right jack, and the yellow plug to the video jack.

- If your video components have S-video (Y/C-separation) and/or component video (Y, P_B/C_B, P_R/C_R) jacks, connect them using an S-video cable (not supplied) and/or component video cable (not supplied). By using these jacks, you can get a better picture quality—in the order : Component video > S-video > Composite video.

IMPORTANT:

This receiver is equipped with the following video jacks—composite video, S-video and component video jacks. You can use any of the three to connect a video component.

However, **the video signals from one type of these input jacks are output only through the video output jacks of the same type.**

Therefore, if a recording video component and a playing video component are connected to the receiver through the video jacks of the different type, you cannot record the picture. In addition, if the TV and a playing video component are connected to the receiver through the video jacks of the different type, you cannot view the playback picture on the TV.

VCR(s)

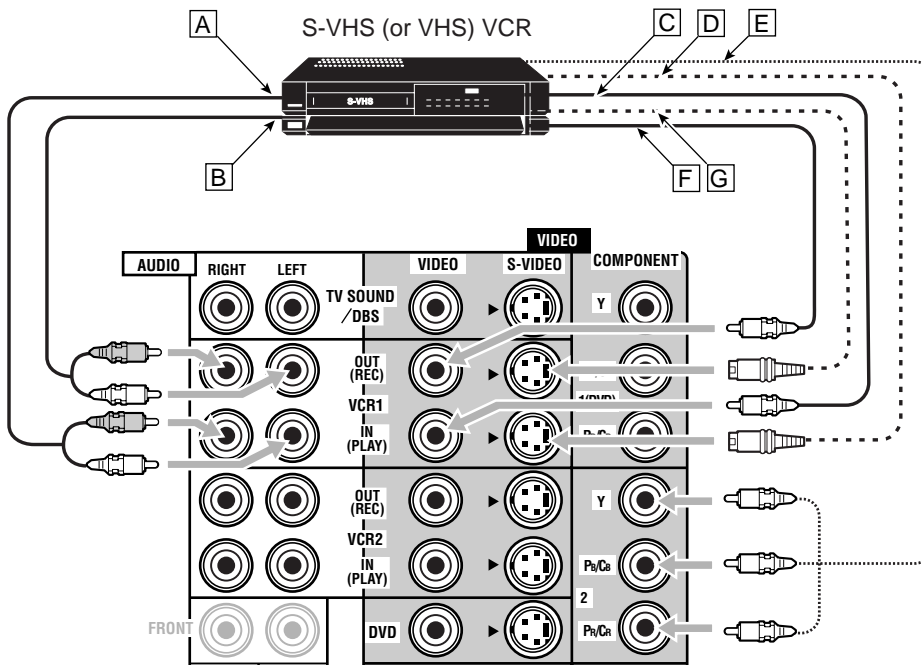

- A To audio output
- B To audio input
- C To composite video output
- D To S-video output
- E To component video output
- F To composite video input
- G To S-video input

Note:

If your VCR has the component video output jacks, you can connect it to either the COMPONENT 1 (DVD) or the COMPONENT 2 jacks. When connecting a VCR to either one of the component input jacks, make the component input (COMPONENT) terminal setting correctly. For details, see "Preparing for the Component Video Input—COMPONENT IN" on page 32.

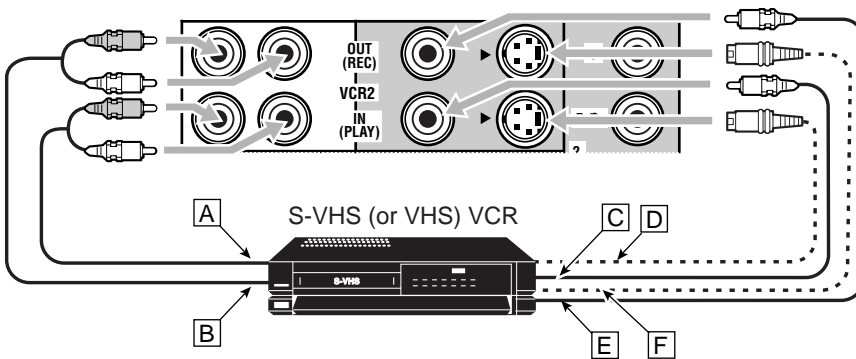

- A To audio output
- B To audio input
- C To composite video output
- D To S-video output
- E To composite video input
- F To S-video input

Video camera

The VIDEO input jacks on the front panel are convenient when connecting and disconnecting the component frequently.

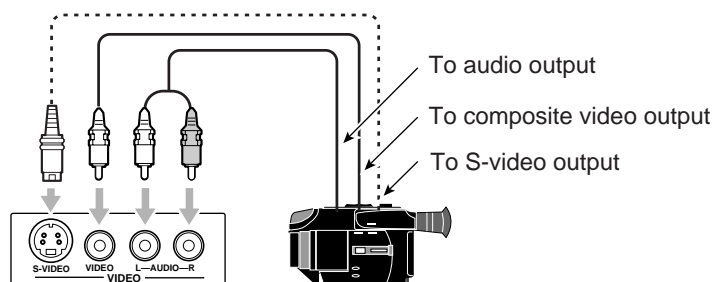

TV and/or DBS tuner

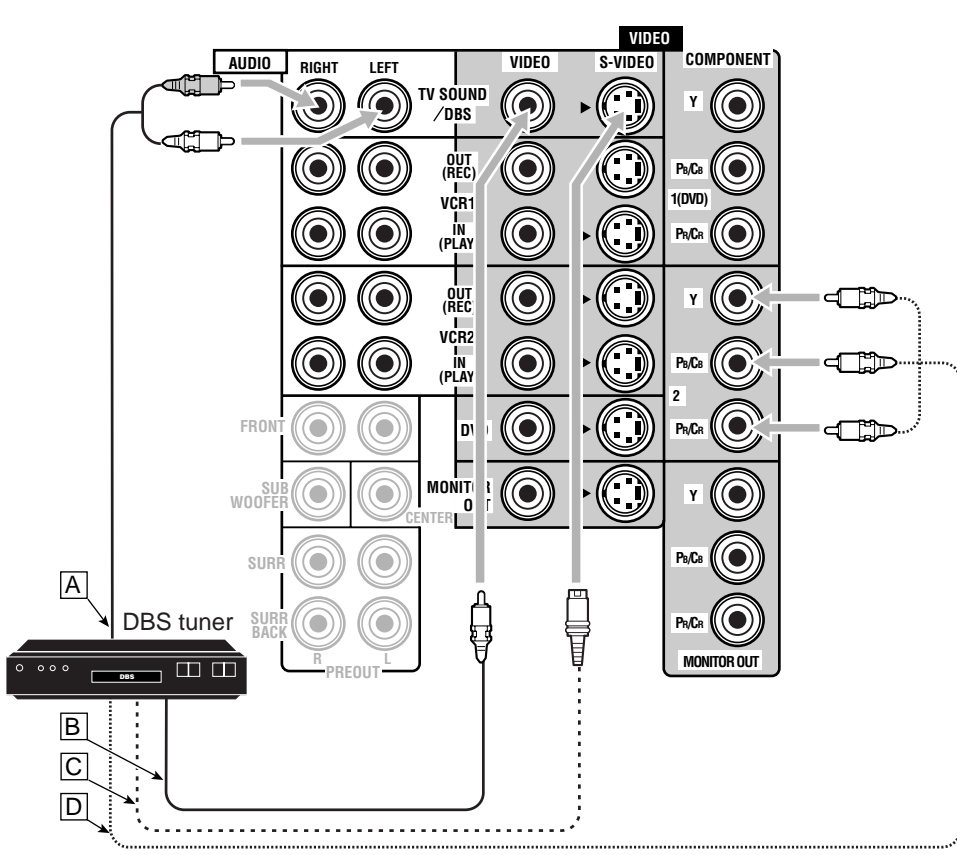
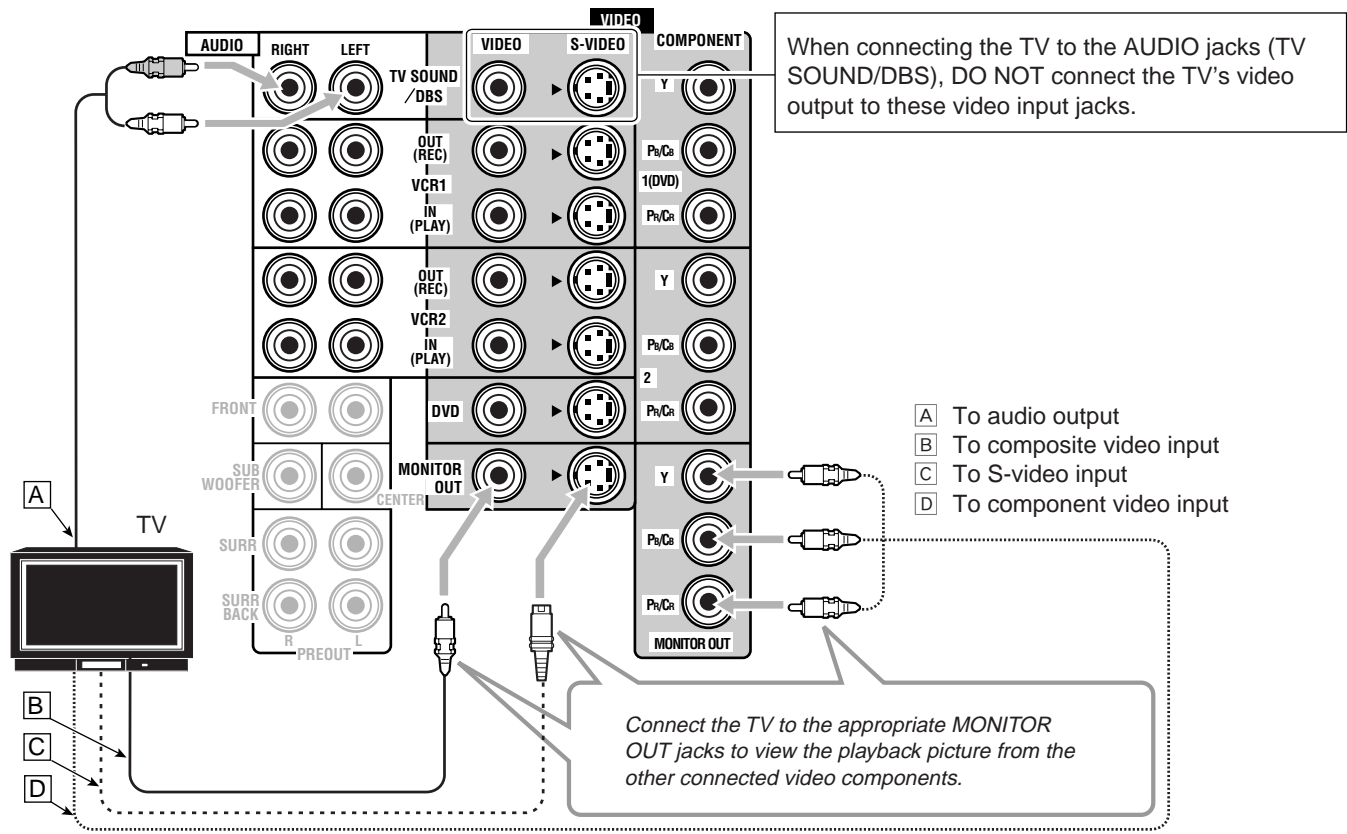

- Notes:**
- When connecting the DBS tuner to the TV SOUND/DBS jacks, change the source name to "DBS," which will be shown on the display when selected as the source. See "Changing the Source Name" on page 22 for details.
 - If your DBS tuner has the component video output jacks, you can connect it to either the COMPONENT 1 (DVD) or the COMPONENT 2 jacks. When connecting the DBS tuner to either one of the component input jacks, make the component input (COMPONENT) terminal setting correctly. For details, see "Preparing for the Component Video Input—COMPONENT IN" on page 32.

DVD player

- When you connect the DVD player with stereo output jacks:

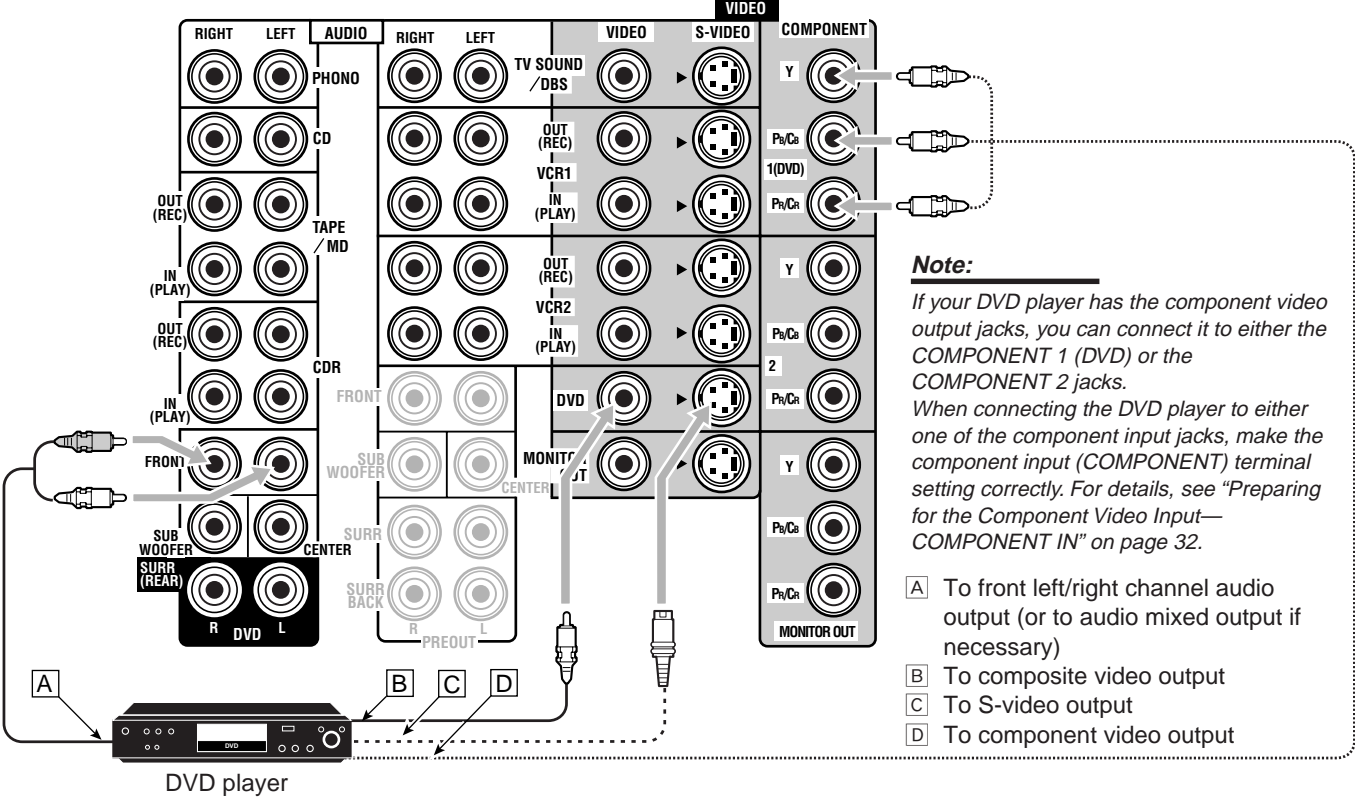

- When you connect the DVD player with its analog discrete output (5.1 CH reproduction) jacks:

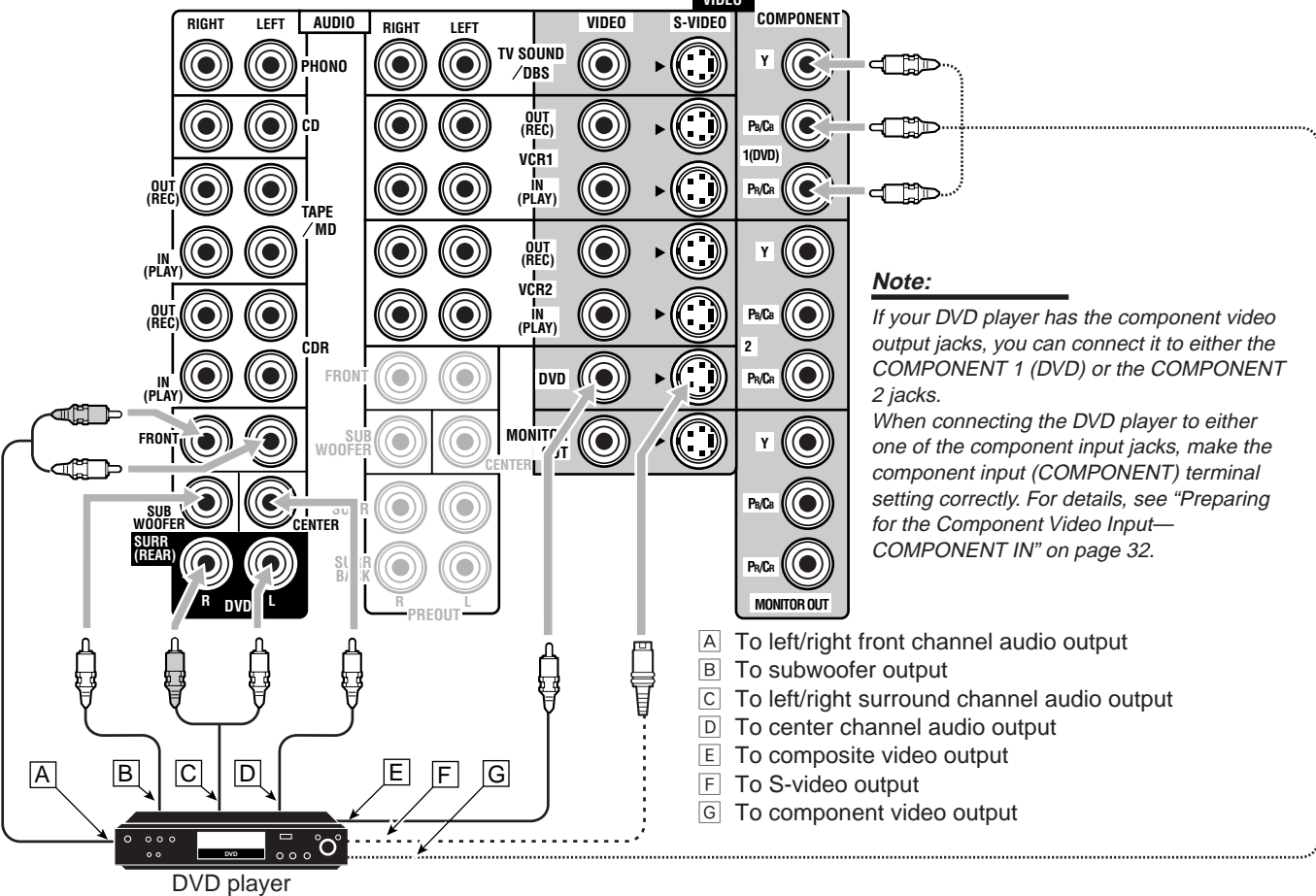

Digital Connections

This receiver is equipped with four DIGITAL IN terminals—one digital coaxial terminal and three digital optical terminals—and one DIGITAL OUT terminal.

IMPORTANT:

- When connecting the DVD player, digital TV broadcast tuner, or DBS tuner using the digital terminals, you also need to connect it to the video terminal on the rear. Without connecting it to the video terminal, you cannot view any playback picture.
- After connecting the components using the DIGITAL IN terminals, set the following correctly if necessary.
 - Set the digital input (DIGITAL IN) terminal setting correctly. For details, see "Setting the Digital Input Terminals—DIGITAL IN" on page 32.
 - Select the digital input mode correctly. For details, see "Selecting the Analog or Digital Input Mode" on page 20.

Digital input terminals

You can connect any digital component as follows:

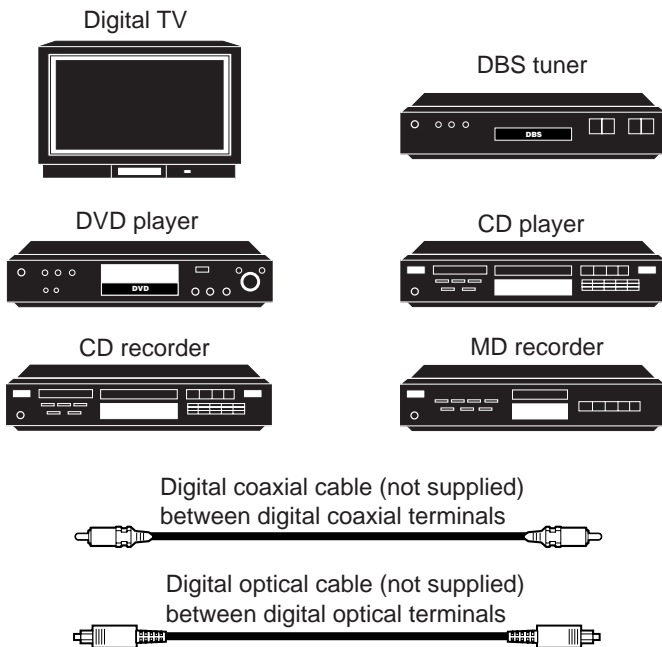

When the component has a digital coaxial output terminal, connect it to the DIGITAL 1 (DVD) terminal, using the digital coaxial cable (not supplied).

When the component has a digital optical output terminal, connect it to the DIGITAL 2 (CD), DIGITAL 3 (TV), DIGITAL 4 (CDR), or terminal, using the digital optical cable (not supplied).

Before connecting a digital optical cable, unplug the protective plug.

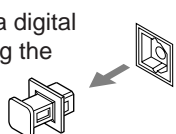

Notes:

- When shipped from the factory, the DIGITAL IN terminals have been set for use with the following components:
 - DIGITAL 1 (coaxial): For DVD player
 - DIGITAL 2 (optical): For CD player
 - DIGITAL 3 (optical): For digital TV broadcast tuner
 - DIGITAL 4 (optical): For CD recorder
- When you want to operate the CD player, CD recorder, or MD recorder using the COMPU LINK remote control system, connect the target component also as described in "Analog connections" (see page 10).
- When you want to operate the VCR or DVD player using the AV COMPU LINK remote control system, connect the target component also as described in "Analog connections" (see pages 11, 13).

Digital output terminal



Digital optical cable (not supplied)
between digital optical terminals



When the digital recording equipment such as an MD recorder and a CD recorder has a digital optical input terminal, connecting it to the DIGITAL OUT terminal enables you to perform digital-to-digital recording.

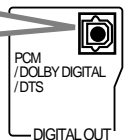

Note:

The digital signal format of the signals output through the DIGITAL OUT terminal is the same as that of the input signal. This means that when the DTS Surround signals are input, the DTS Surround signals are output.

Connecting the Power Cord

Before plugging the receiver into an AC outlet, make sure that all connections have been made.

Plug the power cord into an AC outlet.

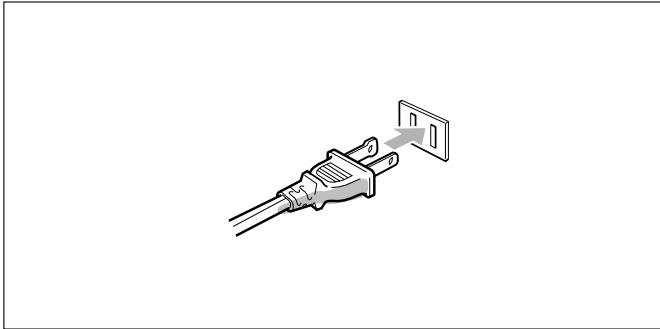

Keep the power cord away from the connecting cables and the antenna. The power cord may cause noise or screen interference. We recommend that you use a coaxial cable to connect the antenna, since it is well-shielded against interference.

Note:

The preset settings such as preset channels and sound adjustment may be erased in a few days in the following cases:

- When you unplug the power cord.
- When a power failure occurs.

CAUTIONS:

- Do not touch the power cord with wet hands.
- Do not pull on the power cord to unplug the cord. When unplugging the cord, always grasp the plug so as not to damage the cord.

Putting Batteries in the Remote Control

Before using the remote control, insert the two supplied batteries first.

1. On the back of the remote control, remove the battery cover.

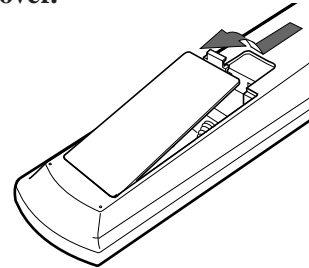

2. Insert the batteries.

- Make sure to match the polarity: (+) to (+) and (–) to (–).

R6(SUM3)/AA(15F)

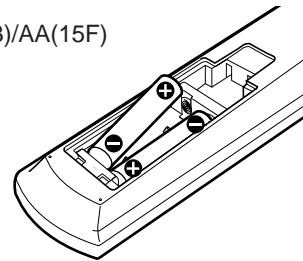

3. Replace the cover.

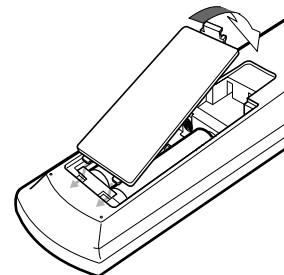

If the remote control cannot transmit signals or operate the receiver correctly, replace the batteries. Use two R6(SUM3)/AA(15F) type dry-cell batteries.

- When the remote control transmits a signal, the signal transmission indicator on the remote's display lights up.

Notes:

- If you aim the remote control directly at the remote sensor on the receiver, you can operate the receiver at a distance of up to 7 m (23 feet).
- When replacing the batteries, finish it without delay; otherwise, the preset signals are all erased (see page 58).

CAUTIONS:

Follow these precautions to avoid leaking or cracking cells:

- Place batteries in the remote control so they match the polarity: (+) to (+) and (–) to (–).
- Use the correct type of batteries. Batteries that look similar may differ in voltage.
- Always replace both batteries at the same time.
- Do not expose batteries to heat or flame.

Basic Operations

This section explains only the operations commonly used when you play any sound source.

- Before performing basic operations, it is recommended to finish the basic settings on pages 26 to 33.

IMPORTANT:

When using the unit:

Press DOOR DOWN to use the buttons inside the front door.

To close the front door, press DOOR UP.

When using the remote control:

Check the indication shown on the remote's display when you press a button—this indicates the remote control operation mode for a while (10 or 5 seconds).

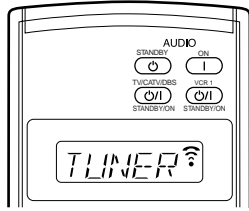

Ex. When you press FM.

3. Press DOOR DOWN so that you can use the other buttons inside the front door.



To close the front door, press DOOR UP once or twice. The front door moves up in two steps.

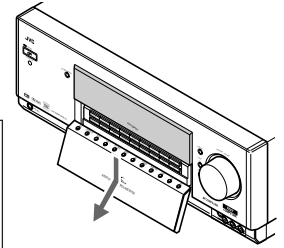

4. If no sounds come out of the front speakers, press SPEAKERS 1 and/or SPEAKERS 2 which you want to use.

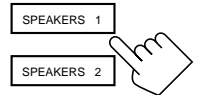

The selected front speaker indicator(s) light(s) up on the display.

- For more details, see “Activating the Front Speakers” on page 19.

5. Turn MASTER VOLUME to adjust the volume level of the sound through the speakers.

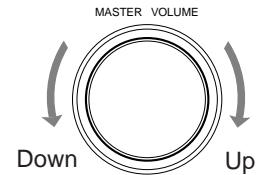

Simple Operating Procedure

On the unit:

1. Press **STANDBY/ON**.

The STANDBY lamp on the unit goes off, and the front door moves down so that the source selecting buttons appear.

- For more details, see “Turning the Power On and Off (Standby)” on page 17.

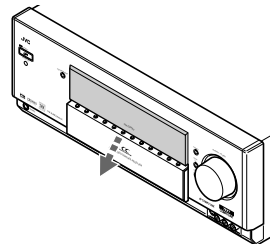
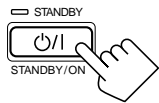

The last source is activated.



The last surround/DSP mode or other information appears.

The volume level appears.

The sound comes out of the speakers.

2. Select and play a source.

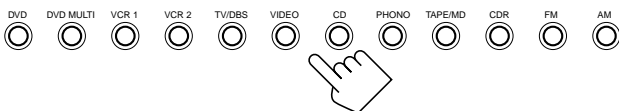

From the remote control:

1. Press **AUDIO ON**.

The STANDBY lamp on the unit goes off.

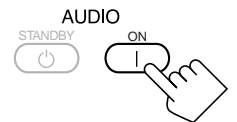

The last source is activated.



The last surround/DSP mode or other information appears.

The volume level appears.

The sound comes out of the speakers.

- See also “Turning the Power On and Off (Standby)” on page 17.

- If no sounds come out of the front speakers, press SPEAKERS 1 and/or SPEAKERS 2 on the unit. The speakers 1 and/or 2 indicator(s) light(s) on the display.

For more details, see “Activating the Front Speakers” on page 19.

2. Select and play a source.



3. Press **VOLUME +/-** to adjust the volume level of the sound through the speakers.

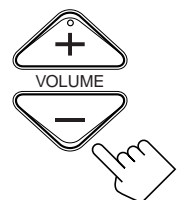

Turning the Power On and Off (Standby)

On the unit:

To turn on the power, press **⏻/I** (STANDBY/ON). The STANDBY lamp goes off, and the front door moves down (so that the source selecting buttons appear).

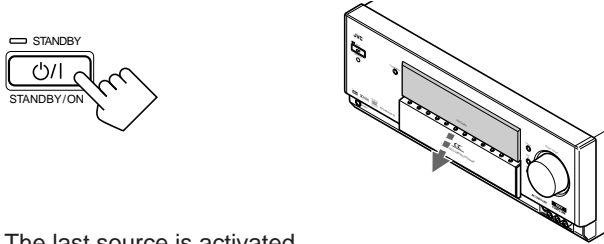

The last source is activated.



The last Surround/DSP mode or other information appears.

The volume level appears.

The currently selected speakers 1 and/or 2 indicator(s) also light(s) up on the display.

- If neither speakers 1 nor 2 indicator is lit on the display, see “Activating the Front Speakers” on page 19.

To turn off the power (into standby mode), press **⏻/I** (STANDBY/ON) again.

The STANDBY lamp lights up, and the front door automatically closes.

- A small amount of power is consumed in standby mode. To turn the power off completely, unplug the AC power cord.

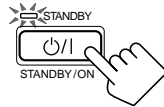

From the remote control:

To turn on the power, press **AUDIO I** (ON).

The STANDBY lamp goes off, and the front door moves down (so that the source selecting buttons appear).

The last source is activated.

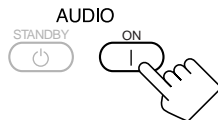

The last Surround/DSP mode or other information appears.

The volume level appears.

The currently selected speakers 1 and/or 2 indicator(s) also light(s) up on the display.

- If neither speakers 1 nor 2 indicator is lit on the display, see “Activating the Front Speakers” on page 19.

To turn off the power (into standby mode), press **AUDIO ⏻** (STANDBY).

The STANDBY lamp lights up.

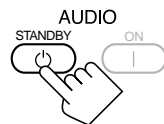

Note:

If you have turned off the receiver with the volume level set at more than level “-35 dB,” the volume level will be automatically set at level “-35 dB” next time you turn on the receiver.

Selecting the Source to Play

Press one of the source selecting buttons.

- The selected source name and Surround/DSP mode also appear on the display.

On the unit:

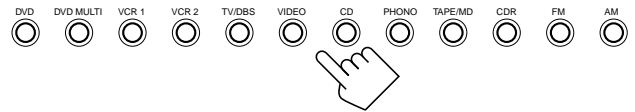

From the remote control:

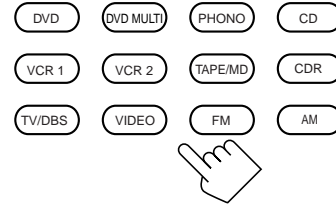

Selected source name



The current Surround/DSP mode appears.

- DVD : Selects the DVD player.
- DVD MULTI : Selects the DVD player for viewing the digital video disc using the analog discrete output mode (5.1CH reproduction).
To enjoy the DVD MULTI playback, see page 46.
- VCR 1 : Selects the video component connected to the VCR 1 jacks.
- VCR 2 : Selects the video component connected to the VCR 2 jacks.
- TV/DBS : Selects TV sounds (or the DBS tuner).
- VIDEO : Selects the video component connected to the VIDEO jacks.
- CD* : Selects the CD player.
- PHONO* : Selects the turntable.
- TAPE/MD* : Selects the cassette deck (or the MD recorder).
- CDR* : Selects the CD recorder.
- FM* : Selects an FM broadcast.
- AM* : Selects an AM broadcast.

Notes:

- When connecting an MD recorder (to the TAPE/MD jacks), and a DBS tuner (to the TV SOUND/DBS jacks), change the source names shown on the display. For details, see “Changing the Source Name” on page 22.
- When you press one of the audio source selecting buttons on the remote control marked with an asterisk (*), the receiver automatically turns on.

Speaker and signal indicators on the display

By checking the following indicators, you can easily confirm which speakers you are activating and which signals are coming into this receiver from the source.

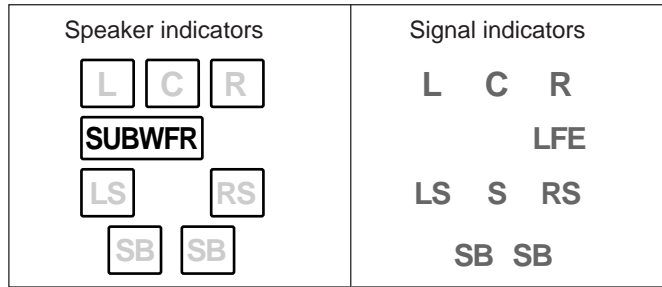

The speaker indicators light only —:

- The frames of “L,” “C,” “R,” “LS,” “RS,” and “SB” light up, when the corresponding speakers are set to “LARGE” or “SMALL” (see “Setting the Speakers—SPEAKER SETTING” on page 29) AND when the corresponding speaker is required for the DSP mode currently selected.
- When “SUBWOOFER” is set to “YES,” **SUBWFR** lights up. (See “Setting the Speakers—SPEAKER SETTING” on page 29.)

The signal indicators light up to indicate the incoming signals.

- L** : • **When digital input is selected:** Lights up when the left channel signal comes in.
- **When analog input is selected:** Always lights up.
- R** : • **When digital input is selected:** Lights up when the right channel signal comes in.
- **When analog input is selected:** Always lights up.
- C** : Lights up when the center channel signal comes in.
- LFE** : Lights up when the LFE channel signal comes in.
- LS** : Lights up when the left surround channel signal comes in.
- RS** : Lights up when the right surround channel signal comes in.
- S** : Lights up when the monaural surround channel signal comes in.
- SB** : Lights up when the surround back channel signal comes in.

Note:

When “DVD MULTI” is selected as the source, “L,” “C,” “R,” “LFE,” “LS” and “RS” light up.

To obtain the best performance of this receiver while using the Surround/DSP modes, check the speaker and signal indicators on the display carefully and set the speakers correctly.

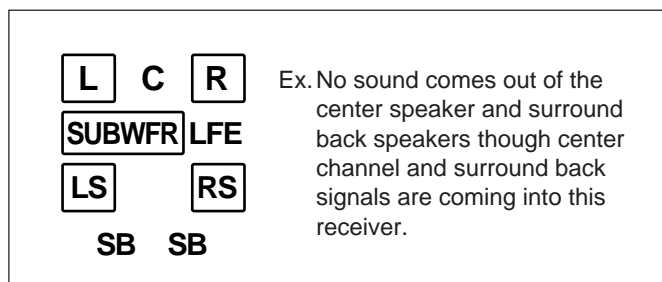

Selecting different sources for picture and sound

While watching pictures from a video source, you can listen to sound of a different source.

On the unit:

You can select any component as the sound source.

1. Press **SOUND SELECTOR** (inside the front door) while viewing the picture from a video component such as the VCR or DVD player, etc.

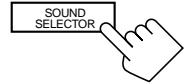

“AUDIO” appears followed by the current sound source.

Within 5 seconds

2. Press one of the source selecting buttons.

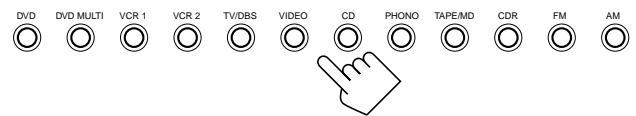

Note:

When “TV” has been assigned as the source name to the TV/DBS button, it does not work. To change the source name, see “Changing the Source Name” on page 22.

To match the video source and sound source again, repeat steps 1 and 2, and select the same sound source as the video source in step 2.

From the remote control:

You can select only audio component as the sound source when using the remote control.

- Once you have selected a video source, pictures of the selected source are sent to the TV until you select another video source.

Press one of the audio source selecting buttons—**PHONO, CD, TAPE/MD, CDR, FM, AM**—while viewing the picture from a video component such as the VCR or DVD player, etc.



Adjusting the Volume

On the unit:

To increase the volume, turn MASTER VOLUME clockwise.

To decrease the volume, turn it counterclockwise.

- When you turn MASTER VOLUME rapidly, the volume level also changes rapidly.
- When you turn MASTER VOLUME slowly, the volume level also changes slowly.

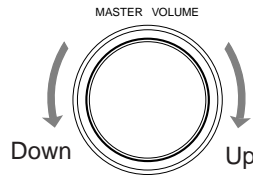

From the remote control:

To increase the volume, press VOLUME +.

To decrease the volume, press VOLUME -.

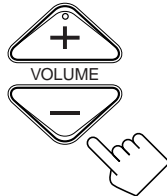

CAUTION:

Always set the volume to the minimum before starting any source. If the volume is set at a high level, the sudden blast of sound energy can permanently damage your hearing and/or ruin your speakers.

Notes:

- The volume level can be adjusted within the range of “-- dB” (minimum) to “+18.0 dB” (maximum).
- If you set One Touch Operation to “ON” (see page 33), you do not have to adjust the volume level each time you change the source. It is automatically set to the stored level. (However, if you have turned off the receiver with the volume level set at more than level “-35 dB,” the volume level will be automatically set at level “-35 dB” next time you turn on the receiver.)

Activating the Front Speakers

When you have connected two pairs of the front speakers, you can select which to use.

IMPORTANT:

You can activate two pairs of the front speakers at the same time only when the SPEAKER LOAD SELECTOR switch on the rear panel is set to the “HIGH” position and when signals are sent only to the front speakers. Otherwise, activating one pair of the speakers deactivates the other.

On the unit ONLY:

To use the speakers connected to the FRONT 1 SPEAKERS terminals, press SPEAKERS 1

(inside the front door) so that the speakers 1 indicator lights up on the display. (Make sure that the front speakers 2 indicator is not lit on the display.)

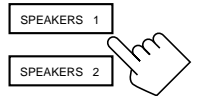

To use the speakers connected to the FRONT 2 SPEAKERS terminals, press SPEAKERS 2 (inside the front door) so that the front speakers 2 indicator lights up on the display. (Make sure that the front speakers 1 indicator is not lit on the display.)

To use both sets of the speakers, press SPEAKERS 1 and SPEAKERS 2 so that the front speakers 1 and 2 indicators light up on the display.

To use neither sets of the speakers, press SPEAKERS 1 and SPEAKERS 2 so that the front speakers 1 and 2 indicators disappear from the display. (“HEADPHONE” appears on the unit’s display).

Note:

In the following cases, the speakers connected to the FRONT 2 SPEAKERS terminals are deactivated even if both pairs of the front speakers are activated.

- If you select “DVD MULTI” as the source.
- If you select any of the Surround/DSP modes which activates the center and/or surround speaker(s).

Listening only with headphones:

Sounds through the front speakers and the subwoofer shut off when connecting a pair of headphones to the PHONES jack. (“HEADPHONE” appears on the unit’s display.)

You can enjoy the following sounds through the headphones:

- If the Surround mode is activated, you can enjoy surround effect. (For details, see “3D HEADPHONE Mode” on page 40.)
- If a DSP mode is activated, you can enjoy the DSP effect. (For details, see “HEADPHONE Mode” on page 44.)

CAUTION:

Be sure to turn down the volume before connecting or putting on headphones, as high volume can damage both the headphones and your hearing.

Selecting the Analog or Digital Input Mode

When you have connected digital source components using the digital terminals (see page 14), you need to select the digital input mode.

Before you start, remember...

The digital input (DIGITAL IN) terminal setting should be correctly done for the sources you want to select the digital input mode for (see "Setting the Digital Input Terminals—DIGITAL IN" on page 32). Without setting this digital input terminal correctly, you cannot change the input mode from analog input to digital input even if you follow the procedure below.

1. Press one of the source selecting buttons (DVD, VCR1, TV/DBS, CD, CDR, or TAPE/MD)* for which you want to change the input mode.



Note:

* You can select the digital input only for the sources which you have selected the digital input terminals for. (See "Setting the Digital Input Terminals—DIGITAL IN" on page 32.) In addition, when "TAPE" has been assigned as the source name to the TAPE/MD button, it does not work in this step. To change the source name, see "Changing the Source Name" on page 22.

2. Press INPUT MODE (or ANALOG/DIGITAL INPUT) to change the input mode.

- Each time you press the button, the input mode changes as follows:

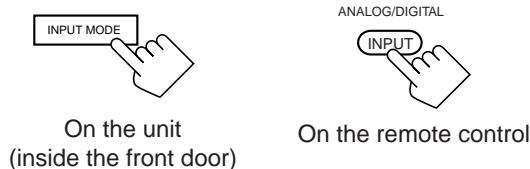

DIGITAL AUTO : Select this for the digital input mode.

The receiver automatically detects the incoming signals.

The DIGITAL AUTO indicator lights up on the display, and the digital signal format indicators for the detected signals also light up.

ANALOG : Select this for the analog input mode.

The ANALOG indicator lights up.

When selecting "DIGITAL AUTO," the following indicators indicate the digital signal format of the incoming signal.

- LINEAR PCM** : Lights up when Linear PCM signals come in.
- DIGITAL** : Lights up when Dolby Digital or Dolby Digital EX signals come in.
- dts** : Lights up when DTS Surround or DTS-ES signals come in.

No indicator lights up when the receiver cannot recognize the digital signal format of the incoming signals.

When playing a software encoded with the Dolby Digital or DTS Surround, the following symptoms may occur:

- Sound does not come out at the beginning of playback.
- Noise comes out while searching for or skipping chapters or tracks.

In this case, press RIGHT (or LEFT) on the unit to select "DOLBY DIGITAL" or "DTS" while "DIGITAL AUTO" still remains on the display.

- Each time you press the button, the input mode changes as follows:

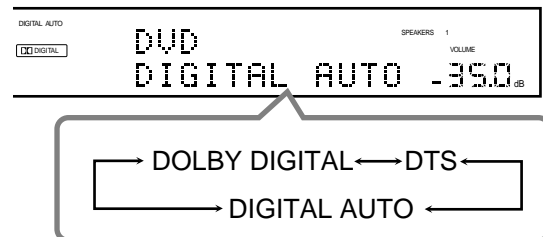

When "DOLBY DIGITAL" or "DTS" is selected, the DIGITAL AUTO indicator goes off, and the corresponding digital signal format indicator (**DIGITAL** or **dts**) lights up on the display.

- If the incoming signal does not match the selected digital signal format, the frame of the selected indicator will flash.

Note:

When you turn off the power or select another source, "DOLBY DIGITAL" and "DTS" settings are canceled and the digital input mode is automatically reset to "DIGITAL AUTO."

Attenuating the Input Signal

When the input level of the playing source is too high, the sounds will be distorted. If this happens, you need to attenuate the input signal level to prevent sound distortion.

- You have to make this setting for each source.

On the unit ONLY:

Press **INPUT ATT** (inside the front door).

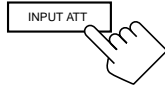

- Each time you press the button, the input attenuator mode turns on (“INPUT ATT ON”) or off (“INPUT ATT OFF”).
- When the input attenuator is on, the INPUT ATT indicator also lights up.



Ex. When the source is “VIDEO.”

Notes:

- This effect is applied to only the sources connected to the analog terminals.
- This function is not valid for the DVD MULTI playback mode.

Muting the Sound

From the remote control ONLY:

Press **MUTING** to mute the sound through all speakers and headphones connected.



“MUTING” appears on the display and the volume turns off (the volume level indicator goes off).



Ex. When the source is “VIDEO.” The volume level indicator goes off.

To restore the sound, press **MUTING** again so that “MUTING OFF” appears on the display for a while.

- Turning **MASTER VOLUME** on the unit or pressing **VOLUME +/-** on the remote control also restores the sound.



Turning Line Direct On and Off

You can enjoy the sound closer to original source by skipping the sound adjustments such as Midnight mode (see page 31), speaker output level adjustments (see page 37) and Parametric Equalizer (see page 37). You can only adjust the volume level while Line Direct is in use.

- You have to make this setting for each source.

Press **LINE DIRECT**.

- Each time you press the button, Line Direct turns on and off.
 - When Line Direct turns on, “LINE DIRECT” appears in the main display.

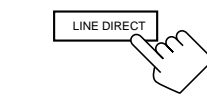

On the unit
(inside the front door)



On the remote control



Ex. When the source is “VIDEO.”

Notes:

- If you turn on Line Direct while using the Surround and DSP modes, the effect changes as follows:

Input \ Mode	Surround	DSP
Analog	Not valid	Not valid
Digital	Valid	Not valid

- If you turn on Line Direct, CC Converter (see page 22) is canceled.
- Turning off Line Direct activates the sound adjustments previously selected such as Midnight mode, speaker output level adjustments and Parametric Equalizer.
- If you turn off Line Direct while listening to an analog source, muting time* will be a little longer. (* The period during which no sound comes out.)

Using the Sleep Timer

Using the Sleep Timer, you can fall asleep to music and know the receiver will turn off by itself rather than play all night.

From the remote control ONLY:

Press SLEEP repeatedly.

The SLEEP indicator lights up on the display, and the shut-off time changes as follows (in minutes):

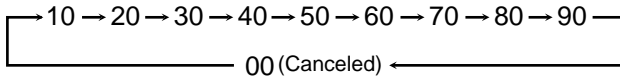

Ex. When the source is "VIDEO."

When the shut-off time comes

The receiver turns off automatically.

To check or change the time remaining until the shut-off time

Press SLEEP once.

The remaining time until the shut-off time appears in minutes.

- To change the shut-off time, press SLEEP repeatedly.

To cancel the Sleep Timer

Press SLEEP repeatedly until "SLEEP 00min." appears on the display. (The SLEEP indicator goes off.)

- Turning off the power also cancels the Sleep Timer.

Recording a Source

For analog-to-analog recording

You can record any analog source through the receiver to—

- the cassette deck (or MD recorder) connected to the TAPE/MD jacks,
 - the VCRs connected to the VCR 1 and VCR 2 jacks, and
 - the CD recorder connected to the CDR jacks
- at the same time.

For digital-to-digital recording

You can record the currently selected digital input source through the receiver to a digital recording device connected to the DIGITAL OUT terminal.

Notes:

- Analog-to-digital and digital-to-analog recordings are not possible.
- All sound adjustments cannot affect the recording.
- The test tone signal (see pages 37 and 42) does not come out through the DIGITAL OUT terminal.

IMPORTANT:

While recording, do not turn off the receiver source; otherwise, recording will stop.

Basic adjustment auto memory

This receiver memorizes sound settings for each source—

- when you turn off the power,
- when you change the source,
- when you change the analog/digital input mode (see page 20), and
- when you turn on One Touch Operation (see page 33).

When you change the source, the memorized settings for the newly selected source are automatically recalled.

The following can be stored for each source:

- Analog/digital input mode (see page 20)
- Input attenuator mode (see page 21)
- Line Direct (see page 21)
- Midnight mode (see page 31)
- Speaker channel output levels (see page 37)
- Parametric Equalizer setting (see page 37)
- DSP Parameters (see page 38)
- THX Surround On/Off setting (see page 41)
- Surround mode On/Off setting (see page 41)
- DSP mode selection (see page 44)

Notes:

- If the source is FM or AM, you can assign a different setting for each band.
- If you want to memorize the volume level together with the above setting, set "ONE TOUCH OPERATION" to "ON" (see page 33).

Receiving Radio Broadcasts

You can browse through all the stations or use the preset function to go immediately to a particular station.

IMPORTANT:

- **When using the remote control:**
Check the indication shown on the remote's display when you press a button—this indicates the remote control operation mode for a while (10 or 5 seconds).

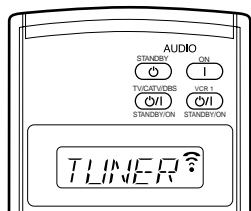

Ex. When you press FM.

- **When using the unit:**
Press DOOR DOWN to use the buttons inside the front door.

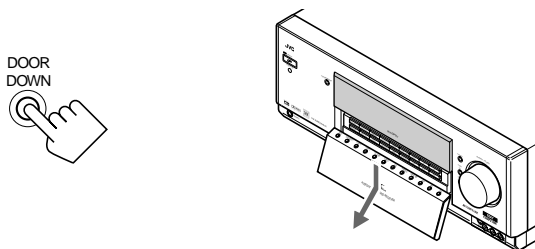

To close the front door, press DOOR UP.

Tuning into Stations Manually

On the unit:

1. Press FM or AM.

The last received station is tuned in.

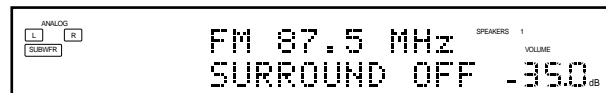
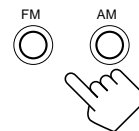

2. Press UP or DOWN (inside the front door) until you find the frequency you want.

- Pressing UP increases the frequencies.
- Pressing DOWN decreases the frequencies.

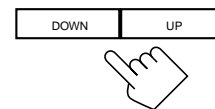

From the remote control:

1. Press FM or AM.

The last received station is tuned in.

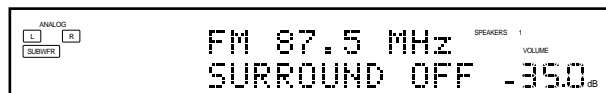
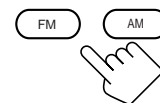

2. Press TUNING UP or TUNING DOWN until you find the frequency you want.

- Pressing TUNING UP increases the frequencies.
- Pressing TUNING DOWN decreases the frequencies.

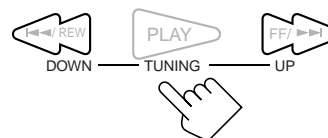

Notes:

- When a station of sufficient signal strength is tuned in, the TUNED indicator lights up on the display.
- When an FM stereo program is received, the STEREO indicator also lights up.
- When you hold the button (and release it) in step 2, the frequency keeps changing until a station is tuned in.

Using Preset Tuning

Once a station is assigned to a channel number, the station can be quickly tuned in. You can preset up to 30 FM and 15 AM stations.

To store the preset stations

Before you start, remember...

- There is a time limit in doing the following steps. If the setting is canceled before you finish, start from step 1 again.

On the unit ONLY:

1. Tune into an FM or AM station you want to preset (see “Tuning into Stations Manually” on page 24).
 - If you want to store the FM reception mode for an FM station, select the FM reception mode you want. See “Selecting the FM Reception Mode.”

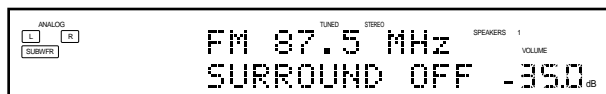

2. Press SET (inside the front door).

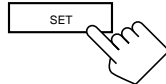

The channel number position starts flashing on the display for about 10 seconds.

3. Press RIGHT or LEFT (inside the front door) to select a channel number while the channel number position is flashing.

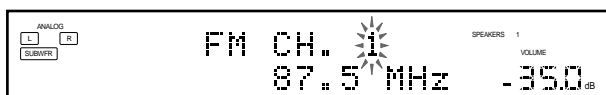
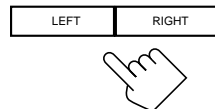

4. Press SET again while the selected channel number is flashing on the display.

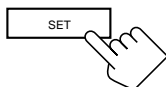

The selected channel number stops flashing. The station is assigned to the selected channel number.

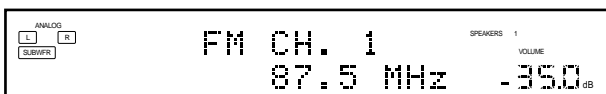

5. Repeat steps 1 to 4 until you store all the stations you want.

To erase a stored preset station

Storing a new station on a used number erases the previously stored one.

To tune into a preset station

On the unit:

1. Press FM or AM. The last received station is tuned in.
2. Press RIGHT or LEFT until you find the channel you want.
 - Pressing RIGHT increases the number.
 - Pressing LEFT decreases the number.

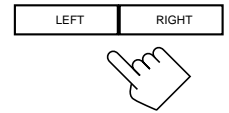
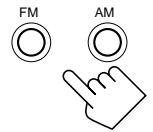

From the remote control:

1. Press FM or AM. The last received station is tuned in.
2. Press the 10 keys to select a preset channel number.
 - For channel number 5, press 5.
 - For channel number 15, press +10 then 5.
 - For channel number 20, press +10 then 10.
 - For channel number 30, press +10, +10, then 10.

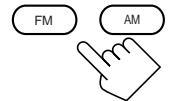

Selecting the FM Reception Mode

When an FM stereo broadcast is hard to receive or noisy

You can change the FM reception mode while receiving an FM broadcast.

- You can store the FM reception mode for each preset station.

Press FM MODE.

- Each time you press the button, the FM reception mode alternates between “AUTO MUTING” and “MONO.”

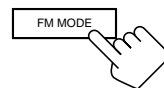

On the unit
(inside the front door)



On the remote control

AUTO MUTING: When a program is broadcasted in stereo, you will hear stereo sound; when in monaural, you will hear monaural sounds. This mode is also useful to suppress static noise between stations. The AUTO MUTING indicator lights up on the display.

MONO: Reception will be improved although you will lose the stereo effect. In this mode, you will hear noise while tuning into the stations. The AUTO MUTING and STEREO indicators go off from the display.

Note:

When you press FM MODE on the remote control, be sure that “TUNER” appears on the remote’s display. If not, press FM first, then press FM MODE.

Basic Settings

Some of the following settings are required after connecting and positioning your speakers, while others will make operations easier.

When performing the basic settings, it is recommended to use the remote control so that you can show the on-screen display menu on the TV.

- When using the buttons on the unit, you can perform the same settings referring to the indications on the unit's display. (The following on-screen display menus cannot be shown if you use the buttons on the unit.)

Setup Menu Configuration

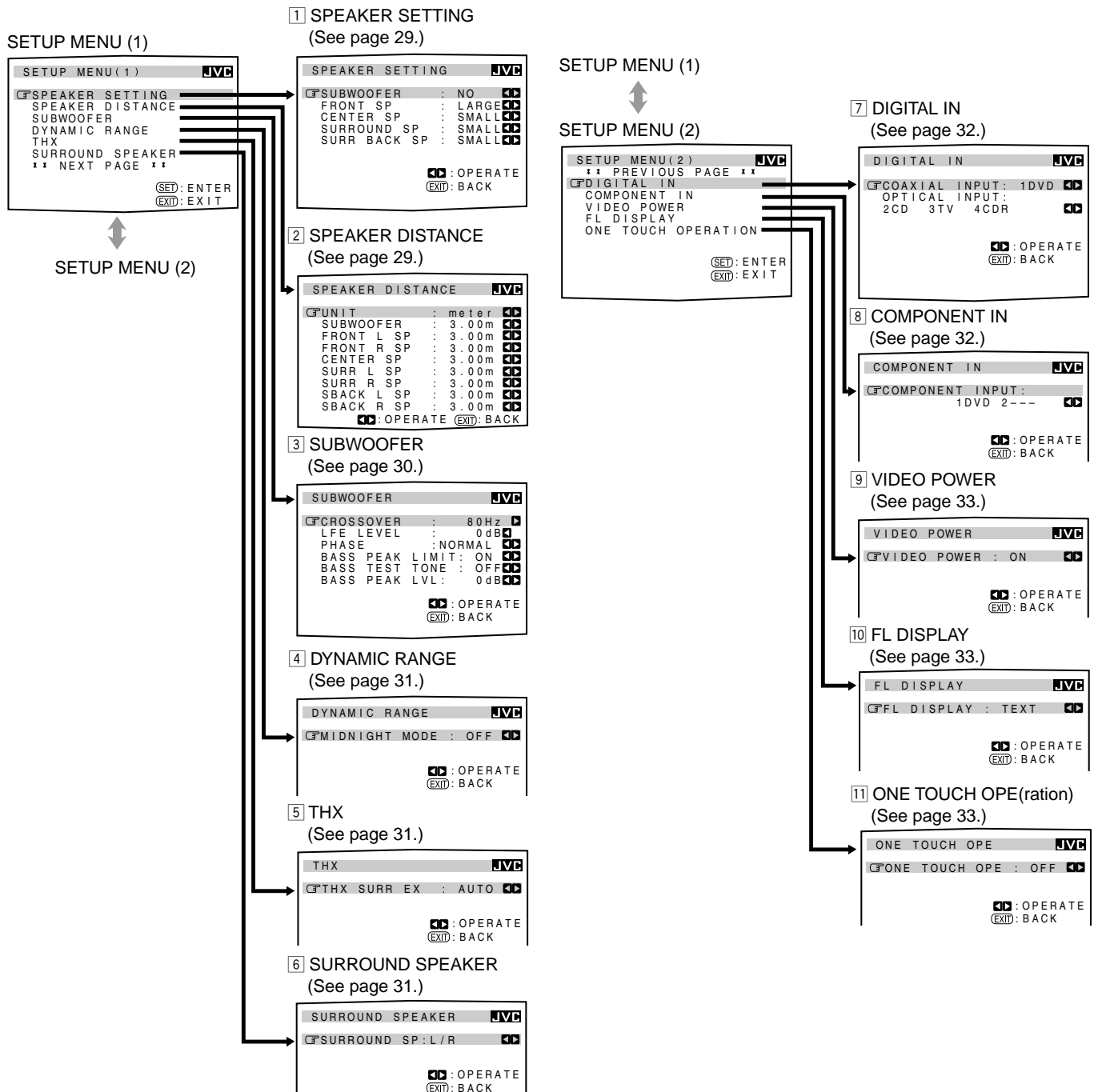

NOTICE—

- Items on the menus shown above are all set to the initial values when shipped from the factory.
- Some of the menus or some items on the menu cannot be shown or cannot be adjusted. (For details, see the respective explanation in this section.)

Note:

When performing the basic settings viewing the indications on the main unit's display, the indications are slightly different from what is shown on the on-screen display.

This is because of the limited number of characters shown on the main unit's display.

Ex. • "SPEAKER SETTING" is shown as "SP SETTING" on the main unit's display.

• "SPEAKER DISTANCE" is shown as "SP DISTANCE" on the main unit's display.

IMPORTANT:

- **When using the remote control:**
Check the indication shown on the remote's display when you press a button—this indicates the remote control operation mode for a while (10 or 5 seconds).

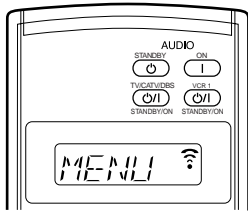

Ex. When you press SETUP MENU.

- **When using the unit:**
Press DOOR DOWN to use the buttons inside the front door.

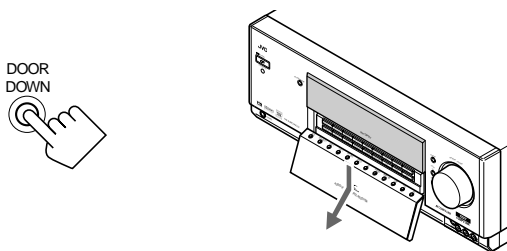

To close the front door, press DOOR UP.

The buttons that can be used on the menus are shown on the screen.
You can perform menu operation with these usable buttons.

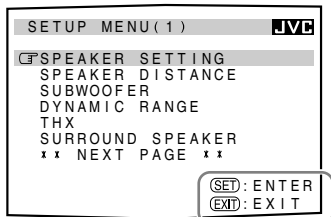

Usable buttons

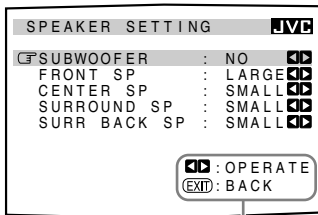

Usable buttons

Operation through On-Screen Display Menu

To do the basic settings for this receiver, use the remote control so that you can utilize the on-screen display menus in order to finish important settings easily while viewing these menus.

Menu operation buttons

From the remote control:

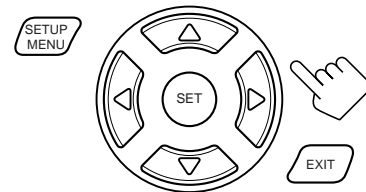

Button	To do
SETUP MENU	display or erase the Setup Menu.
▽ / △	select a submenu item on the Setup Menu or on submenus (downwards or upwards).
SET	move to the selected submenu screen.
◀ / ▶	select the desired setting on a submenu.
EXIT	exit from menu operations or return to the previous menu.

- When no operation is done for about 1 minute, the on-screen menu (as well as the indications in the unit's main display) will disappear.

On the unit:

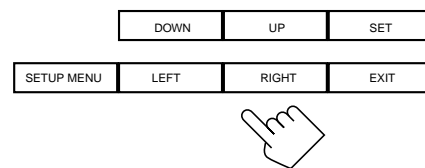

(inside the front door)

Button	To do
SETUP MENU	display or erase the Setup Menu.
DOWN/UP	select a submenu item on the Setup Menu or on submenus (downwards or upwards).
SET	move to the selected submenu screen.
LEFT/RIGHT	select the desired setting on a submenu.
EXIT	exit from menu operations or return to the previous menu.

- When no operation is done for about 5 seconds, the indications on the unit's display will disappear.

Menu Operating Procedure

Ex. When setting the speaker distance

Operations

1. Press SETUP MENU.

On the TV screen

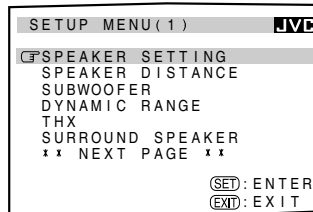

Setup Menu (1) appears.

On the main unit's display

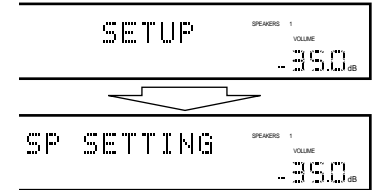

“SETUP” appears for 2 seconds*, then one** of the submenu names appears.

2. Press ▾ or ▲ (DOWN or UP) repeatedly to select the desired submenu.

- In this example, select “SPEAKER DISTANCE” submenu.

Move $\overleftarrow{\text{C}}$ to “SPEAKER DISTANCE.”

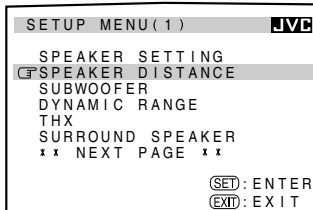

Press the button until “SP (speaker) DISTANCE” appears.

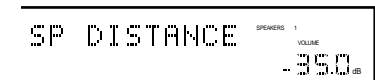

3. Press SET.

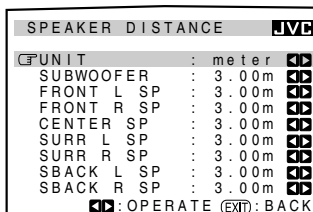

The selected submenu appears.



One item** on the selected submenu appears (with the current setting shown on the lower line of the main display).

4. Set a desired item on the submenu.

- Press ▾ or ▲ (DOWN or UP) repeatedly to select an item.
- Press ► or ◀ (RIGHT or LEFT) to set the item.

- In this example, set “UNIT” to “feet” for indicating the speaker distance.

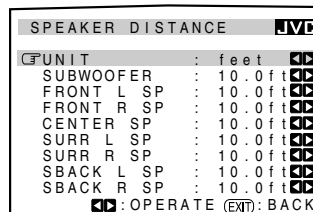

5. Set other items on the same submenu if necessary.

- Press ▾ or ▲ (DOWN or UP) repeatedly to select another item on the same submenu if necessary.
- Press ► or ◀ (RIGHT or LEFT) to set the item.

- In this example, set the center speaker distance.

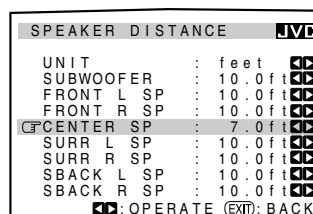

To move between the SETUP MENU (1) and (2)

- By simply pressing ▾ (or DOWN) repeatedly on the SETUP MENU (1), you can go to the SETUP MENU (2).
- By simply pressing ▲ (or UP) repeatedly on the SETUP MENU (2), you can go back to the SETUP MENU (1).

To return to the previous screens

Press EXIT.

Each time you press the button, the on-screen display menu returns to the one previously displayed. (On the unit's main display, the indications also change accordingly.)

To erase the menu (to return to the regular screen)

Press SETUP MENU.

- * “SETUP” appears only when using the button on the unit.
- ** When using the buttons on the unit, the last item selected will appear; on the other hand, when using the remote control, the first-listed item on the menu will always appear.

Setting the Speakers —SPEAKER SETTING (1)

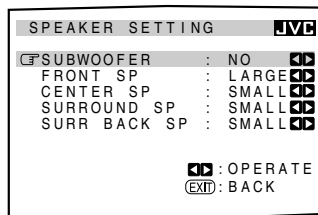

To obtain the best possible surround sound of the Surround and DSP modes, you have to register the information about the speaker arrangement after all connections are completed.

For subwoofer:

Select one of the following.

- | | |
|------------|--|
| YES | : Select this when a subwoofer is connected. |
| NO | : Select this when no subwoofer is used. |

For front speakers, center speaker, surround speakers, and surround back speakers:

Select one of the following.

- | | |
|--------------|---|
| LARGE | : Select this when the speaker size is relatively large. |
| SMALL | : Select this when the speaker size is relatively small. |
| NONE | : Select this when you have not connected a speaker.
(Not selectable for the front speakers) |

Notes:

- Keep the following comment in mind as reference when adjusting.
 - If the size of the cone speaker unit built in your speaker is greater than 12 cm (4 3/4 inches), select "LARGE," and if it is smaller than 12 cm (4 3/4 inches), select "SMALL."
- If you have selected "NO" for the subwoofer, you can only select "LARGE" for the front speakers.
- If you have selected "SMALL" for the front speakers, you cannot select "LARGE" for the center, surround, and surround back speakers.
- If you have selected "SMALL" for the surround speakers, you cannot select "LARGE" for the surround back speakers.
- If you have selected "NONE" for the surround speakers, the surround back speakers are fixed to "NONE."

Setting the Speaker Distance —SPEAKER DISTANCE (2)

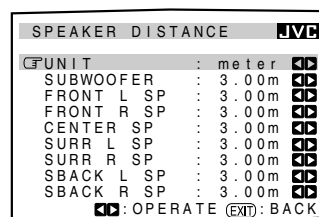

The distance from your listening point to the speakers is another important element to obtain the best possible surround sound of the Surround and DSP modes. You need to set the distance from your listening point to the speakers.

By referring to the speaker distance setting, this unit automatically sets the delay time of the sound through each speaker so that sounds through all the speakers can reach you at the same time.

For measuring unit:

Select one of the following.

- | | |
|--------------|---|
| meter | : Select this to set the distance by meter. |
| feet | : Select this to set the distance by feet. |

For each speaker:

Set the distance from the listening point within the range of **0.30 m (1.0 ft) to 9.00 m (30.0 ft)**, in 0.15 m (0.5 ft) intervals.

Notes:

- You cannot set the speaker distance for the speaker you have selected "NO" or "NONE" for on the SPEAKER SETTING submenu.
- This setting is not valid for the DVD MULTI playback mode.

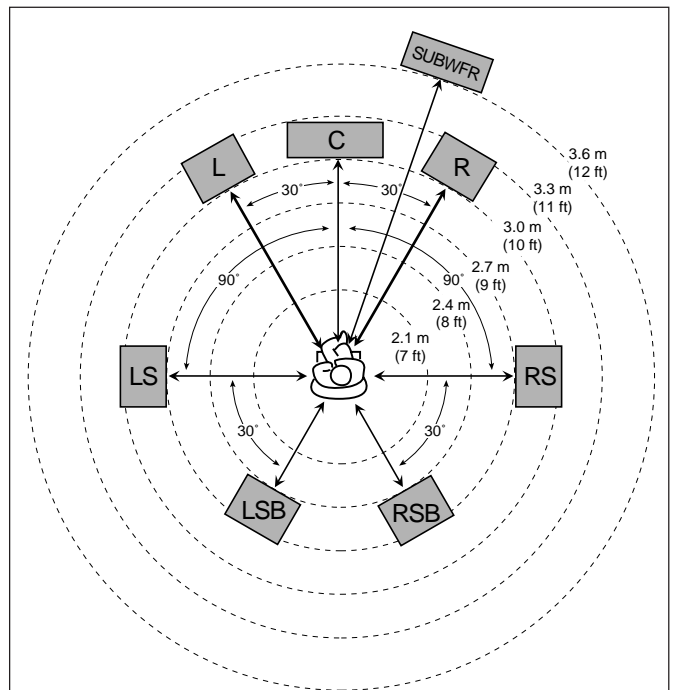

EX. In the above case, set the speaker distance as follows:

Subwoofer (SUBWFR)	SUBWOOFER:	3.60 m (12.0 ft)
Left front (L)	FRONT L SP:	3.00 m (10.0 ft)
Right front (R)	FRONT R SP:	3.00 m (10.0 ft)
Center (C)	CENTER SP:	3.00 m (10.0 ft)
Left surround (LS)	SURR L SP:	2.70 m (9.0 ft)
Right surround (RS)	SURR R SP:	2.70 m (9.0 ft)
Left surround back (LSB)	SBACK L SP:	2.40 m (8.0 ft)
Right surround back (RSB)	SBACK R SP:	2.40 m (8.0 ft)

Setting the Bass Sounds—SUBWOOFER (3)

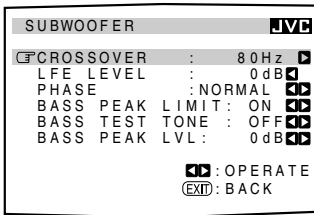

On this submenu, you can adjust subwoofer and bass sounds precisely according to your preference.

Setting the crossover frequency:

When you use a subwoofer, you can select the cutoff frequency for the small speakers used.

Select one of the crossover frequency levels according to the size of the small speaker connected.

80Hz : Select this when the cone speaker unit built in the speaker system is about 12 cm (4 3/4 inches).

100Hz : Select this when the cone speaker unit built in the speaker system is about 10 cm (3 15/16 inches).

120Hz : Select this when the cone speaker unit built in the speaker system is about 8 cm (3 3/16 inches).

Notes:

- Use the above comments as reference when adjusting.
- If you have selected "LARGE" for all activated speakers, this function will be set to "OFF."
- If "SUBWOOFER" is set to "NO" on the SPEAKER SETTING submenu, this function is not available.
- Crossover frequency is not valid for the DVD MULTI playback mode, ALL CH STEREO mode and 3D HEADPHONE mode.
- If Line Direct is in use, this function does not take effect.

Setting the low frequency effect attenuator (LFE):

If the bass sound is distorted while playing back software encoded with Dolby Digital or DTS Surround, set the LFE level to eliminate distortion.

Adjust the LFE level within the range of **-20 dB to 0 dB**. (Normally select "0 dB.")

- Each time you press > (RIGHT) or < (LEFT), the LFE level changes by ± 1 dB.

Notes:

- If "SUBWOOFER" is set to "NO" on the SPEAKER SETTING submenu, this function is not available.
- Low frequency effect attenuator is not valid for THX Surround EX and the DVD MULTI playback mode.

Changing the sound phase:

If the sound output through the subwoofer is not satisfactory, changing the phase will give you a different result.

Select one of the following:

NORMAL : Normally select this.

REVERSE : Select this to reverse the phase.

Note:

If "SUBWOOFER" is set to "NO" on the SPEAKER SETTING submenu, this function is not available.

Using the Bass Peak Limiter:

When this setting is "ON," Bass Peak Limiter functions so that sounds exceeding the preset peak level (see below) will be cut off.

When this setting is "ON," you can set the bass peak level using the bass test tone (see below) to eliminate bass sound distortion while playing back software encoded with Dolby Digital or DTS Surround.

Select one of the following:

ON : Normally select this.

OFF : Select this when not using the Bass Peak Limiter.

Outputting the bass test tone:

Only when "BASS PEAK LIMITER" is "ON," you can output the bass test tone through the subwoofer and/or other speakers (depending on your settings on the SPEAKER SETTING submenu), and adjust the bass peak level (see below).

Select one of the following:

ON : Select this to output the bass test tone.

OFF : Select this to stop the bass test tone.

Note:

If "BASS PEAK LIMITER" is set to "OFF," this function is not available.

Setting the bass peak level:

Only when "BASS PEAK LIMITER" is "ON," you can set the bass peak level so that sounds exceeding the peak level will be cut off to prevent the bass sound distortion.

Adjust the bass peak level within the range of **-12 dB to +18 dB**. (Normally select "0 dB.")

- While listening to the bass test tone, press and hold > (RIGHT) to increase the bass test tone output level, and stop increasing the level just before the test tone is distorted. The level where you stop can be memorized as the bass peak level.
- Each time you press > (RIGHT) or < (LEFT), the bass peak level changes by ± 1 dB.

Note:

When you set "BASS TEST TONE" to "ON," the bass peak level is reset to "--- dB" (no sound).

Setting the Dynamic Range —DYNAMIC RANGE (4)

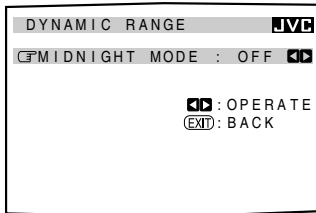

Using the Midnight mode, you can enjoy a powerful sound at night even at a low volume level.

Setting the Midnight mode:

Select one of the following:

- 1 : Select this when you want to reduce the dynamic range a little. The MIDNIGHT MODE indicator lights up on the display.
 - 2 : Select this when you want to apply the compress effect fully (useful at midnight). The MIDNIGHT MODE indicator lights up on the display.
- OFF** : Select this when you want to enjoy surround with its full dynamic range (no effect applied). The MIDNIGHT MODE indicator goes off from the display.

Notes:

- If Line Direct is in use, Midnight mode is temporarily canceled.
- Midnight mode is not valid for the THX Surround modes and DVD MULTI playback mode.

Preparing for THX Surround Modes—THX (5)

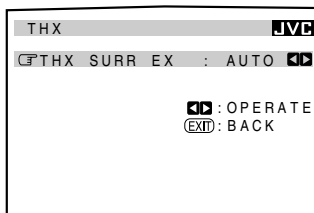

On this submenu screen, you can preset when and how to apply the THX Surround EX to playback software when you press THX ON/OFF button. (See page 41.)

Setting THX Surround EX:

Select one of the following:

- AUTO** : This unit automatically selects either “THX SURR EX” or “THX CINEMA” according to the playback software when you press THX ON/OFF.
- “THX SURR EX” is selected for software encoded with Dolby Digital EX (only if the Dolby Digital EX identification mark is recorded on the disc).
 - “THX CINEMA” is selected except for the above case.
- ON** : This unit automatically selects either “THX SURR EX” or “THX CINEMA” according to the playback software when you press THX ON/OFF.
- “THX SURR EX” is selected for multichannel digital software.
 - “THX CINEMA” is selected except for the above case.
- OFF** : When you press THX ON/OFF, “THX CINEMA” is always selected for any software.

Note:

When “SURR BK SP” is set to “NONE” on the SPEAKER SETTING submenu, this submenu is not available.

Setting the Surround Sound Output —SURROUND SPEAKER (6)

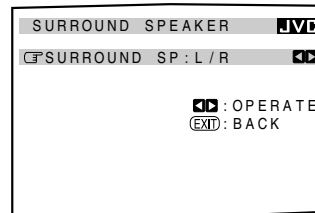

On this submenu screen, you can preset which surround speakers to use to output the surround sounds (except for the THX Surround EX, DAP modes, and DVD MULTI playback mode).

Setting the surround speakers to use

Select one of the following:

- L/R** : Select this to use only the left and right surround speakers.
- BACK** : Select this to use only the surround back speakers.
- L/R+BACK** : Select this to use both the surround speakers and surround back speakers.

Note:

When “SURR BACK SP” is set to “NONE” on the SPEAKER SETTING menu, this submenu is not available.

To activated the surround back speakers to the PREOUT SURR BACK jacks

Turn on the other amplifier connected to the PREOUT SURR BACK jacks; otherwise, no sound comes out of the surround back speakers even though you made the surround back speaker setting correctly on this submenu.

Setting the Digital Input Terminals —DIGITAL IN (7)

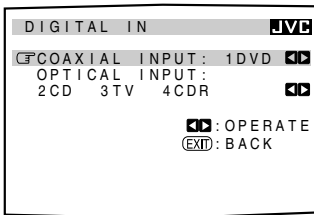

When you use the digital input terminals, you have to register what components you have connected to the digital input terminals.

Setting the component connected to the digital coaxial terminal

Set the component connected to the digital coaxial (DIGITAL IN 1) terminal.

- Each time you press \triangleright (RIGHT) or \triangleleft (LEFT), the digital component name changes as follows:

1DVD \rightleftharpoons 1CD \rightleftharpoons 1TV (or 1DBS*) \rightleftharpoons 1CDR \rightleftharpoons 1MD**
 \rightleftharpoons (back to the beginning)

- * If you have changed the source name from "TV" to "DBS," "DBS" appears (see page 22).
- ** If you want to connect an MD recorder to the digital input terminal, change the source name to "MD" from "TAPE" (see page 22).

Setting the component connected to the digital optical terminals

Set the components connected to the digital optical terminals.

- Each time you press \triangleright (RIGHT) or \triangleleft (LEFT), the digital component names change as follows:

When "COAXIAL INPUT" is set to "DVD"

2 CD 3 TV (or DBS*) 4 CDR \rightleftharpoons
2 CD 3 TV (or DBS*) 4 MD** \rightleftharpoons
2 CD 3 MD** 4CDR \rightleftharpoons
2 MD** 3 TV (or DBS*) 4 CDR \rightleftharpoons
(back to the beginning)

When "COAXIAL INPUT" is set to "CD"

2 DVD 3 TV (or DBS*) 4 CDR \rightleftharpoons
2 DVD 3 TV (or DBS*) 4 MD** \rightleftharpoons
2 DVD 3 MD** 4CDR \rightleftharpoons
2 MD** 3 TV (or DBS*) 4 CDR \rightleftharpoons
(back to the beginning)

When "COAXIAL INPUT" is set to "TV" or "DBS"*

2 CD 3 DVD 4 CDR \rightleftharpoons
2 CD 3 DVD 4 MD** \rightleftharpoons
2 CD 3 MD** 4 CDR \rightleftharpoons
2 MD** 3 DVD 4 CDR \rightleftharpoons
(back to the beginning)

When "COAXIAL INPUT" is set to "CDR"

2 CD 3 TV (or DBS*) 4 DVD \rightleftharpoons
2 CD 3 TV (or DBS*) 4 MD** \rightleftharpoons
2 CD 3 MD** 4 DVD \rightleftharpoons
2 MD** 3 TV (or DBS*) 4 DVD \rightleftharpoons
(back to the beginning)

When "COAXIAL INPUT" is set to "MD"**

2 CD 3 TV (or DBS*) 4 CDR \rightleftharpoons
2 CD 3 TV (or DBS*) 4 DVD \rightleftharpoons
2 CD 3 DVD 4 CDR \rightleftharpoons
2 DVD 3 TV (or DBS*) 4 CDR
(back to the beginning)

- * If you have changed the source name from "TV" to "DBS," "DBS" appears (see page 22).
- ** If you have connected an MD recorder to the digital input terminal, change the source name to "MD" from "TAPE" (see page 22).

Note:

When shipped from the factory, the DIGITAL IN terminals can be used as the digital input for the following components:

- DIGITAL 1 (coaxial): For DVD player
- DIGITAL 2 (optical): For CD player
- DIGITAL 3 (optical): For digital TV broadcast tuner
- DIGITAL 4 (optical): For CD recorder

Preparing for the Component Video Input —COMPONENT IN (8)

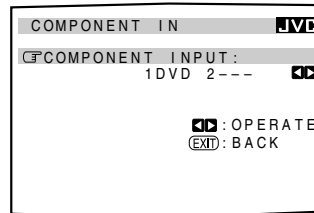

When you use the component video input, you have to register what components you have connected to the component input terminals. Without setting this correctly, you cannot view the correct input on the TV.

Setting the component video input terminals

Select the components connected to the COMPONENT 1 (DVD) and COMPONENT 2 video input terminals.

- Each time you press \triangleright (RIGHT) or \triangleleft (LEFT), the component name changes as follows:

1 DVD 2 --- \rightleftharpoons 1 DVD 2 DBS* \rightleftharpoons
1 DVD 2 VCR1 \rightleftharpoons 1 DBS* 2 --- \rightleftharpoons
1 DBS* 2 VCR1 \rightleftharpoons 1 VCR1 2 --- \rightleftharpoons
1 --- 2 --- \rightleftharpoons (back to the beginning)

Notes:

- * When you have connected the DBS tuner to the COMPONENT 1 (DVD) or COMPONENT 2 video input terminals, change the source name from "TV" to "DBS." To change the source name, see "Changing the Source Name" on page 22.
- When you have not connected any component, select "---."
- If you have not made this setting correctly, the AV COMPU LINK remote control system cannot operate properly. (See page 53.)

■ Turning On and Off the Video Output —VIDEO POWER (9)

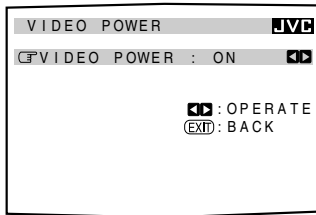

On this submenu screen, you can turn on or off the power supply to the video output circuit built in this unit.

■ *Turning on or off the power supply to the video circuit*

Select one of the following:

-
- ON** : Normally select this.
Power is supplied to the built-in video output circuit.
-
- OFF** : Select this not to supply power to the built-in video output circuit while playing an audio source.
With this setting, noise will be reduced while playing an audio source.
-

Note:

Even if "VIDEO POWER" is set to "OFF," power will be supplied to the video circuit when on-screen display menus are used.

■ Showing the Text Information on the Display—FL DISPLAY (10)

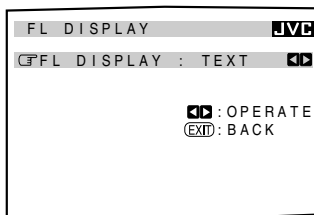

When you have connected an MD recorder or CD player equipped with TEXT COMPU LINK remote control system (see page 48), you can show the text information, such as disc title or track title, on the display of this receiver.

■ *Turning on or off the text information display*

Select one of the following:

-
- NORMAL**: Source name and Surround/DSP mode appear during play.
-
- TEXT** : Text information appears during play.
-

Note:

Though you have selected "TEXT," the source name and Surround/DSP mode will appear while playing a disc that has no text information.

■ Memorizing the Volume Level for Each Source—ONE TOUCH OPE(ration) (11)

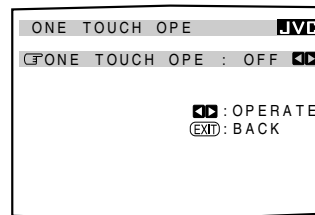

This unit memorizes many settings separately for each source. (See page 23.) In addition, you can store the volume level for each source together with the other memorized settings.

■ *Storing the volume level for each source*

Select one of the following:

-
- ON** : Select this to store the volume level setting separately for each source. (The ONE TOUCH OPERATION indicator lights up on the main unit's display.)
- This receiver memorizes the volume level—
- when you turn off the power,
 - when you change the source,
 - when you change the analog/digital input mode (see page 20), and
 - when you turn on One Touch Operation.
-
- OFF** : Select this not to store the volume level setting.
-

To recall the volume level

With the ONE TOUCH OPERATION indicator lit, the volume level for the currently selected source is recalled when the source is selected.

To cancel the One Touch Operation

Set One Touch Operation to "OFF" so that the ONE TOUCH OPERATION indicator goes off.

Sound Adjustments

When performing the sound adjustments, it is recommended to use the remote control so that you can show the on-screen display menu on the TV.

- When using the buttons on the unit, you can perform the same settings referring to the indications shown on the main unit's display. (The following on-screen display menus cannot be shown if you use the buttons on the unit.)

Adjustment Menu Configuration

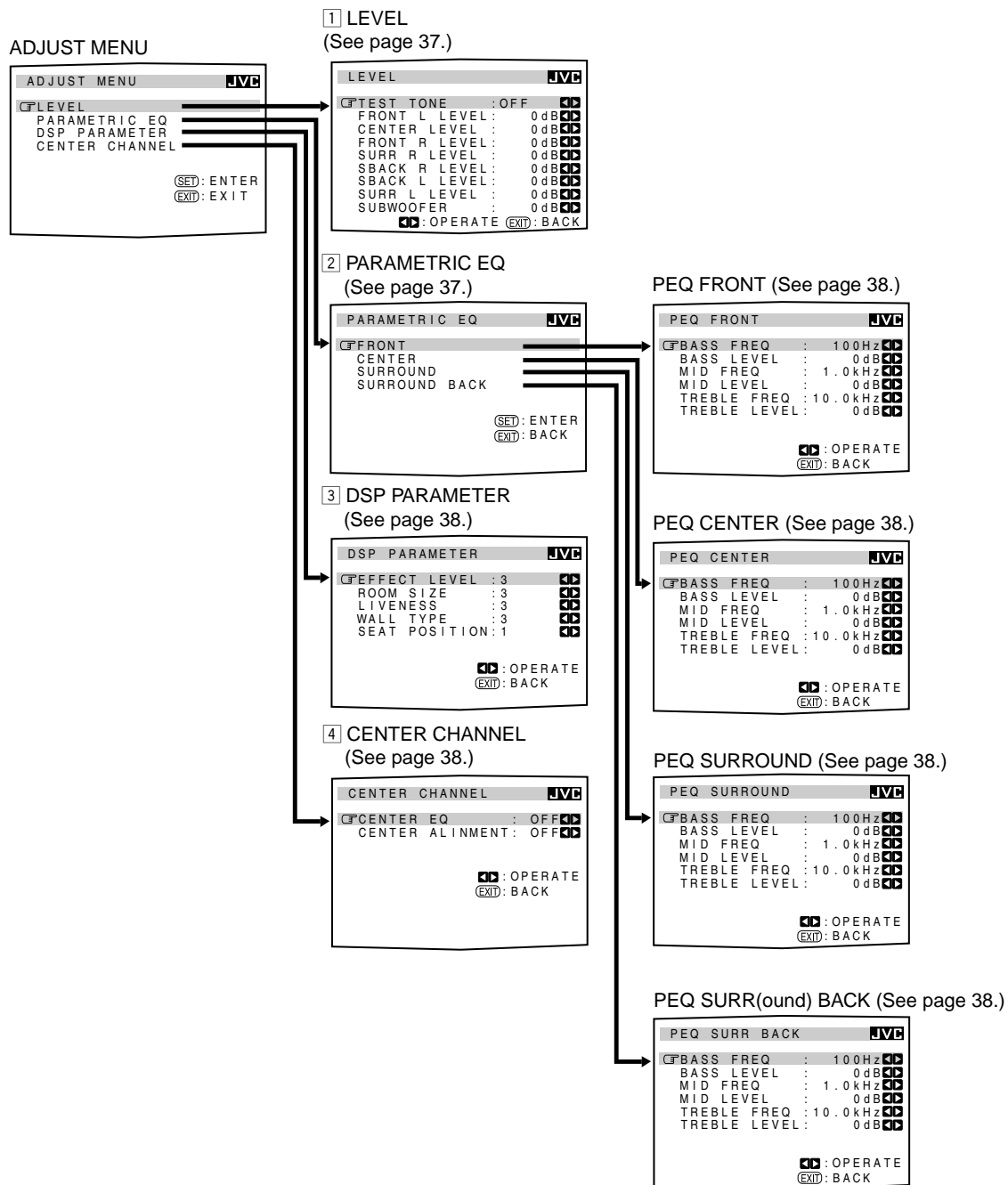

NOTICE—

- If Line Direct is in use (see page 21), you cannot make any sound adjustments using the Adjustment Menu.
- Items on the menus shown above are all set to the initial values when shipped from the factory.
- Some of the menus or some items on the menu cannot be shown or cannot be adjusted. (For details, see the respective explanation in this section.)

Note:

When performing sound adjustments viewing the indications on the main unit's display, the indications shown are slightly different from what is shown on the on-screen display.

This is because of the limited number of characters shown on the main unit's display.

Ex. • "FRONT L LEVEL" is shown as "FRONT L LVL" on the main unit's display.

• "CENTER LEVEL" is shown as "CENTER LVL" on the main unit's display.

IMPORTANT:

- **When using the remote control:**
Check the indication shown on the remote's display when you press a button—this indicates the remote control operation mode for a while (10 or 5 seconds).

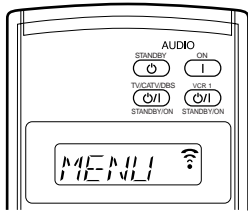

Ex. When you press ADJUST MENU.

- **When using the unit:**
Press DOOR DOWN to use the buttons inside the front door.

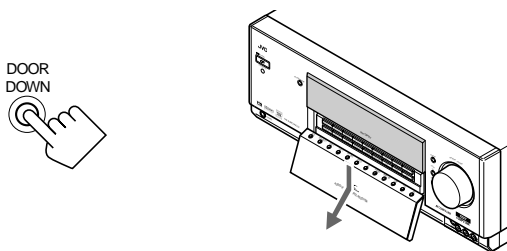

To close the front door, press DOOR UP.

The buttons that can be used on the menus are shown on the screen.
You can perform menu operation with these usable buttons.

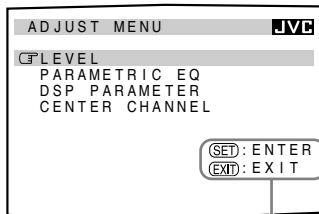

Usable buttons

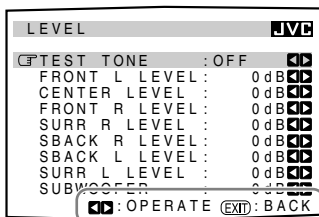

Usable buttons

Operation through On-Screen Display Menus

To make sound adjustments for this receiver, use the remote control so that you can utilize the on-screen display menus in order to finish important adjustments easily while viewing these menus.

Menu operation buttons

From the remote control:

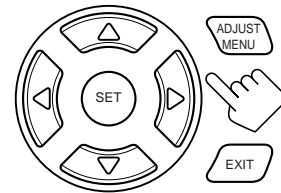

Button	To do
ADJUST MENU	display or erase the Adjustment Menu.
▽ / △	select a submenu item on the Adjustment Menu or on submenus (downwards or upwards).
SET	move to the selected submenu screen.
◁ / ▷	select the desired setting on a submenu.
EXIT	exit from menu operations or return to the previous menu.

- When no operation is done for about 1 minute, the on-screen menu (as well as the indications in the unit's main display) will disappear.

On the front panel:

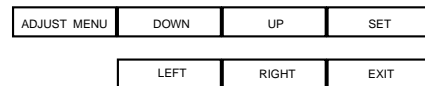







(inside the front door)

Button	To do
ADJUST MENU	display or erase the Adjustment Menu.
DOWN/UP	select a submenu item on the Adjustment Menu or on submenus (downwards or upwards).
SET	move to the selected submenu screen.
LEFT/RIGHT	select the desired setting on a submenu.
EXIT	exit from menu operations or return to the previous menu.

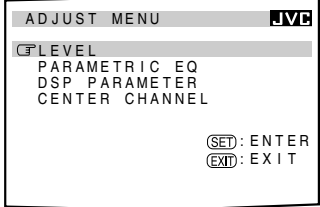
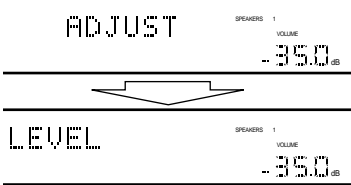
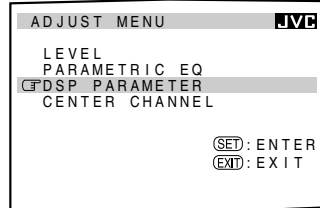
- When no operation is done for about 5 seconds, the indications on the unit's display will disappear.

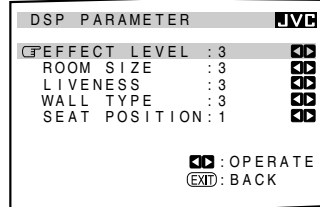
Menu Operating Procedure

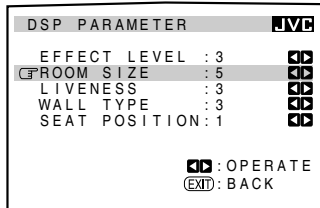
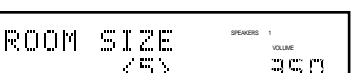
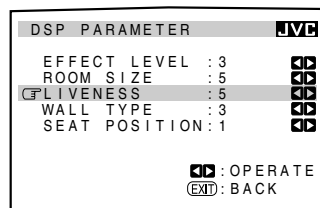
Ex. When adjusting a DSP parameter

Operations	On the TV screen	On the main unit's display
<p>1. Press ADJUST MENU.</p>	 <p>Adjustment Menu appears.</p>	 <p>“ADJUST” appears for 2 seconds*, then one** of the submenu names appears.</p>
<p>2. Press ▾ or ▲ (DOWN or UP) repeatedly to select the desired submenu.</p> <ul style="list-style-type: none"> In this example, select “DSP PARAMETER” submenu. 	<p>Move ↔ to “DSP PARAMETER.”</p> 	<p>Press the button until “DSP” appears.</p> 
<p>3. Press SET.</p> <div data-bbox="119 1041 679 1160" style="border: 1px solid black; padding: 5px; margin-top: 10px;"> <p><i>When adjusting the parametric equalizer:</i> Repeat steps 2 and 3 to select the items on the submenu, and to go to its adjustment screen.</p> </div>	 <p>The selected submenu appears.</p>	 <p>One item** on the selected submenu appears (with the current setting shown on the lower line of the main display).</p>
<p>4. Set a desired item on the submenu.</p> <ol style="list-style-type: none"> Press ▾ or ▲ (DOWN or UP) repeatedly to select an item. Press ▶ or ◀ (RIGHT or LEFT) to set the item. <ul style="list-style-type: none"> In this example, set “ROOM SIZE” to “5.” 		
<p>5. Set other items on the same submenu if necessary.</p> <ol style="list-style-type: none"> Press ▾ or ▲ (DOWN or UP) repeatedly to select another item on the same submenu if necessary. Press ▶ or ◀ (RIGHT or LEFT) to set the item. <ul style="list-style-type: none"> In this example, set “LIVENESS” to “5.” 		

To return to the previous screens

Press EXIT.

Each time you press the button, the on-screen display menu returns to the one previously displayed. (On the unit's main display, the indications also change accordingly.)

To erase the menu (to return to the regular screen)

Press ADJUST MENU.

* “ADJUST” appears only when using the button on the unit.
** When using the buttons on the unit, the last item selected will appear; on the other hand, when using the remote control, the first-listed item on the menu will always appear.

Adjusting the Speaker Channel Output Levels—LEVEL (1)

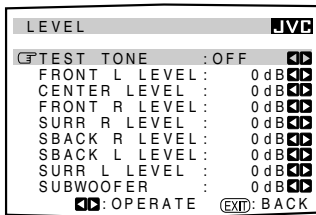

On this submenu, you can adjust the speaker channel output levels. While outputting the test tone, select a speaker channel and adjust its output level. Once adjustment is done on this submenu, it is stored for each source when you change the source or when you turn off the receiver.

Notes:

- The speaker level adjustments except the left/right front level and subwoofer level will be affected and be changed according to the Surround/DSP mode setting.
- You can show this submenu simply by pressing TEST button on the remote control. Test tone comes out of the activated speakers in sequence. (See page 42.)

Adjustment procedure on this submenu

Adjustment is also possible without outputting the test tone. In this case, you can skip steps 1, 2 and 6 below.

- Press ∇ or Δ (DOWN or UP) to select “TEST TONE.”
- Press \triangleright or \triangleleft (RIGHT or LEFT) to output the test tone. (See “Outputting the test tone” below.)
- Press ∇ or Δ (DOWN or UP) to select a speaker you want to adjust.
- Press \triangleright or \triangleleft (RIGHT or LEFT) to adjust the speaker output level.
- Repeat step 3 and 4 to adjust the other speaker output levels.
- After adjustment is finished, stop the test tone.
 - Press Δ or ∇ (UP or DOWN) to select “TEST TONE.”
 - Press \triangleright or \triangleleft (RIGHT or LEFT) to select “OFF.”

Outputting the test tone

CAUTION:

Test tone is automatically fixed to 0 dB, but this level will be louder than you would expect.

Select one of the following.

- Test tone will be heard about three seconds after you select “AUTO” or “MANUAL.”

AUTO : When this is selected, the test tone comes out of all the activated speakers in sequence (for 2 seconds each). The test tone comes out of the activated speakers in the following sequence:

Left front speaker → Center speaker → Right front speaker
 → Right surround speaker → Right surround back speaker
 → Left surround back speaker → Left surround speaker
 → Subwoofer → (Back to the beginning)

MANUAL : When this is selected, the test tone comes out of only the speaker you select. (To select the speaker, see the right column.)

OFF : Select this to stop the test tone.

Notes:

- “TEST TONE” is not available if both speakers 1 and 2 are deactivated or if Surround mode is turned off.
- If “NO” or “NONE” is selected for a speaker on the SPEAKER SETTING submenu (page 29), test tone does not come out of the speaker.

Adjusting the speaker channel output levels

Select and adjust the following speakers:

FRONT L LEVEL : Select this to adjust the left front speaker output level within the range of **-20 dB** to **+10 dB**, and **---** dB (no sound).

FRONT R LEVEL : Select this to adjust the right front speaker output level within the range of **-20 dB** to **+10 dB**, and **---** dB (no sound).

CENTER LEVEL : Select this to adjust the center speaker output level within the range of **-10 dB** to **+10 dB**.

SURR L LEVEL : Select this to adjust the left surround speaker output level within the range of **-10 dB** to **+10 dB**.

SURR R LEVEL : Select this to adjust the right surround speaker output level within the range of **-10 dB** to **+10 dB**.

SBACK L LEVEL : Select this to adjust the left surround back speaker output level within the range of **-10 dB** to **+10 dB**.

SBACK R LEVEL : Select this to adjust the right surround back speaker output level within the range of **-10 dB** to **+10 dB**.

SUBWOOFER : Select this to adjust the subwoofer output level within the range of **-10 dB** to **+10 dB**.

Note:

If “NO” or “NONE” is selected for a speaker on the SPEAKER SETTING submenu (page 29), you cannot adjust its output level.

Adjusting the Parametric Equalizer —PARAMETRIC EQ (2)

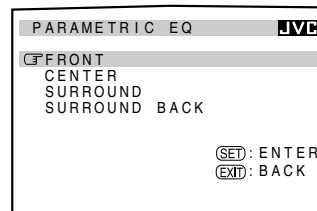

On this submenu, you can adjust equalization patterns according to your preference. First, select the signal channel (speaker) you want to adjust, then move to its adjustment screen.

Notes:

- If “NO” or “NONE” is selected for a speaker on the SPEAKER SETTING submenu (see page 29), you cannot select the corresponding channel.
- If THX Surround or DVD MULTI playback mode is in use, this submenu is not available.

■ Adjustment procedure on this submenu

- 1 Press ∇ or Δ (DOWN or UP) to select the channel—FRONT, CENTER, SURROUND, or SURROUND BACK, then press SET.
The adjustment screen of the selected item appears.
- 2 Press ∇ or Δ (DOWN or UP) to select an item you want to adjust on the selected adjustment screen.
- 3 Press \triangleright or \triangleleft (RIGHT or LEFT) to adjust the item.
 - Once one of the sound levels—“BASS LEVEL,” “MID LEVEL” and “TREBLE LEVEL”—is adjusted, the PARAMETRIC EQ indicator lights up on the display.
- 4 Repeat steps 2 and 3 to adjust the other items on the same adjustment screen.
- 5 Press EXIT once.
The PARAMETRIC EQ submenu appears again.
- 6 Repeat steps 1 to 5 to adjust the other channels.

To cancel the adjustment, set all the sound levels—“BASS LEVEL,” “MID LEVEL” and “TREBLE LEVEL”—to “0 dB.” The PARAMETRIC EQ indicator goes off.

■ Adjustment screen

On these adjustment screens, you can adjust the following items for each channel signal.

PEQ FRONT	
BASS FREQ	: 100Hz
BASS LEVEL	: 0dB
MID FREQ	: 1.0kHz
MID LEVEL	: 0dB
TREBLE FREQ	: 10.0kHz
TREBLE LEVEL	: 0dB

PEQ CENTER	
BASS FREQ	: 100Hz
BASS LEVEL	: 0dB
MID FREQ	: 1.0kHz
MID LEVEL	: 0dB
TREBLE FREQ	: 10.0kHz
TREBLE LEVEL	: 0dB

PEQ SURROUND	
BASS FREQ	: 100Hz
BASS LEVEL	: 0dB
MID FREQ	: 1.0kHz
MID LEVEL	: 0dB
TREBLE FREQ	: 10.0kHz
TREBLE LEVEL	: 0dB

PEQ SURR BACK	
BASS FREQ	: 100Hz
BASS LEVEL	: 0dB
MID FREQ	: 1.0kHz
MID LEVEL	: 0dB
TREBLE FREQ	: 10.0kHz
TREBLE LEVEL	: 0dB

BASS FREQ* : Select the center frequency to adjust bass sounds from
—63 Hz, 80 Hz, **100 Hz** (initial), 125 Hz, 160 Hz, 200 Hz, 250 Hz, 320 Hz, 400 Hz, 500 Hz, 630 Hz, 800 Hz, 1.0 kHz

BASS LEVEL : Adjust the enhancement level for bass sounds (with in the range of **+6 dB** to **-6 dB**).

MID FREQ* : Select the center frequency to adjust middle-range sounds from
—250 Hz, 320 Hz, 400 Hz, 500 Hz, 630 Hz, 800 Hz, **1.0 kHz** (initial), 1.25 kHz, 1.6 kHz, 2.0 kHz, 2.5 kHz, 3.2 kHz, 4.0 kHz

MID LEVEL : Adjust the enhancement level for middle-range sounds (with in the range of **+6 dB** to **-6 dB**).

TREBLE FREQ*: Select the center frequency to adjust treble sounds from—1.0 kHz, 1.25 kHz, 1.6 kHz, 2.0 kHz, 2.5 kHz, 3.2 kHz, 4.0 kHz, 5.0 kHz, 6.3 kHz, 8.0 kHz, **10.0 kHz** (initial), 12.5 kHz, 16.0 kHz

TREBLE LEVEL: Adjust the enhancement level for treble sounds (with in the range of **+6 dB** to **-6 dB**).

■ Adjusting the DSP Parameters —DSP PARAMETER (3)

DSP PARAMETER	
EFFECT LEVEL	: 3
ROOM SIZE	: 3
LIVENESS	: 3
WALL TYPE	: 3
SEAT POSITION	: 1

OPERATE
EXIT: BACK

On this submenu, you can adjust DSP parameters.

- This submenu is available only when the DSP mode* is on, and the settings made apply only to the DSP mode* (*except All Channel Stereo).

Note:

When the front speakers are deactivated, you cannot adjust the DSP parameters.

■ Adjusting the DSP parameters

Select and adjust the following parameters:

EFFECT LEVEL: Adjust the DSP effect level.

As the number increases, the DSP effect becomes stronger. (Normally select “3.” Adjustable range: **1 to 5**)

ROOM SIZE: Adjust the virtual room size. As the number increases, the interval between reflections increases so that you will feel as if you were in a larger room. (Normally select “3.” Adjustable range: **1 to 5**)

LIVENESS: Adjust the liveness effect. As the number increases, the attenuation level of reflections over time decreases so that acoustics change from “Dead” to “Live.” (Normally select “3.” Adjustable range: **1 to 5**)

WALL TYPE: Adjust the wall type. As the number increases, the hardness of the wall to be simulated seems to become “soft” to “hard.” (Normally select “3.” Adjustable range: **1 to 5**)

SEAT POSITION: Select this to either **1** or **2** according to your preference as if you change your seat in a theater, hall, recital hall, church, etc.

■ Adjusting the Center Channel —CENTER CHANNEL (4)

CENTER CHANNEL	
CENTER EQ	: OFF
CENTER ALINMENT	: OFF

OPERATE
EXIT: BACK

On this submenu, you can set center channel signal adjustment for the DSP modes.

- This submenu is available only when the DSP mode* is on, and the settings made apply only to the DSP mode* (*except All Channel Stereo).

■ Cutting off the high frequency range in the center channel

Cut off the high frequency range signals in the center channel.

ON : Select this to cut off the high frequency range signals.

OFF: Select this not to cut off the high frequency range signals.

■ Setting the center channel alignment

Align the vertical localization of the center channel signals (mainly human voices are recorded) at the same height as for the front speakers.

ON : Select this when you cannot feel the actors or singers are not speaking or singing on the screen.

OFF : Center channel alignment is turned off.

* Adjustable range changes according to the other two frequency settings.

Using the Surround Modes

This unit activates a variety of Surround Modes automatically according to the stored basic settings and adjustments performed on the Setup and Adjustment Menus (see pages 26 to 38).

Reproducing Theater Ambience

In a movie theater, many speakers are located on the walls to reproduce impressive multi-surround sounds, reaching you from all directions.

With these many speakers, sound localization and sound movement can be expressed.

Surround modes built in this receiver can create almost the same surround sounds as you can feel in a real movie theater—with only five or seven speakers (plus subwoofer).

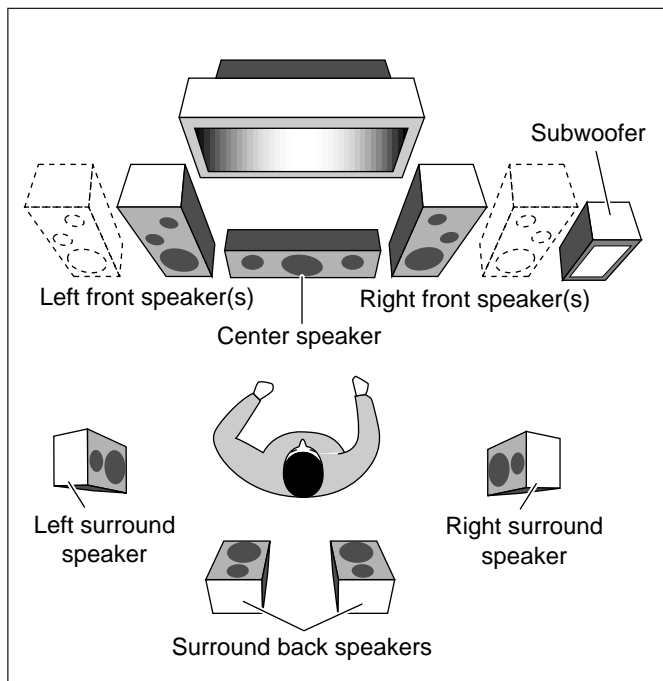
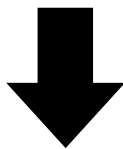
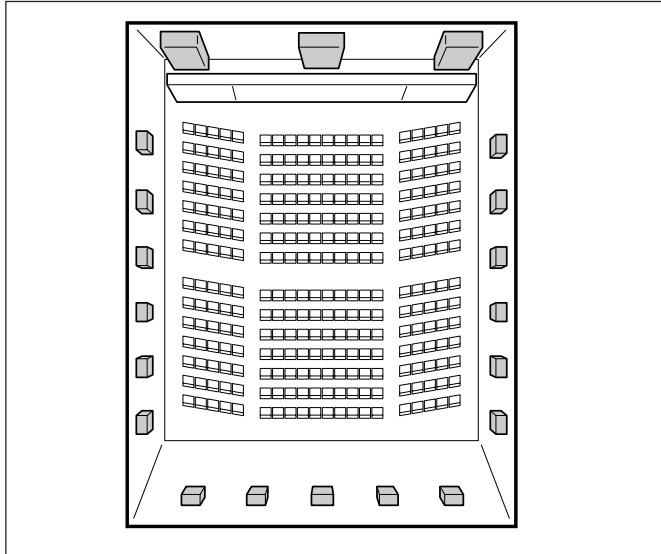

Introducing the Surround Modes

THX Surround EX (Dolby Digital EX)*

Best used to reproduce multichannel sound tracks of the software encoded with Dolby Digital EX.

- To enjoy the software encoded with Dolby Digital EX, connect the source component using the digital terminal on the rear of this receiver. (See page 14.)

Dolby Digital EX is a new digital surround encoding format that adds the third surround channels, called “surround back” (2 channels—but, the same signals are recorded for both left and right surround back channels).

Comparing to the conventional Dolby Digital 5.1CH, these newly added surround back channels can reproduce more detailed movements behind you while viewing the video software. In addition, surround sound localization will become more stable. The **THX Surround EX*** mode built in this receiver decodes Dolby Surround EX encoding, and allows you to enjoy a realistic surround field in your listening room.

Furthermore, this decoder also works for any sound source, applying one of two THX Surround modes—“THX SURR EX” or “THX CINEMA.”

- “THX SURR EX” or “THX CINEMA” is automatically selected when you press THX ON/OFF.

THX SURR EX : To reproduce the sound through all activated speakers. (Best for playing Dolby Digital EX or DTS-ES encoded software)

THX CINEMA : To reproduce the sound through all activated speakers except the surround back speakers.

Dolby Digital 5.1CH*

Used to reproduce multichannel sound tracks of the software encoded with Dolby Digital ().

- To enjoy the software encoded with Dolby Digital, connect the source component using the digital terminal on the rear of this receiver. (See page 14.)

Dolby Digital 5.1CH encoding method (so-called discrete 5.1 channel digital audio format) records and digitally compresses the left front channel, right front channel, center channel, left surround channel, right surround channel, and LFE channel signals (total 6 channels, but LFE channel is counted as 0.1 channel. Therefore, called 5.1 channel).

As each channel is completely independent from the other channel signals to avoid interference, you can obtain a much better sound quality with better stereo and surround effects.

In addition, Dolby Digital enables stereo surround sounds, and sets the cutoff frequency of the surround treble at 20 kHz, compared to 7 kHz for Dolby Pro Logic. As such, the sound movement and “being-there” feeling are enhanced much more than Dolby Pro Logic.

Dolby Surround (Dolby Pro Logic)**

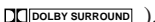
Used to reproduce sound tracks of the software encoded with Dolby Surround ().

Dolby Surround encoding format records the left front channel, right front channel, center channel, and surround channel signals (total 4 channels) into 2 channels.

The **Dolby Pro Logic** decoder built in this receiver decodes these 2 channel signals into 4 original channel signals—matrix-based multichannel reproduction, and allows you to enjoy a realistic surround sound in your listening room.

- When Dolby Pro Logic is activated, the PRO LOGIC indicator lights up on the display.
- Dolby Pro Logic will be activated for all 2 channel software when the Surround mode is turned on. (The PRO LOGIC indicator lights up.)

DTS Surround***

Used to reproduce multichannel sound tracks of the software encoded with DTS Surround ().

- To enjoy the software encoded with DTS Surround, connect the source component using the digital terminal on the rear of this receiver. (See page 14.)

DTS Surround is another discrete 5.1 channel digital audio format available on CD, LD, and DVD software.

Compared to Dolby Digital, the DTS Surround format has a lower audio compression rate which enables it to add breadth and depth to the sounds reproduced. As such, DTS Surround features natural, solid and clear sound.

DTS Extended Surround (DTS-ES)

This is another new digital surround encoding format that adds the third surround channels.

- This unit is compatible with DTS Extended Surround (DTS-ES). You can play back DTS-ES encoded software using THX Surround EX.

Note:

When you select "DVD MULTI" as the source to play, you cannot select the Surround and DSP modes.

3D HEADPHONE Mode

You can also enjoy the surround effect (except THX Surround modes) through the headphones.

By pressing SURROUND ON/OFF when the headphones are connected, 3D HEADPHONE mode is activated without respect to the type of software played back.

The DSP and HEADPHONE indicators also light up.

- Dolby Pro Logic will be activated for all 2-channel software. (The PRO LOGIC indicator lights up.)

DVD MULTI Playback Mode

This receiver provides the DVD MULTI playback mode for reproducing the analog discrete 5.1 channel output mode of the DVD player or other equipment.

You can adjust the DVD MULTI playback mode while playing back a video software such as a DVD using the analog discrete 5.1 channel output mode.

- For the DVD MULTI playback mode connection, see page 13.
- For details on the DVD MULTI playback mode, see page 46.

Surround modes available for input signals

Input Signals	THX ON / SURROUND ON	THX OFF / SURROUND ON	THX OFF / SURROUND OFF
Analog (2 CH)	THX CINEMA	PRO LOGIC	SURROUND OFF
Linear PCM	THX CINEMA	PRO LOGIC	SURROUND OFF
Dolby Digital	THX SURR EX or THX CINEMA* ¹	DOLBY DIGITAL or PRO LOGIC* ²	SURROUND OFF
DTS	THX SURR EX or THX CINEMA* ¹	DTS SURROUND or PRO LOGIC* ³	SURROUND OFF

*¹ Depending on the "THX" setting (see page 31).

*² When 2-channel signal comes in, DOLBY PRO LOGIC will be selected. When other signals come in, DOLBY DIGITAL will be selected.

*³ When 2-channel signal comes in, DOLBY PRO LOGIC will be selected. When other signals come in, DTS SURROUND will be selected.

* Lucasfilm and THX are registered trademarks of Lucasfilm Ltd.

** Manufactured under license from Dolby Laboratories. "Dolby," "Pro Logic," and the double-D symbol are trademarks of Dolby Laboratories. Confidential Unpublished Works. ©1992–1997 Dolby Laboratories, Inc. All rights reserved.

*** Manufactured under license from Digital Theater Systems, Inc. US Pat. No. 5,451,942, 5,956,674, 5,974,380, 5,978,762 and other world-wide patents issued and pending. "DTS," "ES" and "DTS Digital Surround" are trademarks of Digital Theater Systems, Inc. Copyright 1996, 2000 Digital Theater Systems, Inc. All Rights Reserved.

Activating the Surround Modes

Perform the basic settings and adjustments using the Setup and Adjustment Menus first (see pages 26 to 38).

Activating the THX Surround and conventional Surround mode for a source automatically recalls the memorized settings and adjustments done on the above menus.

IMPORTANT:

- **When using the remote control:**
Check the indication shown on the remote's display when you press a button—this indicates the remote control operation mode for a while (10 or 5 seconds).

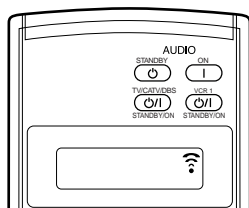

Ex. When you press THX ON/OFF.

- **When using the unit:**
Press DOOR DOWN to use the buttons inside the front door.

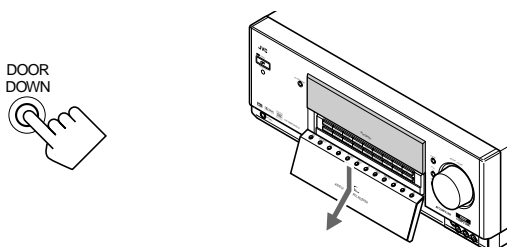

To close the front door, press DOOR UP.

Activating the THX Surround —THX Surround EX/THX Cinema

1. Select and play any sound source.
2. Press THX ON/OFF to activate either “THX SURR EX” or “THX CINEMA.”

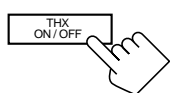

On the unit
(inside the front door)



On the remote control

THX indicator lights up.

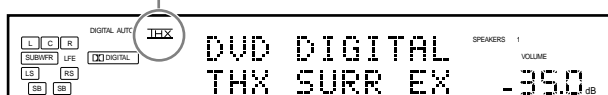

Ex. When “THX SURR EX” (THX Surround EX) is selected.

Notes:

- THX Surround EX or THX Cinema is automatically selected according to the THX submenu setting (see page 31) and to the type of the incoming signals (see page 40).
- Each time you press the button, the THX Surround turns on and off alternately. Conventional surround mode also turns on when the THX Surround is turned on.
- Dolby Pro Logic will be activated for 2-channel software—either digital or analog. (The PRO LOGIC indicator lights up.)

To cancel the THX Surround

Press THX ON/OFF again.

THX Surround is canceled and an appropriate conventional Surround mode—Dolby Digital, DTS Surround, or Dolby Pro Logic—will be selected automatically.

To cancel the conventional Surround mode, press SURROUND ON/OFF.

Activating the Conventional Surround Mode —Dolby Digital/DTS Digital Surround/Dolby Pro Logic

For conventional Surround modes, Parametric Equalizer adjustments done on the PARAMETRIC EQ submenu also take effect for the activated speaker channels. (See page 37).

1. Select and play one of the following sound sources.

- Digital software encoded with 5.1 channel signals —Dolby Digital or DTS Surround.
- Analog software encoded with Dolby Surround.

2. Press SURROUND ON/OFF to activate the conventional Surround mode.



On the unit
(inside the front door)



On the remote control



Ex. When “DOLBY DIGITAL” is selected.

An appropriate Surround mode—DOLBY DIGITAL, DTS SURROUND, or PRO LOGIC—is activated.

Notes:

- Each time you press the button, the Surround mode turns on and off alternately.
- While listening with the headphones, “3D HEADPHONE” will appear. (The DSP and HEADPHONE indicators will light up.)
- Dolby Pro Logic will be activated for 2-channel software—either digital or analog. (The PRO LOGIC indicator lights up.)

To cancel the conventional Surround mode

Press SURROUND ON/OFF again.

Adjusting the Surround Sounds Temporarily

Activating the THX Surround and conventional Surround mode for a source automatically recalls the memorized settings and adjustments done on the Setup and Adjustment Menus.

However, if you want to modify the stored adjustments temporarily only for the current playback source, you can use the TEST button and the number buttons on the remote control.

IMPORTANT:

- **When using the remote control:**
Check the indication shown on the remote's display when you press a button—this indicates the remote control operation mode for a while (10 or 5 seconds).

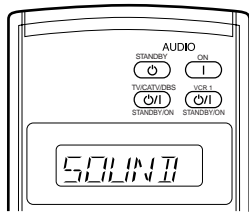

Ex. When you press SOUND.

Before you start, remember...

- Adjustments using the number buttons are temporary and cannot be stored.
When you change the source or turn off the power, the adjustments are erased.
- Make sure that you have set the speaker information correctly (see page 29). You cannot select and adjust the output level of the speaker if the speaker is not activated (set to "NONE" or "NO") on the SPEAKER SETTING submenu.

CAUTION:

Test tone is automatically fixed to 0 dB, but this level will be louder than you would expect.

1. Press SOUND.

The 10 keys are activated for sound adjustments.

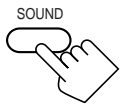

2. Press TEST once to check the speaker output balance.

The test tone comes out of all the activated speakers in the following sequence:

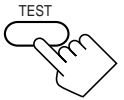

Left front speaker → Center speaker → Right front speaker
→ Right surround speaker → Right surround back speaker
→ Left surround back speaker → Left surround speaker
→ Subwoofer → (Back to the beginning)

Notes:

- The LEVEL submenu (see page 37) appears on the TV screen.
- If "NO" or "NONE" is selected for a speaker on the SPEAKER SETTING submenu (page 29), test tone does not come out of that speaker, and adjustments in the following steps cannot be made.

3. Select the speaker you want to adjust.

The selected speaker name appears on the remote's display for a while.

- To select the left front speaker, press FRONT•L.
- To select the center speaker, press CENTER.
- To select the right front speaker, press FRONT•R.
- To select the right surround speaker, press SURR•R.
- To select the right surround back speaker, press SURR BK•R.
- To select the left surround back speaker, press SURR BK•L.
- To select the left surround speaker, press SURR•L.
- To select the subwoofer, press SUBWFR.



4. Press LEVEL +/- to adjust the speaker output levels.

The speaker name selected in the above step and its level appear on the unit's display.

- You can adjust the levels as follows:
 - Left and right front speakers : -20 dB to +20 dB
 - Other speakers : -10 dB to +10 dB



5. Repeat steps 3 and 4 to adjust the other speaker output levels.

6. Press TEST again to stop the test tone.

Using the DSP Modes

This unit provides a variety of DSP (Digital Signal Processor) Modes.

Reproducing the Sound Field

The sound heard in a concert hall, club, etc. consists of direct sound and indirect sound—early reflections and reflections from behind. Direct sounds reach the listener directly without any reflection. On the other hand, indirect sounds are delayed by the distances of the ceiling and walls. These direct sounds and indirect sounds are the most important elements of the acoustic surround effects. The Surround and DSP modes can create these important elements, and give you a real “being there” feeling.

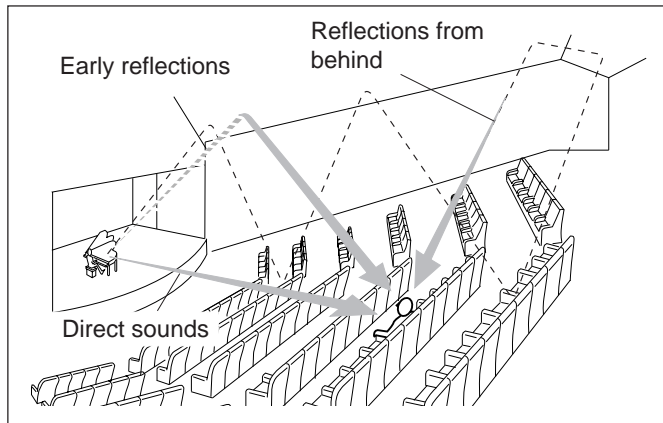

Introducing the DSP Modes

The DSP modes include the following modes—

- DAP (Digital Acoustic Processor) modes (LARGE HALL 1, LARGE HALL 2, RECITAL HALL, OPERA HOUSE, CHURCH, LIVE CLUB, DANCE CLUB, PAVILION, LARGE THEATER, SMALL THEATER)
- ALL CH STEREO
- STEREO FILM/MONO FILM
- 3D THEATER

The following settings you have done are memorized and valid for the DSP modes:

- LEVEL submenu (see page 37)
—Valid only for activated speakers.
- PARAMETRIC EQ submenu (see page 37)
—Valid only for activated speakers.
- DSP PARAMETER submenu (see page 38)
—Valid except for All Channel Stereo.
- CENTER CHANNEL submenu (See page 38)
—Valid only for the center speaker channel when the center speaker is activated. (Not valid for All Channel Stereo.)

To use the DSP modes, press DSP MODE so that the DSP modes change as follows.

→ LARGE HALL 1 → LARGE HALL 2 → RECITAL HALL
→ OPERA HOUSE → CHURCH → LIVE CLUB
→ DANCE CLUB → PAVILION → ALL CH STEREO

→ LARGE THEATER → SMALL THEATER
→ STEREO FILM → MONO FILM → 3D THEATER
→ SURROUND OFF (DSP off) → (Back to the beginning)

- : Suitable for audio sources
□ : Suitable for video sources

DAP modes

You can use the following DAP modes in order to reproduce a more acoustic sound field in your listening room.

LARGE HALL 1 : Reproduces the spatial feeling of a large shoebox-shaped hall designated primarily for classical concerts. (Its seating capacity is about 2000.)

LARGE HALL 2 : Reproduces the spatial feeling of a large vineyards-shaped hall designated primarily for classical concerts. (Its seating capacity is about 2000.)

RECITAL HALL : Reproduces the spatial feeling of a small hall designated primarily for classical recitals. (Seating capacity is about 500.)

OPERA HOUSE : Reproduces the spatial feeling of an opera house with a high ceiling and multi-level seating layout.

CHURCH : Reproduces the spatial feeling of a majestic church with a high ceiling.

LIVE CLUB : Reproduces the spatial feeling of a live music club with a low ceiling.

DANCE CLUB : Reproduces the spatial feeling of a rocking dance club.

PAVILION : Reproduces the spatial feeling of an exhibition hall with a high ceiling.

LARGE THEATER : Reproduces the spatial feeling of a large theater where the seating capacity is about 600. The built-in Dolby Pro Logic decoder is activated. (The PRO LOGIC indicator lights up.)

SMALL THEATER : Reproduces the spatial feeling of a small theater where the seating capacity is about 300. The built-in Dolby Pro Logic decoder is activate. (The PRO LOGIC indicator lights up.)

When using the DAP mode, the sounds come out of all the connected and activated speakers.

- If only front speakers are connected, JVC's original 3D-PHONIC processing (which has been developed to create the surround effect only through the front speakers) is used. The 3D-PHONIC indicator lights up on the display.

ALL Channel Stereo mode (ALL CH STEREO)

This mode can reproduce a larger stereo sound field using all the connected (and activated) speakers. **This mode cannot be used without connecting the surround speakers.**

- The CENTER CHANNEL submenu settings and the DSP PARAMETER submenu settings cannot be applied to All Channel Stereo mode. (You cannot adjust them for this mode.)
- **If headphones are connected or if the front speakers are deactivated**, "ALL CH STEREO" cannot be selected (see "HEADPHONE mode" below).

Stereo Film and Monaural Film modes

In order to reproduce a more acoustic sound field in your listening room while viewing stereo sound or monaural sound video software (analog and 2-channel digital signals), you can use these modes. The surround effect will be added, and the sound localization of actor's words will be improved.

STEREO FILM : To play back stereo video software

MONO FILM : To play back monaural video software

When "STEREO FILM" or "MONO FILM" is used, sounds come out of all the connected (and activated) speakers.

3D THEATER

Only using the front speakers, this mode gives you such a true and clear surround effect only as is reproduced through the Dolby Surround decoder, which is widely used to reproduce sounds with a feeling of movement like those experienced in movie theaters.

- When "3D THEATER" is used, the DSP and 3D-PHONIC indicators light up. The PRO LOGIC indicator also lights up when 2-channel software is played back. (Dolby Pro Logic decoder is activated.)
- **If the center speaker is connected (and activated):** Sounds created by the built-in DSP (Digital Signal Processor) come out of the center speaker to localize the sounds. So, you can feel as if actors on the screen actually speak in your room.
- **If headphones are connected**, "3D HEADPHONE" will be activated. (See "3D HEADPHONE Mode" on page 40.)

HEADPHONE Mode

You can also enjoy the DSP effect (except All Channel Stereo mode) through the headphones.

By pressing DSP MODE when the headphones are connected, HEADPHONE mode is activated without respect to the type of software played back.

The DSP and HEADPHONE indicators also light up.

Activating the DSP Modes

Perform the basic settings and adjustments using the Setup and Adjustment Menus first (see pages 26 to 38).

Activating one of the DSP modes for a source automatically recalls the memorized settings and adjustments done on the above menus.

IMPORTANT:

• When using the remote control:

Check the indication shown on the remote's display when you press a button—this indicates the remote control operation mode for a while (10 or 5 seconds).

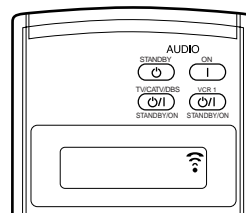

Ex. When you press DSP MODE.

• When using the unit:

Press DOOR DOWN to use the buttons inside the front door.

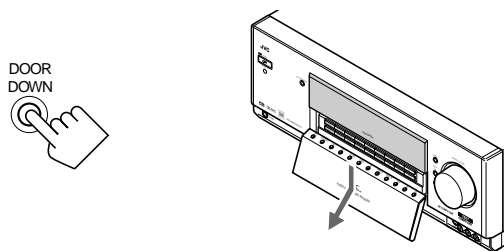

To close the front door, press DOOR UP.

1. Select and play any sound source.

2. Press DSP MODE repeatedly until the DSP mode you want appears on the display.

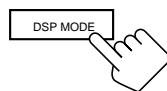

On the unit
(inside the front door)

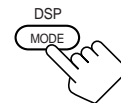

On the remote control

The DSP indicator also lights up on the display.

- Each time you press the button, the DSP modes change as follows:

→ LARGE HALL 1 → LARGE HALL 2 → RECITAL HALL
→ OPERA HOUSE → CHURCH → LIVE CLUB
→ DANCE CLUB → PAVILION → ALL CH STEREO*
→ LARGE THEATER → SMALL THEATER
→ STEREO FILM* → MONO FILM* → 3D THEATER
→ SURROUND OFF (DSP off) → (Back to the beginning)

* When multichannel signals come in, you cannot select "STEREO FILM" and "MONO FILM."

Continued on the next page.

Notes:

- When the surround speakers are deactivated, the 3D-PHONIC processing is applied to the DSP modes (the 3D-PHONIC indicator also lights up).
- If "USER MODE 1" (then "NO DATA") appears, press and hold DSP MODE on the unit until it disappears. (This mode is only for service personnel.)

To cancel the DSP modes

Press DSP MODE repeatedly until "SURROUND OFF" appears on the display.

- When a pair of headphones is connected or when the front speakers are deactivated, "HEADPHONE" will appear.

If you want to modify the stored sound adjustments temporarily

See "Adjusting the Surround Sounds Temporarily" on page 42.

- When adjusting the surround sounds for the DSP modes, you cannot output the test tone.
- When you select "3D THEATER," you cannot adjust the surround speaker levels and surround back speaker levels.

Adjusting the DSP Parameters Temporarily

Activating the DSP mode for a source automatically recalls the memorized DSP parameter settings done on the Adjustment Menu.

However, if you want to modify the stored adjustments temporarily only for the current playback source, you can use the number buttons on the remote control.

IMPORTANT:

Check to see if the following before or while using the buttons and controls.

- **When using the remote control:**
Check the indication shown on the remote's display when you press a button—this indicates the remote control operation mode for a while (10 or 5 seconds).

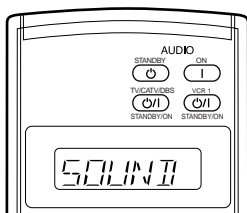

Ex. When you press SOUND.

Before you start, remember...

- Adjustments using the number buttons are temporary and cannot be stored.
When you change the source or turn off the power, the adjustments are erased.
- When you select "ALL CH STEREO," you cannot adjust the DSP parameters.

1. Press SOUND.

The 10 keys are activated for sound adjustments.

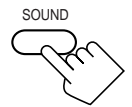

2. Press EFFECT to adjust the overall level of the effect.

- Each time you press the button, the effect level changes as follows:

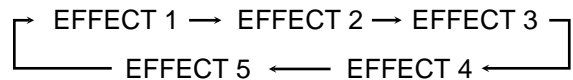

As the number increases, the selected DSP effect becomes stronger. (Normally set it to "EFFECT 3.")

3. Press ROOM SIZE to adjust the room size (sense of spaciousness).

- Each time you press the button, the display changes to show the following:

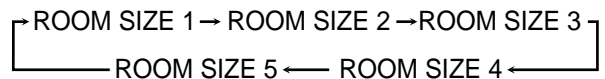

As the number increases, the interval between reflections increases so that you will feel as if you were in a larger room. (Normally set it to "ROOM SIZE 3.")

4. Press LIVENESS to adjust the liveness.

- Each time you press the button, the display changes to show the following:

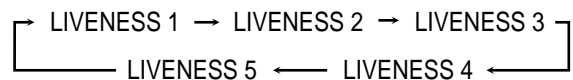

As the number increases, the attenuation level of reflections over time decreases so that acoustics change from "Dead" to "Live." (Normally set it to "LIVENESS 3.")

5. Press WALL to adjust the wall type.

- Each time you press the button, the display changes to show the following:

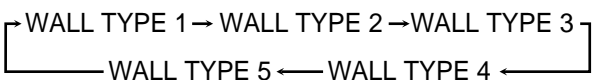
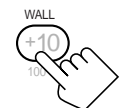

As the number increases, the hardness of the wall to be simulated changes from "Soft" to "Hard." (Normally set it to "WALL TYPE 3.")

Notes:

- You cannot adjust "SEAT POSITION" using the number buttons. If you want to adjust it, see page 38.
- When the front speakers are deactivated, you cannot adjust the DSP parameters.

Using the DVD MULTI Playback Mode

This receiver provides the DVD MULTI playback mode for reproducing the analog discrete output mode of the DVD player. Before playing back a DVD, refer also to the manual supplied for the DVD player.

Activating the DVD MULTI Playback Mode

Perform the basic settings and adjustments using the Setup and Adjustment Menus first (see pages 26 to 38).

Activating DVD MULTI playback mode automatically recalls the memorized settings and adjustments done on the above menus.

- You also need to set the DVD player to the analog discrete output mode.

IMPORTANT:

- **When using the remote control:**
Check the indication shown on the remote's display when you press a button—this indicates the remote control operation mode for a while (10 or 5 seconds).

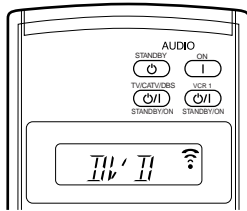

Ex. When you press DVD MULTI.

- **When using the unit:**
Press DOOR DOWN to use the buttons inside the front door.

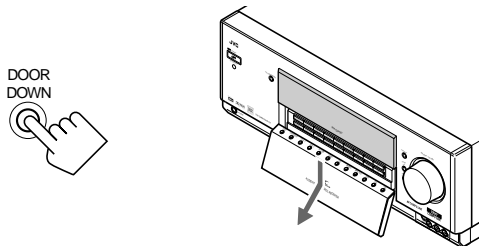

To close the front door, press DOOR UP.

Before you start, remember...

Make sure that you have connected the DVD player to the analog discrete input (5.1 CH reproduction) jacks on the rear (see page 13).

1. Press DVD MULTI so that “DVD MULTI” appears on the display.



On the unit
(inside the front door)



On the remote control

Note:

When you select “DVD MULTI” as the source to play, the THX ON/OFF, SURROUND ON/OFF and DSP MODE buttons do not work.

2. Select the analog discrete output mode on the DVD player, and start playing a DVD.

- Refer to the manual supplied with the DVD player.

If you want to modify the stored sound adjustments temporarily

See “Adjusting the Surround Sounds Temporarily” on page 42.

- When adjusting the sounds for the DVD MULTI playback mode, you cannot output the test tone.
- If “L/R” is selected on the SURROUND SPEAKERS submenu (see page 31), you cannot adjust the output levels of the surround back speakers.

COMPU LINK Remote Control System

The COMPU LINK remote control system allows you to operate JVC audio components through the remote sensor on the receiver.

To use this remote control system, you need to connect JVC audio components through the COMPU LINK (SYNCHRO) jacks (see below) in addition to the connections using cables with RCA pin plugs (see page 10).

- Make sure that the AC power cords of these components are unplugged before connection. Plug the AC power cords only after all connections are complete.

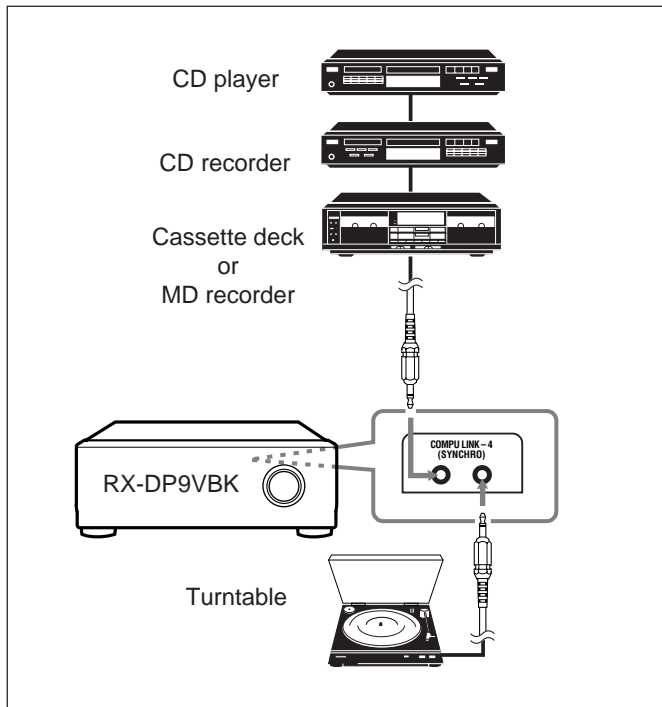

Notes:

- There are four versions of COMPU LINK remote control system. This receiver is equipped with the fourth version — COMPU LINK-4. This version is added systematic operations with the CD recorder to the previous version — COMPU LINK-3.
- If your audio component has two COMPU LINK jacks, you can use either one. If it has only one COMPU LINK jack, connect it so that it is the last item in the series of components. (For example, the turntable or CD player in the diagram above.)
- To operate the cassette deck or MD recorder using the COMPU LINK remote control system, set the source name correctly. (See page 22.)
- Refer also to the manuals supplied with your audio components.

This remote control system allows you to use four functions listed below.

Remote Control through the Remote Sensor on the Receiver

You can control the connected audio components through the remote sensor on the receiver using this remote control. Aim the remote control directly at the remote sensor on the receiver. For details, see pages 55 and 56.

Automatic Source Selection

When you press the play (▶) button on a connected component or on its own remote control, the receiver automatically turns on and changes the source to the component. On the other hand, if you select a new source on the receiver or on the remote control, the selected component begins playing immediately.

In both cases, the previously selected source continues playing without sound for a few seconds.

Note:

If the source changes from an analog source, for which Line Direct (see page 21) is activated, to a digital source, muting time* will be a little longer.

* The period during which the receiver changes the source mechanically. No sound comes out during this period.

Automatic Power On/Off (Standby): only possible with the COMPU LINK-3 and COMPU LINK-4 connection

The connected components turn on and off (standby) along with the receiver.

When you turn on the receiver, one of the connected components will turn on automatically, depending on which component has been previously selected.

When you turn off the receiver, the connected components will turn off (standby).

Synchronized Recording

Synchronized recording means the cassette deck (or MD recorder) starts recording as soon as a CD begins playing.

To use synchronized recording, follow these steps:

1. Put a tape in the cassette deck (or an MD in the MD recorder), and a disc in the CD player.
2. Press the record (●) button and the pause (II) button on the cassette deck (or MD recorder) at the same time.
This puts the cassette deck (or MD recorder) into recording pause.
If you do not press the record (●) button and pause (II) button at the same time, the synchronized recording feature will not operate.
3. Press the play (▶) button on the CD player.

The source changes on the receiver, and as soon as play starts, the cassette deck (or MD recorder) starts recording. When the play ends, the cassette deck (or MD recorder) enters recording pause, and stops about 4 seconds later.

Notes:

- During synchronized recording, the selected source cannot be changed.
- If the power of any component is shut off during synchronized recording, the COMPU LINK remote control system may not operate properly. In this case, you must start again from the beginning.

TEXT COMPU LINK Remote Control System

The TEXT COMPU LINK remote control system has been developed to deal with the disc information recorded in the CD Text* and MDs. Using this information in the discs, you can operate the CD player or MD recorder with the TEXT COMPU LINK remote control system through the receiver.

CONNECTIONS:

To use this remote control system, you need to connect the CD player and/or MD recorder you want to operate, following the procedures below.

1. If you have already plugged your CD player, MD recorder, and this receiver into the AC outlets, unplug their AC power cords first.
2. Connect your CD player, MD recorder, and this receiver as follows, through the COMPU LINK jacks and TEXT COMPU LINK jacks.

- 1) **COMPU LINK jacks:** Use the cables with the monaural mini-plugs (not supplied with this receiver).

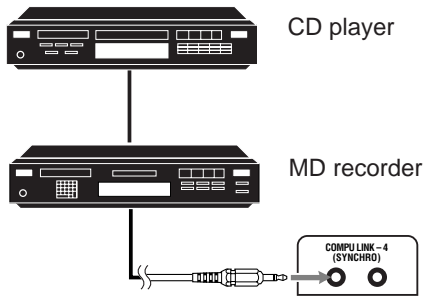

- 2) **TEXT COMPU LINK jacks:** Use the cables with the stereo mini-plugs (not supplied with this receiver).

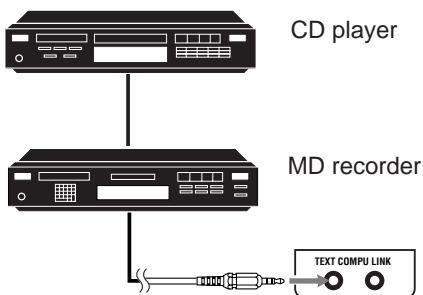

3. Connect your CD player, MD recorder and this receiver, using the cables with RCA pin plugs (see page 10).
4. Plug the AC power cords of these components above into the AC outlets.
5. When turning on these components for the first time, turn on the connected components first, then turn on this receiver.

FUNCTIONS:

This remote control system allows you to use the functions listed below.

Displaying the Disc Information on the TV screen

Disc information such as its performer and disc title (and track titles only when a CD Text is selected) is shown on the TV screen.

Disc Search: Only for CD Player

This remote control system can allow you to search for discs by the performer, disc title, and music genre.

With this disc search, you can easily find the disc you want to play.

Disc Title Input:

If your CD player or MD recorder has the disc memory function, you can input the following information about the normal audio CDs or MDs on the TV screen.

- For CDs: Performer, disc title, and music genre
- For MDs: Disc title and song titles

*What is a CD Text?

In a CD Text, some information about the disc (its disc title, performer, composer, arranger, etc.) is recorded.

Notes:

- If your audio component has two COMPU LINK jacks, you can use either one. If it has only one COMPU LINK jack, connect it so that it is the last item in the series of components. (For example, the CD player in the diagram on the left column.)
- If your audio component has two TEXT COMPU LINK jacks, you can use either one. If it has only one TEXT COMPU LINK jack, connect it so that it is the last item in the series of components. (For example, the CD player in the diagram on the left column.)
- "TEXT COMPULINK SOURCE NOT CONNECTED" appears on the display in the following cases:
 - When the connections explained on the left are not correctly done.
 - When you try to use the TEXT COMPULINK function a few seconds after you turn on the connected equipment. This is not a malfunction of the units.
- Refer also to the manuals supplied with your CD player or MD recorder.

IMPORTANT:

If you turn on the receiver before turning on the other components after connecting the components, the TEXT COMPU LINK remote control system does not work correctly.

If this happens:

1. Turn off all the components including this receiver.
2. Turn on the connected components.
3. Turn on this receiver.

OPERATIONS:

To use this remote control system, you need to connect the TV to the MONITOR OUT jack (see page 12), and set the TV's input mode to the proper position to which the receiver is connected.

Make sure you have connected the CD player or MD recorder equipped with the TEXT COMPU LINK remote control system. If not, you cannot use the following functions.

IMPORTANT:

- **When using the remote control:**
Check the indication shown on the remote's display when you press a button—this indicates the remote control operation mode for a while (10 or 5 seconds).

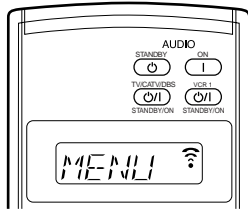

Ex. When you press TEXT DISPLAY.

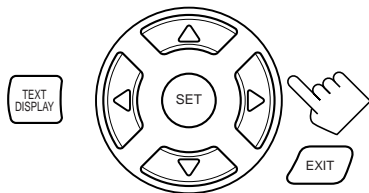

Text display operation buttons

Showing the Disc Information on the TV Screen

Press **TEXT DISPLAY** while “CD” or “MD” is selected as the source.

The Disc Information screen appears on the TV.

Disc Information screen

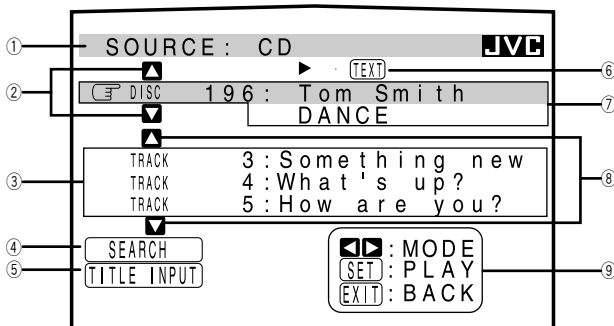

- ① Source name: CD or MD
- ② Select or , then press SET to change the disc.
- ③ Track numbers and track titles.
 - When you move to a track number, you can change the track information by pressing / . Each time you press the button, track information alternates between its track title and its performer. (You can also start playing the track by pressing SET.)
- ④ Select this (move in front), then press SET to go to the DISC SEARCH screen (see page 50).
- ⑤ Select this (move in front), then press SET to go to the TITLE INPUT screen (see page 51).
- ⑥ This appears only when a CD Text is selected.
- ⑦ Disc information such as the disc title, performer, music genre, etc.
When this is selected (in front), you can change the disc information by pressing / . Each time you press the button, disc information (see “Note on ⑦”) changes.
- ⑧ Select or , then press SET to change the track.
- ⑨ Usable buttons and their functions for the current selection.
Indication here will be changed according to what is currently selected (in front) on the screen. See “Note on ⑨.”

Note on ⑦:

The following information will appear on the display:

- For CD Texts — Disc title, Performer, Genre, Song writer, Composer, Arranger, Message
Only recorded information will be shown. If there is no data, “NO DATA” will appear.
- For MDs — Disc title
If there is no data, “NO DATA” will appear.

Note on ⑨:

For example, the SET button will be used to start play (PLAY), to go to the next screen (ENTER), and to determine the selection (ENTER).

To exit from the Disc information screen:

Press EXIT.

Notes:

- The on-screen display will disappear in the following cases:
 - if no operation is done for about 10 minutes.
 - if you do any operation other than explained in this section.
- To control the MD recorder using the TEXT COMPU LINK remote control system, you have to change the source name shown on the display from “TAPE” to “MD.” (See page 22.)
- Some special characters and marks cannot be displayed correctly.

■ Searching for a Disc (Only for the CD player)

Search for a disc by its performer:

1. Press TEXT DISPLAY while “CD” is selected as the source.

The Disc Information screen appears on the TV.

2. Press Δ / ∇ to move \leftarrow to “SEARCH,” then press SET.

The DISC SEARCH screen appears.

3. Press Δ / ∇ to move \leftarrow to “PERFORMER,” then press SET.

The PERFORMER SEARCH screen appears.

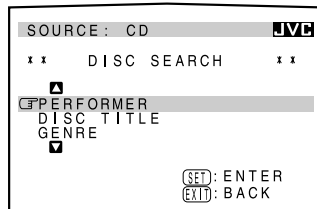

4. Press $\Delta / \nabla / \triangleleft / \triangleright$ to move \leftarrow in front of the first character of the performer you want to search for, then press SET.

To correct the incorrect entry, press $\Delta / \nabla / \triangleleft / \triangleright$ to move \leftarrow in front of the correct character, then press SET.

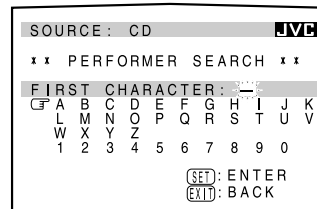

Note:

Symbols such as @, # or \$ are not available for search.

5. Press SET again.

Disc search starts, then the SEARCH RESULT screen, showing the performers, appears.

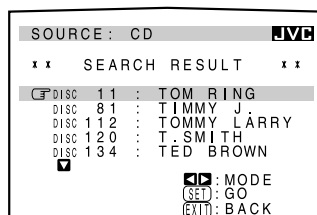

6. On the SEARCH RESULT screen, you can do the following:

- **Changing the indication of the disc information:** Press Δ / ∇ to move \leftarrow to a searched for disc, then press $\triangleleft / \triangleright$. Each time you press $\triangleleft / \triangleright$, the disc information alternates between its performer and its disc title.
- **Starting a disc play and going to the Disc Information screen (see page 49):** Press Δ / ∇ to move \leftarrow to a searched for disc, then press SET.
- **Showing unseen disc information (if more than 5 discs are listed as a result of the search):** Press Δ / ∇ until they appear.
- **Going back to the PERFORMER SEARCH screen:** Press EXIT.

Search for a disc by its disc title:

1. Press TEXT DISPLAY while “CD” is selected as the source.

The Disc Information screen appears on the TV.

2. Press Δ / ∇ to move \leftarrow to “SEARCH,” then press SET.

The DISC SEARCH screen appears.

3. Press Δ / ∇ to move \leftarrow to “DISC TITLE,” then press SET.

The DISC TITLE SEARCH screen appears.

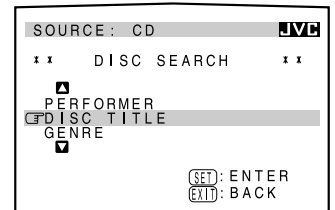

4. Press $\Delta / \nabla / \triangleleft / \triangleright$ to move \leftarrow in front of the first character of the disc title you want to search for, then press SET.

To correct the incorrect entry, press $\Delta / \nabla / \triangleleft / \triangleright$ to move \leftarrow in front of the correct character, then press SET.

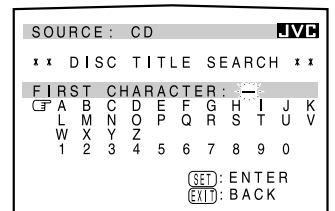

Note:

Symbols such as @, # or \$ are not available for search.

5. Press SET again.

Disc search starts, then the SEARCH RESULT screen, showing the disc titles, appears.

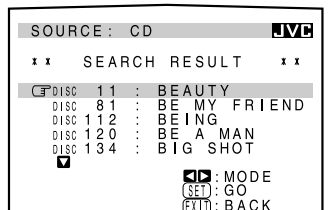

6. On the SEARCH RESULT screen, you can do the following:

- **Changing the indication of the disc information:** Press Δ / ∇ to move \leftarrow to a searched for disc, then press $\triangleleft / \triangleright$. Each time you press $\triangleleft / \triangleright$, the disc information alternates between its disc title and its performer.
- **Starting a disc play and going to the Disc Information screen (see page 49):** Press Δ / ∇ to move \leftarrow to a searched for disc, then press SET.
- **Showing unseen disc information (if more than 5 discs are listed as a result of the search):** Press Δ / ∇ until they appear.
- **Going back to the DISC TITLE SEARCH screen:** Press EXIT.

Search for a disc by its genre:

1. Press TEXT DISPLAY while "CD" is selected as the source.

The Disc Information screen appears on the TV.

2. Press Δ / ∇ to move C to "SEARCH," then press SET.

The DISC SEARCH screen appears.

3. Press Δ / ∇ to move C to "GENRE," then press SET.

The GENRE SEARCH screen appears.

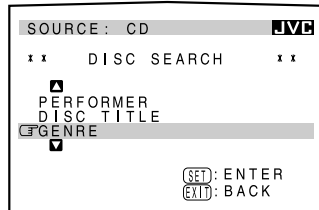

4. Press Δ / ∇ to move C to the genre you want to search for, then press SET.

To show the unseen genres, press Δ / ∇ until they appear.

Disc search starts, then the SEARCH RESULT screen, showing the disc titles, appears.

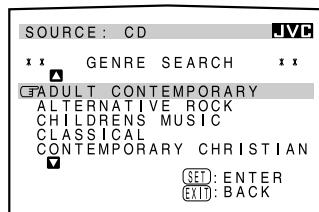

5. On the SEARCH RESULT screen, you can do the following:

- **Changing the indication of the disc information:**

Press Δ / ∇ to move C to a searched for disc, then

press $\triangleleft / \triangleright$. Each time you press $\triangleleft / \triangleright$, the disc information alternates between its disc title and its performer.

- **Starting a disc play and going to the Disc Information screen (see page 49):** Press Δ / ∇ to move C to a searched for disc, then press SET.

- **Showing unseen disc information (if more than 5 discs are listed as a result of the search):** Press Δ / ∇ until they appear.

- **Going back to the GENRE SEARCH screen:** Press EXIT.

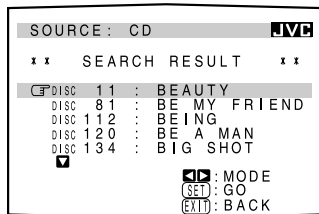

Entering the Disc Information

For the CD Player with the disc memory function:

You can use the disc memory function through this receiver.

The disc information (its performer, disc title, and music genre) of normal audio CDs will be stored into the memory built in the CD player.

For the disc memory function, refer to the manual supplied with your CD player.

- The performer, disc title, and music genre information are usually recorded on a CD Text. However, if a CD Text has no genre information recorded on the disc itself, you can input its music genre by yourself.

Note:

You can enter the TITLE INPUT screens for a CD Text and input its titles. However, you cannot store the titles you have input for a CD Text.

Example: Entering the following information for Disc 1

Performer: "MICHAEL"

Disc title: "MY FAVORITE"

1. Press TEXT DISPLAY while "CD" is selected as the source.

The Disc Information screen appears on the TV.

2. Press Δ / ∇ to move C to "TITLE INPUT," then press SET.

The TITLE INPUT:

PERFORMER screen appears.

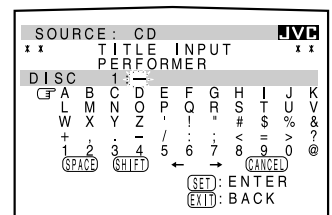

3. Press $\Delta / \nabla / \triangleleft / \triangleright$ to move C in front of a character you want, then press SET to enter the character.

- If the current CD is a CD Text, go to step 5 without entering the performer.

To use the lower-case letters, press $\Delta / \nabla / \triangleleft / \triangleright$ to move C to SHIFT , then press SET.

To use the upper-case letters again, press $\Delta / \nabla / \triangleleft / \triangleright$ to move C to SHIFT , then press SET.

4. Repeat step 3 until you finish putting a performer name (up to 32 characters).

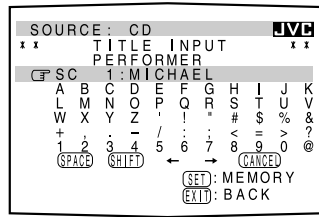

To insert a space, press $\Delta / \nabla / \triangleleft / \triangleright$ to move C to SPACE , then press SET.

To correct an incorrect character:

- 1) Press $\Delta / \nabla / \triangleleft / \triangleright$ to move C to \leftarrow or \rightarrow , then press SET until the incorrect character is selected.
- 2) Press $\Delta / \nabla / \triangleleft / \triangleright$ to move C to CANCEL , then press SET to erase the character.
- 3) Press $\Delta / \nabla / \triangleleft / \triangleright$ to move C in front of the correct character, then press SET to enter the correct character.

5. Press $\Delta / \nabla / \triangleleft / \triangleright$ to move C to "DISC 1: MICHAEL (in this example)," then press SET.

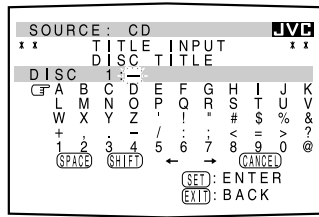

The TITLE INPUT: DISC TITLE screen appears.

6. Enter the disc title, referring to steps 3 and 4.

- If the current CD is a CD Text, go to the next step without entering the disc title.

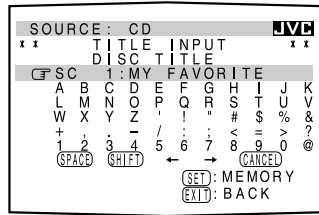

7. Press $\Delta / \nabla / \triangleleft / \triangleright$ to move C to "DISC 1: MY FAVORITE (in this example)," then press SET.

The TITLE INPUT: DISC 1 GENRE screen appears.

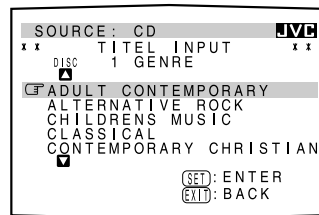

8. Press Δ / ∇ to move C to the genre you want, then press SET.

The Disc Information screen appears again.

To show the unseen genres, press Δ / ∇ until they appear.

For the MD recorder:

You can write the disc information (disc title and song titles) into the disc. You can only write the song title for the song currently selected.

- If you have the CD-MD combination deck, you can also enter the disc information (its performer, disc title, and its music genre) of normal audio CDs into the memory built in the CD-MD combination deck. (To do this, follow the procedure of "For the CD Player with the disc memory function" on page 51.)
- If you change the disc or song title including more than 32 characters, the characters following 32nd will be erased from the title.

1. Press TEXT DISPLAY while "MD" is selected as the source.

The Disc Information screen appears on the TV.

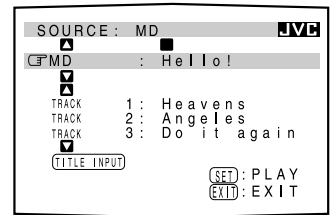

2. Press Δ / ∇ to move C to "TITLE INPUT," then press SET.

The DISC TITLE INPUT screen appears.

3. Enter the title, referring to steps 3 and 4 of "For the CD Player with the disc memory function" on pages 51 and 52.

- You can enter up to 32 characters for the disc title.

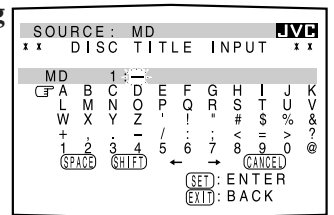

4. Press $\Delta / \nabla / \triangleleft / \triangleright$ to move C to the disc title you have just entered, then press SET.

The disc title is stored into the memory, and the SONG TITLE INPUT screen for the currently selected song appears.

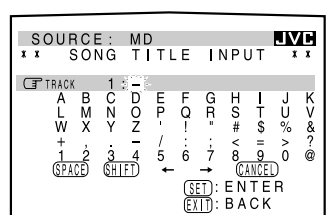

- You can enter a song title for the song currently selected.

5. Enter the song title, referring to steps 3 and 4 of "For the CD Player with the disc memory function" on pages 51 and 52.

- You can enter up to 32 characters for the song title.

6. Press $\Delta / \nabla / \triangleleft / \triangleright$ to move C to the song title you have just entered, then press SET.

The song title is stored into the memory, and the Disc Information screen appears again.

AV COMPU LINK Remote Control System

The AV COMPU LINK remote control system allows you to operate JVC video components (TV, VCR, and DVD player) through the receiver.

This receiver is equipped with the AV COMPU LINK-III, which added a function to operate JVC video components through the video components terminals. To use this remote control system, you need to connect the video components you want to operate, following the diagrams below and the procedure on the next page.

- Refer also to the manuals supplied with your video components.

CONNECTIONS 1: AV COMPU LINK Connection

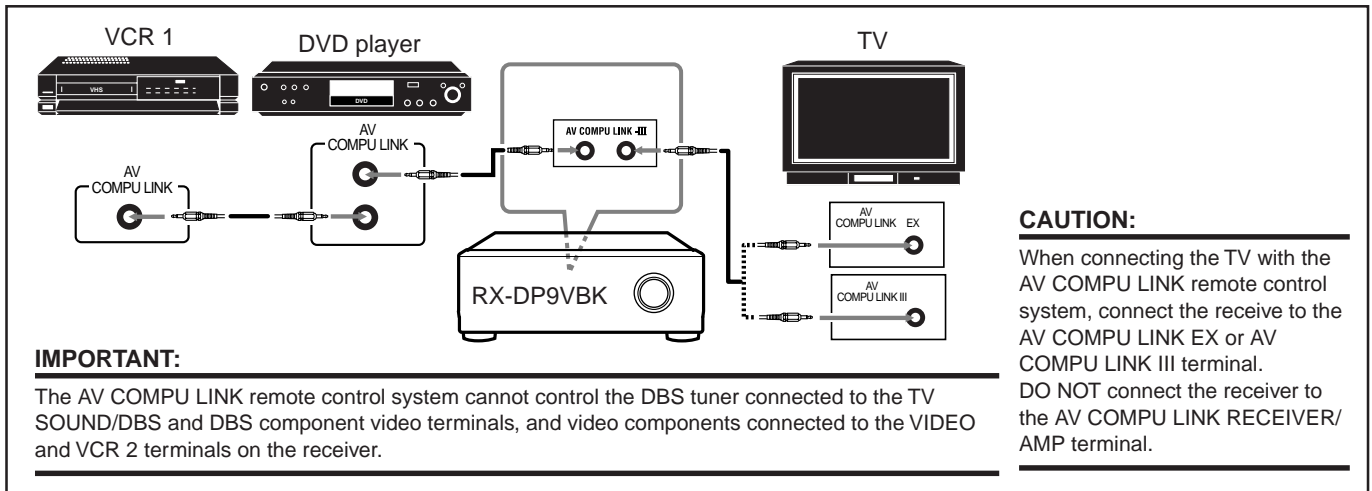

Notes:

- When connecting the receiver and a TV with the AV COMPU LINK EX terminal by using a component video cable, you cannot use Automatic Selection of TV's Input Mode (see page 54).
- When connecting the VCR 1 or DVD player only to this receiver, connect it directly to the receiver using cables with the monaural mini-plugs.

CONNECTIONS 2: Video Cable Connection

This receiver is equipped with three types of the video terminals — S-video, composite video, or component video, and the signals coming into this receiver through one type of video terminals can output only through the terminal of the same type. So you need to connect the VCR and/or DVD player to the TV using one of the following three ways:

- **When using the AV COMPULINK remote control system, set the component video input correctly** (see "Preparing for the Component Video Input—COMPONENT IN" on page 32); otherwise, the correct input for this receiver will not be selected on the TV.

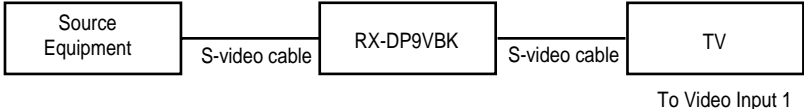
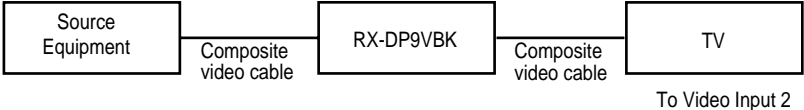
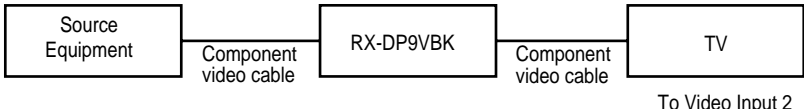
CASE 1	<p>When connecting the source equipment to the receiver through the S-video terminals, connect this receiver to the TV's Video Input 1 terminal using S-video cables.</p> 
CASE 2	<p>When connecting the source equipment to the receiver through the composite video terminals, connect this receiver to the TV's Video Input 2 terminal (composite video input) using composite video cables.</p> 
CASE 3	<p>When connecting the source equipment to the receiver through the component video terminals, connect this receiver to the TV's Video Input 2 terminals (component video input) using component video cables.</p> 

1. **If you have already plugged your VCR 1 (VCR connected to the VCR 1 jacks), DVD player, TV and this receiver into the AC outlets, unplug their AC power cords first.**
2. **Connect your VCR 1, DVD player, TV and this receiver as follows, using the cables with the monaural mini-plugs (not supplied).**
 - See “CONNECTIONS 1” on the previous page.
3. **Connect the audio input/output jacks on VCR 1, DVD player, TV and this receiver using the cables with RCA pin plug.**
 - See pages 11 to 13.
4. **Connect the video input/output jacks on VCR 1, DVD player, TV and this receiver, using the cables with RCA pin plug, with S-video plug or with component video plugs.**
 - See “CONNECTIONS 2” on the previous page.
5. **Plug the AC power cords of the components into the AC outlets.**
6. **When turning on the TV for the first time after the AV COMPU LINK connection, turn the TV volume to the minimum using the TV volume control on the TV.**
7. **Turn on the other connected components first, then turn on this receiver.**
 - When turning on the VCR 1, use the remote control supplied with this receiver—press VCR  (STNADBY/ON) .

The AV COMPU LINK remote control system allows you to use the five basic functions listed below.

Remote Control of the TV, DVD player, and VCR Using This Remote Control

See page 57 for details.

- Aim the remote control directly at **the remote sensor on each target component.**

One-Touch Video Play

Simply by inserting a video cassette without its safety tab into the VCR 1 (the VCR connected to the VCR 1 jacks), you can enjoy the video playback without setting other switches manually. The receiver automatically turns on and changes the source to “VCR 1.” The TV automatically turns on and changes the input mode to the position so that you can view the playback picture. When you insert a video cassette with its safety tab, press the play () button on the VCR 1 or on the remote control. So, you can get the same result.

One-Touch DVD Play

Simply by starting playback on the DVD player, you can enjoy the DVD playback without setting other switches manually.

- *When the DVD player is connected through the analog input jacks on this receiver (and analog input is selected), the receiver automatically turns on and changes the source to “DVD” or “DVD MULTI.”*
- *When the DVD player is connected through the digital input terminal on this receiver (and digital input is selected), the receiver automatically turns on and changes the source to “DVD DIGITAL”*

The TV automatically turns on and changes the input mode to the appropriate position so that you can view the playback picture.

Automatic Selection of TV's Input Mode

- When you select “TV” or “TV DIGITAL” as the source to play on the receiver, the TV automatically changes the input mode to the TV tuner so that you can watch TV.
- When you select “DVD” (“DVD DIGITAL”) “DVD MULTI,” “VCR 1,” “VCR 2,” “VIDEO” or “DBS” (“DBS DIGITAL”) as the source to play on the receiver, the TV automatically changes the input mode to the appropriate position (either Video Input 1 or Video Input 2) so that you can view the playback picture.

Notes:

- *When connecting a TV with the AV COMPU LINK EX terminal to this receiver, you cannot use a component video cable (as case 3 on page 53). Connect the TV using a S-video or composite video cable (as cases 1 and 2).*
- *When you select “TV” as the source on the receiver, you cannot see the menu on the TV screen since the AV COMPU LINK remote control system automatically changes the TV's input mode to the TV tuner.*
If you do not mind stopping listening to the TV sounds, you can then show the on-screen displays after changing the TV's input mode to the appropriate position the receiver is connected to.

Automatic Power On/Off

The TV, VCR 1 (the VCR connected to the VCR 1 jacks), and DVD player turn on and off along with the receiver.

When you turn on the receiver;

- If the previously selected source is “VCR 1,” the TV and VCR 1 will turn on automatically.
- If the previously selected source is “VIDEO,” “VCR 2,” “TV” (“TV DIGITAL”) or “DBS” (“DBS DIGITAL”), only the TV will turn on automatically.
- If the previously selected source is DVD” (“DVD DIGITAL”) or “DVD MULTI,” the TV and DVD player will turn on automatically.

When you turn off the receiver, the TV, VCR 1 and the DVD player will turn off.

Note:

If you turn off the receiver while recording on the VCR 1, the VCR 1 will not turn off, but continue recording.

Operating JVC's Audio/Video Components

You can operate JVC's audio and video components with this receiver's remote control, since control signals for JVC components are preset in the remote control.

Operating Audio Components

IMPORTANT:

To operate JVC's audio components using this remote control:

- You need to connect JVC audio components through the COMPU LINK (SYNCHRO) jacks (see page 47) in addition to the connections using cables with RCA pin plugs (see pages 9 and 10).
- Aim the remote control directly at the remote sensor on the receiver.
- To operate a source with the remote control, the source must be selected using source selecting buttons on the remote control.
- To operate the cassette deck or MD recorder using the COMPU LINK remote control system, set the source name correctly. (See page 22.)
- Refer also to the manuals supplied with your components.

When using the remote control:

- Check the indication shown on the remote's display when you press a button—this indicates the remote control operation mode for a while (10 or 5 seconds).
- The CONTROL button can change the remote control operation mode without changing the source. Each time you press the button, the remote control operation mode changes in the sequence—VCR1 → TAPE → CDR → CDDSC → (back to the beginning).

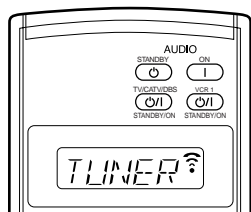

Ex. When you press FM.

Tuner

You can always perform the following operations:

- FM : Tunes into the last selected FM station.
- AM : Tunes into the last selected AM station.

After pressing FM or AM, you can perform the following operations:

- 1 – 10, +10 : Selects a preset channel number directly.
For channel number 5, press 5.
For channel number 15, press +10, then 5.
For channel number 20, press +10, then 10.
- TUNING UP/DOWN : Tunes into stations.
- FM MODE : Changes the FM reception mode.

Sound control section (Amplifier)

You can always perform the following operations:

- THX ON/OFF : Turns on or off the THX Surround modes—THX Surround EX or THX Cinema.
- SURROUND ON/OFF : Turns on or off the conventional Surround modes—Dolby Digital, DTS Surround, and Dolby Pro Logic.
- DSP MODE : Selects the DSP modes.
- TEST : Turns on or off the test tone output.

After pressing SOUND, you can perform the following operations:

- FRONT•L then LEVEL +/- : Adjusts the left front speaker channel output level.
- FRONT•R then LEVEL +/- : Adjusts the right front speaker channel output level.
- SUBWFR then LEVEL +/- : Adjusts the subwoofer output level.
- CENTER then LEVEL +/- : Adjusts the center speaker channel output level.
- SURR•L then LEVEL +/- : Adjusts the left surround speaker channel output level.
- SURR•R then LEVEL +/- : Adjusts the right surround speaker channel output level.
- SURR BK•L then LEVEL +/- : Adjusts the left surround back speaker channel output level.
- SURR BK•R then LEVEL +/- : Adjusts the right surround back speaker channel output level.
- EFFECT : Selects the effect level.
- ROOM SIZE : Selects the room size.
- LIVENESS : Selects the liveness.
- WALL : Selects the wall type.
- LINE DIRECT : Turns on or off Line Direct.
- CC CONVERTER : Turns on or off CC Converter.

Notes:

- After adjusting sounds, press the corresponding source selecting button to operate your target source by using the 10 keys; otherwise, the 10 keys cannot be used for operating your target source.
- Each time you press LEVEL + or LEVEL –, the corresponding speaker name appears on the remote's display.

CD player

After pressing CD, you can perform the following operations on the CD player:

- PLAY : Starts playing.
- ◀◀ : Returns to the beginning of the current (or previous) track.
- ▶▶ : Skips to the beginning of the next track.
- STOP : Stops playing.
- PAUSE : Pauses playing. To release it, press PLAY.
- 1 – 10, +10 : Selects a track number directly.
For track number 5, press 5.
For track number 15, press +10, then 5.
For track number 20, press +10, then 10.
For track number 30, press +10, +10, then 10.

CD player-changer

After selecting “CDDSC” by pressing CONTROL repeatedly, you can perform the following operations on a CD player-changer:

- PLAY : Starts playing.
- ◀◀ : Returns to the beginning of the current (or previous) track.
- ▶▶ : Skips to the beginning of the next track.
- STOP : Stops playing.
- PAUSE : Pauses playing. To release it, press PLAY.
- 1 – 6, 7/P : Selects the number of a disc installed in a CD player-changer.

After pressing CD, you can perform the following operations on the CD player-changer:

- 1 – 10, +10 : Selects a track number directly.
For track number 5, press 5.
For track number 15, press +10, then 5.
For track number 20, press +10, then 10.
For track number 30, press +10, +10, then 10.

EXAMPLE:

- Selecting disc number 4, track number 12, and starting playback.
 1. Press CONTROL repeatedly until “CDDSC” appears on the remote’s display, then press 4.
 2. Press CD, then press +10, 2.

If your CD changer is of 200-disc loading capability (except for XL-MC100 and XL-MC301)

You can do the following operations using the number buttons after pressing CD.

1. Select a disc number.
2. Then select a track number (always enter two digits).
3. Start playback.

EXAMPLES:

- Selecting disc number 3, track number 2, and starting playback. Press 3, then, 0, 2, then PLAY.
- Selecting disc number 10, track number 5, and starting playback. Press 1, 0, then, 0, 5, then PLAY.
- Selecting disc number 105, track number 12, and starting playback. Press 1, 0, 5, then 1, 2 then PLAY.

Turntable

After pressing PHONO, you can perform the following operations on a turntable:

- PLAY : Starts playing.
- STOP : Stops operations.

CD recorder

After pressing CDR, or selecting “CDR” by pressing CONTROL repeatedly, you can perform the following operations on a CD recorder:

- PLAY : Starts playing.
- ◀◀ : Returns to the beginning of the current (or previous) track.
- ▶▶ : Skips to the beginning of the next track.
- STOP : Stops playing.
- PAUSE : Pauses playing. To release it, press PLAY.
- 1 – 10, +10 : Selects a track number directly.
For track number 5, press 5.
For track number 15, press +10, then 5.
For track number 20, press +10, then 10.
For track number 30, press +10, +10, then 10.

Notes:

- When you start recording on the CD recorder, use the buttons on the CD recorder itself or on the remote control supplied for it.
- You can use either the CDR or CONTROL button to activate the buttons listed above. If you press CDR, the playing source changes. On the other hand, if you press CONTROL repeatedly to select “CDR,” the playing source does not change.

Cassette deck

After pressing TAPE/MD or selecting “TAPE” by pressing CONTROL repeatedly, you can perform the following operations on a cassette deck:

- PLAY : Starts playing.
- REW : Fast-winds the tape from right to left.
- FF : Fast-winds the tape from left to right.
- STOP : Stops operations.
- PAUSE : Pauses playing. To release it, press PLAY.
- REC : Press this button together with the PLAY button to start recording.
Press this button together with the PAUSE button to enter recording pause.

Notes:

- When connecting the cassette recorder to the TAPE/MD jacks, change the source name to “TAPE”—initial setting (see page 22).
- You can use either the TAPE/MD or CONTROL button to activate the buttons listed above. If you press TAPE/MD, the playing source changes. On the other hand, if you press CONTROL repeatedly to select “TAPE,” the playing source does not change.

MD recorder

After pressing TAPE/MD, you can perform the following operations on the MD recorder:

- PLAY : Starts playing.
- ◀◀ : Returns to the beginning of the current (or previous) track.
- ▶▶ : Skips to the beginning of the next track.
- STOP : Stops playing.
- PAUSE : Pauses playing. To release it, press PLAY.
- REC : Press this button together with the PLAY button to start recording.
Press this button together with the PAUSE button to enter recording pause.

Note:

When connecting an MD recorder to the TAPE/MD jacks, change the source name to “MD” (see page 22).

Operating Video Components

IMPORTANT:

To operate JVC's video components using this remote control:

- You need to connect JVC video components through the AV COMPU LINK jacks (see page 53) in addition to the connections using cables with RCA pin plugs (see pages 11 to 13).
- Some JVC VCRs can accept two types of the control signals—remote codes “A” and “B.” Before using this remote control, make sure that the remote control code of the VCR connected to the VCR 1 jacks is set to code “A.”
 - When another JVC VCR is connected to the VCR 2 and VIDEO jacks, set its remote control code to code “B.” (This remote control cannot emit the control signals of code “B.”)
- To operate the video component(s) using the remote control:
 - Aim the remote control directly at the remote sensor on each component, not on the receiver.

When using the remote control:

- Set the TV operation mode selector to “TV” or “CATV/DBS” correctly.
 - To operate TV, set it to “TV.”
- Check the indication shown on the remote's display when you press a button—this indicates the remote control operation mode for a while (10 or 5 seconds).
- The CONTROL button can change the remote control operation mode without changing the source.

Each time you press the button, the remote control operation mode changes in the sequence—VCR1 → TAPE → CDR → CDDSC → (back to the beginning).

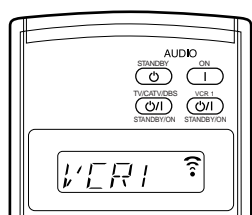

Ex. When you press VCR1.

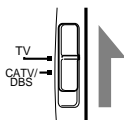

VCR (VCR connected to the VCR 1 jacks)

You can always perform the following operations:

VCR 1 (STANDBY/ON): Turns on or off the VCR.

After pressing VCR 1 or selecting “VCR1” by pressing CONTROL repeatedly, you can perform the following operations on a VCR:

- 1 – 9, 0 : Selects the TV channels on a VCR.
- PLAY : Starts playing.
- REW : Rewinds a tape.
- FF : Fast-winds a tape.
- STOP : Stops operations.
- PAUSE : Pauses playing. To release it, press PLAY.
- REC : Press this button together with the PLAY button to start recording. Press this button together with the PAUSE button to enter recording pause.
- CHANNEL +/- : Changes the TV channels on a VCR.

Note:

You can use either the VCR 1 button or the CONTROL button to activate the buttons listed above. If you press VCR 1, the playing source also changes. On the other hand, if you press CONTROL repeatedly to select “VCR1” on the remote's display, the playing source does not change.

DVD player

After pressing DVD (or DVD MULTI), you can perform the following operations on a DVD player:

- 1 – 10, 0, +10 : Selects the DVD titles or the chapters.
- PLAY : Starts playing.
- ◀◀ : Returns to the beginning of the current (or previous) chapter.
- ▶▶ : Skips to the beginning of the next chapter.
- STOP : Stops playing.
- PAUSE : Stops playing temporarily. To release it, press PLAY.

After pressing DVD MENU, these buttons can be used for the DVD menu operations.

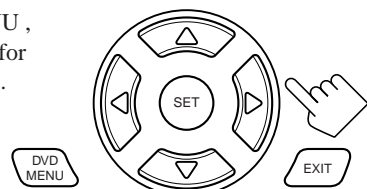

Note:

Refer also to the manual supplied for your DVD player (and the instruction supplied for the discs).

TV

You can always perform the following operations (with the TV operation mode selector set to “TV”):

- TV/CATV/DBS (STANDBY/ON) : Turns on or off the TV.
- TV VOL +/- : Adjusts the volume.
- TV/VIDEO : Sets the input mode (either TV or VIDEO).

After pressing TV/DBS (with the TV operation mode selector set to “TV”), you can perform the following operations on a TV:

- CHANNEL +/- : Changes the channels.
- 1 – 9, 0, 100+ : Selects the channels.
- RETURN : Alternates between the previously selected channel and the current channel.

Operating Other Manufacturers' Equipment

This remote control supplied with the receiver can transmit control signals for other manufacturers' VCRs, TVs, CATV converters, DBS tuners and DVD players. By changing the transmittable signals from preset ones to the other manufacturers', you can operate the other manufacturer's components using this remote control.

IMPORTANT:

When using the remote control:

- Set the TV operation mode selector to “TV” or “CATV/DBS” correctly.
To operate TV, set it to “TV.”
To operate the CATV converter or the DBS tuner, set it to “CATV/DBS.”
- Check the indication shown on the remote's display when you press a button—this indicates the remote control operation mode for a while (10 or 5 seconds).

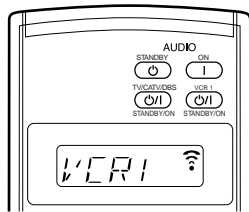
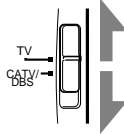

Ex. When you press VCR1.

CAUTION:

When replacing the batteries, finish it without delay; otherwise, manufacturers' codes are lost.

Changing the Preset Signal Codes

By changing the transmittable signals from preset ones to the other manufacturers', you can operate the other manufacturer's components using this remote control.

- When operating the other manufacturers' components, refer also to the manuals supplied with them.

To change the transmittable signals for operating another manufacturer's TV

1. Set the TV operation mode selector to “TV.”

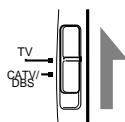

2. Press and hold TV/CATV/DBS \odot/I (STANDBY/ON).



3. Press TV/DBS.

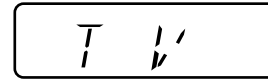

Remote's display

4. Enter manufacturer's code using buttons 1–9, and 0.

See page 61 to find the code.



5. Release TV/CATV/DBS \odot/I (STANDBY/ON).

After setting the TV operation mode selector to “TV,” you can perform the following operations on the TV:

TV/CATV/DBS \odot/I (STANDBY/ON) :

Turns on or off the TV.

TV VOL +/-

: Adjusts the volume.

TV/VIDEO

: Sets the input mode (either TV or VIDEO).

After pressing TV/DBS (with the TV operation mode selector set to “TV”), you can perform the following operations on a TV:

CHANNEL +/-

: Changes the channels.

1 – 10, 0, 100+ (+10):

Selects the channels.

Number button 10 will function as the ENTER button if your TV requires pressing ENTER after selecting a channel number.

Notes:

- Refer to the manual supplied for your TV.
- All the functions listed above may not be assigned to the buttons for some TVs.
- If you cannot change the channels of some TVs by pressing number buttons, press CHANNEL +/- for changing the channels.

6. Try to operate your TV by pressing TV/CATV/DBS \odot/I (STANDBY/ON).



When your TV turns on or off, you have entered the correct code.

If there are more than one code listed for your brand of TV, try each one until the correct one is entered.

To change the transmittable signals for operating a CATV converter and DBS tuner

1. Set the TV operation mode selector to "CATV/DBS."

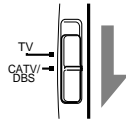

2. Press and hold TV/CATV/DBS \odot /I (STANDBY/ON).



3. Press TV/DBS.



Remote's display

4. Enter manufacturer's code using buttons 1-9, and 0.

See page 61 to find the code.



5. Release TV/CATV/DBS \odot /I (STANDBY/ON).

After setting the TV operation mode selector to "CATV/DBS," you can turn on and off the CATV converter or the DBS tuner:

TV/CATV/DBS \odot /I (STANDBY/ON) :

Turns on or off the CATV converter or DBS tuner.

After pressing TV/DBS (with TV operation mode selector set to "CATV/DBS"), you can perform the following operations on the CATV converter or on the DBS tuner:

CHANNEL +/- : Changes the channels.

1 - 10, 0, 100+ (+10) : Selects the channels.
Number button 10 will function as the ENTER button if your equipment requires pressing ENTER after selecting a channel number.

Note:

Refer to the manual supplied for your CATV converter or DBS tuner.

6. Try to operate your CATV converter or DBS tuner by pressing TV/CATV/DBS \odot /I (STANDBY/ON).



When your CATV converter or DBS tuner turns on or off, you have entered the correct code.

If there are more than one code listed for your brand of CATV converter or DBS tuner, try each one until the correct one is entered.

Note:

You cannot preset the signals for both of the CATV converter and DBS tuner at the same time.

To change the transmittable signals for operating another manufacturer's VCR

1. Press and hold VCR 1 \odot /I (STANDBY/ON).

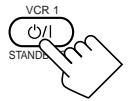

2. Press VCR 1.

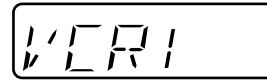
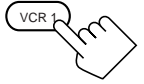

Remote's display

3. Enter manufacturer's code using buttons 1-9, and 0.

See page 61 to find the code.



4. Release VCR 1 \odot /I (STANDBY/ON).

The following button can be used for operating the VCR :

VCR 1 \odot /I (STANDBY/ON):

Turns on or off the VCR.

After pressing VCR 1, you can perform the following operations on the VCR:

1 - 10, 0, 100+ (+10) : Selects the TV channels.
Number button 10 will function as the ENTER button if your VCR requires pressing ENTER after selecting a channel number.

PLAY : Starts playback.

REW : Rewinds a video tape.

FF : Fast-winds a video tape.

STOP : Stops operation.

PAUSE : Pauses.

● REC : Press this button together with the PLAY button to start recording.
Press this button together with the PAUSE button to enter recording pause.

CHANNEL +/- : Changes the TV channels on the VCR.

Note:

Refer to the manual supplied for your VCR.

5. Try to operate your VCR by pressing VCR 1 \odot /I (STANDBY/ON).

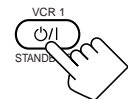

When your VCR turns on or off, you have entered the correct code.

If there are more than one code listed for your brand of VCR, try each one until the correct one is entered.

To change the transmittable signals for operating a DVD player

1. Press and hold VCR 1  (STANDBY/ON).

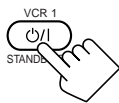

2. Press DVD.

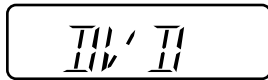

Remote's display

3. Enter manufacturer's code using buttons 1–9, and 0.

See page 61 to find the code.





4. Release VCR 1  (STANDBY/ON).

After pressing DVD (or DVD MULTI), you can perform the following operations on a DVD player:

1 – 9, 0, +10: Selects the titles or the chapters.

PLAY : Starts playing.

 : Returns to the beginning of the current (or previous) chapter.

 : Skips to the beginning of the next track.

STOP : Stops playing.

PAUSE : Stops playing temporarily. To release it, press PLAY.

After pressing DVD MENU, these buttons can be used for the DVD menu operations.

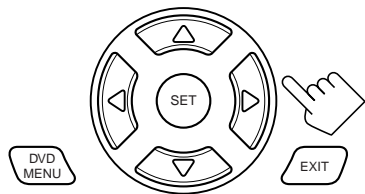

Note:

Refer also to the manual supplied for your DVD player (and the instruction supplied for the discs).

5. Try to operate your DVD player by pressing one of the above buttons.

- DO NOT forget to turn on the DVD player before pressing one of the above buttons.

If there are more than one code listed for your brand of DVD player, try each one until the correct one is entered.

To change the transmittable signals for operating a CD player

1. Press and hold AUDIO  (ON).

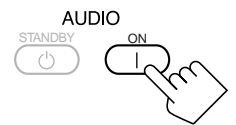

2. Press CD.

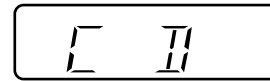
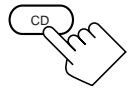

Remote's display

3. Enter manufacturer's code using buttons 1–9, and 0.

See page 61 to find the code.

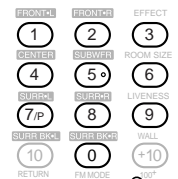

4. Release AUDIO  (ON).

After pressing CD, you can perform the following operations on a CD player:

1 – 9, 0, +10: Selects the tracks.

PLAY : Starts playing.

REW : Fast-reverses the tracks.

FF : Fast-forwards the tracks.

STOP : Stops playing.

PAUSE : Stops playing temporarily. To release it, press PLAY.

Note:

Refer to the manual supplied for your CD player.

5. Try to operate your CD player by pressing one of the above buttons.

- DO NOT forget to turn on the CD player before pressing one of the above buttons.

If there are more than one code listed for your brand of CD, try each one until the correct one is entered.

Manufactures' codes for TV

Manufacturer	Codes
JVC	00*, 74
FISHER	05
HITACHI	08, 09, 10, 49
MAGNAVOX	08, 17, 49
METS	50, 51, 52, 53
mitsubishi	08, 18
PANASONIC	24, 26, 76
PHILIPS	17
QUELLE	52, 53, 54, 55, 56, 57, 58, 59, 60, 61, 62, 63, 64, 65, 66, 67
RCA/PROSCAN	08, 24, 29, 30, 31, 48
SAMSUNG	08, 34, 49
SANYO	05
SHARP	38, 77
SONY	39
TOSHIBA	37, 43
ZENITH	45, 46

*This figure is set to the remote control as the initial JVC code.

Manufactures' codes for VCR

Manufacturer	Codes
JVC	00*, 83
AIWA	01
BELL & HOWELL	03
EMERSON	08, 10, 11, 12, 64, 65
FISHER	03, 14, 15, 16
FUNAI	01
GE	18, 19, 20
GOLDSTAR	07
HITACHI	18, 23, 24
MAGNAVOX	04, 19, 24
MITSUBISHI	30, 31, 32, 33
NEC	26, 27
PANASONIC	19, 24, 39
PHILIPS	19, 24
RCA/PROSCAN	04, 18, 19, 23, 24, 43, 44, 45
SAMSUNG	45, 61, 62
SANYO	03, 48
SHARP	37, 50
SONY	52, 53, 54
TOSHIBA	43, 44
ZENITH	56, 57

*This figure is set to the remote control as the initial JVC code.

Manufactures' codes for DBS tuner

Manufacturer	Codes
JVC	56, 57*, 67
AMSTRAD	43, 44, 45, 46, 47, 48, 49
BLAUPUNKT	30
ECHOSTAR	50, 51, 67
GOLDSTAR	31
GRUNDIG	32, 33
HIRSHMANN	48, 52, 53, 54, 55
GENERAL INSTRUMENT	68
ITT/NOKIA	34
KATHREIN	52, 58, 59, 60, 61, 62, 63
NEC	35, 36
ORBITECH	48
PHILIPS	37, 38
RCA	65
SAMSUNG	39, 40
SCHWAIGER	61, 64
SIEMENS	41, 42
SONY	66
TECHNISAT	48

*This figure is set to the remote control as the initial JVC code.

Manufactures' codes for DVD player

Manufacturer	Codes
JVC	00*, 02
DENON	01
PANASONIC	03
PHILIPS	13
PIONEER	04, 05, 06
RCA	07
SAMSUNG	08
SONY	09
TOSHIBA	10
YAMAHA	11, 12

*This figure is set to the remote control as the initial JVC code.

Manufactures' codes for CD player

Manufacturer	Codes
JVC	00*, 06
DENON	01, 03
FISHER	04
KENWOOD	10, 11, 12
MAGNAVOX	15, 16
MARANTZ	17
ONKYO	18, 20, 21
PANASONIC	22, 24
PHILIPS	25, 26, 29
PIONEER	30
RCA	32, 33, 34
SANYO	35
SHARP	36
SONY	53
TEAC	37, 38, 39
TECHNICS	40, 41, 42, 45
YAMAHA	46, 47, 48

*This figure is set to the remote control as the initial JVC code.

Manufactures' codes for CATV converter

Manufacturer	Codes
GENERAL INSTRUMENT	29
HAMLIN/REGAL	01, 02, 03, 04, 05
JERROLD/G	06, 07, 08, 09, 10, 11, 12, 13, 14
OAK	15, 16, 17
PANASONIC	18, 19, 20
PIONEER	21, 22
SCIENTIFIC ATLANTA	23, 24, 25
TOCOM	26
ZENITH	27, 28

Note:

Manufacturers' codes are subject to change without notice. If they are changed, this remote control cannot operate the equipment.

Troubleshooting

Use this chart to help you solve daily operational problems. If there is any problem you cannot solve, contact your JVC service center.

PROBLEM	POSSIBLE CAUSE	SOLUTION
The display does not light up.	The power cord is not plugged in.	Plug the power cord into an AC outlet. (See page 15.)
No sound from speakers.	Speaker signal cables are not connected properly.	Check speaker wiring and reconnect if necessary. (See page 8.)
	The SPEAKERS 1 and SPEAKERS 2 buttons are not set correctly.	Press SPEAKERS 1 and SPEAKERS 2 correctly. (See page 19.)
	An incorrect source is selected.	Select the correct source.
	Muting is activated.	Press MUTING to cancel the mute. (See page 21.)
	An incorrect input mode (analog or digital) is selected.	Select the correct input mode (analog or digital). (See page 20.)
Sound from one speaker only.	Connections are incorrect.	Check connections. For analog connections, see pages 9 to 13. For digital connections, see page 14.
	Speaker signal cables are not connected properly.	Check speaker wiring and reconnect if necessary. (See page 8.)
Continuous hiss or buzzing during FM reception.	Incoming signal is too weak.	Connect an outdoor FM antenna or contact your dealer. (See page 6.)
	The station is too far away.	Select a new station.
	An incorrect antenna is used.	Check with your dealer to be sure you have the correct antenna.
	Antennas are not connected properly.	Check connections. (See page 6.)
Occasional cracking noise during FM reception.	Ignition noise from automobiles.	Move the antenna farther from automobile traffic.
Noise is heard during record playing.	The ground cable from the turntable is not connected to the screw marked (⌘).	Connect the ground cable to the screw marked (⌘).
Howling during record playing.	Your turntable is too close to the speakers.	Move the speakers away from the turntable.
No sound effect such as DSP mode and Parametric Equalizer.	The Line Direct function is turned on.	Turn off the Line Direct function. (See page 21.)
"OVERLOAD" starts flashing on the display.	Speakers are overloaded because of high volume.	1. Press ⏻ (STANDBY/ON) on the front panel to turn off the receiver. 2. Stop the playback source. 3. Turn on the receiver again, and adjust the volume.
	Speakers are overloaded because of short circuit of speaker terminals.	Press ⏻ (STANDBY/ON) on the front panel to turn off the receiver, check the speaker wiring, then press it again to turn on the receiver again. If "OVERLOAD" does not disappear despite speaker wiring is not short-circuited, consult your dealer.
The STANDBY lamp lights up after turning on the power, but soon the receiver turns off again (into standby mode).	The receiver is overloaded because of applying high voltage.	Press ⏻ (STANDBY/ON) on the front panel to turn off the receiver. After unplugging the AC power cord, consult your dealer.
Remote control does not work.	The TV operation mode selector is not set correctly.	Set the selector correctly either to "TV" or to "CATV/DBS."
	Batteries are weak.	Replace batteries. (See page 15.)
Remote control does not work properly.	An incorrect remote control operation mode is selected.	Select the correct remote control operation mode. (See pages 55 to 61.)
Front door does not open or close.	There is an obstruction disabling the front door from opening or closing.	Remove the obstruction, and turn the unit off then back on again.

Specifications

Amplifier

Output Power

At Stereo operation:

Front channels: **120 W per channel, min. RMS, driven into 8 Ω , 20 Hz to 20 kHz with no more than 0.02% total harmonic distortion.**

120 W per channel, min. RMS, driven into 4 Ω , 20 Hz to 20 kHz with no more than 0.08% total harmonic distortion.

At Surround operation:

Front channels: 100 W per channel, min. RMS, driven into 8 Ω , 20 Hz to 20 kHz with no more than 0.02% total harmonic distortion.

Center channel: 100 W, min. RMS, driven into 8 Ω , 20 Hz to 20 kHz with no more than 0.02% total harmonic distortion.

Surround channels: 100 W per channel, min. RMS, driven into 8 Ω , 20 Hz to 20 kHz with no more than 0.02% total harmonic distortion.

Audio

Audio Input Sensitivity/Impedance (1 kHz): PHONO (MM): 2.5 mV/47 k Ω
CD, CDR, TAPE/MD, DVD, VCR 1, VCR 2, VIDEO, TV SOUND/DBS: 200 mV/47 k Ω

Audio Input (DIGITAL IN)* : Coaxial: DIGITAL 1 (DVD): 0.5 V(p-p)/75 Ω
Optical: DIGITAL 2 (CD) / 3(TV) / 4(CDR):
-21 dBm to -15 dBm (660 nm \pm 30 nm)

* Corresponding to Linear PCM, Dolby Digital, and DTS Digital Surround (with sampling frequency — 32 kHz, 44.1 kHz, 48 kHz)

Audio Output Level: PREOUT: 1 V

Recording Output Level: TAPE/MD, CDR, VCR 1, VCR 2: 200 mV

Digital output: Optical: DIGITAL OUTPUT
Signal wave length: 660 nm
Output level: -21 dBm to -15 dBm

Signal-to-Noise Ratio ('66 IHF/'78 IHF): PHONO: 70 dB/78 dB (at REC OUT)
CD, CDR, TAPE/MD, DVD, VCR 1, VCR 2, VIDEO, TV SOUND/DBS:
92 dB/80 dB (Line Direct On)

Frequency Response (8 Ω): PHONO: 20 Hz to 20 kHz (\pm 1 dB)
CD, CDR, TAPE/MD, DVD, VCR 1, VCR 2, VIDEO, TV SOUND/DBS:
10 Hz to 100 kHz (+1 dB, -3 dB)

RIAA Phono Equalization: \pm 1.0 dB (20 Hz to 20 kHz)

Video

Video Input Sensitivity/Impedance:

Composite video: DVD, VCR 1, VCR 2, VIDEO,
TV SOUND/DBS: 1 V(p-p)/75 Ω
S-video: DVD, VCR 1, VCR 2, VIDEO, TV SOUND/DBS:
(Y: luminance): 1 V(p-p)/75 Ω
(C: chrominance, burst): 0.286 V(p-p)/75 Ω
Component: COMPONENT 1(DVD) / COMPONENT 2
(Y: luminance): 1 V(p-p)/75 Ω
(P_B/C_B, P_R/C_R): \pm 0.7 V/75 Ω

Video Output Level:

Composite video: VCR 1, VCR 2, MONITOR OUT: 1 V(p-p)/75 Ω
S-video: VCR 1, VCR 2, MONITOR OUT:
(Y: luminance): 1 V(p-p)/75 Ω
(C: chrominance, burst): 0.286 V(p-p)/75 Ω
Component: MONITOR OUT
(Y: luminance): 1 V(p-p)/75 Ω
(P_B/C_B, P_R/C_R): \pm 0.7 V/75 Ω

Synchronization: Negative

Signal-to-Noise Ratio: 45 dB

FM tuner (IHF)

Tuning Range:	87.5 MHz to 108.0 MHz
Usable Sensitivity: Monaural:	12.8 dBf (1.2 μ V/75 Ω)
50 dB Quieting Sensitivity:	Monaural: 18.2 dBf (2.2 μ V/75 Ω) Stereo: 38.2 dBf (22.3 μ V/75 Ω)
Signal-to-Noise Ratio (IHF-A weighted):	Monaural: 78 dB at 85 dBf Stereo: 73 dB at 85 dBf
Total Harmonic Distortion:	Monaural: 0.2% at 1 kHz Stereo: 0.3% at 1 kHz
Stereo Separation at REC OUT:	40 dB at 1 kHz
Alternate Channel Selectivity:	60 dB: (\pm 400 kHz)
Frequency Response:	30 Hz to 15 kHz: (+0.5 dB, -3 dB)

AM tuner

Tuning Range:	530 kHz to 1 710 kHz
Usable Sensitivity:	Loop antenna: 400 μ V/m
Signal-to-Noise Ratio:	50 dB (100 mV/m)

General

Power Requirements:	AC 120V \sim , 60 Hz
Power Consumption:	485 W/615 VA (at operation) 2.6 watts (in standby mode)
Dimensions (W x H x D):	445 mm x 177 mm x 474.5 mm (17 ⁹ / ₁₆ in. x 7 in. x 18 ³ / ₄ in.)
Mass:	21.1 kg (47 lbs)

Designs & specifications are subject to change without notice.

Authorized Service Centers

QUALITY **JVC**[®] SERVICE

HOW TO LOCATE YOUR JVC SERVICE CENTER

TOLL FREE: 1 (800) 537-5722

<http://www.jvc.com>

Dear Customer,

In order to receive the most satisfaction from your purchase, please read the instruction booklet before operating the unit. In the event that repairs are necessary, please call 1 (800)537-5722 for your nearest authorized servicer or visit our website at **www.JVC.com**

Remember to retain your Bill of Sale for Warranty Service.

Do not service the television yourself

Caution

To prevent electrical shock, do not open the cabinet. There are no user serviceable parts inside. Please refer to qualified service personnel for repairs.

Accessories

To purchase accessories for your JVC product, please call toll free: 1 (800)882-2345 or on the web at **www.JVC.com**



LIMITED WARRANTY

AUDIO-2

JVC COMPANY OF AMERICA warrants this product and all parts thereof, except as set forth below ONLY TO THE ORIGINAL PURCHASER AT RETAIL to be FREE FROM DEFECTIVE MATERIALS AND WORKMANSHIP from the date of original retail purchase for the period as shown below. ("The Warranty Period")

PARTS	2 YRS	LABOR	2 YRS
-------	--------------	-------	--------------

THIS LIMITED WARRANTY IS VALID ONLY IN THE FIFTY (50) UNITED STATES, THE DISTRICT OF COLUMBIA AND IN COMMONWEALTH OF PUERTO RICO.

WHAT WE WILL DO:

If this product is found to be defective, JVC will repair or replace defective parts at no charge to the original owner. Such repair and replacement services shall be rendered by JVC during normal business hours at JVC authorized service centers. Parts used for replacement are warranted only for the remainder of the Warranty Period. All products and parts thereof may be brought to a JVC authorized service center on a carry-in basis except for Television sets having a screen size 25 inches and above which are covered on an in-home basis.

WHAT YOU MUST DO FOR WARRANTY SERVICE:

Return your product to a JVC authorized service center with a copy of your bill of sale. For your nearest JVC authorized service center, please call toll free: (800) 537-5722.

If service is not available locally, box the product carefully, preferably in the original carton, and ship, insured, with a copy of your bill of sale plus a letter of explanation of the problem to the nearest JVC Factory Service Center, the name and location of which will be given to you by the toll-free number.

If you have any questions concerning your JVC Product, please contact our Customer Relations Department.

WHAT IS NOT COVERED:

This limited warranty provided by JVC does not cover:

1. Products which have been subject to abuse, accident, alteration, modification, tampering, negligence, misuse, faulty installation, lack of reasonable care, or if repaired or serviced by anyone other than a service facility authorized by JVC to render such service, or if affixed to any attachment not provided with the products, or if the model number or serial number has been altered, tampered with, defaced or removed;
2. Initial installation and installation and removal for repair;
3. Operational adjustments covered in the Owner's Manual, normal maintenance, video and audio head cleaning;
4. Damage that occurs in shipment, due to act of God, and cosmetic damage;
5. Signal reception problems and failures due to line power surge;
6. Video Pick-up Tubes/CCD Image Sensor, Cartridge, Stylus (Needle) are covered for 90 days from the date of purchase;
7. Batteries (except that Rechargeable Batteries are covered for 90 days from the date of purchase);

There are no express warranties except as listed above.

THE DURATION OF ANY IMPLIED WARRANTIES, INCLUDING THE IMPLIED WARRANTY OF MERCHANTABILITY, IS LIMITED TO THE DURATION OF THE EXPRESS WARRANTY HEREIN.

JVC SHALL NOT BE LIABLE FOR THE LOSS OF USE OF THE PRODUCT, INCONVENIENCE, LOSS OR ANY OTHER DAMAGES, WHETHER DIRECT, INCIDENTAL OR CONSEQUENTIAL (INCLUDING, WITHOUT LIMITATION, DAMAGE TO TAPES, RECORDS OR DISCS) RESULTING FROM THE USE OF THIS PRODUCT, OR ARISING OUT OF ANY BREACH OF THIS WARRANTY. ALL EXPRESS AND IMPLIED WARRANTIES, INCLUDING THE WARRANTIES OF MERCHANTABILITY AND FITNESS FOR PARTICULAR PURPOSE, ARE LIMITED TO THE WARRANTY PERIOD SET FORTH ABOVE.

Some states do not allow the exclusion of incidental or consequential damages or limitations on how long an implied warranty lasts, so these limitations or exclusions may not apply to you. This warranty gives you specific legal rights and you may also have other rights which vary from state to state.

JVC COMPANY OF AMERICA
DIVISION OF JVC AMERICAS CORP.

1700 Valley Road
Wayne, NJ 07470

REFURBISHED PRODUCTS CARRY A SEPARATE WARRANTY, THIS WARRANTY DOES NOT APPLY. FOR DETAILS OF REFURBISHED PRODUCT WARRANTY, PLEASE REFER TO THE REFURBISHED PRODUCT WARRANTY INFORMATION PACKAGED WITH EACH REFURBISHED PRODUCT.

For customer use:

Enter below the Model No. which is located either on the rear, bottom or side of the cabinet. Retain this information for future reference.

Model No. : _____ Serial No. : _____

Purchase data : _____ Name of dealer : _____

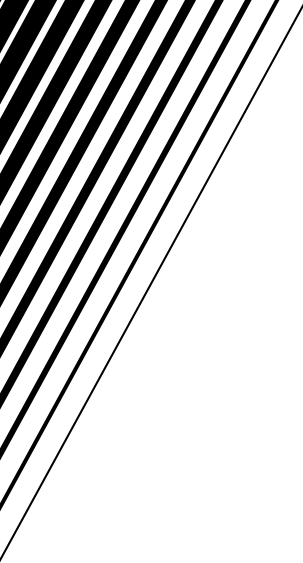

JVC
VICTOR COMPANY OF JAPAN, LIMITED